

**OPERATING PLAN
TAILINGS CELLS AND EVAPORATION PONDS
PIÑÓN RIDGE MILL**



Prepared By:



Energy Fuels Resources Corporation
44 Union Boulevard, Suite 600
Lakewood, Colorado 80228

Prepared For:



U.S. Environmental Protection Agency
Region 8, Indoor Air Program
1595 Wynkoop Street
Mail Code: 8P-AR
Denver, Colorado 80202-1129

August 2010

TABLE OF CONTENTS

<u>Section</u>	<u>Page</u>
1.0 INTRODUCTION.....	1
2.0 TAILINGS CELL DESIGN.....	2
2.1 Delivery and Return Pipelines.....	2
2.2 Cell Liner Design	3
2.3 Leak Collection and Recovery System (LCRS).....	4
2.4 Solution Removal System	4
3.0 EVAPORATION POND DESIGN.....	6
3.1 Delivery and Return Pipelines.....	6
3.2 Pond Liner Design.....	7
3.3 Bird Netting System	8
4.0 TAILINGS CELL OPERATING AND MONITORING PROCEDURES	9
4.1 Standard Operating Procedures	9
4.1.1 Startup and Subcell Operations.....	9
4.1.2 Combined Cell Operations.....	10
4.1.3 Abnormal Circumstances.....	11
4.1.4 Pre-Closure Operations.....	12
4.2 Tailings Monitoring and Control Procedures	13
4.2.1 Dust Monitoring and Control.....	13
4.2.2 Radiation Monitoring and Control.....	14
5.0 EVAPORATION PONDS OPERATING AND MONITORING PROCEDURES	17
5.1 Standard Operating Procedures	17
5.1.1 Cold-Weather Operations	17
5.1.2 Warm-Weather Operations.....	18
5.1.3 Abnormal Circumstances.....	19
5.1.4 Pre-Closure Operations.....	19
5.2 Evaporation Ponds Monitoring and Control Procedures.....	19
5.2.1 Dust Monitoring and Control.....	20
5.2.2 Radiation Monitoring and Control.....	20
6.0 REFERENCES.....	22

FIGURES

Figure 1	Site Plan
Figure 2	Tailings Cell Liner Schematic
Figure 3A	Tailings Deposition – Two Subcells
Figure 3B	Tailings Deposition – One Cell
Figure 3C	Phase I Internal Berm Layout
Figure 3D	Phased Construction of Internal Berms
Figure 4	Evaporation Pond Cells Fill Sequence

APPENDICES

Appendix A	Tailings and Evaporation Pond Delivery and Return Piping Conceptual Plan
------------	--

ACRONYM LIST

ALARA	As Low As Reasonably Achievable
CCD	Counter-Current Decantation
GCL	Geosynthetic Clay Liner
HDPE	High-Density Polyethylene
LCRS	Leak Collection and Recovery System
mg/L	milligram per liter
SX	Solvent Extraction
TDS	Total Dissolved Solids
tpd	tons per day
TSP	Total Suspended Particulates

1.0 INTRODUCTION

This plan provides an overview of the procedures that will be used while operating the tailings cells and evaporation ponds at the Piñon Ridge Mill to minimize fugitive dust and radon emissions. The plan presents procedures that will be in place during normal operations and those that will be put in place for abnormal circumstances that can be reasonably foreseen to occur such as temporary closure and unusual weather conditions. The plan also outlines the procedural changes that will occur as the facilities transition from operational to closure status. The “pre-closure” procedures are designed to allow for closure operations to begin as soon as possible after a facility reaches maximum capacity. The procedures outlined in this plan will be further refined as mill personnel gain experience from operating and monitoring the facility.

Section 2 of this plan provides an overview of the tailings cells design while Section 3 provides a similar overview of the evaporation pond design. Detailed design plans and drawings are presented in the “Tailings Cell Design Report” (Golder, 2008a) and the “Evaporation Pond Design Report” (Golder, 2008b). Sections 4 and 5 discuss operating and monitoring/control procedures for the tailings cells and evaporation ponds, respectively.

2.0 TAILINGS CELL DESIGN

As shown on Figure 1, three tailings cells (A, B, and C) are proposed for the project. The three 30.5-acre tailings cells are designed to provide tailings containment for the life of the project (i.e., 500 tons per day (tpd) for 40 years). The cells are approximately 70-feet deep, mostly incised (i.e., below surface grade), and each have capacity for 2.45 million tons of tailings with three feet of freeboard. This represents 13.3 years of capacity per cell at a process rate of 500 tpd.

The initial tailings cell constructed (Tailings Cell A) is divided into two subcells (A1 and A2) by a lined embankment through the center of the cell. Each subcell has its own leak collection and recovery system (LCRS) and solution removal systems. This configuration allows for decommissioning and repair of a subcell if unforeseen problems with the liner develop, while the other subcell continues to operate.

The central embankment in Tailings Cell A extends approximately 45 feet or two thirds of the way up from the bottom of the cell. Once the tailings level begins to approach the top of the central embankment, Tailings Cell B will be constructed as a backup or secondary tailings area and with a central embankment if production remains at 500 tpd. If production increases, a central embankment may not be necessary. When Tailings Cell A is at full capacity, tailings disposal will transfer to Tailings Cell B. If Tailings Cell B does not have a split-cell configuration, construction will also start on Tailings Cell C. The construction of Cells B and C are planned so that excavated materials from construction activities can be used to cover Tailings Cell A. Energy Fuels will attempt to maintain a contingency tailings disposal area available during most of the life of the facility. However, no more than two 30.5-acre tailings cells will be in operation at any one time, consistent with the provisions of Subpart W of 40 CFR Part 61.

The tailings cell system will consist of delivery and return pipelines and tailings cells constructed with multiple liners, LCRSs, and solution removal systems as discussed below.

2.1 Delivery and Return Pipelines

As shown on Figure 1, the tailings line from the mill to Tailings Cell A will extend from the tailings sump at the mill to the middle of the tailings cell. The tailings line will be 4-inch fused high density polyethylene (HDPE) pipe located within a concrete-lined trench. The trench has positive fall throughout its length; accordingly, any leakage from the pipe would flow into the operating tailings cell. When Tailings Cell B starts operating, the

tailings lines will be extended along the east and west sides of the tailings cells as shown by the dashed lines in Figure 1.

Within each tailings cell, 3-inch HDPE distribution lines will carry the tailings around the perimeter of the cell. The distribution lines feed 2-inch slotted spigots on 100 to 250 foot centers that allow for placement of the tailings throughout the cell. The spigots will extend from the distribution lines to the tailings surface and have individual valves to control tailings discharge. HDPE wear strips will be placed under pipes, walkways, and other locations where system components could potentially tear or abrade the primary liner.

The 6-inch HDPE return line from the barge-mounted pump-back system will be located on top of the HDPE cell liner and then within the same concrete-lined trench as the delivery line between Tailings Cell A and the mill. Similar to the delivery line, this trench has positive fall throughout its length from the mill to the tailings cells and any leaks from the pipe would flow back into the tailings cell.

Additional details of the delivery and return pipelines for the tailings cell system may be found in the “Tailings and Evaporation Pond Delivery and Return Piping Conceptual Plan” by Golder Associates (Golder, 2010b) that is included as Appendix A to this plan.

2.2 Cell Liner Design

The tailings cells have a multiple liner system, as shown on Figure 2, with a LCRS system beneath the primary liner. The liner system is designed to prevent significant seepage into the subsurface that could potentially contaminate surface or ground water and consists of the following components from the top down.

- 60-mil (1.5-millimeter thick) HDPE upper (primary) geomembrane;
- LCRS consisting of HDPE geonet on the base of the tailings cells, and a drainage geocomposite on the side slopes;
- 60-mil HDPE lower (secondary) geomembrane;
- reinforced geosynthetic clay liner (GCL) as the underliner component of the secondary composite liner system; and,
- prepared subgrade.

The upper primary liner will have a 5-mil (0.125-millimeter thick) white layer over the exposed surface of the geomembrane. The white color will result in reduced heat expansion and ultraviolet deterioration of the liner. It will also facilitate the identification

of tears or punctures in the geomembrane because the lower, black portion of the liner would be exposed if the liner is damaged. The upper primary liner will also include a conductive layer that will allow for nondestructive spark testing of the liner for defects prior to the start of operations. The conductive layer typically consists of a 2- to 3-mil-thick coextruded layer of polyethylene containing electrically conductive carbon black on the bottom surface of the geomembrane.

The risk of potentially contaminating groundwater at the site is further reduced by the general absence of groundwater. Extensive drilling on site has not encountered groundwater in the underlying alluvium. The nearest groundwater under the mill area and Tailings Cell A is located in the Chinle and Moenkopi formations at an approximate depth of 450 feet. Groundwater was not encountered beneath Tailings Cells B and C and the Evaporation Ponds, as the alluvium in those areas is underlain by thousands of feet of Hermosa Formation salts.

2.3 Leak Collection and Recovery System (LCRS)

Any seepage through the primary liner will be collected in the LCRS and routed via gravity flow to an LCRS sump located in each tailings cell (or subcell in the case of a divided tailings cell). The LCRS is designed to minimize the hydraulic head on the lower geomembrane liner.

The LCRS, which will be continuous beneath the primary liner, consists of an HDPE geonet on the base of the tailings cells and a drainage geocomposite on the side slopes. The LCRS will drain to a 40-ft square by 5-ft deep sump filled with coarse gravel. Two 10-inch diameter HDPE riser pipes (primary and backup) will extend from the sump beneath the primary liner to the surface. The riser pipes are slotted within the sump area and booted to the liner where they perforate the primary liner at the surface. Submersible pumps within the base of the riser pipes automatically remove any water collected in the sump to the tailings cell. The sumps will be equipped with water level indicators and the pumps with flow meters to allow personnel to quantify and track seepage rates.

2.4 Solution Removal System

The solution removal system will consist of a barge-mounted pumping system that removes the clarified solution that collects at the surface of the tailings cell and an underdrain system that intercepts solution that percolates down through the tailings to the top of the primary liner. The underdrain system is designed to allow for more complete dewatering of the tailings and to minimize hydraulic head on the primary liner.

The pump barge(s) will be anchored to the shore by wire ropes attached to a deadman, and will have a floating catwalk to allow easy access for inspection and maintenance of the pump. The return lines will also be attached to the catwalk. A pump barge will be located in each individual cell and subcell and will pump back to the mill via the 6-inch HDPE return line.

The underdrain system will rest directly on top of the primary liner in the lowest corner of the tailings cell or subcell and will consist of three drainage laterals laid at 45-degree intervals from the corner and connected to a sump. The underdrain laterals will consist of 8-inch diameter, perforated HDPE pipe placed in shallow 2-ft deep trenches. The trenches will be lined with a geotextile to cushion the underlying primary liner and will be filled with one foot of coarse material around the pipe and then one foot of finer material above. Two 10-inch HDPE riser pipes will extend from the corner collection area along the surface of the primary liner to the top of the tailings cell. Submersible pumps within each riser will return any collected solution back to the tailings cell.

3.0 EVAPORATION POND DESIGN

Excess wastewater (i.e., raffinate) from the vanadium solvent extraction (SX) circuit will be pumped directly to the evaporation ponds where the solution will be allowed to evaporate. Raffinate may also be pumped back from the evaporation pond to the tailings cells for use in dust suppression. In the event of a large precipitation event (i.e., greater than the 100-year storm), collected runoff in the mill's East and West Stormwater Ponds will flow via gravity to the evaporation ponds.

The evaporation ponds consist of two sets of 10 cells each. The cells are approximately 10 feet deep and four acres in area, so that a set of 10 cells covers approximately 40 acres. The cells are connected by lined spillways. Initially, only the southern set of cells will be constructed. Based on water balance calculations and previous experience in the region, 40 acres of pond surface provides adequate evaporative area for a 500-tpd production level. The ponds will gradually fill with precipitants and the second set of ponds will come on line in phases as the initial cells fill. The entire second set of cells could also be constructed at one time should the process rate be expanded to 1,000 tpd; thus, doubling the evaporative capacity of the system.

The evaporation pond system consists of pipelines to and from the ponds, the lined evaporation ponds, and a bird netting system designed to exclude birds and bats from accessing the raffinate solution.

3.1 Delivery and Return Pipelines

A continuously fused, four-inch diameter HDPE raffinate delivery line extends from the mill to the evaporation ponds along the east side of the tailings cells, as shown in Figure 1. The pipeline segment extending from the mill to the tailings cells will be installed next to the tailings delivery and return lines within the same concrete-lined trench and on top of the HDPE liner within the tailings cell perimeter area. The segment extending from the tailings cells to the evaporation pond will be installed within a HDPE-lined trench that connects to the southeastern most evaporation pond. The pipeline will be installed within a culvert at vehicle access crossings constructed along the trench. There will be positive fall throughout the length of the lined trench from the mill to the evaporation ponds; accordingly, any leakage from the pipe would flow into either an operating tailings cell or the southeast evaporation pond.

A four-inch diameter return line will convey raffinate from the evaporation ponds to the tailings cells for use in dust suppression and/or to provide additional water that can be recycled back to the mill. The line will be fed by a portable skid-mounted centrifugal pump located on top of the evaporation pond embankments. The line will be located in the HDPE-lined trench that extends from the tailings cells to the evaporation pond. At the tailings cells, the lined trench and pipe will extend up the side of each operating tailings cell. Once within the lined area of the cell, the pipe will be extended to the desired discharge point.

Additional details of the delivery and return pipelines for the evaporation pond system may be found in the “Tailings and Evaporation Pond Delivery and Return Piping Conceptual Plan” by Golder Associates (Golder, 2010b) that is included as Appendix A to this plan.

3.2 Pond Liner Design

The liner system for the evaporation ponds is identical to the tailings liner system with two exceptions: 1) the upper primary liner is black to enhance evaporation rates; and 2) a geonet is used for the LCRS along the side slopes of the cells instead of a drainage geocomposite. The evaporation pond liner system has the following components from the top down.

- 60-mil HDPE upper (primary) geomembrane;
- LCRS consisting of HDPE geonet;
- 60-mil HDPE lower (secondary) geomembrane;
- reinforced GCL as the underliner component of the secondary composite liner system; and,
- prepared subgrade.

Any seepage through the primary liner will be collected in a cell’s LCRS and routed via gravity flow to an LCRS sump. Each cell has a dedicated LCRS and LCRS sump for seepage collection to minimize the potential hydraulic head on the lower geomembrane liner. Each LCRS will be continuous beneath the primary liner and will drain to a 60-ft by 40-ft by 5-ft deep sump filled with coarse gravel. Two 10-inch diameter HDPE riser pipes (primary and backup) will extend from the sump beneath the primary liner to the surface. The riser pipes will be slotted within the sump area and booted to the liner where they perforate the primary liner at the surface. The sumps will be equipped with water level indicators, and portable submersible pumps installed in the riser pipes, as necessary,

to remove any water collected in the LCRS sump. The collected water will be pumped back to the evaporation cell.

Rainbirds or misters will be utilized in the warmer months to enhance evaporation. The enhanced evaporation system will be mounted on the center berm of the six central cells and will be fed by the mill raffinate pumping system and/or one or more submersible pumps located within the evaporation cells. The outer two cells on the east and west sides are not utilized for enhanced evaporation so that overspray beyond the cell limits will be minimized.

3.3 Bird Netting System

The raffinate solution will have a pH of approximately 4.5 and contain elevated concentrations of metals that are potentially toxic to wildlife, especially birds and bats that may attempt to drink from or land on the ponds. To prevent this from occurring, bird netting will be installed over the entire pond network. The bird netting will be clipped to stainless steel cables suspended in a grid between wooden support poles. The 25-ft long wooden poles will be implanted 8.5 feet into the ground (i.e., the netting will be suspended 16.5 feet above ground) and supported by wire strung from a series of concrete anchor points.

4.0 TAILINGS CELL OPERATING AND MONITORING PROCEDURES

This section describes the tailings cell operating and monitoring procedures that will be in place during normal operations, abnormal circumstances, and the pre-closure period. The procedures are designed to limit radon flux and fugitive dust emissions to as low as reasonably achievable (ALARA) levels while still allowing for efficient closure and capping of the cells as they reach capacity. Radon flux and fugitive dust are primarily controlled by maintaining the tailings in a saturated state until such time that the cell cover is to be constructed.

4.1 Standard Operating Procedures

The underflow from the mill's counter-current-decantation (CCD) circuit will be approximately 50 percent solid waste and 50 percent solution at a pH of approximately 3 standard units. This waste stream will be mixed with vanadium raffinate (i.e., waste water from the vanadium solvent extraction system), which reduces the solid ratio to about 27 percent while raising the pH to approximately 3.4. This slurried waste or tailings will then be pumped at an average rate of about 250 gallons per minute to the operating tailings cell via HDPE pipe located within a concrete-lined trench and on top of the cell's HDPE liner.

The tailings will be discharged to a tailings cell via HDPE distribution pipes located around the perimeter of the cell. One line will extend around the east side of the tailings cell and a second will extend around the west side. Slotted pipes will be extended from spigots located along the distribution lines to the tailings surface and the spigots will be opened and closed using corrosive-resistant valves. HDPE wear strips will be placed under pipes, walkways, and other locations where system components could potentially tear or abrade the primary liner.

4.1.1 Startup and Subcell Operations

At startup, there will be two subcells in Tailings Cell A. Each subcell will have its own LCRS and solution recovery system. One subcell will be used for initial tailings deposition while the other will likely be used for storage of fresh makeup water until such time that the water pool in the other subcell is large enough to provide the necessary make-up water. From that point on, tailings discharge will be alternated between the two subcells.

The barge-mounted pumpback systems will be placed on the opposite end from where the tailings are being discharged into each subcell. The coarser particles in the tailings

discharge settle out first, followed by the finer particles resulting in a pond of clarified solution forming at the opposite end from the discharge point in the tailings subcell. The locations of the tailings discharge point and the barge are changed periodically through the life of the tailings subcell so that layers of coarser material and layers of finer material become interlayered throughout the subcell. This condition is expected to provide a more stable base for future closure activities.

During initial operations, the tailings discharge will be located immediately above the underdrain sump as shown on the left side of Figure 3A. This results in coarser tailings being deposited as the first layer over the underdrain system and minimizes the possibility of finer materials infiltrating and sealing off the drainage system. Once the coarse layer of tailings is in place, tailings discharge points will be varied as described above.

The tailings subcells are relatively small in area with an initial base area of 2.4 acres expanding to 8.2 acres at the height of the central berm. Because of the relatively small area for tailings disposal, the water pool will extend across most of each subcell. The only portion of the solid tailings that could be exposed is the sand beach created at the discharge point. However, this area is expected to remain saturated due to the continual discharge of new tailings on top of the existing tailings.

4.1.2 Combined Cell Operations

Once the tailings in the two adjoining subcells reach the height of the central berm, the operating plan will change due to the larger surface areas involved (i.e., initially 16.5 acres expanding to 30.5 acres at full capacity) . The two barge-mounted recycle pumps will be moved to the southeast and southwest corners of the combined tailings area and the tailings discharge will be distributed evenly around the remaining perimeter of the cell on a rotating schedule. This configuration is expected to result in coarser tailings sands (comprising approximately one-third of the tailings) being deposited around most of the cell perimeter. Finer tailings (comprising approximately one-third of the tailings), commonly referred to as slimes, will be being deposited in the middle and southeast and southwest corners of the tailings cell where the water pools and barges are located. A mixture of sands and fines is expected to occur in the remaining area between the coarse sands and slimes. Once Tailings Cell B is constructed, the barge in the southwest corner of Tailings Cell A will be relocated to Tailings Cell B leaving the single barge in the southeast corner of Cell A as shown on Figure 3B.

The fine-grained tailings contain considerably more radium than the coarse-grained tailings because the finer clays and silts readily attenuate radium. Based on modeling results it is expected that the fine tailings will have activity levels four times higher than the coarse tailings (i.e., approximately 1,200 pCi/g compared to approximately 300 pCi/g for the coarse tailings). Radon emissions from the fine tailings will be controlled by the water cover over these areas while radon emissions from the coarse tailings will be controlled by keeping these sands saturated. As discussed above, tailings discharge will be evenly distributed around the perimeter of the cell on a rotating schedule. This will allow the coarser sands to be maintained in a saturated state as they are periodically covered with new tailings. If necessary, water can also be recycled for dust suppression purposes from the cell's water pool or from the evaporation ponds during the warmer summer months. This water would be distributed over the coarse tailings using slotted irrigation pipe.

4.1.3 Abnormal Circumstances

It may be necessary for the mill to be put on standby for maintenance, economic, or other reasons. If the shutdown is temporary in nature, Energy Fuels would add additional fresh water as needed to ensure that the tailings remain saturated. If the standby period is prolonged (i.e., in excess of six months), Energy Fuels would take the following incremental measures to conserve fresh water while still suppressing fugitive dust and maintaining low radon flux levels.

- Water from the evaporation ponds would be pumped to the tailings cell for dust suppression purposes and evaporation ponds would be temporarily taken out of service in a phased manner as described in Section 5.1.3.
- The exposed tailings on the beaches would be sprayed periodically with a chemical dust suppressant and the addition of fresh water to the tailings cell would be reduced or discontinued. In addition to suppressing dust, the chemical agent would seal the tailings surface to minimize loss of moisture in the tails.
- The water pool in the tailings cell would be allowed to gradually dry out while at the same time, coarser tailings from the perimeter would be pushed over the finer tailings. Regraded areas would be sprayed with a dust suppressant as soon as practicable.

Extremely wet or dry weather periods may also create abnormal operating circumstances where there may be more or less water in the tailings and evaporation systems than normally desired. In the event of abnormally wet conditions, additional water may be

held in the tailings area and/or evaporative sprays may be added on the tailings beach sands. As discussed in the “Evaporation Pond Flux Analysis” by SENES Consultants Limited (SENES, 2010), evaporative sprays are not considered as a significant source of increased radon flux. If extremely dry conditions prevail, the procedures described under the first bullet above for standby operations would be implemented in which solution would be transferred from the evaporation ponds to the operating tailings cell.

4.1.4 Pre-Closure Operations

The combined cell operating plan described in Section 4.1.2 is designed to reduce radon emissions to ALARA levels; however, it creates the following undesirable effects from a closure standpoint.

- Saturated fine-grained tailings are concentrated in the center and southeast corner of the cell as shown on Figure 3B. These tailings, commonly referred to as slimes, do not provide a competent base for construction of the final tailings cell cover.
- Slimes also have higher activity levels than the coarser tailings and would require more soil cover to adequately suppress radon emissions after closure.

Because of the physical characteristics of the tailings, the coarse perimeter tailings are expected to be approximately 15 feet higher than the slimes in the center and southeast corner of the impoundment as the cell nears full capacity. To maximize tailings cell capacity and correct the undesirable effects described above, Energy Fuels plans to remove the pump barge and construct internal berms within each cell at that point in the operation as shown on Figure 3C. These internal berms will be constructed of the coarse beach sands using a low-ground-pressure dozer. The discharge point will then be moved to the spigots in the southeast corner. This discharge configuration will allow coarser sands to build up above the slimes.

As the sands build up in height, additional internal berms will be constructed in stair-step fashion as illustrated in Figure 3D. The top of the internal berms will be at least 3 feet below the cell crest so that if tailings solution breaches an internal berm, it will still be contained within the cell. A skid-mounted pump will be placed next to the shallow water pool created within the internal berms. As the tailings solids settle out, the excess water will be pumped out and used to flood irrigate any areas of the tailings cell that are drying out. As the tailings deposition area decreases in size, the majority of the tailings disposal activity will shift to the new tailings cell so that the solids have sufficient time to settle out of solution.

Once the final set of internal berms is filled with tailings, construction of the closure cover will begin. Low-ground-pressure dozers will be used to grade additional coarse tailings from the perimeter over the finer tailings in the center of the cell. This may require the installation of a geotextile fabric over the slimes to prevent heaving as the higher density coarse tailings are placed on top of the lower density slimes. After the tailings surface has been re-graded to the required grades and slopes, a two-foot thick native soil interim cover will be placed immediately over the tailings surface. The interim cover will prevent dust emissions from the tailings surface and the extra weight of the soil will enhance tailings consolidation and removal of tailings water from the underdrain system. Engineering studies predict that the tailings will consolidate sufficiently in 1 to 2 years after placement of the interim cover to allow for construction of the permanent cover (Golder, 2010a).

4.2 Tailings Monitoring and Control Procedures

Monitoring and control procedures within the tailings area will focus on dust emissions, radiation levels, solution leakage, and wildlife protection. Each of these areas of concern is discussed below.

4.2.1 Dust Monitoring and Control

Fugitive dust levels are expected to be low during the cooler months when the exposed tailings beach is relatively small and wet. In the summer months, the water pool will recede and the beach sands can dry out making it necessary to wet these areas with tailings solution or raffinate solution. These solutions contain high concentrations of salts and are effective in forming a hard crust over the tailings. The tailings solution will be obtained through a sump pump and portable line attached to the barge and the raffinate will be obtained from the return line from the evaporation pond (see Section 5.1.1 below). The solution will be applied to the tailings surface using portable pipes and hoses and drip lines, rain-birds or similar methods. The dust suppression system will be checked daily for proper operation. Delivery pumps, lines and spray/drip irrigation systems will be cleaned and/or replaced as necessary to maintain adequate coverage of the tailings beach area.

Dust monitoring will be accomplished using the two existing stationary PM-10 (i.e., particulate matter of 10 microns or less in size) monitors. The two monitoring stations are located on-site near the north and west property boundaries. The monitors will be run for 24 hours every third day and filters will be collected and sent to an analytical laboratory

for weighing. Concentrations are determined based on the weight of the particles collected divided by the volume of air circulated through the PM-10 monitor.

4.2.2 Radiation Monitoring and Control

Radiation levels within the tailings area will be controlled through the use of water levels and water irrigation. Saturated tailings emanate considerably less radiation than unsaturated tailings. The “Uranium Mill Tailings Radon Flux Calculations” report by Golder Associates Inc. (Golder, 2010c) indicates that even with zero percent water cover, the radon flux will remain well below $20 \text{ } \rho\text{Ci/m}^2\text{s}$ as long as the tailings remain saturated. However, the report shows that as tailings lose saturation, the radon flux increases rapidly.

Radiation monitoring will be conducted using monitoring devices and radon modeling as described below.

Air Monitoring Devices: Five existing stationary total suspended particulate (TSP) monitors provide continuous monitoring of uranium, radium-226, thorium-230 and lead-210. Three monitoring stations are located on site near the east, north, and west boundaries and two are located off-site (upwind and downwind). The filters are collected every two weeks and composited and analyzed on a quarterly basis by an analytical laboratory. Radionuclide concentrations are determined by dividing the activity level by the volume of air circulated through the monitor. Personnel working in the tailings area will also be equipped on a periodic basis with portable dust monitors to determine worker exposure levels. The filters from these devices will be shipped to an analytical laboratory for analyses of radon progeny. Individual and cumulative doses received by mill personnel will be recorded and tracked.

Radon Modeling: Radon modeling will be conducted and reported to CDPHE using the MILDOS AREA model. This model calculates the potential doses received by nearby residents. Monitoring data from stacks and other point sources will be input into the model. Area sources such as the tailings cell and ore stockpile area will be modeled by sampling these areas and assigning radionuclide activity levels for these areas based on the sampling results. The wind speed and direction data from the site’s meteorological station are also input into the model.

Seepage Monitoring and Control

Pipes and liner systems will be equipped with secondary containment and leak detection and recovery systems. Flow rates from the LCRS system, underdrain system, barge water recovery system, and dust suppression system will be recorded and reported in accordance with applicable permits. Water levels within the sumps will also be recorded and evaluated on a daily basis. Samples of the various solutions and deposited solids within the tailings area will be periodically collected and analyzed to physically and chemically characterize these materials. The results will be reported to the CDPHE in conjunction with the MILDOS AREA modeling report. Tailings and solution elevations within each tailings cell will be periodically recorded and compared to the stage capacity curve for the facility. Precipitation and evaporation levels will also be recorded on a continuous basis and used to maintain a detailed water balance for the site.

If a failure occurs in a primary liner system, it would be detected by:

- an increase in flow or solution levels within the applicable leak collection system;
- changes in the water balance; or
- a black discoloration on the surface of the white primary liner.

Wherever practicable, leaks will be identified and repaired immediately by the maintenance crew. If leaks cannot be located/repared due to covering by tailings, but are relatively small and within permit limits, the pump-back systems would provide adequate control by maintaining low hydraulic head on the secondary composite liner system. Large seepage rates, should they occur, may require shutting down and repairing that component of the tailings liner system and/or implementing additional investigation and remediation measures.

Maintenance within the tailings cells will also include daily inspections of the tailings line and distribution systems. Identified leaks in the primary lines will be either repaired immediately or scheduled for repair during a subsequent maintenance period, depending on the severity. Plugged spigots and valve assemblies will be cleaned, repaired, or replaced on a routine basis. Wear strips will be added as necessary to protect high-use areas from abrasion and liner damage.

Aboveground pumps will be inspected daily and packing tightened or replaced as necessary. Suction lines will be observed for potential blockage and flow meter records will be checked to verify adequate pumping rates. Water level and flow records for submersible pumps will be checked daily. If a submersible pump shows a diminishing

pumping rate or stops pumping while sump levels remain high, the pump will be inspected and repaired or replaced if damaged.

In most cases, maintenance work within the tailings cells will be limited to foot traffic along the distribution lines. ATVs or small pickup trucks will be used on the access road around the perimeter of each tailings cell. Occasionally, a mobile crane (i.e., cherry-picker) will be used to change out a pump on the barge or move discharge lines.

Wildlife Monitoring and Protection

The tailings solution can be acutely and chronically toxic to wildlife because of its relatively low pH and elevated metal concentrations. The tailings liner surface is also slick and relatively steep (3H:1V), which could prevent larger hoofed mammals from exiting a tailings cell if they should accidentally enter the area. Therefore, wildlife will be excluded from the tailings area by implementation of the following measures.

- A six-ft high chain-link fence topped by three strands of barbed wire will be installed around the entire perimeter of the tailings cells and evaporation ponds. The fence will include a fine mesh from two feet below the ground to three feet above the ground to prevent burrowing animals and smaller ground-dwelling wildlife from entering the tailings area. The fence will be inspected daily and repaired, as necessary, to prevent access to the area by wildlife.
- Bird balls will be placed on top of the ponded portion of the tailings area to prevent birds from landing on the water. The hollow balls are made of plastic and float on top of the water concealing the water surface and creating a physical barrier. The bird balls will be inspected daily and augmented/replenished as necessary to keep the tailings solution covered.
- Mill personnel will inspect the tailings cells on a daily basis. As part of their inspection, they will identify and record any wildlife mortalities and, where possible, implement measures to reduce or eliminate future occurrences.

5.0 EVAPORATION PONDS OPERATING AND MONITORING PROCEDURES

This section describes the operating and monitoring procedures for the evaporation ponds that will be in place during normal operations, abnormal circumstances, and the pre-closure period. The procedures are designed to limit fugitive dust emissions to ALARA levels while still allowing for efficient closure of the ponds at the end of their useful lives. Fugitive dust is primarily controlled by maintaining a water cover over the salts that precipitate out of solution.

5.1 Standard Operating Procedures

On average, approximately 30 percent of the barren raffinate (i.e., waste water) that exits the vanadium raffinate circuit cannot be recycled for use in the mill and will be disposed of in the evaporation pond system. The raffinate is expected to have a total dissolved solid (TDS) concentration of about 15,000 milligrams per liter (mg/L). As the water evaporates, the dissolved solids precipitate out of solution and settle at the bottom and sides of the ponds. Bench-scale testing (Energy Fuels, 2010) indicates that this precipitant will have relatively low levels of radioactivity (i.e., approximately one percent of the radioactivity found in the tailings).

As shown on Figure 4, the raffinate is pumped from the mill to the first evaporation pond, Pond 1, located in the southeast corner of the initial set of ten ponds. From there the water flows west into Ponds 2 through 5 before flowing north into Pond 6. From Pond 6, the water flows east into Ponds 7 through 10. The ponds are expected to be close to full during the winter months when evaporation levels are low and nearly empty during the summer months when evaporation levels are high. Rainbirds or misters may also be used during daylight hours in the warmer summer months to enhance evaporation. The enhanced evaporation system would be confined to the central six cells to avoid overspray from the lined containment area.

5.1.1 Cold-Weather Operations

The primary concerns during the colder months are maintaining adequate pond capacity and ice/wind storms that could potentially pull the bird netting down. The ponds were designed with one additional foot of freeboard based on a conservative water balance study. Accordingly, the ponds are 10 feet rather than 9 feet deep. Energy Fuels will monitor the water level in the ponds on a daily basis. In the event that the water level reaches ten feet, all raffinate would be directed to a tailings cell. The one foot of

remaining freeboard will provide adequate capacity for holding the 1,000-year storm event for the evaporation ponds and the stormwater ponds at the mill.

The bird netting support system has been designed so that the polyclip fasteners holding the netting to the overhead wires will release under a heavy ice or wind loading. The system was designed in this fashion so that the main support structures will not be damaged by heavy loadings. Should most or all of the netting be released, the ponds would need to be incrementally drained to allow for maintenance equipment with an elevated work platform to access the pond area. The water removed from the pond under repair would be pumped to another pond. A sacrificial piece of geomembrane would then be laid over the pond side and bottom to protect the liner from damage when the low-ground pressure equipment is being moved into and within the pond area. Mill personnel would then attach new or repaired netting to the wire system using new polyclips. Minor damage to the netting system would not require the draining of a pond, as replacing and/or refastening the netting can be done from a floating raft using a mechanical hand on a telescoping extension handle.

5.1.2 Warm-Weather Operations

The primary concerns during the warm-weather months are evaporating sufficient water to provide capacity for the winter months, minimizing fugitive dust, and high winds and thunderstorms that could potentially pull down or damage the bird netting. Damaged or down netting would be handled in the same manner as described above. Evaporation will be maximized by installing an enhanced evaporation system along the central berm of the six interior ponds. The system will consist of sprinklers, misters or similar devices fed by the mill raffinate pump and, if needed, submersible pumps within the evaporation pond system. System components will be corrosion and acid resistant.

The 10-foot deep evaporation ponds have connecting weirs at a height of five feet; accordingly, as the water level drops below five feet, the ponds will no longer be interconnected. This means that some of the ponds, especially those later in the series, may go completely dry. As the water level in the ponds is drawn down, precipitated salts will be exposed on the pond sides and bottom, which could potentially create fugitive dust. The following mitigation measures will be employed to minimize fugitive dust.

- Precipitated salts on the sides of ponds will be washed into the pond using a hose or water sprays.
- Salts exposed on pond bottoms will be kept wetted with water sprays.

5.1.3 Abnormal Circumstances

If the mill goes on standby or the project area experiences a prolonged drought, the volume of water in the evaporation ponds will gradually draw down as water is lost through evaporation and/or pumped to the tailings cell to maintain a water cover over the tails. Initially, the same mitigation measures mentioned above may be used to control fugitive dust; however, if the standby period is prolonged, the following additional mitigation measures will become necessary.

- Exposed salts will be sprayed with a chemical dust suppressant or covered with a temporary cover.
- Ponds with minimal salt deposition may be cleaned out with water sprays and the resulting slurry pumped to another pond or to a tailings cell.

In the event of large storm events and/or a prolonged wet period, excess water may be stored in the tailings cell and evaporated by placing water sprays on top of the tailings beaches. Additional evaporation ponds could also be constructed if warranted.

5.1.4 Pre-Closure Operations

Evaporation ponds will need to be removed from service should they fill with precipitated salts or if the primary liner is damaged and experiences high rates of leakage to the LCRS. Depending on the age and condition of the liner, the pond may be decommissioned or repaired as follows.

- If the liner is in relatively good condition, the precipitated salts can be cleaned out with water sprays and the resulting slurry pumped to the tailings cell. This would allow the pond to be put back in service after inspections, testing, and repairs are performed.
- If the liner is in poor condition or the pond is no longer needed, the precipitants may be mixed with soil or another binding agent and excavated with a small skid loader. The liners would then be cut into manageable pieces for disposal and removed. Soil sampling and analysis would be conducted afterwards to identify and remove potentially contaminated soil. The materials generated during decommissioning would be placed in a trench within the tailings cell operating at that time.

5.2 Evaporation Ponds Monitoring and Control Procedures

Monitoring and control procedures within the evaporation ponds area will focus on dust emissions, radiation levels, solution leakage, and wildlife protection. Each of these areas of concern is discussed below.

5.2.1 Dust Monitoring and Control

As discussed in the “Raffinate Characterization Report” (Energy Fuels, 2010) and the “Evaporation Pond Radon Flux Analysis” (SENES, 2010), the salt precipitants from the raffinate are expected to have relatively low radioactivity levels. Under normal conditions, fugitive dust levels are expected to be minimal at the evaporation cells because the cells are covered with water. If one or more cells dry out during the summer months, the mister system or hand-held hoses will be used to spray raffinate on the exposed precipitants to keep them moist.

Dust monitoring will be accomplished using the two existing stationary PM-10 monitors as described previously in Section 4.2.1.

5.2.2 Radiation Monitoring and Control

Radiation levels within the evaporation ponds area are expected to be minimal as the radiation levels in the solution and salt precipitants are relatively low. Predicted radon flux levels are less than 2 pCi/m²s even under the most conservative scenarios (SENES, 2010).

Monitoring for airborne uranium, radium-226, thorium-230, and lead-210 will be conducted at the five monitoring stations as described in Section 4.2.2. Personnel working in the evaporation pond area will also be equipped on a periodic basis with portable dust monitors to determine worker exposure levels.

Seepage Monitoring and Control

The lined pipe trench from the mill and tailings cells to the evaporation ponds daylight at Evaporation Pond 1. The pipe and liner between the evaporation ponds and the tailings cells will be inspected daily and identified damage will be repaired immediately or scheduled for repair during a subsequent maintenance period, depending on the severity. Spray systems and pumps within the evaporation ponds will also be inspected daily and cleaned and repaired, as necessary, to maintain their function.

As discussed in Section 3, each of the pond cells has a dedicated LCRS system. Water level indicators in each sump allow mill personnel to identify seepage through the primary liner. A dedicated sump pump and flow meter will be installed in any sump that requires daily pumping. A portable sump pump may be used for those sumps that collect minimal amounts of water and only require occasional pumping. By documenting sump levels and flow rates for each LCRS, personnel are able to track seepage rates over time.

If the seepage rates are high enough, a cell can be taken out of service temporarily and repaired. This requires sandbagging its spillways and installing a temporary diversion (an HDPE pipe within a lined trench) bypassing that cell. The cell can then be pumped out, hosed down, and inspected for punctures or tears.

Wildlife Monitoring and Protection

The raffinate solution can be acutely and chronically toxic to wildlife because of its relatively low pH and elevated metal concentrations. The pond liners are also slick and relatively steep (3H:1V), which could prevent larger hoofed mammals from exiting a pond if they should accidentally enter the area. Therefore, wildlife will be excluded from the evaporation pond area by implementation of the following measures.

- A six-ft high chain-link fence topped by three strands of barbed wire will be installed around the entire perimeter of the evaporation ponds and tailings cells. The fence will include a fine mesh from two feet below the ground to three feet above the ground to prevent burrowing animals and smaller ground-dwelling wildlife from entering the evaporation pond area. The fence will be inspected daily and repaired, as necessary, to prevent access to the area by wildlife.
- Woven bird netting will be installed over and along the sides of the evaporation pond network. The bird netting will be inspected daily and repaired or replaced as necessary.
- Mill personnel will inspect the evaporation ponds on a daily basis. As part of their inspection, they will identify and record any wildlife mortalities and, where possible, implement measures to reduce or eliminate future occurrences.

6.0 REFERENCES

Golder Associates, Inc. 2008a. Tailings Cell Design Report. Piñon Ridge Project. Montrose County, Colorado. October.

Golder Associates, Inc. 2008b. Evaporation Pond Design Report. Piñon Ridge Project. Montrose County, Colorado. October.

Golder Associates, Inc. 2010a. Tailings Cell Foundation and Closure Cover System Settlement Analyses Addendum, Piñon Ridge Project, Montrose County, Colorado. April 9.

Golder Associates, Inc. 2010b. Tailings and Evaporation Pond Delivery and Return Piping Conceptual Plan, Piñon Ridge Project, Montrose County, Colorado. August 6.

Golder Associates, Inc. 2010c. Uranium Mill Tailings Radon Flux Calculations, Piñon Ridge Project. August.

SENES Consultants Limited. 2010. Evaporation Pond Radon Flux Analysis, Piñon Ridge Mill Project, Montrose County, Colorado. August 4.

Energy Fuels Resources Corporation. 2010. Raffinate Characterization Report, Piñon Ridge Mill. August.

FIGURES

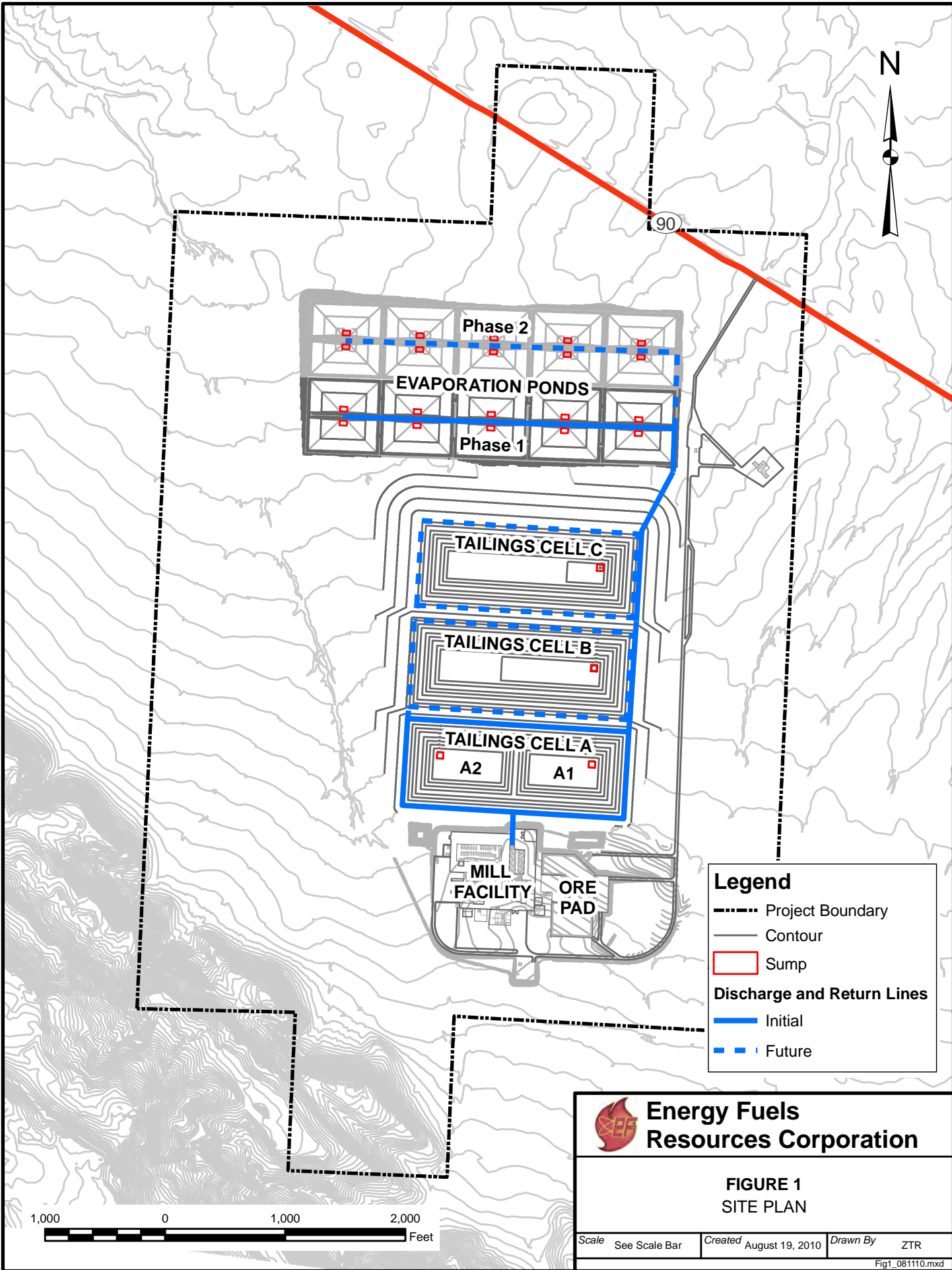

Legend

- Project Boundary
- Contour
- Sump

Discharge and Return Lines

- Initial
- - - Future

 **Energy Fuels Resources Corporation**

FIGURE 1
SITE PLAN

Scale	See Scale Bar	Created	August 19, 2010	Drawn By	ZTR
-------	---------------	---------	-----------------	----------	-----

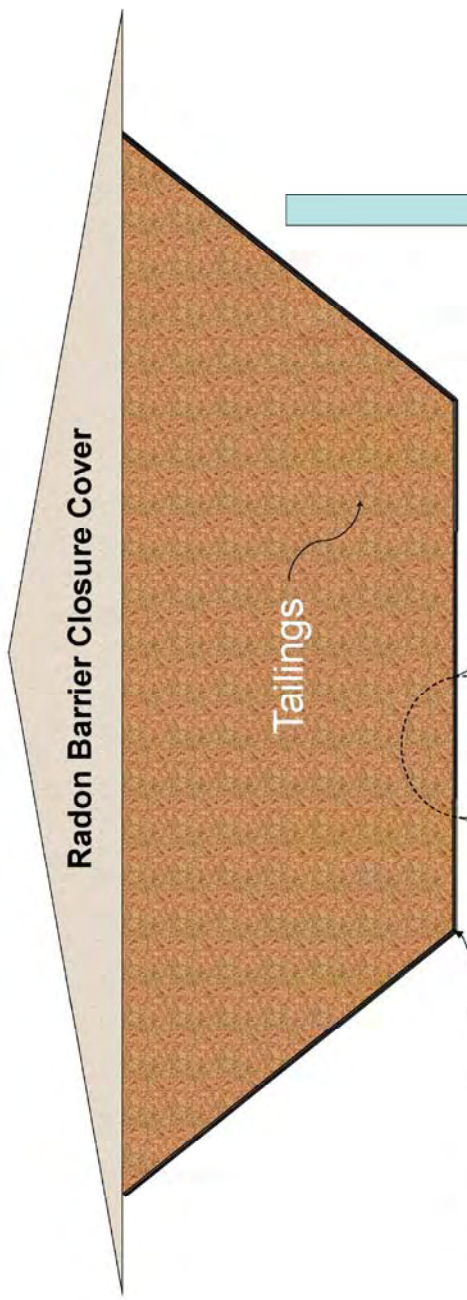

Groundwater, where present, is 450 feet beneath proposed facility

Multi-layer liner system under sides and base of tailings cells

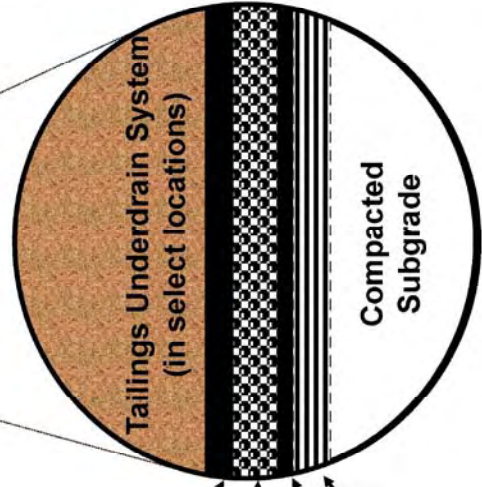

Liner Detail

- High Density Polyethylene (HDPE) Primary Geomembrane
- LCRS = HDPE Geonet (on base) / Drainage Geocomposite (on side slopes)
- HDPE Secondary Geomembrane
- Geosynthetic Clay Liner (GCL)



FIGURE 2
TAILINGS CELL LINER SCHEMATIC

Scale	None	Created	August 23, 2010	Drawn by	ZTR
-------	------	---------	-----------------	----------	-----

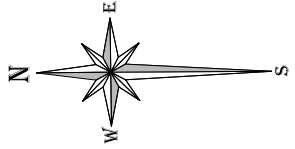

LEGEND

- 2-FOOT CONTOUR
- WATER POOL
- TAILINGS
- ➔ DEPOSITION POINT
- BARGE-MOUNTED PUMP
- LCRS SUMP

CENTRAL DIVIDER BERM
TAILINGS CELL CREST

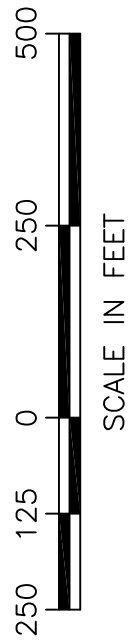
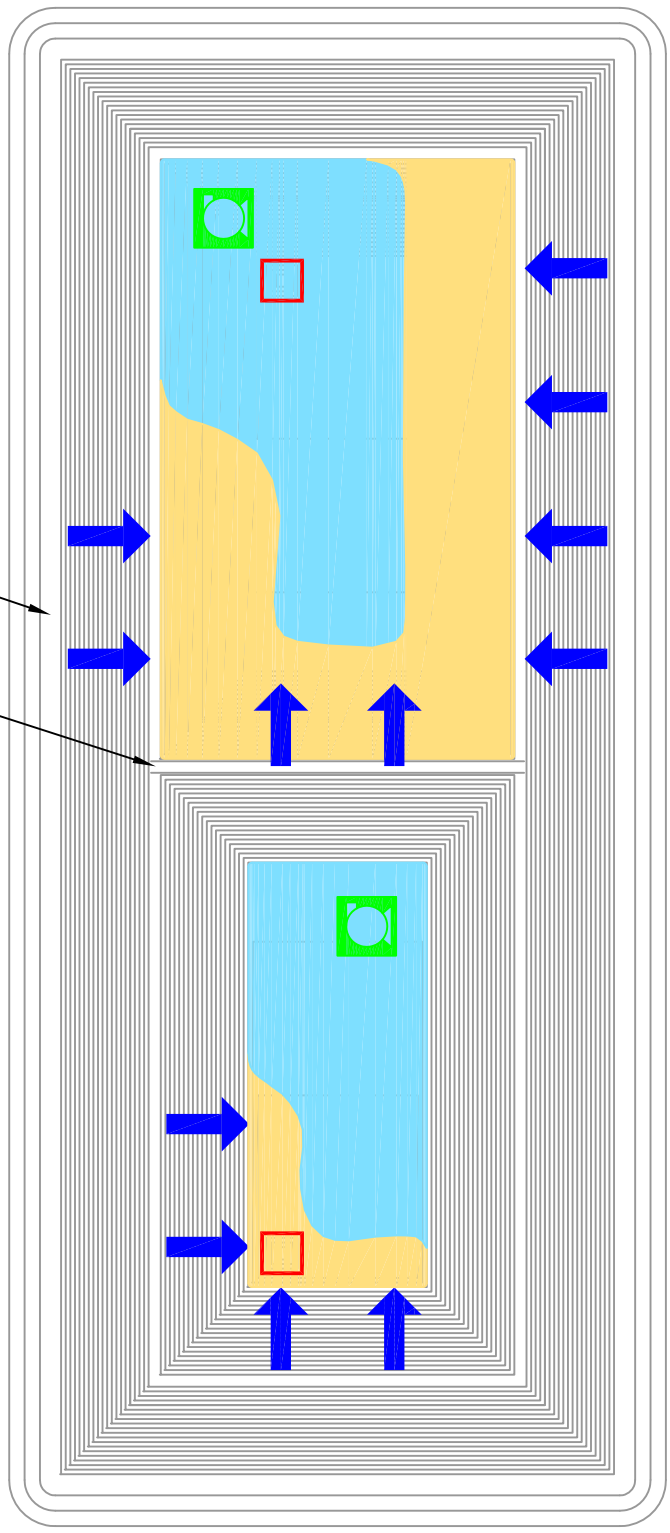

LEGEND

- 2-FOOT CONTOUR
- WATER POOL
- TAILINGS
- ➔ DEPOSITION POINT
- BARGE-MOUNTED PUMP
- LCRS SUMP

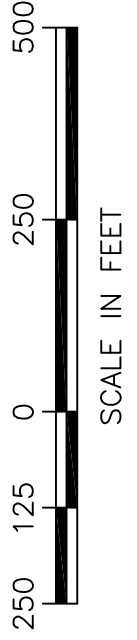
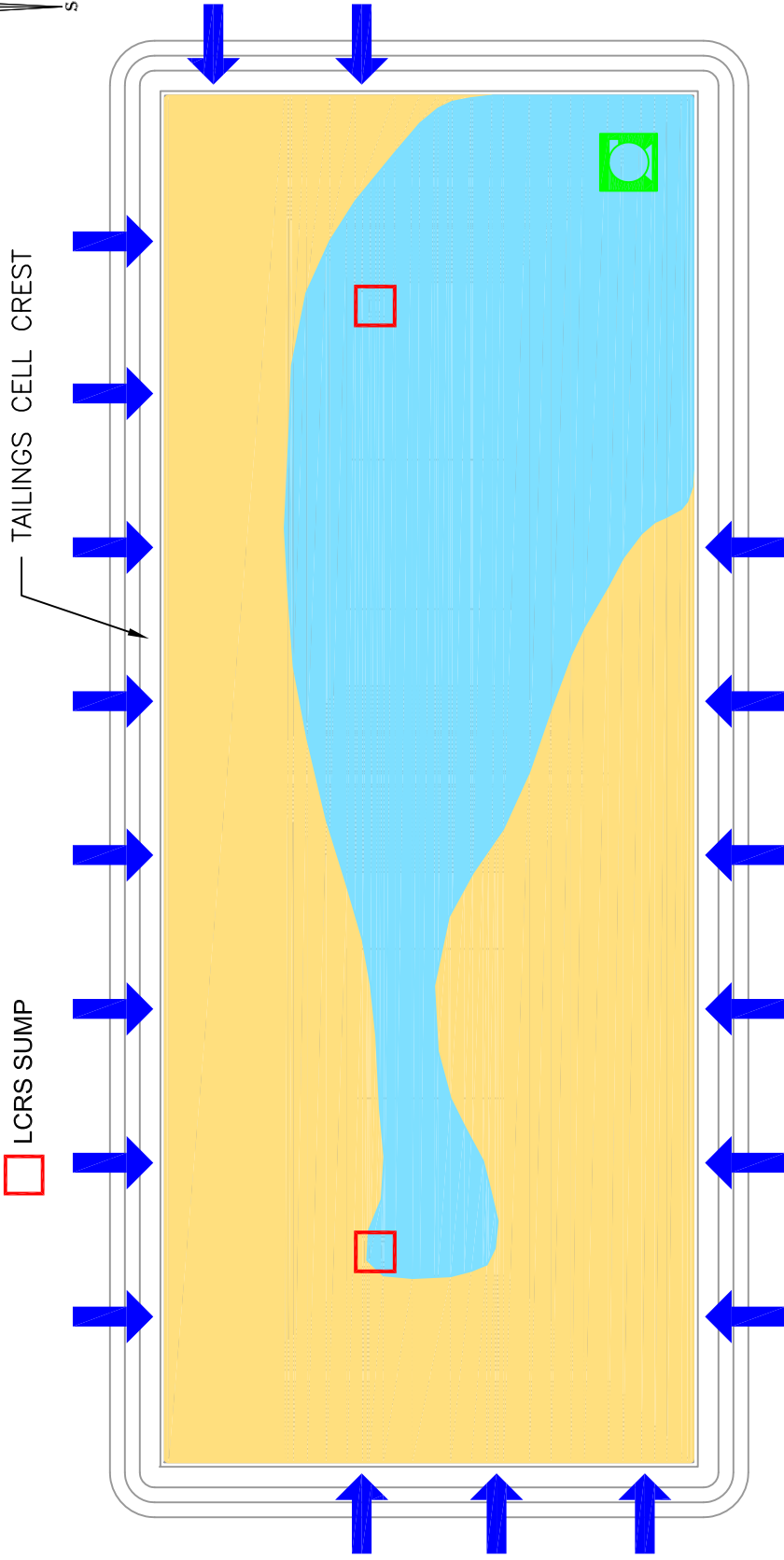
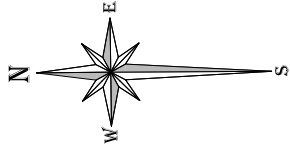

**Energy Fuels
Resources Corporation**

FIGURE 3B
TYPICAL TAILINGS DEPOSITION
ONE CELL

Scale	1" = 250'	Created	August 23, 2010	Drawn by	ZTR
-------	-----------	---------	-----------------	----------	-----

LEGEND

- 2-FOOT CONTOUR
- INTERNAL BERM
- WATER POOL
- TAILINGS
- ➔ DEPOSITION POINT
- ☐ LCRS SUMP

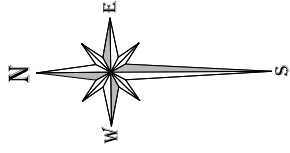

TAILINGS CELL CREST

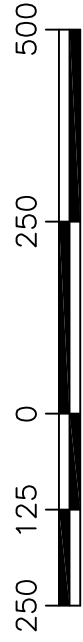
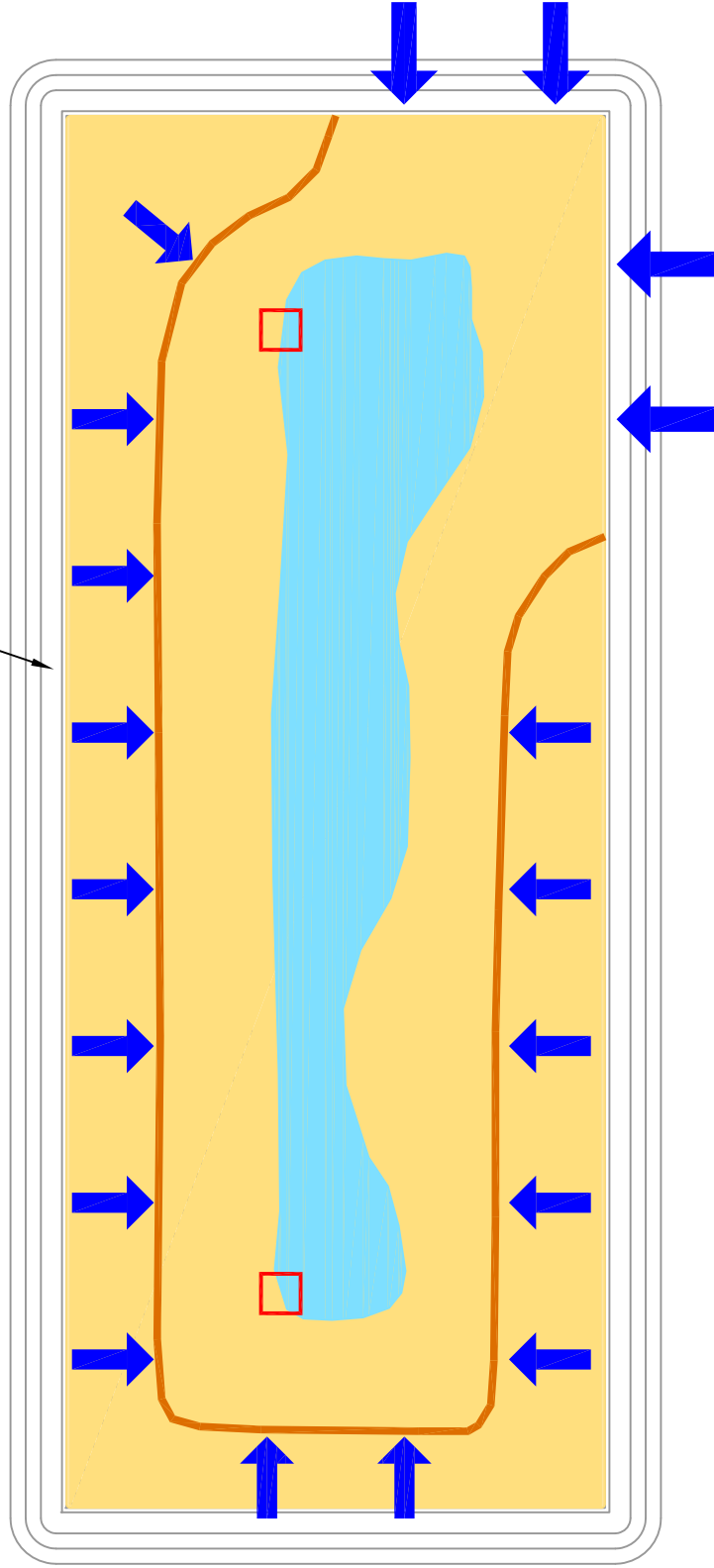

SCALE IN FEET



**Energy Fuels
Resources Corporation**

FIGURE 3C

PHASE I INTERNAL BERM LAYOUT

Scale	1" = 250'	Created	August 23, 2010	Drawn by	ZTR
-------	-----------	---------	-----------------	----------	-----

LEGEND

— 2-FOOT CONTOUR

— I — INTERNAL BERM AND PHASE

■ TAILINGS

□ LCRS SUMP

TAILINGS CELL CREST

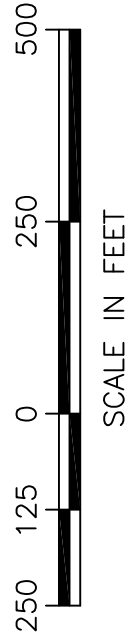
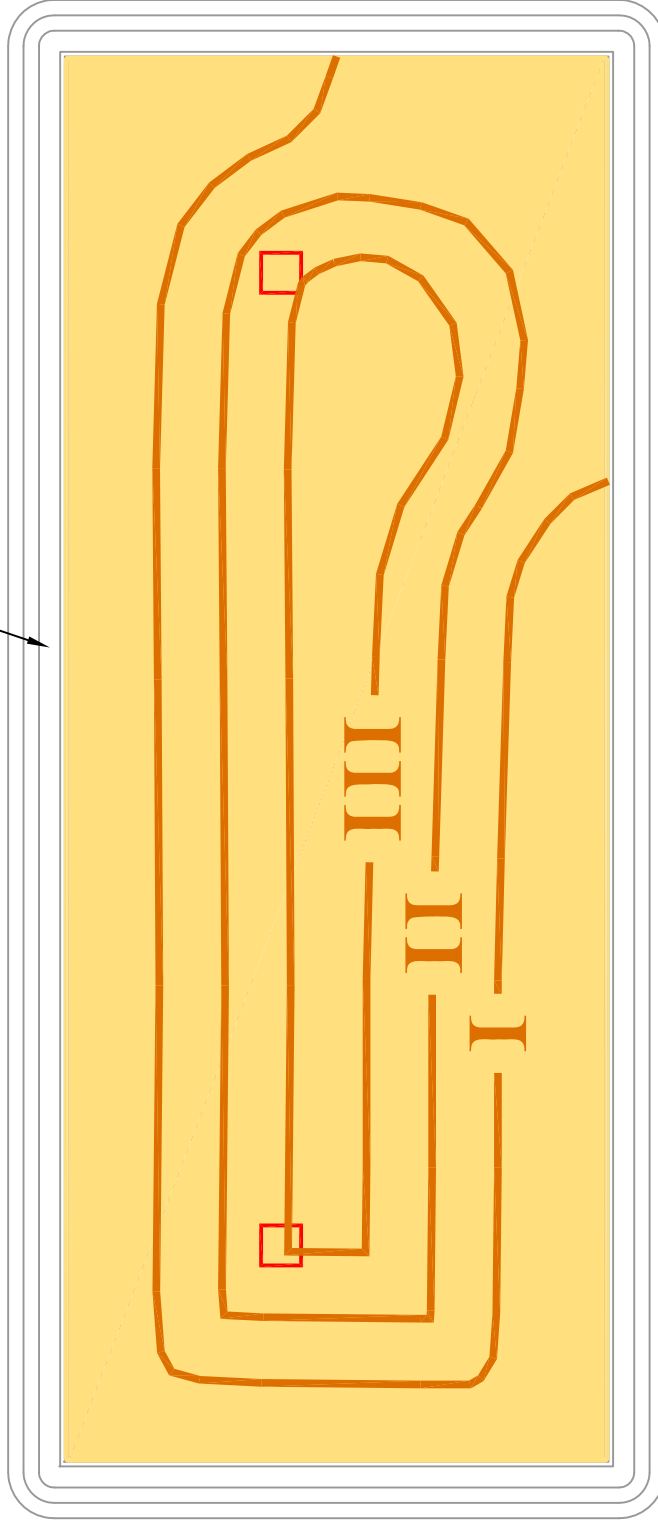
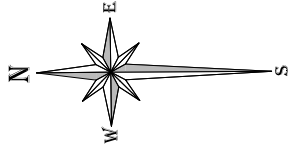

**Energy Fuels
Resources Corporation**

FIGURE 3D
PHASED CONSTRUCTION
OF INTERNAL BERMS

Scale 1" = 250' Created August 23, 2010 Drawn by ZTR

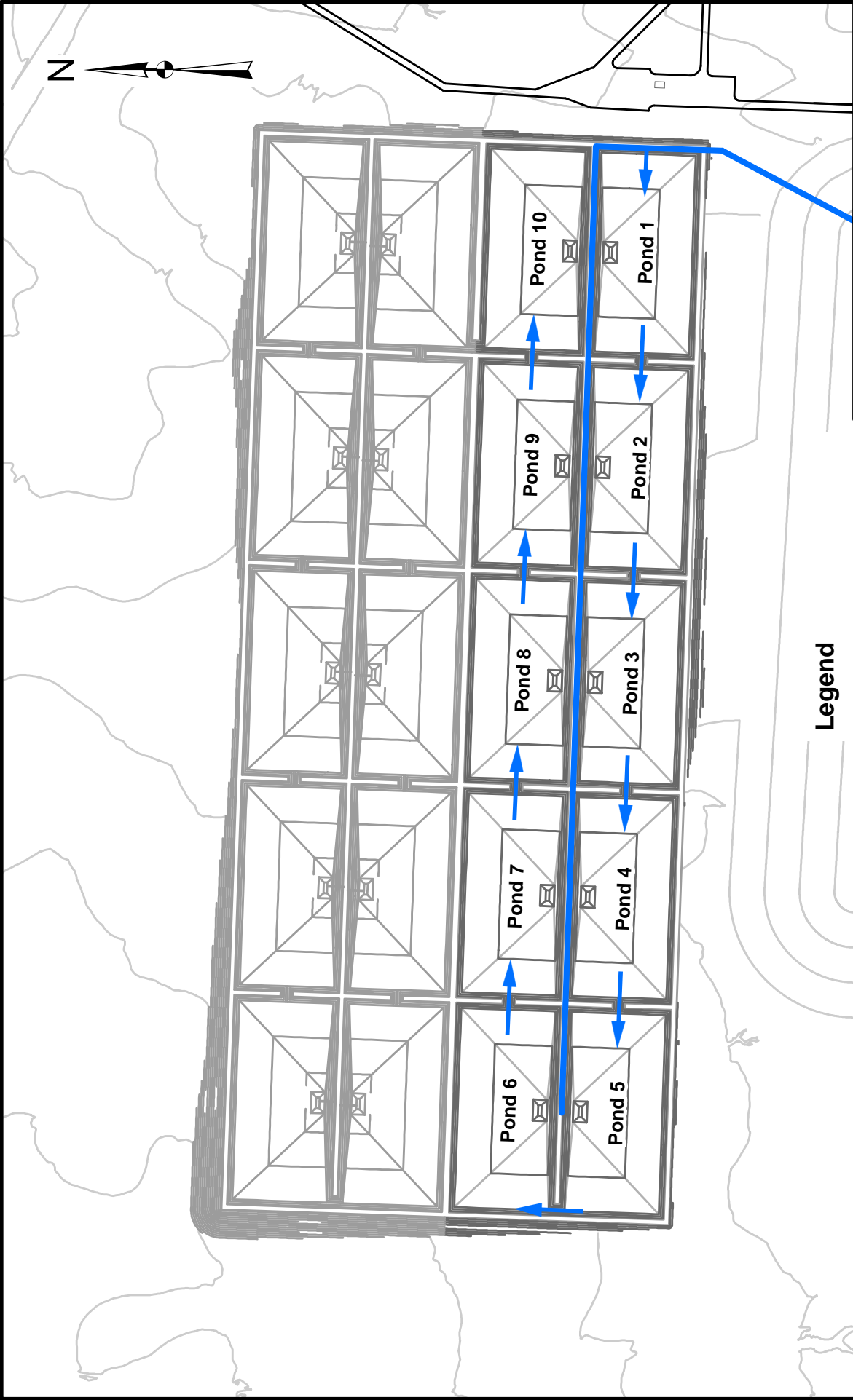

Energy Fuels Resources Corporation

FIGURE 4

EVAPORATION POND FILL SEQUENCE

Scale See Scale Bar Created August 25, 2010 Drawn By ZTR

Fig: 082010.mxd

Legend

- Flow
- Discharge and Return Lines
- Evaporation Pond Contours**
- Phase 1
- Phase 2



APPENDIX A

Tailings and Evaporation Pond Delivery and Return Piping Conceptual Plan

August 6, 2010

Project No. 073-81694.0020

Mr. Bob Monok
Energy Fuels Resources
44 Union Boulevard, Suite 600
Lakewood, Colorado 80228

RE: TAILINGS AND EVAPORATION POND DELIVERY AND RETURN PIPING CONCEPTUAL PLAN, PIÑON RIDGE PROJECT, MONTROSE COUNTY, COLORADO

Dear Mr. Monok:

Golder Associates Inc. (Golder) has prepared this letter to present the conceptual plan for the tailings and evaporation pond delivery and return piping for the Piñon Ridge project in Montrose County, Colorado. This letter has been prepared as an addendum to Golder's "Tailings Cell Design Report," dated October 2008.

1.0 INTRODUCTION

The Piñon Ridge project site is located in the Paradox Valley of Montrose County, Colorado, approximately 15 miles northwest of the town of Naturita. The project is in an advanced stage of permitting and review for a new Uranium and Vanadium Mill. The mill is anticipated to produce 500 tons per day of tailings over its life of approximately 40 years. Golder's services on this project have included design engineering for the tailings cells and evaporation ponds, as documented in the 2008 design reports^{1,2}.

In support of those design reports and as an addendum to the "Tailings Cell Design Report," Golder has prepared this letter summarizing at a conceptual level the delivery and return piping for the tailings cells and evaporation ponds. This letter addresses the piping for Tailings Cells A and B and the Phase 1 Evaporation Ponds. Golder's design reports also include designs for a future Tailings Cell C and Phase 2 Evaporation ponds, which will include conceptually similar piping; however, piping for these future facilities are not specifically addressed in this plan.

2.0 SITE DESCRIPTION

The Piñon Ridge project site is situated in the Paradox Valley of western Colorado at an approximate average elevation of 5,500 feet above mean sea level (amsl). The site terrain slopes downward to the north from about 5,560 ft amsl at the south edge of the mill area to 5,420 ft amsl at the north edge of the Phase 2 Evaporation Ponds.

The mill area is located at the southern end of the site, between about 5,560 to 5,530 feet amsl. Tailings cell A is immediately north of and at an elevation below the mill area; Tailings Cell B is immediately north of and at an elevation below Tailings Cell A; and Tailings Cell C is immediately north of and at an elevation below Tailings Cell B. The top elevations of the tailings cell perimeter berms are 5,525 ft amsl, 5,511 ft amsl, and 5,496 ft amsl for Cells A, B and C, respectively. The Phase 1 Evaporation Ponds are located immediately north of and at an elevation below Tailings Cell C and the Phase 2 Evaporation Ponds are located immediately north of the Phase 1 Evaporation Ponds. The top elevation of the evaporation pond berms is 5,449 ft amsl.

¹ Golder Associates Inc. 2008. *Tailings Cell Design Report, Piñon Ridge Project, Montrose County, Colorado*. Submitted to Energy Fuels Resources Corporation. Golder Project No. 07381694.0003. October.

² Golder Associates Inc. 2008. *Evaporation Pond Design Report, Piñon Ridge Project, Montrose County, Colorado*. Prepared for Energy Fuels Resources Corporation. Golder Project No. 07381694.0004. October.

i:\07381694\0100\0110\07381694 ltr del&ret conceptual plan 6aug10.docx



3.0 TAILINGS CELLS AND EVAPORATION PONDS DESCRIPTION

The tailings cells are designed to have a total capacity of about 7.3 million tons (Mt). Three tailings cells (A, B, and C) of approximately equal storage volume have been designed to meet this total capacity, with a minimum 3-foot freeboard. The tailings cells are designed as permanent, zero-discharge, single-use facilities and are lined accordingly. The plan area of the lined portions of each tailings cell is 30.5 acres. Pursuant to state and federal regulations, the tailings cells are designed with a primary and secondary liner system, an intervening leak collection and recovery system, and tailings underdrain system. Additionally, the tailings pool within each cell will be equipped with a surface water pump-back system. The crests of each cell have been designed with a 1 percent cross-fall into the cells.

The evaporation ponds are designed for total lined area of 82.6 acres, divided equally between Phase 1 and Phase 2. Each phase consists of ten evaporation ponds with a lined area of 4.13 acres each. Pursuant to state and federal regulations, the evaporation ponds are each designed with a primary and secondary liner system, an intervening leak collection and recovery system, and waterfowl protection systems. The ponds are designed to provide contingency storage for the 1,000-year storm event acting over the respective pond area, with an additional one foot of freeboard (above the required design capacities).

4.0 DELIVERY AND RETURN PIPING

A series of high-density polyethylene (HDPE) pipes will transport the tailings slurry, raffinate water, supernatant tailings water, and recovery waters between the mill, tailings cells, and evaporation ponds. All pipelines are designed for double containment transport of the slurry and fluids:

- The first level of containment is provided by the pipe wall; and
- The second level of containment is provided by routing the pipes in a lined trench or culvert, or by placing the pipes on the cell or pond liner.

The following sections describe the conceptual layout and design of the piping for each of these flows.

4.1 Tailings Slurry Delivery Piping

A 4-inch diameter HDPE tailings slurry delivery pipeline will extend from the tailings sump at the mill to the south edge of Tailings Cell A, as shown on Figure 1. The tailings slurry pipeline is contained within a concrete box culvert with positive fall into the tailings cell (see Detail 2 on Figure 3).

At the south edge of the cell, the pipeline will bifurcate into two 3-inch HDPE distribution lines around the perimeter of the cell, as shown on Figure 1. Spigots, 2-inch diameter, equipped with valves will be installed at 100 to 250 foot centers along the 3-inch line to deposit the slurry into the tailings cell.

After deposition is completed in Tailings Cell A, the spigots into Cell A will be closed, and the slurry flow will be routed through 3-inch HDPE distribution lines around the perimeter of Cell B, as shown on Figure 2. Again, 2-inch diameter valved spigots will be installed at 100 to 250 centers along the Cell B distribution line.

Distribution pipelines will be placed on top of the primary geomembrane liner along the edge of each tailings cell (see Detail 1 on Figure 3). The liner will slope at a minimum 1 percent grade into the cell. HDPE wear strips will be placed under the pipes to reduce the potential for tearing or abrasion of the primary liner.

4.2 Supernatant Tailings Water Return Piping

A 6-inch diameter HDPE return pipeline will carry supernatant tailings water from the tailings cell pump-back system back into the mill for reuse in the process circuit. The pipeline will be placed on top of the primary cell liner along the cell crests. HDPE wear strips will be placed under the pipes to reduce the

potential for tearing or abrasion of the primary liner. Between the tailings cell and the mill, the pipeline will be routed through the tailings slurry delivery concrete box culvert, shown as Detail 2 on Figure 3.

4.3 Raffinate Water Delivery Piping

A 4-inch diameter HDPE raffinate water delivery pipeline will extend from the process circuit to the southeast corner of the Phase 1 Evaporation Ponds, as shown on Figures 1 and 2. A portion of the raffinate water flow will be directed into the southwest evaporation pond cell (with overflow via weirs into adjacent pond cells), and the remaining flow will be routed to evaporation sprinklers installed along the central longitudinal axis of the Phase 1 pond system.

The raffinate water delivery pipeline will be routed from the mill to the south edge of Tailings Cell A in the tailings slurry delivery pipeline concrete box culvert, shown as Detail 2 on Figure 3. The raffinate water delivery line will be placed on top of the primary liner along the south and east edges of the tailings cell(s). The pipeline will be placed in a geomembrane-lined trench between the tailings cells and the evaporation ponds (see location on Figures 1 and 2, with details on Figure 3). The trench will be constructed with a positive fall throughout its length from the tailings cell into the evaporation ponds. HDPE wear strips will be placed beneath the pipes to reduce the potential for tearing or abrasion of the cell and trench liners.

4.4 Raffinate Return Water Piping

A 4-inch diameter HDPE return pipeline will carry raffinate return water from the evaporation ponds to the tailings cells for use in the dust suppression system and to maintain saturation of the tailings beaches. The return pipeline will be routed from the evaporation ponds to the tailings cells in the lined raffinate water delivery trench (see Detail 3 on Figure 3). HDPE wear strips will be placed beneath the pipe to reduce the potential for tearing or abrasion of the cell and trench liners.

5.0 USE OF THIS PLAN

The discussion and figures associated with this plan have been developed to a conceptual level and are not suitable for bidding or construction of the facilities described herein. This letter has been prepared for the use of Energy Fuels Resources and its subsidiaries for the specific application to the Piñon Ridge Project in Montrose County, Colorado. No third-party engineer or consultant shall be entitled to rely on any of the information, conclusions, or opinions contained in this report without the prior written approval from Energy Fuels Resources and Golder.

6.0 CLOSING

Golder sincerely appreciates the opportunity to provide continued engineering services for the Piñon Ridge Project. Please contact the undersigned with any questions or comments on the information contained in this letter.

Sincerely,

GOLDER ASSOCIATES INC.

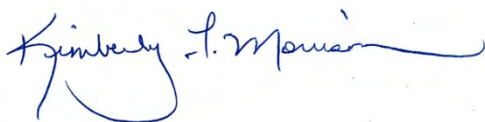

Kimberly Finke Morrison, P.E., R.G.
Associate - Senior Project Manager

Attachments: Figure 1 – Delivery and Return Piping Plan, Cell A Operational
Figure 2 – Delivery and Return Piping Plan, Cell A Closed, Cell B Operational
Figure 3 – Delivery and Return Piping Plan Details



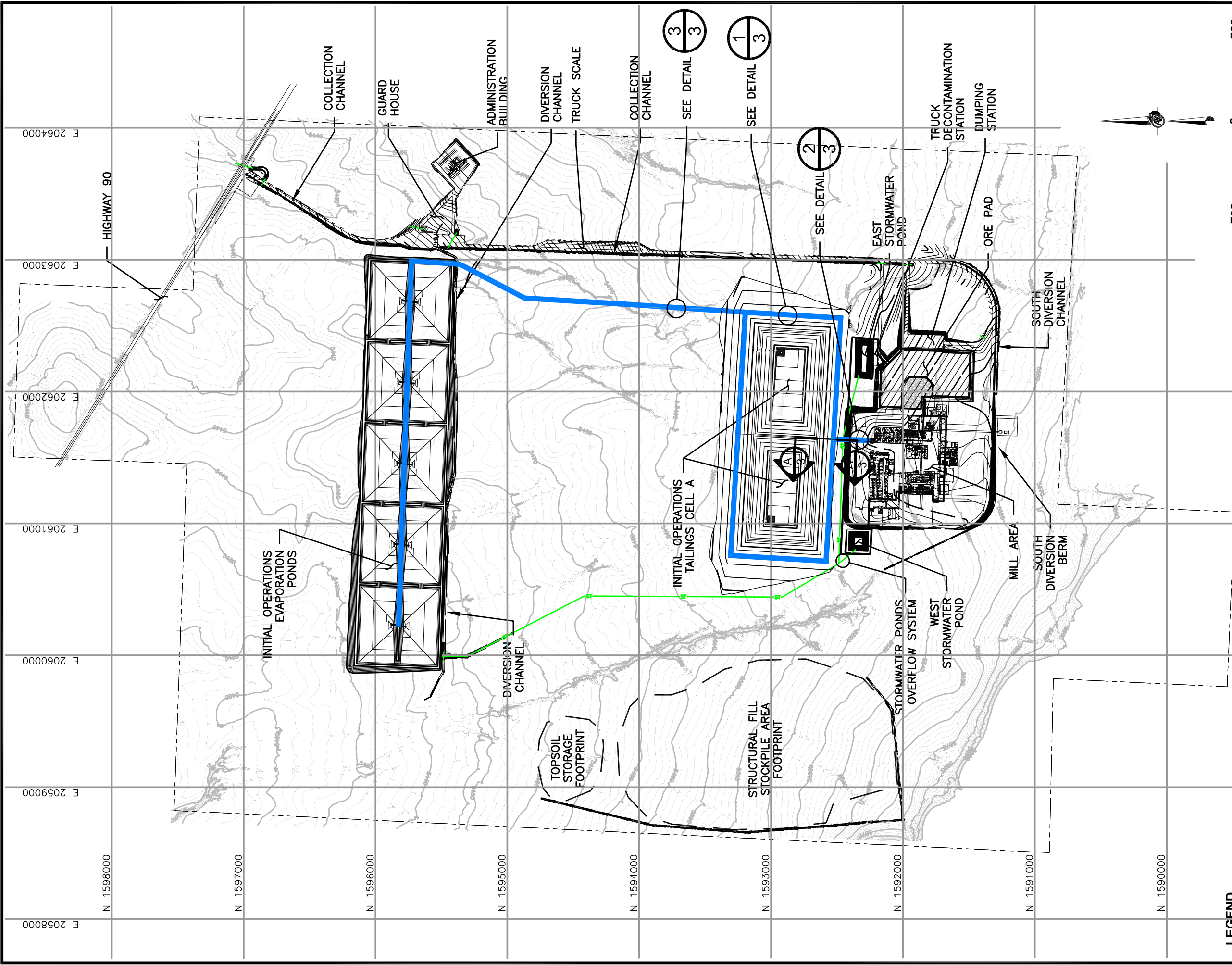

BNS/KFM/rjg

FIGURES

Dwg Name: N:\07\073-5169A_C - SWAMP\0731694C009.dwg
 Layout Name: FIG 1 Machine: DEN-L-JROBERTS
 Last Update: Aug 03, 2010 09:13 By: Jroberts
 Last Plot: Aug 03, 2010 09:19 By: Jroberts

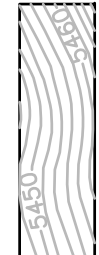
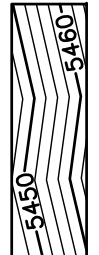

LEGEND

-  EXISTING GROUND TOPOGRAPHY
-  PROPOSED INITIAL CONSTRUCTION GRADES (MILL, CELL A PHASE 1 PONDS)
-  PROJECT BOUNDARY
-  STORMWATER PONDS OVERFLOW SYSTEM
-  DELIVERY AND RETURN PIPING INITIAL OPERATIONS

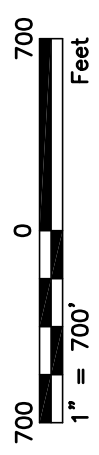

ENERGY FUELS RESOURCES CORPORATION
 PIÑON RIDGE PROJECT
 MONTROSE COUNTY, COLORADO

**DELIVERY AND RETURN PIPING PLAN
 CELL A OPERATIONAL**

PROJ.	ENERGY FUELS RESOURCES CORPORATION		
TITLE	PIÑON RIDGE PROJECT MONTROSE COUNTY, COLORADO		
DELIVERY AND RETURN PIPING PLAN CELL A OPERATIONAL			
PROJECT No.	073-81694	FILE No.	07381694C009
DESIGN	SPS 06/10	SCALE	AS SHOWN REV. A
CADD	JWR 06/10	CHECK	SPS 06/10
REVIEW	KFM 06/10		



FIGURE 1

Plot Time: 08/03/10 09:19

Dwg Name: N:\07\073-5169A_C - SWMP\07381694C010.dwg
 Layout Name: FIG 2 Machine: DEN-L-ROBERTS
 Last Update: Aug 03, 2010 09:13 By: jroberts
 Last Plot: Aug 03, 2010 09:22 By: jroberts

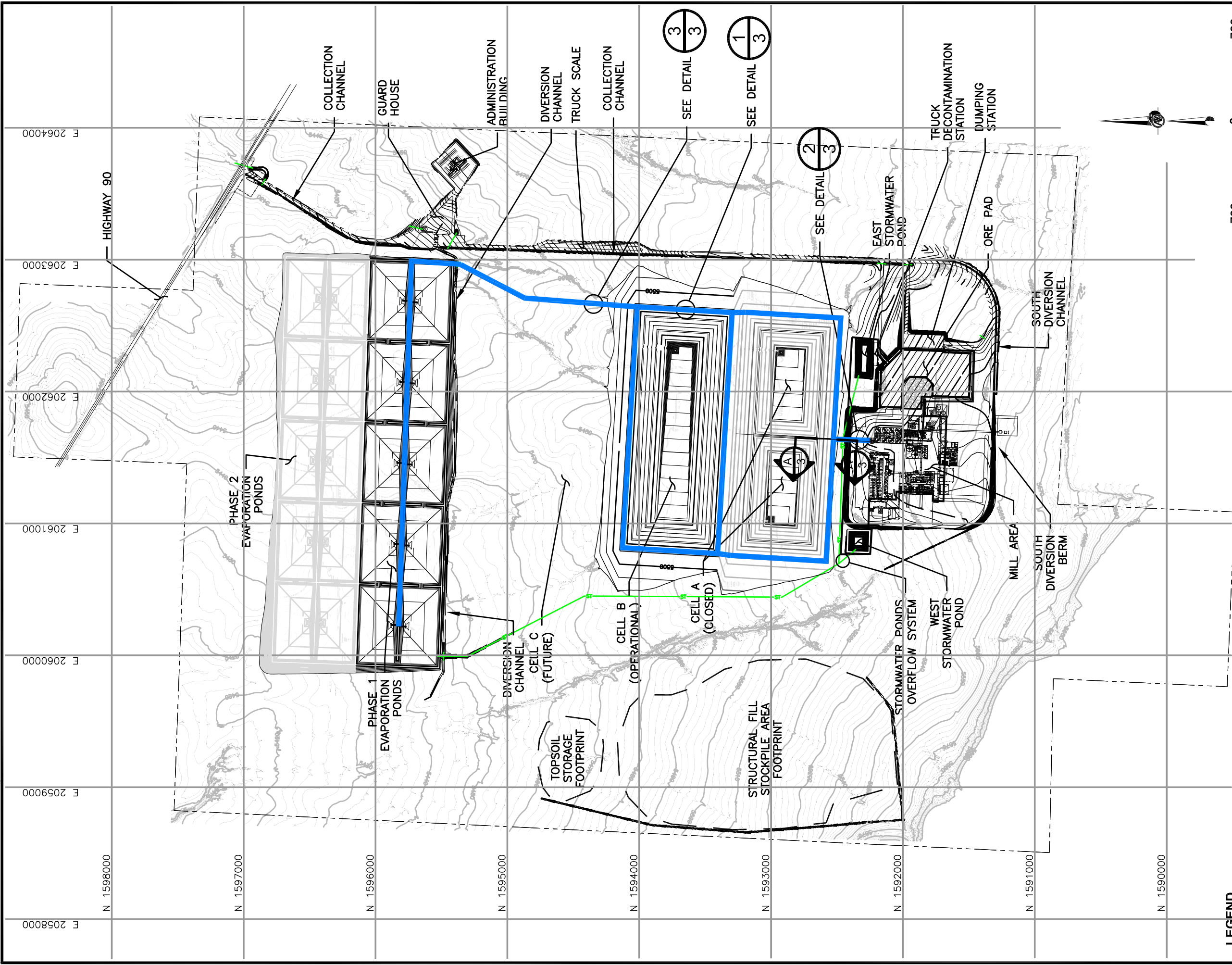

LEGEND

- EXISTING GROUND TOPOGRAPHY
- OPERATIONAL CELL B CONSTRUCTION GRADES (MILL, CELL A PHASE 1 PONDS)
- CLOSED CELL A GRADES
- PROJECT BOUNDARY
- STORMWATER PONDS OVERFLOW SYSTEM
- DELIVERY AND RETURN PIPING INITIAL OPERATIONS

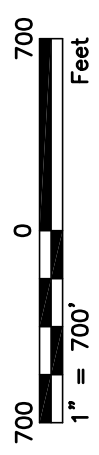
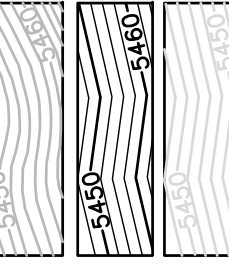

PRO. ENERGY FUELS RESOURCES CORPORATION
 PIÑON RIDGE PROJECT
 MONTROSE COUNTY, COLORADO

TITLE **DELIVERY AND RETURN PIPING PLAN**
CELL A CLOSED, CELL B OPERATIONAL

PROJECT No.	073-81694	FILE No.	07381694C010
DESIGN	SPS 06/10	SCALE	AS SHOWN REV. A
CADD	JWR 06/10	CHECK	SPS 06/10
REVIEW	KFM 06/10		

Golder Associates
 DENVER, COLORADO

FIGURE 2

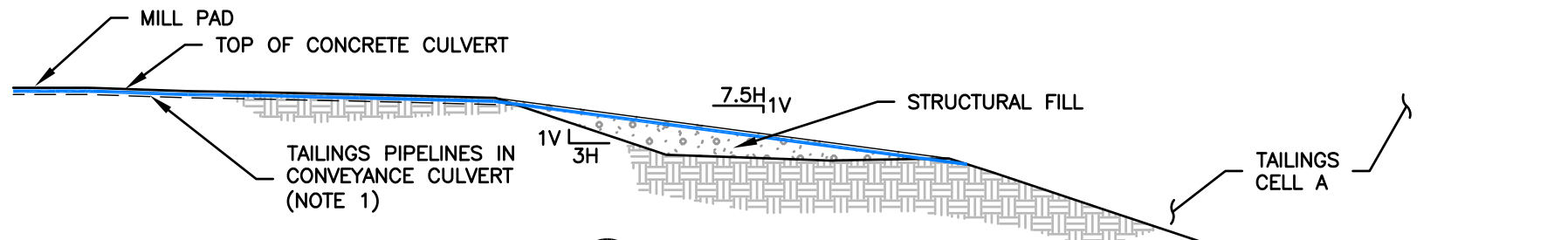

A
3 N.T.S. SECTION A-A'

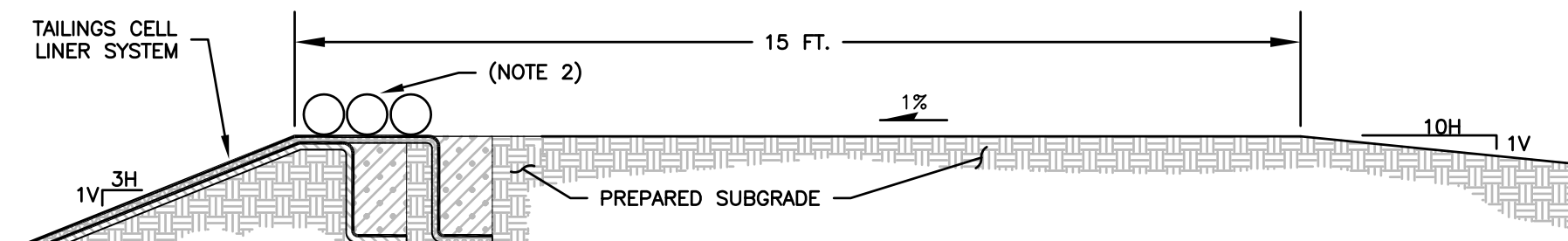

1
3 N.T.S. TAILINGS CELL CREST/ACCESS ROAD AND PIPING DETAIL

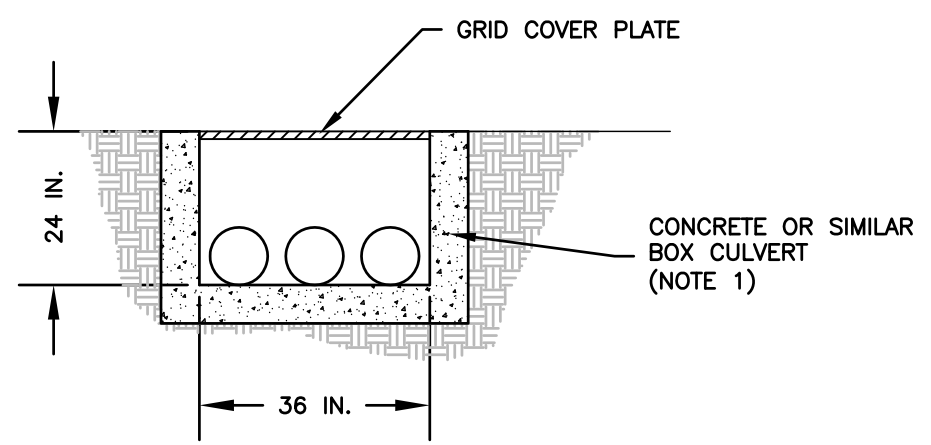

2
3 N.T.S. CONCRETE OR SIMILAR BOX CULVERT WITH GRID COVER PLATE

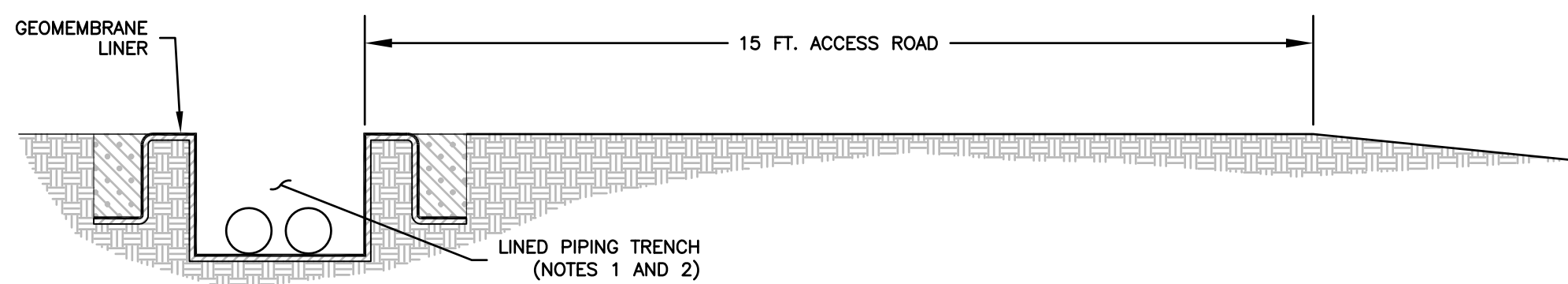

3
3 N.T.S. ACCESS ROAD AND PIPING DETAIL

NOTES

1. CONCRETE CONVEYANCE CULVERT AND LINED PIPING TRENCH TO HAVE A MINIMUM 0.5% SLOPE.
2. INSTALL WEAR STRIPS BETWEEN ALL PIPING AND GEOMEMBRANE LINER.

Dwg Name: N:\07\073-81694\C - SWAMP\07381694C010.dwg
 Layout Name: FIG 3 Machine: DEN-L-JROBERTS
 Last Update: Aug 03, 2010 09:50 By: jroberts
 Last Plot: Aug 03, 2010 11:23 By: jroberts

PROJECT		ENERGY FUELS RESOURCES CORPORATION PIÑON RIDGE PROJECT MONTROSE COUNTY, COLORADO			
TITLE		DELIVERY AND RETURN PIPING DETAILS			
PROJECT No.		073-81694		FILE No. 07381694C010	
DESIGN	SPS	06/10	SCALE	AS SHOWN	REV. A
CADD	JWR	06/10			
CHECK	SPS	06/10			
REVIEW	KFM	06/10			

FIGURE 3

Golder Associates
DENVER, COLORADO