



Water

**Development  
Document for  
Effluent Limitations  
Guidelines and  
Standards for the**

**Final**

**Plastics Molding  
and Forming**

**Point Source Category**



DEVELOPMENT DOCUMENT  
for  
EFFLUENT LIMITATIONS GUIDELINES AND STANDARDS  
for the  
PLASTICS MOLDING AND FORMING POINT SOURCE CATEGORY

William D. Ruckelshaus  
Administrator

Jack E. Ravan  
Assistant Administrator for Water

Edwin L. Johnson  
Director  
Office of Water Regulations and Standards



Jeffery D. Denit, Director  
Industrial Technology Division

Robert W. Dellinger, Chief  
Consumer Commodities Branch  
Industrial Technology Division

Robert M. Southworth, P.E.  
Technical Project Officer

December 1984

U.S. Environmental Protection Agency  
Office of Water  
Office of Water Regulations and Standards  
Industrial Technology Division  
Washington, D.C. 20460

## TABLE OF CONTENTS

<u>Section</u>	<u>Page</u>
I	SUMMARY AND CONCLUSIONS. . . . . 1
	INTRODUCTION . . . . . 1
	TYPE OF EFFLUENT LIMITATIONS GUIDELINES AND STANDARDS. . . . . 4
	CONTACT COOLING AND HEATING WATER SUBCATEGORY. . . . . 5
	Best Practicable Technology Currently Available (BPT) Effluent Limitations Guidelines. . . . . 5
	Best Available Technology Economically Achievable (BAT) Effluent Limitations Guidelines . . . . . 5
	Best Conventional Pollutant Control Technology (BCT) Effluent Limitations Guidelines. . . . . 6
	New Source Performance Standards (NSPS). . . . . 6
	Pretreatment Standards for Existing Sources (PSES) . . . . . 7
	Pretreatment Standards for New Sources (PSNS). . . . . 8
	CLEANING WATER SUBCATEGORY . . . . . 8
	Best Practicable Technology Currently Available (BPT) Effluent Limitations Guidelines. . . . . 8
	Best Available Technology Economically Achievable (BAT) Effluent Limitations Guidelines . . . . . 9
	Best Conventional Pollutant Control Technology (BCT) Effluent Limitations Guidelines. . . . . 9
	New Source Performance Standards (NSPS). . . . . 9
	Pretreatment Standards for Existing Sources (PSES) . . . . . 10
	Pretreatment Standards for New Sources (PSNS). . . . . 11
	FINISHING WATER SUBCATEGORY. . . . . 12
	Best Practicable Technology Currently Available (BPT) Effluent Limitations Guidelines. . . . . 12
	Best Available Technology Economically Achievable (BAT) Effluent Limitations Guidelines . . . . . 12
	Best Conventional Pollutant Control Technology (BCT) Effluent Limitations Guidelines. . . . . 12
	New Source Performance Standards (NSPS). . . . . 12
	Pretreatment Standards for Existing Sources (PSES) . . . . . 13
	Pretreatment Standards for New Sources (PSNS). . . . . 13

TABLE OF CONTENTS (Continued)

<u>Section</u>		<u>Page</u>
II	RECOMMENDATIONS. . . . .	15
III	INTRODUCTION . . . . .	25
	BACKGROUND . . . . .	25
	PURPOSE. . . . .	27
	AUTHORITY. . . . .	27
	STUDY APPROACH . . . . .	27
IV	CATEGORY PROFILE . . . . .	29
	SAMPLING PROGRAM . . . . .	29
	QUESTIONNAIRE SURVEYS. . . . .	30
	1978 and 1979 Questionnaire Surveys. . . . .	30
	1983 Telephone Survey. . . . .	31
	1983 Questionnaire Survey. . . . .	36
	Summary of Questionnaire Data Base . . . . .	39
	LITERATURE REVIEW. . . . .	42
	INDUSTRY DESCRIPTION . . . . .	42
	PLASTICS MOLDING AND FORMING PROCESSES. . . . .	45
	Extrusion Processes. . . . .	45
	Molding Processes. . . . .	50
	Coating and Laminating Processes . . . . .	61
	Thermoforming Processes. . . . .	70
	Calendering Processes. . . . .	72
	Casting Processes. . . . .	74
	Foam Processes . . . . .	78
	Cleaning Processes . . . . .	79
	Finishing Processes. . . . .	79
V	SUBCATEGORIZATION. . . . .	81
	BASIS FOR SUBCATEGORIZATION SCHEME . . . . .	81
	FACTORS CONSIDERED . . . . .	81
	Raw Materials. . . . .	81
	Production Processes . . . . .	82
	Products Produced. . . . .	83
	Size and Age of Plants . . . . .	84
	Geographic Location. . . . .	85
	Types of Water Use . . . . .	85
	Wastewater Characteristics . . . . .	86

TABLE OF CONTENTS (Continued)

<u>Section</u>	<u>Page</u>
	SELECTED SUBCATEGORIZATION SCHEME. . . . . 86
	APPLICABILITY. . . . . 87
VI	WATER USE AND WASTEWATER CHARACTERISTICS . . . . . 91
	QUESTIONNAIRE DATA . . . . . 91
	PM&F Category Data . . . . . 96
	Estimate of Number of Plants and Processes in PM&F Category That Use Process Water . . . . . 99
	Estimate of PM&F Category Process Water Use. . . . . 100
	Estimate of PM&F Category Process Water Discharged . . . . . 102
	SAMPLING PROGRAMS. . . . . 102
	Plant Selection - Proposed Regulation. . . . . 108
	Field Sampling Programs - Proposed PM&F Regulation . . . . . 108
	Plant Selection - Final PM&F Regulation. . . . . 120
	Sample Collection, Preservation, and Transportation . . . . . 122
	Sample Analysis. . . . . 130
	Field Quality Assurance/Quality Control (QA/QC). 130
	Sampling Procedure Protocols . . . . . 136
	Laboratory Quality Assurance/Quality Control (QA/QC). . . . . 139
	PROCESS WATER POLLUTANT CONCENTRATIONS . . . . . 139
	Data Editing Rules . . . . . 139
	Pollutant Average Concentration Methodology. . . . . 153
	SAMPLED PLANTS WITH WASTEWATER TREATMENT SYSTEMS. . . . . 159
	SOLUTION CASTING/SOLVENT RECOVERY SAMPLING DATA . . . . . 159
	TOTAL PHENOLS VERIFICATION AT PLANT F. . . . . 160
VII	POLLUTANTS IN PLASTICS MOLDING AND FORMING PROCESS WATERS . . . . . 161
	CONVENTIONAL POLLUTANTS. . . . . 161
	NONCONVENTIONAL POLLUTANTS . . . . . 161

TABLE OF CONTENTS (Continued)

<u>Section</u>	<u>Page</u>
	PRIORITY TOXIC POLLUTANTS. . . . . 165
	List of Pollutants . . . . . 165
	Exclusion of Pollutants and Subcategories. . . . . 166
	POLLUTANTS CONSIDERED FOR REGULATION . . . . . 176
	Conventional Pollutants. . . . . 176
	Nonconventional Pollutants . . . . . 182
	Priority Toxic Pollutants. . . . . 183
	MASS OF POLLUTANTS . . . . . 209
VIII	WASTEWATER CONTROL AND TREATMENT TECHNOLOGIES. . . . . 221
	INTRODUCTION . . . . . 221
	IN-PLANT CONTROL TECHNOLOGY. . . . . 222
	Process Water Recycle. . . . . 222
	In-Process Measures. . . . . 224
	END-OF-PIPE TREATMENT TECHNOLOGY . . . . . 226
	Settling . . . . . 226
	pH Adjustment. . . . . 228
	Activated Sludge . . . . . 230
	Activated Carbon Adsorption. . . . . 236
	Filtration (Suspended Solids Removal). . . . . 240
	Vacuum Filtration (Sludge Dewatering). . . . . 243
IX	COSTS, ENERGY, AND NON-WATER QUALITY ASPECTS . . . . . 247
	INTRODUCTION . . . . . 247
	COST ESTIMATES FOR TREATMENT TECHNOLOGIES. . . . . 247
	Sources of Cost Data . . . . . 247
	Cost Components. . . . . 247
	Cost Update Factors. . . . . 249
	Cost Data Correlation. . . . . 249
	DESIGN DATA FOR TREATMENT TECHNOLOGIES . . . . . 250
	Flow Equalization. . . . . 250
	pH Adjustment. . . . . 253
	Settling . . . . . 254

TABLE OF CONTENTS (Continued)

<u>Section</u>	<u>Page</u>
Package Activated Sludge Plant . . . . .	255
Activated Carbon Adsorption. . . . .	257
Vacuum Filters . . . . .	261
Contract Haul. . . . .	263
PROCESS-BY-PROCESS COST ESTIMATES. . . . .	263
Plant-Specific Treatment Technologies. . . . .	264
Process Water Characteristics. . . . .	264
Cost Calculations. . . . .	265
Consideration of Existing Treatment. . . . .	265
COST ESTIMATION EXAMPLE. . . . .	265
ESTIMATION OF ENERGY AND NON-WATER QUALITY IMPACTS. . . . .	268
Energy . . . . .	268
Air Pollution. . . . .	270
Solid Waste. . . . .	270
Consumptive Water Loss . . . . .	275
X BEST PRACTICABLE CONTROL TECHNOLOGY CURRENTLY AVAILABLE. . . . .	277
BACKGROUND . . . . .	277
TECHNICAL APPROACH . . . . .	278
BPT Model Treatment Technologies . . . . .	281
BPT OPTIONS. . . . .	283
Contact Cooling and Heating Water Subcategory. . . . .	283
Cleaning Water Subcategory . . . . .	285
Finishing Water Subcategory. . . . .	289
REGULATED POLLUTANTS AND POLLUTANT PROPERTIES. . . . .	292
EFFLUENT CONCENTRATION VALUES. . . . .	292
BPT EFFLUENT LIMITATIONS GUIDELINES. . . . .	295
EXAMPLE OF THE APPLICATION OF THE BPT EFFLUENT LIMITATIONS GUIDELINES . . . . .	295
Example. . . . .	295

TABLE OF CONTENTS (Continued)

<u>Section</u>		<u>Page</u>
XI	BEST AVAILABLE TECHNOLOGY ECONOMICALLY ACHIEVABLE . . . . .	299
	INTRODUCTION . . . . .	299
	IDENTIFICATION OF THE BEST AVAILABLE TECH- NOLOGY ECONOMICALLY ACHIEVABLE . . . . .	299
	Contact Cooling and Heating Water Subcategory. .	299
	Cleaning Water Subcategory . . . . .	302
	Finishing Water Subcategory. . . . .	303
XII	NEW SOURCE PERFORMANCE STANDARDS . . . . .	307
	INTRODUCTION . . . . .	307
	TECHNICAL APPROACH TO NSPS . . . . .	307
	NSPS OPTION SELECTION. . . . .	307
	Contact Cooling and Heating Water Subcategory. .	308
	Cleaning Water Subcategory . . . . .	308
	Finishing Water Subcategory. . . . .	310
	COSTS AND POLLUTANT REMOVALS FOR NSPS. . . . .	312
	REGULATED POLLUTANTS AND POLLUTANT PROPERTIES. .	317
	NEW SOURCE PERFORMANCE STANDARDS . . . . .	317
	NON-WATER QUALITY IMPACTS. . . . .	318
XIII	PRETREATMENT STANDARDS . . . . .	321
	TECHNICAL APPROACH . . . . .	321
	PRETREATMENT STANDARDS FOR EXISTING SOURCES. . .	322
	Contact Cooling and Heating Water Subcategory. .	322
	Cleaning Water Subcategory . . . . .	322
	Finishing Water Subcategory. . . . .	323
	PRETREATMENT STANDARDS FOR NEW SOURCES . . . . .	323
	Contact Cooling and Heating Water Subcategory. .	323
	Cleaning Water Subcategory . . . . .	324
	Finishing Water Subcategory. . . . .	324
XIV	BEST CONVENTIONAL POLLUTANT CONTROL TECHNOLOGY .	327
XV	ACKNOWLEDGEMENTS . . . . .	329
XVI	REFERENCES . . . . .	333



TABLE OF CONTENTS (Continued)

<u>Section</u>		<u>Page</u>
XVII	GLOSSARY . . . . .	351
APPENDICES		
A	SAMPLING DATA. . . . .	A-1
B	STATE INDUSTRIAL GUIDES. . . . .	B-1
C	POLLUTANT REMOVALS . . . . .	C-1
D	POLLUTANT CONCENTRATIONS USED TO CALCULATE THE BEST PRACTICABLE TECHNOLOGY (BPT) EFFLUENT LIMITATIONS GUIDELINES. . . . .	D-1

## LIST OF TABLES

<u>Number</u>		<u>Page</u>
IV-1	RESULTS OF 1983 PLASTICS MOLDING AND FORMING TELEPHONE SURVEY FIRST PART. . . . .	32
IV-2	RESULTS OF 1983 PLASTICS MOLDING AND FORMING TELEPHONE SURVEY SECOND PART . . . . .	34
IV-3	DISTRIBUTION OF THE NUMBER OF PLASTICS MOLDING AND FORMING PROCESSES BY DISCHARGE MODE. . . . .	35
IV-4	DISTRIBUTION OF THE 330 DETAILED 1983 QUESTIONNAIRES . . . . .	38
IV-5	WATER-USING PROCESSES IN THE PM&F CATEGORY DISTRIBUTED BY DISCHARGE MODE. . . . .	41
IV-6	COMMONLY USED ADDITIVES IN POLYMER FORMULATION USING THE EXTRUSION PROCESS. . . . .	48
VI-1	DISCHARGE MODE FOR WET PROCESSES IN QUESTIONNAIRE DATA BASE. . . . .	92
VI-2	QUESTIONNAIRE DATA BASE INFORMATION. . . . .	93
VI-3	DISTRIBUTION OF NUMBER OF PROCESSES IN QUESTIONNAIRE DATA BASE WITH ZERO DISCHARGE. . . . .	94
VI-4	PM&F TREATMENT TECHNOLOGIES SUMMARY. . . . .	95
VI-5	DISCHARGE MODE FOR PROCESSES IN QUESTIONNAIRE DATA BASE THAT RECYCLE PROCESS WATER . . . . .	97
VI-6	DISTRIBUTION OF NUMBER OF PROCESSES IN THE CONTACT COOLING AND HEATING WATER SUBCATEGORY BY TYPE OF PROCESS AND DISCHARGE MODE. . . . .	98
VI-7	DISTRIBUTION OF THE NUMBER OF PM&F PROCESSES THAT USE PROCESS WATER BY TYPE OF PROCESS WATER AND DISCHARGE MODE . . . . .	101
VI-8	DISTRIBUTION OF PM&F WATER USE FOR INDIRECT DISCHARGERS. . . . .	103
VI-9	DISTRIBUTION OF PM&F WATER USE FOR DIRECT DISCHARGERS. . . . .	104

LIST OF TABLES (Continued)

<u>Number</u>		<u>Page</u>
VI-10	DISTRIBUTION OF PM&F WATER USE FOR ZERO DISCHARGERS. . . . .	105
VI-11	DISTRIBUTION OF PM&F PROCESS WATER DISCHARGED BY INDIRECT DISCHARGERS. . . . .	106
VI-12	DISTRIBUTION OF PM&F PROCESS WATER DISCHARGED BY DIRECT DISCHARGERS. . . . .	107
VI-13	1980 AND 1983 SAMPLED PROCESSES. . . . .	121
VI-14	1984 SAMPLED PROCESSES . . . . .	129
VI-15	POLLUTANTS FOR WHICH PM&F PROCESS WATER SAMPLES WERE ANALYZED. . . . .	131
VI-16	ANALYTICAL METHODS SUMMARY . . . . .	132
VI-17	DETECTION LIMITS FOR PRIORITY TOXIC POLLUTANTS .	134
VI-18	CONTAINER AND GLASSWARE PREPARATION PROCEDURES .	137
VI-19	SUMMARY OF SAMPLE DATA . . . . .	140
VI-20	DATA FOR POLLUTANT X - CALCULATION OF AVERAGE CONCENTRATION EXAMPLE. . . . .	155
VI-21	QUESTIONNAIRE DATA BASE WEIGHTING FACTORS FOR FLOW-WEIGHTED CONCENTRATION METHODOLOGY. . . . .	156
VII-1	CONVENTIONAL POLLUTANT AVERAGE CONCENTRATIONS - PM&F PROCESS WATERS. . . . .	162
VII-2	NONCONVENTIONAL POLLUTANTS FOR WHICH SAMPLES WERE ANALYZED. . . . .	163
VII-3	NONCONVENTIONAL POLLUTANT AVERAGE CONCENTRATIONS - CLEANING WATER SUBCATEGORY . . . . .	164
VII-4	PRIORITY POLLUTANTS EXCLUDED FROM CONTROL FOR THE PM&F CATEGORY. . . . .	169
VII-5	PRIORITY POLLUTANTS DETECTED IN PM&F PROCESS WATERS . . . . .	170

LIST OF TABLES (Continued)

<u>Number</u>		<u>Page</u>
VII-6	EXCLUSION METHODOLOGY EXAMPLE - POLLUTANT X. . .	171
VII-7	PRIORITY POLLUTANTS EXCLUDED FROM CONTROL. . .	172
VII-8	PRIORITY POLLUTANTS IN PM&F PROCESS WATERS . . .	174
VII-9	POLLUTANT TREATABILITY LIMITS. . . . .	177
VII-10	PRIORITY POLLUTANTS PRESENT IN TREATABLE CONCENTRATIONS . . . . .	179
VII-11	DATA FOR POLLUTANT X - MASS CALCULATION EXAMPLE. . . . .	210
VII-12	QUESTIONNAIRE SURVEY DATA USED TO ESTIMATE POLLUTANT MASSES . . . . .	211
VII-13	POLLUTANT MASSES . . . . .	215
VIII-1	DISTRIBUTION OF PM&F PROCESSES WITH RECYCLE. . .	225
VIII-2	POLLUTANTS AND POLLUTANT PROPERTIES FOUND IN TREATABLE CONCENTRATIONS IN PM&F PROCESS WATERS . . . . .	227
VIII-3	REMOVAL EFFICIENCIES FOR CONVENTIONAL AND SELECTED NONCONVENTIONAL POLLUTANTS IN A SETTLING TANK. . . . .	229
VIII-4	REMOVAL EFFICIENCIES FOR NONCONVENTIONAL POLLUTANTS AND PRIORITY POLLUTANTS FOR ACTIVATED SLUDGE PROCESSES . . . . .	237
IX-1	CAPITAL AND O&M COST EQUATIONS . . . . .	251
IX-2	ESTIMATED CAPITAL AND O&M COSTS FOR PLANT Y AT BPT . . . . .	269
IX-3	DESCRIPTION OF PM&F TREATMENT SYSTEM SOLID WASTE SAMPLES. . . . .	273
IX-4	EP TOXICITY TEST RESULTS FOR PM&F WASTEWATER TREATMENT SOLID WASTES . . . . .	274

LIST OF TABLES (Continued)

<u>Number</u>		<u>Page</u>
X-1	EFFLUENT CONCENTRATIONS USED TO CALCULATE THE FINAL BPT EFFLUENT LIMITATIONS GUIDELINES. . . .	294
X-2	ALLOWABLE DISCHARGE OF REGULATED POLLUTANTS FOR PLANT X. . . . .	297
XII-1	CHARACTERISTICS OF PM&F "NORMAL" PLANTS. . . . .	313
XII-2	POLLUTANT MASS IN PROCESS WATERS FOR NSPS "NORMAL" PLANT . . . . .	314
XII-3	ESTIMATED POLLUTANT REMOVALS FOR PM&F NSPS MODEL TREATMENT TECHNOLOGY . . . . .	315
XII-4	ESTIMATED COSTS OF NSPS MODEL TREATMENT TECHNOLOGY FOR PM&F "NORMAL" PLANTS. . . . .	316
XVII-1	THE GLASS TRANSITION AND MELTING TEMPERATURES OF SOME COMMON POLYMERS, AND THEIR MAIN USES . .	352

## LIST OF FIGURES

<u>Number</u>		<u>Page</u>
IV-1	EXTRUSION PROCESS . . . . .	47
IV-2	INJECTION MOLDING PROCESS . . . . .	51
IV-3	BLOW MOLDING PROCESS . . . . .	54
IV-4	COMPRESSION MOLDING PROCESS . . . . .	55
IV-5	TRANSFER MOLDING PROCESS . . . . .	57
IV-6	REACTION INJECTION MOLDING PROCESS . . . . .	59
IV-7	ROTATIONAL MOLDING PROCESS . . . . .	60
IV-8	EXPANDABLE BEAD FOAM MOLDING PROCESS . . . . .	62
IV-9	PLASTISOL AND POWDER COATING PROCESSES . . . . .	63
IV-10	SPREAD COATING PROCESS . . . . .	64
IV-11	EXTRUSION COATING PROCESS . . . . .	65
IV-12	LAMINATING PROCESS . . . . .	68
IV-13	CONTINUOUS LAMINATION PROCESS . . . . .	69
IV-14	THERMOFORMING PROCESS . . . . .	71
IV-15	CALENDERING PROCESS . . . . .	73
IV-16	CASTING PROCESSES . . . . .	75
IV-17	CHILLED FILM CASTING PROCESS . . . . .	76
VI-1	SAMPLING POINTS AT PLANT A . . . . .	109
VI-2	SAMPLING POINTS AT PLANT B . . . . .	110
VI-3	SAMPLING POINTS AT PLANT C . . . . .	111
VI-4	SAMPLING POINTS AT PLANT D . . . . .	112
VI-5	SAMPLING POINTS AT PLANT E . . . . .	113
VI-6	SAMPLING POINTS AT PLANT F . . . . .	114

LIST OF FIGURES (Continued)

<u>Number</u>		<u>Page</u>
VI-7	SAMPLING POINTS AT PLANT G . . . . .	115
VI-8	SAMPLING POINTS AT PLANT H . . . . .	116
VI-9	SAMPLING POINTS AT PLANT I . . . . .	117
VI-10	SAMPLING POINTS AT PLANT J . . . . .	118
VI-11	SAMPLING POINTS AT PLANT K . . . . .	119
VI-12	SAMPLING POINTS AT PLANT M . . . . .	123
VI-13	SAMPLING POINTS AT PLANT N . . . . .	124
VI-14	SAMPLING POINTS AT PLANT O . . . . .	125
VI-15	SAMPLING POINTS AT PLANT P . . . . .	126
VI-16	SAMPLING POINTS AT PLANT Q . . . . .	127
VI-17	SAMPLING POINTS AT PLANT R . . . . .	128
VIII-1	ACTIVATED SLUDGE TREATMENT PROCESS . . . . .	232
VIII-2	EXTENDED AERATION ACTIVATED SLUDGE PACKAGE PLANTS . . . . .	235
VIII-3	ACTIVATED CARBON ADSORPTION COLUMN . . . . .	239
VIII-4	FILTRATION TECHNOLOGIES. . . . .	241
VIII-5	VACUUM FILTER. . . . .	244
IX-1	COST ESTIMATE EXAMPLE MODEL TREATMENT TECHNOLOGIES FOR PLANT Y AT BPT. . . . .	267
X-1	AVERAGE PROCESS WATER USAGE FLOW RATE. . . . .	280
X-2	SCHEMATIC OF BPT OPTION 2 - CLEANING WATER SUBCATEGORY. . . . .	286
X-3	SCHEMATIC OF BPT OPTION 1 - FINISHING WATER SUBCATEGORY. . . . .	290

LIST OF FIGURES (Continued)

<u>Number</u>		<u>Page</u>
IX-1	BAT OPTION 1 CONTACT COOLING AND HEATING WATER SUBCATEGORY. . . . .	301
XI-2	BAT OPTION 1 FINISHING WATER SUBCATEGORY . . . .	305
XII-1	MODEL TREATMENT TECHNOLOGY FOR NSPS - CLEANING WATER SUBCATEGORY. . . . .	309
XII-2	MODEL TREATMENT TECHNOLOGY FOR NSPS - FINISHING WATER SUBCATEGORY. . . . .	311



## SECTION I

### SUMMARY AND CONCLUSIONS

#### INTRODUCTION

Pursuant to Sections 301, 304, 306, 307, 308, and 501 of the Clean Water Act and the Settlement Agreement in Natural Resources Defense Council v. Train 8 ERC 2120 (D.D.C. 1976), modified 12 ERC 1833 (D.D.C. 1979), modified by orders dated October 26, 1982, August 2, 1983; January 6, 1984; and July 5, 1984, the Environmental Protection Agency (EPA) collected and analyzed data for plants in the Plastics Molding and Forming Point Source category. (Throughout this document the Plastics Molding and Forming category is referred to as the "PM&F" category.) Proposed effluent limitations guidelines and standards for this category were published in the Federal Register on February 15, 1984 (49 FR 5862). This document and the administrative record provide the technical basis for the final effluent limitations guidelines for existing direct dischargers and standards of performance for new source direct dischargers for the PM&F category. This document also addresses EPA's consideration of pretreatment standards for new and existing indirect dischargers in the PM&F category.

In the PM&F category, there are an estimated 10,260 plants of which 1,898 use process water (i.e., water that contacts the plastic material during processing). These plants have approximately 2,587 processes that use process water. Of these processes, 810 discharge water directly to rivers and streams; 1,145 discharge to publicly owned treatment works; and 632 do not discharge process water. The other 8,362 plants in the PM&F category do not use process water (i.e., they are dry).

To collect information regarding plant size, age and production, the production processes used, and the quantity, treatment, and disposal of process water generated, EPA conducted three questionnaire surveys and a two-part telephone survey. As a result of these surveys, 382 plants were included in a data base from which were derived technical, statistical, and economic information to evaluate the PM&F category. In addition, EPA sampled PM&F processes at 18 plants: four plants were sampled in 1980; seven plants were sampled in 1983; and seven plants were sampled in 1984. Samples collected were analyzed for conventional, selected nonconventional, and priority toxic pollutants to identify and quantify pollutants present in PM&F process waters.

The Agency examined data obtained from the questionnaire surveys and the wastewater sampling programs to characterize the PM&F

category. The category is comprised of plants that employ generic processes that blend, mold, form, or otherwise process plastic materials. These processes are:

1. extrusion,
2. molding,
3. coating and laminating,
4. thermoforming,
5. calendering,
6. casting,
7. foaming,
8. cleaning, and
9. finishing.

Results of the sampling programs indicate that process water is generally used to cool or heat plastic products, to clean both the surfaces of the plastic products and the surfaces of shaping equipment that contact plastic products, or to finish plastic products. Waters used in contact cooling and heating processes, in cleaning processes, and in finishing processes have different pollutant characteristics. For this reason, the PM&F category was divided into three subcategories:

1. contact cooling and heating water subcategory;
2. cleaning water subcategory; and
3. finishing water subcategory.

The contact cooling and heating water subcategory includes those processes where process water contacts raw materials or plastic products for the purpose of heat transfer during plastics molding and forming.

The cleaning water subcategory includes those processes that use process water to clean the surface of plastic products or to clean shaping equipment surfaces that are or have been in contact with the formed plastic product. Process water used to clean the plastic product or shaping equipment includes water used in the detergent wash cycle and water used in the rinse cycle to remove detergents and other foreign matter.

The finishing water subcategory includes those processes that use process water to finish the plastic product. Finishing water consists of water used to carry away waste plastic material or to lubricate the product during the finishing operation.

Only process water that contacts the plastic material, plastic product, or surfaces of shaping equipment used to mold or form plastic materials is covered by this final regulation. Non-contact cooling water is not process water and thus is not

controlled. Permit writers and control authorities will establish limitations for the discharge of non-contact cooling water and other non-process wastewater on a case-by-case basis.

Plants in the PM&F category may have processes that use only one type of water and thus fit within one subcategory. However, many plants have contact cooling and heating water, cleaning water, and finishing water processes. In this instance, plants must comply with the effluent limitations guidelines and standards for each subcategory.

EPA studied the PM&F category to characterize the pollutants in the different types of process water. The conventional and non-conventional pollutants or pollutant properties present in treatable concentrations are: (1) conventional pollutants - biochemical oxygen demand (BOD<sub>5</sub>), oil and grease (O&G), total suspended solids (TSS), and pH, (2) nonconventional pollutants - total organic carbon, chemical oxygen demand, and total phenols. The priority toxic pollutants found in treatable concentrations in PM&F process waters are: (1) contact cooling and heating water - bis(2-ethylhexyl) phthalate, (2) cleaning water - phenol and zinc, and (3) finishing water - bis(2-ethylhexyl) phthalate, di-n-butyl phthalate, and dimethyl phthalate.

The control and treatment technologies available for this category include various end-of-pipe technologies. These technologies were considered appropriate for the treatment of plastics molding and forming process waters and formed the basis for the model treatment technologies for the final PM&F regulation.

End-of-pipe technologies considered appropriate for PM&F process waters include equalization, pH adjustment, settling, the activated sludge process, the activated carbon process and filtration. Using these technologies, the Agency developed several treatment options. After consideration of these options, the Agency selected model treatment technologies as the basis for this regulation.

Equalization. Equalization involves mixing or holding of wastewater to provide an influent to a treatment process with both a relatively constant flow rate and composition.

pH Adjustment. Acidic and basic materials are used to control the pH of the wastewater. Proper pH adjustment not only controls a pollutant property but also serves to ensure proper treatment technology performance.

Settling. Settling is a process that removes solid particles from a liquid matrix by gravitational force. This is done by reducing the velocity of the flow in a large volume tank so that

gravitational settling can occur. Floatable materials such as oils can also be removed in this process by skimming them from the surface of the water in the tank.

Biological Treatment (Activated Sludge). The activated sludge process is a widely used biological treatment process characterized by a suspension of microorganisms maintained in a homogeneous state by mixing and turbulence induced by aeration. The microorganisms oxidize soluble and colloidal organic material to carbon dioxide and water in the presence of molecular oxygen. This process treats dissolved pollutants such as BOD<sub>5</sub>, total organic carbon, and total phenols. The activated sludge process, which is designed to ensure optimal removal of BOD<sub>5</sub>, also may remove organic priority pollutants in the wastewater.

Activated sludge technology can be used with settling technologies to make a package activated sludge plant. These are self-contained plants that usually consist of a primary settling unit, an activated sludge unit, and a final settling unit. Package activated sludge plants can be used to treat flows from as low as 600 gallons per day to as high as 100,000 gallons per day.

Activated Carbon. The activated carbon process is used to remove dissolved organic contaminants from wastewater. The activated carbon removes pollutants from water by the process of adsorption, the attraction and accumulation of one substance on the surface of another. Organic compounds are preferentially adsorbed onto activated carbon; this selectivity results in a particularly effective method for the removal of soluble organic compounds from aqueous solutions.

Filtration. Filtration processes are used to remove suspended solids from process waters. Filtration processes include a wide range of technologies including screens, granular media filters, belt filters, and membrane filters. The primary difference between the various types of filters is the degree of permeability of the barrier, ranging from the coarseness of a wire screen to the selectivity of ultrafiltration membranes.

#### TYPE OF EFFLUENT LIMITATIONS GUIDELINES AND STANDARDS

The effluent limitations guidelines and standards in the final PM&F regulation are mass-based. They are calculated using the following equation:

$$\text{Effluent Mass} = (\text{Concentration}) (\text{Average Process Water Usage Flow Rate})$$

The pollutant concentrations, which are based on the performance of the selected model treatment technology, are promulgated in

the final rule and presented in this document. The average process water usage flow rate is the process water, including recycle, that flows through a process and contacts the plastic product. A permit writer uses the concentration values promulgated in this rule and the average process water usage flow rate, which is obtained from the permittee, to calculate the effluent pollutant mass that can be discharged.

If a plant has more than one PM&F process in the same subcategory, the average process water usage flow rate for those processes is the sum of the average process water usage flow rate for each process. This sum is used to calculate the pollutant mass for the PM&F processes at a plant in the same subcategory.

#### CONTACT COOLING AND HEATING WATER SUBCATEGORY

##### Best Practicable Technology Currently Available (BPT) Effluent Limitations Guidelines

The BPT effluent limitations guidelines for this subcategory are based on the application of good housekeeping practices. During plant visits and various sampling episodes, EPA found that good housekeeping practices are commonly employed with processes in this subcategory. Raw materials and lubricating oils are routinely segregated from the cooling and heating water, which keeps pollutants not generated during the PM&F operation out of the cooling and heating water. The final BPT effluent limitations guidelines ensure continuation of those practices because they are based on a statistical evaluation of the pollutant concentrations currently discharged by processes at plants employing good housekeeping techniques. This approach was selected at BPT because no conventional or nonconventional pollutants were found in treatable concentrations in contact cooling and heating waters.

Implementation of the final BPT effluent limitations guidelines for this subcategory will result in only minimal removals of conventional, nonconventional, and priority toxic pollutants.

##### Best Available Technology Economically Achievable (BAT) Effluent Limitations Guidelines

Except for bis(2-ethylhexyl) phthalate, there are no toxic pollutants present in treatable concentrations in the process water discharged by contact cooling and heating water processes. Therefore, except for bis(2-ethylhexyl) phthalate, the BAT effluent limitations guidelines are the same as the BPT effluent limitations guidelines for this subcategory.

The toxic pollutant bis(2-ethylhexyl) phthalate was found in treatable concentrations (ranging from 0.011 mg/l to 1.72 mg/l) in 52.6 percent of the contact cooling and heating water samples collected and analyzed. However, none of the technologies considered during the development of the proposed rule for this subcategory can be used to control this pollutant. Accordingly, EPA is reserving the BAT effluent limitations guidelines for bis(2-ethylhexyl) phthalate pending further study. The Agency has identified one technology (i.e., the activated carbon process) that it believes will effectively control bis(2-ethylhexyl) phthalate, but at this time does not have treatability data for phthalates for that treatment process. EPA plans to study the treatment of phthalates by the activated carbon process and, after reviewing the results of that study, to propose and promulgate BAT effluent limitations guidelines for bis(2-ethylhexyl) phthalate.

Because the BAT effluent limitations guidelines for all pollutants except bis(2-ethylhexyl) phthalate are the same as the BPT effluent limitations guidelines for those pollutants, there are no additional pollutant removals achieved by implementation of the final BAT effluent limitations guidelines.

#### Best Conventional Pollutant Control Technology (BCT) Effluent Limitations Guidelines

The Agency was unable to identify a technology that further reduces the concentrations of conventional pollutants found in contact cooling and heating waters. For this reason, BCT is equal to BPT for this subcategory and the BCT effluent limitations guidelines are the same as the BPT effluent limitations guidelines. Because there are no technologies available to reduce conventional pollutants in this subcategory, EPA has no reason to await promulgation of the final BCT methodology before promulgating BCT effluent limitations guidelines for this subcategory.

#### New Source Performance Standards (NSPS)

Except for bis(2-ethylhexyl) phthalate, the Agency is promulgating NSPS for this subcategory equal to the BPT effluent limitations guidelines. The NSPS control BOD<sub>5</sub>, O&G, TSS, and pH.

NSPS are being promulgated equal to the BPT effluent limitations guidelines because the Agency believes that the characteristics of process waters generated by new sources will be substantially the same as the characteristics of PM&F process waters generated by existing sources. Accordingly, the Agency considered the same technologies as the basis for NSPS that were considered for BPT/BAT. EPA was unable to identify additional technologies that

are capable of reducing the concentrations of pollutants found in process water discharges from contact cooling and heating water processes at new sources.

The Agency believes that the concentrations of bis(2-ethylhexyl) phthalate in contact cooling and heating water discharged by new sources will be similar to the concentrations of that pollutant discharged by existing sources. As discussed earlier, the Agency found treatable concentrations of bis(2-ethylhexyl) phthalate in 52.6 percent of the contact cooling and heating water samples collected and analyzed. Because no previously-studied technologies effectively control this pollutant, NSPS for bis(2-ethylhexyl) phthalate are reserved pending completion of the phthalate treatability study discussed above.

NSPS were derived based on a statistical evaluation of the conventional pollutant concentrations in process waters discharged by existing contact cooling and heating water processes. They ensure that the same good housekeeping practices employed at existing sources will be employed at new sources.

The Agency anticipates that 14 kilograms per year of the toxic pollutants found in treatable concentrations in contact cooling and heating waters will be discharged from a "normal" new source plant for this subcategory. Implementation of NSPS is expected to result in minimal pollutant removals.

EPA has defined a "normal" new source plant for this subcategory as a plant that only contains a contact cooling and heating water process. The average process water usage flow rate for the contact cooling and heating water process at this "normal" plant is 35 gpm and the pollutant concentrations in the process water discharged from that process are assumed to be equal to the average pollutant concentrations for this subcategory.

#### Pretreatment Standards for Existing Sources (PSES)

The Agency is not promulgating PSES at this time for any pollutant; PSES for bis(2-ethylhexyl) phthalate are being reserved. EPA has determined that the average percentage of toxic pollutant removals nation-wide by well-operated POTWs meeting secondary treatment requirements (ranging from 35 to 99 percent) is greater than the percentage of toxic pollutant removals achieved by BAT (i.e., zero percent removals). Therefore, the toxic pollutants do not pass through a POTW. Even though categorical pretreatment standards are not being promulgated, indirect dischargers in this subcategory must comply with the General Pretreatment Regulations - 40 CFR Part 403.

PSES for bis(2-ethylhexyl) phthalate are reserved pending proposal and promulgation of the BAT effluent limitations guidelines for bis(2-ethylhexyl) phthalate. When BAT is selected, EPA will determine if that pollutant passes through a POTW.

#### Pretreatment Standards for New Sources (PSNS)

The Agency is not promulgating PSNS at this time for any pollutant; PSNS for bis(2-ethylhexyl) phthalate are being reserved. The Agency believes that new and existing indirect discharge sources will discharge the same pollutants in similar amounts. As discussed in the preceding subsection, the average percentage of toxic pollutants removed nation-wide by well-operated POTWs meeting secondary treatment requirements (ranging from 35 to 99 percent) is greater than the average percent removal achieved by BAT/NSPS for this subcategory (i.e., zero percent removal). Therefore, the toxic pollutants do not pass through a POTW. Even though the Agency is not promulgating categorical pretreatment standards, indirect dischargers at new sources in this subcategory must comply with the General Pretreatment Regulations - 40 CFR Part 403.

The Agency believes that the concentrations of bis(2-ethylhexyl) phthalate in contact cooling and heating water discharged from new indirect sources will be similar to the concentrations of that pollutant discharged from existing indirect sources. For this reason, the Agency is reserving PSNS for bis(2-ethylhexyl) phthalate until completion of the phthalate treatability study. When the technology basis for NSPS for that pollutant is selected, EPA will determine if bis(2-ethylhexyl) phthalate passes through a POTW.

#### CLEANING WATER SUBCATEGORY

##### Best Practicable Technology Currently Available (BPT) Effluent Limitations Guidelines

The Agency is promulgating BPT effluent limitations guidelines for this subcategory based on the performance of a package activated sludge plant with equalization and pH adjustment. The final BPT effluent limitations guidelines control BOD<sub>5</sub>, O&G, TSS, and pH. The activated sludge process removes the toxic pollutants found in treatable concentrations in cleaning water. This technology and the effluent values for this technology were transferred from the organic chemicals, plastics, and synthetic fibers (OCPSF) point source category.

Implementation of the BPT effluent limitations guidelines for this subcategory is expected to result in an annual removal of 217,500 kilograms of conventional pollutants, 136,700 kilograms



of nonconventional pollutants, and 155 kilograms of treatable priority toxic pollutants. EPA believes that the toxic pollutants in cleaning water are effectively controlled when the effluent limitations guidelines for the conventional pollutants are met.

#### Best Available Technology Economically Achievable (BAT) Effluent Limitations Guidelines

The Agency is not promulgating BAT effluent limitations guidelines more stringent than the BPT effluent limitations guidelines for this subcategory because there are insignificant quantities of toxic pollutants remaining in cleaning water after compliance with the applicable BPT effluent limitations guidelines. The Agency believes that the amount and toxicity of these pollutants do not justify establishing more stringent BAT effluent limitations guidelines for the toxic pollutants. Therefore, the BAT effluent limitations guidelines for this subcategory are the same as the BPT effluent limitations guidelines. No additional toxic pollutant removals are achieved by the BAT effluent limitations guidelines for this subcategory.

#### Best Conventional Pollutant Control Technology (BCT) Effluent Limitations Guidelines

The Agency has identified at least one technology (i.e., filtration) that can reduce the concentration of conventional pollutants remaining after the application of BPT for this subcategory. Accordingly, EPA is reserving promulgation of BCT effluent limitations guidelines for this subcategory pending promulgation of the final BCT methodology. Once that methodology is promulgated, EPA will use it to determine if additional controls for conventional pollutants are justified for this subcategory.

#### New Source Performance Standards (NSPS)

The Agency believes that characteristics of process waters discharged by new sources in the cleaning water subcategory will be the same as the characteristics of process waters discharged by existing sources in this subcategory. Thus, the technology option selected for new sources is the same as the technology option selected for existing sources in this final rule.

The Agency is promulgating NSPS based on the same model treatment technologies used as the basis for the promulgated BPT/BAT effluent limitations guidelines (package activated sludge plant with equalization and pH adjustment). Although the Agency also considered filtration as a model treatment technology following the package activated sludge plant, filtration was not included in the technology basis at this time for the reasons presented in

Section XII of this document. However, if the Agency finds that application of filtration is justified based on the final BCT cost test methodology, EPA may revise the technology basis for NSPS for this subcategory to include filtration as a polishing step. At this time, the Agency is not promulgating NSPS more stringent than the effluent limitations guidelines for existing sources because the amount and toxicity of the toxic pollutants remaining after treatment in the BPT/BAT treatment technologies for this subcategory do not justify more stringent controls.

Pollutants and pollutant properties controlled by NSPS include biochemical oxygen demand, oil and grease, total suspended solids, and pH. The Agency believes that the toxic pollutants in cleaning waters are effectively controlled when the NSPS for the above pollutants are met.

The Agency anticipates that 2,290 kilograms per year of conventional pollutants, 2,079 kilograms of nonconventional pollutants, and 2.3 kilograms of priority toxic pollutants will be discharged by a "normal" new source plant for this subcategory. Implementation of NSPS is expected to result in removal of 2,100 kilograms per year of conventional pollutants, 1,300 kilograms of nonconventional pollutants, and 1.5 kilograms of priority toxic pollutants.

A "normal" plant for the cleaning water subcategory is a model plant that has one cleaning process whose production, wastewater characteristics, and financial profile are typical of existing plants with cleaning processes. The process flow rate for the cleaning process in this "normal" plant is 13.5 gpm.

#### Pretreatment Standards for Existing Sources (PSES)

EPA is not promulgating PSES for the cleaning water subcategory because the priority toxic pollutants (i.e., phenol and zinc) found in cleaning waters in treatable concentrations do not pass through a POTW. The Agency compared the percent removal of phenol and zinc (i.e., 75 percent and 65 percent, respectively) achieved by application of BAT to the average percentage removal of those pollutants nation-wide by well-operated POTWs meeting secondary treatment requirements (99 percent for phenol and 77 percent for zinc). Because the percent removals in a POTW are greater than the BAT percent removals, phenol and zinc do not pass through a POTW. Therefore, pretreatment standards are not established for phenol and zinc.

Even though no categorical pretreatment standards are being promulgated for existing sources for this subcategory, indirect dischargers must comply with the General Pretreatment Regulations - 40 CFR Part 403.

## Pretreatment Standards for New Sources (PSNS)

The Agency is not promulgating PSNS for this subcategory. The Agency believes that new and existing indirect discharge sources will discharge the same pollutants in similar amounts. As discussed in the preceding subsection, the average toxic pollutant percentage removal by well-operated POTWs meeting secondary treatment requirements is greater than the percentage of toxic pollutants removed by the model treatment technology for the BAT effluent limitations guidelines, which is the technology basis for NSPS. Therefore, the toxic pollutants do not pass through a POTW.

Even though new indirect dischargers are not subject to categorical pretreatment standards, they must comply with the General Pretreatment Regulations - 40 CFR Part 403.

## FINISHING WATER SUBCATEGORY

### Best Practicable Technology Currently Available (BPT) Effluent Limitations Guidelines

The Agency is promulgating BPT effluent limitations guidelines for this subcategory based on the performance of a settling unit. The BPT effluent limitations guidelines control TSS and pH.

The Agency estimates that the BPT effluent limitations guidelines for this subcategory will result in a removal of 2,520 kilograms per year of conventional pollutants from finishing process waters.

### Best Available Technology Economically Achievable (BAT) Effluent Limitations Guidelines

Except for three phthalates, EPA is promulgating BAT equal to BPT for this subcategory. The BAT effluent limitations guidelines are the same as the BPT effluent limitations guidelines. There are no additional pollutant removals achieved by implementation of the BAT effluent limitations guidelines for this subcategory.

EPA was only able to identify one technology (i.e., the activated carbon process) for the removal of the three phthalates found in treatable concentrations in finishing waters. However, the Agency does not have treatability data for phthalates for the activated carbon process. The Agency plans to study the treatment of phthalates by the activated carbon process. After reviewing the results of that study, EPA plans to propose and to promulgate BAT effluent limitations guidelines for the three phthalates in finishing water. For this reason, the BAT effluent limitations guidelines for this subcategory for bis(2-ethylhexyl)

phthalate, di-n-butyl phthalate, and dimethyl phthalate are reserved.

#### Best Conventional Pollutant Control Technology (BCT) Effluent Limitations Guidelines

EPA was able to identify at least one technology (i.e., filtration) that could reduce the concentration of TSS in finishing waters after the application of BPT. Accordingly, BCT effluent limitations guidelines for this subcategory are reserved pending promulgation of the final BCT methodology. That methodology will be used to determine if additional controls for conventional pollutants are justified for this subcategory.

#### New Source Performance Standards (NSPS)

The Agency believes that characteristics of process waters discharged from finishing processes at new sources will be the same as the characteristics of process waters discharged by those processes at existing sources. Thus, the technology option selected for new sources is the same as the one selected for existing sources.

The Agency is promulgating NSPS based on the same model treatment technology used as the basis for the BPT effluent limitations guidelines (i.e., settling). Although the Agency also considered filtration as a model treatment technology following settling, filtration was not included in the technology basis for NSPS at this time for the reasons presented in Section XII of this document. However, if the Agency finds that application of filtration is justified based on the final BCT cost test methodology, EPA may revise the technology basis for NSPS for this subcategory to include filtration as a polishing step. At this time, the Agency is not establishing NSPS more stringent than the effluent limitations guidelines for existing sources because, except for three phthalates, there are no toxic pollutants found in finishing waters in treatable concentrations. The Agency believes that the concentrations of the three phthalates in finishing waters discharged by new sources will be similar to the concentrations of those phthalates found in finishing waters discharged by existing sources. For this reason, the Agency is reserving NSPS for bis(2-ethylhexyl) phthalate, di-n-butyl phthalate, and dimethyl phthalate for this subcategory.

Pollutants and pollutant properties controlled by new sources include TSS and pH. NSPS for this subcategory are the same as the BPT effluent limitations guidelines.

The Agency anticipates that 363 kilograms per year of conventional pollutants will be discharged by a "normal" new source

plant for this subcategory. Implementation of NSPS is expected to result in the removal of 252 kilograms per year of conventional pollutants.

EPA has defined a "normal" new source plant for this subcategory as a plant that only contains a finishing water process. The average process water usage flow rate for the finishing water process at this "normal" plant is 3.15 gpm and the pollutant concentrations in the process water discharged from that process are assumed to be equal to the average pollutant concentrations for this subcategory.

#### Pretreatment Standards for Existing Sources (PSES)

The Agency is not promulgating PSES for this subcategory at this time for any pollutant; PSES for bis(2-ethylhexyl) phthalate, di-n-butyl phthalate, and dimethyl phthalate are reserved. EPA has determined that the average percentage of the toxic pollutants removed nation-wide by well-operated POTWs meeting secondary treatment requirements (ranging from 35 to 99 percent) is greater than the average percent removal achieved by application of BAT (i.e., zero percent removal). Therefore, the toxic pollutants do not pass through a POTW. Even though the Agency is not promulgating categorical pretreatment standards, indirect dischargers at existing sources in this subcategory must comply with the General Pretreatment Regulations - 40 CFR Part 403.

PSES for bis(2-ethylhexyl) phthalate, di-n-butyl phthalate, and dimethyl phthalate are reserved pending promulgation of the BAT effluent limitations guidelines for those pollutants. When BAT is established, EPA will determine if those three phthalates pass through a POTW.

#### Pretreatment Standards for New Sources (PSNS)

The Agency is not promulgating PSNS for this subcategory at this time for any pollutant; PSNS for bis(2-ethylhexyl) phthalate, di-n-butyl phthalate, and dimethyl phthalate are reserved. The Agency believes that new and existing indirect discharge sources will discharge the same pollutants in similar amounts. As discussed in the preceding subsection, EPA has determined that the average percentage of toxic pollutants removed nation-wide by well-operated POTWs meeting secondary treatment requirements is greater than the average percent of toxic pollutants removed by the model treatment technology for BAT, which is the technology basis for NSPS. Therefore, the toxic pollutants do not pass through a POTW. Even though the Agency is not promulgating categorical pretreatment standards, indirect discharges at new sources in this subcategory must comply with the General Pretreatment Regulations - 40 CFR Part 403.

The Agency believes that the concentrations of the three phthalates in finishing waters discharged from new sources will be similar to the concentrations of those pollutants discharged from existing indirect sources. For this reason, the Agency is reserving PSNS for bis(2-ethylhexyl) phthalate, di-n-butyl phthalate, and dimethyl phthalate until completion of the phthalate treatability study. When the technology basis for the NSPS for those pollutants is established, EPA will determine if PSNS for the three phthalates are warranted.

SECTION II

RECOMMENDATIONS

1. EPA has divided the plastics molding and forming category into three subcategories for the purpose of final effluent limitations guidelines and standards. They are:
  - contact cooling and heating water subcategory;
  - cleaning water subcategory; and
  - finishing water subcategory.
2. Best Practicable Technology Currently Available (BPT) effluent limitations guidelines for the contact cooling and heating water subcategory are based on a statistical evaluation of the pollutant concentrations in contact cooling and heating waters. For the cleaning water subcategory and the finishing water subcategory, the BPT effluent limitations guidelines are based on the performance of a package activated sludge plant with pH adjustment and a settling unit with pH adjustment, respectively.

A. BPT EFFLUENT LIMITATIONS GUIDELINES FOR THE CONTACT COOLING AND HEATING WATER SUBCATEGORY

The mass of the pollutants listed below that can be discharged is calculated by multiplying the average process water usage flow rate for the contact cooling and heating water processes at a point source times the following pollutant concentrations:

---

Contact Cooling and Heating Water

---

Concentration used to calculate BPT effluent limitations

---

Pollutant or Pollutant Property	Maximum for any 1 day (mg/l)
BOD <sub>5</sub>	26
Oil & Grease	29
TSS	19
pH	(1)

---

<sup>1</sup>Within the range of 6.0 to 9.0 at all times.

The permit authority will obtain the average process water usage flow rate for the contact cooling and heating water processes from the permittee.

**B. BPT EFFLUENT LIMITATIONS GUIDELINES FOR THE CLEANING WATER SUBCATEGORY**

The mass of the pollutants listed below that can be discharged is calculated by multiplying the average process water usage flow rate for the cleaning water processes at a point source times the following pollutant concentrations:

---

Cleaning Water

---

Concentration used to calculate BPT effluent limitations

---

Pollutant or Pollutant Property	Maximum for any 1 day (mg/l)	Maximum for monthly average (mg/l)
BOD <sub>5</sub>	49	22
Oil & Grease	71	17
TSS	117	36
pH	(1)	(1)

---

<sup>1</sup>Within the range of 6.0 to 9.0 at all times.

The permit authority will obtain the average process water usage flow rate for the cleaning water processes from the permittee.

**C. BPT EFFLUENT LIMITATIONS GUIDELINES FOR THE FINISHING WATER SUBCATEGORY**

The mass of the pollutants listed below that can be discharged is calculated by multiplying the average process water usage flow rate for the finishing water processes at a point source times the following pollutant concentrations:



---

Finishing Water

---

Concentration used to calculate BPT effluent limitations

---

Pollutant or Pollutant Property	Maximum for any 1 day (mg/l)	Maximum for monthly average (mg/l)
TSS	130	37
pH	(1)	(1)

---

<sup>1</sup>Within the range of 6.0 to 9.0 at all times.

The permit authority will obtain the average process water usage flow rate for the finishing water processes from the permittee.

3. Except for one phthalate in contact cooling and heating waters and three phthalates in finishing waters, best available technology economically achievable (BAT) equals BPT for each subcategory. The BAT effluent limitations guidelines are the same as the BPT effluent limitations guidelines for each subcategory. The BAT effluent limitations guidelines for phthalates in two subcategories are reserved pending further study.

A. BAT EFFLUENT LIMITATIONS GUIDELINES FOR THE CONTACT COOLING AND HEATING WATER SUBCATEGORY

- (1) The BAT effluent limitations guidelines for bis(2-ethylhexyl) phthalate are reserved.
- (2) The Agency has determined that, with the exception of bis(2-ethylhexyl) phthalate, there are no toxic pollutants in treatable concentrations in contact cooling and heating waters. Accordingly, the Agency is promulgating BAT effluent limitations guidelines equal to the BPT effluent limitations guidelines.

B. BAT EFFLUENT LIMITATIONS GUIDELINES FOR THE CLEANING WATER SUBCATEGORY

The Agency has determined that there are insignificant quantities of toxic pollutants in cleaning process waters after application of BPT. Accordingly, because the BPT level of treatment provides adequate control, the Agency is establishing BAT effluent limitations guidelines equal to the BPT effluent limitations guidelines.

C. BAT EFFLUENT LIMITATIONS GUIDELINES FOR THE FINISHING WATER SUBCATEGORY

- (1) The BAT effluent limitations guidelines for bis(2-ethylhexyl) phthalate, di-n-butyl phthalate, and dimethyl phthalate are reserved.
  - (2) The Agency has determined that, with the exception of bis(2-ethylhexyl) phthalate, di-n-butyl phthalate, and dimethyl phthalate, there are no toxic pollutants in treatable concentrations in finishing waters. Accordingly, the Agency is promulgating BAT effluent limitations guidelines equal to the BPT effluent limitations guidelines for this subcategory.
4. EPA could not identify a technology that would reduce the concentrations of conventional pollutants in contact cooling and heating waters. Therefore, the Agency has no reason to await promulgation of the final BCT methodology before promulgating BCT effluent limitations guidelines for the contact cooling and heating water subcategory. The BCT effluent limitations guidelines for that subcategory are the same as the BPT effluent limitations guidelines.

The Agency identified at least one technology, filtration, that could reduce the concentrations of conventional pollutants in cleaning waters and in finishing waters after application of BPT. Accordingly, BCT effluent limitations guidelines are not being promulgated for those subcategories until the final BCT methodology is promulgated.

A. BCT EFFLUENT LIMITATIONS GUIDELINES FOR THE CONTACT COOLING AND HEATING WATER SUBCATEGORY

The mass of the pollutants listed below that can be discharged is calculated by multiplying the average process water usage flow rate for the contact cooling and heating water processes at a point source times the following pollutant concentrations:

---

Contact Cooling and Heating Water

---

Concentration used to calculate BCT effluent limitations

---

Pollutant or Pollutant Property	Maximum for any 1 day (mg/l)
BOD <sub>5</sub>	26
Oil & Grease	29
TSS	19
pH	(1)

---

<sup>1</sup>Within the range of 6.0 to 9.0 at all times.

The permit authority will obtain the average process water usage flow rate for the contact cooling and heating water processes from the permittee.

B. BCT EFFLUENT LIMITATIONS GUIDELINES FOR THE CLEANING WATER SUBCATEGORY

[Reserved]

C. BCT EFFLUENT LIMITATIONS GUIDELINES FOR THE FINISHING WATER SUBCATEGORY

[Reserved]

5. Except for one phthalate in contact cooling and heating waters and three phthalates in finishing waters, new source performance standards (NSPS) are the same as the BAT effluent limitations guidelines for each subcategory. NSPS for the phthalates in two subcategories are reserved pending further study.

A. NEW SOURCE PERFORMANCE STANDARDS FOR THE CONTACT COOLING AND HEATING WATER SUBCATEGORY

- (1) NSPS for bis(2-ethylhexyl) phthalate are reserved.
- (2) The mass of the pollutants listed below that can be discharged is calculated by multiplying the average process water usage flow rate for the contact cooling and heating water processes at a new source times the following pollutant concentrations:

---

Contact Cooling and Heating Water

---

Concentration used to calculate NSPS

---

Pollutant or Pollutant Property	Maximum for any 1 day (mg/l)
BOD <sub>5</sub>	26
Oil & Grease	29
TSS	19
pH	(1)

---

<sup>1</sup>Within the range of 6.0 to 9.0 at all times.

The permit authority will obtain the average process water usage flow rate for the new source contact cooling and heating water processes from the permittee.

B. NEW SOURCE PERFORMANCE STANDARDS FOR THE CLEANING WATER SUBCATEGORY

The mass of the pollutants listed below that can be discharged is calculated by multiplying the average process water usage flow rate for cleaning processes at a new source times the following pollutant concentrations:

---

Cleaning Water

---

Concentration used to calculate NSPS

---

Pollutant or Pollutant Property	Maximum for any 1 day (mg/l)	Maximum for monthly average (mg/l)
BOD <sub>5</sub>	49	22
Oil & Grease	71	17
TSS	117	36
pH	(1)	(1)

---

<sup>1</sup>Within the range of 6.0 to 9.0 at all times.

The permit authority will obtain the average process water usage flow rate for the contact cooling and heating water processes from the permittee.

C. NEW SOURCE PERFORMANCE STANDARDS FOR THE FINISHING WATER SUBCATEGORY

- (1) NSPS for bis(2-ethylhexyl) phthalate, di-n-butyl phthalate, and dimethyl phthalate are reserved.
- (2) The mass of the pollutants listed below that can be discharged is calculated by multiplying the average process water usage flow rate for the finishing water processes at a new source times the following pollutant concentrations:

---

Finishing Water

---

Concentration used to calculate NSPS

---

Pollutant or Pollutant Property	Maximum for any 1 day (mg/l)	Maximum for monthly average (mg/l)
TSS	130	37
pH	(1)	(1)

---

<sup>1</sup>Within the range of 6.0 to 9.0 at all times.

The permit authority will obtain the average process water usage flow rate for the new source finishing water processes from the permittee.

6. Except for one phthalate in contact cooling and heating waters and three phthalates in finishing waters, the Agency is not promulgating pretreatment standards for existing sources for the PM&F category because the Agency has determined that toxic pollutants found in PM&F process waters do not pass through a well-operated secondary POTW. The PSES for the phthalates in two subcategories are reserved pending further study.

A. PRETREATMENT STANDARDS FOR EXISTING SOURCES FOR THE CONTACT COOLING AND HEATING WATER SUBCATEGORY

- (1) PSES for bis(2-ethylhexyl) phthalate are reserved.
- (2) Any existing source subject to this subpart that introduces pollutants into a publicly owned treatment works must comply with 40 CFR Part 403 - General Pretreatment Regulations.

B. PRETREATMENT STANDARDS FOR EXISTING SOURCES FOR THE CLEANING WATER SUBCATEGORY

Any existing source subject to this subpart that introduces pollutants into a publicly owned treatment works must comply with 40 CFR Part 403 - General Pretreatment Regulations.

C. PRETREATMENT STANDARDS FOR EXISTING SOURCES FOR THE FINISHING WATER SUBCATEGORY

- (1) PSES for bis(2-ethylhexyl) phthalate, di-n-butyl phthalate, and dimethyl phthalate are reserved.
- (2) Any existing source subject to this subpart that introduces pollutants into a publicly owned treatment works must comply with 40 CFR Part 403 - General Pretreatment Regulations.

7. Except for one phthalate in contact cooling and heating waters and three phthalates in finishing waters, EPA is not promulgating pretreatment standards for new sources for the PM&F category because the Agency has determined that toxic pollutants found in PM&F process waters do not pass through a well-operated secondary POTW. PSNS for the phthalates in two subcategories are reserved pending further study.

A. PRETREATMENT STANDARDS FOR NEW SOURCES FOR THE CONTACT COOLING AND HEATING WATER SUBCATEGORY

- (1) PSNS for bis(2-ethylhexyl) phthalate are reserved.
- (2) Any new source subject to this subpart that introduces pollutants into a publicly owned treatment works must comply with 40 CFR Part 403 - General Pretreatment Regulations.

B. PRETREATMENT STANDARDS FOR NEW SOURCES FOR THE CLEANING WATER SUBCATEGORY

Any new source subject to this subpart that introduces pollutants into a publicly owned treatment works must comply with 40 CFR Part 403 - General Pretreatment Regulations.

C. PRETREATMENT STANDARDS FOR NEW SOURCES FOR THE FINISHING WATER SUBCATEGORY

- (1) PSNS for bis(2-ethylhexyl) phthalate, di-n-butyl phthalate, and dimethyl phthalate are reserved.
- (2) Any new source subject to this subpart that introduces pollutants into a publicly owned treatment works must comply with 40 CFR Part 403 - General Pretreatment Regulations.





## SECTION III

### INTRODUCTION

#### BACKGROUND

The Federal Water Pollution Control Act Amendments of 1972 established a comprehensive program to "restore and maintain the chemical, physical, and biological integrity of the Nation's waters," under Section 101(a). By July 1, 1977, existing industrial dischargers were required to achieve "effluent limitations requiring the application of the best practicable control technology currently available" (BPT), under Section 301(b)(1)(A); and by July 1, 1984, "effluent limitations requiring the application of the best available technology economically achievable . . . which will result in reasonable further progress toward the national goal of eliminating the discharge of all pollutants" (BAT), under Section 301(b)(2)(A). New industrial direct dischargers were required to comply with Section 306 new source performance standards (NSPS) based on best available demonstrated technology; existing and new dischargers to publicly owned treatment works (POTW) were subject to pretreatment standards under Sections 307(b) (PSES) and (c) (PSNS), respectively, of the Act.

The requirements for direct dischargers were to be incorporated into National Pollutant Discharge Elimination System (NPDES) permits issued under Section 402 of the Act while pretreatment standards were made enforceable directly against dischargers to a POTW (indirect dischargers). Although Section 402(a)(1) of the 1972 Act authorized the setting of NPDES permit requirements for direct dischargers on a case-by-case basis, Congress intended that, for the most part, effluent limitations guidelines be based on the degree of effluent reduction attainable by the application of BPT and BAT. Moreover, Sections 304(c) and 306 of the Act required promulgation of new source performance standards; and Sections 304(f), 307(b), and 307(c) required promulgation of pretreatment standards. In addition to the effluent limitations guidelines and standards for designated industry categories, Section 307(a) of the Act required the Administrator to promulgate effluent standards for toxic pollutants applicable to all dischargers of these pollutants. Finally, Section 501(a) of the Act authorized the Administrator to prescribe any additional regulations "necessary to carry out his functions" under the Act.

EPA was unable to promulgate many of the toxic pollutant standards by the dates specified in the Act. In 1976, EPA was sued by several environmental groups and in settlement of this lawsuit, EPA and the plaintiffs executed a "Settlement Agreement" that was approved by the Court. This agreement required EPA to

develop a program and adhere to a schedule for promulgating effluent limitations guidelines, pretreatment standards, and new source performance standards for 65 "priority" compounds and classes of compounds for 21 major industries. See, Settlement Agreement in Natural Resources Defense Council, Inc. v. Train, 8 ERC 2120 (D.D.C. 1976), modified 12 ERC 1833 (D.D.C. 1979), modified by orders dated October 26, 1982, August 2, 1983; January 6, 1984; and July 5, 1984.

On December 27, 1977, the President signed into law amendments to the Federal Water Pollution Control Act (P.L. 95-217). The Act, as amended, is commonly referred to as the Clean Water Act. Although this Act makes several important changes in the federal water pollution control program, its most significant feature is its incorporation of several of the basic elements of the Settlement Agreement program for toxic pollution control. Sections 301(b)(2)(C) and 301(b)(2)(D) of the Act now require the achievement by July 1, 1984, of effluent limitations guidelines based on the application of BAT for toxic pollutants, including the 65 priority compounds and classes of compounds (the same toxic pollutants as listed in Natural Resources Defense Council, Inc. v. Train, *supra*) Congress declared toxic under Section 307(a) of the Act. Likewise, EPA's program for new source performance standards is now aimed principally at control of these toxic pollutants. Pretreatment standards control the toxic pollutants and other pollutants that are incompatible with a POTW. Moreover, to strengthen the toxics control program, Congress added Section 304(e) to the Act, authorizing the Administrator to prescribe "best management practices" (BMP) to prevent the release of toxic and hazardous pollutants from plant site runoff, spillage or leaks, sludge or waste disposal, and drainage from raw material storage associated with, or ancillary to, the manufacturing or treatment process.

In keeping with its emphasis on toxic pollutants, the Clean Water Act also revised the control program for other types of pollutants. Instead of BAT for "conventional" pollutants identified under Section 304(a)(4) (including biochemical oxygen demand, oil and grease, total suspended solids, fecal coliform, and pH), the new Section 301(b)(2)(E) requires achievement, by July 1, 1984, of "effluent limitations requiring the application of the best conventional pollutant control technology" (BCT). The factors considered in assessing BCT for an industry include a two-part "cost-reasonableness" test (Section 304(b)(4)(B)). See, American Paper Institute v. EPA, 660 F.2d 954 (4th Cir. 1981). The first part compares the cost for private industry to reduce its conventional pollutant concentrations with the costs for publicly owned treatment works for similar levels of reduction of those pollutants. The second part examines the cost effectiveness of additional industrial treatment beyond BPT.

For nonconventional pollutants, Sections 301(b)(2)(A) and (b)(2)(F) require achievement of BAT effluent limitations guidelines within three years after their establishment, or not later than July 1, 1984, whichever is later, but in no case later than July 1, 1987.

#### PURPOSE

This document presents the information and data used to develop the final effluent limitations guidelines and standards for the plastics molding and forming (PM&F) point source category.

#### AUTHORITY

Effluent limitations guidelines and standards for the PM&F category are promulgated under authority of Sections 301, 304, 306, 307, 308, and 501 of the Clean Water Act (the Federal Water Pollution Control Act Amendments of 1972, 33 U.S.C. 1251 et seq., as amended by the Clean Water Act of 1972, Pub. L. 95-217) (the "Act"). The PM&F regulation is also promulgated in response to the Settlement Agreement in Natural Resources Defense Council, Inc. v. Train, 8 ERC 2120 (D.D.C. 1976), modified 12 ERC 1833 (D.D.C. 1979), modified by orders dated October 26, 1982; August 2, 1983; January 6, 1984; and July 5, 1984.

#### STUDY APPROACH

The approach used to develop the final PM&F effluent limitations guidelines and standards included the following:

1. The Agency conducted three questionnaire surveys, a two part telephone survey, and three process water sampling programs to gather information on production, manufacturing processes, water use and discharge practices, wastewater treatment, and process water characteristics.
2. EPA sampled 18 PM&F plants to characterize PM&F process waters. Samples were analyzed for conventional, selected nonconventional, and priority toxic pollutants.
3. A PM&F category profile was developed using information from both the questionnaire surveys and literature sources.
4. The PM&F category was subcategorized based on information from the questionnaire surveys and information from the process water sampling programs.

5. Results of the sampling programs were used to determine the pollutants in PM&F process water in treatable concentrations.
6. Control and treatment technologies that effectively control the pollutants in PM&F process waters were evaluated.
7. Costs, pollutant removals, energy, and non-water quality aspects were evaluated for the various treatment technologies.
8. A model treatment technology was selected for BPT, BAT, BCT, and NSPS.
9. Effluent concentration data for the model treatment technologies were obtained.
10. Effluent concentrations for each type of effluent limitations guidelines and standard were then established. Permit writers use those concentrations and the average process water usage flow rate for a process, which is obtained from the permittee, to calculate the mass of a pollutant that can be discharged.

EPA also evaluated the need for pretreatment standards to control discharges of pollutants that may pass through a well-operated secondary POTW. Results of that evaluation are presented in this document.

## SECTION IV

### CATEGORY PROFILE

The plastics molding and forming (PM&F) category covers a large, diverse industry that uses plastic materials to produce a wide variety of consumer and industrial products. Since shortly after the discovery of plastic materials, nearly 60 years ago, molding and forming processes have been used to turn those plastic materials into usable items. Originally, plastic products were typically considered to be inexpensive substitutes for wood, leather, and metal items. However, in many cases, plastic products have virtually replaced other products due to their superior characteristics, such as light weight, durability, and resistance to corrosion. New product uses for plastics as well as new plastic formulations are continually being developed. The products produced by the plastics molding and forming category are used in a wide variety of consumer and industrial markets including: automobiles, appliances and business machines, construction materials, disposables, household furnishings, housewares, and medical products.

The PM&F category is defined by both molding and forming processes and the type of material processed. Plants included in this category are generally classified by Standard Industrial Classification (SIC) 3079 (Miscellaneous Plastics Products), either as the primary or secondary SIC code. Standard Industrial Classifications are established by the Department of Commerce, Bureau of the Census. Plants in the PM&F category with a secondary SIC code of 3079 include plants in the textiles, lumber and wood products, printing and publishing, machinery, and transportation equipment industries. Classification of plants covered by the PM&F category is further discussed in Section V.

In the course of developing the effluent limitations guidelines and standards for the plastics molding and forming category, several data gathering efforts were undertaken to characterize the category. They included:

- sampling at PM&F plants,
- conducting questionnaire and telephone surveys, and
- reviewing various literature sources.

#### SAMPLING PROGRAM

Information on the PM&F category was gathered during three wastewater sampling programs for this regulation. Eighteen PM&F plants were sampled: seven in 1984, seven in 1983, and four in 1980. Flow measurements taken at the sampled plants provided

information on water use and discharge practices. Wastewater samples were collected and analyzed for conventional, selected nonconventional, and priority toxic pollutants. A discussion of the sampling programs including analytical results is presented in Section VI and Appendix A.

### QUESTIONNAIRE SURVEYS

The plastics molding and forming category was surveyed to gather information on plant size and age, production, production processes used, and the quantity, treatment, and disposal of wastewater generated at PM&F plants. This information was requested in three questionnaires mailed under authority of Section 308 of the Act to companies known or believed to be involved in plastics molding or forming. A two-part telephone survey was used to develop the sample population for the third questionnaire survey.

#### 1978 and 1979 Questionnaire Surveys

In 1978, 8,450 firms were sent a one-page questionnaire. The names and addresses of the plants on the mailing list for this questionnaire were compiled from the following sources:

1. Dun & Bradstreet, Inc. and
2. Fortune 500.

The questionnaire asked if the company was a plastics molder and former; if process water was used, (i.e., water that contacts the plastic product); the type of discharge mode; what plastic materials were used; and what products were produced at the plant. When firms had plastics molding and forming processes at more than one location, a questionnaire was completed for each plant. A total of 5,138 questionnaires were returned: 1,114 indicated the plant uses process water in a PM&F process and 4,024 indicated the plant did not use process water.

From the 1,114 respondents to the 1978 survey that indicated they use process water, 750 plants were mailed a more detailed questionnaire in 1979. Approximately 59 percent of the companies responded to the survey. Of the 440 respondents to the survey, 407 returned completed questionnaires and 33 indicated they had responded incorrectly to the one page questionnaire and had only dry processes (i.e., process water did not contact the formed plastic product). Seventy-five of the 407 returned questionnaires contained unclear data. Therefore, only data from the other 332 questionnaires were included in the data base for this regulation.

## 1983 Telephone Survey

In 1983, a two-part telephone survey was conducted to screen the target population for the third questionnaire survey. The first part of the telephone survey consisted of calling:

1. Two hundred thirty-two plants that returned a completed 1979 questionnaire;
2. One hundred ninety-three randomly selected plants that received a questionnaire in 1979 but did not return it; and
3. Seven hundred thirty-four plants, which is one-half of the PM&F plants (i.e., "new plants") that entered the market between January 1, 1978, and December 31, 1981, according to Dun and Bradstreet's list of plants with a primary SIC Code 3079.

The first part of the telephone survey was designed so that the ratio of plants that returned a completed questionnaire in 1979 to those that did not return a completed 1979 questionnaire (232:193) was the same as the actual ratio of plants that returned a completed 1979 questionnaire to those that did not return a completed questionnaire (407:343). All plants called in the telephone survey were asked whether they were plastics molders and formers and if they use process water in their PM&F processes.

Table IV-1 contains the results of the first part of the telephone survey. As shown in the table, 50 percent of the new plants indicated they use process water. This number was viewed with caution because the Agency believes that many of the respondents did not completely understand the difference between contact and non-contact cooling water.

In the second part of the 1983 telephone survey, the other portion of the new PM&F plants that entered the market between January 1, 1978, and December 31, 1981, (according to Dun and Bradstreet's listing of plants with a primary SIC 3079) were contacted. They were also asked if they were plastics molders and formers and if they use process water. However, they were asked more specific questions, such as what kind of PM&F processes they employ. Because more time was spent asking detailed questions, information from this part of the survey concerning the number of processes that use process water (i.e., wet) and that do not use process water (i.e., dry) is more reliable than similar information from the first part of the telephone survey.

Table IV-1

RESULTS OF 1983 PLASTICS MOLDING AND FORMING TELEPHONE SURVEY  
FIRST PART

	<u>Total Number of Plants Contacted</u>	<u>Number of Plants in the PM&amp;F Category</u>	<u>PM&amp;F Plants</u>					
			<u>Wet</u>	<u>(%)</u>	<u>Dry</u>	<u>(%)</u>	<u>Total</u>	<u>(%)</u>
Respondents to the 1979 ques- tionnaire	232	182	182	(100)	0		182	(100)
Non-respondents to the 1979 question- naire	193	103	29	(28)	74	(72)	103	(100)
New plants listed as entering the market between 1977 and 1981*	734	467	233	(50)	234	(50)	467	(100)

32

---

\*Based on a listing of plants with a primary SIC of 3079 obtained from Dun and Bradstreet, Inc.



In the second part of the telephone survey, 741 PM&F plants were contacted. Out of that number, 535 plants were plastic molders and formers, while the remaining 206 plants were not. Eighty-four (16 percent) of the 535 PM&F plants had wet processes and 451 (84 percent) had dry processes.

Table IV-2 contains a distribution of the wet and dry processes from the second part of the telephone survey by the type of process. The number of wet processes and the number of dry processes are larger than the number of PM&F plants because some plants had more than one PM&F process. Types of processes with the largest number of wet processes were extrusion, molding, and finishing.

Results of the second part of the telephone survey are distributed by type of wet process and discharge mode in Table IV-3. Most PM&F processes in the second part of the telephone survey discharged process water to a POTW or did not discharge process water (i.e., zero discharge).

Statistics from the 1978 single page questionnaire and the second part of the 1983 telephone survey were used to estimate the percentages of wet and dry plants in the PM&F category. These were the only two surveys not directed solely at plants believed to use process water. Of the 5,138 PM&F plants that returned the single page questionnaire in 1978, 21 percent indicated they had wet PM&F processes. This percentage was averaged with the 16 percent of the PM&F plants from the second part of the 1983 telephone survey that had wet processes to obtain an estimate of 18.5 percent of the plants in the PM&F industry that are wet (i.e., use process water). Multiplying that percentage times the estimated 10,260 plants in the PM&F category provides an estimate of 1,898 wet plants in the category.

The total number of 10,260 PM&F plants in the United States was estimated from the State Industrial Guides (Appendix B lists the guides used to develop this estimate). For the purpose of the analysis to determine the economic impact of the PM&F regulation, a sample of PM&F plants was selected from the State Industrial Guides. The sample, created by extracting every 20th plant listed as a producer of SIC 3079 products, formed a data base with 513 entries. Because one of every 20 plants was included, the 513 entries represent five percent of the category. It follows that the PM&F category is comprised of approximately 10,260 plants. ( $20 \times 513 = 10,260$ ). Approximately 77 percent of the 513 randomly selected plants had a primary SIC of 3079 and approximately 23 percent had a secondary SIC of 3079. Applying these percentages to the total number of plants in the PM&F industry yields 7,900 plants that are primary plastics molders and formers and 2,360 that mold and form plastics as a secondary

Table IV-2

RESULTS OF 1983 PLASTICS MOLDING AND FORMING TELEPHONE SURVEY  
SECOND PART

<u>Type of Process</u>	<u>Wet Processes</u>	(%)*	<u>Dry Processes</u>	(%)*	<u>Total</u>	(%)
Extrusion	52	(48)	57	(52)	109	(100)
Molding	18	(5)	329	(95)	347	(100)
Coating and Laminating	1	(3)	34	(97)	35	(100)
Thermoforming	0	(0)	61	(100)	61	(100)
Calendering	0	(0)	2	(100)	2	(100)
Casting	1	(14)	6	(86)	7	(100)
Foaming	0	(0)	11	(100)	11	(100)
Cleaning	3	(60)	2	(40)	5	(100)
Finishing	11	(13)	72	(87)	83	(100)
	—		—		—	
TOTAL	86		574		660	
		Total		%		
	Wet Processes	86		13		
	Dry Processes	<u>574</u>		<u>87</u>		
		660		100		

---

\*Percent of type of process.

Table IV-3

DISTRIBUTION OF THE NUMBER OF PLASTICS MOLDING AND FORMING  
PROCESSES BY DISCHARGE MODE\*

<u>Type of Wet Process</u>	<u>% of Total Wet Processes</u>	<u>Discharge Mode</u>				<u>Total</u>
		<u>Direct</u>	<u>Indirect</u>	<u>Zero</u>	<u>Unknown</u>	
Extrusion	60.4	1	15	31	5	52
Molding	20.9	1	7	10	0	18
Coating and Laminating	1.2	0	0	1	0	1
Casting	1.2	0	1	0	0	1
Cleaning	3.5	0	3	0	0	3
Finishing	12.8	0	1	10	0	11
TOTAL	100.0	2	27	52	5	86

---

\*Based on information from second part of 1983 telephone survey.

operation. The types of plants with a secondary plastics molding and forming operation include: textiles, lumber and wood products, printing and publishing, machinery, and transportation equipment.

### 1983 Questionnaire Survey

To further update the questionnaire data collected in 1978 and 1979 and the telephone survey data collected in 1983, 330 questionnaires were mailed in June 1983 to PM&F plants believed to use process water. The questionnaire sample was developed based on the following criteria:

1. The sample was selected to obtain current information for plants in the category that used process water (wet plants).
2. The sample consisted of "new" PM&F plants (those entering the market between January 1, 1978, and December 31, 1981) and "old" PM&F plants that use process water.
3. The number of "new" wet plants was based on data obtained through the two-part 1983 telephone survey.
4. The number of "old" wet plants was based on data obtained from the 1978 and 1979 questionnaire surveys and from the first part of the 1983 telephone survey.

All plants entering the market between January 1, 1978, and December 31, 1981, were called during the 1983 two-part telephone survey. Results of that telephone survey indicate that there are 317 new plants that have wet processes.

As previously mentioned, a one-page questionnaire was mailed to 8,450 plants in 1978. There were 1,114 respondents to that questionnaire that indicated they had wet PM&F processes. A more detailed questionnaire was mailed to 750 of the 1,114 respondents in 1979.

Four hundred seven of the plants that received the 1979 detailed questionnaire returned a completed questionnaire and 343 did not return a completed questionnaire. Applying the percentage of the plants that returned completed questionnaires and the percentage of those that did not return completed questionnaires to the 1,114 wet plants reported in the 1978 one-page questionnaire provides an estimate of the 1,114 plants that would have returned a completed questionnaire and that would not have returned a completed questionnaire if all 1,114 wet plants were mailed a detailed questionnaire. Using those percentages, the Agency

estimated that 605 of 1,114 wet plants would have returned a completed questionnaire and 509 would not have returned a completed questionnaire.

To determine the current status of the 750 plants that received the 1979 questionnaire, 425 of those plants were called in 1983. Two hundred thirty-two of the 425 plants returned a questionnaire in 1979 and 193 did not return the questionnaire. As previously mentioned, this telephone survey was designed so that the ratio of the plants that were called (i.e., 232:193) was the same ratio of the plants that returned and did not return completed 1979 detailed questionnaires (i.e., 407:343).

Results of this telephone survey indicated that 182 of the 232 plants that returned completed 1979 questionnaires were still in business and had wet PM&F processes. Twenty-nine of the 193 plants that did not return a completed 1979 questionnaire were still in business and had wet PM&F processes.

The estimated number of the 1,114 wet plants from the 1978 questionnaire survey that would have returned a detailed questionnaire (i.e., 605) and the estimated number that would not have returned the questionnaire (i.e., 509) if all 1,114 plants had been mailed a questionnaire in 1979 were adjusted using the results of the above telephone survey. Based on those results, the Agency estimates 475 ( $605 \times 182/232$ ) of the 1,114 wet plants would have returned the questionnaire and 76 ( $509 \times 29/193$ ) would not have returned the questionnaire. Therefore, the target population for the 1983 questionnaire survey was:

317	new PM&F plants
475	old PM&F plants that would have returned the 1979 questionnaire
76	old PM&F plants that would not have returned the 1979 questionnaire
<hr/>	
868	total

The numbers in each of these strata were used to determine the distribution of the 330 detailed questionnaires that were mailed in 1983. That distribution is presented in Table IV-4.

In the 1983 questionnaire survey, companies were requested to return a questionnaire for each plastics molding and forming plant they operated. A total of 346 questionnaires were returned. Of the 346 questionnaires, 324 indicated the plant molds and forms plastic materials. One hundred sixty-four of those plants use process water (i.e., they were wet) and 160 do

Table IV-4

DISTRIBUTION OF THE 330 DETAILED 1983 QUESTIONNAIRES

<u>Stratum</u>	<u>Target Population</u>	<u>Number of 1983 Questionnaires</u>
New plants	317*	119
Old plants that would have returned 1979 questionnaire	475**	182
Old plants that would not have returned the 1979 questionnaire	76**	29

---

\*Based on results of 1983 telephone survey of new plants.

\*\*Based on results of 1983 telephone survey of plants that did  
and did not return a completed questionnaire in 1979.

not use process water (i.e., they are dry), meaning 49 percent of the plants do not use process water even though the survey was directed at plants who said they did use process water in the first part of the 1983 telephone survey. This supports the Agency's contention that plants did not understand the difference between contact and non-contact cooling water during the first part of the telephone survey.

Most of the plants that received the 1979 and 1983 questionnaires have a primary SIC of 3079, which means that a plant molds and forms plastics as a primary operation. During a meeting with representatives from the Society of Plastics Industries (SPI), they indicated that additional information could be obtained from plants with a secondary SIC of 3079 (i.e., the plant molds and forms plastics as a secondary operation) by sending a questionnaire to a sample of companies on the mailing list for the magazine "Plastic World." Therefore, in August 1983, 170 questionnaires were mailed to companies on that list. As with the other questionnaire surveys, companies were requested to return a questionnaire for each plastics molding and forming plant that they operated, so that a total of 173 questionnaires were returned. Of these, 106 questionnaires indicated the plant molds and forms plastics with 56 plants using process water and 50 plants having dry processes. Because the mailing list included many subscribers not believed to mold or form plastics, such as libraries and chambers of commerce, statistical information from these questionnaires was not used to characterize the PM&F category. However, information from the questionnaires regarding water use practices at plants with wet processes was included in the data base for this regulation.

#### Summary of Questionnaire Data Base

The questionnaire data base for this project consists of questionnaires from both the 1979 and 1983 surveys. When a plant returned a questionnaire in 1979 and again in 1983, only the updated questionnaire from the 1983 survey was included in the data base. Thus, only 175 of the original 332 questionnaires from the 1979 questionnaire survey remain in the updated data base. The data base also contains 207 of the 220 1983 questionnaires returned by wet plants during the 1983 questionnaire survey. The other 13 questionnaires were incomplete or not applicable to these effluent limitations guidelines. For the incomplete questionnaires, it was not possible to obtain additional data through further contact with the plants. Thus, the questionnaire data base consists of 175 questionnaires from the 1979 survey and 207 questionnaires from the 1983 survey for a total of 382 questionnaires.

Table IV-5 contains a distribution of the types of processes by discharge mode reported on the 1979 and 1983 questionnaires that make up the data base. These processes use water that contacts the plastic product. Extrusion processes are the most prevalent water-users followed by cleaning processes and molding processes. Calendering processes comprise the smallest percentage of processes that use process water (0.8 percent) because most of the cooling water is contained within the calender roll and never touches the plastic product.

Each of the questionnaires in the data base for this regulation were reviewed and the following data were documented for future reference and evaluation:

- company name, plant address, and name of the contact listed in the questionnaire.
- plant discharge status (i.e., direct, indirect, or zero discharge).
- production processes present at the plant; associated wastewater flow rates; production rates; operating hours; process water treatment, reuse, or disposal methods; and the plastic materials processed.
- capital and annual treatment costs.
- any available pollutant monitoring data provided by the plant.

The summaries provided a consistent, systematic method of evaluating the information. In addition, procedures were developed to simplify subsequent analyses. Using those procedures, information in the data base was used to:

- select and list the plants containing specific production processes and associated types of process waters and treatment technologies;
- sum the number of plants containing specific processes and associated types of process waters and treatment technology combinations;
- calculate annual production associated with each process; and
- calculate water use and process water discharge rates for individual processes.



Table IV-5

## WATER-USING PROCESSES IN THE PM&amp;F CATEGORY DISTRIBUTED BY DISCHARGE MODE

Type of Process†	Number of Processes in the Questionnaire Data Base							
	<u>Direct Discharge</u>	<u>(%)*</u>	<u>Indirect Discharge</u>	<u>(%)*</u>	<u>Zero Discharge</u>	<u>(%)*</u>	<u>Total</u>	<u>(%**)</u>
Extrusion	128	(78.6)	132	(57.1)	105	(82.7)	365	(70.0)
Molding	5	(3.1)	18	(7.8)	8	(6.3)	31	(6.0)
Coating and Laminating	2	(1.2)	7	(3.0)	4	(3.1)	13	(2.5)
Thermoforming	2	(1.2)	6	(2.6)	1	(0.8)	9	(1.7)
† Calendering	2	(1.2)	2	(0.9)	0	(0)	4	(0.8)
Casting	1	(0.6)	5	(2.2)	0	(0)	6	(1.2)
Cleaning	21	(12.9)	47	(20.3)	3	(2.4)	71	(13.6)
Finishing	2	(1.2)	14	(6.1)	6	(4.7)	22	(4.2)
TOTAL	163	(100)	231	(100)	127	(100)	521	(100)

†There are no foaming processes that use water in the questionnaire data base.

\*Percent of all types of processes in a discharge mode.

\*\*Percent of the total number of processes for all types of processes.

The survey information was used to develop the PM&F category profile, to develop a subcategorization scheme, to analyze treatment and control technologies, to determine the water use and discharge practices, and to estimate statistics for the estimated 1,898 plants in the PM&F category that use process water. A more detailed description of the PM&F data base is presented in Section VI.

#### LITERATURE REVIEW

The literature was examined for information on plastics molding and forming processes and wastewater treatment technologies. Treatment technology effectiveness and investment and annual operation and maintenance costs were also obtained from the literature.

Many sources were reviewed for information on wastewater treatment technologies. EPA's Innovative and Alternative Technology Assessment Manual provided most of the information on treatment technologies. Treatment technology performance data were obtained from EPA's Treatability Manual, Volume III, Technologies for Control/Removal of Pollutants. Additional data were obtained from documents supporting the proposed organic chemicals, plastics, and synthetic fibers category effluent limitations guidelines and standards. Treatment technology information obtained from these sources is presented in Section VIII. Costing information was obtained primarily from EPA's Estimating Water Treatment Costs and vendor contacts. Details on investment and operation and maintenance costs are presented in Section IX.

A great variety of general references, texts, and articles were used as sources of information on plastics molding and forming processes. The process descriptions derived from these sources are presented later in this chapter. Process information was supplemented by trip reports for numerous site visits to PM&F plants. A complete list of references used to obtain both process information and information on other aspects of the PM&F category is presented in Section XVI.

#### INDUSTRY DESCRIPTION

The following description of the PM&F category and the processes used to mold and form plastic products is based on information from the sources of information listed above. The literature provided the foundation on which the descriptions are based. Literature information has been augmented and updated where appropriate by data gathered during the sampling episodes and questionnaire surveys.

Plastic materials are a group of synthetic\* organic materials composed of high molecular weight, long chain molecules. The molecular composition along with the degree of crosslinking and the pattern and amount of branching in the molecule determines the material's characteristics. The generic category of plastic materials includes many types of resins, resinoids, organic polymers, cellulose derivatives, casein derivatives, and proteins. Except for some specialty applications, the majority of plastic materials used in consumer and industrial products are synthetically produced organic polymers and copolymers. The PM&F effluent limitations guidelines and standards only apply to synthetic organic polymers (i.e., thermoset polymers, thermoplastic polymers, or combinations of natural polymers and thermoset or thermoplastic polymers) that are solid in their final forms and that were shaped by flow. The materials can be either homogeneous polymers or polymers combined with fillers, plasticizers, pigments, stabilizers, or other additives. Accordingly, the PM&F regulation does not apply to natural organic materials.

Plastic materials can be generally classified into two basic groups: thermoplastics and thermosets. Thermoplastics become soft when exposed to a sufficient amount of heat and they harden when cooled. The heating and cooling process can be repeated several times. Thermoplastic materials can be processed by a large number of forming processes, the most common being injection molding and extrusion. They include: acrylonitrile-butadiene-styrene, polyethylene, polypropylene, polystyrene, and polyvinyl chloride.

Thermosetting plastics are set into their permanent shape when heat and pressure are applied during molding or forming. Unlike thermoplastics, once set into shape, thermoset products cannot be softened and reformed. Thermoset plastic products are usually formed by processes such as compression molding, transfer molding, and casting. Thermoset plastic materials include alkyd resins, epoxy resins, phenolic resins, and silicone.

Some plastics can be formulated into either thermoplastics or thermosetting products depending on the extent of crosslinking permitted during their manufacture. Once produced, these materials exhibit the properties of the particular type of plastic and are processed accordingly. Polyurethane and polyester are two such plastic materials.

---

\* The definition of plastic materials in the PM&F regulation also includes natural polymers that are combined with synthetic organic materials, such as cellulose acetate. Wholly natural organic materials, such as regenerated cellulose, are not included in this definition.

For the purpose of regulation, the plastics industry is covered by two industrial point source categories. These categories are: (1) the organic chemicals, plastics, and synthetic fibers category which includes manufacturers who produce and formulate all the basic plastic resins and who process certain natural organic materials; and (2) the plastics molding and forming category comprised of the processors that convert the plastic materials into usable shapes.

Overlap of the organic chemicals, plastics, and synthetic fibers category and the plastics molding and forming category occurs during the production of crude intermediate plastic material, such as pelletized plastic resin. Plastics molding and forming processes (e.g., extrusion and pelletizing) used by plastics resin manufacturers to process crude intermediate plastic material for shipment off-site are excluded from the PM&F regulation and are regulated under the organic chemicals, plastics, and synthetic fibers category. Plastics molding and forming processes used by plastic resin manufacturers to process crude intermediate plastic materials that are further processed on-site into intermediate or final plastics products in molding and forming processes are controlled by the effluent limitations guidelines and standards for the plastics molding and forming category.

For example, consider a manufacturer of polyurethane who uses contact cooling water in a pelletizing operation; the pelletizing operation is the last step in the polyurethane manufacturing process. If those polyurethane pellets (crude intermediate plastic material) are shipped off-site without further molding and forming, the contact cooling water used in the pelletizing operation is regulated under the organic chemicals, plastics, and synthetic fibers category. If, however, the extruded polyurethane pellets are further extruded on-site into polyurethane tubing (intermediate or final plastic product), the contact cooling water used in both the pelletizing operation and the extrusion operation would be regulated under the plastics molding and forming category.

PM&F plants produce a wide variety of products and range from small plants with a single process and a few employees to large plants with several hundred employees. Plastics molding and forming plants tend to be located near the sales centers of the United States so that finished consumer products need not be transported over long distances. Sixty-five percent of the plants are located in one of the following four clusters:

1. New York, New Jersey, and Pennsylvania;
2. Illinois, Indiana, Michigan, and Ohio;
3. Louisiana, Oklahoma, and Texas; and
4. California and Washington.

## PLASTICS MOLDING AND FORMING PROCESSES

The plastics molding and forming category consists of plants that blend, mold, form, or otherwise process a wide variety of plastic materials into intermediate or final plastic products. There are nine generic processes used to process plastic materials. They are:

1. extrusion,
2. molding,
3. coating and laminating,
4. thermoforming,
5. calendering,
6. casting,
7. foaming,
8. cleaning, and
9. finishing.

Each of these processes is described below including discussion of which PM&F processes use process water and the purpose of the water. For this regulation, process water is defined as any raw, service, recycled, or reused water that contacts the plastic product or contacts shaping equipment surfaces, such as molds and mandrels, that are or have been in contact with the plastic product. Non-contact cooling water is not process water and thus is not controlled by the final PM&F regulation. Permitting and control authorities will establish limitations for the discharge of non-contact cooling water and other non-process wastewater on a case-by-case basis.

### Extrusion Processes

Extrusion processes force molten polymer under pressure through a shaping die to produce products of uniform cross-sectional area such as pipe, tubing, sheet, film, and profile. This process has a number of different applications including the compounding of polymers, the production of pellets and parisons (blow molding preforms) for later use, the production of finished and semi-finished products, and the coating of substrate materials.

A wide range of polymers are extruded. Thermoplastic polymers are most commonly used and include acrylic resins, acrylonitrile-butadiene-styrene (ABS), polyacetal, fluoroplastics, nylon, polyphenylene oxide, polybutylene, polyethylene, polypropylene, polystyrene, polyvinyl chloride, styrene-acrylonitrile, and thermoplastic polyesters.

Extruded thermoplastic foams are produced by incorporating a gas-forming expanding agent in the thermoplastic and extruding the mixture under carefully controlled conditions. This is an

extrusion process with the addition of a blowing agent at the extrusion die. Packaging and building products are the major applications for extruded foam products. The primary raw materials used to produce extruded foam products are acrylonitrile-butadiene-styrene, high density polyethylene, polypropylene, polystyrene, and polyvinyl chloride.

A schematic of the extrusion process is shown in Figure IV-1. Polymer granules, pellets, powder, or beads are fed into the hopper of the extruder. The polymer is picked up by a rotating screw within the extruder cylinder and is forced toward the die. Heat provided to the cylinder walls begins the softening of the polymer pellets. As the material moves along the cylinder, friction becomes the primary source of heat. During this heating and compression period, the plastic material is transformed into a homogeneous melt and is thoroughly mixed.

Prior to leaving the extruder cylinder, the melted polymer passes through a screen pack that removes dirt and provides back pressure control. The melt enters the die at high pressure. The extrusion die is a streamlined orifice that reduces the melt to the desired shape. As the extrudate leaves the extruder, it is transported over some type of roller or conveyor cooling system that cools the hot extrudate by use of air or water.

Approximately 50 percent of extrusion processes use contact cooling water. Contact cooling water is used when a high heat transfer rate is required such as for the extrusion of thick-walled products or during pelletizing operations.

Extrusion processes are often used to blend, color, and pelletize polymers. Additives required for special applications and colors desired by the processor are added to the resin and are fed to the extruder to become a homogeneous melt. A brief description of the most commonly used classes of additives and specialty chemicals is presented in Table IV-6. The melt is extruded through a multi-opening die and taken off as strands that are cut into pellets of the desired size after cooling. In many cases, the pellets are cut at the face of the die, which is submerged in water for rapid cooling. Pelletized polymers can be in the form of round, cylindrical, or cube-shaped particles and can be used as feed material for extrusion, molding, casting, foaming, and other processes. Commonly pelletized thermoplastics are ABS, polyethylene, polypropylene, and polyvinyl chloride.

Extrusion processes can use both contact and non-contact cooling water. Non-contact cooling water is used to remove excess heat from the extrusion machinery caused by friction. Direct contact cooling water is used for product quenching. Extruded profile, pipe, and tube are often cooled by direct contact cooling water.

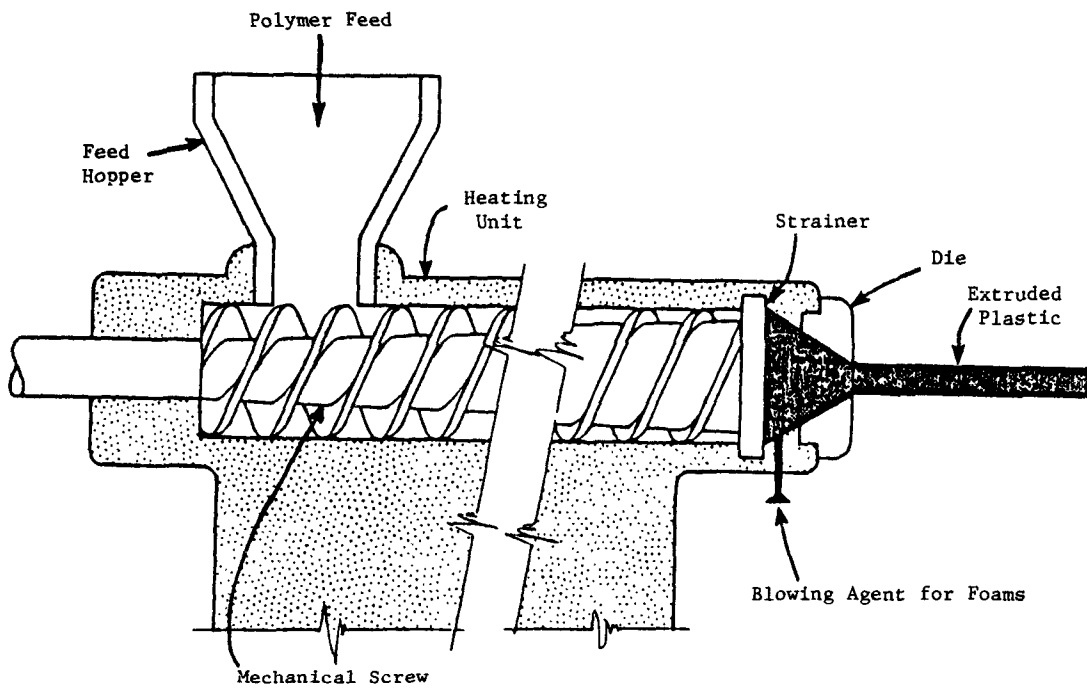
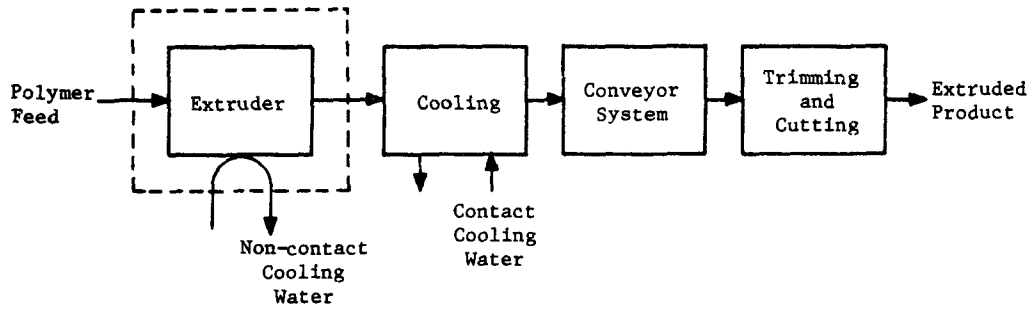

Source: Adpated from Masson, D. (ed). The Study of the Plastics Industry. 1973.

Figure IV-1  
EXTRUSION PROCESS

Table IV-6

COMMONLY USED ADDITIVES IN POLYMER FORMULATION  
USING THE EXTRUSION PROCESS

<u>Additive</u>	<u>Function</u>	<u>Example</u>
Antiblocking Agent	Prevents self-adhesion of films	Silicate minerals High melting point waxes
Antioxidants	Retard oxidative degradation of plastic material during processing and use	Alkylated phenols Amines Phosphates Thio compounds
Antisatic Agents	Reduce the accumulation of electronic charge on the surface of polymers	Amine Quaternary ammonium Anionic surface active agents
Catalysts	Affect the rate of chemical reactions without themselves being consumed or undergoing chemical change	Peroxides Organo-tin compounds Amines
Chemical Resistant Additives	Decrease polymer susceptibility to chemical degradation	Glass Synthetic fibers Graphite
Colorants	Impart hue (shade), volume (brightness), and chroma (strength of color) to plastics	Dyes Organic and inorganic pigments
Coupling Agents	Enhance polymer-mineral surface bonds and increase the ability of composites to retain properties during prolonged exposure to moisture	Silane compounds Titanate compounds
Cure Retardants	Reduce the cure rate for amino resins	Amines
Curing Agents	Improve the curing of thermosetting resins upon exposure to heat	Peroxides Amines Azo compounds
Fibrous Reinforcements	Impart tensile, flexural, and compressive strength to plastics	Synthetic fibers Carbon fibers Glass fibers
Fillers and Extenders	Increase the bulkiness and decrease the total cost of plastic formulations	Calcium carbonate Silica Nutshell flours
Flame Retardants	Act chemically or physically as insulators by creating endothermic cooling reactions, by coating the plastic to exclude oxygen or by influencing combustion through reaction with materials that have different physical properties	Antimony oxide Chlorinated parafins Halogenated organics
Foaming (blowing) Agents	Produce large quantities of gases upon heating that form cellular plastics	Nitrogen Pentane Azo bis formamide
Heat Stabilizers	Prevent the degradation of the plastic material during process heating and during its useful life	Barium-cadmium compounds Tin compounds



Table IV-6 (Continued)

COMMONLY USED ADDITIVES IN POLYMER FORMULATION  
USING THE EXTRUSION PROCESS

<u>Additive</u>	<u>Function</u>	<u>Example</u>
Impact Resistant Additives	Decrease a plastic materials tendency to break or crack upon impact	Acrylics ABS
Insulators	Improve the thermal or electrical insulating properties of polymers	Silaceous minerals Ceramic oxides
Lubricants	Enhance resin processibility and the appearance of the end product	Fatty acid esters Hydrocarbon oils Paraffin wax Amides
Mold Release Agents	Prevent sticking of newly formed parts to a mold	Silicon Mineral oil Wax Fatty acids Mica Talc
Plasticizers	Impart flexibility, resiliency and increasing melt flow to polymers by reducing the intramolecular forces between polymer chains	Phthalates Adipates Trimellitates Glycolates Fatty acid esters Organic phosphates
Preservatives and Biocides	Inhibit biological degradation of polymers	Fungicides Bacteriostats
Casting Promoters	Improve the cure of cast parts	Cobalt octoate Dimethyl aniline Tin salts
Sizing Agents	Coatings that protect the polymer surface	Waxes
UV Stabilizers	Absorb ultraviolet radiation and reradiate it at a harmless wavelength or consume the free radicals generated by UV light	Benzotriazoles Benzophenones

Plastic jacketed wire and cable is also passed through a water bath for direct contact cooling. The use of contact cooling water in extrusion processes is the major source of process water in the plastics molding and forming category.

### Molding Processes

Molding is the most common process used to produce finished or semi-finished products from plastic materials. Molded parts can be solid, hollow, or foamed. Plastic objects of almost any desired shape can be produced commercially by one of seven different types of molding processes:

1. injection molding,
2. blow molding,
3. compression molding,
4. transfer molding,
5. reaction injection molding,
6. rotational molding, and
7. expandable bead foam molding.

Injection Molding. Injection molding is used to form intricate plastic parts with excellent dimensional accuracy at very high production rates. Injection molding involves the plasticating of pelletized plastic materials with heat and the subsequent injection of the melt into a mold.

Both thermoplastic and thermoset polymers are injection molded. The majority of injection molded products are produced from polyethylene, polypropylene, polystyrene, and acrylonitrile-butadiene-styrene (ABS). Other polymers that are commercially injection molded are acrylic resins, fluoroplastics, nylons, phenolic resins, polyacetal, polycarbonate, polyesters, polyphenylene sulfide, and styrene-acrylonitrile. Typical injection molded products include appliance parts, furniture parts, machine parts, office and household items, and toys and novelties. Fillers can be added during the injection molding process to produce reinforced plastic products such as appliance components and sporting goods.

A schematic of the injection molding process is shown in Figure IV-2 . The resin and additives are fed into the heating portion of the injection molding machine where the polymer is heated to the temperature at which it becomes soft enough to flow. An injection system forces the melt through a nozzle, then through sprues and runners, and finally into the cavities of the mold where high pressure is held briefly to allow the plastic to set. As thermoplastics cool in the mold, they retain the desired product shape. Thermosets require that heat be applied to the mold to complete polymerization.

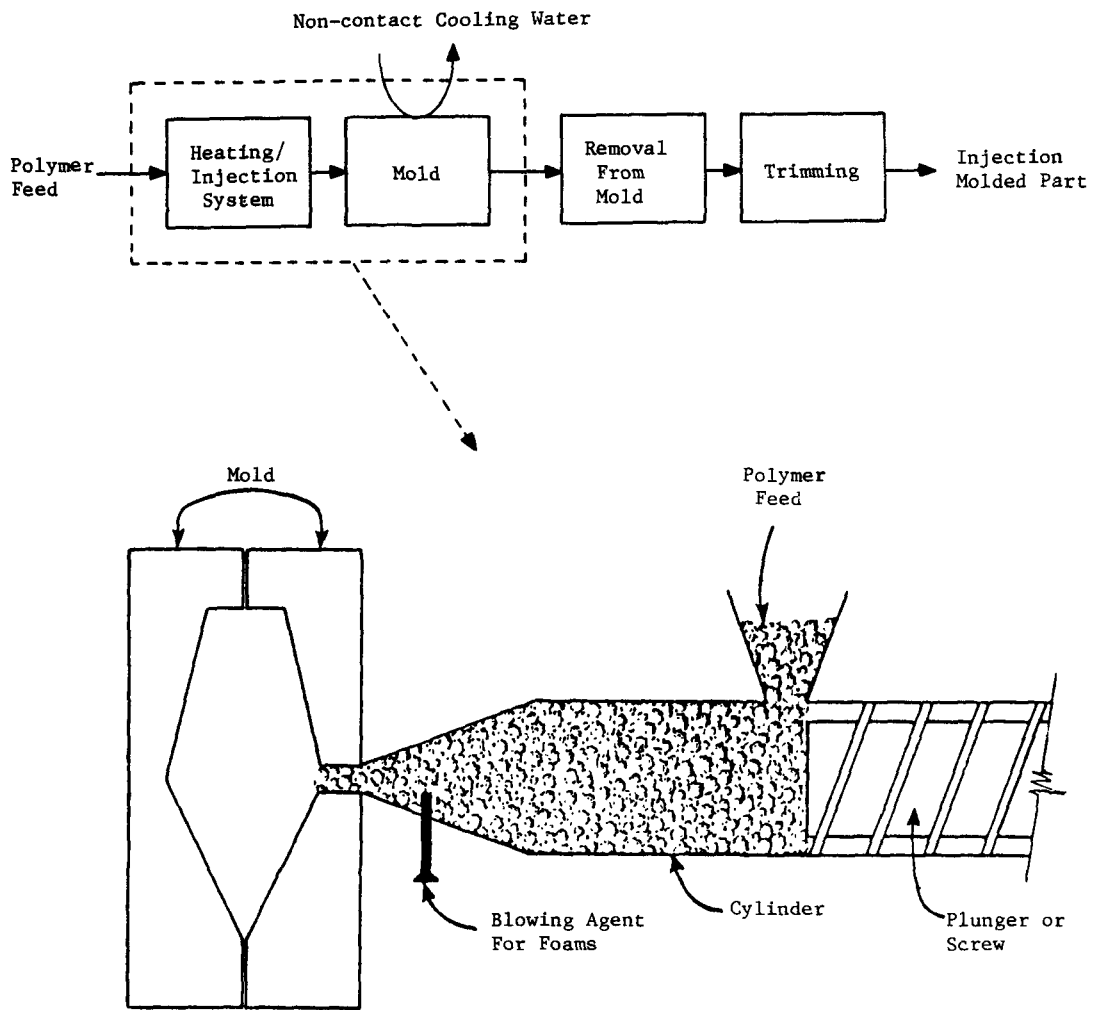

Source: Adapted from Masson, D. (ed). The Study of the Plastics Industry. 1973.

Figure IV-2  
INJECTION MOLDING PROCESS

Structural foam molding is an injection molding process where a blowing agent is added to either the polymer input materials or the polymer melt. Polystyrene is the major material used in structural foam molding. The following polymers are also used: acrylonitrile-butadiene-styrene, polyphenylene oxide, polycarbonate, high density polyethylene, polypropylene, and polystyrene. Uses for structural foam include furniture, business machines, and construction products.

There are four basic types of heating/injection systems used for commercial injection molding. They are: (1) conventional injection molding machines, (2) piston-type preplasticating machines, (3) screw type preplasticating machines, and (4) reciprocating-screw injection machines. The reciprocating screw injection machine is the most common machine for modern plastics processing due to its faster cycles, lower melting temperature requirements, and better mixing.

In conventional injection molding machines the plastic granules or pellets feed from a hopper into the chamber of the heating cylinder. A plunger compresses the material forcing it through progressively hotter zones of the heating cylinder. The material flows from the heating cylinder through a nozzle and into the mold. In piston-type preplasticating machines a heater is used to preplasticate the plastic granules after which the plastic is held in a holding chamber until it is molten enough to be forced into the die. A piston rams the plastic through the nozzle into the mold. In screw-type preplasticating machines, an extruder is used to plasticize the plastic material. A rotating screw feeds the pellets forward into the heated interior surface of the extruder barrel. The molten plastic is extruded into a holding chamber and is forced into the die by an injection plunger. In reciprocating screw injection machines, a rotating screw moves the plastic material forward through a heated extruder barrel. As the molten plastic material moves forward, the screw backs up to a limit switch that determines the volume of material collecting in the front of the barrel. The screw then acts as a ram and injects the plastic material into the die.

The majority of all injection molding operations use non-contact cooling water circulated through channels in both the injection equipment and the product mold. Direct contact cooling may be used, however, when molded parts require rapid cooling.

Blow Molding. Blow molding is used to produce hollow, thin wall objects from thermoplastic resins; it has become one of the major processing methods for the plastics industry for hollow articles. Blow molding involves extruding or injection molding a preformed shape that is then blown into its final form by compressed air.

Most thermoplastic materials can be blow molded; however, high density polyethylene has traditionally been the workhorse of the blow molding industry. Other thermoplastic polymers commercially used for blow molding include acrylic resins, acrylonitrile-butadiene-styrene, polyacetal, polycarbonate, polyester, polyethylenes, polypropylene, polystyrene, and polyvinyl chloride. Blow molding processes are used to produce a wide range of hollow bottles and containers. Approximately 80 percent of the blow molding processes produce packaging items. These include household bottles and containers for cosmetics, toiletries, pharmaceuticals, chemicals, and foods, as well as industrial containers. The remaining 20 percent produce industrial products such as automobile fuel tanks, lighting fixture globes, ornaments, and toys.

A schematic of a blow molding process is shown in Figure IV-3. Blow molding processes can be divided into two major types: extrusion blow molding and injection blow molding. These two processes are similar in that they both use a parison, or pre-shaped sleeve, of plastic that is expanded by air pressure to fill the inside of a concave mold. The difference between the processes lies in the formation of the parison. Extrusion blow molding uses an extruder to preform parisons whereas in injection blow molding the parisons are formed in an injection mold. Blow molding processes use non-contact cooling water to cool the mold.

Compression Molding. Compression molding is one of the earliest forms of molding; it requires only one major piece of equipment: the compression press. Compression molding involves shaping a measured quantity of plastic within a mold by applying pressure and heat. This molding process is ideal for the production of parts with large areas and relatively simple shapes.

Compression molding is primarily used for processing thermoset resins, although it is used to mold thermoplastics for special applications. Polymers most commonly used in compression molding include alkyd resins, amino resins, diallyl phthalate, epoxy resins, phenolic resins, and polyester resins. Other less frequently used polymers include polytetrafluorethylene, polyurethane, silicone, and polyvinyl chloride. Fillers such as glass fibers, wood, cotton, and cellulose are often used during compression molding to produce reinforced plastic products. Typical compression molded products include novelties, knobs, handles, dinnerware, buttons, electrical and electronic components, and appliance parts. Reinforced products include large automotive and appliance parts.

A schematic of the compression molding process is shown in Figure IV-4. The plastic material is fed to the compression mold either in granular form or as a preform. The mold halves are then

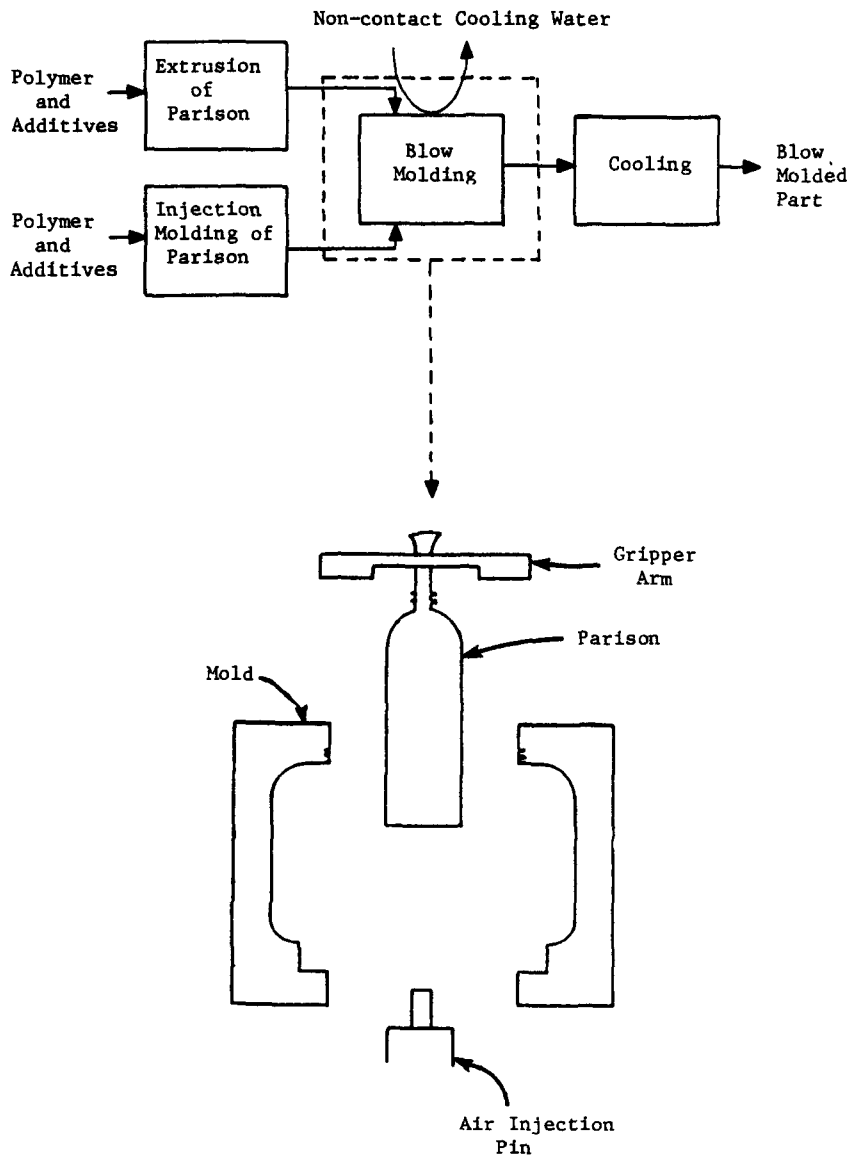

Source: Adapted from Seymour, W.B. Modern Plastics Technology. 1975.

Figure IV-3  
BLOW MOLDING PROCESS

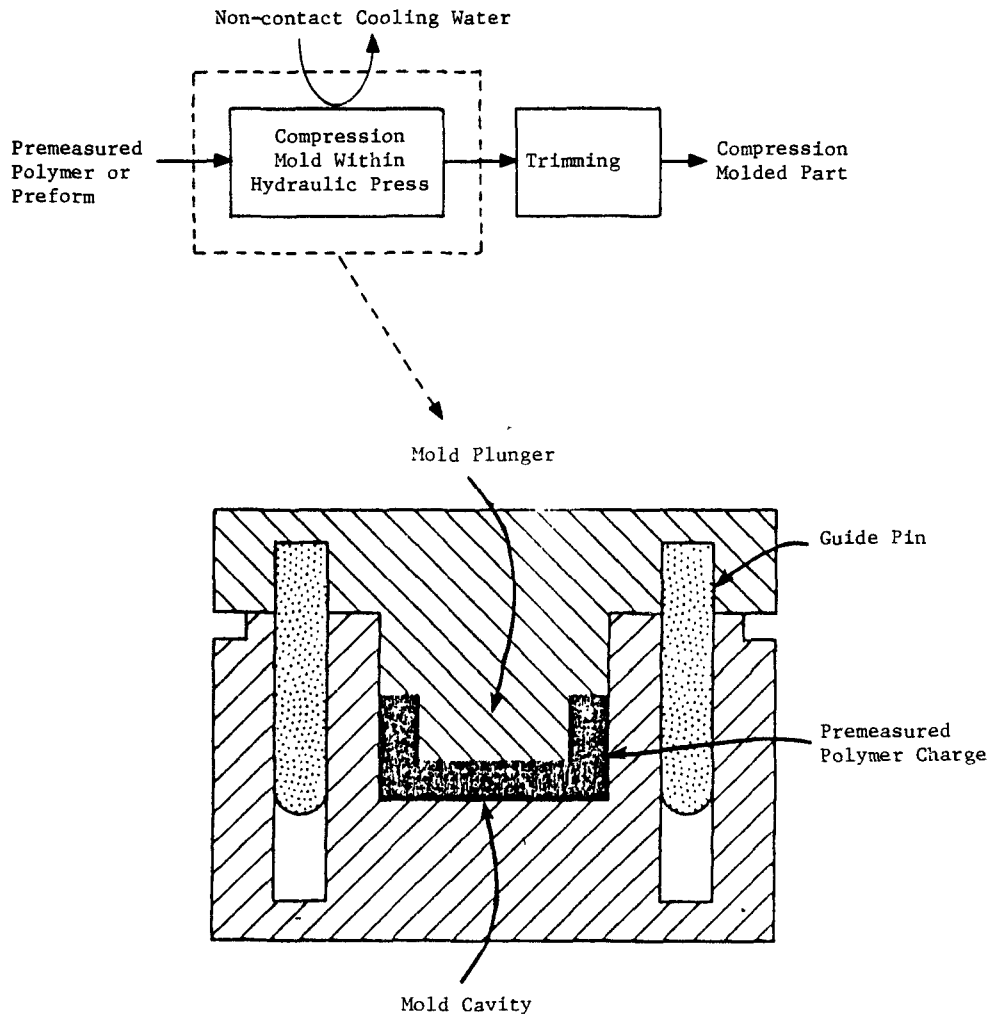

Source: Adapted from Masson, D. (ed). The Study of the Plastics Industry. 1973.

Figure IV-4  
 COMPRESSION MOLDING PROCESS

closed by a hydraulic press. Pressure is maintained and heat is applied, causing the plastic to spread to the shape of the mold.

Compression molding processes generally use non-contact cooling water to cool the mold halves. Some compression molding processes may use contact cooling water sprays to rapidly cool newly formed products.

Transfer Molding. Transfer molding is much like compression molding with the difference being that in transfer molding the resin is preheated in a separate chamber and is then forced into the mold cavity for curing.

Thermoset resins are most commonly transfer molded. These include alkyd resins, amino resins, diallyl phthalate resins, epoxy resins, phenolic resins, and polyester resins. Fillers such as cellulose, clay, glass fiber, minerals, and synthetic fibers are often used during transfer molding to produce reinforced plastic products. Transfer molding is especially well suited for the production of small intricate thermoset parts and is used extensively in the production of electrical insulating parts and connectors. Reinforced products include appliance housings and decorative parts.

A schematic of the transfer molding process is shown in Figure IV-5. Plastic preforms are preheated by heat lamps, hot air ovens, or dielectric heaters. That material is put into a chamber or "transfer pot" where it is plasticized by heat and pressure into a viscous mass. The plastic is then forced through sprues and runners into the mold cavity. The pot, sprues, runners, and cavity surfaces are maintained at a temperature suitable for rapid curing of the material. The plastic is held in the mold at its cure temperature until the part is capable of maintaining its shape. Transfer molding processes generally do not use contact water to cool the product.

Reaction Injection Molding. Reaction injection molding (RIM) involves the simultaneous high pressure injection of two or more reactive liquids into a mixing chamber followed by low pressure injection into a mold cavity. Most commercial reaction injection molding is performed with various urethane formulations. The majority of urethane formulations are comprised of two liquid intermediate feeds: the resin and isocyanate. When blowing agents are incorporated in the isocyanate feed, foam products are formed. Fillers are added during reaction injection molding to produce reinforced plastic products for the automotive industry. Reaction injection molded polyurethane products include bumper systems, panelling, automotive trim, sporting goods, and machinery housing.



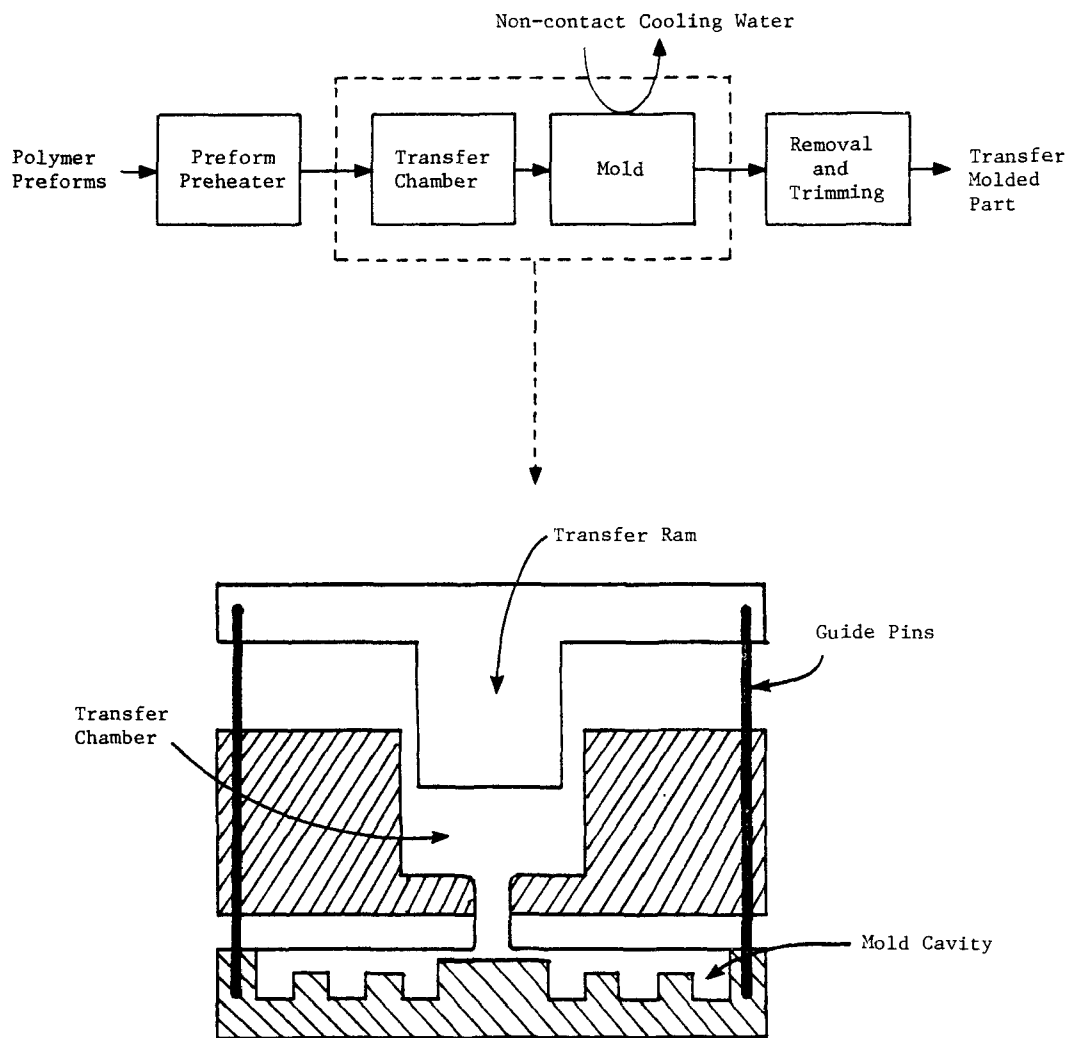

Figure IV-5

TRANSFER MOLDING PROCESS

A schematic of a reaction injection molding process is shown in Figure IV-6. A reaction injection molding process consists of four integrally related units: feed tanks, a metering system, a mixer, and the mold. The feed tanks are where the raw material components are stored and heated. Agitators, heat exchangers, low-pressure pumps, and recirculation equipment are used to maintain liquid temperature and uniformity. Liquid material from the feed tanks are metered to the mixing head where they are mixed under high-pressure. The liquids are then injected into the mold where polymerization occurs. Once the part has sufficiently cured to hold its shape, the mold is opened and the part is ejected. Contact water is not used during the reaction injection molding process. The molded parts can be sufficiently cooled by air. Non-contact water may be used to cool the mold.

Rotational Molding. Rotational molding, sometimes termed rotomolding or rotocasting, is used to make rigid or flexible thin-walled hollow objects from thermoplastic materials. Rotational molding involves rotating polymer powder or liquid in a heated hollow mold.

Rotational molding is performed almost exclusively with thermoplastic resins such as polyamide resins, polyacetal, polycarbonate, low density polyethylene, and polyvinyl chloride. The rotational molding process is used to produce a wide range of industrial and consumer goods including arm rests, toys and novelties, sporting goods, and tanks and storage bins.

A schematic of the rotational molding process is shown in Figure IV-7. Premeasured amounts of the polymer powder or liquid are put into the preheated hollow mold at the mold loading station. The mold is then put in the circulating hot air oven where it is simultaneously rotated around two perpendicular axes. The heat forces the thermoplastic to melt and the rotation uniformly distributes the polymer over the entire mold surface. The mold is then removed from the heating oven and is cooled. After the part has cooled sufficiently to hold the desired shape, the mold is opened and the part is removed.

Most rotational molding processes use non-contact cooling water to cool the outside surface of the mold. Some rotational molding processes may use direct contact water sprays when rapid cooling of the part is necessary.

Expandable Bead Foam Molding. Expandable bead foam molding processes produce a closed-cell, rigid plastic foam material characterized by fused polymer spheres. The fused polymer product is produced by expanding beads impregnated with hydrocarbon in a mold cavity. The beads puff and fuse together filling the mold cavity when heated.

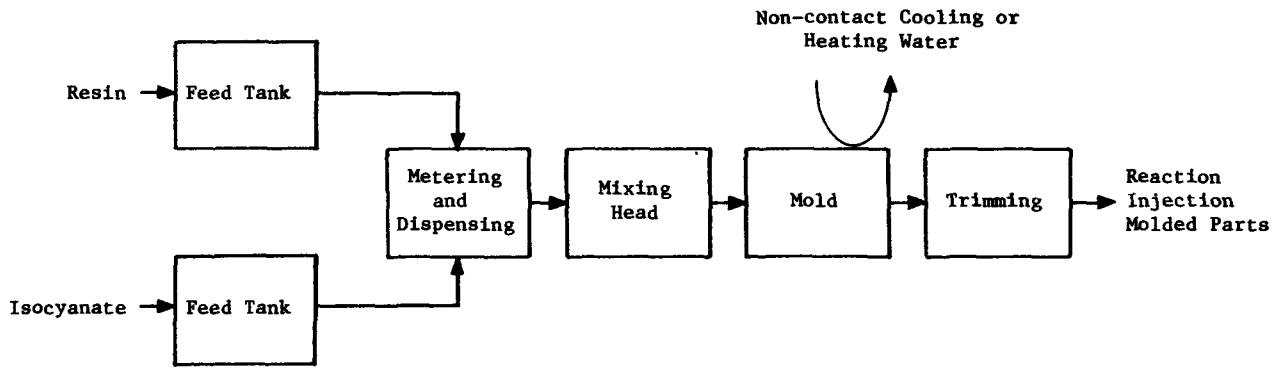

Figure IV-6

REACTION INJECTION MOLDING PROCESS

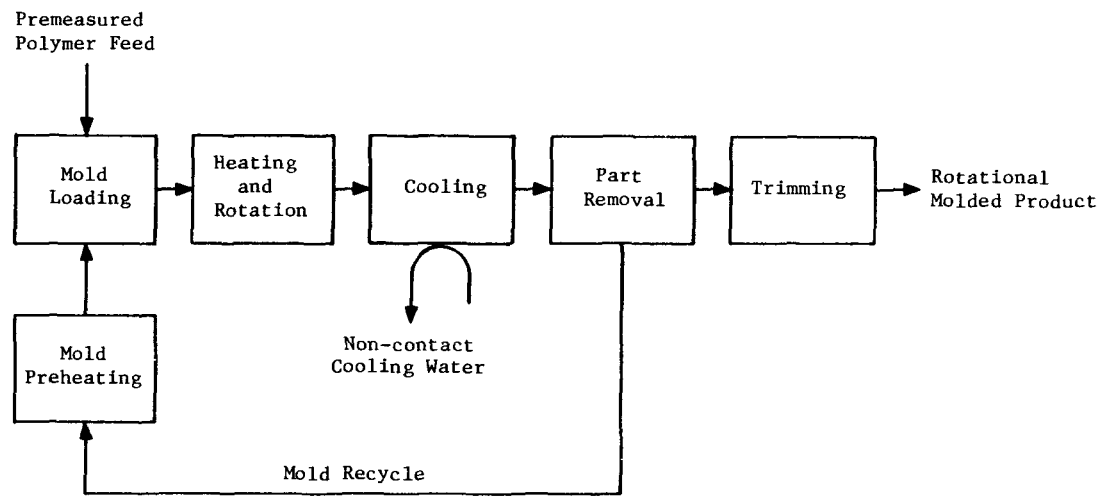

Figure IV-7  
ROTATIONAL MOLDING PROCESS

Most bead foam molding processes use polystyrene or polyvinyl chloride as raw materials. Typical end products are packaging materials, flotation devices, insulation, and hot and cold containers.

A schematic of an expandable bead foam process is shown in Figure IV-8. Polystyrene beads are usually pre-expanded to a bulk density close to the desired product bulk density prior to further processing. Pre-expansion equipment commonly consists of a steam chamber with baffles and mechanical agitation. Condensate is discharged from the steam chamber.

The pre-expanded beads are fed to a preheated split cavity mold. Steam is supplied to the mold cavity through small holes in the mold. The heat supplied by the steam causes the impregnated beads to expand to fill the confines of the mold. The soft and molten bead skins fuse together to form a single polymer mass. Condensed steam (contact heating water) is discharged from the mold cavity.

Water is generally not used for the direct contact cooling of foam products. Non-contact cooling water is used to cool extruder and mold assemblies. However, the steam that heats the product becomes a source of contact heating process water when condensed.

### Coating and Laminating Processes

Coating and laminating processes combine polymeric materials with other materials to produce products with special properties such as chemical resistance, toughness, humidity resistance, corrosion resistance, and electrical insulation. Heat is used in both processes. Lamination also requires high pressures.

Coating. Polymer coatings are applied in the form of a melt, liquid, or finely divided powder onto numerous substrates including other plastic objects, metal, wood, paper, fabric, leather, glass, concrete, and ceramics. Both thermoplastic and thermoset resins can be coated. The most common resins used are: acrylic resins, epoxy resins, fluoroplastics, amino resins, polyesters, low density polyethylene, polypropylene, and polyvinyl chloride. Typical products from coating processes include automotive parts, appliance parts, electrical supplies, furniture, and housewares.

There are four types of coating processes: plastisol coating, powder coating, spread coating, and extrusion coating. A flow diagram representing plastisol and powder coating is presented in Figure IV-9. Spread coating is illustrated in Figure IV-10. A flow diagram of the extrusion coating process is presented in Figure IV-11.

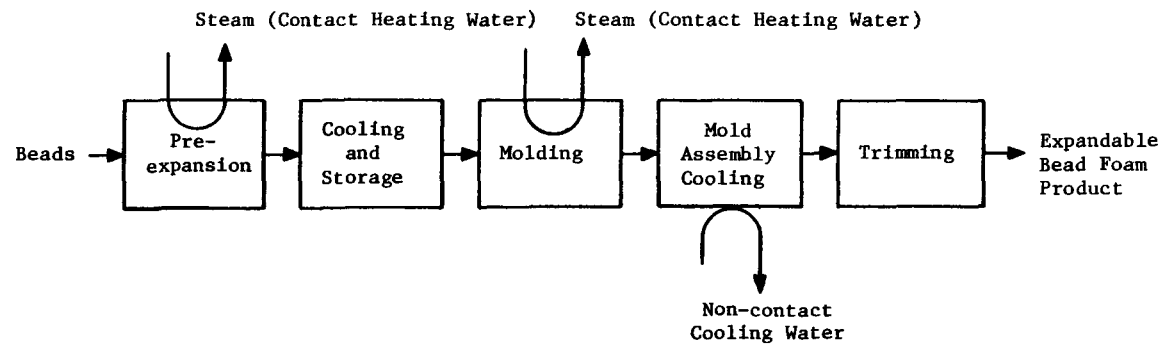

Figure IV-8

EXPANDABLE BEAD FOAM MOLDING PROCESS

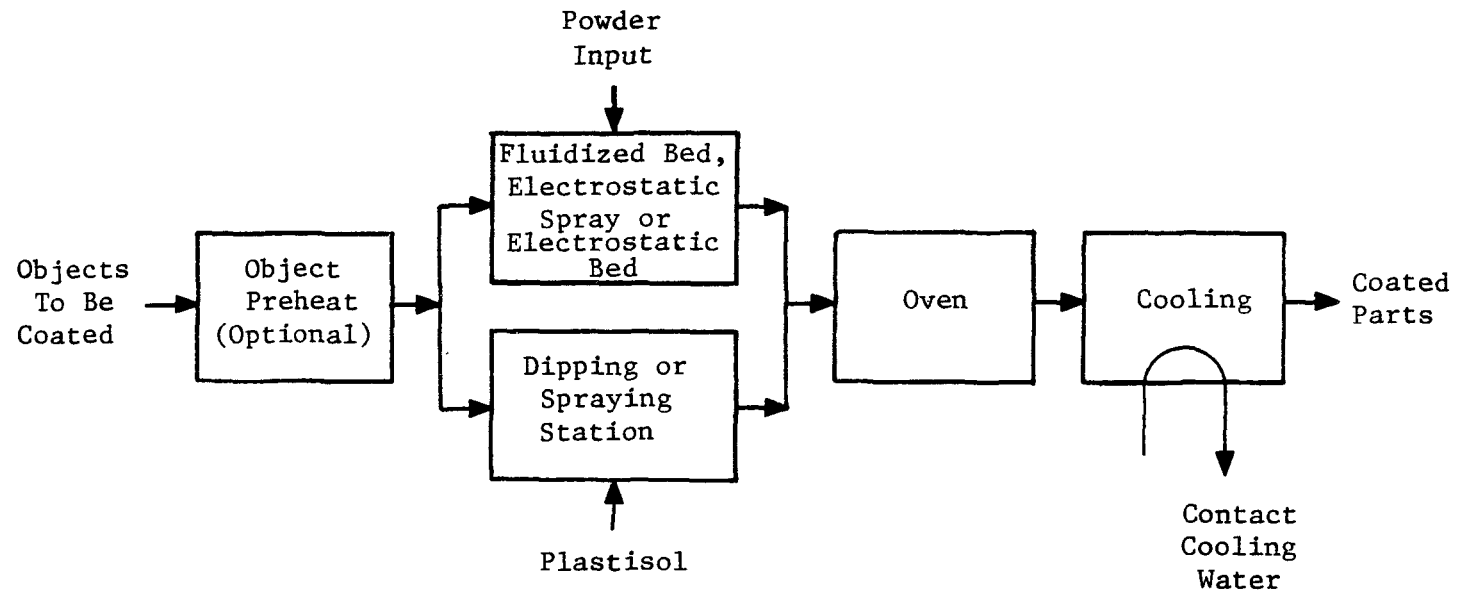

Figure IV-9

PLASTISOL AND POWDER COATING PROCESSES

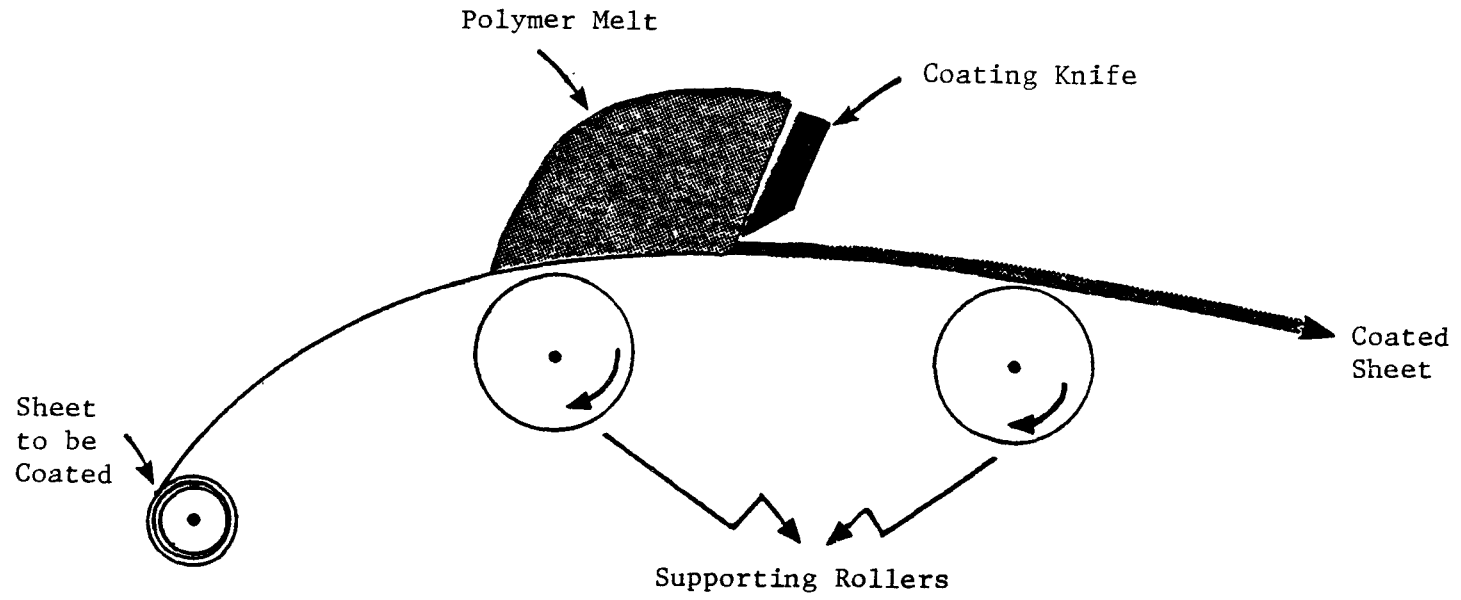

Figure IV-10  
SPREAD COATING PROCESS



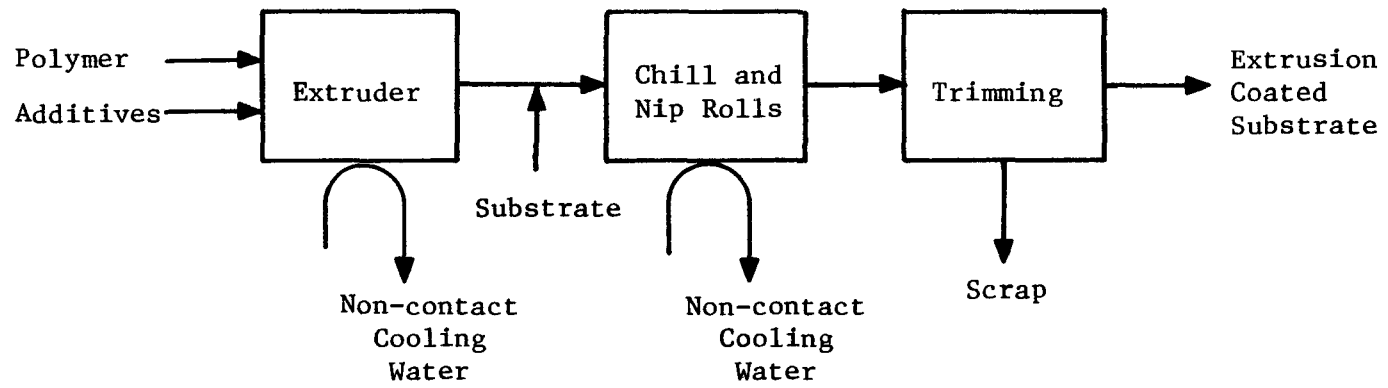

Figure IV-11  
EXTRUSION COATING PROCESS

Plastisol Coating. Plastisol coating involves the use of a liquid plastisol that consists of fine particles of polyvinyl chloride (PVC) dispersed in plasticizers. Typical plastisol coated products include housewares and outdoor furniture. The plastisol is contained in a vat into which the object to be coated is dipped. The objects are sometimes preheated to assure sufficient polymer fusion. The dipped parts then pass through an oven to complete fusion. Some product applications require that the plastisol be applied to the object surface with a spray gun or a brush. Whether sprayed or brushed, the coated object must subsequently be heated in an oven to fuse the polymer coat. The dip coating process is very similar to a dip casting process. The difference lies in the nature of the mold. In dip casting, the plastic part, such as a glove, is stripped from the mold and the mold is used to form another part. In dip coating, the mold is actually part of the finished product, such as a metal patio chair that is dip coated with plastic.

Powder Coating. Powder coating involves the use of a homogeneous blend of thermoset or thermoplastic resin, pigments, fillers, and additives in the form of a dry, fine, flour-like substance. Three basic powder coating methods exist: fluidized bed, electrostatic spray, and electrostatic bed. Fluidized bed coating involves creating a fluidized bed of thermoplastic or thermoset resin powder by the flow of air through a porous plate at the bottom of a tank. Objects to be coated are preheated and are then dipped into the fluidized bed. When the resin particles touch the surface of the hot object they melt and fuse. Electrostatic spraying is performed by charging the polymer powder either positively or negatively so that it is attracted to a grounded or oppositely charged object. The electrostatic bed process is a combination of the fluidized bed and electrostatic spray methods. Electrodes located in the porous plate at the bottom of the fluidized bed tank transfer a charge to the powder particles which are then attracted to the grounded object to be coated.

Spread Coating. Knife or spread coating uses a long blade or knife to spread the molten thermoplastic polymer coating on a moving substrate. Thermoplastics such as low density polyethylene, polyvinyl chloride, and polypropylene are used to coat flexible materials such as fabric.

Extrusion Coating. Extrusion coating involves the extrusion of a thin film of polymer onto a moving substrate, which is usually either a paper web, plastic sheet, or paper sheet. Polymers such as low density polyethylene, polypropylene, and polyethylene terephthalate are used in extrusion coating processes to produce the coatings.

Laminating. Laminate structures are formed from layers of resins and fillers bonded together. Thermosetting resins are the only resin types commercially used for laminating. Typical laminating resins include alkyd resins, epoxy resins, melamine formaldehyde, and phenolic resins. Paper, cloth, glass fiber, and glass cloth are typically used as the reinforcing substrate. Lamination processes are used to produce decorative panels and items requiring good electrical insulating properties. Process water is typically not used in lamination processes.

Laminating processes can be classified into three types: lamination of flat sheets, lamination of rods and tubes, and continuous lamination. A schematic of the laminating process is shown in Figure IV-12.

Flat Sheet Lamination. Flat laminate sheets are produced by impregnating the base sheets with liquid thermosetting resin. Phenolics, melamines, alkyd, polyester, and epoxies are all commonly used. The correct number of sheets for the specific application are placed together with the resin between two platens of a hydraulic laminating press. The hydraulic press closes and pressure and heat are applied to the layers. The thermoset resin flows through the filler sheets and cures. After the sheets have sufficiently cured, the platens are allowed to cool, the press is opened, and the sheets removed.

Rod and Tube Lamination. Laminate rods and tubes are produced from filler webs impregnated with thermoset resin. Solid rods are made by winding the impregnated filler web around a very thin rod (mandrel) which is then withdrawn. The preform rods are then placed in a compression mold where heat and pressure are applied. In some operations the rods are placed in an oven and allowed to cure without pressure over a long period of time, typically 12 to 24 hours. In making a tube, the mandrel is left in during the compression molding step.

Continuous Lamination. Continuous lamination processes are used to produce large volumes of structural grade sheets for use as residential and industrial panels. Polyester resins are most commonly used in the continuous lamination process along with chopped glass fibers. Continuous lamination is performed by combining the resins and reinforcements between two moving carrier films. The films are pulled through a set of squeeze rolls to eliminate entrapped air. The laminate cures in an oven after which the carrier film is stripped from the newly formed laminate. Figure IV-13 depicts the continuous lamination process.

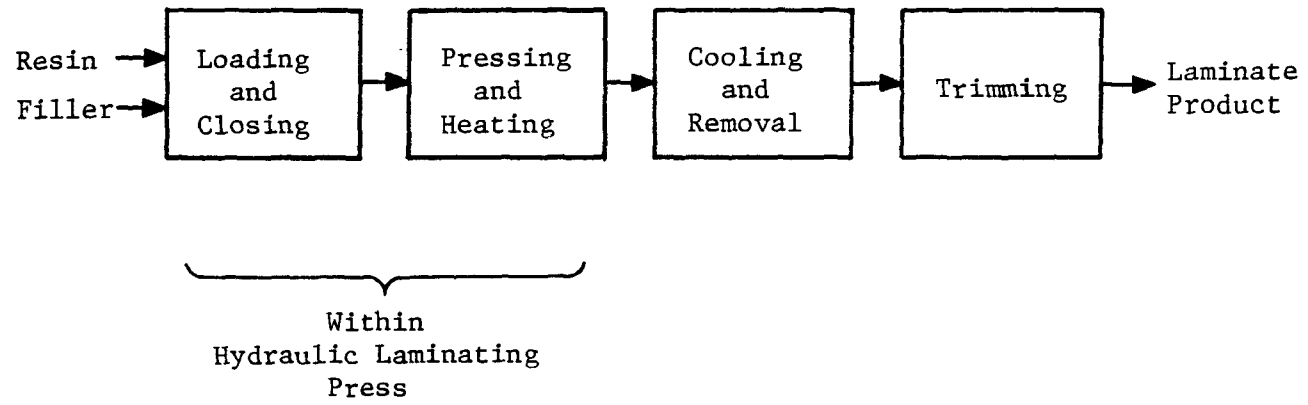

Figure IV-12  
LAMINATING PROCESS

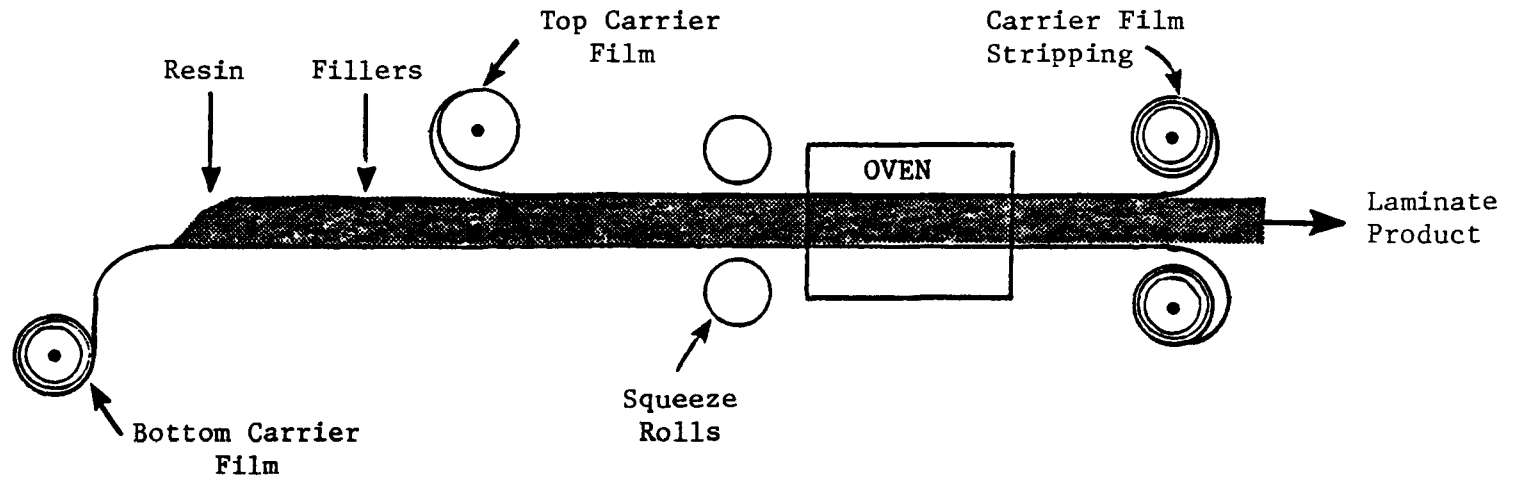

Figure IV-13  
CONTINUOUS LAMINATION PROCESS

## Thermoforming Processes

Thermoforming processes involve the heating of thermoplastic sheet or film to a pliable state and forcing it around the contours of a mold. Vacuum, air pressure, or mechanical force are employed to aid in the sheet forming. The input for thermoforming processes is foam sheet or film produced by extrusion, calendaring, or casting processes. Sheet and film can be laminated or printed prior to thermoforming.

A wide variety of sheet and film plastic is suitable for thermoforming. Sheet and film for thermoforming is typically made from acrylic, acrylonitrile-butadiene-styrene, polycarbonate, polyethylenes, polypropylene, polystyrene, and polyvinyl chloride. Typical thermoformed products include appliance parts, automotive parts, lighting fixtures, packaging, and signs and displays.

A schematic of the thermoforming processes is shown in Figure IV-14. Plastic sheet is clamped into a frame prior to thermoforming to provide support for the plastic material throughout the entire process. The plastic sheet is uniformly heated before being formed to be certain of uniform stretch during forming. One of three heating methods are usually used: radiant heating, convection heating, and conduction heating, with radiant heating being the most commonly used method. When sufficiently heated, the sheet is formed into the desired shape by one of three forming processes: (1) vacuum forming, (2) pressure forming, and (3) matched mold forming.

Vacuum Forming. Vacuum forming is the most versatile and most commonly used process for thermoforming. The heated sheet is placed directly above a concave mold and pressure is used to seal the plastic material to the upper mold edge. Vacuum is applied from beneath the mold through small holes in the mold cavity forcing the sheet against the mold contours. Although many variations of vacuum forming exist, they all employ a vacuum applied from below the mold surface. Common variations are termed drape forming, snap-back forming, and plug assist vacuum forming.

Pressure Forming. Pressure forming involves the use of air pressure to force the softened plastic sheet against the mold. A sheet of plastic is clamped over a pressure box containing a concave mold and is heated. The sheet is then covered and compressed air is blown through openings in the cover. The air pressure forces the sheet against the mold contours. A variation of pressure forming termed free blowing is used to produce bubble-like forms.

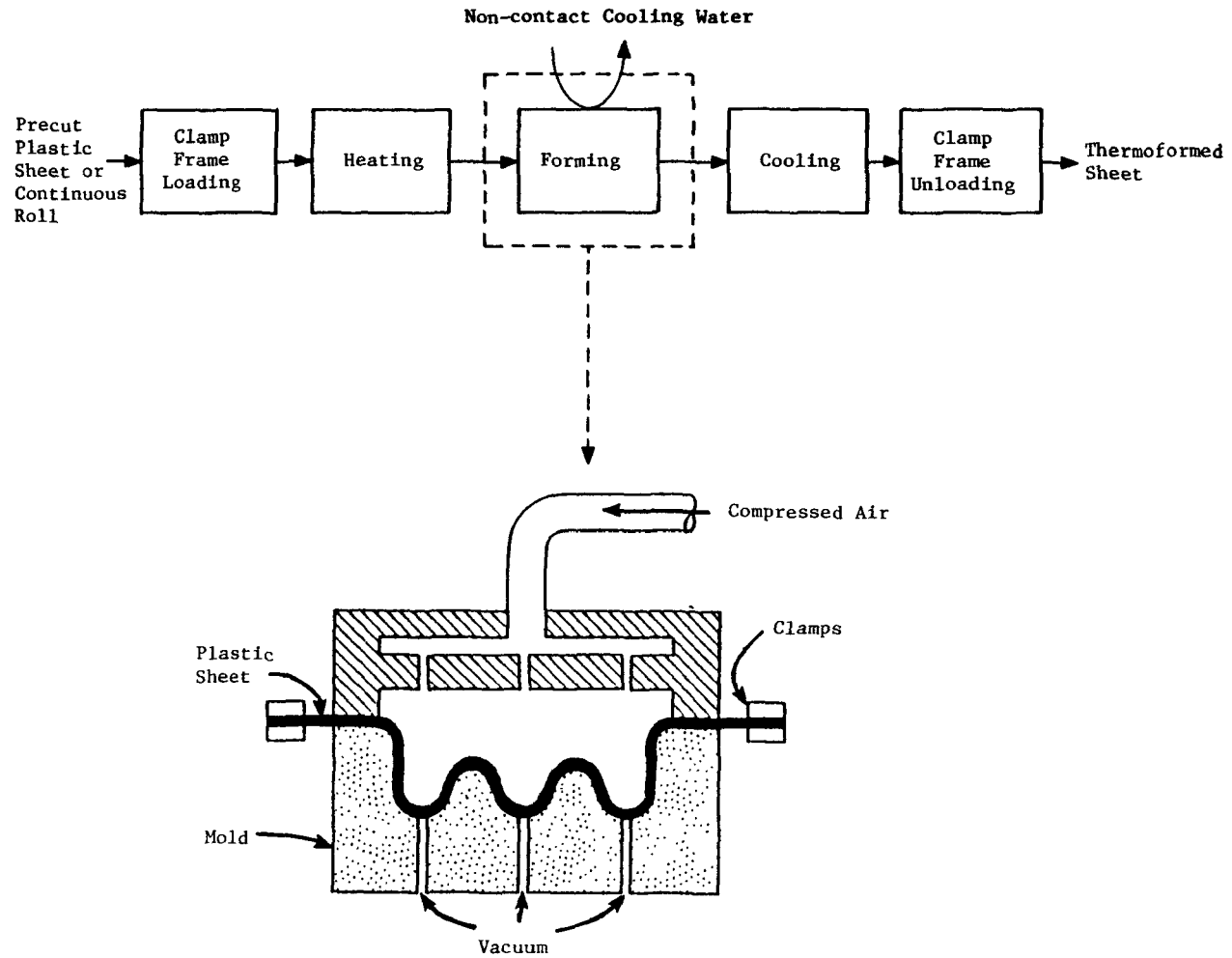

Source: Adapted from Masson, D. (ed). The Study of the Plastics Industry. 1973.

Figure IV-14  
THERMOFORMING PROCESS

Matched Mold Forming. Matched mold forming is used to produce products requiring excellent reproduction detail. The heated sheet material is placed between convex and concave mold halves. The halves are brought together, thereby forming the sheet into the mold shape.

Most thermoforming processes use non-contact cooling water. However, in some instances, the thermoformed product may be spray cooled with water.

### Calendering Processes

Calendering is widely used in the plastics molding and forming category to produce uniform thickness film and sheet at high production rates. Calendering processes squeeze pliable thermoplastic between a series of rotating rolls to produce the polymer film and sheet, to emboss sheet and film, to perform compounding and to coat textiles and papers.

Flexible and rigid polyvinyl chloride compounds are the most commonly used input materials for the manufacture of calendered products. Typical products include building and construction supplies, packaging supplies, and consumer and institutional goods such as toys, seats, and coverings. Acrylonitrile-butadiene-styrene, polyethylene, and polystyrene are also used to produce various films.

A schematic of a calendering process is shown in Figure IV-15. Calendering processes generally consist of five units: mixing, calendering, cooling, take-off, and trimming. The thermoplastic resin and the appropriate additives are transferred from storage facilities through a sieve to a high shear mixer or mill where heat is supplied to soften and blend the polymer mix. The polymer is then fed to the calendering unit, which usually consists of three to five heated cast iron rolls that squeeze the softened polymer into a sheet or film of desired width and thickness. The arrangement of the calender rolls is determined by the product requirements as are the number of rolls and the roll spacings. The clearance between rolls is progressively decreased to slowly reduce the thickness and increase the width of the sheet or film. Most roll arrangements are adjustable to allow versatility in production methods. Newly calendered sheet is cooled by feeding the sheet or film through a series of two to ten cooling rolls cooled with non-contact cooling water. The take-off rolls feed the sheet and film to edge trimming operations, further finishing operations, or roll-up.

Calendering is also used to coat materials such as paper and fabric with a polymer. The process is similar to that described above except that fabric or paper is fed into the calendering



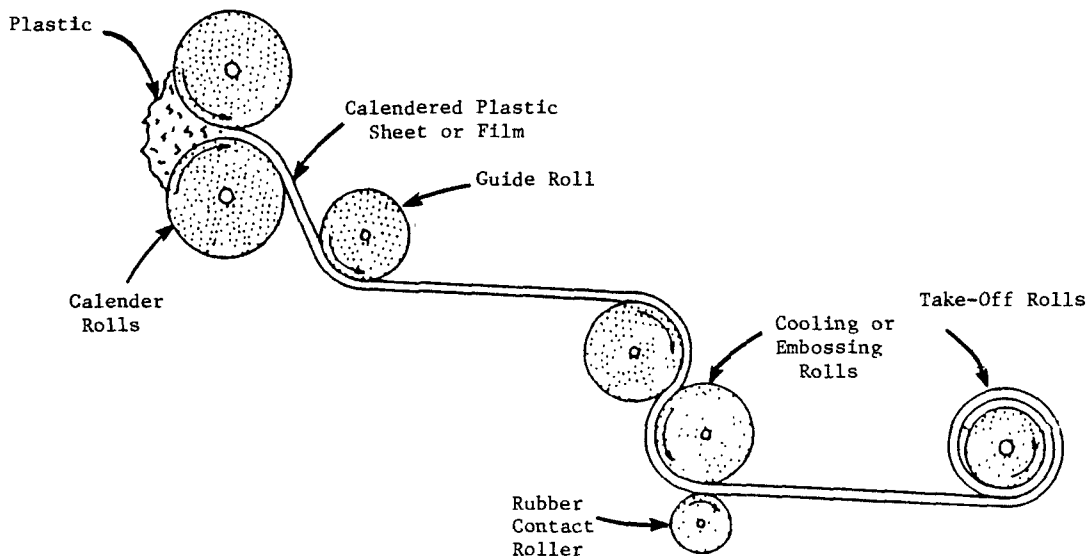
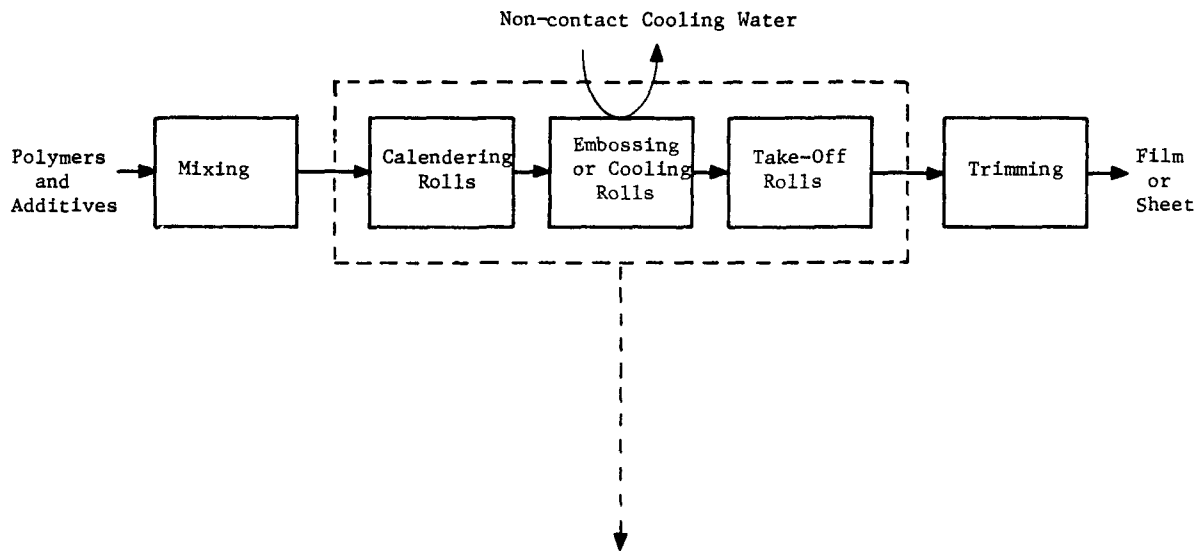

Source: Adapted from Masson, D. (ed). The Study of the Plastics Industry. 1973.

Figure IV-15  
CALENDERING PROCESS

rolls as the plastic film is formed. The plastic and fabric are tightly bonded together by the heat and force of the rolls and emerge from the cooling rolls as a single composite sheet.

Most calendering processes use non-contact water to cool the cooling rolls. Contact cooling water may be sprayed on both the plastic sheet and the rubber contact roller as the plastic sheet passes through the embossing rollers. Some calendering processes may also use contact cooling water to cool the newly formed sheet or film.

### Casting Processes

In the plastics molding and forming industry, the term casting is used rather loosely to describe a wide variety of processes. Casting involves liquid plastic materials allowed to cure at atmospheric pressure in a mold or on a mold surface.

Both thermoplastic and thermoset resins can be used in casting processes. Commonly cast thermoplastics include acrylics, nylons, and polyvinyl chlorides. Commonly cast thermosets include epoxy resins, polyesters, phenolics, and polyurethanes.

Fillers are often used in casting processes to produce reinforced plastic products such as boats and recreational vehicles, troughs, ducts, bins and tubs, as well as preforms for use in the compression molding of reinforced products.

There are seven types of casting processes: pot casting, slush casting, dip casting, cell casting, chilled film casting, solvent casting, and continuous casting. A schematic of pot, slush and dip, cell, solvent, and continuous casting processes is shown in Figure IV-16. The chilled film casting process is illustrated in Figure IV-17.

Pot Casting. Pot casting is the simplest form of casting and is used to produce a wide variety of products. Polymers used in pot casting include acrylic, alkyl resins, diallyl phthalate, epoxy, nylon, phenolic, polyester, polyurethane, and silicone elastomer. During pot casting a liquid polymer or a monomer solution is poured into an open mold where it is allowed to cure. The pot cast part is cured by the addition of heat in an oven, exothermically by means of a catalyst, or by a combination of both methods. Typical pot cast products include novelties, plaques, knobs, embedments, electrical encapsulations, optical products, bearings, gears, jewelry, billiard balls, seals and gaskets, housewares, and furniture parts.

Pot, Cell, Dip, and Slush Casting

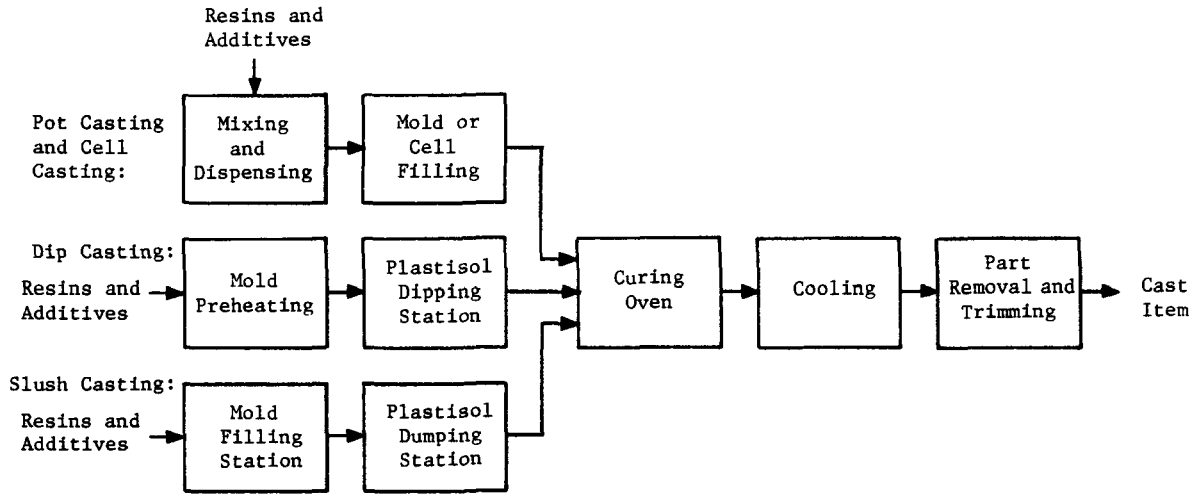

Solvent Casting

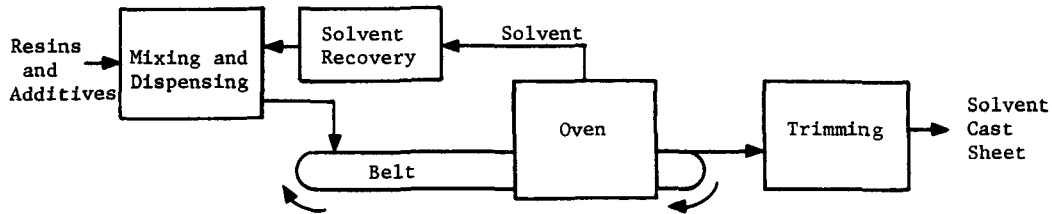

Continuous Casting

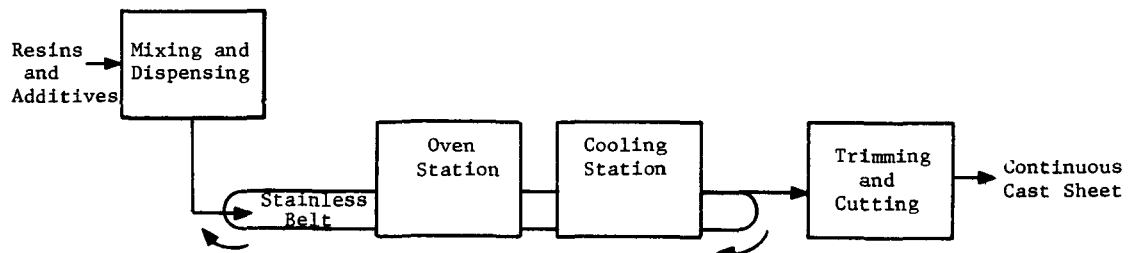

Figure IV-16  
CASTING PROCESSES

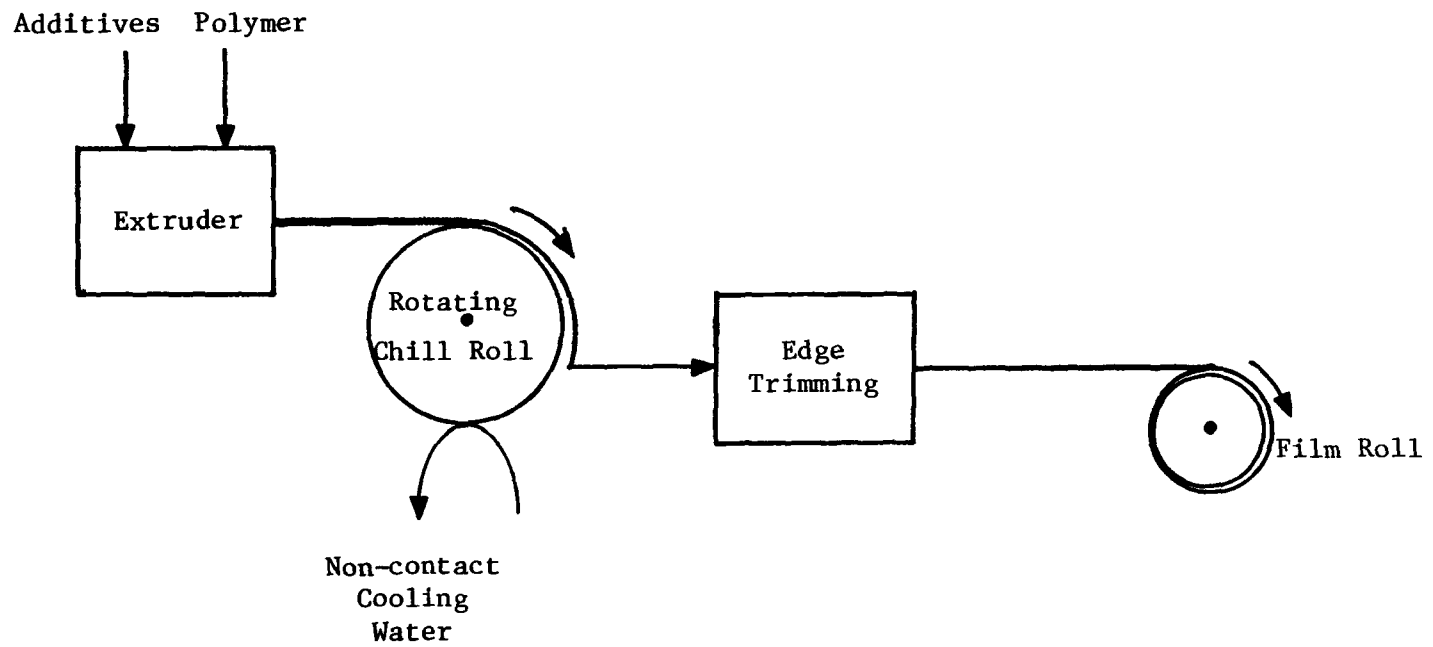

Figure IV-17  
CHILLED FILM CASTING PROCESS

Slush Casting and Dip Casting. Slush casting involves the use of liquid plastisol (fine particle polyvinyl chloride dispersed in plasticizers such as dioctyl phthalate). These plastisols are viscous at room temperature. A measured amount of plastisol is poured into a hollow mold that has been preheated. The mold is rotated quickly to cover all inside surfaces and after a specific period of time, excess plastisol is poured out into a storage vat for future reuse. The thickness of the hollow part is determined by the amount of time the plastisol remains in the mold. The mold is then placed in an oven and is heated for several minutes to complete fusion. Typical slush cast products include housewares, novelties, doll heads, fish lures, and toys.

In dip casting, a mold is preheated and dipped into a liquid plastisol. A polymer coating fuses around the mold during immersion. The coated mold is then placed in an oven to complete fusion. Typical dip cast products include novelties, boots, gloves, coin purses, and eye glass cases.

Cell Casting. Cell casting is used to produce sheet, tubes, and rods. Acrylic sheet is most commonly cell cast. A premeasured amount of liquid acrylic, consisting of a small amount of polymer in a monomer and additive solution, is poured between two sheets of polished or tempered plate glass that are slightly larger than the desired acrylic sheet product. The glass cell, which is held together by tubing and spring clips, is then placed horizontally in an oven for curing.

Chilled Film Casting. Chilled film casting is a casting process used to produce non-oriented, thin, polymer films. Thermoplastic materials such as polypropylene homopolymer, propylene-ethylene copolymer, and low density polyethylene are most commonly used to produce film. The most common form of chilled film casting is termed chill roll casting. In chill roll casting, the formulated polymer is extruded through a slot die onto a rotating, chilled, polished roll. The movement of the roll draws the molten resin away from the die without significantly stretching or orienting the film. The extrudate solidifies into a film as it passes over the chilled roll surface. The film is trimmed as necessary and wound onto rolls. Chill casting processes produce high clarity film products. Process water is not used during chill roll casting.

A less commonly used film casting process is termed tubular water bath casting. A thin-walled vertical tube of formulated polymer is extruded downward from a rotating circular die over a water cooled mandrel. The tube is quenched in contact cooling water and split open to form a film. The film is then trimmed and wound on rolls.

Solvent Casting. Solvent casting, often referred to as solution casting, is used for the production of film and sheet. Polyvinyl chloride (PVC) organosols are the most commonly used polymers for this process. Organosols are formed by dispersing finely powdered PVC in plasticizer and organic solvents. The solution is poured onto a rotating drum or an endless belt that passes through an oven. The solvent is evaporated in the oven in carefully programmed heat zones and a relatively solvent free polymer film leaves the oven.

Continuous Casting. Continuous casting processes produce thin continuous acrylic sheet. They are very similar to cell casting processes except that the liquid acrylic is cured between two highly polished moving stainless steel belts. The acrylic, trapped between the stainless belts, travels through the oven and air cooling stations.

Water may be used for the direct contact cooling of cast products. Direct contact cooling water sprays can be used in slush casting and in dip casting processes and in some pot casting processes. During tubular water bath casting, direct contact cooling water is used during the product quenching step.

#### Foam Processes

Foamed plastics (often called cellular or expanded plastics) are made by adding a blowing agent to thermoplastics or thermosets to form a spongelike material. Blowing agents are either added to the input material and vaporize due to heat or are generated as a by-product of a cure reaction. Plastic foam products have wide commercial use for flotation devices, packaging, cushioning, and insulation. Plastic foams can be either rigid or flexible. Foamed plastic products can be classified into one of three types: extruded thermoplastic foam, structural foam, and multi-component thermoset foam. The production of extruded thermoplastic foams is a variation of the extrusion process where either dry chemicals that foam when heated are included in the resin feed or a solvent blowing agent is injected into the polymer melt at the extrusion die. Structural foam molding is a variation of the injection molding process where chemical blowing agents or injected gases form bubbles in the molded product. Multicomponent thermoset foams are formed in a carefully controlled reaction injection molding (RIM) process where blowing agents are either generated as a by-product of the chemical reaction that takes place in the mold of a RIM process or added with the input materials and vaporized by the heat of reaction. Contact cooling water is generally not used during the molding and forming of these foamed products.

## Cleaning Processes

Parts produced by the various molding and forming processes may require cleaning to become useful end products.

Cleaning. Cleaning processes wash the surfaces of plastic products to remove residual mold release agents, processing chemicals, and other matter prior to finishing, shipping, or further processing. Cleaning is generally divided into two segments; a detergent wash cycle and a rinse cycle for the removal of detergents and other foreign matter. Generally, the level of sophistication of washing processes varies with the type of product being formed and the manufacturing steps that follow. Small novelty items requiring cleaning may simply be dunked and agitated in a bucket with the bucket dumped periodically. Larger items can be cleaned in the same manner in a tank. At the large manufacturing facilities, custom designed washing equipment may be employed. Two types of automated cleaning processes are used. In the first type, a batch of plastic products is loaded into a washing machine that operates cyclically. In the first cycle, plastic products are washed with detergent water; in subsequent cycles, the plastic products are rinsed. When the wash-rinse cycle is complete, the plastic products are removed from the machine and the whole process is repeated with a new batch of products. The other type of automated washing process is a continuous staged process. The products to be cleaned are conveyed through a detergent wash stage and then through a rinse stage.

Depending on the degree of cleaning required for a final application or further processing, the cleaning process may actually employ several rinse cycles or stages. For instance, cleaning processes used to prepare surfaces for painting generally include a deionized water rinse as a final step.

Shaping equipment surfaces that contact the plastic product, such as molds and mandrels, may also be washed in a cleaning process.

## Finishing Processes

Products produced by the various molding and forming processes may also require finishing to render the final product useful.

Finishing. There are three general finishing processes: machining, decorating, and assembling. Machining is used to drill, cut, mill, and otherwise shape products to match final product specifications. Decorative finishes are applied to plastic parts by a variety of methods including painting, printing, hot stamping, and vacuum metallizing. Assembling involves

joining two or more plastic parts by methods such as solvent welding, ultrasonic welding, and electronic heat sealing. Process water is often used in finishing processes as a lubricant and carrier of waste particulates generated by machining processes. Decorating and assembling are dry operations.



SECTION V  
SUBCATEGORIZATION

BASIS FOR SUBCATEGORIZATION SCHEME

In developing the final regulation for the plastics molding and forming category, the Agency considered whether different effluent limitations guidelines and standards are appropriate for different segments of the industry. The Act allows EPA to consider a number of factors to determine if subcategorization is needed. These factors are:

1. raw materials;
2. production processes;
3. products;
4. size and age of plants;
5. geographic location;
6. type of water use; and
7. wastewater characteristics.

The Agency determined whether any of these individual factors identified a need to subcategorize the PM&F category. The Agency also evaluated the relationship between different factors to identify a need for subcategorization. A discussion of each factor is presented below. After considering all these factors, the Agency determined that the plastics molding and forming category is most appropriately regulated using three subcategories.

FACTORS CONSIDERED

Raw Materials

The raw materials used in the plastics molding and forming category can be classified as:

- plastics and resins;
- chemical additives; and
- processing aids.

The type and combination of raw materials used in plastics molding and forming are highly dependent on the production process used and the end products desired. Plastics molders and formers can use many different raw material combinations to produce different end products at one production plant over a given period of time. Many different raw materials may also be used in any one type of PM&F process.

The concentration of pollutants in PM&F process waters varies because of the raw materials used. However, the types of pollutants in these process waters are similar regardless of the material processed. This is illustrated by reviewing the sampling data base presented in Appendix A. For cleaning process waters, the priority pollutant phenol was found in concentrations ranging from 0.002 mg/l to 6.0 mg/l in eight of the 13 cleaning water processes sampled. The 6.0 mg/l concentration was found in process water used to clean the surfaces of equipment that process phenolic resin. The 0.002 mg/l was found in process water used to wash and rinse a polyurethane product. The range in phenol concentrations for those two processes can be explained by the raw material processed. However, the range in pollutant concentration does not prevent both process waters from being treated in the same type of treatment technology. This situation is also illustrated in the data bases for the contact cooling and heating water processes and for the finishing water processes. Therefore, a subcategorization scheme based on raw materials is not needed to ensure equitable effluent limitations guidelines and standards for the PM&F category. Further, due to the proprietary nature of the raw material combinations and the varying requirements for product quality, particularly when different raw materials are processed in the same PM&F process, the Agency believes that a subcategorization scheme based on raw materials is not feasible for the PM&F category.

#### Production Processes

There are nine different generic production processes used in the plastics molding and forming category. They are:

1. extrusion;
2. molding;
3. coating and laminating;
4. thermoforming;
5. calendering;
6. casting;
7. foaming;
8. cleaning; and
9. finishing.

Each of the above processes may use process water (i.e., water that contacts the plastic product). Process water is used in the first seven processes to cool or heat plastic materials and plastic products. Process water is used in cleaning processes to clean surfaces of plastic products and to clean shaping equipment surfaces; it is used in finishing processes to finish plastic products.

As indicated in the section on raw materials, sampling data presented in Appendix A indicate that the pollutants found in process waters for PM&F processes that cool or heat a plastic product (i.e., the first seven processes listed above) are similar even though the pollutant concentrations may vary. Therefore, the Agency believes that there is nothing about the different contact cooling and heating processes that significantly affects the development of equitable effluent limitations guidelines for those processes. For this reason, PM&F contact cooling and heating water processes can be addressed as a group with respect to effluent limitations guidelines and standards.

Sampling data for cleaning water processes and finishing water processes indicate that the pollutants in those two process waters are different. Those data also indicate that the pollutants in contact cooling and heating waters are different from the pollutants in either cleaning process waters or finishing process waters. For these reasons, the Agency considered three types of PM&F processes (i.e., contact cooling and heating water processes, cleaning water processes, and finishing water processes) further as the basis to subcategorize the PM&F category so that equitable effluent limitations guidelines and standards could be developed.

#### Products Produced

An extremely wide range of products are produced in the plastics molding and forming category. The products can be classified according to the following types:

1. packaging materials;
2. building and construction components;
3. consumer and institutional products;
4. electrical and electronics products;
5. appliances;
6. transportation products;
7. furniture;
8. industrial equipment; and
9. intermediate products.

Products within any given product type can generally be manufactured from several different plastic materials and in several different production processes. In addition, any given plant may produce a wide range of products falling into many of the above product types. The amount and type of pollutants discharged by those processes are not directly related to the type of product produced. Thus, a subcategorization scheme based on product type is not needed to ensure the development of equitable effluent limitations guidelines and standards for the PM&F category.

### Size and Age of Plants

The number of employees and amount of production can be used to measure relative sizes of PM&F plants. However, neither factor provides an adequate basis for subcategorization.

The amount of wastewater discharged and the types of pollutants in the wastewater are largely independent of the number of plant employees. Variations in staff occur for many reasons including shift differences, the need for clerical and administrative support, the need for maintenance support, efficiency of plant operations, and market fluctuations. Due to these and other factors, the number of employees is constantly fluctuating. The Agency found no correlation between the number of employees at a PM&F plant and the number and range of concentrations of pollutants in wastewater discharged from PM&F processes at a plant. Therefore, a subcategorization scheme based on the number of employees at a plant is not appropriate for the PM&F category.

While plant production can be used to approximate the mass of pollutants generated, the Agency has determined that it should not be used to establish different effluent limitations guidelines and standards for the plastics molding and forming category for the following reasons:

1. The types of PM&F processes used and the characteristics of the wastewater discharged from those processes are not dependent on the total plant production.
2. While the amount of production affects the total mass of pollutants discharged, it has little effect on the types and range of concentrations of pollutants found in the wastewater. Therefore, there is little, if any, difference between the type of treatment technology required at small and large PM&F plants where process water is treated and discharged.

The plastics molding and forming industry is a relatively new industry that developed following the development of the polymer and resins formulating industry. To remain competitive in an industry that has steadily made technological improvements over the past 30 years, PM&F plants have been continually modernized. Thus, because most PM&F plants were built in the same general time frame and are continually modernized, neither plant age nor equipment age is a significant factor that requires subcategorization to ensure equitable effluent limitations guidelines and standards.

## Geographic Location

Plastics molding and forming plants are not limited to any one geographical location and are generally located near distribution and sales centers so that the finished products need not be transported over long distances. A large percentage of molding and forming plants are located in the four geographical clusters of (1) New Jersey, New York, and Pennsylvania; (2) Illinois, Indiana, Michigan, and Ohio; (3) Louisiana, Oklahoma, and Texas; and (4) California and Washington.

There are no specific geographical factors that significantly affect water use at PM&F plants or characteristics of PM&F process waters. The physical space required for the treatment systems evaluated for the PM&F regulation is small compared to the overall plant size. Therefore, there are no consequences from the construction and operation of a wastewater treatment system peculiar to the different geographical areas. For these reasons, the Agency believes there is no need to subcategorize the PM&F category based on geographic location.

## Types of Water Use

Results of the questionnaire surveys and the sampling programs for the PM&F regulation indicate that there are basically three types of process water used by processes in the PM&F category. They are:

1. contact cooling and heating water,
2. cleaning water, and
3. finishing water.

Contact cooling and heating water is used to either cool or heat plastic materials or plastic products. Water can be sprayed onto a product or the product can be drawn through a water bath. In either case, the water is used for heat transfer.

Cleaning water is used to clean the surfaces of plastic products or to clean shaping equipment surfaces that are or have been in contact with the plastic product. It includes water used in the washing and rinsing cycles of a cleaning process.

Finishing water is used to finish plastic products. It includes water used either to carry away waste plastic materials during a finishing operation or to lubricate a plastic product during finishing.

Sampling data indicate that the type and concentration of pollutants in PM&F process waters vary depending on how process water is used. Therefore, the development of equitable effluent

limitations guidelines and standards for the PM&F category may be influenced by how the process water is used. For this reason, the Agency gave further consideration to type of water used as the basis for the PM&F subcategorization scheme.

#### Wastewater Characteristics

Results of the sampling programs for this regulation indicate that contact cooling and heating waters, cleaning waters, and finishing waters have different pollutant characteristics. Only one pollutant (i.e., bis(2-ethylhexyl) phthalate) was found in a treatable concentration in contact cooling and heating waters. Cleaning waters have treatable concentrations of three conventional pollutants, three nonconventional pollutants, and two priority toxic pollutants. Finishing waters have treatable concentrations of one conventional pollutant (i.e., TSS) and three priority pollutants. These different pollutants severely impact the development of equitable effluent limitations guidelines and standards for the PM&F category. Therefore, wastewater characteristics were considered further as the basis for the PM&F subcategorization scheme.

#### SELECTED SUBCATEGORIZATION SCHEME

The subcategorization scheme for the PM&F category is based on three types of production processes, water use, and wastewater characteristics. The three types of production processes are contact cooling and heating water processes, cleaning water processes, and finishing water processes. The water use (i.e., heat transfer, cleaning, or finishing) for those three types of processes influence the wastewater characteristics of the process water. All three factors influence the development of equitable effluent limitations guidelines and standards for the PM&F category.

The three subcategories for the PM&F category are:

1. contact cooling and heating water subcategory,
2. cleaning water subcategory, and
3. finishing water subcategory.

The contact cooling and heating water subcategory includes PM&F processes in which process water contacts plastic materials for the purpose of heat transfer. Processes that use process water to clean the surfaces of plastic products or to clean shaping equipment surfaces that are or have been in contact with the plastic product are included in the cleaning water subcategory. The finishing water subcategory includes PM&F processes that use process water during the finishing operation.

One advantage of this subcategorization scheme is that plants can easily identify the type of water used in their PM&F processes. Having only three subcategories should also make it less complicated for the permit writer to write permits for PM&F plants.

#### APPLICABILITY

The PM&F effluent limitations guidelines and standards apply to processes that blend, mold, form, or otherwise process intermediate or final plastic products and that discharge process water. Some molding and forming processes (e.g., extrusion and pelletizing) are used by plastic resin manufacturers to process crude intermediate plastic material. For the purpose of the PM&F regulation, plastic molding and forming processes used by plastic resin manufacturers to process crude intermediate plastic materials for shipment off-site are excluded from the PM&F regulation and regulated under the organic chemicals, plastics, and synthetic fibers category. Plastic molding and forming processes used by plastic resin manufacturers to process crude intermediate plastic materials that are processed on-site into intermediate or final plastic products by molding and forming are controlled by the effluent limitations guidelines and standards for the PM&F category. For example, a plant may manufacture a polyurethane resin. To prepare the resin for shipment, the manufacturer may extrude the resin and then pelletize it. If the polyurethane pellet is shipped off-site, the extrusion process is subject to the effluent limitations guidelines and standards for the organic chemicals, plastics, and synthetic fibers category. If the polyurethane pellet is further processed on-site in a molding and forming process, that process and the extrusion process used to obtain the pellet are subject to the PM&F effluent limitations guidelines and standards.

In several instances, particular PM&F processes and the wastewater generated by these processes may fall within this and other industrial categories for which the Agency has established effluent limitations guidelines and standards. Thus, for the purpose of regulatory coverage, the Agency has separated each process to ensure that it is clearly subject to one set of effluent limitations guidelines and standards. Processes that coat a plastic material onto a substrate may fall within the definition of electroplating and metal finishing as defined in 40 CFR Parts 413 and 433 (see 48 FR 32485; July 15, 1983). These coating operations are excluded from the effluent limitations guidelines and standards for the electroplating and metal finishing point source category and are subject to the PM&F effluent limitations guidelines and standards.

Coating of plastic material onto a formed metal substrate is also covered by the PM&F effluent limitations guidelines and standards

and is not covered by the specific metal forming effluent limitations guidelines such as those for aluminum forming (40 CFR Part 467 (48 FR 49126; October 24, 1983), copper forming (40 CFR Part 468 (48 FR 36942; August 15, 1983), and nonferrous metals forming (40 CFR Part 471 (proposed 49 FR 8112, March 5, 1984)). However, the PM&F regulation applies only to the coating process; the prior forming operations are subject to the specific metal forming regulation.

Some research and development (R&D) laboratories and technical centers produce low quantities of plastic products in PM&F processes. PM&F processes at R&D laboratories are subject to the PM&F effluent limitations guidelines and standards if they discharge process water. The PM&F regulation applies to PM&F processes that discharge process waters regardless of the mass of plastic products produced by a process. The Agency considered low production PM&F processes during the development of the final PM&F regulation because there are 24 processes in the Agency's data base with very low production rates (i.e., less than 10,000 pounds per year). Information from those processes was used with information from high production processes to characterize the PM&F category.

The PM&F regulation does not apply to wastewater generated during the reticulation of polyurethane foam. Reticulation can be done by either a chemical process or a thermal process. In the chemical process, the foam is passed through a bath of sodium hydroxide and then is quenched in a series of water baths to stop the chemical reaction. In thermal reticulation, the foam is reticulated by controlled explosions inside the foam structure. Products of combustion are removed from the foam by a vacuum pump and are absorbed in the water inside the pump. Process water used in chemical and thermal reticulation is not cooling water because it is not used for heat transfer; it is not cleaning water because it does not clean the surface of either the plastic product or the equipment that contacts the plastic product; and it is not finishing water because the process water is not used to finish a plastic product. For these reasons, the PM&F effluent limitations guidelines and standards do not apply to the processes that reticulate polyurethane foam. Those processes are addressed in the effluent limitations guidelines and standards for the organic chemicals, plastics, and synthetic fibers category. If the reticulated foam is further processed in a molding and forming process, that process is subject to the PM&F regulation.

The final regulation does not apply to processes used to produce regenerated cellulose for two reasons. First, cellulose is a natural organic material, not a "plastic material" as defined by EPA. In the final PM&F regulation, a plastic material is defined as "a synthetic organic polymer . . ." [emphasis added]. Second,



the final step in the xanthate process used to regenerate cellulose is to wash the regenerated cellulose to remove dissolved salts and sulfur compounds from within the cellulose. Process water used in this final step is not cleaning water as defined in the final PM&F regulation because it cleans more than just the surface of the regenerated cellulose. For these reasons, the manufacturing process for regenerated cellulose is not subject to the PM&F regulation. It is subject to the effluent limitations guidelines and standards for the organic chemicals, plastics, and synthetic fibers category.

Similarly, the final PM&F regulation also does not apply to molding and forming operations that process regenerated cellulose because regenerated cellulose is not a plastic material as defined in the final PM&F regulation. The regulation does apply, however, to molding and forming processes that use cellulose derivatives (e.g., cellulose acetate), which are plastic materials as defined in the final PM&F regulation.

Wastewater is generated by the solvent recovery operation in the solution or solvent casting process. However, this wastewater does not result from the blending, molding, forming, or any processing of the plastic material and is not a process water. It is generated when steam condensate from the solvent casting process is distilled to recover acetone. Data from the analysis of samples of this wastewater indicate that its pollutant characteristics are different from the characteristics of PM&F process waters. In addition, the Agency estimates that only eight plants in the category generate solvent recovery wastewater. For these reasons, the Agency believes that solvent recovery wastewater is best controlled on a case-by-case basis by the permit writer or control authority. Analytical data for this type of wastewater are presented in Appendix A of this technical development document and may be used as a guide by the permit writer or control authority.

Plants in the PM&F category may have processes generating only one type of wastewater and thus fit within one subcategory. However, many plants generate contact cooling and heating water, cleaning water, and finishing water. In this instance, plants must comply with the effluent limitations guidelines and standards for each subcategory.



## SECTION VI

### WATER USE AND WASTEWATER CHARACTERISTICS

This section discusses the water use and wastewater discharge practices for the PM&F category and presents the wastewater treatment technologies currently used by PM&F plants. Data used to characterize PM&F process waters are also presented in this section. The data were obtained from two sources:

1. questionnaires and
2. sampling and analysis programs.

#### QUESTIONNAIRE DATA

From the survey data base for this project described in Section IV, statistics were developed to apply to the plastics molding and forming plants that use process water. The data base contains questionnaires from 382 plants: 175 questionnaires are from the 1979 survey and 207 questionnaires are from the 1983 survey.

The 382 questionnaires were reviewed and summarized to determine the discharge mode (i.e., direct, indirect, or zero discharge) for PM&F processes. Table VI-1 contains a distribution of the 521 wet processes reported in the questionnaires by discharge mode for the types of process waters generated. As shown in the table, 31 percent of these processes are direct dischargers, 44 percent are indirect dischargers, and 25 percent have no discharge.

Table VI-2 presents the average operating hours, average production, and the average water use and discharge rates by subcategory for the different types of dischargers. The averages were calculated by summing the data for processes within a subcategory by discharge mode and dividing by the number of processes with the discharge mode. Average water use and discharge rates are given in both liters per hour and liters per year.

Table VI-3 contains a distribution of the number of wet processes in the questionnaire data base that have no discharge by the method used to obtain no discharge.

The 382 questionnaires were also reviewed to determine the treatment technologies currently used by plants in the PM&F category. A summary of those treatment technologies is presented in Table VI-4. The 17 plants listed in the table are plants where a significant portion (i.e., 50 percent or more) of the wastewater treated is from PM&F processes. Only 10 of those plants have

Table VI-1

DISCHARGE MODE FOR WET PROCESSES IN QUESTIONNAIRE DATA BASE\*

<u>Type of Process Water</u>	<u>Discharge Mode</u>						<u>Total</u>	<u>Percent</u>
	<u>Direct</u>	<u>Percent†</u>	<u>Indirect</u>	<u>Percent†</u>	<u>Zero</u>	<u>Percent†</u>		
Contact Cooling and Heating Water	140	32.7	170	39.7	118	27.6	428	100
Cleaning Water	21	29.6	47	66.2	3	4.2	71	100
Finishing Water	<u>2</u>	9.1	<u>14</u>	63.6	<u>6</u>	27.3	<u>22</u>	100
TOTAL	163	31.3	231	44.3	127	24.4	521	100

92

---

\*Based on information from 1979 and 1983 questionnaire surveys.

†Percent for type of process water.

Table VI-2

## QUESTIONNAIRE DATA BASE INFORMATION\*

	Average Operating Hours Per Year	Average Plastic Production (kkg/yr)	Average Process Water Use		Average Process Water Discharge	
			(l/hr)	(l/yr)	(l/hr)	(l/yr)
<u>Contact Cooling and Heating Water Processes</u>						
Direct Dischargers	5,870	6,290	26,600	178,000,000	5,450	33,000,000
Indirect Dischargers	4,610	2,480	14,500	92,800,000	3,180	18,300,000
Zero Dischargers	5,210	3,160	23,200	146,000,000	0	0
<u>Cleaning Water Processes</u>						
Direct Dischargers	5,790	3,150	11,800	63,500,000	3,860	30,700,000
Indirect Dischargers	3,900	1,390	10,900	41,000,000	1,780	7,670,000
Zero Dischargers	6,930	3,110	600	5,280,000	0	0
<u>Finishing Water Processes</u>						
Direct Dischargers	4,000	46	715	2,490,000	715	2,490,000
Indirect Dischargers	3,580	2,200	2,730	7,160,000	1,590	3,800,000
Zero Dischargers	3,540	1,670	20,200	76,600,000	0	0

\*Based on information obtained from the 1979 and 1983 questionnaire surveys.

Table VI-3

DISTRIBUTION OF NUMBER OF PROCESSES IN QUESTIONNAIRE  
DATA BASE WITH ZERO DISCHARGE\*

<u>Zero Discharge Method</u>	<u>Contact Cooling and Heating Water</u>	<u>Cleaning Water</u>	<u>Finishing Water</u>
100 Percent Recycle	83	0	3
Ponded for Evaporation	5	0	1
Septic Tank With Leach Field	10	2	0
Evaporation From Process Equipment	10	0	1
Land Application	9	0	0
Contract Haul	<u>1</u>	<u>1</u>	<u>1</u>
TOTAL	118	3	6

76

---

\*Based on information obtained from the 1979 and 1983 questionnaire surveys.

Table VI-4

## PM&amp;F TREATMENT TECHNOLOGIES SUMMARY\*

Plant ID	Discharge Mode	% PM&F Process Water	Treatment Technologies													
			pH Adjustment	Equalization	Oil Skimming	Solids Skimming	Filtration	Aeration	API Separator	Clarifier	Settling	Chlorinator	Activated Sludge	Carbon Adsorption	Coagulant Addition	Sludge or Solids Removal
640	Direct	100			X	X	X					X				
602195C	Direct	100								X						
564076A	Direct	100	X									X				
1400	Direct	99						X				X				
1420	Direct	88		X			X	X				X				X
1946	Direct	86	X									X				
29640A	Direct	81										X				
362544S	Direct	80					X	X				X				
580294E	Direct	61						X				X				
1330	Direct	50	X	X		X	X			X		X	X			X
583	Indirect	100					X					X				
1500	Indirect	100	X									X				X
2722	Indirect	100	X											X		
10290	Indirect	100					X									
10650	Indirect	100	X													
2500	Indirect	100	X	X			X									
480	Zero	100		X							X					X
TOTAL			7	4	1	2	7	4	1	2	9	1	1	1	1	4

\*Based on information reported in 1979 and 1983 questionnaire surveys.

treatment technologies that treat only PM&F process water. The other plants have treatment technologies that treat process water from PM&F processes with wastewater from other industrial processes. The 17 plants where a significant portion of the wastewater treated is from PM&F processes are only four percent of the plants in the data base. The other 96 percent of the plants are zero dischargers, had no treatment technology, or are plants where more than 50 percent of the wastewater treated was discharged by processes other than PM&F processes.

Of the 521 wet PM&F processes in the combined data base, 201 recycle process water. Table VI-5 contains a distribution of the number of processes that recycle process water by discharge mode. As shown in the table, 48 percent of those processes do not discharge process water, 23 percent are direct dischargers, and 28 percent are indirect dischargers.

The contact cooling and heating water subcategory was analyzed to determine the types of plastics molding and forming processes in the subcategory. Table VI-6 presents results of this analysis. As shown in the table, extrusion processes comprise the majority of processes in the subcategory with 85.0 percent. The next predominate type of process is molding with 7.5 percent. These two types of processes are 92.5 percent of the processes in this subcategory. The remaining four types of processes (i.e., calendering, casting, coating and laminating, and thermoforming) make up the remaining 7.5 percent.

#### PM&F Category Data

The 382 plants in the questionnaire data are distributed with respect to the processes that use a specific type of process water in the following manner:

1. Three hundred fifteen plants (82.5 percent) have processes using only contact cooling and heating water;
2. Twenty-six plants (6.8 percent) have processes using only cleaning water;
3. Nine plants (2.3 percent) have processes using only finishing water;
4. Twenty plants (5.2 percent) have processes that use contact cooling and heating water and processes that use cleaning water;
5. Five plants (1.3 percent) have processes that use contact cooling and heating water and processes that use finishing water;



Table VI-5 -

DISCHARGE MODE FOR PROCESSES IN QUESTIONNAIRE DATA BASE THAT RECYCLE PROCESS WATER\*

<u>Type of Process Water</u>	<u>Discharge Mode</u>						<u>Total</u>	<u>Percent</u>
	<u>Direct</u> <sup>§</sup>	<u>Percent</u> <sup>†</sup>	<u>Indirect</u>	<u>Percent</u> <sup>†</sup>	<u>Zero</u>	<u>Percent</u> <sup>†</sup>		
Contact Cooling and Heating Water	44	23.4	50	26.6	94	50	188	100
Cleaning Water	3	33.3	6	66.7	0	0	9	100
Finishing Water	<u>0</u>	0	<u>1</u>	25.0	<u>3</u>	75.0	<u>4</u>	100
TOTAL	47	23.4	57	28.4	97	48.2	201	100

97

---

\*Based on information from 1979 and 1983 questionnaire surveys.

§Direct and indirect discharge processes have a continuous or intermittent bleed or discharge from the recycle unit.

†Percent for type of process water.

Table VI-6

DISTRIBUTION OF NUMBER OF PROCESSES IN THE CONTACT COOLING AND HEATING WATER SUBCATEGORY  
BY TYPE OF PROCESS AND DISCHARGE MODE

Type of Process	<u>Direct Discharge</u>	<u>Percent*</u>	<u>Indirect Discharge</u>	<u>Percent*</u>	<u>Zero Discharge</u>	<u>Percent*</u>	<u>Total</u>	<u>Percent*</u>
Calendering	1	0.8	2	1.2	0	0	3	0.7
Casting	1	0.8	5	2.9	0	0	6	1.4
Coating and Laminating	2	1.4	7	4.1	4	3.4	13	3.1
Extrusion	127	90.7	132	77.7	105	89.0	364	85.0
86 Molding	6	4.2	18	10.6	8	6.8	32	7.5
Thermoforming	<u>3</u>	<u>2.1</u>	<u>6</u>	<u>3.5</u>	<u>1</u>	<u>0.8</u>	<u>10</u>	<u>2.3</u>
TOTAL	140	100.0	170	100.0	118	100.0	428	100.0

---

\*Percent of all types of processes in a discharge mode.

6. Six plants (1.6 percent) have processes that use cleaning water and processes that use finishing water; and
7. One plant (0.3 percent) has a process that uses contact cooling and heating water, a process that uses cleaning water, and a process that uses finishing water.

Based on that information, 341 plants (315 + 20 + 5 + 1) have processes that use contact cooling and heating water, 53 plants have processes that use cleaning water (26 + 20 + 6 + 1), and 21 plants (9 + 5 + 6 + 1) have processes that use finishing water.

Estimate of Number of Plants and Processes in PM&F Category That Use Process Water

The process and plant information listed above from the questionnaire data base was applied to the estimated 1,898 wet plants in the PM&F category to obtain an estimate of the number of wet plants and processes in each subcategory. The means of arriving at the estimate of 1,898 wet plants is presented in Section IV. The calculations for the category plant estimate are:

- (1,898 category wet plants) (0.825) = 1,569 plants with processes that use only contact cooling and heating water
- (1,898 category wet plants) (0.068) = 129 plants with processes that use only cleaning water
- (1,898 category wet plants) (0.023) = 43 plants with processes that use only finishing water
- (1,898 category wet plants) (0.052) = 98 plants with processes that use contact cooling and heating water and processes that use cleaning water
- (1,898 category wet plants) (0.013) = 24 plants with processes that use contact cooling and heating water and processes that use finishing water
- (1,898 category wet plants) (0.016) = 30 plants with processes that use cleaning water and processes that use finishing water

(1,898 category wet plants) (0.003) = 5 plants with processes that use contact cooling and heating water, processes that use cleaning water, and processes that use finishing water

This equates to 1,696 plants (1,569 + 98 + 24 + 5) in the PM&F category with processes that use contact cooling and heating water, 262 plants (129 + 98 + 30 + 5) that use cleaning water, and 102 plants (43 + 24 + 30 + 5) that use finishing water. The total category wet process estimate is:

(1,696 category plants with processes that use contact cooling and heating water)	x	$\frac{(428 \text{ data base processes})}{(341 \text{ data base plants})}$	=	2,129 processes that use contact cooling and heating water
(262 category plants with processes that use cleaning water)	x	$\frac{(71 \text{ data base processes})}{(53 \text{ data base plants})}$	=	351 category processes that use cleaning water
(102 category plants with processes that use finishing water)	x	$\frac{(22 \text{ data base processes})}{(21 \text{ data base plants})}$	=	107 category processes that use finishing water

Applying the percentages for direct, indirect, and zero dischargers from Table VI-1 to the number of estimated processes gives an estimate number of processes by discharge mode. See Table VI-7 for this presentation.

#### Estimate of PM&F Category Process Water Use

The amount of process water use was estimated for each type of discharge mode (i.e., direct, indirect, and zero) in the PM&F category. The PM&F category uses approximately 308 billion liters (81 billion gallons) annually of process water. The following example for indirect dischargers illustrates the procedure used to estimate water use for the PM&F category.

To estimate the water use by indirect dischargers, the average amount of water used per year for each subcategory from the questionnaire data base was multiplied by the estimated number of indirect processes. These data are listed in Tables VI-2 and VI-7, respectively. The subcategory total amount of indirect water used was further divided into amounts discharged by plants with processes in only one subcategory, in two subcategories, and

Table VI-7

DISTRIBUTION OF THE NUMBER OF PM&F PROCESSES THAT USE PROCESS WATER  
BY TYPE OF PROCESS WATER AND DISCHARGE MODE

<u>Type of Process Water</u>	<u>Direct Dischargers</u>	<u>Indirect Dischargers</u>	<u>Zero Dischargers</u>	<u>Total</u>
Contact Cooling and Heating Water	696	845	588	2,129
Cleaning Water	104	232	15	351
Finishing Water	<u>10</u>	<u>68</u>	<u>29</u>	<u>107</u>
TOTAL	810	1,145	632	2,587

in three subcategories. For example, in the contact cooling and heating water subcategory questionnaire data base, indirect discharging processes are distributed as follows:

1. 90.0 percent of the contact cooling and heating water processes are at plants with only contact cooling and heating processes,
2. 7.1 percent of the contact cooling and heating water processes are at plants with contact cooling and heating water processes and cleaning processes,
3. 2.3 percent of contact cooling and heating water processes are at plants with contact cooling and heating water processes and finishing processes, and
4. 0.6 percent of contact cooling and heating water processes are at plants that have processes in the three subcategories.

These percentages were multiplied by the total amount of contact cooling and heating water used by indirect dischargers to calculate the amount of contact cooling and heating water used by indirect dischargers at the above listed combinations of processes. The same calculations were done for the cleaning water subcategory and for the finishing water subcategory. Table VI-8 summarizes the water use for the possible combinations. Likewise, water use was calculated for both the direct and zero dischargers. Tables VI-9 and VI-10 present the water use information for those discharge modes.

#### Estimate of PM&F Category Process Water Discharged

The amount of water discharged by PM&F processes was estimated for direct and indirect dischargers. The PM&F category discharges approximately 44 billion liters (12 billion gallons) annually of process water. The water discharge estimate was calculated in the same manner as the water use estimate, except that the average amount of water discharged from the questionnaire data base (presented in Table VI-2) was multiplied by the estimated number of processes. The distribution of process water discharged by plants with processes in one or more subcategories was calculated using the same percentages used to calculate the water use estimates. Tables VI-11 and VI-12, respectively, present the process water discharge information for direct and indirect dischargers.

#### SAMPLING PROGRAMS

This section discusses the sampling programs conducted during 1980, 1983, and 1984, and presents the results of the sample

Table VI-8

## DISTRIBUTION OF PM&amp;F WATER USE FOR INDIRECT DISCHARGERS

<u>Possible Process Combination</u>	Water Use by Indirect Dischargers (billion liters per year)			<u>Total</u>
	<u>Contact Cooling and Heating Water</u>	<u>Cleaning Water</u>	<u>Finishing Water</u>	
1. Contact Cooling and Heating Water Processes Only	70.6	---	---	70.6
2. Cleaning Water Processes Only	---	5.47	---	5.47
3. Finishing Water Processes Only	---	---	0.174	0.174
4. Contact Cooling and Heating Water and Cleaning Water Processes	5.57	2.84	---	8.41
5. Contact Cooling and Heating Water and Finishing Water Processes	1.80	---	0.139	1.94
6. Cleaning Water and Finishing Water Processes	---	1.01	0.139	1.15
7. Contact Cooling and Heating Water, Cleaning Water, and Finishing Water Processes	0.470	0.200	0.0346	0.705
TOTAL	78.4	9.52	0.487	88.4

Table VI-9

## DISTRIBUTION OF PM&amp;F WATER USE FOR DIRECT DISCHARGERS

<u>Possible Process Combination</u>	Water Use by Direct Dischargers (billion liters per year)			
	<u>Contact Cooling and Heating Water</u>	<u>Cleaning Water</u>	<u>Finishing Water</u>	<u>Total</u>
1. Contact Cooling and Heating Water Processes Only	112	---	---	112
2. Cleaning Water Processes Only	---	1.88	---	1.88
3. Finishing Water Processes Only	---	---	0	0
4. Contact Cooling and Heating Water and Cleaning Water Processes	12.4	3.76	---	16.2
5. Contact Cooling and Heating Water and Finishing Water Processes	0	---	0	0
6. Cleaning Water and Finishing Water Processes	---	0.942	0.0249	0.967
7. Contact Cooling and Heating Water, Cleaning Water, and Finishing Water Processes	0	0	0	0
TOTAL	124	6.58	0.0249	131



Table VI-10

## DISTRIBUTION OF PM&amp;F WATER USE FOR ZERO DISCHARGERS

<u>Possible Process Combination</u>	Water Use by Zero Dischargers (billion liters per year)			<u>Total</u>
	<u>Contact Cooling and Heating Water</u>	<u>Cleaning Water</u>	<u>Finishing Water</u>	
1. Contact Cooling and Heating Water Processes Only	84.4	---	---	84.4
2. Cleaning Water Processes Only	---	0.0528	---	0.0528
3. Finishing Water Processes Only	---	---	1.85	1.85
4. Contact Cooling and Heating Water and Cleaning Water Processes	0.730	0.0264	---	0.756
5. Contact Cooling and Heating Water and Finishing Water Processes	0.730	---	0.371	1.10
6. Cleaning Water and Finishing Water Processes	---	0	0	0
7. Contact Cooling and Heating Water, Cleaning Water, and Finishing Water Processes	0	0	0	0
TOTAL	85.9	0.0792	2.22	88.2

Table VI-11

## DISTRIBUTION OF PM&amp;F PROCESS WATER DISCHARGED BY INDIRECT DISCHARGERS

		Process Water Discharged by Indirect Dischargers (billion liters per year)			
<u>Possible Process Combination</u>		<u>Contact Cooling and Heating Water</u>	<u>Cleaning Water</u>	<u>Finishing Water</u>	<u>Total</u>
901	1. Contact Cooling and Heating Water Processes Only	13.9	---	---	13.9
	2. Cleaning Water Processes Only	---	1.02	---	1.02
	3. Finishing Water Processes Only	---	---	0.0921	0.0921
	4. Contact Cooling and Heating Water and Cleaning Water Processes	1.09	0.530	---	1.62
	5. Contact Cooling and Heating Water and Finishing Water Processes	0.354	---	0.0738	0.428
	6. Cleaning Water and Finishing Water Processes	---	0.189	0.0378	0.263
	7. Contact Cooling and Heating Water, Cleaning Water, and Finishing Water Processes	0.0924	0.0374	0.0183	0.148
TOTAL	15.4	1.78	0.258	17.4	

Table VI-12

## DISTRIBUTION OF PM&amp;F PROCESS WATER DISCHARGED BY DIRECT DISCHARGERS

<u>Possible Process Combination</u>	<u>Process Water Discharged by Direct Dischargers</u> <u>(billion liters per year)</u>			
	<u>Contact Cooling and Heating Water</u>	<u>Cleaning Water</u>	<u>Finishing Water</u>	<u>Total</u>
1. Contact Cooling and Heating Water Processes Only	21.0	---	---	21.0
2. Cleaning Water Processes Only	---	0.912	---	0.912
3. Finishing Water Processes Only	---	---	0	0
4. Contact Cooling and Heating Water and Cleaning Water Processes	2.33	1.82	---	4.15
5. Contact Cooling and Heating Water and Finishing Water Processes	0	---	0	0
6. Cleaning Water and Finishing Water Processes	---	0.456	0.0249	0.481
7. Contact Cooling and Heating Water, Cleaning Water, and Finishing Water Processes	0	0	0	0
TOTAL	23.3	3.19	0.0249	26.5

analyses. The results from the 1980 and 1983 sampling programs were used in developing the proposed PM&F effluent limitations guidelines and standards. The 1984 sampling effort results were incorporated with the results from the other efforts to evaluate comments and to develop the final PM&F effluent limitations guidelines and standards.

#### Plant Selection - Proposed Regulation

The sampling programs for the proposed PM&F regulation were undertaken to identify pollutants in the PM&F process waters. Samples were collected at plastics molding and forming plants and analyzed for conventional, selected nonconventional, and priority toxic pollutants.

Criteria used to select PM&F plants for sampling included the number and types of PM&F processes, water use and wastewater discharge practices, and differences in production processes and plastics materials used. The primary sources of this information were the questionnaire surveys. The Agency selected plants for sampling that represented a full range of PM&F processes and raw materials. Those plants usually had more than one PM&F process.

#### Field Sampling Programs - Proposed PM&F Regulation

After selection of candidate plants, each plant was contacted by telephone to verify their operations and to inform them that EPA had included them in the sampling program. Presampling site visits were conducted to identify sample locations, sampling conditions, and plant operations.

Eleven plants were sampled during the 1980 and 1983 episodes. Plants C, E, F, and I were sampled in 1980 and the remaining seven plants, A, B, D, G, H, J, and K, were sampled in 1983. Figures VI-1 through VI-11 present process water flow diagrams for the 11 plants indicating the location of the sample points.

The sampling data base for the proposed regulation contained data from 18 contact cooling and heating processes that were sampled at eight PM&F plants. Four different types of contact cooling and heating water processes were sampled at those plants (i.e., extrusion, molding, calendering, and thermoforming). Twelve cleaning processes were sampled at eight PM&F plants and one finishing process was sampled. These 13 processes were in the cleaning and finishing water subcategory for the proposed regulation.

Several changes were made to the pre-proposal sampling data base between proposal and promulgation. These changes include the following:

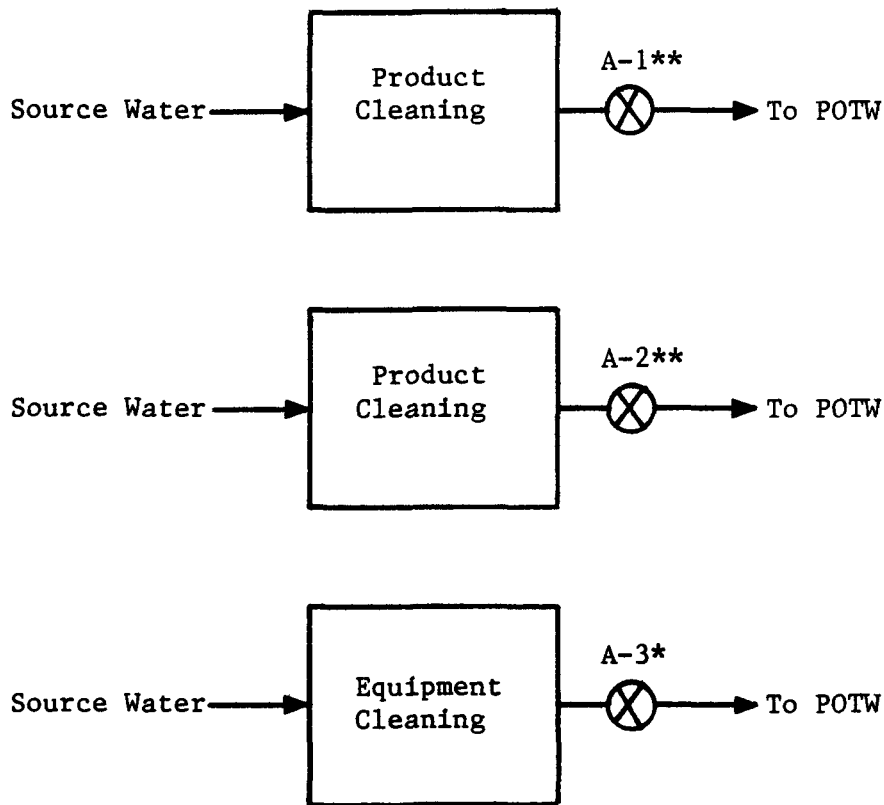

LEGEND:

 - Sample Point

 - PM&F Process

\*Data from this point were not used in data analysis because production data were not available for this process.

\*\*This is a batch process.

Figure VI-1  
SAMPLING POINTS AT PLANT A

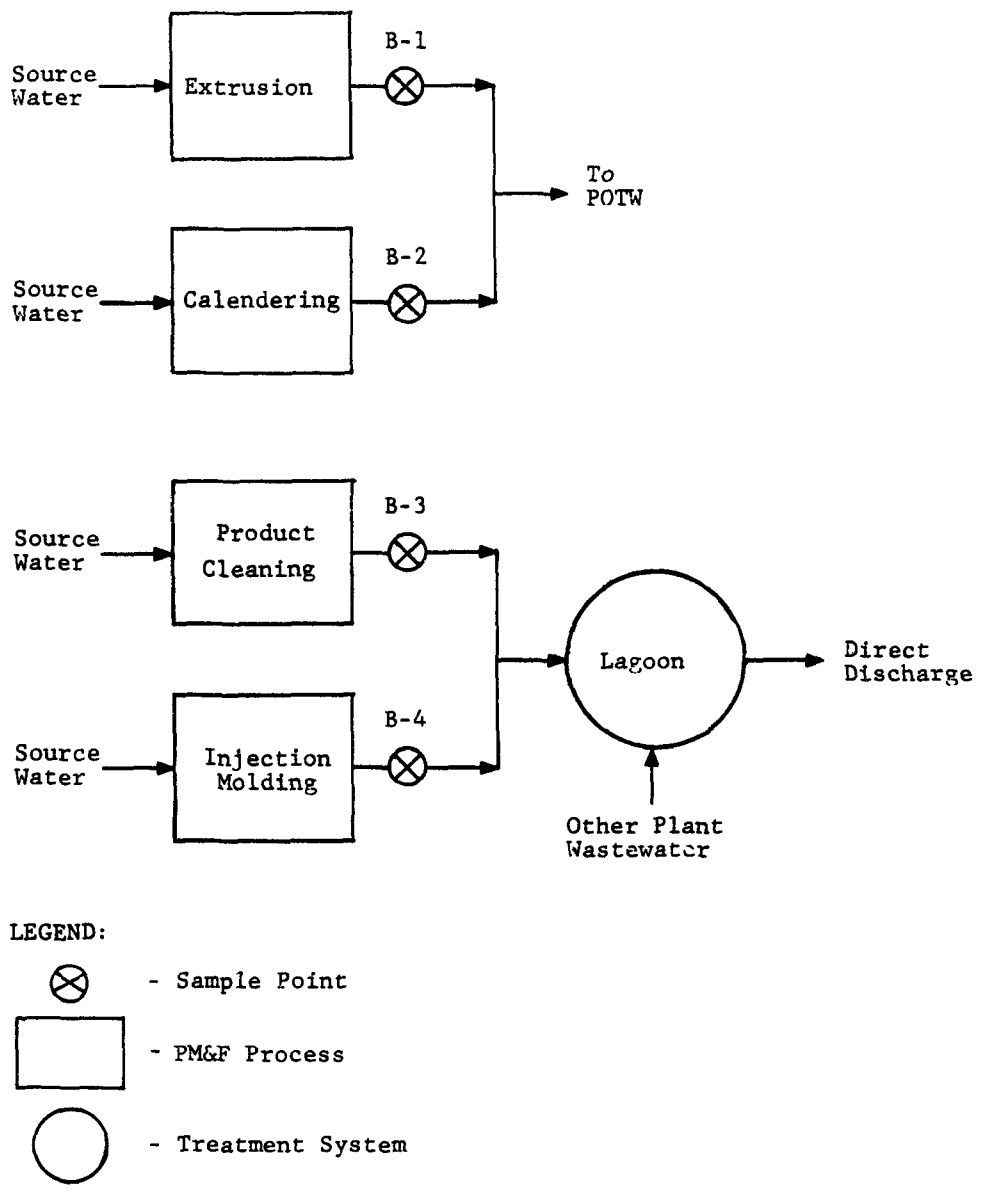
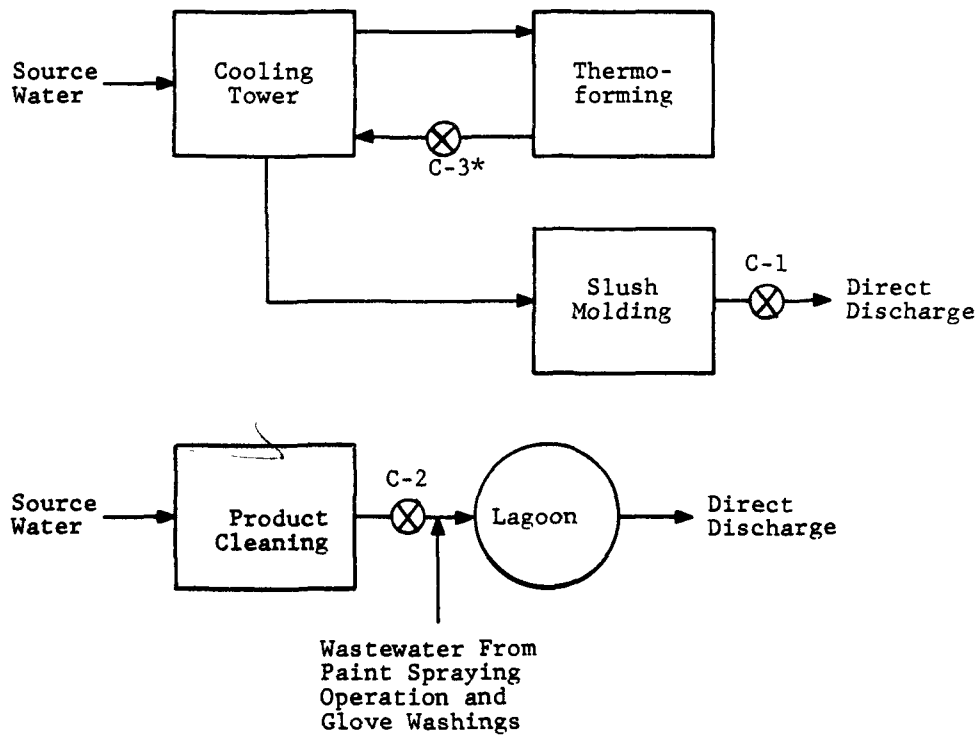

Figure VI-2  
 SAMPLING POINTS AT PLANT B



LEGEND:



- ⊗ - Sample Point
- - PM&F Process
- - Treatment System

\*Data from this point were not used in data analyses because process is no longer in operation.

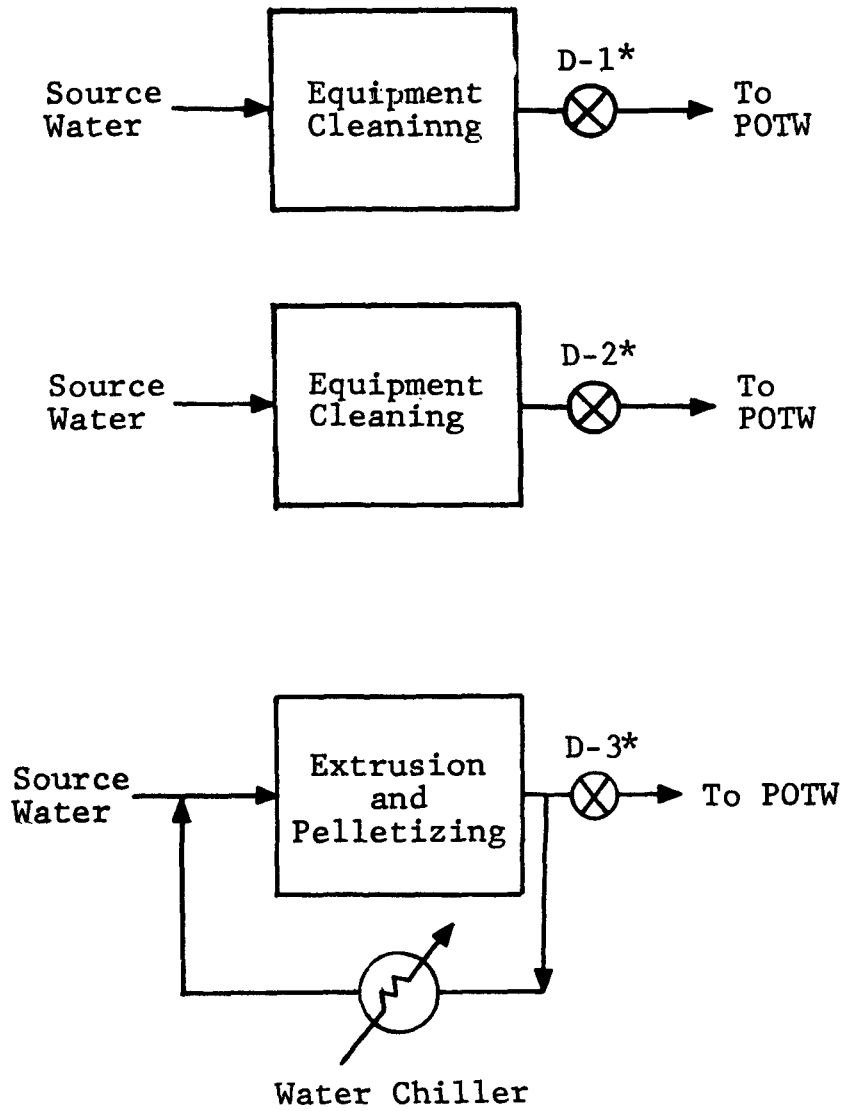
Figure VI-3  
 SAMPLING POINTS AT PLANT C



LEGEND:

-  - Sample Point
-  - PM&F Process



\*Batch process was sampled when process water was discharged.

Figure VI-4  
SAMPLING POINTS AT PLANT D

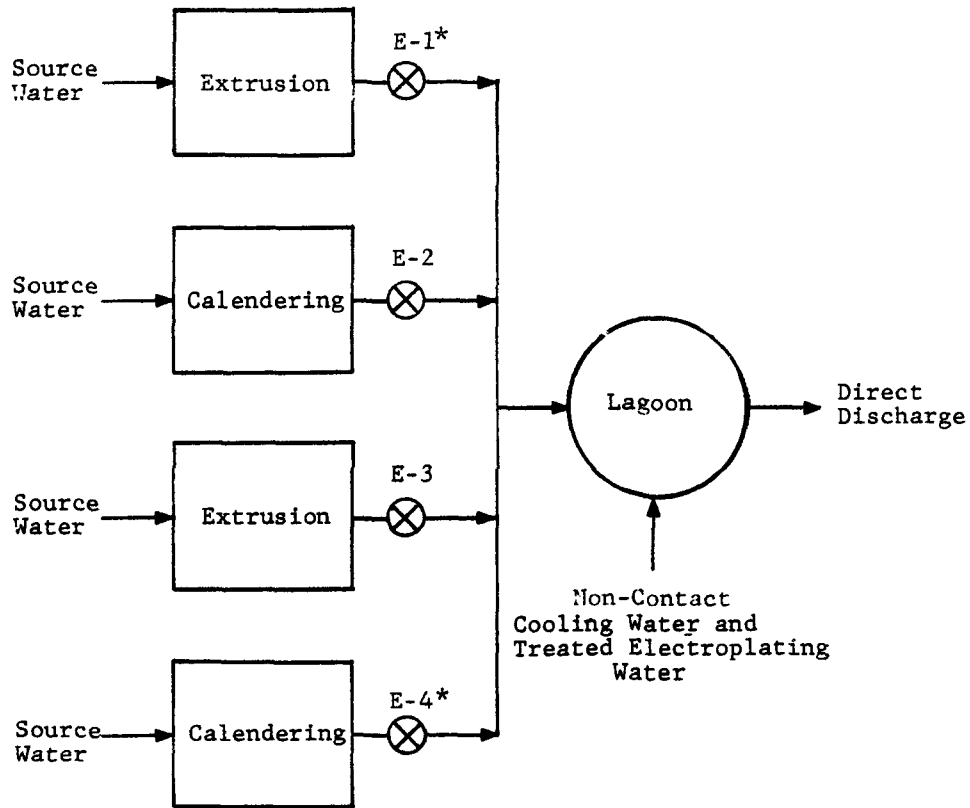



LEGEND:

-  - Sample Point
-  - PM&F Process
-  - Treatment System

\*Data from this point were not used in data analyses, because the material processed is a synthetic rubber.

Figure VI-5  
 SAMPLING POINTS AT PLANT E

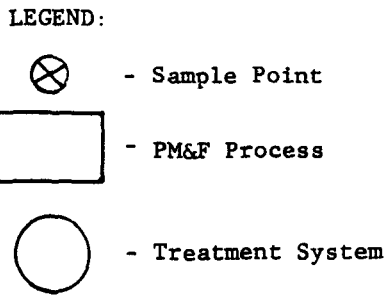
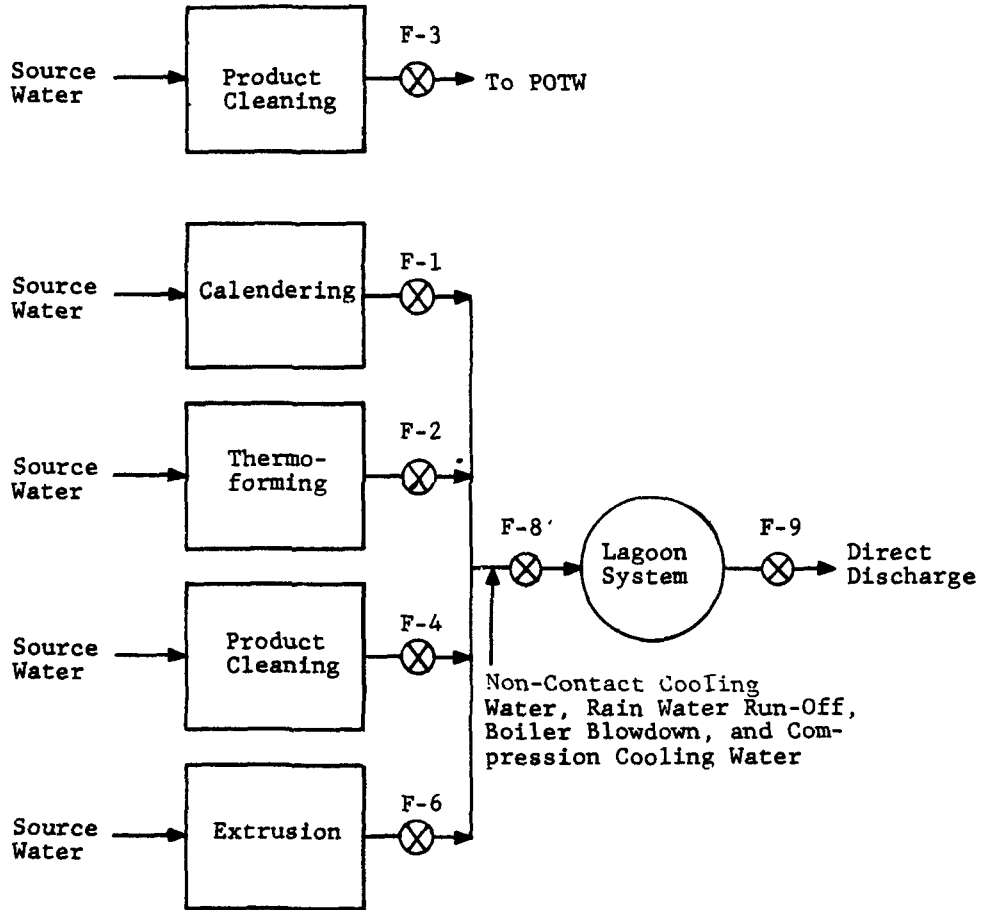
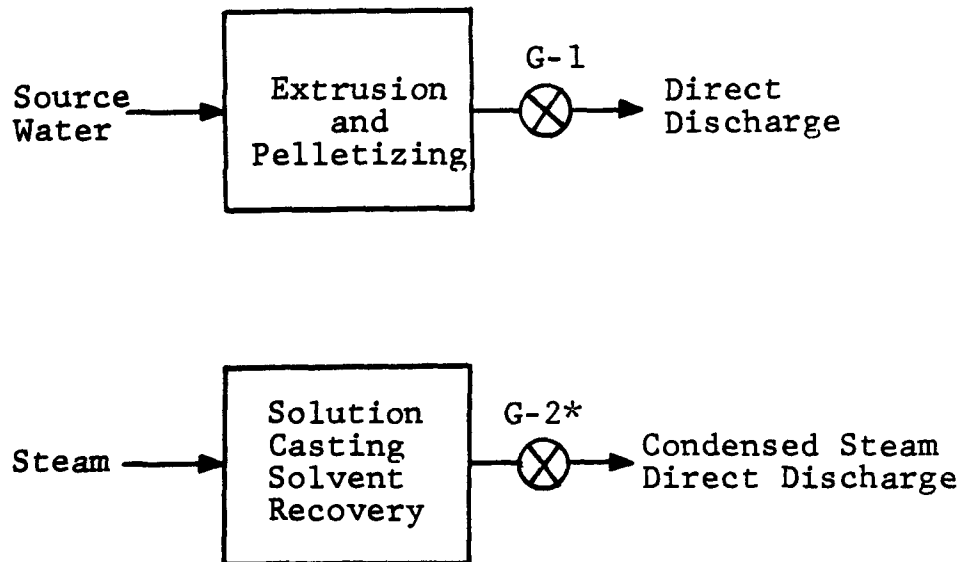



Figure VI-6  
 SAMPLING POINTS AT PLANT F



**LEGEND:**



-  - Sample Point
-  - PM&F Process

\*Solvent recovery wastewater is not regulated by the PM&F effluent limitations guidelines and standards.

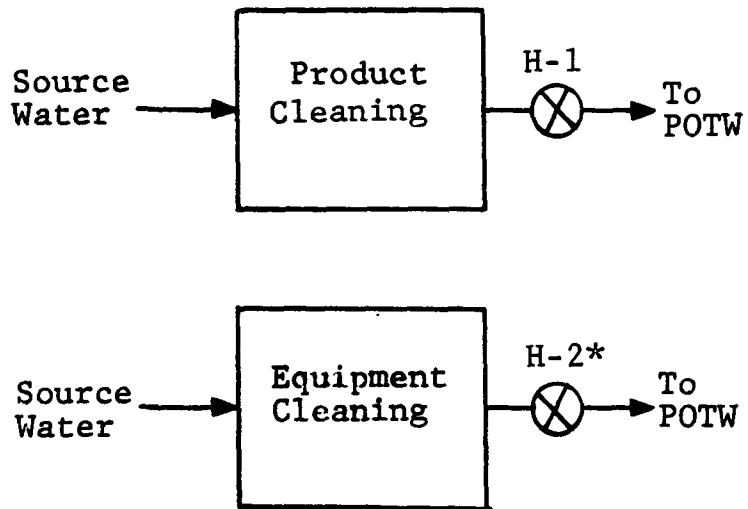
Figure VI-7  
 SAMPLING POINTS AT PLANT G



LEGEND:

-  - Sample Point
-  - PM&F Process

\*Data from this point were not used in data analyses because production data were not available for this process.

Figure VI-8  
SAMPLING POINTS AT PLANT H



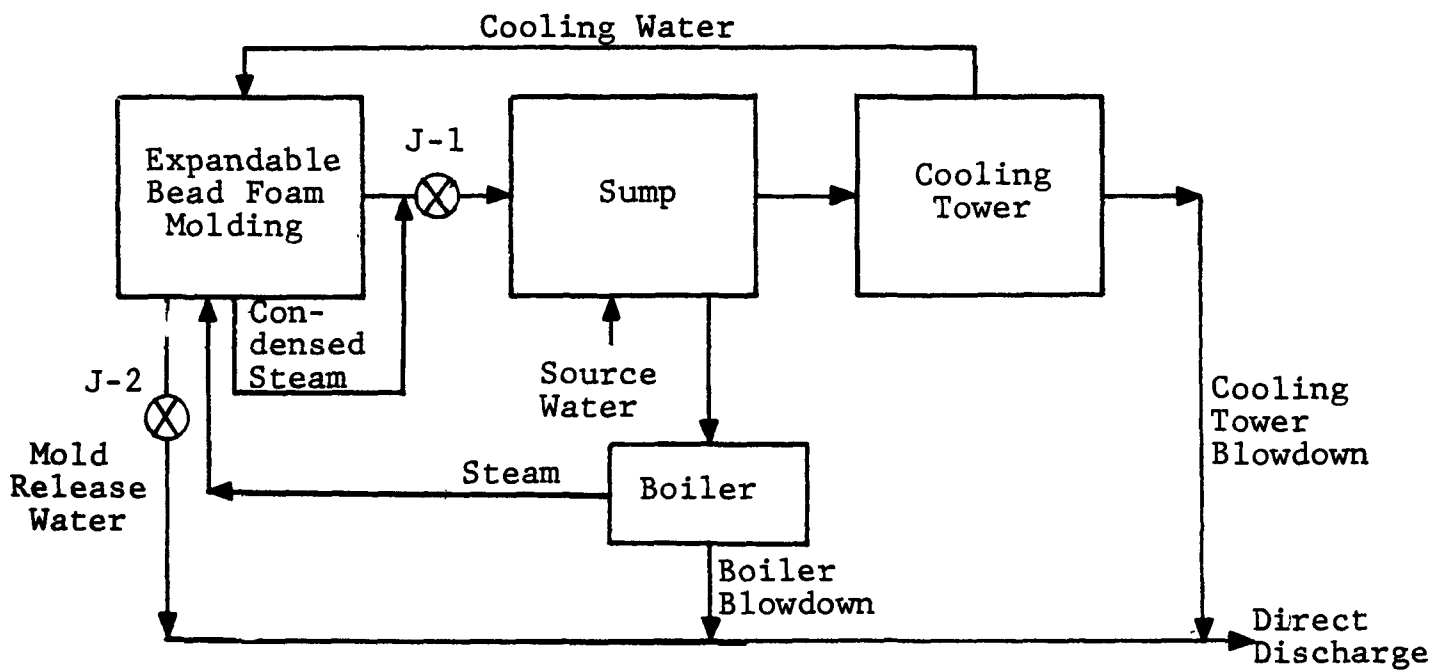

LEGEND:

- ⊗ - Sample Point
- - PM&F Process

Figure VI-10  
 SAMPLING POINTS AT PLANT J

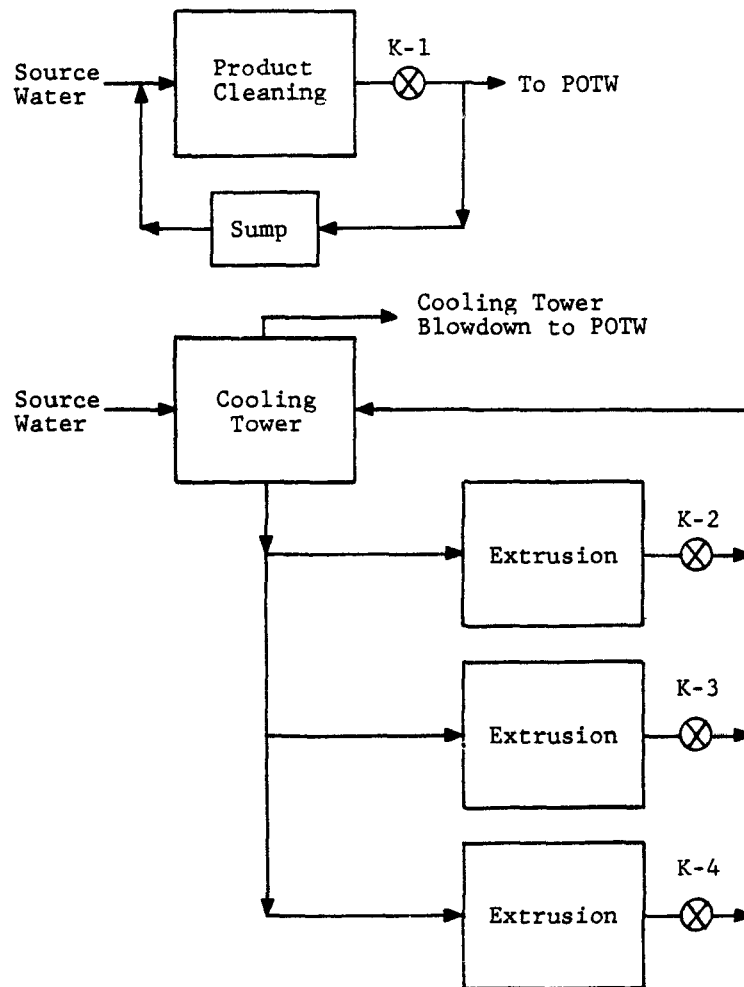

LEGEND:

- ⊗ - Sample Point
- - PM&F Process

Figure VI-11  
 SAMPLING POINTS AT PLANT K

1. Process H-1 was moved to the cleaning water subcategory. Originally, this process was classified as a casting process in the contact cooling and heating water subcategory. The Agency determined that water was used in this process to rinse the mold release agent (glycerol) from the product after the product was stripped off a mandrel. Because this is a cleaning operation instead of a heat transfer operation, data from that process were transferred from the contact cooling and heating water data base to the cleaning water data base.
2. Process B-2 was moved to the contact cooling and heating water subcategory. At proposal, process B-2 was classified as a finishing operation because two calender rolls formed the product into its final shape. This process was subsequently moved to the contact cooling and heating water subcategory because the Agency now believes water is used to cool instead of finish the product.
3. Processes E-1 and E-4 were eliminated from the contact cooling and heating water subcategory. The material used in those processes is a synthetic rubber and not a plastic material.
4. The cleaning and finishing water subcategory was separated into the cleaning water subcategory and the finishing water subcategory.
5. Production data were calculated for process I-4 and the process was included in the finishing water subcategory.

Table VI-13 lists the processes sampled in each subcategory and the process water flow rate for each process for which data were used to develop the final PM&F regulation.

#### Plant Selection - Final PM&F Regulation

Effluent limitations guidelines and standards were proposed on February 15, 1984, for the PM&F point source category. At the time of the proposal, the Agency identified three areas of the industry where the collection of additional sampling data was necessary. The three areas were (1) conventional and nonconventional pollutant data for contact cooling and heating waters; (2) conventional, nonconventional, and priority pollutant data for finishing waters; and (3) characteristics of solid waste generated by PM&F wastewater treatment operations. In addition, EPA determined that some additional data were needed to fully evaluate and respond to comments on the proposed PM&F regulation.



Table VI-13

## 1980 AND 1983 SAMPLED PROCESSES

## CONTACT COOLING AND HEATING WATER SUBCATEGORY

<u>Process Code</u>	<u>Type of Process</u>	<u>Process Water Flow Rate (gpm)</u>
B-1	extrusion	0.8
B-2	extrusion	1.8
B-4	injection molding	0.025
C-1	slush molding	0.28
D-3	pelletizing (extrusion)	50 gal/batch
E-2	calendering	14.0
E-3	wire coating (extrusion)	35.0
F-1	calendering	2.3
F-2	vacuum forming	1.8
F-6	extrusion	2.0
G-1	pelletizing (extrusion)	1.45
J-1	foam injection molding	120.0
J-2	molding	11.0
K-2	extrusion	4.0
K-3	extrusion	2.0
K-4	extrusion	146.0

## CLEANING WATER SUBCATEGORY

A-1	parts washing	10 gal/batch
A-2	oxalic acid parts washing	40 gal/batch
B-3	lens cleaning	20
C-2	parts washing	2.0
D-1	tank cleaning	15 gal/batch
D-2	tank cleaning	15 gal/batch
F-3	parts washing and rinsing	3.4
F-4	parts washing and rinsing	7.4
H-1	product rinsing	0.07
I-1	resin application equipment cleanup	1.4
I-2	resin application equipment cleanup	0.7
I-3	resin application equipment cleanup	1.6
K-1	parts washing	0.5

## FINISHING WATER SUBCATEGORY

I-4	product surface dulling	5.4
-----	-------------------------	-----

As for the sampling programs for the proposed regulation, types of processes, water use and wastewater discharge practices, and differences in production processes and plastic materials used were considered when selecting plants for the post-proposal sampling program. The questionnaire survey forms were the primary source of this information. Plants M, N, O, P, Q, and R were sampled in 1984. Figures VI-12 through VI-17 present process water flow diagrams for these six plants indicating the location of the sample points.

The 1984 sampling data base contains data from nine contact cooling and heating processes sampled at five plants. These processes, which include extrusion, thermoforming, and casting, were sampled and the samples were analyzed for conventional and selected nonconventional pollutants. Two finishing water processes were also sampled at two plants. Samples from those processes were analyzed for conventional, selected nonconventional, and priority pollutants. Table VI-14 presents the processes sampled in each subcategory and the process water flow rate for each process. Additionally, four solid waste samples from PM&F wastewater treatment operations were collected at three plants and analyzed to determine whether those wastes were hazardous. Refer to the energy and non-water quality impacts in Section IX for the extraction procedure (EP) toxicity test results for those samples.

Plant F was sampled in 1980 and was re-sampled in 1984 for verification of the total phenols concentrations found in the process water. The 1980 sampling episode showed total phenols levels that were magnitudes higher than levels found at the other sampled plants. Because personnel at Plant F could not explain what was contributing to the total phenols concentration, Plant F was selected for total phenols verification sampling. The results of this verification sampling are discussed at the end of this section.

#### Sample Collection, Preservation, and Transportation

Collection, preservation, and transportation of samples were performed in accordance with procedures outlined both in Appendix III of "Sampling and Analysis Procedures for Screening of Industrial Effluents for Priority Pollutants" (published by the Environmental Monitoring and Support Laboratory, Cincinnati, Ohio, March 1977, revised, April 1977) and in "Sampling Screening Procedure for the Measurement of Priority Pollutants" (published by the EPA Industrial Technology Division (formerly Effluent Guidelines Division), Washington, D.C., October 1976). Procedures for collection, preservation, and transportation of samples tested for conventional and nonconventional pollutants are described in the appropriate test methods (see Table VI-16).

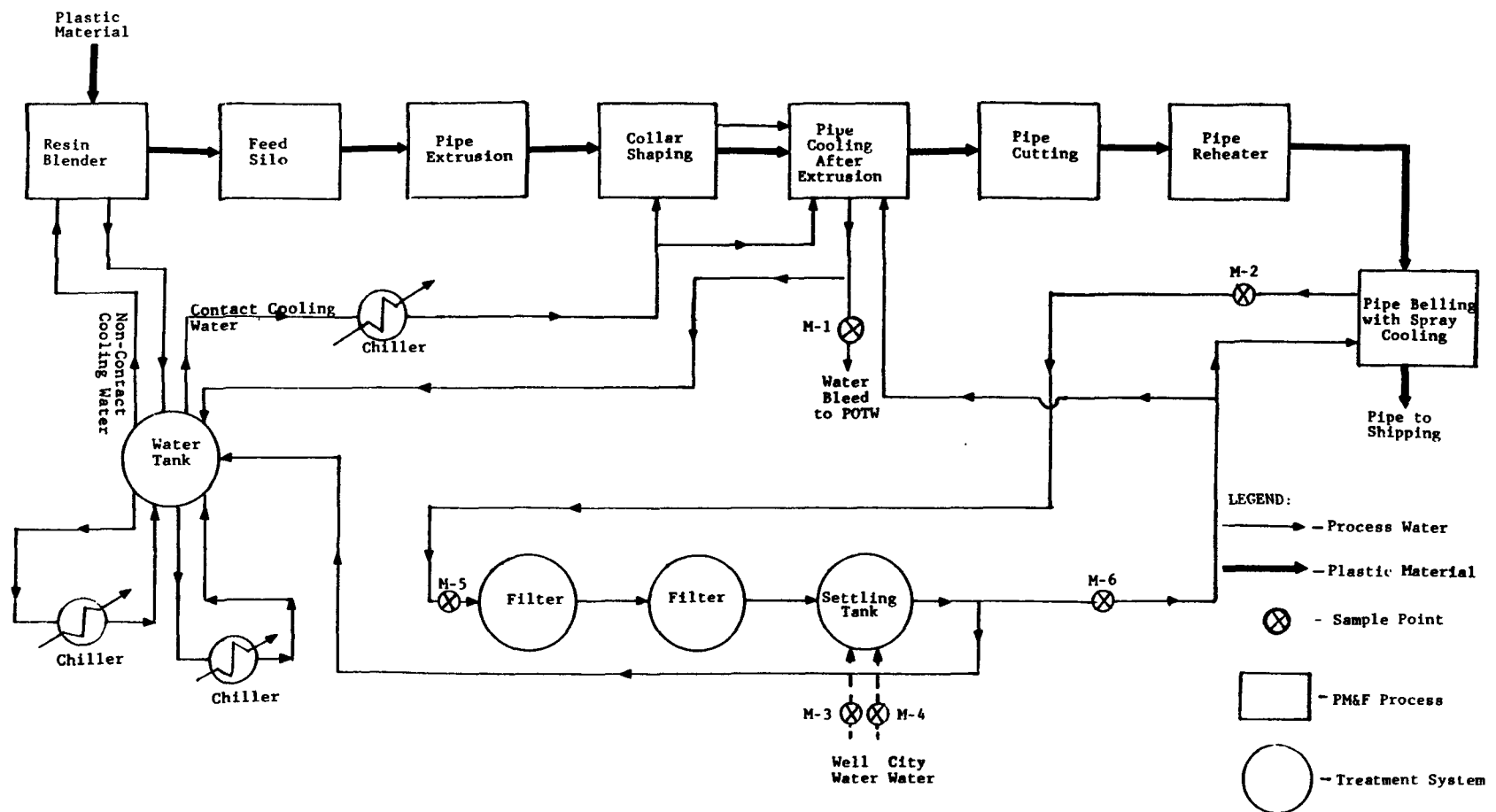

Figure VI-12  
 SAMPLING POINTS AT PLANT M

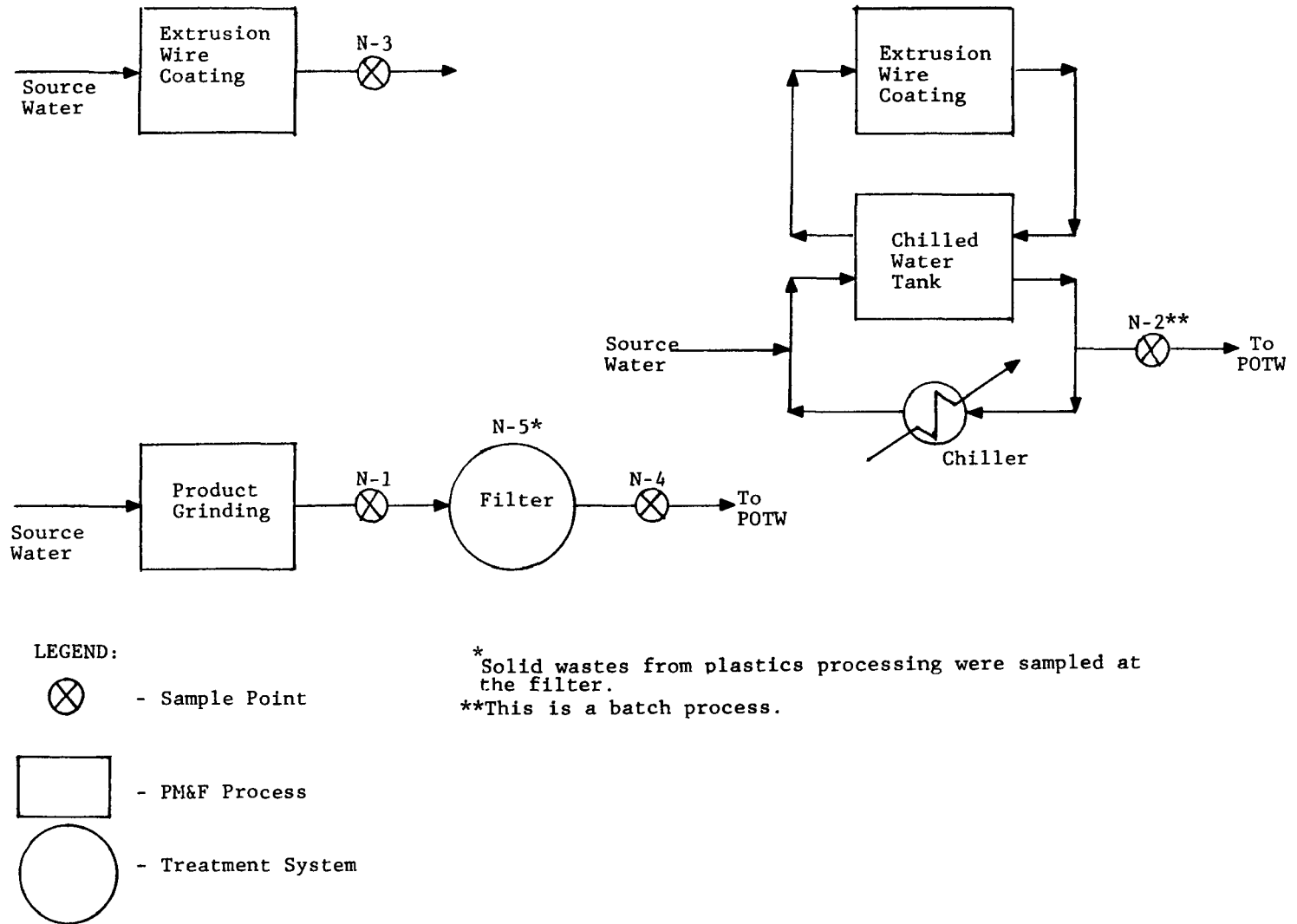
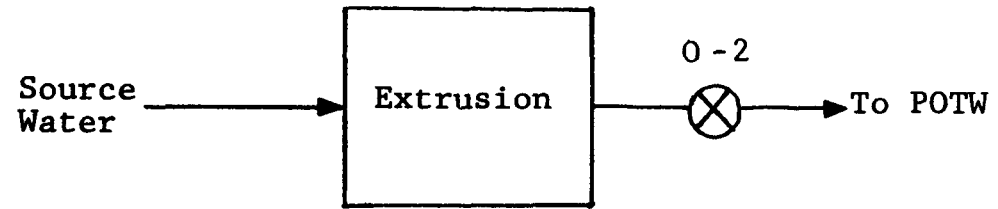
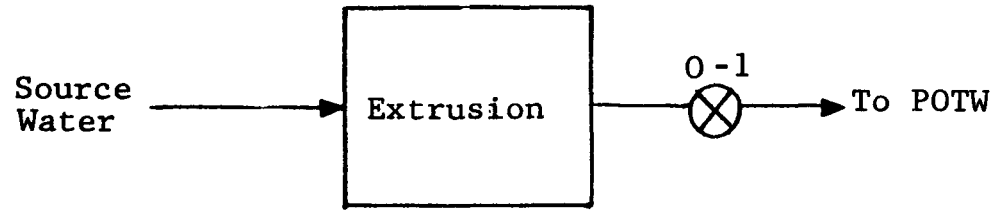

Figure VI-13  
 SAMPLING POINTS AT PLANT N



LEGEND:



- Sample Point



- PM&F Process

Figure VI-14  
SAMPLING POINTS AT PLANT O

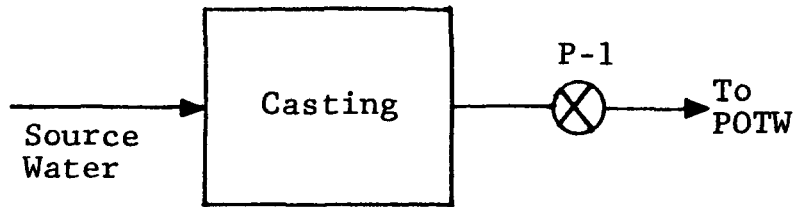

LEGEND:



- Sample Point



- PM&F Process

Figure VI-15  
SAMPLING POINTS AT PLANT P



LEGEND:







-  - Sample Point
-  - PM&F Process

Figure VI-16  
SAMPLING POINTS AT PLANT Q

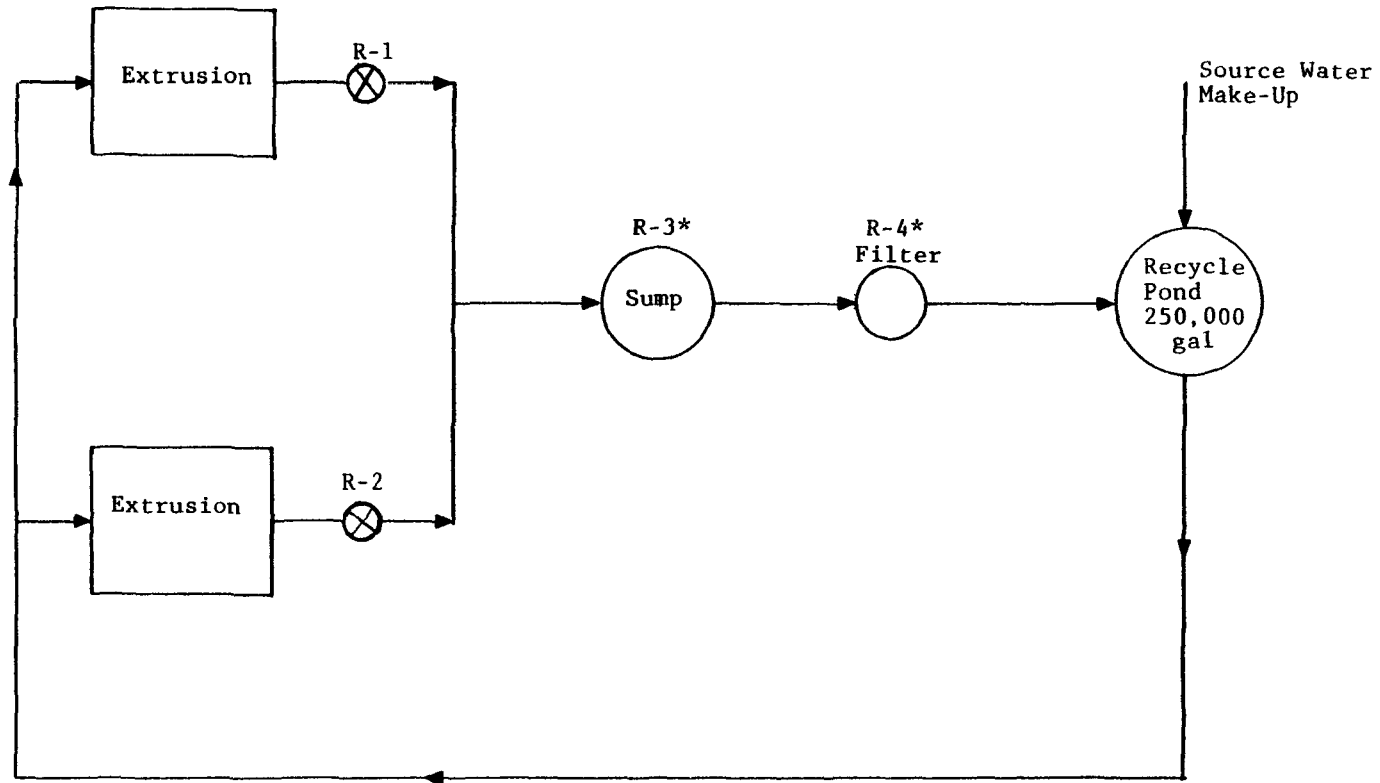

LEGEND:

-  - Sample Point
-  - PM&F Process
-  - Treatment

\*Solid wastes from plastics processing were sampled at this location.

Figure VI-17  
SAMPLING POINTS AT PLANT R



Table VI-14  
1984 SAMPLED PROCESSES

CONTACT COOLING AND HEATING WATER SUBCATEGORY

<u>Process Code</u>	<u>Type of Process</u>	<u>Process Water Flow Rate (gpm)</u>
M-1	pipe extrusion	3.6
M-2	thermoforming	5.0
N-2	extrusion	0.03
N-3	extrusion	0.94
O-1	extrusion	2.5
O-2	extrusion	1.8
P-1	casting	4.8
R-1	extrusion	3.9
R-2	extrusion	55.0

FINISHING WATER SUBCATEGORY

N-1	product grinding	12.0
Q-1	product finishing	18.0

## Sample Analysis

Once collected in the field, samples were prepared and shipped via overnight air express to EPA contract laboratories for analysis. Pollutants for which analyses were conducted are presented in Table VI-15. The analytical methods used are listed in Table VI-16. The analytical detection limits for the priority toxic pollutants are listed in Table VI-17.

## Field Quality Assurance/Quality Control (QA/QC)

Field QA/QC procedures for the sampling programs included taking duplicate, blank, preservative blank, and source water samples.

Field Duplicates. Duplicate samples were collected at one sampling point at some of the sampled plants and were analyzed for the same pollutants that the other samples collected at that point were analyzed for. The identity of the duplicate samples was not made known to the laboratories. Oil and grease and volatile organic (VOA) samples were collected in duplicate each time samples were collected and shipped to the laboratory.

Field Blanks. As required by sampling protocol, organic-free water was flushed through each automatic sampler prior to the start of sampling at each plant. One gallon of that water was collected and shipped to the contract laboratory. This sample was the non-volatile organic pollutant blank sample.

Duplicate VOA blanks for each sampling point were supplied in 40 milliliter vials by the laboratory. Both preserved and unpreserved VOA field blanks were supplied. The VOA blanks were prepared in the laboratory, transported to the sampling site, placed at selected locations at the sampling site, and then returned to the laboratory after conclusion of the sampling period.

Preservative/Container Blanks. To verify that there was no contamination from the various chemicals used as preservatives or from the sample containers, organic-free water supplied by the laboratory was poured into the appropriate sample containers. These samples were preserved and shipped to appropriate laboratories for analysis.

Source Water Samples. To assess potential presence of conventional, nonconventional, and toxic pollutants in the source water for each plant, samples of the source water were collected, preserved, shipped to the laboratory, and analyzed for the pollutants listed in Table VI-15.

Table VI-15

POLLUTANTS FOR WHICH PM&F PROCESS WATER SAMPLES WERE ANALYZED

131

<u>PRIORITY POLLUTANTS</u>		<u>PRIORITY POLLUTANTS</u>	
<u>Base/Neutral Compounds</u>		<u>Pesticides</u>	<u>Volatiles</u>
Acenaphthene	Naphthalene	Aldrin	Acrolein
Benzidine	Nitrobenzene	Dieldrin	Acrylonitrile
1,2,4-Trichlorobenzene	N-Nitrosodimethylamine	Chlordane	Benzene
Hexachlorobenzene	N-Nitrosodiphenylamine	4,4'-DDT	Carbon tetrachloride
Hexachloroethane	N-Nitrosodi-n-propylamine	4,4'-DDE	Chlorobenzene
bis (2-Chloroethyl) ether	bis (2-Ethylhexyl) phthalate	4,4'-DDD	1,2-Dichloroethane
1,2-Dichlorobenzene	Butyl benzyl phthalate	alpha-Endosulfan	1,1,1-Trichloroethane
2-Chloronaphthalene	Di-n-butyl phthalate	beta-Endosulfan	1,1-Dichloroethane
1,3-Dichlorobenzene	Di-n-octyl phthalate	Endosulfan sulfate	1,1,2-Trichloroethane
1,4-Dichlorobenzene	Diethyl phthalate	Endrin	1,1,2,2-Tetrachloroethane
3,3'-Dichlorobenzidine	Dimethyl phthalate	Endrin aldehyde	Chloroethane
2,4-Dinitrotoluene	Benzo(a)anthracene	Heptachlor	bis (Chloromethyl) ether <sup>1</sup>
2,6-Dinitrotoluene	Benzo(a) pyrene	Heptachlor epoxide	2-Chloroethylvinyl ether
1,2-Diphenylhydrazine	3,4-Benzofluoranthene	alpha-BHC	Chloroform
(as azobenzene)	Benzo(k)fluoranthene	beta-BHC	1,1-Dichloroethylene
Fluoranthene	Chrysene	gamma-BHC	1,2-trans-Dichloroethylene
4-Chlorophenyl phenyl ether	Acenaphthylene	delta-BHC	1,2-Dichloropropane
4-Bromophenyl phenyl ether	Anthracene	PCB-1242	1,2-Dichloropropylene
bis (2-Chloroisopropyl) ether	Benzo (g,h,i)perylene	PCB-1254	Ethylbenzene
bis (2-Chloroethoxy) methane	Fluorene	PCB-1221	Methylene chloride
Hexachlorobutadiene	Phenanthrene	PCB-1232	Methyl chloride
Hexachlorocyclopentadiene	Dibenzo(a,h)anthracene	PCB-1248	Methyl bromide
Isophorone	Indeno(1,2,3-c,d)pyrene	PCB-1260	Bromoform
	Pyrene	PCB-1016	Dichlorobromomethane
	2,3,7,8-Tetrachlorodibenzo-	Toxaphene	Trichlorofluoromethane <sup>1</sup>
	p-dioxin		Dichlorodifluoromethane <sup>1</sup>
			Chlorodibromomethane
			Tetrachloroethylene
			Toluene
			Trichloroethylene
			Vinyl chloride

<u>PRIORITY POLLUTANTS</u>	<u>NONCONVENTIONAL POLLUTANTS</u>	<u>NONCONVENTIONAL METAL POLLUTANTS</u>	<u>CONVENTIONAL POLLUTANTS</u>
<u>Acid Compounds</u>	<u>Metals</u>		Biochemical Oxygen Demand (BOD <sub>5</sub> )
2,4,6-Trichlorophenol	Antimony	Aluminum	pH
p-Chloro-m-cresol	Arsenic	Barium	Oil and Grease
2-Chlorophenol	Beryllium	Boron	Total Suspended Solids (TSS)
1,4-Dichlorophenol	Chromium	Calcium	
2,4-Dimethylphenol	Cadmium	Cobalt	
2-Nitrophenol	Copper	Iron	
4-Nitrophenol	Lead	Magnesium	
2,4-Dinitrophenol	Mercury	Manganese	
4,5-Dinitro-o-cresol	Nickel	Molybdenum	
Pentachlorophenol	Selenium	Tin	
Phenol	Silver	Titanium	
<u>Other</u>	Thallium	Vanadium	
Cyanide	Zinc	Yttrium	
Asbestos			
	Ammonia		
	Boron		
	Bromide		
	Chemical Oxygen Demand (COD)		
	Fluoride		
	Free Chlorine		
	Lead		
	Nitrates		
	Sulfate		
	Sulfide		
	Surfactants		
	Total Dissolved Solids		
	Total Kjeldahl Nitrogen		
	Total Organic Carbon (TOC)		
	Total Phenols (4-AAP)		
	Total Phosphorus		

<sup>1</sup>These compounds were removed from the priority pollutant list (see 46 FR 2266, January 8, 1981, and 46 FR 10723, February 4, 1981).

Table VI-16  
ANALYTICAL METHODS SUMMARY

<u>Conventional and Nonconventional Pollutants</u>	<u>USEPA Methods†</u>	<u>Standard Methods††</u>
BOD <sub>5</sub>	405.1	
COD	410.1, 410.2	
TOC	415.1	
TSS	160.2	
Bromide		405
Fluoride	340.1	
Ammonia	350.1	
Total Kjeldahl Nitrogen (TKN)	351.3	
Nitrate-Nitrite Nitrogen (as N)	353.2	
Oil and Grease		503C
Phosphorus (total)	365.1	
Boron		404B
Sulfate (as SO <sub>4</sub> =)	375.2	
Sulfide (as S)	376.2	
Surfactants (MBAS)	425.1	512A
pH	150.1	
Cyanide (total)	335.3	
Phenols (total)	420.2	
<b>Metals</b>	<b>Inductively Coupled Plasma (ICP) Opticals - Emission Spectrometer Method (Task 1)†††</b>	
Calcium		
Magnesium		
Sodium		
Aluminum		
Manganese		
Vanadium		
Boron		
Barium		
Molybdenum		
Tin		
Yttrium		
Cobalt		
Iron		
Titanium		

†USEPA Methods for Chemical Analysis of Water and Wastes, USEPA, Environmental Monitoring and Support Laboratory, Cincinnati, Ohio, March 1979, EPA-600/4-79-020.

††Standard Methods for the Examination of Water and Wastewater, 15 Edition, 1981.

†††Procedures are described in "Guidelines Establishing Test Procedures for Analysis of Pollutants; Proposed Regulations, Appendix IV," Federal Register, December 3, 1979, p. 69559.

Table VI-16 (Continued)  
ANALYTICAL METHODS SUMMARY

<u>Priority Toxic Pollutants</u>	<u>USEPA Method†</u>
Acid Extraction	1625*
Base/Neutral Extraction	1625*
Volatile Organics	1624*
Pesticides and PCB's	608
Metals	Inductively Coupled Plasma (ICP)
Lead	Optical - Emission Spectrometer
Beryllium	Method (Task 1)††
Cadmium	
Chromium	
Copper	
Nickel	
Zinc	
Metals	Flameless Atomic Absorption
Selenium	Spectrometer Method (Task 2)†
Thallium	
Silver	
Arsenic	
Antimony	
Mercury	
Metals	Flame Atomic Absorption
Lead	Spectrometer Method (Task 2)†
Beryllium	
Cadmium	
Chromium	
Copper	
Nickel	
Zinc	

\*In cases where isotopes were not available USEPA Methods 624 and 625 were used.

†USEPA Methods for Chemical Analysis of Water and Wastes, USEPA, Environmental Monitoring and Support Laboratory, Cincinnati, Ohio, March 1979, EPA-600/4-79-020.

††Procedures are described in "Guidelines Establishing Test Procedures for Analysis of Pollutants; Proposed Regulations, Appendix IV," Federal Register, December 3, 1979, p. 69559.

Table VI-17

## DETECTION LIMITS FOR PRIORITY TOXIC POLLUTANTS

<u>Pollutant</u>	<u>Analytical* Detection Limit (ug/l)</u>
<u>Base/Neutral Extractable Compounds</u>	
N-nitrosodimethylamine	250
isophorone	50
hexachlorocyclopentadiene	250
benzidine	50
3,3'-dichlorobenzidine	50
indeno(1,2,3-cd)pyrene	25
dibenzo(ah)anthracene	25
benzo(ghi)perylene	25
all other base/neutral compounds	10
<u>Acid Extractable Compounds</u>	
2,4-dimethylphenol	250
2,4-dinitrophenol	250
2-methyl-4,6-dinitrophenol	250
pentachlorophenol	125
all other acid compounds	25
<u>Volatile Compounds</u>	
acrolein	100
acrylonitrile	100
all other volatile compounds	10
<u>Pesticides</u>	
aldrin	0.003
dieldrin	0.006
chlordane	0.04
4,4'-DDT	0.016
4,4'-DDE	0.006
4,4'-DDD	0.012
alpha-endosulfan	0.005
beta-endosulfan	0.010
endosulfan sulfate	0.03
endrin	0.009
endrin aldehyde	0.023
heptachlor	0.002
heptachlor epoxide	0.004

Table VI-17 (Continued)

## DETECTION LIMITS FOR PRIORITY TOXIC POLLUTANTS

<u>Pollutant</u>	<u>Analytical* Detection Limit (ug/l)</u>
<u>Pesticides (Continued)</u>	
alpha-BHC	0.002
beta-BHC	0.004
gamma-BHC	0.004
delta-BHC	0.002
PCB-1242	0.05
PCB-1254	0.06
PCB-1221	0.10
PCB-1232	0.10
PCB-1248	0.06
PCB-1260	0.15
PCB-1016	0.04
toxaphene	0.40
<u>Metals</u>	
antimony	100
arsenic	53
beryllium	0.3
cadmium	4
chromium	7
copper	6
lead	42
mercury	0.1
nickel	15
selenium	75
silver	7
thallium	100
zinc	2
<u>Others</u>	
cyanide	20

\*These analytical detection limits are from the USEPA test method for the organic acid, base neutral, and volatile pollutants. The limits for the pesticides and metals are from the Federal Register, Monday, December 3, 1979, "Guidelines Establishing Test Procedures for the Analysis of Pollutants; Proposed Regulations."

## Sampling Procedure Protocols

The following procedures were used during the sampling episodes. These procedures comply with sampling method protocols.

Bottle/Glassware Preparation. Sample containers and glassware that came in contact with the process water samples were prepared according to the procedures outlined in Table VI-18. With the exceptions of grease and oil jars, volatile organic analysis vials, field blank and preservative blank containers, and the non-volatile (NVO) composite jug, sample containers were rinsed with process water prior to use.

Composite Samples. Composite samples were collected using an ISCO Model 1580 Sampler equipped with new silastic pump tubing and new teflon sample lines. An aluminum rod was used to anchor the sample line in place if necessary. The equipment was programmed to collect a minimum of nine quarts (8,516 milliliters) of process water over the duration of each sampling day. The minimum aliquot size was 100 milliliters and the maximum interval between aliquot collection was 30 minutes.

The operation of each sampler was checked periodically throughout the sampling day. Batteries used with the samplers were changed on a daily basis to avoid problems.

At the conclusion of collection of each composite sample period, contents of the jug were thoroughly mixed by shaking before being transferred to individual containers. Graduated cylinders were used to transfer the sample from the sample jug to the container to avoid spillage.

Free Chlorine Determination. A free chlorine determination was made with potassium iodide paper at each sampling point at the beginning of each sampling day. The appropriate samples were preserved if free chlorine was present in excess of 1 ppm.

Sample Preservation. All samples were maintained at 4°C during the sampling period. All preservatives were purchased fresh and placed in new containers. Cyanide and phenol samples were collected via grab samples and preserved with appropriate chemicals as soon as they were collected. Oil and grease samples were single grab samples preserved with sulfuric acid. VOA samples were individual grab samples collected four times per day and preserved with sodium metabisulfate, if necessary. Individual pipets were used for each preservative and discarded after use to avoid cross-contamination.

pH Measurement. pH was monitored at each sampling location using pH meters. The meter was buffered before use with pH 4, 7, and



Table VI-18

## CONTAINER AND GLASSWARE PREPARATION PROCEDURES

<u>Container</u>	<u>Type</u>	<u>Size</u>	<u>Preparation</u>
Composite Jug	Glass	2.5-5 gallons	Scrub with hot detergent water, rinse with tap water, rinse with blank water, rinse with methylene chloride. Use Teflon liners in caps.
NVO Jug	Glass	1 gallon	
Blank Water Jug	Glass	1 gallon	
Graduated Cylinders	Glass	250/2000 ml	
VOA Vial, Septa, Screw Cap	Glass	40 ml	New containers were used each time after being cleaned according to procedures outlined above.
Phenol	Amber Glass	8 ounce	New containers, caps and Teflon liners washed with hot water, rinsed with tap water and blank water.
Cyanide	Plastic	1 quart	New containers and caps washed with hot water and rinsed with tap water and blank water.
Metals	Plastic Bottles	1 quart	New containers washed with detergent water, rinsed with tapwater, rinsed with deionized water, rinsed with 1:1 ultra-pure nitric acid.
Conventional/Nonconventional Pollutants	Plastic	0.5 gallon	New containers.
Acidified Conventional/Nonconventional Pollutants	Plastic	quart	New containers.

Table VI-18 (Continued)

## CONTAINER AND GLASSWARE PREPARATION PROCEDURES

<u>Container</u>	<u>Type</u>	<u>Size</u>	<u>Preparation</u>
Sulfide	Plastic	pint	New containers.
Sulfite	Plastic	8 ounce	New containers.
Free Chlorine	Plastic	8 ounce	New containers.
Grease and Oil	Glass Widemouth	quart	New containers washed with soap and water, rinsed with tap water, rinsed with deionized water, rinsed with acetone, rinsed with freon.

10 buffering agents. If pH meters were not available, pH paper was used.

Temperature Measurement. Temperature was measured with metal dial thermometers. Mercury thermometers were not used because of potential contamination of the process water in case the thermometer broke.

#### Laboratory Quality Assurance/Quality Control (QA/QC)

Quality control measures used in the laboratory are presented in "Handbook for Analytical Quality Control in Water and Wastewater Laboratories" (published by EPA Environmental Monitoring and Support Laboratory, Cincinnati, Ohio, 1976). As part of the analytical quality control program, duplicates and blanks (including sealed VOA samples of blank water carried to each sampling site and returned unopened and samples of preserved and unpreserved equipment blank water) were analyzed. Standards and spiked samples were also analyzed. As part of the analytical QA/QC, all instruments (such as balances, spectrophotometers, and recorders) were routinely maintained and calibrated.

#### PROCESS WATER POLLUTANT CONCENTRATIONS

Analytical data for each type of process water were summarized and are presented in this section. The tables that present the data contain the following information for each pollutant:

1. Number of samples analyzed,
2. Number of times pollutant was detected,
3. Subcategory pollutant concentration range, and
4. Subcategory average pollutant concentration.

Table VI-19 presents these data for the three subcategories. Only pollutants that were detected one or more times are included in Table VI-19. The daily data used to calculate the summaries are presented in Appendix A.

Certain data editing rules were applied to the daily data; the data were then averaged by a flow-weighted averaging methodology to calculate the subcategory average concentrations listed in Table VI-19. The editing rules and averaging methodology are described below.

#### Data Editing Rules

The following editing rules were used to calculate the subcategory pollutant average concentrations:

Table VI-19

## SUMMARY OF SAMPLE DATA

## CONTACT COOLING AND HEATING WATER SUBCATEGORY

<u>Pollutant</u>	<u>Number of Samples</u>	<u>Number of Times Detected</u>	<u>Concentration Range (mg/l)</u>	<u>Flow-Weighted Average Concentration (mg/l)</u>
<u>Conventional</u>				
biochemical oxygen demand (BOD <sub>5</sub> )	43	43	2.3-96.9	1
oil and grease	47	47	0-75	2
pH	35	35	5.4-8.3	NA
total suspended solids (TSS)	38	38	<1-104	0.6
<u>Nonconventional</u>				
aluminum	34	19	ND-0.800	0.044
ammonia nitrogen	38	37	0-8.4	0.035
barium	34	22	ND-0.190	0.001
boron	34	18	ND-0.17	0.0006
bromide	21	21	<0.4-0.8	636†
calcium	34	34	2.0-406	3.59
chemical oxygen demand (COD)	47	47	<5-800	26
cobalt	34	11	ND-0.142	0.018
cyanide (amenable)	19	19	0-<0.01	0
fluoride	21	21	0.08-1.25	0.211
iron	34	32	ND-9.85	0.156
Kjeldahl nitrogen	38	32	ND-1.15	0.034
magnesium	34	34	0.7-29.8	0.412
manganese	34	14	ND-0.210	0.005
molybdenum	34	5	ND-0.15	0.004
nitrate	21	21	<0.1-2.1	0.062
sodium	34	34	1.8-207	0.861
sulfate	21	21	<5-1,180	1.04

Table VI-19 (Continued)

## SUMMARY OF SAMPLE DATA

## CONTACT COOLING AND HEATING WATER SUBCATEGORY (Cont.)

<u>Pollutant</u>	<u>Number of Samples</u>	<u>Number of Times Detected</u>	<u>Concentration Range (mg/l)</u>	<u>Flow-Weighted Average Concentration (mg/l)</u>
<u>Nonconventional (Cont.)</u>				
sulfide	19	19	<1	0
surfactants	36	36	0-28.86	0.013
tin	34	10	ND-0.12	31†
titanium	34	17	ND-0.290	0.0004
total dissolved solids (TDS)	17	17	66-800	68.1
total organic carbon (TOC)	47	47	1-144	8
total phenols	39	39	<0.001-20.86	0.006
total phosphorus	38	38	<0.003-3.25	0.281
vanadium	35	6	ND-0.056	0.0008
yttrium	35	3	ND-0.019	75†
<u>Priority Toxic</u>				
1. acenaphthene	38	4	ND-<0.01	1†
4. benzene	41	22	ND-0.045	0.012
5. benzidine	37	2	ND-<0.01	9†
6. carbon tetrachloride (tetrachloromethane)	41	9	ND-0.008	92†
7. chlorobenzene	38	6	ND-0.0032	8†
10. 1,2-dichloroethane	39	1	ND-<0.01	0.07†
11. 1,1,1-trichloroethane	38	21	ND-0.093	0.024
22. parachlorometa cresol	38	16	ND-0.043	0.022
23. chloroform	41	32	ND-0.115	0.001
24. 2-chlorophenol	38	1	ND-<0.01	0.07†

Table VI-19 (Continued)

## SUMMARY OF SAMPLE DATA

## CONTACT COOLING AND HEATING WATER SUBCATEGORY (Cont.)

<u>Pollutant</u>	<u>Number of Samples</u>	<u>Number of Times Detected</u>	<u>Concentration Range (mg/l)</u>	<u>Flow-Weighted Average Concentration (mg/l)</u>
<u>Priority Toxic (Cont.)</u>				
25. 1,2-dichlorobenzene	38	1	ND-<0.01	0.07†
26. 1,3-dichlorobenzene	38	1	ND-<0.01	0.07†
27. 1,4-dichlorobenzene	38	1	ND-<0.01	0.07†
30. 1,2-trans-dichloroethylene	41	3	ND-0.017	0.0001
31. 2,4-dichlorophenol	38	1	ND-<0.01	0.07†
38. ethylbenzene	41	7	ND-<0.01	6†
39. fluoranthene	37	2	ND-<0.01	4†
41. 4-bromophenyl phenyl ether	38	1	ND-0.00042	23†
44. methylene chloride (dichloromethane)	41	36	ND-0.33	0.023
47. bromoform	41	10	ND-0.024	0.0003
48. dichlorobromomethane	41	18	ND-0.007	8†
49. trichlorofluoromethane	41	11	ND-0.004	18†
51. chlorodibromomethane	41	9	ND-0.001	0.0003
54. isophorone	38	1	ND-0.00096	53†
55. naphthalene	38	1	ND-0.018	2†
57. 2-nitrophenol	38	5	ND-0.003	19†
58. 4-nitrophenol	38	3	ND-0.004	0
60. 4,6-dinitro-o-cresol	38	1	ND-0.004	0.9†
61. N-nitrosodimethylamine	38	1	ND-<0.01	0.0002
62. N-nitrosodiphenylamine	38	2	ND-0.006	7†
65. phenol	38	20	ND-0.910	0.004
66. bis(2-ethylhexyl) phthalate	38	37	ND-1.72	0.098
67. butyl benzyl phthalate	38	4	ND-0.006	33†

Table VI-19 (Continued)

## SUMMARY OF SAMPLE DATA

## CONTACT COOLING AND HEATING WATER SUBCATEGORY (Cont.)

<u>Pollutant</u>	<u>Number of Samples</u>	<u>Number of Times Detected</u>	<u>Concentration Range (mg/l)</u>	<u>Flow-Weighted Average Concentration (mg/l)</u>
<u>Priority Toxic (Cont.)</u>				
68. di-n-butyl phthalate	38	36	ND-0.013	0.001
69. di-n-octyl phthalate	38	7	ND-0.021	0.0001
70. diethyl phthalate	38	22	ND-0.964	0.005
71. dimethyl phthalate	38	4	ND-0.087	0.0002
72. benzo(a)anthracene (1,2-benzoanthracene)	38	3	ND-<0.01	5†
73. benzo(a)pyrene (3,4-benzopyrene)	38	3	ND-0.012	99†
76. chrysene	38	1	ND-<0.01	0.07†
78. anthracene	38	6	ND-<0.01	0.002
80. fluorene	38	2	ND-<0.01	22†
81. phenanthrene	38	4	ND-<0.01	37†
85. tetrachloroethylene	38	6	ND-0.014	4†
86. toluene	41	16	ND-0.015	0.0001
87. trichloroethylene	38	8	ND-0.215	0.0003
89. aldrin	41	6	ND-<0.005	0.2†
90. dieldrin	38	6	ND-<0.005	0.2†
92. 4,4'-DDT	41	1	ND-22†	0.1†
93. 4,4'-DDE	41	2	ND-45†	9†
94. 4,4'-DDD	38	1	ND-40†	2†
97. endosulfan sulfate	38	1	ND-0.00013	0.3†
98. endrin	38	2	ND-<0.005	0.06†
99. endrin aldehyde	38	3	ND-66†	0.3†
100. heptachlor	38	3	ND-28†	0.3†
101. heptachlor epoxide	38	1	ND-0.0004	0.02†

Table VI-19 (Continued)

## SUMMARY OF SAMPLE DATA

## CONTACT COOLING AND HEATING WATER SUBCATEGORY (Cont.)

<u>Pollutant</u>	<u>Number of Samples</u>	<u>Number of Times Detected</u>	<u>Concentration Range (mg/l)</u>	<u>Flow-Weighted Average Concentration (mg/l)</u>
<u>Priority Toxic (Cont.)</u>				
102. alpha-BHC	38	17	ND-0.0006	36†
103. beta-BHC	38	11	ND-0.0006	9†
104. gamma-BHC	38	14	ND-349†	2†
105. delta-BHC	38	11	ND-107†	40†
114. antimony	35	8	ND-0.03	0.006
115. arsenic	34	2	ND-0.016	0.0015
117. beryllium	35	2	ND-0.003	19†
118. cadmium	34	13	ND-0.071	0.0007
119. chromium (total)	34	12	ND-0.200	0.002
120. copper	34	25	ND-2.2	0.001
121. cyanide (total)	38	36	ND-<0.02	0
122. lead	34	14	ND-0.292	0.100
123. mercury	34	3	ND-0.0007	0.1†
124. nickel	34	8	ND-3.88	0.003
125. selenium	34	6	ND-0.012	0
126. silver	34	8	ND-0.016	56†
127. thallium	34	2	ND-0.126	57†
128. zinc	34	25	ND-0.770	0.009



Table VI-19 (Continued)

## SUMMARY OF SAMPLE DATA

## CLEANING WATER SUBCATEGORY

<u>Pollutant</u>	<u>Number of Samples</u>	<u>Number of Times Detected</u>	<u>Concentration Range (mg/l)</u>	<u>Flow-Weighted Average Concentration (mg/l)</u>
<u>Conventional</u>				
biochemical oxygen demand (BOD <sub>5</sub> )	26	26	2.6-1,000	90
oil and grease	26	26	0-684	48
total suspended solids (TSS)	28	28	2-16,363	714
pH	26	26	1.6-11.5	NA
<u>Nonconventional</u>				
aluminum	25	17	ND-8.1	0.276
ammonia nitrogen	28	28	0-399	11
barium	26	19	ND-0.8	0.017
boron	26	16	ND-2.9	0.091
bromide	10	10	<0.4	0
calcium	26	25	ND-207	3.88
chemical oxygen demand (COD)	28	28	48-2,280	115
cyanide (amenable)	20	5	0-0.174	0
fluoride	10	10	<0.1-6.8	0.201
iron	26	20	ND-51.3	1.61
Kjeldahl nitrogen	28	25	0-3,070	127
magnesium	26	26	0.154-24.9	1.66
manganese	26	16	ND-0.519	0.017
molybdenum	26	3	ND-0.3	0.009
nitrate/nitrite	10	10	<0.1-2.1	0.012
sodium	26	25	ND-3,860	107
sulfate	10	10	<5-45	1.52
sulfide	9	9	<1	0
surfactants	27	26	ND-148	7.95

Table VI-19 (Continued)

## SUMMARY OF SAMPLE DATA

## CLEANING WATER SUBCATEGORY (Cont.)

<u>Pollutant</u>	<u>Number of Samples</u>	<u>Number of Times Detected</u>	<u>Concentration Range (mg/l)</u>	<u>Flow-Weighted Average Concentration (mg/l)</u>
<u>Nonconventional (Cont.)</u>				
tin	26	7	ND-1.2	0.033
titanium	26	17	ND-0.199	0.004
total dissolved solids (TDS)	20	17	0-13,000	928
total organic carbon (TOC)	28	28	19.5-10,038	634
total phenols	22	22	<0.001-730	36
total phosphorus	28	28	0.005-123	7
yttrium	25	3	ND-0.006	77†
<u>Priority Toxic</u>				
4. benzene	26	18	ND-0.099	0.002
7. chlorobenzene	26	2	ND-<0.001	24†
11. 1,1,1-trichloroethane	26	14	ND-0.020	0.0004
13. 1,1-dichloroethane	26	1	ND-0.003	65†
22. parachlorometa cresol	26	9	ND-0.042	0.0001
23. chloroform	26	12	ND-0.19	0.0004
24. 2-chlorophenol	26	1	ND-0.006	0.0001
26. 1,3-dichlorobenzene	26	1	ND-0.001	6†
30. 1,2-trans-dichloroethylene	26	2	ND-<0.010	36†
31. 2,4-dichlorophenol	26	1	ND-0.001	22†
38. ethylbenzene	26	3	ND-<0.010	58†
39. fluoranthene	26	6	ND-<0.010	76†
44. methylene chloride (dichloromethane)	26	23	ND-0.310	0.012
47. bromoform (tribromomethane)	26	3	ND-0.010	6†

Table VI-19 (Continued)

## SUMMARY OF SAMPLE DATA

## CLEANING WATER SUBCATEGORY (Cont.)

<u>Pollutant</u>	<u>Number of Samples</u>	<u>Number of Times Detected</u>	<u>Concentration Range (mg/l)</u>	<u>Flow-Weighted Average Concentration (mg/l)</u>
<u>Priority Toxic (Cont.)</u>				
48. dichlorobromomethane	26	2	ND-0.015	0.0001
49. trichlorofluoromethane	26	5	ND-0.034	0.004
51. chlorodibromomethane	26	2	ND-0.002	18†
55. naphthalene	26	1	ND-<0.010	42†
57. 2-nitrophenol	26	1	ND-<0.010	12†
60. 4,6-dinitro-o-cresol	26	1	ND-0.004	64†
62. N-nitrosodiphenylamine	26	13	ND-0.064	0.002
64. pentachlorophenol	26	2	ND-0.02	0.0002
65. phenol	26	19	ND-6.0	0.198
66. bis(2-ethylhexyl) phthalate	26	24	ND-0.196	0.007
67. butyl benzyl phthalate	26	2	ND-<0.010	32†
68. di-n-butyl phthalate	26	16	ND-0.023	0.002
69. di-n-octyl phthalate	26	1	ND-<0.010	7†
70. diethyl phthalate	26	14	ND-<0.010	0.0009
72. benzo(a)anthracene (1,2-benzoanthracene)	26	2	ND-<0.010	15†
73. benzo(a)pyrene (3,4-benzopyrene)	26	2	ND-<0.010	0.0008
76. chrysene	26	9	ND-<0.010	0.0003
78. anthracene	26	5	ND-<0.010	0.0001
80. fluorene	26	1	ND-<0.010	23†
81. phenanthrene	26	4	ND-<0.010	0.0001
84. pyrene	26	4	ND-<0.010	70†
85. tetrachloroethylene	26	3	ND-<0.010	0

Table VI-19 (Continued)

## SUMMARY OF SAMPLE DATA

## CLEANING WATER SUBCATEGORY (Cont.)

<u>Pollutant</u>	<u>Number of Samples</u>	<u>Number of Times Detected</u>	<u>Concentration Range (mg/l)</u>	<u>Flow-Weighted Average Concentration (mg/l)</u>
<u>Priority Toxic (Cont.)</u>				
86. toluene	26	15	ND-0.69	0.013
87. trichloroethylene	26	5	ND-<0.010	73†
89. aldrin	26	4	ND-<0.005	25†
90. dieldrin	26	1	ND-<0.005	4†
97. endosulfan sulfate	26	2	ND-<0.005	5†
98. endrin	26	2	ND-<0.005	0.0004
100. heptachlor	26	4	ND-<0.005	27†
102. alpha-BHC	26	5	ND-6†	0.1†
103. beta-BHC	26	5	ND-0.0002	9†
104. gamma-BHC	26	6	ND-<0.005	66†
105. delta-BHC	26	9	ND-0.0005	70†
114. antimony	26	6	ND-0.133	0.003
115. arsenic	26	8	ND-0.12	0.0002
119. chromium (total)	26	9	ND-0.53	0.019
120. copper	26	18	ND-1.44	0.044
121. cyanide (total)	26	28	0-0.034	0
123. mercury	26	3	ND-0.0005	8†
124. nickel	26	3	ND-0.166	0.004
125. selenium	26	8	ND-0.28	0.013
126. silver	26	3	ND-0.018	0.0002
128. zinc	26	22	ND-29.8	0.598

Table VI-19 (Continued)

## SUMMARY OF SAMPLE DATA

## FINISHING WATER SUBCATEGORY

<u>Pollutant</u>	<u>Number of Samples</u>	<u>Number of Times Detected</u>	<u>Concentration Range (mg/l)</u>	<u>Flow-Weighted Average Concentration (mg/l)</u>
<u>Conventional</u>				
Biochemical oxygen demand (BOD <sub>5</sub> )	9	9	3.8-14	6
oil and grease	9	6	0-19.7	8
total suspended solids (TSS)	9	7	0-1,359	95
pH	9	9	6.36-8.4	NA
<u>Nonconventional</u>				
aluminum	9	5	ND-9.75	2.32
barium	9	5	ND-0.065	0.022
boron	9	4	ND-0.700	
calcium	9	8	2.97-19.3	1.06
chemical oxygen demand (COD)	9	8	<5-325	17
iron	9	7	ND-9.66	1.62
magnesium	9	8	0.386-5.1	0.102
manganese	9	5	ND-0.308	0.069
sodium	9	8	11.7-318	9.73
titanium	9	3	ND-0.076	0.009
total organic carbon (TOC)	9	9	2-238	23
total phenols	9	6	<0.01-8.75	0.217
<u>Priority Toxic</u>				
4. benzene	9	2	ND-0.009	0.0005
8. 1,2,4-trichlorobenzene	9	2	ND-0.01945	0.006
11. 1,1,1-trichloroethane	9	1	ND-0.018	0.001
12. hexachloroethane	9	1	ND-0.00666	0

Table VI-19 (Continued)

## SUMMARY OF SAMPLE DATA

## FINISHING WATER SUBCATEGORY (Cont.)

<u>Pollutant</u>	<u>Number of Samples</u>	<u>Number of Times Detected</u>	<u>Concentration Range (mg/l)</u>	<u>Flow-Weighted Average Concentration (mg/l)</u>
<u>Priority Toxic (Cont.)</u>				
28. 3,3'-dichlorobenzidine	9	1	ND-0.01289	0.002
34. 2,4-dimethylphenol	9	2	ND-0.00591	0
38. ethylbenzene	9	3	ND-0.01149	0.005
44. methylene chloride (dichloromethane)	9	1	ND-0.006	0
65. phenol	9	3	ND-0.2	0.007
66. bis(2-ethylhexyl) phthalate	9	9	0.003-1.48768	0.479
68. di-n-butyl phthalate	9	6	ND-0.08085	0.031
71. dimethyl phthalate	9	2	ND-0.19438	0.034
87. trichloroethylene	9	3	ND-0.01511	0.004
114. antimony	9	2	ND-0.01	0.001
115. arsenic	9	3	ND-0.11	0.001
119. chromium (total)	9	2	ND-0.01	0.001
120. copper	9	5	ND-0.073	0.028
122. lead	9	1	ND-0.179	0.030
121. cyanide	3	2	0-0.015	0.010
123. mercury	9	3	ND-0.00025	15†
124. nickel	9	2	ND-0.04	0.004
125. selenium	9	3	ND-0.30	0.030
128. zinc	9	7	ND-0.229	0.087

NA - Average concentration is not applicable for pH.

†Concentration is in nanograms per liter.

1. All non-detected results were averaged as zero.
2. The source water concentration was subtracted from the process water concentration. If a negative number resulted, zero was used in the average.
3. Laboratory values below the method detection limit were averaged as the reported value.
4. Laboratory values reported as less than values for organic compounds were averaged as the values without the less than sign.
5. Duplicate data were treated as data for an additional sampling day.
6. For the priority toxic pollutant metals, when both the Task 1 (Inductively Coupled Plasma Optical) and Task 2 (Flame Atomic Absorption) analyses were performed, only the Task 1 test results were used in the averaging process. A metal laboratory result reported as a less than value was treated as a non-detected result in the averaging methodology.

These editing rules vary from the editing rules used to develop pollutant averages for the proposed PM&F regulation. At proposal, the following editing rules were used:

1. Non-detected values were excluded from the data base.
2. Source water concentrations were not subtracted from the process water concentration.
3. Laboratory values equal to or below the method detection limit were excluded from the data base.
4. Laboratory values reported as less than values for organic compounds were excluded from the data base. These less than values were usually equal to the method detection limit.
5. Duplicate data were treated as data for an additional sampling day.
6. For the priority metal pollutants, when both the Task 1 (Inductively Coupled Plasma Optical) and Task 2 (Flame Atomic Absorption) analyses were performed, only the Task 1 test results were used in the data base. A metal laboratory result reported as a less than value was treated as a non-detected result in the averaging methodology.

EPA's pre-proposal editing rules that excluded values in the averaging methodology lead to examination of the process water characteristics on a worse-case basis. By not considering non-detected values, the concentration average was skewed conservatively high. The post-proposal editing rule that includes all non-detected data points as zeros in the averaging of data recognizes that even though certain pollutants were not detected, the resulting data (i.e., that indicating non-detection) are valid data. These values were included in subcategory average pollutant concentration calculations to ensure proper characterization of subcategory process water instead of only characterizing a segment of the subcategory process water where pollutants were found above their detection limits.

At proposal, EPA did not subtract the source water concentration from the process water concentration prior to averaging the process water concentration because the plant's source water pollutant concentrations contribute to the overall effluent concentrations. However, EPA decided to subtract the source water concentration from the process water concentration before averaging the data for development of the final regulation. This allowed the Agency to determine the pollutants that were added to process water from the PM&F processes.

EPA used laboratory results equal to or below the method detection limit in developing the final PM&F regulation because the Agency believes that all reported values should be used to calculate average concentrations even though a value may be below a method detection limit. In addition, EPA had no reason to believe such data were not valid. Therefore, the data were used to calculate the subcategory average concentrations.

To develop the final regulation, laboratory results for organic compounds that were reported as less than values, were averaged as the value without the less than sign. As discussed above, EPA believes that all data should be used to calculate the pollutant averages for the PM&F subcategories. By using the value without the less than sign, the Agency was conservative in assuming that the pollutant was present.

The treatment of duplicate data did not change between proposal and promulgation. EPA considered duplicate data as data for an additional sampling day.

Likewise, the use of Task 1 metal analyses, instead of Task 2 metal analyses when results from both analyses were available, did not change between proposal and promulgation. EPA used Task 1 analyses results because only those results were available for all sampled processes. The use of reported less than values did



not change between the proposed and promulgated regulation. A reported metal less than value was treated as a non-detected result.

#### Pollutant Average Concentration Methodology

For the proposed PM&F rule, EPA used subcategory average pollutant concentrations to characterize PM&F process waters and then to determine which pollutants warranted control by the effluent limitations guidelines and standards for a subcategory. The Agency estimated subcategory average pollutant concentrations by obtaining an arithmetic average of the pollutant concentrations found in PM&F process waters during several sampling episodes. Based on these estimates, EPA identified pollutants present in treatable concentrations and then selected various technology options to control those pollutants.

Several commenters on the proposal stated that the subcategory average pollutant concentrations should be estimated by flow-weighting the sampling data because arithmetic averages overestimate the concentrations of the pollutants in PM&F process waters. They claimed that flow-weighted averages should be used to account for the wide variation in the amount of process water discharged by the processes that were sampled. Commenters also stated that different average pollutant concentrations should be calculated for extrusion processes in the contact cooling and heating water subcategory and for other processes in that subcategory. According to the commenters, extrusion processes have the highest water use in that subcategory and process water from those processes does not contain pollutants in high concentrations.

EPA reviewed the variation in the amount of water discharged by processes sampled during the development of the PM&F regulation. The Agency determined that there is wide variation in the discharge rates and that the variation should be considered when subcategory average pollutant concentrations are estimated. EPA also determined that flow-weighted average pollutant concentrations provide a better estimate of the pollutant concentrations found in PM&F process waters because that type of average addresses the impact of the wide variation in discharge rates. More weight is given to high flow rate processes than to low flow rate processes when flow-weighted concentrations are calculated. When arithmetic averages are calculated, all processes are given the same weight regardless of their discharge rate. In developing the final PM&F regulation, EPA relied on flow-weighted pollutant averages to estimate the pollutant concentrations found in process water discharged from processes in each subcategory.

In response to the comment concerning separate average concentrations for the extrusion processes, the Agency proportioned the flow-weighted concentrations for the contact cooling and heating water subcategory by the number of processes for each type of contact cooling and heating water process in the questionnaire data base. This gave more weight to extrusion processes because the largest number of processes in the data base for the contact cooling and heating water subcategory are extrusion processes.

Presented below is the methodology that the Agency used to flow-weight the pollutant concentration data. This methodology uses analytical results and flow data from the sampling episode; it also uses weighting factors from the questionnaire data base to determine the predominance of a type of process in the contact cooling and heating water subcategory. Table VI-20 presents the sampling data used in the example presented below. Table VI-21 presents the questionnaire data base weighting factors that were used in the concentration averaging methodology. The methodology steps described below were applied to the data in Tables VI-20 and VI-21 in the following example:

1. The processes contributing to each type of process water are separated into similar types of processes (i.e., extrusion, molding, calendering, thermoforming, and casting processes are separated within the contact cooling and heating water subcategory).

There are two extrusion processes and one molding process in the example. The extrusion processes are denoted as EX-1 and EX-2, and the molding process is denoted as MD-1 in Table VI-20.

2. The daily concentrations for each process are flow-weighted to obtain an average daily flow-weighted concentration. The process water usage flow rates measured on the sampling days are used to flow-weight the concentrations.

<u>Process</u>	<u>Average Daily Flow-Weighted Concentration (mg/l)</u>	
EX-1	$\frac{(10 \text{ mg/l})(100 \text{ l/hr}) + (30 \text{ mg/l})(140 \text{ l/hr}) + (15 \text{ mg/l})(100 \text{ l/hr})}{(100 \text{ l/hr} + 140 \text{ l/hr} + 100 \text{ l/hr})}$	= 19.7 mg/l
EX-2	$\frac{(50 \text{ mg/l})(300 \text{ l/hr}) + (10 \text{ mg/l})(400 \text{ l/hr})}{(300 \text{ l/hr} + 400 \text{ l/hr})}$	= 27 mg/l
MD-1	$\frac{(100 \text{ mg/l})(50 \text{ l/hr}) + (110 \text{ mg/l})(60 \text{ l/hr}) + (120 \text{ mg/l})(60 \text{ l/hr})}{(50 \text{ l/hr} + 60 \text{ l/hr} + 60 \text{ l/hr})}$	= 111 mg/l

Table VI-20

DATA FOR POLLUTANT X - CALCULATION OF AVERAGE CONCENTRATION EXAMPLE

<u>Process</u>	<u>Concentration*</u> <u>Day 1</u>	<u>Flow**</u> <u>Day 1</u>	<u>Concentration</u> <u>Day 2</u>	<u>Flow</u> <u>Day 2</u>	<u>Concentration</u> <u>Day 3</u>	<u>Flow</u> <u>Day 3</u>	<u>Concentration</u> <u>Dup.</u>	<u>Flow</u> <u>Dup.</u>
Extrusion (EX-1)	10	100	---	---	30	140	15	100
Extrusion (EX-2)	50	300	10	400	---	---	---	---
Molding (MD-1)	100	50	---	---	110	60	120	60

155

---

\*Concentrations are in mg/L.

\*\*Flow rates are in l/hr.

Table VI-21

QUESTIONNAIRE DATA BASE WEIGHTING FACTORS FOR  
FLOW-WEIGHTED CONCENTRATION METHODOLOGY

CONTACT COOLING WATER SUBCATEGORY

<u>Type of Process</u>	<u>Percentage of Processes* in Questionnaire Data Base</u>
Extrusion	85.05
Molding	7.48
Coating and Laminating	3.04
Thermoforming	2.33
Casting	1.40
Calendering	<u>0.70</u>
	100.00

---

\*See Table VI-6.

3. For each process, the water usage flow rates measured on the sampling days are averaged. This is the average process water usage rate.

<u>Process</u>	<u>Average Process Water Usage Rate (l/hr)</u>
EX-1	$\frac{100 + 140 + 100}{3} = 113 \text{ l/hr}$
EX-2	$\frac{300 + 400}{2} = 350 \text{ l/hr}$
MD-1	$\frac{50 + 60 + 60}{2} = 85 \text{ l/hr}$

4. The average daily flow-weighted concentrations (calculated in step 2) for all similar processes in a subcategory are flow-weighted using the average process water usage rates (calculated in step 3). For example, the average daily flow-weighted concentrations of extrusion processes within the contact cooling and heating water subcategory are flow-weighted together. This resulting concentration is the type-of-process flow-weighted concentration.

<u>Type of Process</u>	<u>Type-of-Process Flow-Weighted Concentration (mg/l)</u>
Extrusion	$\frac{(19.7 \text{ mg/l}) (113 \text{ l/hr}) + (27 \text{ mg/l}) (350 \text{ l/hr})}{(113 \text{ l/hr} + 350 \text{ l/hr})}$ = 25.2 mg/l
Molding	$\frac{(111 \text{ mg/l}) (85 \text{ l/hr})}{(85 \text{ l/hr})} = 111 \text{ mg/l}$

5. The average process water usage rates (calculated in step 3) are averaged together for all similar processes to calculate a type-of-process average water usage flow rate.

<u>Type of Process</u>	<u>Type-of-Process Average Water Usage Flow Rate (l/hr)</u>
Extrusion	$(113 \text{ l/hr} + 350 \text{ l/hr})/2 = 232 \text{ l/hr}$
Molding	85 l/hr

6. The average pollutant mass for a type of process is calculated by multiplying the type-of-process flow-weighted concentration (calculated in step 4) by the type-of-process average water usage flow rate (calculated in step 5).

<u>Type of Process</u>	<u>Average Pollutant Mass (mg/hr)</u>
Extrusion	(25.2 mg/l) (232 l/hr) = 5,850 mg/hr
Molding	(111 mg/l) (85 l/hr) = 9,440 mg/hr

7. For each type of process, the average pollutant mass (calculated in step 6) is weighted by the predominance of that type of process in the questionnaire data base. The weighted average pollutant masses for the different types of processes are then summed together. Extrusion processes comprise 85.05 percent and molding processes comprise 7.48 percent of the questionnaire data base contact cooling and heating water processes (from Table VI-21).

<u>Type of Process</u>	<u>Weighted Pollutant Mass (mg/hr)</u>
Extrusion	(0.8505) (5,850 mg/hr) = 4,970
Molding	(0.0748) (9,440 mg/hr) = <u>706</u>
	TOTAL 5,676 mg/hr

8. For each type of process, the type-of-process average water usage flow rate (calculated in step 5) is also weighted by the predominance of that type of process in the questionnaire data base. The weighted type-of-process average flows for the different types of processes in the contact cooling and heating water subcategory are summed together.

<u>Type of Process</u>	<u>Weighted Type-of-Process Average Water Usage Flow Rate (l/hr)</u>
Extrusion	(0.8505) (232 l/hr) = 197
Molding	(0.0748) (85 l/hr) = <u>6.4</u>
	TOTAL 203.4 l/hr

9. The subcategory average concentration is calculated by dividing the total weighted pollutant mass (calculated in step 7) by the total weighted flow (calculated in step 8).

Subcategory Average Concentration (mg/l)

Pollutant X             $(5,676 \text{ mg/hr}) / (203.4 \text{ l/hr}) = 27.9 \text{ mg/l}$

The calculation procedure is more simplified for the cleaning water subcategory and the finishing water subcategory because these subcategories have only one type of process (i.e., cleaning or finishing processes). The same methodology is used except for proportioning the average by type of process.

SAMPLED PLANTS WITH WASTEWATER TREATMENT SYSTEMS

Wastewater treatment technologies exist at four of the plants (i.e., plants C, E, F, and I) that were sampled in 1980, at one plant (i.e., Plant B) that was sampled in 1983, and at three plants that were sampled in 1984 (i.e., plants M, N, and R). Of the sampled treatment systems, plants I, M, N, and R had a wastewater treatment system primarily for PM&F process waters.

The treatment at Plant I consists of equalization, pH adjustment, and filtration (see Figure VI-9). Treatment at Plant M consists of filtration and settling of contact cooling water. Figure VI-12 illustrates this treatment. Process water from the grinding operation at Plant N is filtered before discharge (see Figure VI-13). Treatment for recycled contact cooling water at Plant R consists of solids skimmings from a collection sump and filtration through a bag filter (see Figure VI-17). Effluent data for these treatment processes are presented in Appendix A.

The treatment process at Plants B, C, E, and F is a lagoon that treats a combined wastewater. Effluents from the lagoons at Plants E and F were sampled during this project. These effluent data were not used in the data analyses for the PM&F regulation because they treat more than just PM&F process waters. Those data are contained in the administrative record for the regulation.

SOLUTION CASTING/SOLVENT RECOVERY SAMPLING DATA

Wastewater is also generated by the solvent recovery operation in the solution or solvent casting process. However, this wastewater does not result from the blending, molding, forming, or any processing of the plastic material and is not a process water. Samples of this wastewater indicate that its pollutant characteristics are different from the characteristics of PM&F process

waters. In addition, the Agency estimates that only eight plants in the category generate solvent recovery wastewater. For these reasons, the Agency believes that solvent recovery wastewater is best controlled on a case-by-case basis by the permit writer or control authority. Analytical data for this type of wastewater from the Agency's study of the plastics molding and forming category may be used as a guide by the permit writer. Appendix A presents wastewater pollutant characteristics for a solution casting process at Plant G. See Figure VI-7 for a process diagram.

#### TOTAL PHENOLS VERIFICATION AT PLANT F

The sample points shown in Figure VI-6 were resampled in 1984 to verify the process water total phenols concentrations at Plant F. All samples had total phenols samples of less than 0.01 mg/l. Because the concentrations from the 1980 sampling episode, ranging from <5 to 1,670 mg/l, could not be explained by plant personnel and because the 1984 sampling data do not verify the 1980 analytical results, the total phenols data from Plant F were not used to obtain a subcategory average concentration for total phenols.



## SECTION VII

### POLLUTANTS IN PLASTICS MOLDING AND FORMING PROCESS WATERS

The Agency studied the plastics molding and forming category to determine the presence of conventional, selected nonconventional, and priority toxic pollutants in PM&F process waters.

#### CONVENTIONAL POLLUTANTS

As previously mentioned, conventional pollutants are those defined in Section 304(a)(4) of the Act and any other pollutants defined by the Administrator as conventional pollutants. The list of conventional pollutants currently includes: biochemical oxygen demand (BOD), total suspended solids (TSS), fecal coliform, pH, and oil and grease.

Samples collected during the 1980, 1983, and 1984 sampling episodes for the PM&F regulation were analyzed for BOD<sub>5</sub>, TSS, oil and grease, and pH. All of these pollutants warrant further consideration for control in the cleaning water subcategory because they were found in treatable concentrations in the cleaning process waters. In the finishing water subcategory, total suspended solids (TSS) were found in concentrations that warrant control. The contact cooling and heating water subcategory does not have treatable concentrations of BOD<sub>5</sub>, oil and grease, or TSS. Refer to Table VII-1 for the average concentrations of the conventional pollutants that are controlled in each subcategory.

#### NONCONVENTIONAL POLLUTANTS

Samples collected during the 1980, 1983, and 1984 sampling episodes were also analyzed for the nonconventional pollutants listed in Table VII-2. These pollutants were selected for analysis based on knowledge of the raw materials used in the PM&F category and on the potential for those pollutants to be discharged in PM&F process waters.

Results of the sample analyses indicate that only three nonconventional pollutants were found in treatable concentrations in cleaning process waters. They are: chemical oxygen demand (COD), total organic carbon (TOC), and total phenols. Refer to Table VII-3 for the average concentrations of the nonconventional pollutants in cleaning water.

Nonconventional pollutants were not found in treatable concentrations in contact cooling and heating waters or in finishing waters.

Table VII-1

CONVENTIONAL POLLUTANT AVERAGE CONCENTRATIONS - PM&F PROCESS WATERS

<u>Conventional Pollutants</u>	<u>Average Concentrations (mg/l)**</u>		
	<u>Contact Cooling and Heating Water</u>	<u>Cleaning Water</u>	<u>Finishing Water</u>
BOD <sub>5</sub>	*	90	*
Oil and Grease	*	48	*
TSS	*	714	95
pH range	5.4-8.3	1.6-11.5	*

---

\*Average concentrations below treatable concentrations.

\*\*Subcategory average concentrations are from Table VI-19.

Table VII-2

## NONCONVENTIONAL POLLUTANTS FOR WHICH SAMPLES WERE ANALYZED

<u>Nonconventional Pollutant</u>	<u>Sampling Episode Year</u>		
	<u>1980</u>	<u>1983</u>	<u>1984</u>
Ammonia	X	X	
Boron		X	
Bromide		X	
Chemical oxygen demand (COD)	X	X	X
Cyanide (amenable)	X		
Fluoride		X	
Free chlorine		X	X
Nitrates		X	
Sulfate		X	
Sulfide		X	
Surfactants	X	X	
Total dissolved solids	X		
Total Kjehdahl nitrogen	X	X	
Total organic carbon (TOC)	X	X	X
Total phenols	X	X	X
Total phosphorus	X	X	

Table VII-3

NONCONVENTIONAL POLLUTANT AVERAGE CONCENTRATIONS -  
CLEANING WATER SUBCATEGORY

<u>Nonconventional Pollutant</u>	<u>Average Concentration (mg/l)*</u>
COD	115
TOC	634
Total Phenols	36

---

\*Average concentrations are from Table VI-19.

In the proposed PM&F regulation, the Agency indicated that although approximately 79 percent of the mass of nonconventional pollutants in contact cooling and heating waters would be removed by the proposed BPT, EPA was going to investigate the nonconventional pollutants, particularly COD and TOC, to determine the constituents of those pollutants. Subsequent to proposal, the Agency conducted a study to determine what contributes to those pollutants.

EPA reviewed the analytical data for the contact cooling and heating water samples to determine which of the pollutants that the samples were analyzed for would contribute to the COD and TOC. By doing this, the Agency determined whether the concentrations of COD and TOC in contact cooling and heating waters were solely attributed to the organic pollutants for which analyses were conducted. Results of that work indicated that other pollutants contributed to the COD and TOC because the concentrations of COD and TOC were higher than the total of the concentrations of the organic pollutants in the contact cooling and heating waters.

The Agency believes that many different non-priority organic pollutants could have contributed to the COD and TOC concentration estimates at proposal. However, EPA could not identify those pollutants because the contact cooling and heating water samples were only analyzed for conventional, selected nonconventional, and priority toxic pollutants.

As discussed in Section VI of this development document, the Agency revised its pollutant averaging methodology for the final PM&F regulation. Flow-weighted averages were calculated for the final rule to account for the different flow rates of the sampled processes. EPA believes that flow-weighted averages provide a better estimate of the pollutant concentrations than the arithmetic averages used for the proposal.

Based on the flow-weighted subcategory average concentrations for the COD and TOC, those pollutants are not present in treatable concentrations in contact cooling and heating waters. The Agency does not believe that the masses of COD and TOC in contact cooling and heating waters calculated using the flow-weighted subcategory averages are significant.

#### PRIORITY TOXIC POLLUTANTS

##### List of Pollutants

One hundred and twenty-nine priority toxic pollutants were studied for the PM&F regulation pursuant to the requirements of the Clean Water Act of 1977. These pollutants, which are listed

in Table VI-15, are members of the 65 compounds and classes of compounds referred to in Section 307(a)(1) of the Act.

From the original list of 129 priority pollutants, three pollutants were deleted in two separate amendments to 40 CFR Subchapter N, Part 401. Dichlorodifluoromethane and trichlorofluoromethane were deleted first (46 FR 79692; January 8, 1981) followed by the deletion of bis(chloromethyl) ether (46 FR 10723; February 4, 1981). The Agency concluded that deleting these compounds does not compromise adequate control over their discharge into the aquatic environment and that no adverse effects on the aquatic environment or on human health will occur as a result of deleting them from the list of priority toxic pollutants. Concentration data were obtained for these pollutants during the sampling episodes for this regulation because some of the PM&F samples were collected and analyzed prior to the deletion of these pollutants from the list of priority pollutants. These pollutants were not considered, however, for the final PM&F regulation.

Data on the concentration of asbestos in PM&F process waters are available from a small number of samples taken during the 1980 sampling program. Those data indicate that asbestos was not present or could not be interpreted because of the limited number of fibers counted. EPA did not analyze for asbestos in the 1983 and the 1984 sampling programs.

#### Exclusion of Pollutants and Subcategories

The modified Settlement Agreement in NRDC v. Train, supra, contains provisions that authorize the exclusion of priority toxic pollutants and industry subcategories from regulation in certain instances. These provisions are presented in Paragraph 8 of the modified Settlement Agreement. They are:

- "1. For a specific pollutant or a subcategory or category, equally or more stringent protection is already provided by an effluent, new source performance standard, or pretreatment standard or by an effluent limitation and guideline promulgated pursuant to Section(s) 301, 304, 306, 307(a), 307(b), and 307(c) of the Act.
2. For a specific pollutant, except for pretreatment standards, the specific pollutant is present in the effluent discharge solely as a result of its presence in intake waters taken from the same body of water into which it is discharged and, for pretreatment standards, the specific pollutant is present in the effluent which is introduced into treatment works (as defined in Section 212 of the Act) which are publicly owned solely as a

result of its presence in the point source's intake waters, provided however, that such point source may be subject to an appropriate effluent limitation for such pollutant pursuant to the requirements of Section 307.

3. For a specific pollutant, the pollutant is not detectable (with the use of analytical methods approved pursuant to 304(h) of the Act, or in instances where approved methods do not exist, with the use of analytical methods which represent state-of-the-art capability) in the direct discharges or in the effluents which are introduced into publicly-owned treatment works from sources within the subcategory or category; or is detectable in the effluent from only a small number of sources within the subcategory and the pollutant is uniquely related to only those sources; or the pollutant is present only in trace amounts and is neither causing nor likely to cause toxic effects; or is present in amounts too small to be effectively reduced by technologies known to the Administrator; or the pollutant will be effectively controlled by the technologies upon which are based other effluent limitations and guidelines, standards of performance, or pretreatment standards.
4. For a category or subcategory, the amount and the toxicity of each pollutant in the discharge does not justify developing national regulations in accordance with the schedule contained in Paragraph 7(b)."

The basis for exclusion in subparagraph 2 above for the PM&F regulation is that if a pollutant was found in a higher concentration in the plant intake water (i.e., source water) than in the process water generated by the PM&F process, that pollutant would be excluded from control. Data obtained from the sampling episodes were reviewed, therefore, to determine which, if any, of the priority pollutants were excluded from control because of this reason.

With respect to subparagraph 3 for the PM&F regulation, a pollutant was considered not detected if the laboratory reported that it was not detected or if the laboratory reported that it was detected at or below the analytical detection limit. Pollutants were excluded from control if they were not detected or detected at or below their detection limit. Refer to Table VI-17 for analytical detection limits for the priority toxic pollutants. Also for the PM&F regulation, "detected in a small number of sources" was defined as detected in two or less samples when 20 or more samples were analyzed. If a pollutant was found in two or less samples when 20 or more samples were analyzed for that pollutant, it was excluded from further consideration. Another

basis for exclusion in subparagraph 3 is that a pollutant is present in amounts too small to be effectively reduced by technologies known by the Administrator.

The PM&F category was reviewed to determine if any of the priority pollutants could be excluded based on Paragraph 8 of the Settlement Agreement. Each subcategory was also reviewed to determine if any priority pollutants could be excluded by subcategory. Results of those reviews are presented below.

PM&F Category. The Agency first applied the exclusion criterion that a pollutant was not detected or was detected at or below the analytical detection limit to exclude pollutants for the entire PM&F category. Table VII-4 lists 73 priority toxic pollutants that were not detected in any of the process water samples analyzed or were detected at or below the pollutant analytical detection limit. These pollutants are excluded from regulation for the PM&F category and were not considered further. Table VII-5 lists the priority pollutants that were considered further because they were detected above their analytical detection limit.

PM&F Subcategories. Priority pollutants listed in Table VII-5 were reviewed by subcategory to determine whether:

1. A pollutant was never detected in process water samples for this subcategory or was detected at or below the analytical detection limit;
2. A pollutant was found in a higher concentration in the plant intake water (i.e., source water) than in the process water generated by the PM&F process; and
3. A pollutant was detected in two or less samples when 20 or more samples were analyzed for that pollutant.

A pollutant was first reviewed to determine if it was found above the detection limit. If it was, the data were reviewed to determine if the pollutant was present in a higher concentration in the source water than in the process water. If the concentration was higher in the effluent, the pollutant was examined for occurrence in more than two samples if 20 or more samples were analyzed. If the pollutant passed all of these criteria, it was considered further for regulation. Table VII-6 presents an example of this exclusion methodology. Table VII-7 presents priority pollutants excluded from control for the PM&F subcategories using this methodology. Table VII-8 lists the priority pollutants that remain after the above mentioned exclusions and their subcategory average concentration (from Table VI-19).



Table VII-4

## PRIORITY POLLUTANTS EXCLUDED FROM CONTROL FOR THE PM&amp;F CATEGORY\*

699

Priority Pollutant

1. acenaphthene	52. hexachlorobutadiene
2. acrolein	53. hexachlorocyclopentadiene
3. acrylonitrile	54. isophorone
5. benzidene	56. nitrobenzene
6. carbon tetrachloride	57. 2-nitrophenol
7. chlorobenzene	58. 4-nitrophenol
9. hexachlorobenzene	59. 2,4-dinitrophenol
10. 1,2-dichloroethane	60. 4,6-dinitro-o-cresol
13. 1,1-dichloroethane	61. N-nitrosodimethylamine
14. 1,1,2-trichloroethane	63. N-nitrosodi-n-propylamine
15. 1,1,2,2-tetrachloroethane	64. pentachlorophenol
16. chloroethane	67. butyl benzyl phthalate
18. bis (2-chloroethyl) ether	72. benzo (a)anthracene (1,2-benzanthracene)
19. 2-chloroethyl vinyl ether (mixed)	74. 3,4-benzofluoranthene
20. 2-chloronaphthalene	75. benzo(k)fluoranthene (11,12-benzofluoranthene)
21. 2,4,6-trichlorophenol	76. chrysene
24. 2-chlorophenol	77. acenaphthylene
25. 1,2-dichlorobenzene	78. anthracene
26. 1,3-dichlorobenzene	79. benzo(ghi)perylene (1,11-benzoperylene)
27. 1,4-dichlorobenzene	80. fluorene
29. 1,1-dichloroethylene	81. phenanthrene
31. 2,4-dichlorophenol	82. dibenzo (a,h)anthracene (1,2,5,6-dibenzanthracene)
32. 1,2-dichloropropane	83. indeno (1,2,3-cd)pyrene (w,e,-o-phenylenepyrene)
33. 1,2-dichloropropylene (1,3-dichloropropene)	84. pyrene
34. 2,4-dimethylphenol	88. vinyl chloride (chloroethylene)
35. 2,4-dinitrotoluene	91. chlordane (technical mixture and metabolites)
36. 2,6-dinitrotoluene	95. alpha-endosulfan
37. 1,2-diphenylhydrazine	106. PCB-1242 (Arochlor 1242)
39. fluoranthene	107. PCB-1254 (Arochlor 1254)
40. 4-chlorophenyl phenyl ether	108. PCB-1221 (Arochlor 1221)
41. 4-bromophenyl phenyl ether	109. PCB-1232 (Arochlor 1232)
42. bis(2-chloroisopropyl) ether	110. PCB-1248 (Arochlor 1248)
43. bis(2-chloroethoxy) methane	111. PCB-1260 (Arochlor 1260)
45. methyl chloride (chloromethane)	112. PCB-1016 (Arochlor 1016)
46. methyl bromide (bromomethane)	113. toxaphene
51. chlorodibromomethane	116. asbestos
	129. 2,3,7,8-tetra chlorodibenzo-p-dioxin (TCDD)

\*Pollutants were either not detected in any process water samples or were detected at or below the pollutant analytical detection limit.

Table VII-5

## PRIORITY POLLUTANTS DETECTED IN PM&amp;F PROCESS WATERS

Priority Pollutant

4. benzene	89. aldrin
8. 1,2,4-trichlorobenzene	90. dieldrin
11. 1,1,1-trichloroethane	92. 4,4'-DDT
12. hexachloroethane	93. 4,4'-DDE(p,p' DDX)
22. parachlorometa cresol	94. 4,4'-DDD(p,p' TDE)
23. chloroform (trichloro- methane)	96. beta-endosulfan
28. 3,3'-dichlorobenzidine	97. endosulfan sulfate
30. 1,2-trans-dichloro- ethylene	98. endrin
38. ethylbenzene	99. endrin aldehyde
44. methylene chloride (dichloromethane)	100. heptachlor
47. bromoform (tribromo- methane)	101. heptachlor epoxide
48. dichlorobromomethane	102. alpha-BHC
55. naphthalene	103. beta-BHC
62. N-nitrosodiphenylamine	104. gamma-BHC
65. phenol	105. delta-BHC
66. bis(2-ethylhexyl) phthalate	114. antimony
68. di-n-butyl phthalate	115. arsenic
69. di-n-octyl phthalate	117. beryllium
70. diethyl phthalate	118. cadmium
71. dimethyl phthalate	119. chromium (Total)
73. benzo (a)pyrene (3,4-benzopyrene)	120. copper
85. tetrachloroethylene	121. cyanide (Total)
86. toluene	122. lead
87. trichloroethylene	123. mercury
	124. nickel
	125. selenium
	126. silver
	127. thallium
	128. zinc

Table VII-6

## EXCLUSION METHODOLOGY EXAMPLE - POLLUTANT X

<u>Process</u>	<u>Method Detection Limit (mg/l)</u>	<u>Pollutant X Concentration (mg/l)</u>					
		<u>Source</u>	<u>Day 1</u>	<u>Day 2</u>	<u>Day 3</u>	<u>Day 4</u>	<u>Day 5</u>
1	2	4	ND	(3)	ND	ND	(4)
2	2	5	(5)	ND	⑥	ND	ND
3	2	ND	+	⑦	ND	ND	ND
4	2	3	+	<del>2</del>	(3)	ND	ND

## Exclusion Methodology

1. Data are first eliminated because the pollutant was never detected or detected at or below the analytical detection limit. See sample data that have a straight line through them.
2. Data are next eliminated if the source water concentrations are equal to or greater than the effluent concentrations. See sampled data enclosed by parentheses.
3. Data are finally eliminated if only analytical results remain for two or less samples when 20 or more samples were analyzed. See sample data that are circled.

Pollutant X was excluded because it was found in two or less samples after the other data were eliminated.

Table VII-7

PRIORITY POLLUTANTS EXCLUDED FROM CONTROL

CONTACT COOLING AND HEATING WATER SUBCATEGORY

Priority Pollutants Not Detected or Detected at or Below the Analytical Detection Limit

- 8. 1,2,4-trichlorobenzene
- 28. 3,3'-dichlorobenzidine
- 38. ethylbenzene
- 48. dichlorobromomethane
- 62. N-nitrosodiphenylamine
- 114. antimony
- 115. arsenic
- 121. cyanide (Total)
- 125. selenium

Priority Pollutants with Concentrations in the Plant Intake Water Equal to or Greater Than the Effluent Concentrations

- 47. bromoform (tribromomethane)
- 87. trichloroethylene

Priority Pollutants Detected in Two or Less Samples When 20 or More Samples Were Analyzed

- 12. hexachloroethane
- 30. 1,2-trans-dichloroethylene
- 55. naphthalene
- 69. di-n-octyl phthalate
- 70. diethyl phthalate
- 71. dimethyl phthalate
- 73. benzo (a)pyrene (3,4-benzopyrene)
- 85. tetrachloroethylene
- 92. 4,4'-DDT
- 93. 4,4'-DDE(p,p'DDX)
- 94. 4,4'-DDD(p,p'TDE)
- 96. beta-endosulfan
- 97. endosulfan sulfate
- 98. endrin
- 100. heptachlor
- 101. heptachlor epoxide

CLEANING WATER SUBCATEGORY

Priority Pollutants Not Detected or Detected at or Below the Analytical Detection Limit

- 8. 1,2,4-trichlorobenzene
- 12. hexachloroethane
- 28. 3,3'-dichlorobenzidine
- 30. 1,2-trans-dichloroethylene
- 38. ethylbenzene
- 47. bromoform (tribromomethane)
- 55. naphthalene
- 69. di-n-octyl phthalate
- 70. diethyl phthalate
- 71. dimethyl phthalate
- 73. benzo (a)pyrene (3,4-benzopyrene)
- 85. tetrachloroethylene
- 87. trichloroethylene
- 90. dieldrin
- 92. 4,4'-DDT
- 93. 4,4'-DDE(p,p'DDX)
- 94. 4,4'-DDD(p,p'TDE)
- 96. beta-endosulfan
- 97. endosulfan sulfate
- 99. endrin aldehyde
- 101. heptachlor epoxide
- 117. beryllium
- 118. cadmium
- 122. lead
- 127. thallium

Priority Pollutants with Concentrations in the Plant Intake Water Equal to or Greater Than the Effluent Concentrations

- 23. chloroform
- 121. cyanide (Total)

Priority Pollutants Detected in Two or Less Samples When 20 or More Samples Were Analyzed

- 11. 1,1,1-trichloroethane
- 48. dichlorobromomethane
- 68. di-n-butyl phthalate
- 98. endrin

Table VII-7 (Continued)

PRIORITY POLLUTANTS EXCLUDED FROM CONTROL

FINISHING WATER SUBCATEGORY

Priority Pollutants Not Detected or Detected at or Below the Analytical Detection Limit

- 4. benzene
- 12. hexachloroethane
- 22. parachlorometa cresol
- 23. chloroform (trichloromethane)
- 30. 1,2-trans-dichloroethylene
- 44. methylene chloride (dichloromethane)
- 47. bromoform (tribromomethane)
- 48. dichlorobromomethane
- 55. naphthalene
- 62. N-nitrosodiphenylamine
- 69. di-n-octyl phthalate
- 70. diethyl phthalate
- 73. benzo (a)pyrene (3,4-benzopyrene)
- 85. tetrachloroethylene
- 86. toluene
- 89. aldrin
- 90. dieldrin
- 92. 4,4'-DDT
- 93. 4,4'-DDE(p,p'DDX)
- 94. 4,4'-DDD(p,p'TDE)
- 96. beta-endosulfan
- 97. endosulfan sulfate
- 98. endrin
- 99. endrin aldehyde
- 100. heptachlor
- 101. heptachlor epoxide
- 102. alpha-BHC
- 103. beta-BHC
- 104. gamma-BHC
- 105. delta-BHC
- 117. beryllium
- 118. cadmium
- 126. silver
- 127. thallium

Priority Pollutants with Concentrations in the Plant Intake Water Equal to or Greater Than the Effluent Concentrations

There are no pollutants excluded in this subcategory for this reason.

Priority Pollutants Detected in Two or Less Samples When 20 or More Samples Were Analyzed

There are no pollutants excluded in this subcategory for this reason.

Table VII-8

## PRIORITY POLLUTANTS IN PM&amp;F PROCESS WATERS

Priority Pollutants	Average Concentrations (mg/l)**		
	Contact Cooling and Heating Water	Cleaning Water	Finishing Water
4. benzene	0.012	0.002	*
8. 1,2,4-trichlorobenzene	*	*	0.006
11. 1,1,1-trichloroethane	0.024	*	0.001
22. parachlorometa cresol	0.022	0.0001	*
23. chloroform	0.001	*	*
28. 3,3'-dichlorobenzidine	*	*	0.002
38. ethylbenzene	*	*	0.005
44. methylene chloride	0.023	0.012	*
62. N-nitrosodiphenylamine	*	0.002	*
65. phenol	0.004	0.198	0.007
66. bis(2-ethylhexyl) phthalate	0.098	0.007	0.479
68. di-n-butyl phthalate	0.001	*	0.031
71. dimethyl phthalate	*	*	0.034
86. toluene	0.0001	0.013	*
87. trichloroethylene	*	*	0.004
89. aldrin	0.2†	25†	*
90. dieldrin	0.2†	*	*
99. endrin aldehyde	0.3†	*	*
100. heptachlor	*	27†	*
102. alpha-BHC	36†	0.1†	*
103. beta-BHC	9†	9†	*
104. gamma-BHC	2†	66†	*
105. delta-BHC	40†	70†	*
114. antimony	*	0.003	0.001
115. arsenic	*	0.0002	0.001
117. beryllium	19†	*	*
118. cadmium	0.0007	*	*

Table VII-8 (Continued)

## PRIORITY POLLUTANTS IN PM&amp;F PROCESS WATERS

		<u>Average Concentrations (mg/l)**</u>		
<u>Priority Pollutants</u>		<u>Contact Cooling and Heating Water</u>	<u>Cleaning Water</u>	<u>Finishing Water</u>
119.	chromium (Total)	0.002	0.019	0.001
120.	copper	0.001	0.044	0.028
121.	cyanide (Total)	*	*	0.010
122.	lead	0.100	*	0.030
123.	mercury	0.1†	8†	15†
124.	nickel	0.003	0.004	0.004
125.	selenium	*	0.013	0.030
126.	silver	56†	0.0002	*
127.	thallium	0.0008	*	*
128.	zinc	0.009	0.598	0.087

175

---

\*Pollutant is not considered further in this subcategory.

\*\*Average concentrations are from Table VI-19.

†Concentration is in nanograms per liter.

The subcategory average concentrations for the priority pollutants were compared with treatability limits for treatment technologies most capable of effectively removing the pollutants. These treatability limits are presented in Table VII-9.

Because the treatability limits are based on "best-case" treatment technologies, priority pollutants with a concentration greater than the treatability limit were considered further for control. The priority pollutants that were present at concentrations higher than the treatable limits and their average concentrations are presented in Table VII-10. Priority pollutants with a subcategory average below the treatability limit were considered present in amounts too small to be effectively reduced by technologies known to the Administrator.

#### POLLUTANTS CONSIDERED FOR REGULATION

The following discussions address the pollutants listed in Tables VII-1, VII-3, and VII-8. The discussions include the source of the pollutant; whether it is a naturally occurring element, processed metal, or a manufactured product; general physical properties and the form of the pollutant; and toxic effects of the pollutant on humans and other animals.

#### Conventional Pollutants

Biochemical Oxygen Demand (BOD<sub>5</sub>). Biochemical oxygen demand is not a specific pollutant, but a measure of the relative oxygen requirements of wastewaters. The BOD<sub>5</sub> test measures the oxygen required for the biochemical degradation of organic material (carbonaceous demand) and the oxygen used to oxidize inorganic material such as sulfides and ferrous iron. It also may measure the oxygen used to oxidize reduced forms of nitrogen (nitrogenous demand) unless their oxidation is prevented by the use of an inhibitor.

Many wastewaters contain more oxygen-demanding materials than the amount of dissolved oxygen available in air-saturated water. Therefore, it is necessary to dilute the sample, add nutrients, and maintain the pH in a range suitable for bacterial growth. When analyzing those wastewaters, complete stabilization of a sample may require a period of incubation too long for practical purposes. For this reason, a five day period was selected as the standard incubation period.

Oil and Grease. Oil and grease are taken together as one pollutant. Some of its components are:

1. Light Hydrocarbons - These include light fuels such as gasoline, kerosene, and jet fuel, and miscellaneous solvents used



Table VII-9  
POLLUTANT TREATABILITY LIMITS\*

<u>Priority Pollutant</u>	<u>Treatability Limit (mg/l)</u>
4. benzene	0.050
8. 1,2,4-trichlorobenzene	0.010
11. 1,1,1-trichloroethane	0.100
22. parachlorometa cresol	0.050
23. chloroform	0.100
28. 3,3'-dichlorobenzidine	0.010
38. ethylbenzene	0.050
44. methylene chloride	0.100
62. N-nitrosodiphenylamine	0.001 to 0.010
65. phenol	0.050
66. bis(2-ethylhexyl) phthalate	0.010
68. di-n-butyl phthalate	0.025
71. dimethyl phthalate	0.001 to 0.010
86. toluene	0.050
87. trichloroethylene	0.100
89. aldrin	0.001
90. dieldrin	0.001
99. endrin aldehyde	≤0.001
100. heptachlor	≤0.001
102. alpha-BHC	0.001
103. beta-BHC	0.001
104. gamma-BHC	0.001
105. delta-BHC	0.001
114. antimony	0.47
115. arsenic	0.34
117. beryllium	0.200
118. cadmium	0.049
119. chromium	0.07

Table VII-9 (Continued)  
 POLLUTANT TREATABILITY LIMITS\*

<u>Priority Pollutant</u>	<u>Treatability Limit (mg/l)</u>
120. copper	0.39
121. cyanide	0.047
122. lead	0.080
123. mercury	0.036
124. nickel	0.22
125. selenium	0.20
126. silver	0.070
127. thallium	0.200
128. zinc	0.23

---

\*Treatability limits for organic priority pollutants (excluding pesticides) are from U.S. EPA, Treatability of Organic Priority Pollutants - Part C - Their Estimated (30-Day Ave.) Treated Effluent Concentrations - A Molecular Engineering Approach, Murray P. Strier, 11 July 1978.

Treatability limits for priority pollutant pesticides are from U.S. EPA, Treatability of Organic Priority Pollutants - Part D - The Pesticides - Their Estimated (30-Day Ave.) Treated Effluent Concentrations, Murray P. Strier, 26 December 1978.

Treatability limits for the priority metal pollutants are from the U.S. EPA, Development Document for Effluent Guidelines and Standards for the Nonferrous Metals Manufacturing Point Source Category Phase II, July 1984.

Table VII-10

## PRIORITY POLLUTANTS PRESENT IN TREATABLE CONCENTRATIONS

<u>Priority Pollutant</u>	<u>Average Concentration (mg/l)</u>		
	<u>Contact Cooling and Heating Waters</u>	<u>Cleaning Waters</u>	<u>Finishing Waters</u>
65. phenol	*	0.198	*
66. bis(2-ethylhexyl) phthalate	0.098	*	0.479
68. di-n-butyl phthalate	*	*	0.031
71. dimethyl phthalate	*	*	0.034
128. zinc	*	0.598	*

179

---

\*Pollutant not found in treatable concentrations for this subcategory.

for industrial processing, degreasing, or cleaning purposes. The presence of these light hydrocarbons may make the removal of other heavier oil wastes more difficult.

2. Heavy Hydrocarbons, Fuels, and Tars - These include the crude oils, diesel oils, #6 fuel oil, residual oils, slop oils, and in some cases, asphalt and road tar.

3. Lubricants and Cutting Fluids - These generally fall into two classes: non-emulsifiable oils such as lubricating oils and greases and emulsifiable oils such as water soluble oils, rolling oils, cutting oils, and drawing compounds. Emulsifiable oils may contain fat, soap, or various other additives.

4. Vegetable and Animal Fats and Oils - These originate primarily from processing of foods and natural products.

Oil and grease can settle or float and may exist as solids or liquids depending on factors such as method of use, production process, and temperature of water.

Even in small quantities, oil and grease cause troublesome taste and odor problems. Scum lines from these pollutants are produced on treatment basin walls and on other containers. Fish and water fowl are adversely affected by oils in their habitat. Oil emulsions may adhere to the gills of fish causing suffocation, and the flesh of fish is tainted when microorganisms that were exposed to waste oil are eaten. Deposition of oil in the bottom sediments of water can inhibit normal benthic growth and oil and grease exhibit an oxygen demand.

Many of the toxic organic pollutants may be distributed between the oil phase and the aqueous phase in industrial wastewaters. The presence of phenols, PCB's, PAH's, and almost any other organic pollutant in the oil and grease make characterization of this pollutant almost impossible. The other organics add to the objectionable nature of the oil and grease.

Levels of oil and grease that are toxic to aquatic organisms vary greatly, depending on the type and the species susceptibility. Crude oil in concentrations as low as 0.3 mg/l has been reported as extremely toxic to freshwater fish. It has been recommended that public water supply sources be essentially free from oil and grease.

Oil and grease in quantities of 100 liters per square kilometer cause a sheen on the surface of a body of water. The presence of oil slicks decreases the aesthetic value of a waterway.

pH. Although not a specific pollutant, pH is related to the acidity or alkalinity of a wastewater. It is not, however, a measure of either. The term pH is used to describe the hydrogen ion concentration (or activity) present in a given solution. Values for pH range from 0 to 14; these numbers are the negative logarithms of the hydrogen ion concentrations. A pH of 7 indicates neutrality. Solutions with a pH above 7 are alkaline, while those solutions with a pH below 7 are acidic. The relationship of pH and acidity and alkalinity is not necessarily linear or direct. Knowledge of the water pH is useful in determining necessary measures for corrosion control, sanitation, and disinfection. Its value is also necessary in the treatment of industrial wastewaters to determine amounts of chemicals required to remove pollutants and to measure their effectiveness. Removal of pollutants, especially dissolved solids is affected by the pH of the wastewater.

Waters with a pH below 6.0 are corrosive to treatment facilities, distribution lines, and household plumbing fixtures and can thus add constituents to drinking water such as iron, copper, zinc, cadmium, and lead. The hydrogen ion concentration can affect the taste of the water; at a low pH water tastes sour. The bactericidal effect of chlorine is weakened as the pH increases.

Extremes of pH or rapid pH changes can exert stress conditions on or kill aquatic life. Even moderate changes from acceptable criteria limits of pH are deleterious to some aquatic species.

The relative toxicity to aquatic life of many materials is increased by changes in the water pH. For example, metalocyanide complexes can increase a thousand-fold in toxicity with a drop of 1.5 pH units.

Because of the universal nature of pH and its effect on water quality and treatment, it is controlled by the effluent limitations guidelines and standards for many industry categories. A neutral pH range (approximately 6 to 9) is generally desired because either extreme beyond this range has a deleterious effect on receiving waters and on other wastewater constituents.

Total Suspended Solids (TSS). Suspended solids include both organic and inorganic materials. The inorganic compounds include sand, silt, and clay. The organic fraction includes such materials as grease, oil, tar, and animal and vegetable waste products. These solids may settle out rapidly; bottom deposits are often a mixture of both organic and inorganic solids. Solids may be suspended in water for a time and then settle to the bed of the stream or lake. Solids discharged with domestic wastes may be inert, slowly biodegradable materials, or rapidly decomposable substances. While in suspension, suspended solids increase the

turbidity of the water, reduce light penetration, and impair the photosynthetic activity of aquatic plants.

Suspended solids in water interfere with many industrial processes and cause foaming in boilers and incrustations on equipment exposed to such water, especially as the temperature rises. They are undesirable in process water used in many manufacturing processes and in cooling water systems.

Solids in suspension are aesthetically displeasing. When they settle to form sludge deposits on the stream or lake bed, they often cause damage to aquatic life. Solids, when transformed to sludge deposits, may do a variety of damaging things, including blanketing the stream or lake bed and thereby destroying the living spaces for those benthic organisms that would otherwise occupy the habitat. Organic solids use a portion or all of the dissolved oxygen available in the area and also serve as a food source for sludgeworms and associated organisms.

Suspended solids may kill fish and shellfish by causing abrasive injuries and by clogging the gills and respiratory passages of various aquatic fauna. Indirectly, suspended solids are inimical to aquatic life because they screen out light, and they promote and maintain the development of noxious conditions through oxygen depletion. This results in the killing of fish and fish food organisms. Suspended solids also reduce the recreational value of the water.

#### Nonconventional Pollutants

Chemical Oxygen Demand (COD). COD is a test that measures the organic matter in wastewater by chemical oxidation. It is not a measure of one particular pollutant. The oxygen equivalent (i.e., carbon dioxide, CO<sub>2</sub>) of the organic matter that can be oxidized is measured by using a strong chemical oxidizing agent in an acidic medium. Potassium dichromate is an excellent oxidizing agent for this test. The principal reaction using dichromate as the oxidizing agent may be generally represented by the following unbalanced equation:

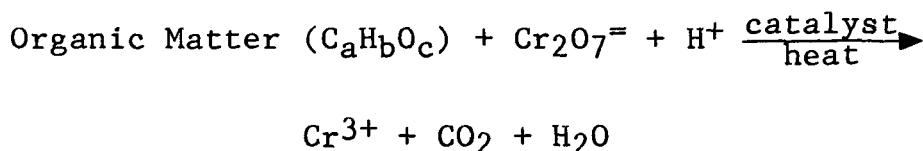

The COD of wastewater is usually higher than the BOD<sub>5</sub> because more compounds can be chemically oxidized than can be biologically oxidized. COD can be correlated with BOD<sub>5</sub> for many kinds of wastewater. This can be quite useful because COD test results can be obtained in three hours versus the five days needed to obtain BOD<sub>5</sub> test results.

Total Organic Carbon (TOC). TOC is another test to determine the organic matter present in wastewater; it is especially applicable to small concentrations of organic matter. The test is performed by injecting a known quantity of sample into a high-temperature furnace. The organic carbon is oxidized to carbon dioxide in the presence of a catalyst and the carbon dioxide is quantitatively measured with an infrared analyzer. TOC also measures more than one pollutant.

Phenols (Total). Total phenols are measured using the 4-AAP (4-aminoantipyrine) method. This analytical procedure measures the color development of reaction products between 4-AAP and some phenols. The results are reported as phenol. Thus, "total phenols" is not actually total phenols because many phenols (notably nitrophenols) do not react. Also, because each reacting phenol contributes to the color development to a different degree and because each phenol has a molecular weight different from others and from phenol itself, analyses of several mixtures containing the same total concentration of several phenols will give different numbers depending on the proportions of the phenols in the particular mixture. Despite these limitations, the total phenols method is useful when the mix of phenols is relatively constant and an inexpensive monitoring method is desired.

#### Priority Toxic Pollutants

4. Benzene. Benzene ( $C_6H_6$ ) is a clear, colorless liquid obtained mainly from petroleum feedstocks using several different processes. Some is recovered from light oils obtained from coal carbonization gases. Benzene boils at  $80^\circ C$  and has a vapor pressure of 100 mm of mercury at  $26^\circ C$ . It is slightly soluble in water (1.8 g/l at  $25^\circ C$ ) and it dissolves in hydrocarbon solvents. Annual production in the United States is three to four million tons.

Most of the benzene used in the United States goes into chemical manufacture. About half of that is converted to ethylbenzene which is used to make styrene. Some benzene is used in motor fuels.

According to numerous published studies, benzene is harmful to human health. Most studies relate effects of inhaled benzene vapors. These effects include nausea, loss of muscle coordination, and excitement followed by depression and coma. Death is usually the result of respiratory or cardiac failure. Two specific blood disorders are related to benzene exposure. One of these, acute myelogenous leukemia, represents a carcinogenic effect of benzene. However, most human exposure data are based on exposure in occupational settings and benzene carcinogenesis is not firmly established.

Oral administration of benzene to laboratory animals produced leukopenia, a reduction in the number of leukocytes in the blood. Subcutaneous injection of benzene-oil solutions has produced suggestive, but not conclusive, evidence of benzene carcinogenesis.

Benzene demonstrated teratogenic effects in laboratory animals, and mutagenic effects in humans and other animals.

For maximum protection of human health from the potential carcinogenic effects of exposure to benzene through ingestion of water and contaminated aquatic organisms, the ambient water concentration is zero. Concentrations of benzene estimated to result in additional lifetime cancer risk at levels of  $10^{-7}$ ,  $10^{-6}$ , and  $10^{-5}$  are 0.000066 mg/l, 0.00066 mg/l, and 0.0066 mg/l, respectively.

8. 1,2,4-Trichlorobenzene. 1,2,4-Trichlorobenzene ( $C_6H_3Cl_3$ , 1,2,4-TCB) is a liquid at room temperature, solidifying to a crystalline solid at  $17^\circ C$  and boiling at  $214^\circ C$ . It is produced by liquid phase chlorination of benzene in the presence of a catalyst. Its vapor pressure is 4 mm Hg at  $25^\circ C$ . 1,2,4-TCB is insoluble in water and soluble in organic solvents. Annual United States production is in the range of 15,000 tons. 1,2,4-TCB is used in limited quantities as a solvent and as a dye carrier in the textile industry. It is also used as a heat transfer medium and as a transfer fluid. The compound can be selectively chlorinated to 1,2,4,5-tetrachlorobenzene using iodine plus antimony trichloride as catalyst.

No reports are available regarding the toxic effects of 1,2,4-TCB on humans. Limited data from studies on effects in laboratory animals fed 1,2,4-TCB indicate depression of activity at low doses and predeath extension convulsions at lethal doses. Metabolic disturbances and liver changes were also observed. Studies for the purpose of determining teratogenic or mutagenic properties of 1,2,4-TCB have not been conducted. No studies have been made of carcinogenic behavior of 1,2,4-TCB administered orally.

For the prevention of adverse effects due to the organoleptic properties of 1,2,4-trichlorobenzene in water, the water quality criterion is 0.013 mg/l.

11. 1,1,1-Trichloroethane. 1,1,1-Trichloroethane is one of the two possible trichloroethanes. It is manufactured by hydrochlorinating vinyl chloride to 1,1-dichloroethane which is then chlorinated to the desired product. 1,1,1-Trichloroethane is a liquid at room temperature with a vapor pressure of 96 mm of mercury at  $20^\circ C$  and a boiling point of  $74^\circ C$ . Its formula is  $CCl_3CH_3$ . It is slightly soluble in water (0.48 g/l) and is very soluble in



organic solvents. The United States annual production is greater than one-third of a million tons. 1,1,1-Trichloroethane is used as an industrial solvent and degreasing agent.

Most human toxicity data for 1,1,1-trichloroethane relate to inhalation and dermal exposure routes. Limited data are available for determining toxicity of ingested 1,1,1-trichloroethane, and those data are all for the compound itself, not solutions in water. No data are available regarding its toxicity to fish and aquatic organisms. For the protection of human health from the toxic properties of 1,1,1-trichloroethane ingested through the consumption of water and fish, the ambient water criterion is 18.4 mg/l. The criterion is based on results of bioassays for possible carcinogenicity.

22. Para-chloro-meta-cresol. Para-chloro-meta-cresol ( $\text{ClC}_7\text{H}_6\text{OH}$ ) is thought to be a 4-chloro-3-methyl-phenol (4-chloro-meta-cresol, or 2-chloro-5-hydroxy-toluene), but is also used by some authorities to refer to 6-chloro-3-methyl-phenol (6-chloro-meta-cresol, or 4-chloro-3-hydroxy-toluene), depending on whether the chlorine is considered to be para to the methyl or to the hydroxy group. For the purposes of this document, the pollutant is assumed to be 2-chloro-5-hydroxy-toluene. This pollutant is a colorless crystalline solid melting at 66 to 68°C. It is slightly soluble in water and soluble in organic solvents. This pollutant reacts with 4-aminoantipyrene to give a colored product and contributes, therefore, to the nonconventional pollutant "total phenols." No information on manufacturing methods or volumes produced was found.

Para-chloro-meta cresol (abbreviated here as PCMC) is marketed as a microbicide and was proposed as an antiseptic and disinfectant more than 40 years ago. It is used in glues, gums, paints, inks, textiles, and leather goods.

Although no human toxicity data are available for PCMC, studies on laboratory animals have demonstrated that this pollutant is toxic when administered subcutaneously and intravenously. Death was preceded by severe muscle tremors. At high dosages kidney damage occurred. On the other hand, an unspecified isomer of chlorocresol, presumed to be PCMC, is used at a concentration of 0.15 percent to preserve mucous heparin, a natural product administered intravenously as an anticoagulant. No information was found regarding possible teratogenicity or carcinogenicity of PCMC.

23. Chloroform. Chloroform, also called trichloromethane, is a colorless liquid manufactured commercially by chlorination of methane. Careful control of conditions maximizes chloroform

production, but other products must be separated. Chloroform boils at 61°C and has a vapor pressure of 200 mm of mercury at 25°C. It is slightly soluble in water (8.22 g/l at 20°C) and readily soluble in organic solvents.

Chloroform is used as a solvent and to manufacture refrigerants, pharmaceuticals, plastics, and anesthetics. It is seldom used as an anesthetic.

Toxic effects of chloroform on humans include central nervous system depression, gastrointestinal irritation, liver and kidney damage and possible cardiac sensitization to adrenalin. Carcinogenicity has been demonstrated for chloroform using laboratory animals.

For the maximum protection of human health from the potential carcinogenic effects of exposure to chloroform through ingestion of water and contaminated aquatic organisms, the ambient water concentration is zero. Concentrations of chloroform estimated to result in additional lifetime cancer risks at the levels of  $10^{-7}$ ,  $10^{-6}$ , and  $10^{-5}$  are 0.000019 mg/l, 0.00019 mg/l, and 0.0019 mg/l, respectively.

28. 3,3'-Dichlorobenzidine. 3,3'-Dichlorobenzidine (DCB) or dichlorobenzidine (4,4'-diamino-3,3'-dichlorobiphenyl) is used in the production of dyes and pigments and as a curing agent for polyurethanes. The molecular formula of dichlorobenzidine is  $C_{12}H_{10}Cl_2N_2$  and the molecular weight is 253.13.

DCB forms brownish needles with a melting point of 132 to 133°C. It is readily soluble in alcohol, benzene, and glacial acetic acid, slightly soluble in HCl, and sparingly soluble in water (0.7 g/l at 15°C). When combined with ferric chloride or bleaching powder, a green color is produced.

The affinity of DCB for suspended particulates in water is not clear; its basic nature suggests that it may be fairly tightly bound to humic materials in soils. Soils may be moderate to long term reservoirs for DCB.

Pyrolysis of DCB will most likely lead to the release of HCl. Because of the halogen substitution, DCB compounds probably biodegrade at a slower rate than benzidine alone. The photochemistry of DCB is not completely known. DCB may photodegrade to benzidine.

Assuming the clean air concentrations of ozone ( $2 \times 10^{-9}$ ) and an average atmospheric concentration of hydroxyl radicals ( $3 \times 10^{-15}$  M), the half-life for oxidation of DCB by either of these chemical compounds is on the order of one and one to 10 days,

respectively. Furthermore, assuming a representative concentration of  $10^{-10}$  M for peroxy radicals in sunlit oxygenated water, the half-life for oxidation by these compounds is approximately 100 days, given the variability of environmental conditions.

The data base available for dichlorobenzidines and freshwater organisms is limited to one test on bioconcentration of 3,3'-dichlorobenzidine. No statement can be made concerning acute or chronic toxicity of this pollutant.

No saltwater organisms have been tested with any dichlorobenzidine; no statement can be made concerning acute or chronic toxicity for that pollutant on saltwater organisms.

For the maximum protection of human health from the potential carcinogenic effects due to exposure of dichlorobenzidine through ingestion of contaminated water and contaminated aquatic organisms, the ambient water concentration should be zero based on the non-threshold assumption for this chemical. However, zero level may not be attainable at the present time. Therefore, the levels that may result in incremental increase of cancer risk over the lifetime were estimated at  $10^{-5}$ ,  $10^{-6}$ , and  $10^{-7}$ . The corresponding recommended criteria are 0.103 ug/l, 0.010 ug/l, and 0.001 ug/l, respectively. If the above estimates are made for consumption of aquatic organisms only, excluding consumption of water, the levels are 0.204 ug/l, 0.020 ug/l, and 0.002 ug/l, respectively.

38. Ethylbenzene. Ethylbenzene is a colorless, flammable liquid manufactured commercially from benzene and ethylene. Approximately half of the benzene used in the United States goes into the manufacture of more than three million tons of ethylbenzene annually. Ethylbenzene boils at  $136^{\circ}\text{C}$  and has a vapor pressure of 7 mm Hg at  $20^{\circ}\text{C}$ . It is slightly soluble in water (0.14 g/l at  $15^{\circ}\text{C}$ ) and is very soluble in organic solvents.

About 98 percent of the ethylbenzene produced in the United States goes into the production of styrene, much of which is used in the plastics and synthetic rubber industries. Ethylbenzene is a constituent of xylene mixtures used as diluents in the paint industry, agricultural insecticide sprays, and gasoline blends.

Although humans are exposed to ethylbenzene from a variety of sources in the environment, little information on effects of ethylbenzene in man or animals is available. Inhalation can irritate eyes, affect the respiratory tract, or cause vertigo. In laboratory animals, ethylbenzene exhibited low toxicity. There are no data available on teratogenicity, mutagenicity, or carcinogenicity of ethylbenzene.

Criteria are based on data derived from inhalation exposure limits. For the protection of human health from the toxic properties of ethylbenzene ingested through water and contaminated aquatic organisms, the ambient water quality criterion is 1.4 mg/l.

44. Methylene Chloride. Methylene chloride, also called dichloromethane ( $\text{CH}_2\text{Cl}_2$ ), is a colorless liquid manufactured by chlorination of methane or methyl chloride followed by separation from the higher chlorinated methanes formed as coproducts. Methylene chloride boils at  $40^\circ\text{C}$  and has a vapor pressure of 362 mm of mercury at  $20^\circ\text{C}$ . It is slightly soluble in water (20 g/l at  $20^\circ\text{C}$ ) and very soluble in organic solvents. The United States annual production is about 250,000 tons.

Methylene chloride is a common industrial solvent found in insecticides, metal cleaners, paint, and paint and varnish removers.

Methylene chloride is not generally regarded as highly toxic to humans. Most human toxicity data are for exposure by inhalation. Inhaled methylene chloride acts as a central nervous system depressant. There is also evidence that the pollutant causes heart failure when large amounts are inhaled.

Methylene chloride did produce mutation in tests for this effect. In addition, a bioassay recognized for its extremely high sensitivity to strong and weak carcinogens produced results that were marginally significant. Thus, potential carcinogenic effects of methylene chloride are not confirmed or denied, but are under continuous study. These studies are difficult to conduct for two reasons. First, the low boiling point ( $40^\circ\text{C}$ ) of methylene chloride makes it difficult to maintain the compound at  $37^\circ\text{C}$  during incubation. Secondly, all impurities must be removed because the impurities themselves may be carcinogenic. These complications also make the test results difficult to interpret.

62. N-nitrosodiphenylamine. N-nitrosodiphenylamine [ $(\text{C}_6\text{H}_5)_2\text{NNO}$ ], also called nitrous diphenylamide, is a yellow crystalline solid manufactured by nitrosation of diphenylamine. It melts at  $66^\circ\text{C}$  and is insoluble in water, but soluble in several organic solvents other than hydrocarbons. Production in the United States has approached 1,500 tons per year. The compound is used as a retarder for rubber vulcanization and as a pesticide for control of scorch (a fungus disease of plants).

N-nitroso compounds are acutely toxic to every animal species tested and are also poisonous to humans. N-nitrosodiphenylamine toxicity in adult rats lies in the mid range of the values for 60 N-nitroso compounds tested. Liver damage is the principal toxic

effect. N-nitrosodiphenylamine, unlike many other N-nitrosoamines, does not show mutagenic activity. N-nitrosodiphenylamine has been reported by several investigations to be non-carcinogenic. However, the pollutant is capable of trans-nitrosation and could thereby convert other amines to carcinogenic N-nitrosoamines. Sixty-seven of 87 N-nitrosoamines studied were reported to have carcinogenic activity. No water quality criteria have been proposed for N-nitrosodiphenylamine.

65. Phenol. Phenol, also called hydroxybenzene and carboic acid, is a clear, colorless, hygroscopic, deliquescent, crystalline solid at room temperature. Its melting point is 43°C and its vapor pressure at room temperature is 0.35 mm Hg. It is very soluble in water (67 gm/l at 16°C) and can be dissolved in benzene, oils, and petroleum solids. Its formula is C<sub>6</sub>H<sub>5</sub>OH.

Although a small percent of the annual production of phenol is derived from coal tar as a naturally occurring product, most of the phenol is synthesized. Two of the methods are fusion of benzene sulfonate with sodium hydroxide and oxidation of cumene followed by cleavage with a catalyst. Annual production in the United States is in excess of one million tons. Phenol is generated during distillation of wood and the microbiological decomposition of organic matter in the mammalian intestinal tract.

Phenol is used as a disinfectant, in the manufacture of resins, dyestuffs, and pharmaceuticals, and in the photo processing industry. In this discussion, phenol is the specific compound that is separated by methylene chloride extraction of an acidified sample and identified and quantified by GC/MS. Phenol also contributes to the "Total Phenols," discussed elsewhere, which are determined by the 4-AAP colorimetric method.

Phenol exhibits acute and sub-acute toxicity in humans and laboratory animals. Acute oral doses of phenol in humans cause sudden collapse and unconsciousness by its action on the central nervous system. Death occurs by respiratory arrest. Sub-acute oral doses in mammals are rapidly absorbed then quickly distributed to various organs, then cleared from the body by urinary excretion and metabolism. Long term exposure by drinking phenol contaminated water has resulted in statistically significant increase in reported cases of diarrhea, mouth sores, and burning of the mouth. In laboratory animals, long term oral administration at low levels produced slight liver and kidney damage. No reports were found regarding carcinogenicity of phenol administered orally - all carcinogenicity studies were skin tests.

For the protection of human health from phenol ingested through water and through contaminated aquatic organisms the concentration in water should not exceed 3.4 mg/l.

Fish and other aquatic organisms demonstrated a wide range of sensitivities to phenol concentration. However, acute toxicity values were at moderate levels when compared to other organic priority pollutants.

66-71. Phthalate Esters. Phthalic acid, or 1,2-benzenedicarboxylic acid, is one of three isomeric benzenedicarboxylic acids produced by the chemical industry. The other two isomeric forms are called isophthalic and terephthalic acids. The formula for all three acids is  $C_6H_4(COOH)_2$ . Some esters of phthalic acid are designated as toxic pollutants. They are discussed as a group here and specific properties of individual phthalate esters in PM&F process waters are then discussed.

Phthalic acid esters are manufactured in the United States at an annual rate in excess of one billion pounds. They are used as plasticizers - primarily in the production of polyvinyl chloride (PVC) resins. The most widely used phthalate plasticizer is bis (2-ethylhexyl) phthalate which accounts for nearly one-third of the phthalate esters produced. This particular ester is commonly referred to as dioctyl phthalate (DOP) and should not be confused with one of the less used esters, di-n-octyl phthalate, which is also used as a plasticizer. In addition to these two isomeric dioctyl phthalates, four other esters, also used primarily as plasticizers, are designated as toxic pollutants. They are: butyl benzyl phthalate, di-n-butyl phthalate, diethyl phthalate, and dimethyl phthalate.

Industrially, phthalate esters are prepared from phthalic anhydride and the specific alcohol to form the ester. Some evidence is available suggesting that phthalic acid esters also may be synthesized by certain plant and animal tissues. The extent to which this occurs in nature is not known.

Phthalate esters used as plasticizers can be present in concentrations up to 60 percent of the total weight of the plastic. The plasticizer is not linked by primary chemical bonds to the resin. Rather, it is locked into the structure of intermeshing polymer molecules and held by van der Waals forces. The result is that the plasticizer is easily extracted. Plasticizers are responsible for the odor associated with new plastic toys or flexible sheet that has been contained in a sealed package.

Although the phthalate esters are not soluble or are only very slightly soluble in water, they do migrate into aqueous solutions placed in contact with the plastic. Thus, industrial facilities with tank linings, wire and cable coverings, tubing, and sheet flooring of PVC are expected to discharge some phthalate esters in their raw waste. In addition to their use as plasticizers,

phthalate esters are used in lubricating oils and pesticide carriers. These also can contribute to industrial discharge of phthalate esters.

From the accumulated data on acute toxicity in animals, phthalate esters may be considered as having a rather low order of toxicity. Human toxicity data are limited. The toxic effect of the esters is most likely due to one of the metabolic products, in particular the monoester. Oral acute toxicity in animals is greater for the lower molecular weight esters than for the higher molecular weight esters.

Orally administered phthalate esters generally produced enlarging of liver and kidney and atrophy of testes in laboratory animals. Specific esters produced enlargement of heart and brain, splenitis, and degeneration of central nervous system tissue.

Subacute doses administered orally to laboratory animals produced some decrease in growth and degeneration of the testes. Chronic studies in animals showed similar effects to those found in acute and subacute studies, but to a much lower degree. The same organs were enlarged, but pathological changes were not usually detected.

A recent study of several phthalic esters produced suggestive but not conclusive evidence that dimethyl, diethyl, and bis(2-ethylhexyl) phthalates have a cancer liability. Phthalate esters do bioconcentrate in fish. The factors, weighted for relative consumption of various aquatic and marine food groups, are used to calculate ambient water quality criteria for phthalate esters. The values are included in the discussion of the specific esters.

Studies of toxicity of phthalate esters in freshwater and salt water organisms are scarce. A chronic toxicity test with bis(2-ethylhexyl) phthalate showed that significant reproductive impairment occurred at 0.003 mg/l in the freshwater crustacean, Daphnia magna. In acute toxicity studies, saltwater fish and organisms showed sensitivity differences of up to eight-fold to butyl benzyl, diethyl, and dimethyl phthalates. This suggests that each ester must be evaluated individually for toxic effects.

In addition to the general remarks and discussion on phthalate esters, specific information on bis(2-ethylhexyl) phthalate, di-n-butyl phthalate, and dimethyl phthalate is presented below.

66. Bis(2-ethylhexyl) phthalate. Little information is available about the physical properties of bis(2-ethylhexyl) phthalate. It is a liquid boiling at 387°C at 5mm of mercury and is insoluble in water. Its formula is  $C_6H_4(COOC_8H_{17})_2$ . This toxic pollutant constitutes about one-third of the phthalate

ester production in the U.S. It is commonly referred to as dioctyl phthalate, or DOP, in the plastics industry where it is the most extensively used compound for the plasticization of polyvinyl chloride (PVC).

Bis(2-ethylhexyl) phthalate has been shown to induce liver tumors in both sexes of Fisher 344 rats and B<sub>6</sub>C<sub>3</sub>F<sub>1</sub> mice. The most sensitive animals were the male B<sub>6</sub>C<sub>3</sub>F<sub>1</sub> mice. Carcinogenicity bioassays, conducted for the Carcinogenesis Testing Program, National Cancer Institute (NCI)/National Toxicology Program, showed that liver tumors were associated with the administration of bis(2-ethylhexyl) phthalate (judged at least 99.5 percent pure by thin layer chromatography) in both mice and rats of either sex. In rats, the incidence of hepatocellular carcinomas and neoplastic nodules of the liver were both significantly increased (p=0.05) in females on the 12,000 ppm diet. Combining these two categories led to a significant increase (p=0.01) in males at 12,000 ppm and in females at 6,000 (p=0.012) and 12,000 ppm (p=0.001). Among mice, there was a statistically significant increase in hepatocellular carcinomas in females at 3,000 ppm (p=0.006) and in both sexes at 6,000 ppm (p=0.03). There was also evidence of an increase in hepatocellular adenomas, although not significant at p<0.05.

Two previous studies on Sherman rats fed diets containing 4,000 ppm DEHP and Wistar rats fed diets containing 5,000 ppm bis(2-ethylhexyl) phthalate did not show any carcinogenic effects. However, mortality was high in both studies and too few animals were maintained longer than one year to permit conclusions concerning near lifetime exposure.

For the maximum protection of human health from the potential carcinogenic effects due to exposure of bis(2-ethylhexyl) phthalate through ingestion of contaminated water and contaminated aquatic organisms, the ambient water concentrations should be zero based on the non-threshold assumption for this chemical. However, zero level may not be attainable at the present time. Therefore, levels are estimated that may result in incremental increase of cancer risk over the lifetime of 10<sup>-5</sup>, 10<sup>-6</sup>, and 10<sup>-7</sup>. The corresponding recommended criteria are 17.5 ug/l, 1.75 ug/l, and 0.175 ug/l, respectively. If the above estimates are made for consumption of aquatic organisms only, excluding consumption of water, the levels are 58.8 ug/l, 5.88 ug/l, and 0.588 ug/l, respectively.

68. Di-n-butyl Phthalate (DBP). DBP is a colorless, oily liquid, boiling at 340°C. Its water solubility at room temperature is reported to be 0.4 g/l and 4.5 g/l in two different chemistry handbooks. The formula for DBP, C<sub>6</sub>H<sub>4</sub>(COOC<sub>4</sub>H<sub>9</sub>)<sub>2</sub>,



is the same as for its isomer, di-isobutyl phthalate. DBP production is one to two percent of total United States phthalate ester production.

DBP is used to a limited extent as a plasticizer for polyvinyl chloride (PVC). It is not approved for contact with food. It is used in liquid lipsticks and as a diluent for polysulfide dental impression materials. DBP is used as a plasticizer for nitrocellulose in making gun powder and as a fuel in solid propellants for rockets. Further uses are insecticides, safety glass manufacture, textile lubricating agents, printing inks, adhesives, paper coatings, and resin solvents.

For protection of human health from the toxic properties of DBP ingested through water and through contaminated aquatic organisms, the ambient water quality criterion is 34 mg/l. If contaminated aquatic organisms alone are consumed, excluding the consumption of water, the ambient water criterion is 154 mg/l.

71. Dimethyl Phthalate (DMP). DMP has the lowest molecular weight of the phthalate esters - M.W. = 194 compared to M.W. of 391 for bis(2-ethylhexyl) phthalate. DMP has a boiling point of 282°C. It is a colorless liquid, soluble in water to the extent of 5 mg/l. Its molecular formula is  $C_6H_4(C)(CH_3)_2$ .

Dimethyl phthalate production in the United States is just under one percent of total phthalate ester production. DMP is used to some extent as a plasticizer in cellulose; however, its principal specific use is for dispersion of polyvinylidene fluoride (PVDF). PVDF is resistant to most chemicals and finds use as electrical insulation, chemical process equipment (particularly pipe), and as a case for long-life finishes for exterior metal siding. Coil coating techniques are used to apply PVDF dispersions to aluminum or galvanized steel siding.

For the protection of human health from the toxic properties of dimethyl phthalate ingested through water and through contaminated aquatic organisms, the ambient water criterion is 313 mg/l. If contaminated aquatic organisms alone are consumed, excluding the consumption of water, the ambient water criterion is 2,900 mg/l.

86. Toluene. Toluene is a clear, colorless liquid with a benzene-like odor. It is a naturally occurring compound derived primarily from petroleum or petrochemical processes. Some toluene is obtained from the manufacture of metallurgical coke. Toluene is also referred to as toluol, methylbenzene, methacide, and phenylmethane. It is an aromatic hydrocarbon with the formula  $C_6H_5CH_3$ . It boils at 111°C and has a vapor pressure of 30 mm Hg at room temperature. The water solubility of toluene

is 535 mg/l and it is miscible with a variety of organic solvents. Annual production of toluene in the United States is greater than two million metric tons. Approximately two-thirds of the toluene is converted to benzene and the remaining 33 percent is used approximately equally for the manufacture of chemicals and for use as a paint solvent and aviation gasoline additive. An estimated 5,000 metric tons are discharged to the environment annually as a constituent in wastewaters.

Most data on the effects of toluene in human and other mammals are based on inhalation exposure or dermal contact studies. There appear to be no reports of oral administration of toluene to human subjects. A long term toxicity study on female rats revealed no adverse effects on growth, mortality, appearance and behavior, organ to body weight ratios, blood-urea nitrogen levels, bone marrow counts, peripheral blood counts, or morphology of major organs. The effects of inhaled toluene on the central nervous system, both at high and low concentrations, have been studied in humans and animals. However, ingested toluene is expected to be handled differently by the body because it is absorbed more slowly and must first pass through the liver before reaching the nervous system. Toluene is extensively and rapidly metabolized in the liver. One of the principal metabolic products of toluene is benzoic acid, which itself seems to have little potential to produce tissue injury.

Toluene does not appear to be teratogenic in laboratory animals or man. Nor is there any conclusive evidence that toluene is mutagenic. Toluene has not been demonstrated to be positive in any in vitro mutagenicity or carcinogenicity bioassay system or to be carcinogenic in animals or man.

Toluene has been found in fish caught in harbor waters in the vicinity of petroleum and petrochemical plants. Bioconcentration studies have not been conducted, but bioconcentration factors have been calculated on the basis of the octanol-water partition coefficient.

For the protection of human health from the toxic properties of toluene ingested through water and through contaminated aquatic organisms, the ambient water criterion is 14.3 mg/l. If contaminated aquatic organisms alone are consumed excluding the consumption of water, the ambient water criterion is 424 mg/l. Available data show that the adverse effects on aquatic life occur at concentrations as low as 5 mg/l.

Acute toxicity tests have been conducted with toluene and a variety of freshwater fish and Daphnia magna. The latter appears to be significantly more resistant than fish. No test results have been reported for the chronic effects of toluene on freshwater fish or invertebrate species.

87. Trichloroethylene. Trichloroethylene (1,1,2-trichloroethylene or TCE) is a clear, colorless liquid boiling at 87°C. It has a vapor pressure of 77 mm Hg at room temperature and is slightly soluble in water (1 gm/l). United States production is greater than 0.25 million metric tons annually. It is produced from tetrachloroethane by treatment with lime in the presence of water.

TCE is used for vapor phase degreasing of metal parts; cleaning and drying electronic components, as a solvent for paints; as a refrigerant; for extraction of oils, fats, and waxes; and for dry cleaning. Its widespread use and relatively high volatility result in detectable levels in many parts of the environment.

Data on the effects produced by ingested TCE are limited. Most studies have been directed at inhalation exposure. Nervous system disorders and liver damage are frequent results of inhalation exposure. In the short term exposures, TCE acts as a central nervous system depressant. It was used as an anesthetic before its other long term effects were defined.

TCE has been shown to induce transformation in a highly sensitive in vitro Fischer rat embryo cell system (F1706) that is used for identifying carcinogens. Severe and persistent toxicity to the liver was recently demonstrated when TCE was shown to produce carcinoma of the liver in mouse strain B6C3F1. One systematic study of TCE exposure and the incidence of human cancer was based on 518 men exposed to TCE. The authors of that study concluded that although the cancer risk to man cannot be ruled out, exposure to low levels of TCE probably does not present a very serious and general cancer hazard.

TCE is bioconcentrated in aquatic species, making the consumption of such species by humans a significant source of TCE. For the protection of human health from the potential carcinogenic effects of exposure to trichloroethylene through ingestion of water and contaminated aquatic organisms, the ambient water concentration should be zero based on the non-threshold assumption of this chemical. However, zero level may not be attainable at the present time. Therefore, the levels that may result in incremental increase of cancer risk over the lifetime are estimated at  $10^{-5}$ ,  $10^{-6}$ , and  $10^{-7}$ . The corresponding recommended criteria are 0.027 mg/l, 0.0027 mg/l, and 0.00027 mg/l.

Only a very limited amount of data on the effects of TCE on freshwater aquatic life are available. One species of fish (fat-head minnows) showed a loss of equilibrium at concentrations below those resulting in lethal effects.

89. Aldrin. Aldrin is highly toxic by ingestion and inhalation and is absorbed through the skin. It has been found to be carcinogenic to the liver of mice. For the protection of human health against the carcinogenic properties of aldrin, EPA has proposed a limit of  $4.6 \times 10^{-3}$  ng/l at a risk factor of  $10^{-6}$  for the ingestion of water and contaminated aquatic organisms. Aldrin is banned from manufacture and use by EPA.

90. Dieldrin. Dieldrin is highly toxic by ingestion, inhalation, and skin absorption. Dieldrin has been found to cause cancer in the liver of mice. Dieldrin is banned from manufacture and use by EPA.

99. Endrin Aldehyde. Endrin aldehyde is likely to be present in one pesticide process as a reaction by-product. It is toxic and has no known commercial uses.

100. Heptachlor. Heptachlor is a nonsystemic stomach and contact insecticide that has fumigant action. It is a soft waxy solid with a melting range of 46 to 75°C and is practically insoluble in water. Heptachlor is very toxic to mammals with an acute oral LD50 of 100 mg/kg for male rats and an acute dermal LD50 for male rats of 195 mg/kg. Heptachlor and its epoxide bioaccumulate in fatty tissue and persist for lengthy periods of time. Several uses of heptachlor have been discontinued to avoid contamination of milk and animal products. Heptachlor is a suspected carcinogen. The total number of tumors in both male and female rats increased in one long-term study after heptachlor exposure. It has been recommended that human daily intake of heptachlor should not exceed 0.005 mg/kg of body weight. A ban was placed on heptachlor in Canada in 1969 because of concern for residues in milk and deleterious effects on birds.

102. Alpha-BHC. Alpha-BHC is toxic by ingestion and skin absorption; is an eye and skin irritant; and is a central nervous system depressant.

103. Beta-BHC. Beta-BHC is moderately toxic by inhalation, highly toxic by ingestion, and is a strong irritant by skin absorption. It acts as a central nervous system depressant.

104. Gamma-BHC. Gamma-BHC, also known as lindane, is highly toxic by ingestion and moderately toxic by inhalation.

105. Delta-BHC. Delta-BHC is moderately toxic by inhalation and highly toxic by ingestion. It is a strong irritant to the skin and eyes; is absorbed by the skin; and is a central nervous system depressant.

114. Antimony. Antimony (chemical name - stibium, symbol Sb), classified as a non-metal or metalloid, is a silvery white, brittle crystalline solid. Antimony is found in small ore bodies throughout the world. Principal ores are oxides of mixed antimony valences and an oxysulfide ore. Complex ores with metals are important because the antimony is recovered as a by-product. Antimony melts at 631°C and is a poor conductor of electricity and heat.

Annual United States consumption of primary antimony ranges from 10,000 to 20,000 tons. About half is used in metal products, mostly antimonial lead for lead acid storage batteries, and about half in non-metal products. A principal compound is antimony trioxide which is used as a flame retardant in fabrics and as an opacifier in glass, ceramics, and enamels. Several antimony compounds are used as catalysts in organic chemicals synthesis, as fluorinating agents (the antimony fluoride), as pigments, and in fireworks.

Essentially no information on antimony-induced human health effects has been derived from community epidemiology studies. The available data are in literature relating effects observed with therapeutic or medicinal uses of antimony compounds and industrial exposure studies. Large therapeutic doses of antimonial compounds, usually used to treat schistosomiasis, have caused severe nausea, vomiting, convulsions, irregular heart action, liver damage, and skin rashes. Studies of acute industrial antimony poisoning have revealed loss of appetite, diarrhea, headache, and dizziness in addition to the symptoms found in studies of therapeutic doses of antimony.

For the protection of human health from the toxic properties of antimony ingested through water and through contaminated aquatic organisms, the ambient water criterion is 0.146 mg/l. If contaminated aquatic organisms are consumed, excluding the consumption of water, the ambient water criterion is 45 mg/l. Available data show that adverse effects on aquatic life occur at concentrations higher than those cited for human health risks.

115. Arsenic. Arsenic (chemical symbol As) is classified as a non-metal or metalloid. Elemental arsenic normally exists in the alpha-crystalline metallic form, which is steel gray and brittle, and in the beta form, which is dark gray and amorphous. Arsenic sublimates at 615°C. Arsenic is widely distributed throughout the world in a large number of minerals. The most important commercial source of arsenic is as a by-product from treatment of copper, lead, cobalt, and gold ores. Arsenic is usually marketed as the trioxide (As<sub>2</sub>O<sub>3</sub>). Annual United States production of the trioxide approaches 40,000 tons.

The principal use of arsenic is in agricultural chemicals (herbicides) for controlling weeds in cotton fields. Arsenicals have various applications in medicinal and veterinary use, as wood preservatives, and in semiconductors.

The effects of arsenic in humans were known by the ancient Greeks and Romans. The principal toxic effects are gastrointestinal disturbances. Breakdown of red blood cells occurs. Symptoms of acute poisoning include vomiting, diarrhea, abdominal pain, lassitude, dizziness, and headache. Longer exposure produced dry, falling hair, brittle, loose nails, eczema, and exfoliation. Arsenicals also exhibit teratogenic and mutagenic effects in humans. Oral administration of arsenic compounds has been associated clinically with skin cancer for nearly one-hundred years. Since 1888, numerous studies have linked occupational exposure and therapeutic administration of arsenic compounds to increased incidence of respiratory and skin cancer.

For the maximum protection of human health from the potential carcinogenic effects of exposure to arsenic through ingestion of water and contaminated aquatic organisms, the ambient water concentration is zero. Concentrations of arsenic estimated to result in additional lifetime cancer risk levels of  $10^{-7}$ ,  $10^{-6}$ , and  $10^{-5}$  are 0.00000022 mg/l, 0.0000022 mg/l, and 0.000022 mg/l, respectively. If contaminated aquatic organisms alone are consumed, excluding the consumption of water, the water concentration should be less than  $1.75 \times 10^{-4}$  to keep the increased lifetime cancer risk below  $10^{-5}$ . Available data show that adverse effects on aquatic life occur at concentrations higher than those cited for human health risks.

117. Beryllium. Beryllium is a dark gray metal of the alkaline earth family. It is relatively rare, but because of its unique properties finds widespread use as an alloying element, especially for hardening copper used in springs, electrical contacts, and non-sparking tools. World production is reported to be in the range of 250 tons annually. However, much more reaches the environment as emissions from coal burning operations. Analysis of coal indicates an average beryllium content of 3 ppm and 0.1 to 1.0 percent in coal ash or fly ash.

The principle ores are beryl ( $3\text{BeO} \cdot \text{Al}_2\text{O}_3 \cdot 6\text{SiO}_2$ ) and bertrandite [ $\text{Be}_6\text{Si}_2\text{O}_7(\text{OH})_2$ ]. Only two industrial facilities produce beryllium in the United States because of limited demand and the highly toxic character. About two-thirds of the annual production goes into alloys, 20 percent into heat sinks, and 10 percent into beryllium oxide ( $\text{BeO}$ ) ceramic products.

Beryllium has a specific gravity of 1.846, making it the lightest metal with a high melting point (1,350°C). Beryllium alloys are corrosion resistant, but the metal corrodes in aqueous environments. Most common beryllium compounds are soluble in water, at least to the extent necessary to produce a toxic concentration of beryllium ions.

Most data on toxicity of beryllium are for inhalation of beryllium oxide dust. Some studies on orally administered beryllium in laboratory animals have been reported. Despite the large number of studies implicating beryllium as a carcinogen, there is no recorded instance of cancer being produced by ingestion. However, a recently convened panel of uninvolved experts concluded that epidemiologic evidence suggests that beryllium is a carcinogen in man.

In the aquatic environment, beryllium is chronically toxic to aquatic organisms at 0.0053 mg/l. Water softness has a large effect on beryllium toxicity to fish. In soft water, beryllium is reportedly 100 times as toxic as in hard water.

For the maximum protection of human health from the potential carcinogenic effects of exposure to beryllium through ingestion of water and contaminated aquatic organisms, the ambient water concentration is zero. Concentrations of beryllium estimated to result in additional lifetime cancer risk levels of  $10^{-7}$ ,  $10^{-6}$ , and  $10^{-5}$  are 0.00000037 mg/l, 0.0000037 mg/l, and 0.000037 mg/l, respectively. If contaminated aquatic organisms alone are consumed, excluding the consumption of water, the concentration should be less than 0.00117 mg/l to keep the increased lifetime cancer risk below  $10^{-5}$ .

118. Cadmium. Cadmium is a relatively rare metallic element that is seldom found in sufficient quantities in a pure state to warrant mining or extraction from the earth's surface. It is found in trace amounts of about one ppm throughout the earth's crust. Cadmium is, however, a valuable by-product of zinc production.

Cadmium is used primarily as an electroplated metal and is found as an impurity in the secondary refining of zinc, lead, and copper.

Cadmium is an extremely dangerous cumulative toxicant, causing progressive chronic poisoning in mammals, fish, and probably other organisms. The metal is not excreted.

Toxic effects of cadmium on man have been reported from throughout the world. Cadmium may be a factor in the development of such human pathological conditions as kidney disease, testicular

tumors, hypertension, arteriosclerosis, growth inhibition, chronic disease of old age, and cancer. Cadmium is normally ingested by humans through food and water as well as by breathing air contaminated by cadmium dust. Cadmium is cumulative in the liver, kidney, pancreas, and thyroid of humans and other animals. A severe bone and kidney syndrome known as itai-itai disease has been documented in Japan as caused by cadmium ingestion via drinking water and contaminated irrigation water. Ingestion of as little as 0.6 mg/day has produced the disease. Cadmium acts synergistically with other metals. Copper and zinc substantially increase its toxicity.

Cadmium is concentrated by marine organisms, particularly molluscs, that accumulate cadmium in calcareous tissues and in the viscera. A concentration factor of 1,000 for cadmium in fish muscle has been reported, as have concentration factors of 3,000 in marine plants and up to 29,600 in certain marine animals. The eggs and larvae of fish are apparently more sensitive than adult fish to poisoning by cadmium and crustaceans appear to be more sensitive than fish eggs and larvae.

For the protection of human health from the toxic properties of cadmium ingested through water and through contaminated aquatic organisms, the ambient water criterion is 0.010 mg/l. Available data show that adverse effects on aquatic life occur at concentrations in the same range as those cited for human health and they are highly dependent on water hardness.

119. Chromium. Chromium is an elemental metal usually found as a chromite ( $\text{FeO}\cdot\text{Cr}_2\text{O}_3$ ). The metal is normally produced by reducing the oxide with aluminum. A significant proportion of the chromium used is in the form of compounds such as sodium dichromate ( $\text{Na}_2\text{CrO}_4$ ) and chromic acid ( $\text{CrO}_3$ ), both are hexavalent chromium compounds.

Chromium is found as an alloying component of many steels and its compounds are used in electroplating baths and as corrosion inhibitors for closed water circulation systems.

The two chromium forms most frequently found in industry wastewaters are hexavalent and trivalent chromium. Hexavalent chromium is the form used for metal treatments. Some of it is reduced to trivalent chromium as part of the process reaction. The raw wastewater containing both valence states is usually treated first to reduce remaining hexavalent to trivalent chromium and second to precipitate the trivalent form as the hydroxide. The hexavalent form is not removed by lime treatment.

Chromium, in its various valence states, is hazardous to man. It can produce lung tumors when inhaled and induces skin sensitizations. Large doses of chromates have corrosive effects on the



intestinal tract and can cause inflammation of the kidneys. Hexavalent chromium is a known human carcinogen. Levels of chromate ions that show no effect in man appear to be so low as to prohibit determination, to date.

The toxicity of chromium salts to fish and other aquatic life varies widely with the species, temperature, pH, valence of the chromium, and synergistic or antagonistic effects, especially the effect of water hardness. Studies have shown that trivalent chromium is more toxic to fish of some types than is hexavalent chromium. Hexavalent chromium retards growth of one fish species at 0.0002 mg/l. Fish food organisms and other lower forms of aquatic life are extremely sensitive to chromium. Therefore, both hexavalent and trivalent chromium must be considered harmful to particular fish or organisms.

For the protection of human health from the toxic properties of chromium (except hexavalent chromium) ingested through water and contaminated aquatic organisms, the ambient water quality criterion is 170 mg/l. If contaminated aquatic organisms alone are consumed, excluding the consumption of water, the ambient water criterion for trivalent chromium is 3,443 mg/l. The recommended ambient water quality criterion for hexavalent chromium is identical to the existing drinking water standard for total chromium, which is 0.050 mg/l.

120. Copper. Copper is a metallic element that sometimes is found free, as the native metal, and is also found in minerals such as cuprite ( $\text{Cu}_2\text{O}$ ), malachite [ $\text{CuCO}_3 \cdot \text{Cu}(\text{OH})_2$ ], azurite [ $2\text{CuCO}_3 \cdot \text{Cu}(\text{OH})_2$ ], chalcopyrite ( $\text{CuFeS}_2$ ), and bornite ( $\text{Cu}_5\text{FeS}_4$ ). Copper is obtained from these ores by smelting, leaching, and electrolysis. It is used in the plating, electrical, plumbing, and heating equipment industries, as well as in insecticides and fungicides.

Traces of copper are found in all forms of plant and animal life and the metal is an essential trace element for nutrition. Copper is not considered to be a cumulative systemic poison for humans as it is readily excreted by the body, but it can cause symptoms of gastroenteritis, with nausea and intestinal irritations, at relatively low dosages. The limiting factor in domestic water supplies is taste. To prevent this adverse organoleptic effect of copper in water, a criterion of one mg/l has been established.

The toxicity of copper to aquatic organisms varies significantly, not only with the species, but also with the physical and chemical characteristics of the water, including temperature, hardness, turbidity, and carbon dioxide content. In hard water, the toxicity of copper salts may be reduced by the precipitation of

copper carbonate or other insoluble compounds. The sulfates of copper and zinc and of copper and calcium are synergistic in their toxic effect on fish.

Relatively high concentrations of copper may be tolerated by adult fish for short periods of time; the critical effect of copper appears to be its higher toxicity to young or juvenile fish. Concentrations of 0.02 to 0.03 mg/l have proved fatal to some common fish species. In general, the salmonoids are very sensitive and the sunfishes are less sensitive to copper.

The recommended criterion to protect freshwater aquatic life is 0.0056 mg/l as a 24-hour average, and 0.012 mg/l maximum concentration at a hardness of 50 mg/l  $\text{CaCO}_3$ . For total recoverable copper, the criterion to protect freshwater aquatic life is 0.0056 mg/l as a 24-hour average.

Copper salts cause undesirable color reactions in the food industry and cause pitting when deposited on some other metals such as aluminum and galvanized steel. To control undesirable taste and odor quality of ambient water due to the organoleptic properties of copper, the estimated level is one mg/l for total recoverable copper.

Irrigation water containing more than minute quantities of copper can be detrimental to certain crops. Copper appears in all soils; its concentration ranges from 10 to 80 ppm. In soils, copper occurs in association with hydrous oxides of manganese and iron and also as soluble and insoluble complexes with organic matter. Copper is essential to the life of plants and the normal range of concentration in plant tissue is from 5 to 20 ppm. Copper concentrations in plants normally do not build up to high levels when toxicity occurs. For example, the concentrations of copper in snapbean leaves and pods was less than 50 and 20 mg/kg, respectively, under conditions of severe copper toxicity. Even under conditions of copper toxicity, most of the excess copper accumulates in the roots; very little is moved to the aerial part of the plant.

121. Cyanide. Cyanides are among the most toxic of pollutants commonly observed in industrial wastewaters. Introduction of cyanide into industrial processes is usually by dissolution of potassium cyanide (KCN) or sodium cyanide (NaCN) in process waters. However, hydrogen cyanide (HCN) formed when the above salts are dissolved in water, is probably the most acutely lethal compound.

The relationship of pH to hydrogen cyanide formation is very important. As pH is lowered to below 7, more than 99 percent of the cyanide is present as HCN and less than 1 percent as cyanide

ions. Thus, at neutral pH, the pH of most living organisms, the more toxic form of cyanide prevails.

Cyanide ions combine with numerous heavy metal ions to form complexes. The complexes are in equilibrium with HCN. Thus, the stability of the metal-cyanide complex and the pH determine the concentration of HCN. Stability of the metal-cyanide anion complexes is extremely variable. Those formed with zinc, copper, and cadmium are not stable. They rapidly dissociate, with production of HCN, in near neutral or acid waters. Some of the complexes are extremely stable. Cobaltocyanide is very resistant to acid distillation in the laboratory. Iron cyanide complexes are also stable, but undergo photodecomposition to give HCN upon exposure to sunlight. Synergistic effects have been demonstrated for the metal cyanide complexes making zinc, copper, and cadmium cyanides more toxic than an equal concentration of sodium cyanide.

The toxic mechanism of cyanide is essentially an inhibition of oxygen metabolism (i.e., rendering the tissues incapable of exchanging oxygen). The cyanogen compounds are true noncumulative protoplasmic poisons. They arrest the activity of all forms of animal life. Cyanide shows a very specific type of toxic action. It inhibits the cytochrome oxidase system. This system is the one that facilitates electron transfer from reduced metabolites to molecular oxygen. The human body can convert cyanide to a non-toxic thiocyanate and eliminate it. However, if the quantity of cyanide ingested is too great at one time, the inhibition of oxygen utilization proves fatal before the detoxifying reaction reduces the cyanide concentration to a safe level.

Cyanides are more toxic to fish than to lower forms of aquatic organisms such as midge larvae, crustaceans, and mussels. Toxicity to fish is a function of chemical form and concentration, and is influenced by the rate of metabolism (temperature), the level of dissolved oxygen, and pH. In laboratory studies, free cyanide concentrations ranging from 0.05 to 0.14 mg/l have been proven to be fatal to sensitive fish species including trout, bluegill, and fathead minnows. Levels above 0.2 mg/l are rapidly fatal to most fish species. Long term sublethal concentrations of cyanide as low as 0.01 mg/l have been shown to affect the ability of fish to function normally (e.g., reproduce, grow, and swim).

For the protection of human health from the toxic properties of cyanide ingested through water and through contaminated aquatic organisms, the ambient water quality criterion is 0.200 mg/l.

Persistence of cyanide in water is highly variable and depends upon the chemical form of cyanide in the water, the concentration of cyanide, and the nature of other constituents. Cyanide may be

destroyed by strong oxidizing agents such as permanganate and chlorine. Chlorine is commonly used to oxidize strong cyanide solutions. Carbon dioxide and nitrogen are the products of complete oxidation. But if the reaction is not complete, the very toxic compound, cyanogen chloride, may remain in the treatment system and subsequently be released to the environment. Partial chlorination may occur either as part of a POTW treatment or during the disinfection treatment of surface water for drinking water preparation.

122. Lead. Lead is a soft, malleable, ductile, blueish-gray, metallic element, usually obtained from the mineral galena (lead sulfide,  $PbS$ ), anglesite (lead sulfate,  $PbSO_4$ ), or cerussite (lead carbonate,  $PbCO_3$ ). Because it is usually associated with minerals of zinc, silver, copper, gold, cadmium, antimony, and arsenic, special purification methods are frequently used before and after extraction of the metal from the ore concentrate by smelting.

Lead is widely used for its corrosion resistance, sound and vibration absorption, low melting point (solders), and relatively high imperviousness to various forms of radiation. Small amounts of copper, antimony and other metals can be alloyed with lead to achieve greater hardness, stiffness, or corrosion resistance than is afforded by the pure metal. Lead compounds are used in glazes and paints. About one third of United States lead consumption goes into storage batteries. About half of United States lead consumption is from secondary lead recovery. United States consumption of lead is in the range of one million tons annually.

Lead ingested by humans produces a variety of toxic effects including impaired reproductive ability, disturbances in blood chemistry, neurological disorders, kidney damage, and adverse cardiovascular effects. Exposure to lead in the diet results in permanent increase in lead levels in the body. Most of the lead entering the body eventually becomes localized in the bones where it accumulates. Lead is a carcinogen or cocarcinogen in some species of experimental animals. Lead is teratogenic in experimental animals. Mutagenicity data are not available for lead.

The recommended ambient water quality criterion for lead is identical to the existing drinking water standard for lead which is 0.050 mg/l. Available data show that adverse effects on aquatic life occur at concentrations as low as  $7.5 \times 10^{-4}$  mg/l of total recoverable lead as a 24-hour average with a water hardness of 50 mg/l as  $CaCO_3$ .

123. Mercury. Mercury is an elemental metal rarely found in nature as the free metal. Mercury is unique among metals as it remains a liquid down to about 39 degrees below zero. It is

relatively inert chemically and is insoluble in water. The principal ore is cinnabar (HgS).

Mercury is used industrially as the metal and as mercurous and mercuric salts and compounds. Mercury is used in several types of batteries. Mercury released to the aqueous environment is subject to biomethylation, conversion to the extremely toxic methyl mercury.

Mercury can be introduced into the body through the skin and the respiratory system as the elemental vapor. Mercuric salts are highly toxic to humans and can be absorbed through the gastrointestinal tract. Fatal doses can vary from 1 to 30 grams. Chronic toxicity of methyl mercury is evidenced primarily by neurological symptoms. Some mercuric salts cause death by kidney failure.

Mercuric salts are extremely toxic to fish and other aquatic life. Mercuric chloride is more lethal than copper, hexavalent chromium, zinc, nickel, and lead towards fish and aquatic life. In the food cycle, algae containing mercury up to 100 times the concentration in the surrounding sea water are eaten by fish that further concentrate the mercury. Predators that eat the fish in turn concentrate the mercury even further.

For the protection of human health from the toxic properties of mercury ingested through water and through contaminated aquatic organisms, the ambient water criterion is 0.00014 mg/l.

124. Nickel. Nickel is seldom found in nature as the pure elemental metal. It is a relatively plentiful element and is widely distributed throughout the earth's crust. It occurs in marine organisms and is found in the oceans. The chief commercial ores for nickel are pentlandite [(Fe,Ni)<sub>9</sub>S<sub>8</sub>], and a lateritic ore consisting of hydrated nickel-iron-magnesium silicate.

Nickel has many and varied uses. It is used in alloys and as the pure metal. Nickel salts are used for electroplating baths.

The toxicity of nickel to man is thought to be very low and systemic poisoning of human beings by nickel or nickel salts is almost unknown. In non-human mammals nickel acts to inhibit insulin release, depress growth, and reduce cholesterol. A high incidence of cancer of the lung and nose has been reported in humans engaged in the refining of nickel.

Nickel salts can kill fish at very low concentrations. However, nickel has been found to be less toxic to some fish than copper, zinc, and iron. Nickel is present in coastal and open ocean waters at concentrations in the range of 0.0001 to 0.006 mg/l

although the most common values are 0.002 to 0.003 mg/l. Marine animals contain up to 0.4 mg/l and marine plants contain up to 3 mg/l. Higher nickel concentrations have been reported to cause reduction in photosynthetic activity of the giant kelp. A low concentration was found to kill oyster eggs.

For the protection of human health based on the toxic properties of nickel ingested through water and through contaminated aquatic organisms, the ambient water criterion is 0.0134 mg/l. If contaminated aquatic organisms are consumed, excluding consumption of water, the ambient water criterion is 0.100 mg/l. Available data show that adverse effects on aquatic life occur for total recoverable nickel concentrations as low as 0.0071 mg/l as a 24-hour average.

125. Selenium. Selenium (chemical symbol Se) is a non-metallic element existing in several allotropic forms. Gray selenium, which has a metallic appearance, is the stable form at ordinary temperatures and melts at 220°C. Selenium is a major component of 38 minerals and a minor component of 37 others found in various parts of the world. Most selenium is obtained as a by-product of precious metals recovery from electrolytic copper refinery slimes. United States annual production at one time reached one million pounds.

Principal uses of selenium are in semi-conductors, pigments, decoloring of glass, zerography, and metallurgy. It also is used to produce ruby glass used in signal lights. Several selenium compounds are important oxidizing agents in the synthesis of organic chemicals and drug products.

While results of some studies suggest that selenium may be an essential element in human nutrition, the toxic effects of selenium in humans are well established. Lassitude, loss of hair, discoloration and loss of fingernails are symptoms of selenium poisoning. In a fatal case of ingestion of a larger dose of selenium acid, peripheral vascular collapse, pulmonary edema, and coma occurred. Selenium produces mutagenic and teratogenic effects, but it has not been established as exhibiting carcinogenic activity.

For the protection of human health from the toxic properties of selenium ingested through water and through contaminated aquatic organisms, the ambient water criterion is 0.010 mg/l (i.e., the same as the drinking water standard). Available data show that adverse effects on aquatic life occur at concentrations higher than that cited for human toxicity.

126. Silver. Silver is a soft, lustrous, white metal that is insoluble in water and alkali. In nature, silver is found in the

elemental state (native silver) and combined in ores such as argentite ( $\text{Ag}_2\text{S}$ ), horn silver ( $\text{AgCl}$ ), and procisite ( $\text{Ag}_3\text{AsS}_3$ ), and pyrangyrite ( $\text{Ag}_3\text{SbS}_3$ ). Silver is used extensively in several industries, among them electroplating.

Metallic silver is not considered to be toxic, but most of its salts are toxic to a large number of organisms. Upon ingestion by humans, many silver salts are absorbed in the circulatory system and deposited in various body tissues, resulting in generalized or sometimes localized gray pigmentation of the skin and mucous membranes known as argyria. There is no known method for removing silver from the tissues once it is deposited and the effect is cumulative.

Silver is recognized as a bactericide and doses from 0.000001 to 0.0005 mg/l have been reported as sufficient to sterilize water. The criterion for ambient water to protect human health from the toxic properties of silver ingested through water and through contaminated aquatic organisms is 0.050 mg/l.

The chronic toxic effects of silver on the aquatic environment have not been given as much attention as many other heavy metals. Data from existing literature support the fact that silver is very toxic to aquatic organisms. Despite the fact that silver is nearly the most toxic of the heavy metals, there are insufficient data to adequately evaluate even the effects of hardness on silver toxicity. There are no data available on the toxicity of different forms of silver.

Bioaccumulation and concentration of silver from sewage sludge has not been studied to any great degree. There is some indication that silver could be bioaccumulated in mushrooms to the extent that there could be adverse physiological effects on humans if they consumed large quantities of mushrooms grown in silver enriched soil. The effect, however, would tend to be unpleasant rather than fatal.

127. Thallium. Thallium is a soft, silver-white, dense, malleable metal. Five major minerals contain 15 to 85 percent thallium, but they are not of commercial importance because the metal is produced in sufficient quantity as a by-product of lead-zinc smelting of sulfide ores. Thallium melts at  $304^\circ\text{C}$ . United States annual production of thallium and its compounds is estimated to be 1,500 pounds.

Industrial uses of thallium include the manufacture of alloys, electronic devices, and special glass. Thallium catalysts are used for industrial organic syntheses.

Acute thallium poisoning in humans has been widely described. Gastrointestinal pains and diarrhea are followed by abnormal sensation in the legs and arms, dizziness, and, later, loss of hair. The central nervous system is also affected. Somnolence, delirium or coma may occur. Studies on the teratogenicity of thallium appear inconclusive; no studies on mutagenicity were found; and no published reports on carcinogenicity of thallium were found.

For the protection of human health from the toxic properties of thallium ingested through water and contaminated aquatic organisms, the ambient water criterion is 0.013 mg/l.

128. Zinc. Zinc occurs abundantly in the earth's crust, concentrated in ores. It is readily refined into the pure, stable, silver-white metal. In addition to its use in alloys, zinc is used as a protective coating on steel. It is applied by hot dipping (i.e., dipping the steel in molten zinc) or by electroplating.

Zinc can have an adverse effect on man and animals at high concentrations. Zinc at concentrations in excess of five mg/l causes an undesirable taste that persists after wastewater treatment. For the prevention of adverse effects due to these organoleptic properties of zinc, five mg/l was adopted for the ambient water criterion. Available data show that adverse effects on aquatic life occur at concentrations as low as 0.047 mg/l as a 24-hour average.

Toxic concentrations of zinc compounds cause adverse changes in the morphology and physiology of fish. Lethal concentrations in the range of 0.1 mg/l have been reported. Acutely toxic concentrations induce cellular breakdown of the gills and possibly the clogging of the gills with mucous. Chronically toxic concentrations of zinc compounds cause general enfeeblement and widespread histological changes to many organs, but not to gills. Abnormal swimming behavior has been reported at 0.04 mg/l. Growth and maturation are retarded by zinc. Effects of zinc poisoning may not become apparent immediately, so that fish removed from zinc-contaminated water may die as long as 48 hours after removal.

In general, salmonoids are most sensitive to elemental zinc in soft water; the rainbow trout is the most sensitive in hard waters. A complex relationship exists between zinc concentration, dissolved zinc concentration, pH, temperature, and calcium and magnesium concentration. Prediction of harmful effects has been less than reliable and controlled studies have not been extensively documented.



The major concern with zinc compounds in marine waters is not with acute lethal effects, but rather with the long-term sub-lethal effects of the metallic compounds and complexes. Zinc accumulates in some marine species; marine animals contain zinc in the range of 6 to 1,500 mg/kg. From the point of view of acute lethal effects, invertebrate marine animals seem to be the most sensitive organism tested.

#### MASS OF POLLUTANTS

Pollutant average concentrations in the PM&F process waters were presented for the PM&F subcategories in Table VI-19. Of equal importance is the mass of pollutants in the process waters. Estimated pollutant masses generated per year are presented in this section.

Pollutant masses were estimated with a statistical methodology that combines information from both the sampling episodes and the questionnaire data base. This methodology is illustrated below. Refer to Table VII-11 for sampling data used in this example. The questionnaire survey data used in the example are presented in Table VII-12.

1. The example has two extrusion processes and one molding process in the contact cooling and heating water subcategory.
2. Calculate the average mass of pollutant discharged for each process. Use the water usage flow rates and the concentrations measured on the sampling days (see Table VII-11).

<u>Process</u>	<u>Average Mass of Pollutant (mg/hr)</u>
EX-1	$\frac{(10 \text{ mg/l})(100 \text{ l/hr}) + (30 \text{ mg/l})(140 \text{ l/hr}) + (15 \text{ mg/l})(100 \text{ l/hr})}{3}$ $= 2,230 \text{ mg/hr}$
EX-2	$\frac{(50 \text{ mg/l})(300 \text{ l/hr}) + (10 \text{ mg/l})(400 \text{ l/hr})}{2} = 9,500 \text{ mg/hr}$
MD-1	$\frac{(100 \text{ mg/l})(50 \text{ l/hr}) + (110 \text{ mg/l})(60 \text{ l/hr}) + (120 \text{ mg/l})(60 \text{ l/hr})}{3}$ $= 6,270 \text{ mg/hr}$

Table VII-11

DATA FOR POLLUTANT X - MASS CALCULATION EXAMPLE

Process	Contact Cooling and Heating Water Subcategory									Duplicate		
	Day 1 Conc. (mg/l)	Day 1 Flow (l/hr)	Day 1 Prod. (kg/hr)	Day 2 Conc. (mg/l)	Day 2 Flow (l/hr)	Day 2 Prod. (kg/hr)	Day 3 Conc. (mg/l)	Day 3 Flow (l/hr)	Day 3 Prod. (kg/hr)	Conc. (mg/l)	Flow (l/hr)	Prod. (kg/hr)
Extrusion (EX-1)	10	100	50	--	--	--	30	140	100	15	100	50
Extrusion (EX-2)	50	300	1000	10	400	900	--	--	--	--	--	--
Molding (MD-1)	100	50	100	--	--	--	110	60	130	120	60	130

Table VII-12

## QUESTIONNAIRE SURVEY DATA USED TO ESTIMATE POLLUTANT MASSES

<u>Type of Process</u>	<u>Estimated Number of Processes*</u>		<u>Average Plastic Production (kkg/yr/process)**</u>	
	<u>Direct Dischargers</u>	<u>Indirect Dischargers</u>	<u>Direct Dischargers</u>	<u>Indirect Dischargers</u>
Calendering	5	10	1,980	11,000
Casting	5	25	7,300	1,580
Coating and Laminating	10	35	293	1,800
Extrusion	631	657	6,740	2,650
Molding	30	89	1,490	900
Thermoforming	15	29	2,060	2,240
Cleaning	104	232	3,150	1,390
Finishing	10	68	46	2,200

211

---

\*Calculated by applying the percentages in Table VI-6 to the total estimated number of contact cooling and heating water processes presented in Table VI-7.

\*\*Calculated using data from the PM&F questionnaire survey data base.

3. For the processes that belong to a type of process, sum the average mass of pollutants (calculated in step 2).

<u>Type of Process</u>	<u>Summed Average Mass (mg/hr)</u>
Extrusion	$2,230 \text{ mg/hr} + 9,500 \text{ mg/hr} = 11,730 \text{ mg/hr}$
Molding	$6,270 \text{ mg/hr}$

4. For each process, calculate an average plastic production rate with measurements taken on the sampling day (see Table VII-11).

<u>Process</u>	<u>Average Plastic Production Rate (kg/hr)</u>
EX-1	$\frac{50+100+50}{3} = 67 \text{ kg/hr}$
EX-2	$\frac{1,000+900}{2} = 950 \text{ kg/hr}$
MD-1	$\frac{100+130+130}{3} = 120 \text{ kg/hr}$

5. For the processes that belong to a type of process, sum the average plastic production rates calculated in step 4.

<u>Type of Process</u>	<u>Summed Average Plastic Production Rate (kg/hr)</u>
Extrusion	$67 \text{ kg/hr} + 950 \text{ kg/hr} = 1,117 \text{ kg/hr}$
Molding	$120 \text{ kg/hr}$

6. For each type of process, divide the summed average pollutant mass (calculated in step 3) by the summed average plastic production rate (calculated in step 5) to calculate a pollutant mass per unit of production.

<u>Type of Process</u>	<u>Pollutant Mass Per Unit of Production (mg Pollutant/kg Plastic)</u>
Extrusion	$\frac{11,730 \text{ mg/hr}}{1,117 \text{ kg/hr}} = 10.5 \frac{\text{mg}}{\text{kg}}$
Molding	$\frac{6,270 \text{ mg/hr}}{120 \text{ kg/hr}} = 52.3 \frac{\text{mg}}{\text{kg}}$

7. For each type of process, multiply the pollutant mass per unit of production (calculated in step 6) by the estimated number of processes and by the average plastic production from the questionnaire data base. This calculation estimates the pollutant mass for each type of process in the subcategory. The questionnaire data are presented in Table VII-12 for the different types of processes for both direct and indirect dischargers. This example calculation estimates the direct discharge pollutant mass. An analogous calculation for the indirect discharge pollutant mass uses the values for indirect dischargers presented in Table VII-12.

<u>Type of Process</u>	<u>Estimated Direct Discharge Pollutant Mass (kg/yr)</u>
Extrusion	(10.5 mg/kg)(631 processes)(6,740 kkg/yr/process) = 44,700 kg/yr
Molding	(52.3 mg/kg)(30 processes)(1,490 kkg/yr/process) = 2,340 kg/yr

8. In the contact cooling and heating water subcategory, an estimate of the pollutant mass per unit of production for the types of processes that have no sampling data was also calculated. This was calculated by summing the estimated pollutant masses (calculated in step 7) and then dividing by the sum of questionnaire survey factors used in the pollutant mass estimate. For example, combining the extrusion and molding results from step 7 gives the following:

$$\frac{44,700 \text{ kg/yr} + 2,340 \text{ kg/yr}}{[(631 \text{ processes})(6,740 \text{ kkg/yr/process}) + (30 \text{ processes})(1,490 \text{ kkg/yr/process})]}$$

$$= 0.011 \frac{\text{kg pollutant}}{\text{kkg plastic}}$$

This pollutant mass per unit of production is an estimate to use for the types of processes that have no sampling data (i.e., casting, calendering, coating and laminating, and thermoforming).

9. To estimate the pollutant mass discharged for the type of processes that have no available sampling data, multiply the pollutant mass per unit of production (calculated in step 8) by the appropriate factors in Table VII-12.

<u>Type of Process</u>	<u>Estimated Direct Discharge Pollutant Mass (kg/yr)</u>
Calendering	(0.011 kg/kkg)(5 processes)(1,980 kkg/yr/process) = 109 kg/yr
Casting	(0.011 kg/kkg)(5 processes)(7,300 kkg/yr/process) = 402 kg/yr
Coating & Laminating	(0.011 kg/kkg)(10 processes)(293 kkg/yr/process) = 32 kg/yr
Thermoforming	(0.011 kg/kkg)(15 processes)(2,060 kkg/yr/process) = 340 kg/yr

10. Sum the estimated pollutant masses for both sampled and unsampled types of processes (calculated in steps 7 and 9), to obtain an estimate of the total direct discharge pollutant mass for the subcategory.

<u>Type of Process</u>	<u>Estimated Direct Discharge Pollutant Mass (kg/yr)</u>
Extrusion	44,700
Molding	2,340
Calendering	109
Casting	402
Coating & Laminating	32
Thermoforming	<u>340</u>
TOTAL	47,923 kg/yr of Pollutant X

This calculation procedure is more simplified for the cleaning water subcategory and for the finishing water subcategory because these subcategories have only one type of process (i.e., cleaning or finishing processes). Calculation steps one through seven need only be performed for these subcategories.

This methodology was used to estimate the mass of pollutants discharged by direct and indirect dischargers in the three PM&F subcategories. Those estimates are presented in Table VII-13. Masses were estimated for the conventional and nonconventional pollutants in all three subcategories, even though not all of these pollutants were found in treatable concentrations for each subcategory. This was done to examine the total pollutant mass in the subcategories. Masses for the priority pollutants were calculated for the pollutants in Table VII-8. This was also done to evaluate the priority pollutant mass discharged by the industry.

Table VII-13

POLLUTANT MASSES  
(CONTACT COOLING AND HEATING WATER SUBCATEGORY)

<u>Conventional Pollutants</u>	<u>Direct Discharge Mass (kg/yr)</u>	<u>Indirect Discharge Mass (kg/yr)</u>	<u>Total Mass (kg/yr)</u>
BOD <sub>5</sub>	127,000	65,600	192,600
Oil and Grease	99,200	74,800	174,000
TSS	<u>33,000</u>	<u>23,000</u>	<u>56,000</u>
TOTAL	259,200	163,400	422,600
 <u>Nonconventional Pollutants</u>			
COD	1,760,000	900,000	2,660,000
TOC	596,000	320,000	916,000
Total Phenols	<u>441</u>	<u>342</u>	<u>783</u>
TOTAL	2,356,441	1,220,342	3,576,783
 <u>Priority Pollutants</u>			
4. benzene	2,040	872	2,912
11. 1,1,1-trichloroethane	3,970	1,700	5,670
22. parachlorometa cresol	3,630	1,550	5,180
23. chloroform	212	95	307
44. methylene chloride	3,810	1,640	5,450
65. phenol	662	289	951
66. bis(2-ethylhexyl) phthalate	9,470	5,460	14,930
68. di-n-butyl phthalate	211	98.7	309.7
86. toluene	21.9	13.7	35.6

Table VII-13 (Continued)

POLLUTANT MASSES  
(CONTACT COOLING AND HEATING WATER SUBCATEGORY) (Continued)

<u>Priority Pollutants</u>	<u>Direct Discharge Mass (kg/yr)</u>	<u>Indirect Discharge Mass (kg/yr)</u>	<u>Total Mass (kg/yr)</u>
89. aldrin	0.022	0.033	0.055
90. dieldrin	0.022	0.055	0.077
99. endrin aldehyde	0.044	0.019	0.063
102. alpha-BHC	2.68	1.92	4.60
103. beta-BHC	1.52	0.648	2.17
104. gamma-BHC	0.278	0.173	0.451
105. delta-BHC	6.37	2.80	9.17
117. beryllium	3.24	1.38	4.66
118. cadmium	116	49.7	165.7
119. chromium	296	142	438
120. copper	165	82.1	247.1
122. lead	16,800	7,220	24,020
123. mercury	0.002	0.004	0.006
124. nickel	392	193	585
126. silver	9.28	4.00	13.28
127. thallium	136	58.1	194.1
128. zinc	567	527	1,094
TOTAL	42,500	20,000	62,500



Table VII-13 (Continued)

POLLUTANT MASSES  
(CLEANING WATER SUBCATEGORY)

<u>Conventional Pollutants</u>	<u>Direct Discharge Mass (kg/yr)</u>	<u>Indirect Discharge Mass (kg/yr)</u>	<u>Total Mass (kg/yr)</u>
BOD <sub>5</sub>	25,600	25,200	50,800
Oil and Grease	14,200	14,000	28,200
TSS	<u>199,000</u>	<u>196,000</u>	<u>395,000</u>
TOTAL	238,800	235,200	474,000
 <u>Nonconventional Pollutants</u>			
COD	32,000	31,500	63,500
TOC	177,000	174,000	351,000
Total Phenols	<u>7,400</u>	<u>7,290</u>	<u>14,690</u>
TOTAL	216,400	212,790	429,190
 <u>Priority Pollutants</u>			
4. benzene	0.532	0.524	1.056
22. parachlorometa cresol	0.0413	0.0406	0.0819
44. methylene chloride	3.58	3.53	7.11
62. N-nitrosodiphenylamine	0.482	0.476	0.958
65. phenol	59.2	58.3	117.5
66. bis(2-ethylhexyl) phthalate	2.21	2.18	4.39
86. toluene	3.74	3.68	7.42

Table VII-13 (Continued)

POLLUTANT MASSES  
(CLEANING WATER SUBCATEGORY) (Continued)

<u>Priority Pollutants</u>	<u>Direct Discharge Mass (kg/yr)</u>	<u>Indirect Discharge Mass (kg/yr)</u>	<u>Total Mass (kg/yr)</u>
89. aldrin	0.0075	0.00739	0.01489
100. heptachlor	0.00815	0.00803	0.01618
102. alpha-BHC	0.0000182	0.0000178	0.0000360
103. beta-BHC	0.00256	0.00254	0.00510
104. gamma-BHC	0.0196	0.0193	0.0389
105. delta-BHC	0.0210	0.0206	0.0416
114. antimony	0.970	0.984	1.954
115. arsenic	0.068	0.069	0.137
119. chromium	5.62	5.53	11.15
120. copper	13.1	12.9	26.0
123. mercury	0.002	0.002	0.004
124. nickel	1.25	1.23	2.48
125. selenium	3.74	3.68	7.42
126. silver	0.0607	0.0617	0.1217
128. zinc	<u>178</u>	<u>176</u>	<u>354</u>
TOTAL	273	269	542

Table VII-13 (Continued)

POLLUTANT MASSES  
(FINISHING WATER SUBCATEGORY)

<u>Conventional Pollutants</u>	<u>Direct Discharge Mass (kg/yr)</u>	<u>Indirect Discharge Mass (kg/yr)</u>	<u>Total Mass (kg/yr)</u>
BOD <sub>5</sub>	237	76,900	77,137
Oil and Grease	287	93,000	93,287
TSS	<u>3,630</u>	<u>1,180,000</u>	<u>1,183,630</u>
TOTAL	4,154	1,349,900	1,354,054
 <u>Nonconventional Pollutants</u>			
COD	640	207,000	207,640
TOC	889	288,000	288,889
Total Phenols	<u>8.28</u>	<u>2,680</u>	<u>2,688.28</u>
TOTAL	1,537.28	497,680	499,217.28
 <u>Priority Pollutants</u>			
8. 1,2,4-trichlorobenzene	0.225	72.9	73.125
11. 1,1,1-trichloroethane	0.0307	9.95	9.9807
28. 3,3'-dichlorobenzidine	0.0833	27.0	27.0833
38. ethylbenzene	0.181	58.7	58.881
65. phenol	0.263	85.1	85.363
66. bis(2-ethylhexyl) phthalate	18.3	5,920	5,938.3
68. di-n-butyl phthalate	1.17	378	379.17
71. dimethyl phthalate	1.28	414	415.28
87. trichloroethylene	0.155	50.2	50.355

Table VII-13 (Continued)

POLLUTANT MASSES  
(FINISHING WATER SUBCATEGORY) (Continued)

<u>Priority Pollutants</u>	<u>Direct Discharge Mass (kg/yr)</u>	<u>Indirect Discharge Mass (kg/yr)</u>	<u>Total Mass (kg/yr)</u>
114. antimony	0.0397	12.9	12.9397
115. arsenic	0.0348	11.3	11.3348
119. chromium	0.0397	12.9	12.9397
120. copper	1.08	349	350.08
121. cyanide	0.194	62.7	62.894
122. lead	1.15	374	375.15
123. mercury	0.000566	0.183	0.183566
124. nickel	0.156	50.7	50.856
125. selenium	1.15	371	372.15
128. zinc	<u>3.33</u>	<u>1,080</u>	<u>1,083.33</u>
TOTAL	29	9,341	9,370

## SECTION VIII

### WASTEWATER CONTROL AND TREATMENT TECHNOLOGIES

#### INTRODUCTION

This section discusses the control and treatment technologies considered in this final rulemaking for the control of pollutants in process waters generated by PM&F processes. These control and treatment technologies are unit processes that are used to develop model treatment technology options. The specific model technology options considered for BPT, BAT, NSPS, and PSES/PSNS are discussed in Sections X, XI, XII, and XIII, respectively.

Prior to publication of the proposed PM&F regulation, EPA considered a wide range of in-process control and end-of-pipe treatment technologies. These technologies are discussed in detail in the preamble to the proposed PM&F regulation (see 49 FR 5862) and in the technical development document supporting the proposed PM&F regulation. Additional information obtained subsequent to the proposal to evaluate comments and data submitted by commenters on the proposed regulation and revisions in EPA's data averaging methodology (see Section VI of this document) led to changes in technologies considered in developing model treatment technology options for the final PM&F regulation. Based on their applicability to PM&F process waters and general technical feasibility, the following control and treatment technologies, which are divided into in-plant control technologies and end-of-pipe treatment technologies, were considered for the final PM&F regulation:

- o In-plant control technologies
  - Process water recycle
  - In-process measures
- o End-of-pipe treatment technologies
  - Settling
  - pH adjustment
  - Activated sludge
  - Activated carbon adsorption
  - Filtration (suspended solids removal)
  - Vacuum filtration (sludge dewatering)

The remainder of this section describes each of these technologies. In particular, the following topics are discussed, where applicable, for each technology:

- o Process description,
- o Applications,
- o Technology status,
- o Limitations,
- o Reliability,
- o Environmental impact, and
- o Treatability data.

The primary literature sources relied on during the development of this section were EPA's Treatability Manual, Volume III, Technologies for Control/Removal of Pollutants and EPA's Innovative and Alternative Technology Assessment Manual. Metcalf and Eddy, Inc.'s Wastewater Engineering, Treatment/Disposal/Reuse served as a general reference. Refer to Section XVI for reference details.

#### IN-PLANT CONTROL TECHNOLOGY

The purpose of in-plant control technology for plants in the plastics molding and forming category is to reduce or eliminate the amount of process water requiring end-of-pipe treatment and thereby either reduce the size of the treatment technology or eliminate the need for the treatment technology. In-plant technologies considered for the PM&F category are: (1) process water recycle; and (2) in-process measures.

#### Process Water Recycle

Recycling of process water is the practice of recirculating water to be used again for the same purpose or process. Water recycle is distinguished from water reuse, which is the recirculation of process water to be used again for a different purpose or process. An example of water recycle would be to use rinse water more than once in the same rinsing operation; whereas in water reuse, the rinse water would be used again, but in a different operation. Both practices result in a reduction in the amount of process water discharged.

Applications. Two types of recycle are possible - recycle with no discharge (100 percent recycle) and recycle with a discharge (or bleed stream). One hundred percent recycle may be prohibited by the presence of dissolved solids in the process water (e.g., sulfates and chlorides). These dissolved solids precipitate if their solubility limits are exceeded and form scale on pipes and equipment. A bleed stream, either continuous or periodic, is necessary to prevent maintenance problems that would be created by the precipitation of dissolved solids. One hundred percent recycle is generally applicable to low flow rate processes and to process waters with low pollutant concentrations.

Process water that requires cooling is recycled through a unit that lowers the temperature of the water so that it can be recycled. Two types of equipment may be used for 100 percent recycle of process water that needs to be cooled. The first and simplest piece of equipment is a holding tank. Process water is held up in a tank until the temperature drops sufficiently, through passive heat transfer to the environment, to allow the water to be recycled. A holding tank is only practical for low flow rates because tank sizes increase dramatically when the flow rate increases. One hundred percent recycle of process waters that needs to be cooled may also be achieved using chillers, which cool the water by mechanical refrigeration. In a chiller, the cooling water is passed through a heat exchanger that is cooled by a low boiling, vaporized refrigerant. Chillers can be used with processes with medium flow rates because they can be purchased as self-contained units that are easy to install. At higher flow rates, the chiller's high energy usage per unit of cooling makes its use less attractive. Recycle systems such as cooling tanks or chiller units are generally cleaned out once every one or two years and thus potentially may require the disposal of some amount of waste.

Recycle with a discharge is generally practiced for processes with high flow rates. Process waters from those processes that need to be cooled can be recycled through cooling towers that lower the water temperature by evaporative cooling. In a typical cooling tower configuration, water is distributed at the top of the tower in a manner that provides a large contact area between air and water. Air circulates countercurrently to the water to be cooled. Heat is transferred from the water to the air as water evaporates. Cooling towers can be used with processes with flow rates from as low as 15 gpm to several hundred gpm.

One hundred percent recycle of process water through cooling towers is prohibited because the concentration of dissolved solids in the process waters may cause scale to form on the cooling tower. A bleed stream is needed to reduce the concentration of these solids below the concentration where they would precipitate and cause pipe plugging and scaling on the cooling tower.

Process water that requires the removal of solids and oil and grease before it can be used again in the process can be recycled through a settling tank. Generally, process water that requires removal of suspended solids and oil and grease has to be replaced after a period of time. This can be done either by replacing the small continuous discharge flow from the unit with fresh water or by periodically changing all of the process water within the recycle unit.

Technology Status. Process water recycle is currently practiced by 44 percent of the wet processes in the contact cooling and heating water subcategory, 13 percent of wet processes in the cleaning water subcategory, and 18 percent of wet processes in the finishing water subcategory. When recycle was reported, the recycle percentage generally ranged from 90 to 100 percent. Table VIII-1 contains a distribution of the number of processes with various recycle percentages by PM&F subcategory based on data from the questionnaire data base.

Limitations. A potential limitation of 100 percent recycle of process water is the buildup of dissolved solids. The presence of dissolved solids may result in scale formation on piping and equipment and may also affect product quality. Dissolved solids levels can be controlled in cases where a bleed stream is discharged by increasing the bleed flow. For recycle systems that include settling, solids removed from the settling unit require disposal. Small quantities of scale and settled solids also have to be periodically removed from recycle units with a discharge.

The percent of process water that can be recycled depends on product quality. In some cases, process water may not be recycled because product quality requires that only "potable" water be used in the process.

Reliability. Recycle units have few components with moving parts; most of the routine maintenance is needed to service the recirculating pump.

Environmental Impact. Recycle is an important water conservation measure because both the demand for raw water and the amount of water discharged are reduced when process water is recycled. A reduction in the amount of process water that requires treatment results in a reduction in the required treatment unit capacity and, therefore, the cost of end-of-pipe treatment. In addition, the performance of the treatment process, in terms of percent removal, may be improved when recycle is used because pollutants in the recycle unit discharge are more concentrated. Generally, end-of-pipe treatment perform more effectively with higher pollutant concentrations.

#### In-Process Measures

Two opportunities exist for plants to reduce the quantity of water used by PM&F processes. One is to decrease the quantity of water that flows through the process; the other is to modify the process so that the use of process water is no longer necessary.



Table VIII-1

## DISTRIBUTION OF PM&amp;F PROCESSES WITH RECYCLE

<u>Percent Recycle</u>	<u>Number of Processes in Questionnaire Data Base With Recycle (Percent of Total Wet Processes in Subcategory)</u>		
	<u>Contact Cooling and Heating Water Subcategory</u>	<u>Cleaning Water Subcategory</u>	<u>Finishing Water Subcategory</u>
100	83 (19.4)	0	3 (13.6)
95-99.9	63 (14.7)	7 (9.9)	1 (4.5)
90-94.9	15 (3.5)	1 (1.4)	0
75-89.9	14 (3.3)	1 (1.4)	0
50-74.9	9 (2.1)	0	0
0.1-49.9	4 (0.9)	0	0
0	<u>240 (56.1)</u>	<u>62 (87.3)</u>	<u>18 (81.9)</u>
	428 (100)	71 (100)	22 (100)

Applications. The Agency believes that, based on observations made during plant visits, some PM&F plants may not pay close attention to water use. Satisfactory operation may be achieved with smaller rinse or contact cooling water flows. The practice of shutting off process water during periods when a production unit is inoperative and adjusting flow rates during periods of low activity can reduce the volume of water to be treated or discharged. Producers with a high water use should be able to reduce their water use through simple flow reduction procedures such as more careful adjustment of process water flow rates and reduction of overflow and dragout from quench tanks.

The Agency considered process modifications for reducing process water use because approximately 80 percent of the processes in the PM&F category do not require the use of process water. The possibility of eliminating the use of process water by the other 20 percent of PM&F processes that use process water, was studied. Investigation into the specific uses of process water revealed that the 20 percent of manufacturers who are using process water need that water for efficient and effective operation of their processes. The majority of PM&F process water is contact cooling water used during extrusion processes. This water is necessary for effective heat transfer, particularly during pelletizing processes and for the extrusion of tube, pipe, profiles, or plastic coverings on wire and cable. Process water is also needed for contact cooling during other molding and forming process to maintain product integrity. It is also needed to clean both the surfaces of the plastic products and surfaces of shaping equipment used to produce those products and to finish plastic products. Water is required in cleaning processes and in finishing processes as a carrier media. PM&F processes that use process water need the water for effective operation of the process; they cannot be converted to dry processes. Therefore, process modifications to eliminate the use of process water are not appropriate for wet PM&F processes.

#### END-OF-PIPE TREATMENT TECHNOLOGY

This section discusses end-of-pipe treatment technologies applicable to treatment of process waters discharged by PM&F processes. End-of-pipe treatment technologies are used to reduce the concentrations of pollutants in process waters. The end-of-pipe treatment technologies that were considered will treat either some or all of the pollutants listed in Table VIII-2.

##### Settling

Settling is a process that removes solid particles from a liquid matrix by gravitational force. This is done by reducing the velocity of the influent flow so that gravitation settling can

Table VIII-2

POLLUTANTS AND POLLUTANT PROPERTIES FOUND IN TREATABLE  
CONCENTRATIONS IN PM&F PROCESS WATERS

Conventional Pollutants

BOD<sub>5</sub>  
Oil and Grease  
TSS  
pH

Nonconventional Pollutants

COD  
TOC  
Total Phenols

Priority Pollutants

65. phenol  
66. bis(2-ethylhexyl) phthalate  
68. di-n-butyl phthalate  
71. dimethyl phthalate  
128. zinc

occur. Simple settling requires long retention times to achieve high removal efficiencies. Settling tanks can be designed with baffles to eliminate the turbulence caused by influent water and have sloping bottoms to aid in sludge collection. Settling tanks are often designed so that oil and grease separation also occurs. Oil and grease and other floatable materials can be removed by surface skimming.

Applications. Settling can be effectively used to treat wastewater with high concentrations of oil and grease and suspended solids. Toxic metals removals have also been achieved in settling tanks.

Technology Status. Settling has been effectively demonstrated in the treatment of numerous industrial wastewaters. It is one of the oldest wastewater treatment technologies in use. Eleven plants in the questionnaire data base for the PM&F category have settling/clarification units in place to treat PM&F process waters.

Limitations. Excessively long retention times may be required under certain conditions, particularly when the specific gravity of suspended particles is close to one or the particle sizes are small. Colloidal particles with diameters less than one micron may not be effectively settled without the addition of a flocculant or coagulating agent. Additionally, dissolved pollutants are not removed by settling.

Reliability. The lack of mechanical complexity makes this technology very reliable.

Environmental Impact. The major environmental impact associated with settling is the disposal of the solid material removed from the wastewater.

Treatability Data. Mean removal efficiencies for conventional and selected nonconventional pollutants in a settling unit are presented in Table VIII-3.

#### pH Adjustment

pH adjustment is the process of adjusting an acidic or a basic wastewater to a pH of an acceptable value. Adjusting the pH of the wastewater is necessary for various reasons. The pH should be adjusted to: (1) prevent metal corrosion and/or damage to equipment and structures; (2) protect aquatic life and human health; (3) ensure effective operation of a treatment process; and (4) provide neutral pH water for recycle. pH adjustment may also be needed to break emulsions, to insolubilize certain

Table VIII-3

REMOVAL EFFICIENCIES FOR CONVENTIONAL AND SELECTED  
NONCONVENTIONAL POLLUTANTS IN A SETTLING TANK

<u>Pollutant</u>	<u>Mean Removal Efficiency (%)</u>
BOD5	33
Oil and Grease	47
TSS	82
COD	71
TOC	40
Total Phenols	43

---

Source: Treatability Manual, Volume III, Technologies for  
Control/Removal of Pollutants, July 1980,  
EPA 600/8-80-042c.

chemical species, or to control chemical reaction rates (e.g., chlorination). Generally, the pH of a wastewater should be between 6.0 and 9.0.

The actual process of adjustment to a neutral pH is accomplished by the addition of a basic material to an acidic material or by adding an acid to an alkaline material. Addition of the neutralization agent must be carefully controlled to avoid large temperature increases due to the exothermic nature of most acid-base neutralization reactions. Neutralization chemicals can be added manually or automatically to a mixed tank. Continuous pH monitoring is usually included in an automatic chemical addition system.

Applications. This technology is widely applied in the treatment of wastewaters.

Technology Status. pH adjustment is widely used in industrial waste treatment. Seven PM&F plants that treat process waters from primarily PM&F processes reported that they adjusted the pH of their process waters (see Table VI-4).

Limitations. The pH adjustment rate may be limited by heat effects accompanying the neutralization reaction. In most cases, proper planning of the neutralization process with respect to concentration of the neutralizing agent, rate of addition, reaction time, and equipment design can alleviate the heat problem.

Reliability. The pH adjustment process is highly reliable if properly monitored.

Environmental Impact. The environmental impacts associated with pH adjustment are, in general, minor. However, pH adjustment may result in precipitation of dissolved pollutants in certain wastewaters. These precipitated solids may eventually settle and require disposal. In addition, when acids are added to wastewaters containing certain salts, such as sulfide, toxic gases may be produced.

### Activated Sludge

The activated sludge process is an aerobic (i.e., in the presence of oxygen) decomposition process in which organic material is oxidized by microorganisms. These microorganisms utilize organic pollutants as a source of food and convert them into carbon dioxide, water, energy, and cellular material, which may be removed by liquid-solids separation. Activated sludge treatment is distinguished from other types of biological treatment by the return of settled microorganisms (i.e., the acidvated sludge) to contact with incoming wastewater. The activated sludge process is used

to remove dissolved and colloidal biodegradable organic pollutants from wastewater.

A flow diagram of a conventional activated sludge process is presented in Figure VIII-1. There are two basic unit operations involved: (1) contacting of the influent wastewater and microorganisms in the presence of oxygen, and subsequently, (2) separation of the liquid/solids mixture that forms. The activated sludge process was developed as a continuous flow process because of the underlying concept of recycling activated sludge. In the first step, or the contacting phase, the microorganisms oxidize soluble and colloidal organic pollutants to carbon dioxide and water in the presence of molecular oxygen. The intimate contact required between the wastewater and microorganisms is achieved by mixing and turbulence induced by aeration. The mixture of microorganisms and wastewater (called mixed liquor) formed in the contactor or aeration basin is transferred to a gravity settling unit for liquid/solids separation. A large portion of the microorganisms that settle in the settling unit is recycled to the contactor to be mixed with incoming wastewater; the remaining excess sludge is transferred to sludge handling processes.

The mechanism of aerobic decomposition in the activated sludge process can be expressed as:

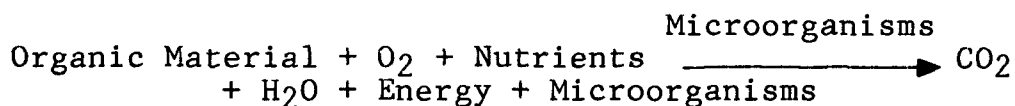

Two separate phases actually occur in parallel; one is the synthesis of organic materials into new microorganism cells in the presence of nutrients, and the other is the oxidation of organic material to  $\text{CO}_2$ ,  $\text{H}_2\text{O}$ , and energy in the presence of oxygen and microorganisms. Two primary nutrients are required for the formation of new cells in the former reaction; these are nitrogen and phosphorus. Most wastewaters contain sufficient quantities of nutrients; however, nutrients have to be added where this is not the case.

Oxygen is required in this process to support the oxidation and synthesis reactions. Various aeration methods are employed to transfer oxygen to wastewater. They include mechanical aeration and diffused aeration.

Mechanical Aeration. Mechanical aeration methods include a submerged turbine with compressed air spargers (agitator/sparger system) and surface mechanical entrainment aerators. The agitator/sparger system consists of a radial-flow turbine located below the mid-depth of the basin with compressed air supplied to the turbine through a sparger. The surface-type aerators entrain

## Flow Diagram, Conventional Activated Sludge Process

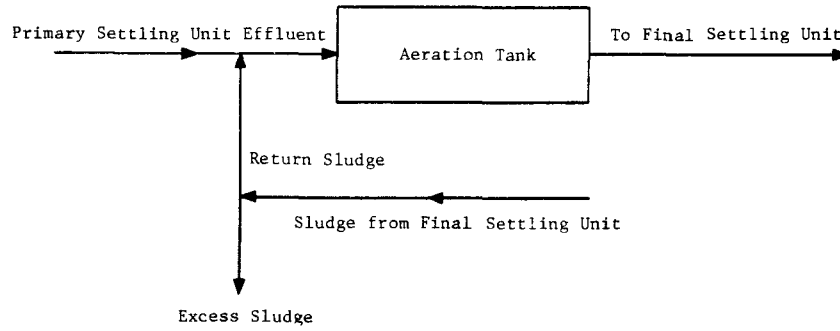

## Mechanical Surface Aeration

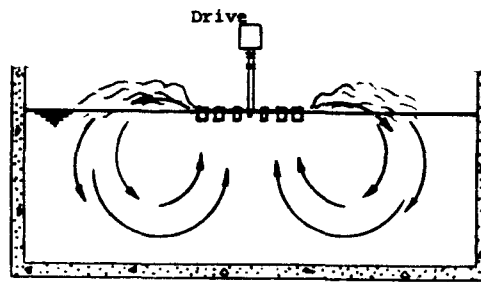

## Diffused Aeration

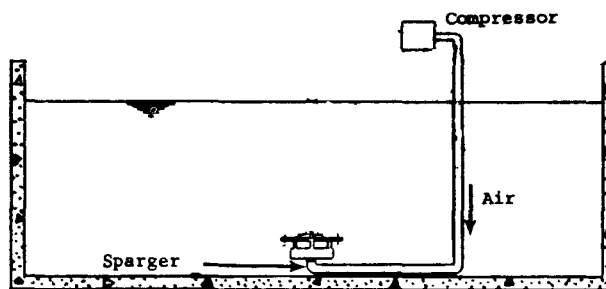

Figure VIII-1

## ACTIVATED SLUDGE TREATMENT PROCESS

Figures adapted from Innovative and Alternative Technology Assessment Manual, EPA 430/9-78-009.



atmospheric air by producing a region of intense turbulence at the water surface. They are designed to pump large quantities of liquid, thus dispersing the entrained air and agitating and mixing the basin contents. Figure VIII-1 contains a schematic diagram of a mechanical surface aeration unit.

Diffused Aeration. In a diffused air system, compressors are used to supply air to a diffusion network. Diffused air systems may be classified as fine bubble or coarse bubble. Diffusers commonly used in the activated sludge process include porous ceramic plates laid in the basin bottom (fine bubble), porous ceramic domes or ceramic or plastic tubes connected to a pipe header and lateral system (fine bubble), tubes covered with synthetic fabric or wound filaments (fine or coarse bubble), and specifically designed spargers with multiple openings (coarse bubble). A diffused aeration sparger system is also depicted in Figure VIII-1.

Two modifications to the activated sludge process are pure oxygen and extended aeration:

Pure Oxygen. The use of pure oxygen for activated sludge treatment has become competitive with the use of air due to the development of efficient oxygen dissolution systems. The benefits of substituting pure oxygen for air include reduced power requirements for dissolving oxygen in the wastewater, reduced aeration tank volume, and improved biokinetics of the activated sludge. Lower amounts of excess sludge are generated; the thickening capability of pure oxygen activated sludge is generally greater than the thickening capability of the air activated sludge.

Extended Aeration. Extended aeration is a modification of the activated sludge process in which the fundamental idea is to minimize the amount of excess sludge, which represents a disposal problem. Extended aeration is distinguished from the conventional activated sludge process by longer retention times, lower food to microorganism ratios, higher oxygen consumptions, and higher concentration of microorganisms in the contactor. All of these factors lead to a decrease in the amount of sludge that has to be disposed of.

Excess sludge is formed in the activated sludge process because there is a net increase in the microorganism formation. However, there is an additional reaction that occurs in extended aeration in which the new microorganism cells undergo self-oxidation because sufficient time is allowed for further completion of the oxidation process. In the self-oxidation step, the microorganisms consume their own cell material for energy (a step also referred to as endogenous respiration). However, there is always a portion of the sludge that is non-biodegradable.

The extended aeration process is generally applicable to relatively small wastewater flows for which the additional retention time (and aeration basin volume) is less costly compared to costs of the aeration basin volume for larger flows. The application of extended aeration for small flows is usually accomplished with package treatment plants. There are a variety of proprietary extended aeration package plants available on the market today. A typical design features three chambers. The influent enters the first chamber where scum and sludge are separated. The second chamber is where the aeration occurs. The third and final compartment is a settling chamber where sludge settles by gravity and is returned to the aeration portion of the unit. Figure VIII-2 presents a diagram of an extended aeration activated sludge package plant.

Applications. The activated sludge process is employed in domestic and industrial wastewater treatment for the removal of conventional, nonconventional, and priority organic pollutants. Limited priority pollutant metals removal has also been observed in activated sludge processes. Activated sludge processes can be used to treat PM&F process waters to remove dissolved organic pollutants found in treatable concentrations (see Table VIII-2). Industrial wastewater that is amenable to biological treatment and degradation may be jointly treated with domestic wastewater in an activated sludge process.

Technology Status. Activated sludge has not been demonstrated for the treatment of process waters generated solely by PM&F processes. However, it is a widely demonstrated, effective biological treatment process that has been used to treat wastewaters with conventional pollutant characteristics similar to the conventional pollutant characteristics of PM&F process waters.

Limitations/Reliability. Activated sludge treatment processes can be upset with variations in hydraulic and organic loads. For example, shock loads of phenolic compounds will kill the microorganisms that oxidize the organic materials and make the activated sludge process work. Under steady state conditions, phenols can be treated in concentrations up to 500 mg/l (Metcalf & Eddy, Inc.). Activated sludge processes are also not designed for an intermittent wastewater flow. Other disadvantages are high operating costs, operational complexity, and energy consumption. The activated sludge process must be well maintained for it to work properly.

Environmental Impact. The activated sludge process requires proper disposal of sludge to avoid solid waste pollution problems. Excess sludge generation is generally in the range of 0.15 to 0.7 pound per pound BOD<sub>5</sub> removed (EPA Treatability Manual). Energy requirements are approximately 200 kwh/yr per 1,000 gpd

### Batch - Extended Aeration

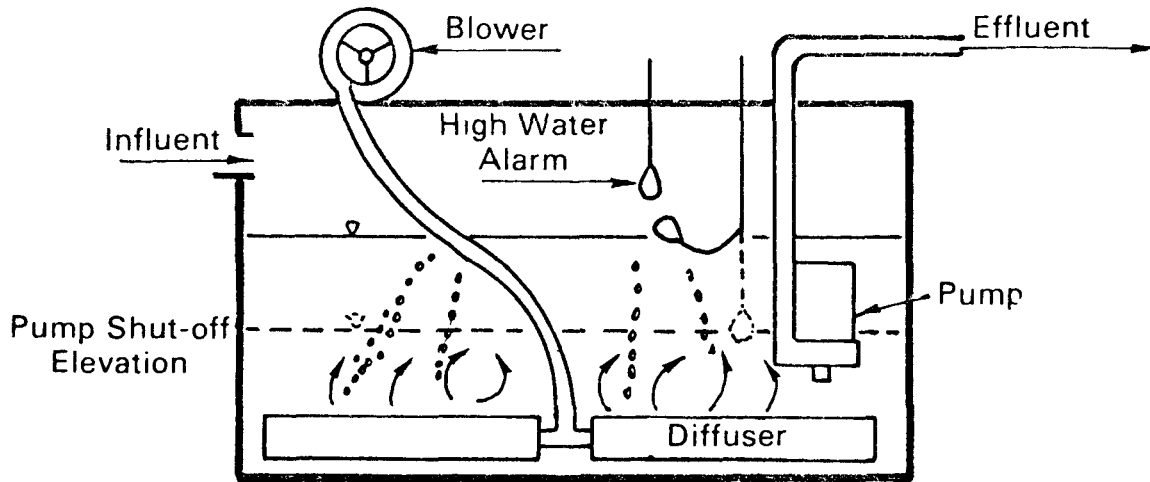

### Flow-Through Extended Aeration

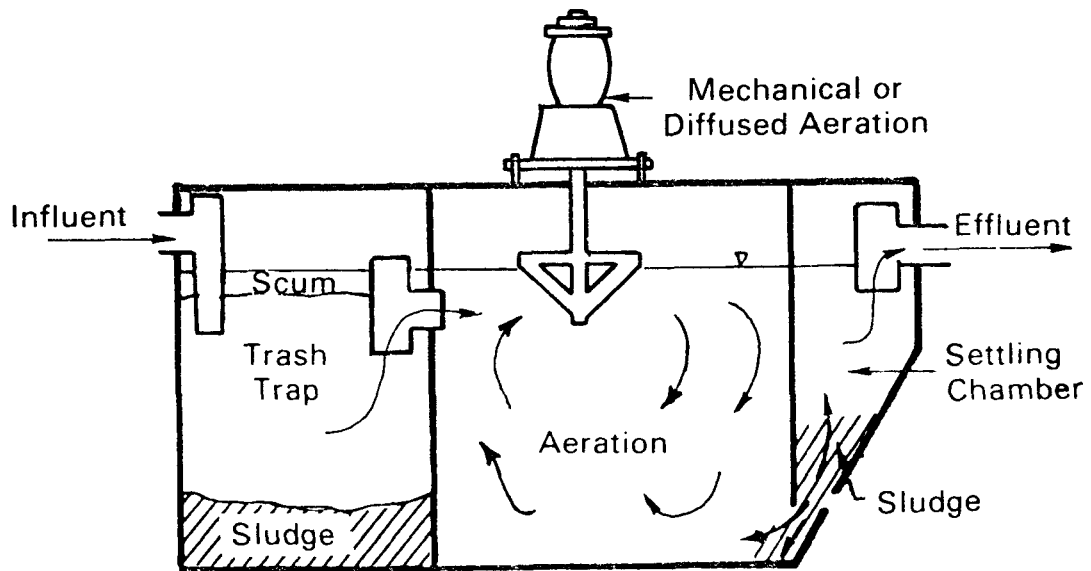

Figure VIII-2

EXTENDED AERATION ACTIVATED SLUDGE PACKAGE PLANTS

treated (Innovative and Alternative Technology Assessment Manual). Improperly operated systems can cause odor problems.

Treatability Data. Treatability data for activated sludge processes treating solely PM&F process waters are not available. However, treatability data for activated sludge processes are available from several studies of other industrial categories.

For conventional pollutants (i.e., BOD<sub>5</sub>, oil and grease, TSS), the available treatability data most applicable to the PM&F category are data from the organic chemicals, plastics, and synthetic fibers category because wastewaters generated by some processes in that subcategory and by some PM&F processes are similar with respect to conventional pollutant concentrations.

Treatability data for nonconventional pollutants (i.e., COD, TOC, total phenols) were based on percent removal values reported in EPA's Treatability Manual, Volume III, Technologies for Control/Removal of Pollutants. These values represented mean percent removals for COD, TOC, and total phenols calculated using performance data from various industries for activated sludge processes.

For priority pollutants found above treatable concentrations, mean percent removals for the activated sludge process were obtained from EPA's Fate of Priority Pollutants in Publicly Owned Treatment Works: Volume I (440/1-82-303); they are presented in Table VIII-4. However, these percent removals are not generally applicable to the relatively low concentrations of priority pollutants characteristic of PM&F process waters. In many cases, application of these percent removals to the average influent concentrations of priority pollutants found in PM&F process waters resulted in effluent concentrations less than the pollutant analytical detection limits.

#### Activated Carbon Adsorption

Activated carbon removes pollutants from water by the process of adsorption (i.e., the attraction and accumulation of one substance on the surface of another). Activated carbon preferentially adsorbs organic compounds over other compounds and, because of this selectivity, is effective in removing organic pollutants from wastewaters. This sorption process occurs when wastewater is passed over the activated carbon in a packed bed.

The term activated carbon applies to any amorphous form of carbon specially treated to give high adsorption capacities. The adsorption of materials onto the active sites in the activated carbon is a reversible process, allowing the carbon to be regenerated for reuse using either heat and steam or solvents.

Table VIII-4

REMOVAL EFFICIENCIES FOR NONCONVENTIONAL POLLUTANTS  
AND PRIORITY POLLUTANTS FOR ACTIVATED SLUDGE PROCESSES

<u>Nonconventional Pollutants</u>	<u>Mean Removal Efficiency (%)</u>	<u>Source</u>
COD	63	A
TOC	63	A
Total Phenols	60	A
<u>Priority Pollutants</u>		
65. phenol	99+	B
66. bis(2-ethylhexyl) phthalate	72	B
67. dimethyl phthalate	No Data	
68. di-n-butyl phthalate	51	B
128. zinc	77	B

## Sources:

- (A) USEPA, Treatability Manual, Volume III, Technologies for Control/Removal of Pollutants, July 1980, EPA 600/8-80-042c.
- (B) USEPA, Fate of Priority Pollutants in Publicly Owned Treatment Works: Volume I, September 1982, EPA 440/1-82/303.

Carbon adsorption requires preliminary treatment of the wastewater to remove excess suspended solids, oils, and greases. Suspended solids in the influent should be less than 50 mg/l to minimize backwash requirements; oil and grease should be less than 10 mg/l.

Activated carbon is available in both powdered and granular form. An adsorption column packed with granular activated carbon is depicted in Figure VIII-3. Powdered carbon is less expensive per unit weight and may have slightly higher adsorption capacity, but it is more difficult to handle and to regenerate compared with granular activated carbon.

Applications. Carbon adsorption is used primarily to remove gaseous contaminants and condensable vapors from gaseous streams. Carbon adsorption has also been used to remove dissolved organic pollutants in both municipal and industrial wastewaters. It is most effective for removing non-polar organic compounds of low molecular weight and slight solubility in the liquid phase. Many inorganic pollutants, including cyanide, chromium, mercury, and chlorine, are also effectively removed in the activated carbon process.

In general, carbon adsorption is used to treat wastewater when a high quality effluent is desired. It is used for such things as purification in industrial processes, pharmaceutical manufacture, drinking water purification, and secondary and tertiary treatment of industrial and municipal wastewaters. Typical applications include removal of phenol from drinking water supplies, sugar decolorization, and removal of mercury from industrial wastewaters. Potentially, activated carbon adsorption is almost universally applicable because trace organics are found in virtually all industrial wastewaters.

Limitations. Wastewaters treated by carbon adsorption require pretreatment if there are significant levels of suspended solids (greater than 50 mg/l) and oil and grease (greater than 10 mg/l) present. High suspended solids levels tend to quickly clog the carbon bed and result in frequent backwashings. Oil and grease tend to coat the activated carbon, interfering with reactivation and resulting in the loss of activity.

Carbon adsorption is generally least effective for the removal of organic pollutants exhibiting the following characteristics:

- o Low molecular weight,
- o High solubility in the liquid phase, and
- o High polarity.

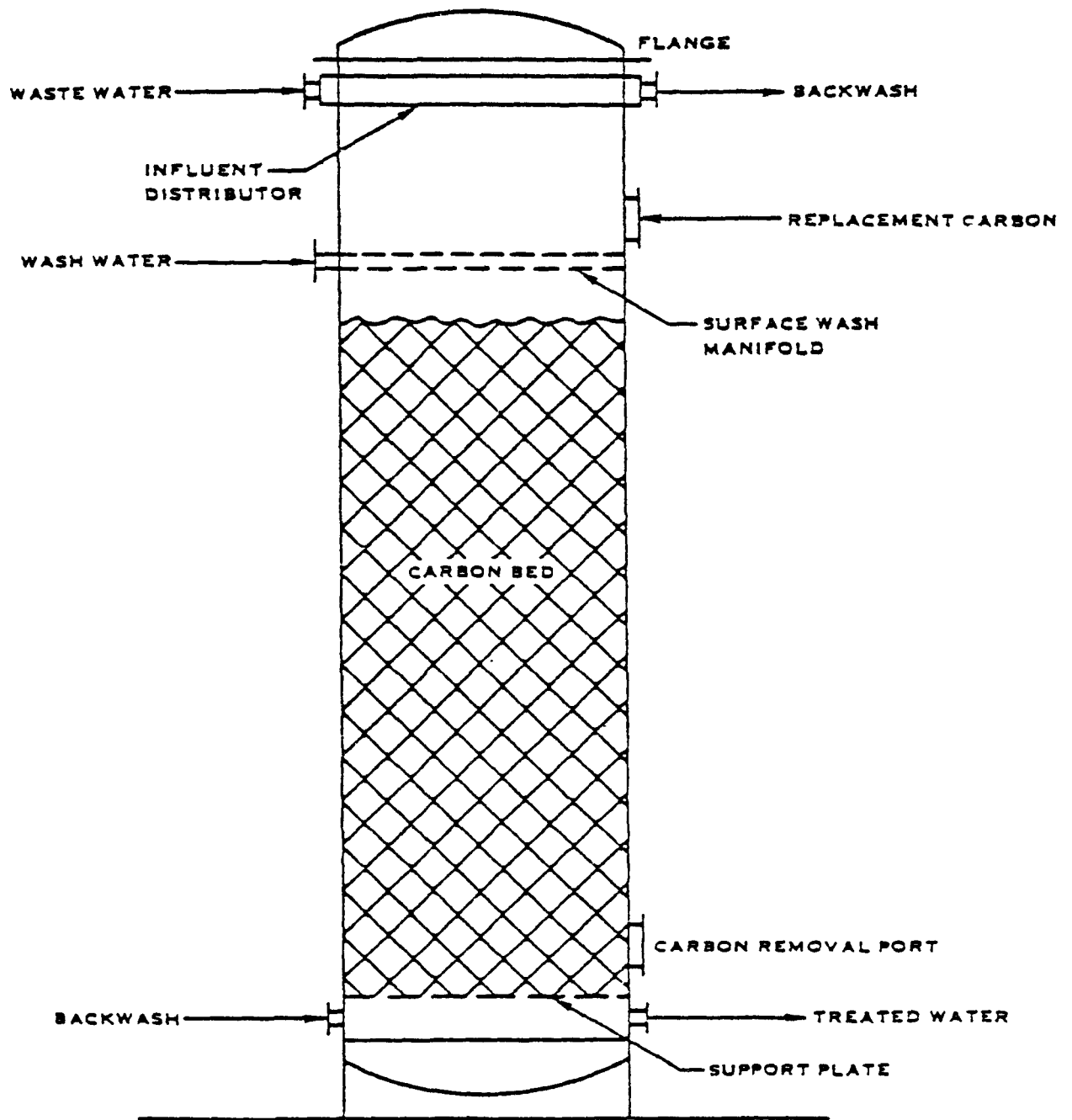

Figure VIII-3  
 ACTIVATED CARBON ADSORPTION COLUMN

High operating and maintenance costs are associated with carbon adsorption due to the relatively sophisticated operation and materials handling.

Reliability. Treatment of wastewater using activated carbon adsorption is moderately reliable, depending on the design, construction, and manufactured equipment quality. In addition, high levels of suspended solids and oil and grease may affect the performance.

Environmental Impact. Carbon adsorption equipment requires minimal use of land. Spent carbon may present a land disposal problem if regeneration is not feasible. There may also be an air pollution problem encountered with regeneration and production of hydrogen sulfide (leading from favorable conditions found in carbon beds).

Treatability Data. A U.S. EPA study entitled, Treatability of Organic Priority Pollutants - Part C - Their Estimated (30-Day Ave.) Treated Effluent Concentration - A Molecular Engineering Approach, indicates that bis(2-ethylhexyl) phthalate can be theoretically removed to 0.010 mg/l (30-day average) using activated carbon treatment preceded by oil-water separation and filtration. Based on consideration of chemical structure and physical and chemical properties that would affect adsorption, the treatability level for dimethyl phthalate and di-n-butyl phthalate were both estimated to be 0.025 mg/l.

#### Filtration (Suspended Solids Removal)

Filtration processes are used either to remove suspended solids from the effluent from other treatment technologies or as a pretreatment process. Filtration processes include a wide range of technologies including screens, granular media filters, belt filters, and membrane filters, just to name a few. Figure VIII-4 contains diagrams of different kinds of filters used to remove suspended solids from wastewater.

The performance of filters is based on a physical screening process in which a barrier\* prevents the passage of suspended solids. The primary difference between the various types of filters is the degree of permeability of the barrier, ranging from the coarseness of a wire screen to the selectivity of ultrafiltration membranes.

---

\* Although processes based on barriers that have no appreciable thickness in the direction of the liquid flow are typically referred to as straining, these processes are considered as filtration processes in this discussion.



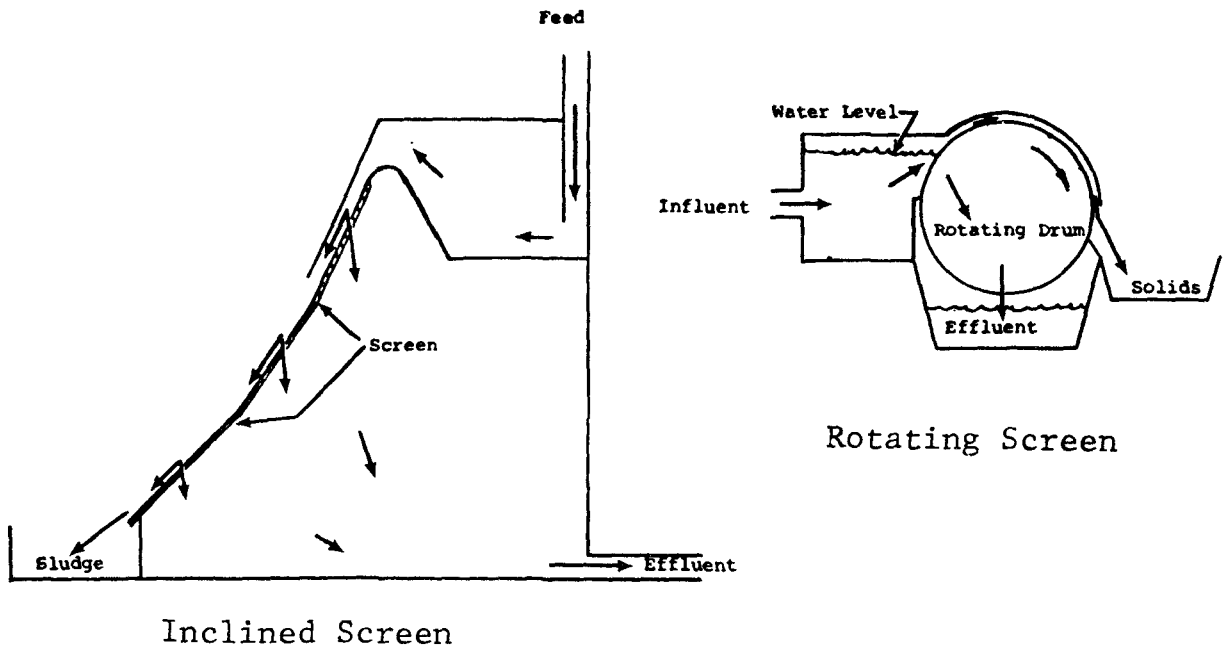

Inclined Screen

Rotating Screen

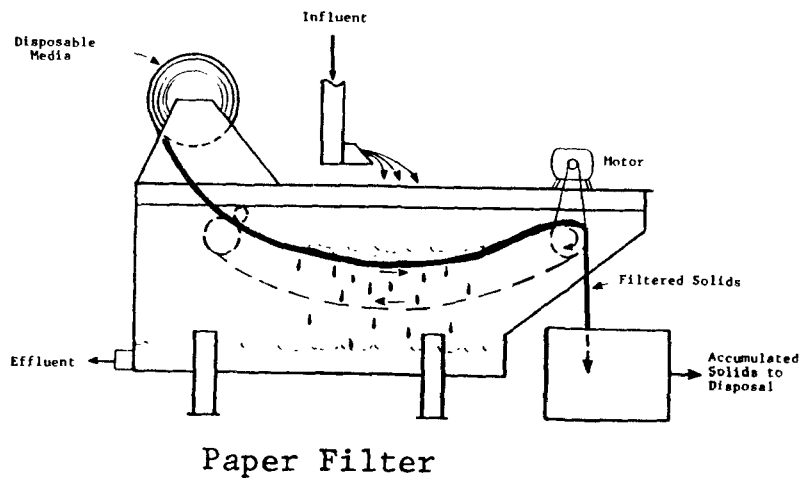

Paper Filter

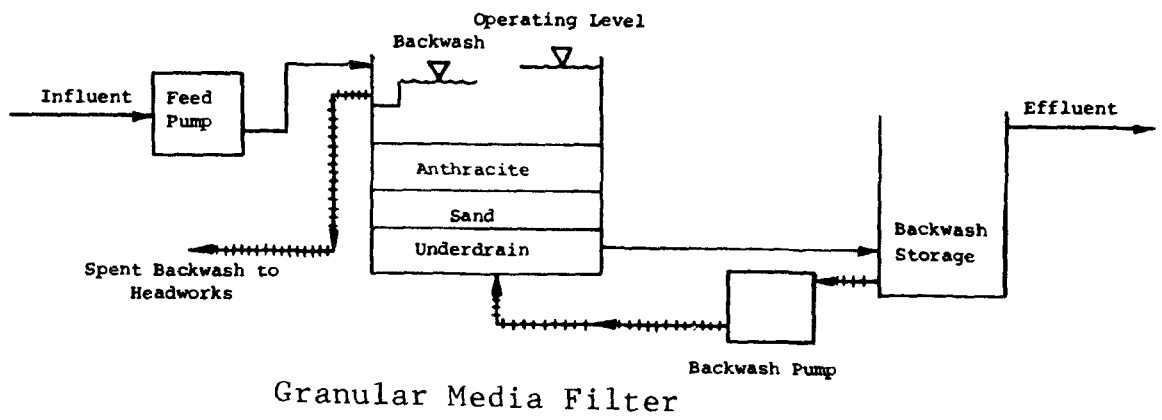

Granular Media Filter

Figure VIII-4  
FILTRATION TECHNOLOGIES

Filtration processes operate on either a batch or continuous basis, depending on the process. For instance, normal practice is to design certain types of filters (e.g., granular media, cartridge, bag) to operate on a batch basis with entire units taken out of service for cleaning (e.g., backwashing, filter media replacement) according to a schedule or as required. Some granular media filter designs, however, provide more or less continuous cleaning, either externally with media cycled through the bed, or in-place with techniques such as traveling backwash or air pulsing of the bed and air mixing of the liquid above it. Other types of filters, such as inclined screens and paper filters (see Figure VIII-4) usually provide continuous removal of the accumulated solids.

Applications. Filtration can be used for a wide range of applications including: (1) the removal of coarse solids by screening in a pretreatment process, (2) the removal of precipitated solids after chemical coagulation of wastewaters, and (3) treatment of settled effluent from other treatment technologies (e.g., the activated sludge process).

Technology Status. Several types of filters are currently used to treat PM&F process waters. Technologies observed during sampling episodes include a bag filter, a paper filter, and a belt filter.

Limitations. Economics of filtration processes can be highly dependent on consistent influent quality and flow variations. The performance of filtration processes may be limited by the filterability (e.g., particle size, floc strength, adhesive properties) of the suspended solids. The filterability may be improved by addition of filter aids such as alum to act as coagulants and to increase the floc strength.

In addition, dissolved solids are generally not removed by filtration processes, with the exception of certain processes based on selective membranes that are capable of removing dissolved solids.

Reliability. Filters typically have a high degree of reliability when properly maintained. Occasional problems may arise when the filters are not properly cleaned.

Environmental Impact. The major environmental impact of filters is the disposal of the suspended solids removed from the wastewater. Solids have to be disposed of properly to avoid negative environmental impacts. Filters usually do not contribute to other types of pollution (e.g., air pollution).

Treatability Data. Filtration is an effective and widely used technology for removing total suspended solids from wastewater. Typical percent removals for suspended solids range from 5 to 95 percent. The median percent removal for suspended solids using granular media filtration is 75 percent based on treatability data reported in Treatability Manual, Volume III, Technologies for Control/Removal of Pollutants, (EPA 600/8-80-042C). Mean removal efficiencies ranging from 10 to 25 percent for oil and grease, BOD<sub>5</sub>, TOC, COD, and total phenols have also been achieved in filtration units.

#### Vacuum Filtration (Sludge Dewatering)

In wastewater treatment plants, sludge may be dewatered by vacuum filters that generally use cylindrical drum filters. These filters have a medium that may be cloth made of natural or synthetic fibers or a wire-mesh fabric. The drum is suspended above and dips into a vat of sludge. As the drum rotates slowly, part of its circumference is subject to an internal vacuum that draws sludge to the filter medium. Water is drawn through the porous filter cake to a discharge port, and the dewatered sludge, loosened by compressed air, is scraped from the filter mesh. Because the dewatering of sludge on vacuum filters is relatively expensive per kilogram of water removed, the liquid sludge is frequently thickened prior to processing. A vacuum filter is depicted in Figure VIII-5.

Applications. Vacuum filters are frequently used both in municipal treatment plants and in a wide variety of industries. They are most commonly used in larger facilities, which may have a thickener to double the solids content of sludge before vacuum filtering.

Technology Status. Vacuum filtration is a fully proven technology for sludge dewatering. It is used for sludge dewatering in many industries.

Limitations. Vacuum filters are not practical at low dewatered sludge outputs due to their high initial cost and area requirements. In addition, vacuum filters have high maintenance requirements, which are characteristic of sludge dewatering equipment. Maintenance consists of the cleaning or replacement of the filter media, drainage grids, drainage piping, filter pans, and other parts of the equipment. Experience in a number of vacuum filter plants indicates that maintenance consumes approximately 5 to 15 percent of the time of the maintenance personnel. If carbonate buildup or other problems are unusually severe, maintenance time may be as high as 20 percent. For this reason, one or more spare units should be available. If intermittent operation is used, the filter equipment should be drained

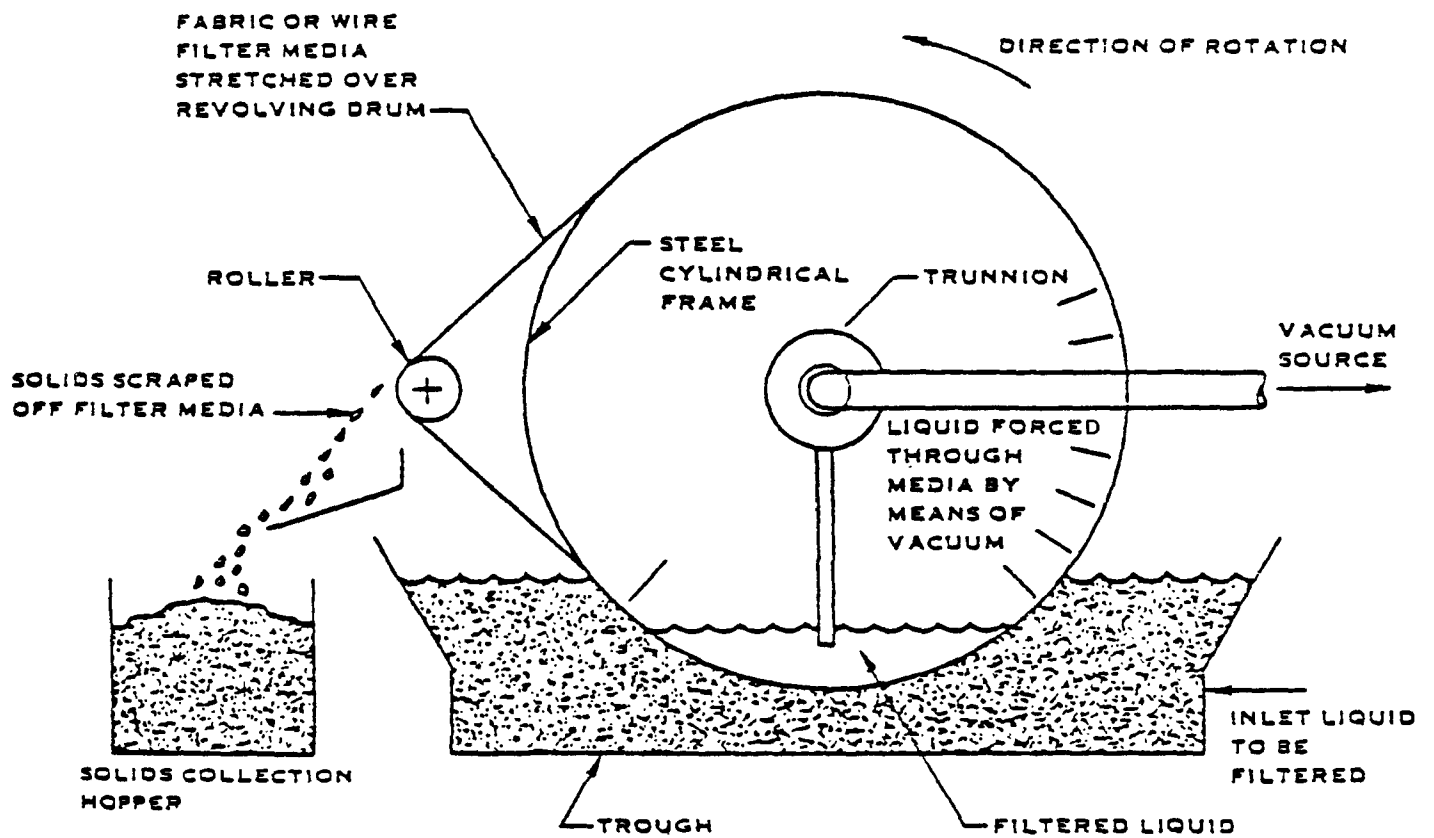

Figure VIII-5  
VACUUM FILTER

and washed each time it is taken out of service. An allowance for this wash time must be made in filtering schedules.

Reliability. Vacuum filters have proven reliable at many industrial and municipal treatment facilities. At present, the largest municipal installation that uses vacuum filters is the West Southwest wastewater treatment plant in Chicago, Illinois, where 96 large filters were installed in 1925, functioned approximately 25 years, and then were replaced with larger units. Original vacuum filters at Minneapolis-St. Paul, Minnesota, now have over 28 years of continuous service.

Environmental Impact. The disposal of the solid cake generated from vacuum filtration is the only major environmental impact associated with this technology. The solid waste is usually disposed in a landfill. The characteristics of the dewatered sludge depend primarily on the raw waste characteristics of the treated wastewaters and the particular treatment technology utilized.



## SECTION IX

### COSTS, ENERGY, AND NON-WATER QUALITY ASPECTS

#### INTRODUCTION

This section presents the technical data used to develop cost estimates for the treatment technologies described in Section VIII. In addition, the methodology for estimating process-by-process treatment costs is discussed. Cost estimates obtained using information presented in this section are used to evaluate the control and treatment options for each type of effluent limitations guidelines and standards. The cost estimates are also used as the basis to estimate the economic impact of the final regulation on the PM&F category.

This section also discusses the technical basis for the Agency's estimates of (1) the energy used by the treatment technologies, (2) solid waste generation rates, and (3) other non-water quality impacts attributable to implementation of the control and treatment technologies.

#### COST ESTIMATES FOR TREATMENT TECHNOLOGIES

##### Sources of Cost Data

Capital and operation and maintenance (O&M) cost data for the treatment technologies were obtained from two sources: (1) equipment manufacturers and (2) the literature. The major sources of capital costs were contacts with equipment vendors. Most of the O&M cost information was obtained from the literature.

##### Cost Components

Capital costs consist of equipment costs and system costs. Equipment costs include: (1) the purchase price of the manufactured equipment and any accessories; (2) delivery charges, which account for the cost of shipping the purchased equipment a distance of 500 miles; and (3) installation charges, which include charges for labor, excavation, site work, and materials.

System capital costs include engineering, administrative, and legal costs, contingencies, and the contractor's fee. The engineering, administrative, and legal costs are expressed as a percentage of the equipment costs. Contingencies and contractor's fee are expressed as a percentage of the sum of the equipment costs and the engineering, administrative, and legal costs. Equipment costs and system costs are added to obtain the total capital costs. The components of capital costs are listed below:

<u>Item No.</u>	<u>Item</u>	<u>Cost</u>
1	Equipment Costs	Cost of installed equipment
2	Engineering, Administrative, and Legal	10 percent of Item 1
3	Subtotal	Item 1 and Item 2
4	Contingency	15 percent of Item 3
5	Contractor's Fee	10 percent of Item 3
6	Total Capital Cost	Items 3 through 5

Operation and maintenance costs include the following:

1. Raw materials costs - These costs are for chemicals used in the treatment processes, which include caustic, sulfuric acid, corrosion inhibitors, and biocides.
2. Operational labor costs - These costs account for the labor directly associated with operation of the process equipment. Labor requirements are estimated in terms of hours per year. A composite labor rate of \$21 per hour was used to convert the annual hours to an annual cost. This composite labor rate includes a base labor rate of \$9 per hour for skilled labor, 15 percent of the base labor rate for supervision, and 100 percent of the base rate for plant overhead. Nine dollars per hour is the Bureau of Labor national wage rate for skilled labor.
3. Maintenance and repair costs - These costs account for the labor and materials required for repair and routine maintenance of the equipment. Maintenance and repair costs were assumed to be five percent of the equipment costs based on information from literature sources unless more reliable data were available from vendors.
4. Energy costs - Energy or power costs were calculated based on total nominal horsepower requirements for the equipment (in kw-hrs); an electricity charge of \$0.049/kilowatt-hour; and an operating schedule of 24 hours/day, 250 days/year unless specified otherwise. The electricity rate is based on the industrial electricity rate derived from the Department of Energy's Monthly Energy Review (March 1982).



In addition to O&M costs, total annualized costs include monitoring costs. Monitoring refers to periodic sampling and analysis to verify that discharge limitations are being met. Monitoring costs were based on \$300 per sample for toxic pollutants (base/neutral extractables analysis via gas chromatography/mass spectrophotometry) and \$50 per sample for conventional pollutants (BOD<sub>5</sub>, TSS, oil and grease, and pH). These costs were determined from in-house literature and from a vendor quote. The costs per analysis were multiplied by the monitoring frequency (i.e., number of analyses per year) to obtain the annual monitoring costs for a particular plant. Monitoring frequencies and the annual monitoring costs for each plant are discussed in the Economic Impact Analysis of Effluent Limitations and Standards for the Plastics Molding and Forming Industry, EPA 440/2-84-025, December 1984. Amortized costs, which account for depreciation and the cost of financing, are also discussed in the economic analysis document.

#### Cost Update Factors

All costs were standardized by adjusting them to the first quarter of 1982. The cost indices used for particular components of costs are described below.

Capital Costs - Capital costs were adjusted using the EPA-Sewage Treatment Plant Construction Cost Index. The value of this index for March 1982 is 414.0.

Operation and Maintenance-Labor Costs - The Engineering News-Record Skilled Labor Wage Index was used to adjust the portion of operation and maintenance cost attributable to labor. The March 1982 value is 325.0.

Maintenance and Repair Costs - The producer price index published by the Department of Labor, Bureau of Statistics was used for these costs. The March 1982 value of this index is 276.5.

Raw Materials Costs - The Chemical Engineering Producer Price Index for industrial chemicals was used. This index is published biweekly in Chemical Engineering magazine. The March 1982 value of this index is 362.6.

#### Cost Data Correlation

To estimate capital and O&M costs for the treatment technologies, cost data from all available sources were plotted on a graph of capital or O&M costs versus a design parameter (usually flow rate). These data were distributed over a range of flows. A single line was fitted to the data points, thus arriving at a cost curve that represented an average of all the costs for

either a treatment technology or a component of a treatment technology. Because the cost estimates presented in this section are applicable to treatment technologies used in varying circumstances and geographic locations, the Agency believes this statistical approach best estimates costs of the technologies considered for the final PM&F regulation. For consistency in estimating costs and accuracy in reading the final cost curves, equations were developed to represent the final cost curves. Capital and operation and maintenance cost equations are listed in Table IX-1.

### DESIGN DATA FOR TREATMENT TECHNOLOGIES

Design data and cost information are presented for the following treatment and control technologies:

- Flow equalization,
- pH adjustment,
- Settling,
- Package activated sludge plant,
- Activated carbon adsorption,
- Vacuum filters, and
- Contract haul.

#### Flow Equalization

Flow equalization is accomplished using holding tanks sized for a retention time of eight hours and an excess capacity factor of 20 percent. Equalization costs were based on the following equipment:

1. Equalization tank (eight hour retention time)
2. Influent pump

Cost correlations are available for equalization tanks with a volume between 50 and 500,000 gallons based on vendor quotations. Three separate capital cost equations were developed, one for fiberglass tanks ranging from 50 to 1,000 gallons, another for fiberglass tanks from 1,000 to 24,000 gallons, and a third for 24,000 to 500,000 gallon steel tanks. Capital costs for steel tanks with a volume greater than 24,000 gallons include on-site fabrication, two coats of epoxy, a prime coat, and a finish coat.

O&M costs for tanks include maintenance costs (e.g., for inspection, repair) and labor costs for removing settled solids from the tank. The maintenance costs are estimated as two percent of the capital cost of the tank and the labor requirements for settled solids removal range from 1 to 4.5 hours per week, depending on the tank size.

Table IX-1  
CAPITAL AND O&M COST EQUATIONS\*

<u>Equipment</u>	<u>Equation</u>	<u>Range of Validity</u>
Activated Carbon Adsorption	$C = 19,280$ $C = 16,538.7 + 836.368 Y - 3.40459 Y^2$ $C = -60,242.7 + 1,814.97 Y - 2.79681 Y^2$ $A = 3,140$ $A = 3,112 + 209.26 Y - 0.3526 Y^2$ $A = 14,214 + 14.668 Y + 0.2696 Y^2$	$CER = 0.374, 0 < Y < 5$ $, 5 \leq Y < 75$ $, 75 < Y < 310$ $, 0 < Y < 1$ $, 1 \leq Y < 75$ $, 75 < Y < 310$
	$C = 19,220$ $C = 7,847 + 11,531.4 Y - 98.524 Y^2$ $C = 132,579 + 1,738.07 Y$ $A = 3,400$ $A = 2,694.5 + 2,787.15 Y - 99.2586 Y^2$ $A = 5,865.5 + 1,086.30 Y$	$CER = 3.90, 0 < Y < 1$ $, 1 \leq Y < 15$ $, 15 \leq Y < 150$ $, 0 \leq Y < 0.15$ $, 0.15 \leq Y < 15$ $, 15 \leq Y < 150$
Agitators, C-clamp	$C = 417 + 4,030 (HP)$ $A = 104 + 351 (HP)$ $C = 839.1 + 587.5 (HP)$ $A = 2,739.89 + 403.365 (HP) + 0.7445 (HP)^2$	$0 < HP \leq 0.25$ $0.25 < HP \leq 0.33$
	$C = 1,585.55 + 125.302 (HP) - 3.27437 (HP)^2$ $A = 2,739.89 + 403.365 (HP) + 0.7445 (HP)^2$	$0.33 < HP < 5.0$
Contract Haul	$C = 0$ $A = 0.40 (G)(HPY)$	Nonhazardous Wastes
Lime Feed System	$C = \exp[9,13051 + 0.114998 \ln (F) + 0.18767 (\ln F)^2]$ $A = \exp[7,00162 + 0.317975 \ln F + 0.064336 (\ln F)^2] + 0.022 (F) (HPY)$	$0.01 < F < 10$ $0.01 < F < 10$
	$C = 2,566$ $A = 910$ $C = 9,165$ $A = 3,055$ $C = 6,500 + 1.71 X$ $A = 1,600 + 0.96 X$ $C = \exp[1.57977 + 1.22209 (\ln X) - 0.028484 (\ln X)^2]$ $A = 4,538.99 + 0.0737513 (X) - 2.77111 \times 10^{-7} (X^2)$	$X < 600$ $600 < X \leq 1,500$ $1,500 < X \leq 5,000$ $5,000 < X < 100,000$
Pumps, Transfer	$C = \exp[6.31076 + 0.228887 (\ln Y) + 0.0206172 (\ln Y)^2]$ $A = \exp[6.67588 + 0.031335 (\ln Y) + 0.062016 (\ln Y)^2]$	$3 < Y < 3,500$
Tank, Fiberglass	$C = 3,100.44 + 1.19041 (V) - 1.7288 \times 10^{-5} (V)^2$ $A = 0.02(C) + (21)[4.17 \times 10^{-5}(V) + 0.958]$ $A = 0.05(C)$ $A = 0.02(C)$	$500 < V < 24,000$ Equalization w/settling Settling Equalization/holding w/o settling

Table IX-1 (Continued)  
CAPITAL AND O&M COST EQUATIONS\*

<u>Equipment</u>	<u>Equation</u>	<u>Range of Validity</u>
Tank, Steel	$C = 14,759.8 + 0.170817 (V) - 8.44271 \times 10^{-8} (V)^2$ $A = 0.02(C) + (21)[4.17 \times 10^{-5}(V) + 0.958]$ $A = 0.05(C)$ $A = 0.02(C)$	24,000 < V < 500,000  Equalization w/settling Settling Equalization/holding w/o settling
Vacuum Filter	$C = 71,083.7 + 442.3(SA) - 0.233807(SA)^2$ $A = 17,471.4 + 677.408(SA) - 0.484647(SA)^2$	9.4 < SA < 750
Vacuum Filter Housing	$C = (45)[308.253 + 0.836592(SA)]$ $A = (4.96)[308.253 + 0.836592(SA)]$	9.4 < SA < 750

---

A = Operation and maintenance costs (1982 dollars/year)  
 C = Equipment costs (1982 dollars)  
 CER = Carbon exhaustion rate (pounds carbon/1,000 gallons)  
 F = Chemical feed rate (pounds/hour)  
 G = Sludge disposal rate (gallons/hour)  
 HP = Power requirement (horsepower)  
 HPY = Plant operating hours (hours/year)  
 SA = Filter surface area (square feet)  
 V = Tank capacity (gallons)  
 X = Wastewater flow rate (gallons/day)  
 Y = Wastewater flow rate (gallons/minute)

\*Capital cost equations do not include system capital costs (e.g., engineering, contingency, etc.); system costs must be added to the equipment costs (calculated by the above cost equations) to obtain total capital costs. O&M cost equations do not include either monitoring or amortization costs.

Capital costs for pumps are based on vendor quotations for positive displacement pumps with a flow rate between 3 and 27 gpm and centrifugal pumps, which are more economical at higher flow rates, with a flow rate between 27 and 3,500 gpm. Pump O&M costs are based on the following:

- energy costs, which were estimated assuming a pump efficiency of 70 percent; the pump operates for the reported plant operating hours at the nominal capacity (horsepower);
- operating labor costs, which were based on 0.5 hours labor/operating day; and
- maintenance labor costs, which were based on labor requirements ranging from 0.005 to 0.03 hours labor/hour of pump operation (depending on pump capacity).

### pH Adjustment

Costs were estimated for adjusting the pH of process waters from pH 5 to pH 7 by the addition of lime. An influent pH of 5 was selected based on a review of pH's from the sampling data. Adjustment of pH occurs in the equalization tank if such a tank is included in the treatment technology. If equalization is not required, pH adjustment occurs in a mix tank with an appropriately sized agitator (based on 0.5 horsepower/1,000 gallons). Costs for the following equipment were included in pH adjustment costs:

1. Mix tank (if equalization tank is not available)
2. Lime feed system
  - storage tank
  - chemical metering pump
  - pipe and valves
  - instrumentation (pH control)
3. Agitator

Capital costs for the mix tank were obtained using the cost equations used to calculate equalization tank costs, as described in the flow equalization discussion in this section. O&M costs for mix tanks are estimated as five percent of the tank capital cost and are for maintenance (e.g., periodic clean out and repair).

A capital cost equation for the lime feed system delivering between 0.01 and 10 lbs lime/hour on a continuous basis was developed from vendor quotations. The capital costs include

costs for a pH monitor (flow-through pH analyzer), electrical and instrumentation (e.g., conduit, indicating controller, transducer), piping and valves (e.g., control valve and instrumentation piping), a C-clamp agitator, and a storage tank (sized to hold six percent weight lime slurry for one week).

O&M costs for lime feed systems include energy costs for the agitator, operational labor costs for preparation of chemical stock solutions and calibration of instrumentation, and maintenance costs for the tank and valving.

Lime feed system costs were included in the pH adjustment costs because PM&F process waters generally have to be adjusted from acidic to neutral conditions when pH adjustment is necessary. In cases when an acid feed system was required, the costs of an acid feed system were assumed to be equal to the costs of the lime feed system. This assumption tends to overestimate the pH adjustment costs because an acid feed system requires a less sophisticated metering system than a lime feed system.

Capital and O&M cost equations were developed for three types of agitators: (1) small C-clamp agitators (less than 0.25 hp), (2) medium-sized C-clamp agitators (between 0.25 and 0.33 hp), and (3) top-entry agitators (between 0.33 and 10 hp). The capital costs for agitators, which were based on vendor quotations, include costs of enclosed gear drives, electric motors, and 304 stainless steel shafts and propellers. Agitator O&M costs include energy costs (based on estimated horsepower requirements and 8,760 operating hours per year) and maintenance labor and materials costs (assumed to be five percent of the capital cost).

### Settling

Settling tanks are used for gravity separation of suspended solids in wastewater. The settling unit was sized for eight hours of retention time. It was assumed that 82 percent influent solids were removed. This technology includes:

1. Settling tank (eight hour retention time)
2. Pump

Operating and maintenance costs include tank maintenance and settled solids removal (estimated as five percent of capital cost of tank) and O&M costs associated with the pump. Refer to previous discussion on flow equalization for information on tank capital costs and for information on pump capital and O&M costs.

## Package Activated Sludge Plant

Package activated sludge plants are usually composed of three tanks (see Figure VIII-2) in which primary settling, activated sludge treatment (extended aeration), and secondary settling occur. The influent enters the first chamber where scum and settleable solids are removed. The second chamber (i.e., the activated sludge unit) is where dissolved pollutants are treated. The final chamber is a settling unit where solids settle by gravity and are either returned to the aeration unit or removed. Package activated sludge plants can be used for flows as low as 600 gallons per day.

Capital costs for a package activated sludge plant included the following:

1. Costs for a nutrient addition system
  - mix tank (retention time of eight hours for PM&F plants operating eight hours per day, 10 minutes for PM&F plants operating 16 to 24 hours per day)
  - agitator (sized based on 0.5 hp/1,000 gallons)
  - chemical feed pumps (2)
  - chemical day tanks (2)
2. Costs for the activated sludge unit
  - primary settling tank
  - aeration chamber
  - secondary settling tank

The following assumptions were made in the design of the package activated sludge plant:

1. Influent process water characteristics:  
BOD<sub>5</sub> = 89 mg/l  
TSS = 714 mg/l  
pH = 5  
  
Effluent process water characteristics:  
BOD<sub>5</sub> = 22 mg/l  
TSS = 36 mg/l  
pH = 7
2. "Nutrients" are added to the process water to maintain an active microorganism level. Nitrogen is added at a dosage level of 8.9 mg/l (one-tenth of the influent BOD<sub>5</sub> concentration) as ammonia chloride (NH<sub>4</sub>Cl).

Phosphorus is fed at a dosage level of 0.89 mg/l (one-hundredth of the influent BOD<sub>5</sub> concentration) as phosphoric acid (H<sub>3</sub>PO<sub>4</sub>).

3. Nutrients (for maintaining the activated sludge) and lime (for adjusting the pH) are added in a mix tank. Nutrient and lime addition was accomplished on either a batchwise or continuous basis depending on which alternative was less costly. For addition of the chemicals to the high flow rate PM&F processes, a rapid mix tank (10 minute retention time) and continuous feed system was more economical compared with collection of the process water generated during the course of an operating day followed by manual addition of chemicals on a batchwise basis. For low flow rate processes, however, the batch addition scheme was more economical than continuous chemical addition due to the relatively high capital costs of continuous feed systems.

Because the low flow rate processes were generally associated with plants with fewer number of operating hours, the selection of either batch or continuous chemical addition was based on the plant operating schedule. For plants operating eight hours per day, the mix tank is sized for eight hours of retention (in addition to 20 percent excess capacity) and chemicals are manually added on a batch basis. For plants operating 16 or 24 hours per day, chemicals are added continuously in a rapid mix tank sized for 10 minutes of retention. Costs for lime feed systems are described separately under the pH adjustment discussion in this section.

4. The design for the activated sludge treatment of industrial wastes is based on three-stage treatment, consisting of primary settling, extended aeration, and secondary settling. However, the commercially available package activated sludge units that are applicable to low flow rate processes only provide two-stage treatment (aeration followed by settling). Thus, costs for a primary settling tank sized for a retention time of eight hours were added to the costs of the two-stage package units.
5. The package activated sludge treatment plant design includes flow equalization. Flow equalization is provided in the nutrient addition mix tank for PM&F plants operating eight hours per day and in the primary settling tank for PM&F plants operating either 16 or 24 hours per day. In each case, the tank is sized for an eight hour retention time based on instantaneous influent flow rate.



6. The nominal package activated sludge treatment plant capacity is based on a continuous influent flow rate. The smallest capacity package plant for which costs were obtained is 600 gpd. If the influent flow is greater than 200 gpd but less than 600 gpd, costs for the 600 gpd package plant were assumed. Treatment costs for PM&F processes with a flow rate less than 200 gpd were based on disposal by contract haul, which is more economical than treatment in a package activated sludge plant at these flow rates. It was assumed in these cases that PM&F plants will use the less costly method of complying with the PM&F regulation.
7. Sludge production rates are based on removal of TSS from the influent concentration of 714 mg/l to a concentration of 36 mg/l, plus production of 0.6 lb sludge (dry weight) per lb of BOD<sub>5</sub> removed. Sludge from the settling units consists of two percent solids (TSS = 20,000 mg/l).
8. Costs are provided for sludge dewatering based on vacuum filtration of the sludge to 20 percent solids if such treatment is economical. Sludge is contract hauled without dewatering if the influent flow to the vacuum filter is less than 50 l/hr.

#### Activated Carbon Adsorption

Activated carbon is used to remove dissolved organic contaminants from wastewaters. As the wastewater is pumped through the carbon column, organic contaminants diffuse into the carbon particles through pores and are adsorbed onto the pore walls. As organic material accumulates, the carbon loses its effectiveness and must be replaced or regenerated periodically.

Two downflow carbon columns in series are usually used.\* The leading column loses its effectiveness first because most of the organic pollutants are adsorbed in it. When breakthrough occurs (i.e., when the column effluent concentration of a specified adsorbed pollutant exceeds a specified maximum), the column is taken off-line and regenerated or replaced and the second column becomes the leading column. This configuration, known as a

---

\* When it was estimated that breakthrough would occur less than once every three months, two columns were not deemed necessary. Thus, costs were based on a single adsorption column in these cases.

"merry-go-round," results in a more consistent effluent quality than a single, larger column or a system where one column is active and one is on standby. During column operation, solids accumulate in the interstices of the carbon bed. To prevent the column from plugging, the bed must be periodically backwashed to remove these solids. Also, a method for replacing spent carbon is required. Either replacement with virgin carbon and disposal of the spent carbon or regeneration of the spent carbon by either off-site or on-site regeneration may be used, depending on the carbon usage rate.

Costs of the following equipment were included in the estimate of capital costs for the activated carbon process:

1. Carbon adsorption unit
  - steel adsorption columns (1 or 2 columns depending on estimated carbon exhaustion rate)
  - hydraulic loading = 2.5 gpm/ft<sup>2</sup>
  - initial activated carbon charge
  - pump for transfer between surge tank and column
  - piping
  - instrumentation
2. Backwash facilities
  - backwash hold tank - provides 15 gpm/ft<sup>2</sup> per column for 15 minutes (duration length of backwash)
  - pump
3. Influent surge tank (one hour retention time)
4. Carbon replacement/regeneration facilities\* for:
  - replacement (for carbon usage rates less than 1.6 lbs/hr)
  - off-site regeneration (for carbon usage rates between 1.6 and 53 lbs/hr) or
  - on-site regeneration (for carbon usage rates above 53 lbs/hr)

The capital and O&M cost equations for activated carbon adsorption systems include the costs of all four components listed above. As presented in Table IX-1, separate sets of equations were developed for different flow ranges and carbon exhaustion

---

\*The carbon replacement/regeneration method depends on the carbon usage rate.

rates as a function of influent flow rate. Both the carbon exhaustion rate and the influent flow rate to the activated carbon unit are dependent on whether process waters are recycled. For processes in the questionnaire data base for this regulation that recycled 90 percent or more of the process water, the influent to the activated carbon adsorption unit was assumed to be the discharge (at 90 percent recycle) from the recycle unit. For processes with reported recycle percentages of less than 90 percent, the influent to activated carbon adsorption was assumed to be the process water usage flow (i.e., once-through process data).

The carbon exhaustion rate is dependent on the influent and effluent pollutant concentrations of the process water. Recycled process waters should have higher pollutant concentrations than process waters that are not recycled. Specifically, process water recycled at 90 percent was assumed to have concentrations 10 times higher than non-recycled process waters. Based on this assumption, the following influent concentrations and carbon exhaustion rates were used to size the activated carbon unit:

<u>Pollutant</u>	Process Water Concentration/Carbon Exhaustion Rate			
	<u>Contact Cooling and Heating Water</u>		<u>Finishing Water</u>	
	<u>Non-Recycled</u>	<u>Recycled†</u>	<u>Non-Recycled</u>	<u>Recycled†</u>
Bis(2-ethylhexyl) phthalate (mg/l)	0.235*	2.35	0.479	4.79
Di-n-butyl phthalate (mg/l)	**	**	0.031	0.31
Dimethyl phthalate (mg/l)	**	**	0.034	0.34
<hr/> Carbon Exhaustion Rate (lb/1,000 gal)	0.374	3.90	0.82	8.6

† Based on 90 percent recycle.

\* Only field sampling concentration data above the treatability level of 0.01 mg/l were used in calculating the flow-weighted pollutant average concentration in the influent to activated carbon adsorption.

\*\* Not found above treatable concentrations in this process water.

The carbon exhaustion rates were based on published isotherm data (Reference: Carbon Adsorption Isotherms for Toxic Organics, EPA 600/8-80-023, April 1980) and an excess capacity factor of 100 percent.

Capital and O&M costs for activated carbon adsorption were based on achieving the following theoretical treatability limits:

<u>Pollutant</u>	<u>Theoretical Treatability Limit (mg/l) for Activated Carbon Adsorption</u>
Bis(2-ethylhexyl) phthalate	0.010
Di-n-butyl phthalate	0.025
Dimethyl phthalate	0.025

---

Source: Treatability of Organic Priority Pollutants - Part C - Their Estimated (30-Day Ave.) Treated Effluent Concentration - A Molecular Engineering Approach, U.S. EPA (internal report).

Capital costs of activated carbon adsorption units include costs based on vendor quotations for pre-assembled steel adsorption columns having a constant height of 25 feet. The diameter is based on a constant hydraulic loading of 2.5 gpm/ft<sup>2</sup>. If the calculated column diameter is greater than the maximum allowable diameter (9 feet), multiple column trains are designed. If the predicted diameter is less than the allowable minimum diameter (2 feet), the minimum diameter is used. O&M costs for the carbon columns specifically include costs of energy for supply and backwash pumping, operating labor costs for monitoring column performance, and routine maintenance (e.g., changing pump seals, etc.). Costs for the initial activated carbon charge are based on the cost of Calgon FILTRASORB 300 and are a function of the amount of carbon purchased. Typical activated carbon costs range from \$0.63 to \$0.97 (March 1982) per pound.

The capital and O&M costs for the surge and backwash tanks and transfer pumps are based on the corresponding cost equations previously described in the flow equalization discussion, except that O&M tank costs are only two percent of the capital cost because solids removal is not necessary.

Selection of the carbon replacement or regeneration method depends on the carbon usage rate (lbs carbon exhausted/hr), which is a function of the influent flow rate and the carbon exhaustion rate. One of three operating schemes was chosen for each plant. Below a carbon usage rate of 1.6 lbs/hr, replacement of spent

carbon with new carbon and contract haul of the spent carbon was most economical. Between 1.6 and 53 lbs/hr, regeneration by off-site regeneration was more economical. On-site regeneration facilities were more economical when the carbon usage rate was above 53 lbs/hr.

For carbon replacement, no capital investment was required. Direct annual costs consist of contract hauling the spent carbon as a hazardous waste and the purchase and installation of new carbon.

For the off-site regeneration option, direct capital costs include costs for hoppers for dewatering and storage of spent carbon. The minimum amount of carbon that can be economically regenerated off-site is 20,000 lbs. In cases where the actual inventory is less than 20,000 lbs, capital costs for purchasing additional carbon to reach the minimum level are included. O&M costs include the charge for regeneration, transportation of the carbon to and from the regeneration facility, and cost for placing carbon into the column.

For an on-site regeneration facility, direct capital costs include costs for a multiple hearth furnace and associated equipment, spent carbon storage, exhaust gas scrubbers, a carbon slurry system, quench tank, housing, and controls and instrumentation. Direct annual costs include operation and maintenance labor for the regeneration facility, maintenance materials, and electricity and natural gas costs for the building, electrical equipment, and furnace. Also included is the cost of replacing carbon lost in the regeneration process (10 percent of the spent carbon passing through the furnace) with virgin carbon.

#### Vacuum Filters

For the PM&F regulation, sludge from a settling unit and waste activated sludge is dewatered in a vacuum filter to reduce the amount of sludge that requires disposal. Vacuum filters can dewater sludge to a cake with 20 percent solids. Dewatered sludge is disposed of by contract haul and the filtrate is recycled to the treatment process.

The capacity of the vacuum filter, expressed as square feet of filtration area, is based on a yield of 14.6 kg of dry solids/hr per square meter of filter area (3 lbs/hr/ft<sup>2</sup>), a solids capture of 95 percent and an excess capacity of 30 percent. The filter operates eight hours per operating day.

Cost data were compiled for vacuum filters ranging in size from 0.9 to 69.7 m<sup>2</sup> (9.4 to 750 ft<sup>2</sup>) of filter surface area. Based on the results of a total annualized cost comparison,

contract haul of the sludge is more economical when the sludge flow rate is 50 l/hr (0.23 gpm) or less. Therefore, when the sludge flow rate is 50 l/hr or less, costs were estimated to contract haul all of the sludge.

Costs for the vacuum filtration unit include costs for the following equipment:

1. Vacuum filter with precoat but no sludge conditioning
2. Housing
3. Influent transfer pump
4. Slurry holding tank
5. Sludge pumps

The vacuum filter is sized based on eight hours of operation per day. The slurry holding tank and pump are excluded when the treatment technology operates eight hours per day or less. In this case, the underflow from the settling unit directly enters the vacuum filter. For cases where the treatment technology is operated for more than eight hours per day, the underflow is stored during vacuum filter non-operating hours. The filter is sized accordingly to filter the stored slurry in an eight hour period each day. The holding tank capacity is based on the difference between the plant and vacuum filter operating hours plus an excess capacity of 20 percent. Cost equations for capital and O&M costs of vacuum filters and a vacuum filter building are presented in Table IX-1.

The following assumptions were made in developing vacuum filter capital and O&M costs:

1. O&M costs associated with the vacuum filter were developed based on continuous operation (24 hrs/day, 365 days/yr). These costs were adjusted for a plant's individual operating schedule by assuming that O&M costs are proportional to the hours the vacuum filter actually operates. Thus, O&M costs were adjusted by the ratio of actual vacuum filter operating hours per year (8 hrs/day x number days/yr) to the number of hours in a year (8,760 hrs/yr).
2. O&M vacuum filter costs include operating and maintenance labor (ranging from 200 to 3,000 hrs/yr as a function of filter size), maintenance materials (generally less than five percent of capital cost), and energy (mainly for the vacuum pumps).
3. Costs for facilities to house a vacuum filter were based on rates of \$45/ft<sup>2</sup> and \$5/ft<sup>2</sup>/yr for capital and O&M costs, respectively. These rates were applied to

the estimated floor area required by the vacuum filter system to obtain the costs of the facilities that house the vacuum filter. The O&M cost rate accounts for electrical energy requirements of the filter housing. Floor area for the housing is based on equipment dimensions reported in vendor literature, ranging from 300 ft<sup>2</sup> for the minimum size filters (9.4 ft<sup>2</sup>) to 1,400 ft<sup>2</sup> for a vacuum filter capacity of 1,320 ft<sup>2</sup>.

### Contract Haul

Concentrated sludge and certain process waters are removed on a contract basis for off-site disposal. The cost of contract haul depends on the classification of the waste as being either hazardous or nonhazardous. For nonhazardous wastes, a rate of \$0.106/liter (\$0.40/ gallon) was used to estimate contract hauling costs. The cost for contract hauling hazardous wastes (i.e., spent activated carbon) was developed from a survey of waste disposal services and varies with the amount of waste hauled (e.g., \$0.97/gal for disposal at 1 gal/hr of sludge to \$0.76/gal for disposal at 100 gal/hr of sludge). No capital costs are associated with contract hauling. The minimum monthly charge for removal is \$75.00, based on information from nonhazardous sludge haulers.

### PROCESS-BY-PROCESS COST ESTIMATES

Prior to estimating treatment costs for each process in the data base for this regulation, the treatment technologies discussed in Section VIII were used to develop model treatment technology options for the various types of effluent limitations guidelines and standards. These model treatment technology options are discussed in more detail in Sections X, XI, and XII.

For the model treatment technology options considered by the Agency, each type of process water (i.e., each subcategory) requires a different treatment option.\* Thus, the Agency assumed that process waters in different subcategories would not be combined for treatment. For this reason, capital and O&M costs for each type of process water were estimated separately (i.e., based on segregated treatment of each process water type), as discussed below.

---

\* Except for the contact cooling and heating category water and finishing water subcategory, both of which had activated carbon adsorption as the model treatment technology at BAT. However, no plant for which process water treatment costs were estimated had process waters in both of these subcategories.

First, for each of the 112 direct discharging plants in the questionnaire survey data base for which treatment costs were estimated, process waters were segregated by subcategory. Next, for the questionnaire survey plants that had more than one process water in a particular subcategory, the flows for these process waters were combined to obtain subcategory flows for each plant. Thus, it was assumed that process waters would be combined if they required the same treatment. Third, costs of the model treatment technology options were estimated for each subcategory to obtain capital and O&M costs for each of the 112 questionnaire survey plants. These process-by-process cost estimates, which are included in the public record for this regulation, were then used in the economic impact analysis to develop total capital and total annual cost estimates on a plant-by-plant basis. These cost estimates are in the Economic Impact Analysis of Effluent Limitation Guidelines and Standards for the Plastics Molding and Forming Industry, EPA 440/2-84-025, December 1984. A more detailed discussion of this process-by-process cost methodology for a plant is presented below.

### Plant-Specific Treatment Technologies

The first step in the development of process-by-process cost estimates was to select the appropriate treatment technologies for a particular plant. This selection is simply based on the particular processes at a plant. For example, if a plant discharges cleaning water and finishing water, costs at BPT for this plant were estimated for the model treatment technology options at BPT for these process waters.

### Process Water Characteristics

After establishing the model treatment technology for a given plant, the next step was to define the influent process water characteristics (i.e., flow and pollutant concentrations).

Because the cost equations shown in Table IX-1 are primarily dependent on flow, either directly or indirectly, the influent flow is required as an input parameter. The plant-specific flows for each process water were derived from the questionnaire surveys. For plants practicing recycle of process water, the discharge flow was used as the influent flow to end-of-pipe treatment (see discussion on activated carbon adsorption in this section for exceptions).

Costs for certain treatment technologies are affected by influent concentrations. For example, the carbon exhaustion rate is dependent on the amount of adsorbable organics removed from the influent. Influent concentration dictates how long it takes for carbon to be exhausted. These influent concentrations are also



required for the calculation of pollutant removals. In general, the influent concentrations used as input to cost estimation are the flow-weighted average values calculated for each subcategory and presented in Section VI. The exception is explained in the description of the activated carbon adsorption process.

### Cost Calculations

Once the model treatment technology option and process water characteristics were defined for each plant in the data base, appropriate cost equations were used to estimate capital and O&M costs of the technology. The capital and O&M cost equations are presented in Table IX-1.

### Consideration of Existing Treatment

Cost estimates for the model treatment technology options are for "greenfield" plants and do not account for equipment that plants may already have in-place. To estimate the cost incurred by a plant to meet the effluent limitations guidelines, "credit" should be given for treatment in-place at that plant. The actual capital costs of a model treatment technology option were obtained by subtracting capital costs of treatment in-place (as calculated by the cost equations) from the total "greenfield" costs. O&M costs associated with treatment in-place were not subtracted, however, because these costs recur and must be borne by the facility each year.

### COST ESTIMATION EXAMPLE

An example illustrating the cost estimation procedures for a single plant is presented here. Capital and O&M costs at BPT are estimated using the specific cost estimation steps previously described.

Plant Y in the PM&F category is a direct discharger at which injection molding, dip coating, plastic product cleaning, and grinding operations are performed. Both cleaning water and finishing water are discharged from the plant. Therefore, the plant has processes in both the cleaning water subcategory and the finishing water subcategory. The plant also has processes in the contact cooling and heating water subcategory (i.e., injection molding and dip coating), but these processes do not use process water.

Costs for Plant Y at BPT were estimated using the following procedure:

1. Define the treatment technology.

The only model treatment technology option considered at BPT for the cleaning water subcategory consists of equalization and pH adjustment followed by a package activated sludge plant; for the finishing water subcategory, only settling was considered. Thus, costs for Plant Y are estimated based on the model treatment technologies shown in Figure IX-1.

2. Define the process water characteristics.

Cleaning water influent characteristics:

Flow = 170 l/hr (0.75 gpm)  
pH = 5  
BOD<sub>5</sub> = 89 mg/l  
TSS = 714 mg/l  
O&G = 48 mg/l

Finishing water influent characteristics:

Flow = 522 l/hr (2.3 gpm)  
TSS = 95 mg/l

Plant operating hours = 5,914 hrs/yr

3. Cost calculation.

The specified model treatment technology and raw waste data were used as the basis of the cost calculations. Results of the design and cost calculations are presented below.

Design Data

Finishing water (settling):

Settling tank volume = 1,324 gal  
Contract haul volume (sludge) = 3,125 gal/yr

Cleaning water (equalization, pH adjustment, and package activated sludge plant):

Equalization tank volume = 432 gal  
Equalization agitator size = 0.015 hp  
Activated sludge treatment capacity = 864 gal/day

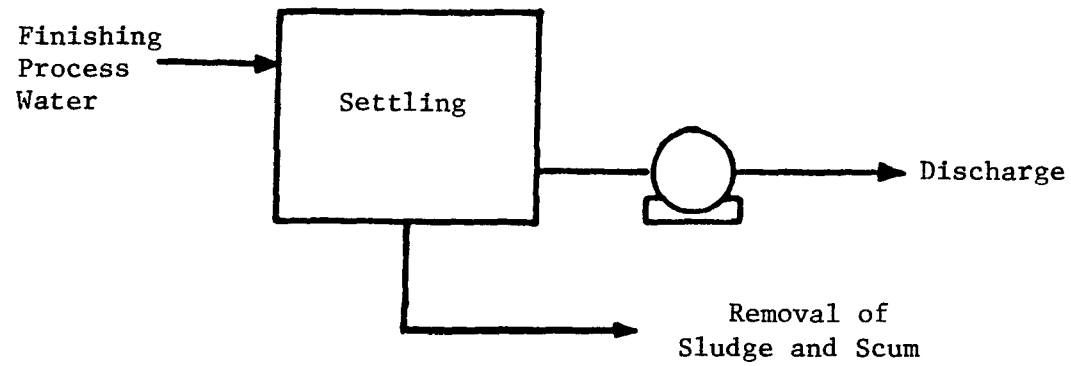
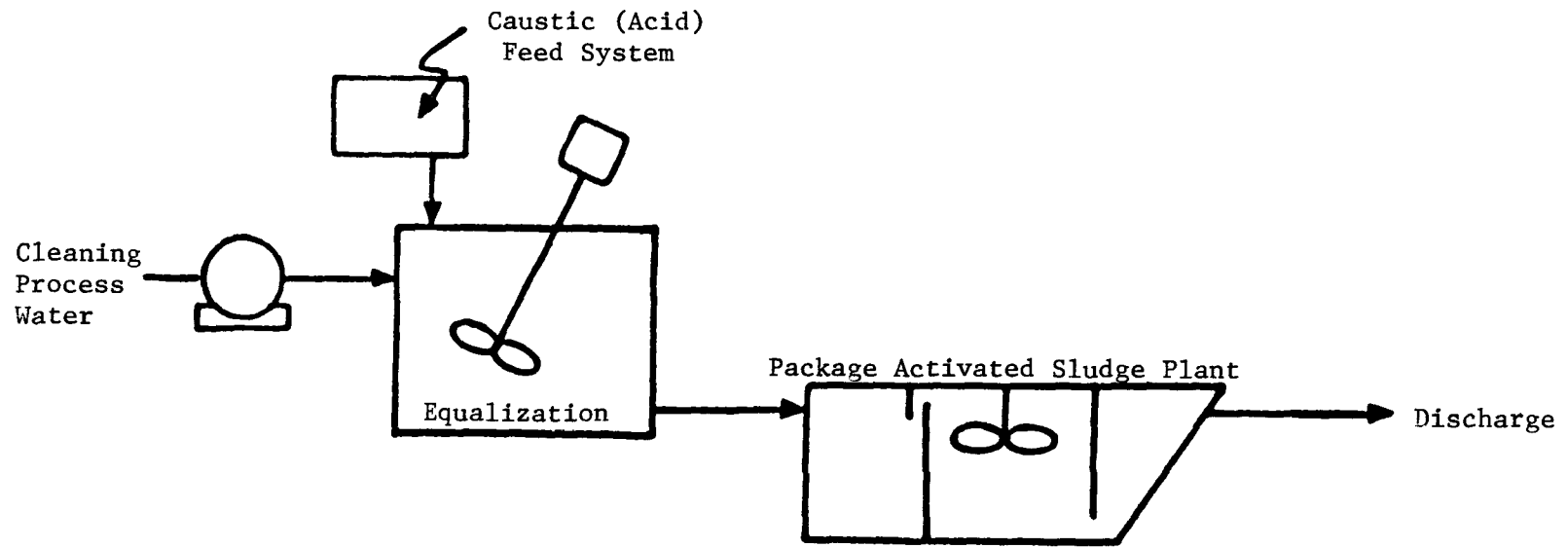

267

Figure IX-1

COST ESTIMATE EXAMPLE  
 MODEL TREATMENT TECHNOLOGIES FOR PLANT Y AT BPT

Nutrient Addition:

Phosphoric acid application rate = 0.0012 lbs/hr

Ammonium chloride application rate = 0.0128  
lbs/hr

Lime application rate = 0.0011 lbs/hr

Contract haul volume (sludge) = 9,830 gal/yr

The estimated costs of these model treatment technologies are presented in Table IX-2.

4. Consideration of treatment in place.

This step reduces the estimated costs to account for treatment facilities existing at Plant Y. Based on the questionnaire survey response, Plant Y has no treatment in-place. Therefore, the "greenfield costs" shown in Table IX-2 represent the actual estimated costs for Plant Y at BPT.

ESTIMATION OF ENERGY AND NON-WATER QUALITY IMPACTS

The remainder of this section discusses the methodologies used to estimate the energy and non-water quality environmental impacts associated with the regulation. The estimated energy requirements, solid wastes generation, air pollution emissions, and consumptive water losses based on the following methodologies are presented in Sections X through XIII.

Energy

The increases in electrical energy consumption attributable to application of the final PM&F effluent limitations guidelines and standards were estimated to assess the impact of the final PM&F regulation with regard to energy consumption. The estimated electrical energy consumption by the PM&F category (expressed as kw-hr/year) for the selected model treatment technology options is presented in Sections X, XI, XII, and XIII for BPT, BAT, NSPS, and PSES/PSNS, respectively. This part discusses the assumptions and steps used to derive the energy consumption estimates.

Estimation of the net increase in electrical energy consumption at BPT and BAT was accomplished as follows:

1. Energy costs for the treatment technologies were estimated using energy factors. These factors represent the percent of the annual O&M costs attributable to energy for each technology. The energy costs (\$/year) were converted to energy requirements (kilowatt-hours/year) using the electricity charge rate of \$0.049/kilowatt-hour.

Table IX-2

## ESTIMATED CAPITAL AND O&amp;M COSTS FOR PLANT Y AT BPT

<u>Equipment Costs</u>	<u>Estimated Costs (\$, 3/82)</u>	
	<u>Capital</u>	<u>O&amp;M (1)</u>
Settling	\$ 5,390	\$ 1,120
Equalization	1,980	1,980
Chemical Addition	16,500	4,400
Package Activated Sludge Plant	4,380	4,670
Contract Haul (Sludge)		
Cleaning Water	0	3,700
Finishing Water	<u>0</u>	<u>1,270</u>
Subtotal (Equipment Costs)	\$28,250	\$17,140
 <u>System Costs</u>		
Engineering, Administrative, and Legal	2,825	-
Contingency	4,661	-
Contractor's Fee	<u>3,108</u>	<u>-</u>
Subtotal (System Costs)	10,594	-
Total Costs	\$38,844	\$17,140

---

(1) O&M costs do not include monitoring costs.

2. Energy requirements for plants in each subcategory were estimated by applying the energy factors to the corresponding treatment technology O&M costs. This was done for each of the 112 direct discharging plants in the questionnaire survey for which costs were estimated. Estimated energy requirements for these plants were then totaled by subcategory.
3. The total energy requirement for each PM&F subcategory was estimated by scaling up the subcategory values obtained in the previous step. The scale-up was based on multiplying the subcategory value by the ratio of the estimated total number of wet PM&F plants to the number of wet plants in the PM&F questionnaire survey.
4. The energy usage for the PM&F category was estimated by adding the projected subcategory energy requirements obtained in the previous step.

At BPT, the estimated total energy requirement determined in the last step represents the total energy usage by PM&F plants attributable to the BPT effluent limitations guidelines. The significance of the energy usage attributable to the PM&F regulation is assessed by comparing it to the total current energy usage for the PM&F category, which is estimated to be  $1 \times 10^{11}$  kw-hr/yr. The total energy usage was projected from energy usage information supplied by plants in the questionnaire survey data base.

#### Air Pollution

The Agency does not expect the treatment of PM&F process waters using the technologies considered as the basis for this final PM&F regulation to create an air pollution problem. Some volatile organic compounds may be emitted to the air from the biological treatment technologies. However, those emissions are not expected to be significant. Accordingly, air pollution emissions attributable to the PM&F regulation were not estimated.

#### Solid Waste

The increase in solid wastes generated from application of the final effluent limitations guidelines and standards were estimated to assess the potential solid waste disposal impact of the final PM&F regulation. The estimated amounts of solid wastes (expressed as metric tons per year) generated by the PM&F category for the selected model treatment technologies are presented in Sections X, XI, XII, and XIII, for BPT, BAT, NSPS, and PSES/PSNS, respectively. This section discusses the assumptions and steps used to derive the solid wastes generation estimates.

Solid wastes generated by the control and treatment technologies considered for the PM&F category include settled solids from sedimentation processes, treatment process sludges containing biological solids and skimmed oil, and residues from periodic cleaning of tanks and other equipment that may accumulate solids. The annual sludge generation rates resulting from treatment of PM&F process waters were estimated by material balances performed around each unit treatment process. These material balances were based on the average influent pollutant levels and design assumptions for the treatment technologies discussed previously in this section. These sludge generation rates provided the basis for estimating the total amount of solid wastes generated by the PM&F category due to the final PM&F regulation:

1. Solid waste generation rates (liters/year) for treatment of each type of PM&F process water were determined for each of the 112 direct discharging plants included in the questionnaire survey data base that have no treatment in-place.\* These generation rates, expressed in liters/year, were converted to metric tons/year by assuming that the solid waste has the density of water. Estimated solid waste generation rates for these plants were totaled by subcategory.
2. The total solid waste generation rates for the PM&F subcategory were estimated by scaling up the subcategory values obtained in the previous step. The scale-up was based on multiplying the subcategory values by the ratio of the estimated total number of wet PM&F plants to the number of wet plants in the PM&F questionnaire survey data base.
3. The solid waste generation rate for the PM&F category was estimated by adding the projected subcategory solid waste generation rates obtained in the previous step.

Characterization of PM&F Solid Wastes. Based on the analyses of process water solid wastes generated during treatment of PM&F process waters, the Agency believes that PM&F process water treatment residuals are not hazardous under Section 3001 of the Resource Conservation and Recovery Act (RCRA). Four solid waste samples were collected at three PM&F plants. The descriptions of

---

\* Only questionnaire survey plants with no treatment-in-place were included to estimate the additional amount of solid waste generated from implementation of the selected model treatment technologies (i.e., the net increase from the current level of solid waste generation attributable to this regulation).

these samples, including the PM&F subcategory, materials processed, wastewater treatment practices, and physical descriptions of the samples are presented in Table IX-3. These samples were tested for hazardous characteristics based on the extraction procedure (EP) toxicity test (see test method 1310, Test Methods for Evaluating Solid Wastes, SW-846†). This test method is designed to simulate potential leaching of toxic pollutants from the solid waste. Pollutants in solid waste samples analyzed were present in concentrations below the allowable concentration of those pollutants specified in the EP toxicity test procedures. As can be seen by the results, presented in Table IX-4, the pollutant concentrations in all extract samples were well below the pollutant concentrations considered hazardous.

In addition to passing the EP toxicity test, none of the solid wastes are specifically listed as hazardous, pursuant to 40 CFR Part 261.11 (45 FR 33121; May 1980, as amended by 45 FR 76624; November 19, 1980), nor are they likely to exhibit only hazardous waste characteristics (e.g., reactivity, ignitability).

Also, the Agency expects the solid wastes generated by the selected model treatment technologies to exhibit similar nonhazardous characteristics as these sampled wastes. Thus, the Agency believes that the solid wastes generated as a result of these guidelines will not be hazardous. Because the PM&F solid wastes are not believed to be hazardous, no estimates for treatment, storage, or disposal of the solid wastes in accordance with RCRA hazardous waste requirements were made.

Although it is the Agency's view that solid wastes generated as a result of the final PM&F regulation are not expected to be classified as hazardous under the regulations implementing Subtitle C of the Resource Conservation and Recovery Act (RCRA), generators of these wastes must test the waste to determine if they meet any of the characteristics of hazardous waste. See 40 CFR Part 262.11 (45 FR 12732-12733; February 26, 1980). The Agency may also list these sludges as hazardous pursuant to 40 CFR Part 261 (45 FR at 33121; May 19, 1980, as amended at 45 FR 76624; November 19, 1980).

If these wastes are identified as hazardous, they will come within the scope of RCRA's "cradle to grave" hazardous waste management program, requiring regulation from the point of generation to point of final disposition. EPA's generator standards require generators of hazardous wastes to meet containerization, labeling, record keeping, and reporting requirements; if plastics molders or formers dispose of hazardous wastes off-site, they

---

†See also 40 CFR 261.24 (45 FR 33084; May 19, 1980).



Table IX-3

## DESCRIPTION OF PM&amp;F TREATMENT SYSTEM SOLID WASTE SAMPLES

<u>Plant</u>	<u>Process Code</u>	<u>PM&amp;F Subcategory</u>	<u>Materials Processed</u>	<u>Wastewater Treatment</u>	<u>Solid Sample Description</u>
480*	L-5	finishing water	polyester, rubber	recycle with a DAF clarifier, and belt filtration (dewatering) of solids	dewatered solids sample
10290	N-5	finishing water	polyurethane	filtration	filter cake sample
273 3625445	R-3	contact cooling and heating water	polyvinyl chloride, polypropylene, polyethylene	recycle with solids skim- ming, filtra- tion, and water cooling	skimmed solids sample
3625445	R-4	contact cooling and heating water	polyvinyl chloride, polypropylene, polyethylene	recycle with solids skim- ming, filtra- tion, and water cooling	filter cake sample

---

\*Plant 480 is not included in the PM&F sampling data base (presented in Section VI), because rubber is also processed at the plant.

Table IX-4

## EP TOXICITY TEST RESULTS FOR PM&amp;F WASTEWATER TREATMENT SOLID WASTES

Pollutant	Hazardous Concentrations (ug/l)*	PM&F Solid Waste Concentration by Process Code (ug/l)			
		L-5	N-5	R-3	R-4
<u>Metals (ICAPES)</u>					
silver	5,000	<0.002	0.004	<0.002	<0.002
barium	100,000	0.22	0.96	0.16	0.57
cadmium	1,000	<0.002	<0.002	<0.002	0.27
chromium	5,000	<0.001	<0.001	<0.001	0.094
<u>Metals (AA)</u>					
arsenic	5,000	<0.002	<0.003	<0.002	<0.002
mercury	200	<0.002	<0.0002	<0.0002	<0.0002
lead	5,000	0.008	<0.002	<0.002	<0.002
selenium	1,000	<0.002	<0.003	<0.002	<0.002
<u>Herbicides</u>					
2,4-D	10,000	<0.1	<0.1	<0.15	<0.1
2,4,5-TP (silvex)	1,000	**	<0.01	<0.01	<0.1
<u>Pesticides</u>					
lindane	400	<0.1	<0.1	<4	<4
endrin	20	<0.1	<0.1	<0.2	<0.2
methoxychlor	10,000	<1	<1	<100	<100
toxaphene	500	<1	<1	<5	<5

274

\*These concentrations are listed in CFR Title 40, Part 261.

\*\*Presence of large interference peak precludes detection.

would have to prepare a manifest that tracks the movement of the wastes from the generator's premises to an appropriate off-site treatment, storage, or disposal facility. See 40 CFR Part 262.20 (45 FR 33142; May 19, 1980, as amended at 45 FR 86973; December 31, 1980). The transporter regulations require transporters of hazardous wastes to comply with the manifest system to ensure that the wastes are delivered to a permitted facility. See 40 CFR Part 263.20 (45 FR 33142; May 19, 1980, as amended at 45 FR 86973; December 31, 1980). Finally, RCRA regulations establish standards for hazardous waste treatment, storage, and disposal facilities allowed to receive such wastes. See 40 CFR Part 264 (46 FR 2802; January 12, 1981, 45 FR 32274; July 26, 1982).

Even if these wastes are not identified as hazardous, they still must be disposed in a manner that will not violate the open dumping prohibition of §4005 of RCRA. The Agency has calculated as part of the costs for wastewater treatment the cost of hauling and disposing of these wastes in accordance with this requirement.

#### Consumptive Water Loss

Where evaporative cooling mechanisms are used for recycling water, water loss may result and contribute to water scarcity problems - a primary concern in arid and semi-arid regions. Because recycle of PM&F process waters is not a treatment and control technology used in development of the PM&F regulation, consumptive water loss associated with the regulation does not represent a potential environmental impact. Therefore, consumptive water losses were not estimated.



## SECTION X

### BEST PRACTICABLE CONTROL TECHNOLOGY CURRENTLY AVAILABLE

#### BACKGROUND

This section defines the effluent characteristics attainable through the application of best practicable control technology currently available (BPT), as required by Section 301(b)(1)(A) of the Act. Effluent limitations guidelines for the PM&F category based on BPT reflect either the existing treatment performance by plants of various sizes, ages, and manufacturing processes within the plastics molding and forming category or the performance of a treatment technology transferred from the organic chemicals, plastics, and synthetic fibers category.

The factors considered in identifying BPT include the total cost of applying the technology in relation to the effluent reduction benefits derived, the age of equipment and facilities involved, the manufacturing processes employed, energy, non-water quality environmental impacts, and other factors EPA considers appropriate. In general, the BPT level represents the average of the best existing performance of plants of various ages, sizes, processes, or other common characteristics. Where existing performance is uniformly inadequate, BPT may be transferred from a different subcategory or category. Limitations based on transfer of a technology have to be supported by a conclusion that the technology will be capable of achieving the prescribed effluent limitations guidelines (see Tanners' Council of America v. Train, 540 F.2d 1188 (4th Cir. 1976)). BPT focuses on end-of-pipe treatment rather than process changes or internal controls, except where such practices are common to the industry.

The cost-benefit inquiry for BPT is a limited balancing, committed to EPA's discretion, that does not require the Agency to quantify benefits in monetary terms. See American Iron and Steel Institute v. EPA, 526 F.2d 1027 (3rd Cir. 1975). In balancing costs in relation to effluent reduction benefits, EPA considers the volume and nature of existing discharges, the volume and nature of discharges expected after application of BPT, the general environmental effects of the pollutants, and the cost and economic impacts of the required level of pollution control. The Act does not require or permit consideration of water quality problems attributable to particular point sources or industries, or water quality improvements in particular water bodies. Accordingly, water quality considerations were not the basis for the final BPT effluent limitations guidelines for the PM&F category. See Weyerhaeuser Company v. Costle, 590 F.2d 1011 (D.C. Cir. 1978).

## TECHNICAL APPROACH

The plastics molding and forming category was studied to identify the manufacturing processes used and to determine the characteristics of PM&F process waters. Results of that study were used to subcategorize the PM&F category, to determine the appropriate type of effluent limitations guidelines for the PM&F category, and to select model BPT treatment technologies.

Subcategorization. The factors reviewed to determine the subcategorization scheme for this category are:

1. Raw materials,
2. Production processes,
3. Products,
4. Size and age of plants,
5. Wastewater characteristics,
6. Water use, and
7. Geographic location of plants.

At proposal, the PM&F category was divided into two subcategories: (1) contact cooling and heating water subcategory and (2) cleaning and finishing water subcategory. In response to comments, the Agency collected additional sampling data for finishing waters subsequent to proposal. Using those data and data from previous sampling episodes, EPA determined that cleaning waters and finishing waters have different pollutant characteristics. Cleaning waters have treatable concentrations of BOD<sub>5</sub>, O&G, TSS, COD, TOC, total phenols, phenol, and zinc, whereas finishing waters only have treatable concentrations of TSS and three phthalates. Because of these different characteristics, cleaning water processes and finishing water processes were placed in separate subcategories for the final rule.

For the purpose of the final regulation, the PM&F category is divided into three subcategories: (1) contact cooling and heating water subcategory, (2) cleaning water subcategory, and (3) finishing water subcategory. Additional information on this subcategorization scheme is presented in Section V of this document.

In making technical assessments of data, reviewing manufacturing processes, and assessing treatment technology options, both indirect and direct dischargers were considered as a single group for each subcategory. An examination of PM&F plants and processes did not indicate any process differences based on the type of discharge, whether it be direct or indirect. Therefore, data from both direct and indirect dischargers were used to make technical assessments for BPT for each subcategory.

Type of Effluent Limitations Guidelines and Standards. The Agency proposed production-based effluent limitations guidelines and standards for the PM&F category. They were calculated by multiplying the effluent pollutant concentration by a regulatory production-normalized flow (i.e., liters discharged per 1,000 kilograms of plastic product produced). After further study and evaluation, the Agency has determined that production-based effluent limitations guidelines and standards are not appropriate for the PM&F category. EPA could not establish production normalized flows for each subcategory primarily because of the wide variation in water use by PM&F processes. This variation is caused by the many different types of materials processed and by product quality requirements. The amount of water required depends on the type of material processed and the desired product quality. In some cases, many different materials are processed in the same process at the same plant thus making the establishment of a regulatory production normalized flow infeasible. This is particularly true for "custom" plastics molders and formers.

EPA considered subdividing the PM&F category based on either the plastic material processed or on product quality to account for the variability in water use caused by the different plastic materials thus allowing the establishment of subcategory production normalized flows. However, such a subcategorization scheme would be extremely complex because of the large number of plastic materials and the combination of plastic materials that are used. Such an approach is also not feasible because of the "custom" PM&F plants discussed above.

The effluent limitations guidelines and standards in this final rule for all three subcategories are mass-based. They are calculated using the following equation:

$$\text{Effluent Mass} = (\text{Concentration}) (\text{Average Process Water Usage Flow Rate})$$

The pollutant concentrations are established based on the performance of the selected treatment technology. The average process water usage flow rate is obtained from the permittee for each process to be regulated. It is defined as the volume of process water (liters) used per year by a process divided by the number of days per year the process operates. The volume of water used is the water that flows through a process and comes in contact with the plastic product over a period of one year. Figure X-1 indicates where the average process water usage flow rate is measured.

A one year period was selected to determine the volume of water used by a process to account for any variation in water use because of seasonal operations. It also accounts for variation in the number of days that the plant operates during a year.

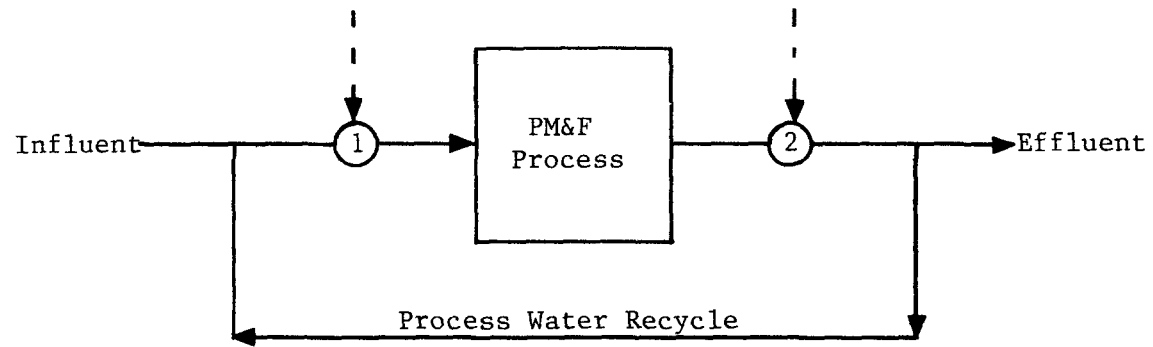

 Average process water usage flow rate is measured at either location 1 or location 2.

Figure X-1  
AVERAGE PROCESS WATER USAGE FLOW RATE



If a plant has more than one PM&F process in the same subcategory, the average process water usage flow rate for those processes is the sum of the average process water usage flow rate for each process. This sum is used to calculate the pollutant mass for the PM&F processes at a plant in the same subcategory.

Using the above equation to calculate effluent pollutant mass ensures that processes with the same average process water usage flow rate, whether water is recycled or used on a once-through basis, have the same mass limitations. If only concentration limitations were employed, processes that recycle process water may be penalized because their discharges would likely have higher concentrations than the concentrations in discharges from processes that use once-through process water.

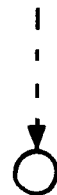
Additional Steps. Once the subcategorization scheme and the type of effluent limitations guidelines and standards were established, the following steps were taken as part of the technical study to develop final BPT effluent limitations guidelines:

1. Select pollutants that would be controlled.
2. Select a treatment technology on which to base the BPT effluent limitations guidelines.
3. Establish effluent concentration values for the controlled pollutants achievable by the selected BPT.
4. Establish maximum concentration for any one day and maximum for monthly average concentration based on the effluent concentrations achievable by the selected BPT technology.

#### BPT Model Treatment Technologies

The BPT model treatment technologies were developed from the control and treatment technologies described in Section VIII. Factors considered in developing the model BPT treatment technologies included the characteristics of PM&F process waters, PM&F process water flow rates, and treatment technologies at PM&F plants.

The BPT options for each subcategory were selected from the group of model treatment technologies described below.

Technology 1: Settling and pH Adjustment (if necessary)

Settling is effective in removing insoluble pollutants such as total suspended solids (TSS) and oil and grease (O&G). However, dissolved pollutants (e.g., BOD<sub>5</sub>) are not removed by this technology. Settling is a widely demonstrated technology used to

treat PM&F process waters. If necessary, pH adjustment is used to maintain the pH of the effluent within prescribed limits.

Technology 2: Equalization, pH Adjustment (if necessary),  
and Package Activated Sludge Plant

This treatment technology consists of flow equalization and pH adjustment (as needed) followed by treatment in a package activated sludge plant. Flow equalization provides an influent wastewater with a relatively constant flow rate and composition. If necessary, pH adjustment is included to maintain the pH of the effluent within prescribed limits. The activated sludge technology treats dissolved and biodegradable organic compounds in the process waters. In addition, insoluble pollutants such as TSS and O&G are removed in the liquid/solids separation processes in a package activated sludge plant.

Activated sludge treatment is used only at integrated facilities where PM&F process waters and other wastewaters are combined for treatment. However, the activated sludge technology is widely demonstrated in other categories for the treatment of wastewaters with characteristics similar to the characteristics of PM&F process waters. In particular, it has been demonstrated in the treatment of wastewater generated by processes in the plastics only subcategory of the organic chemicals, plastics, and synthetic fibers category.

Technology 3: Zero Discharge by Contract Haul of the Discharge  
from a Recycle Unit

Disposal of the discharge from a recycle unit by contract haul eliminates the discharge of pollutants. Two plants in the PM&F questionnaire data base currently contract haul cleaning water.

At proposal, recycle was included as part of several treatment technologies. Recycle reduces the amount of process water that has to be treated and also may improve the performance of the treatment technology because technologies usually perform better with a concentrated wastewater.

The Agency considered recycle with the technologies for the final PM&F regulation, but rejected it because of the variation in water use by PM&F processes. That variation is caused by the different types of plastic materials produced and by product quality requirements. For example, a "custom" plastics molder and former may produce a polyurethane product and a polyvinyl chloride product in the same process. Those products may have different quality requirements that influence the amount of water needed to produce each product. The amount of water that could be recycled also depends on the quality requirements of the plastic product.

As mentioned above in the discussion on production-normalized flows, EPA considered subdividing the PM&F category based on either the plastic material processed or on product quality to account for the variability in water use. This approach was rejected because of its complexity.

Because of the variation in water use by PM&F processes, the Agency was unable to establish a subcategory recycle percentage that all processes in a subcategory can meet. For this reason, recycle was rejected for the final PM&F regulation. Technology 3 was not considered further for this regulation because it was considered feasible only in conjunction with extensive recycle. The Agency does not believe it is feasible to contract haul all of the process water instead of just the discharge from the recycle unit.

### BPT OPTIONS

The BPT options were selected from the model treatment technologies described above. The applicability of a model treatment technology to a particular subcategory is based on the characteristics of process waters generated by processes in the subcategory. The rationale for selection or rejection of each BPT option is discussed below. In addition, the estimated costs, pollutant removals, energy requirements, and solid waste generation rates associated with the selected option for each subcategory are presented.

#### Contact Cooling and Heating Water Subcategory

There were no conventional pollutants found in treatable concentrations in the contact cooling and heating water subcategory (see Table VI-19). The only pollutant found in treatable concentrations in contact cooling and heating waters was bis(2-ethylhexyl) phthalate. Therefore, the Agency did not consider any of the model treatment technologies as BPT options.

At proposal, Technology 1 (settling and pH adjustment) and Technology 2 (equalization, pH adjustment, and activated sludge treatment) were considered as BPT options for this subcategory. Technology 1 was rejected for the final rule because the suspended solids concentration in the contact cooling and heating water is very low. Technology 2 was rejected for the final rule because the BOD<sub>5</sub> concentration in contact cooling and heating water is not high enough to support the activated sludge treatment process.

Contract haul was also included as part of a BPT option considered at proposal. That option included recycle to reduce the amount of process water that had to be hauled. As discussed earlier in this section, the Agency has determined that recycle is

no longer appropriate as part of the technology basis for the effluent limitations guidelines and standards for the PM&F category. EPA believes that contract haul of contact cooling and heating water is not a feasible option unless the amount of process water that has to be hauled is reduced through the use of a recycle unit. For this reason, contract haul of process water was not considered as a BPT option for the final regulation for this subcategory.

The Agency considered one BPT option as the basis for the BPT effluent limitations guidelines for this subcategory. It is:

Option 1: Good Housekeeping Practices

The Agency found during the sampling episodes for this regulation that good housekeeping practices are employed with contact cooling and heating processes. Lubricating oils and other pollutants are kept out of the contact cooling and heating water and the processes that use that type of water are usually used only to cool or heat plastic materials. For example, in an extrusion process, the molten plastic material is forced through a die and the resulting product is drawn through a water bath for rapid cooling. The water bath is used only to cool the plastic product. Consequently, the only opportunity for pollutants to get into the process water occurs when the plastic material is cooled.

In this option, the concentration values used to calculate the final BPT effluent limitations guidelines are based on a statistical evaluation of the pollutant concentrations in the raw process waters. This option ensures the continuation of the good housekeeping practices by limiting the pollutant concentrations to those that are currently being discharged.

Option Selected. The Agency is promulgating Option 1 as the model technology basis for BPT effluent limitations guidelines for the contact cooling and heating water subcategory. The final BPT effluent limitations guidelines control BOD<sub>5</sub>, O&G, TSS, and pH. Appendix D describes how the concentration values promulgated in the final regulation for this subcategory were calculated.

The concentration values in the final rule are multiplied by the average process water usage flow rate for a contact cooling and heating water process to obtain the mass of pollutants that can be discharged. The average process water usage flow rate, discussed in the previous section, is obtained from the permittee.

There are only minimal pollutant removals for the selected option and only minimal costs because this option is based on current

practices. The Agency has determined that the effluent reduction benefits associated with compliance with the BPT effluent limitations guidelines justify the costs.

The Agency has concluded that there will be only a minimal increase in production of solid wastes caused by the implementation of the BPT effluent limitations guidelines for this subcategory. There is also little or no increase in electrical energy usage.

### Cleaning Water Subcategory

The conventional pollutants found in treatable concentrations in cleaning waters are TSS, O&G, BOD<sub>5</sub>, and pH. Therefore, the Agency only considered model treatment technologies that remove these pollutants as BPT options for this subcategory.

At proposal, EPA considered BPT options based on recycle and contract haul of the discharge from the recycle unit and recycle with treatment of the discharge from the recycle unit in a package activated sludge plant. As discussed earlier, the Agency has determined that recycle is no longer an appropriate technology basis for the final effluent limitations guidelines for the PM&F category. Contract haul of cleaning waters was rejected as a BPT option for this subcategory for the same reasons it was rejected for the contact cooling and heating water subcategory.

The Agency identified two options as the basis for the final BPT effluent limitations guidelines for the cleaning water subcategory. These options are:

#### Option 1: Settling and pH Adjustment (as needed)

The technology for this option consists of a sedimentation tank in which the velocity of the process water is reduced so that solid material can settle by gravitational force. The pH of the process water is adjusted, if necessary. For the final PM&F regulation, this option was rejected early because it does not treat the dissolved pollutants (i.e., BOD<sub>5</sub>) found in treatable concentrations in cleaning waters.

#### Option 2: Equalization, pH Adjustment (as needed), and Package Activated Sludge Plant

The technology for this option consists of an equalization tank followed by a package activated sludge plant with pH adjustment (if necessary). This technology treats the BOD<sub>5</sub>, O&G, and TSS in cleaning waters (see Table VI-19). It also treats the non-conventional and priority toxic pollutants found in treatable concentrations in cleaning water. The Option 2 technology is represented in Figure X-2.

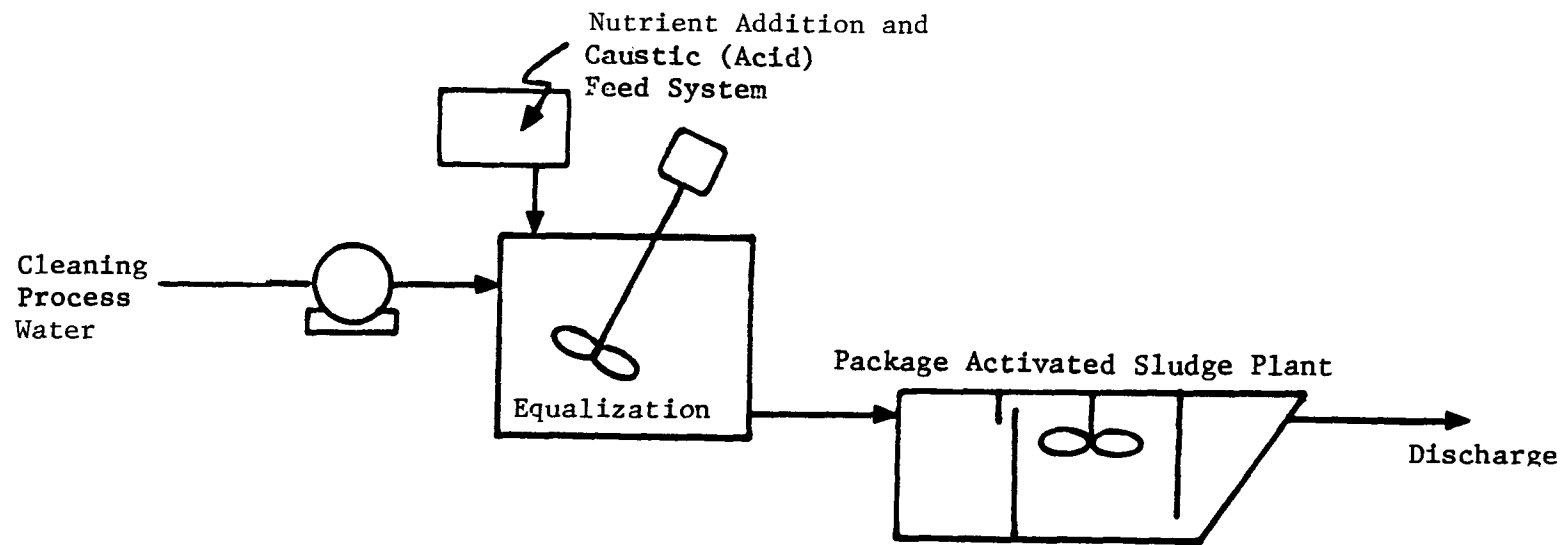

Figure X-2

SCHEMATIC OF BPT OPTION 2 - CLEANING WATER SUBCATEGORY

The estimated amounts of pollutants remaining after Option 2 are:

<u>Type of Pollutant</u>	<u>Discharged in Raw Water - Direct Dischargers (kg/yr)</u>	<u>Remaining After Option 2 (kg/yr)</u>
Conventional	238,800	21,300
Nonconventional	216,400	79,800
Priority Toxic	237	82

The methodology used to calculate the pollutant removals is presented in Appendix C.

The estimated investment cost and annual pollution control costs for Option 2 are:

	<u>Cost (\$ Million, 1984 Dollars) Option 2</u>
Investment Cost	\$6.9
Annual Pollution Control Costs*	4.4

\*Includes depreciation and interest.

Detailed information on these costs is presented in Economic Impact Analysis of Final Effluent Limitations and Standards for the Plastics Molding and Forming Industry, EPA 440/2-84-025, December 1984.

Option Selected. The Agency is promulgating Option 2 as the technology basis for the BPT effluent limitations guidelines for this subcategory.

Data available to the Agency indicate that where cleaning waters are treated by biological treatment processes, wastewaters from other manufacturing processes are commingled with the cleaning process waters. Therefore, data are not available on the application of biological treatment to cleaning waters only. As at proposal, EPA found that treatment at plants that treat cleaning waters separately is uniformly inadequate because those plants indicated on their questionnaires that they use only sedimentation and oil skimming to treat cleaning water. These technologies do not remove the dissolved pollutants in the cleaning waters. Thus, the Agency has determined that the PM&F industry has uniformly inadequate treatment of process water discharges resulting from the cleaning processes. Accordingly, the Agency has relied on the transfer of biological treatment (i.e., the activated sludge process) from the organic chemicals, plastics,

and synthetic fibers category to establish BPT effluent limitations guidelines for this subcategory. The Agency believes that such a transfer is appropriate because of the similarities between the cleaning process waters and the organic chemicals, plastics, and synthetic fibers category wastewaters.

At proposal, to evaluate the two types of wastewaters, the Agency conducted a statistical comparison of the raw wastewater conventional pollutant concentrations in PM&F process waters and the concentrations of those pollutants in raw wastewaters discharged at plants in the plastics only subcategory in the organic chemicals, plastics, and synthetic fibers category. This comparison was revised to support the final PM&F rule. After reviewing the results of the updated analysis, the Agency has concluded that the raw wastewater conventional pollutant concentrations in PM&F cleaning waters are neither significantly greater nor more variable than the raw process water conventional pollutant concentrations in wastewaters discharged by plants in the plastics only subcategory. This conclusion supports the Agency's determination that the activated sludge treatment technology can be transferred from the organic chemicals, plastics, and synthetic fibers (OCPSF) category and that the technology will treat PM&F cleaning waters to the same level that it treats OCPSF wastewaters.

Performance data for the activated sludge process were also transferred from the organic chemicals, plastics, and synthetic fibers category to the cleaning water subcategory. The transferred concentration values in the final PM&F regulation are the same as the concentration values used to calculate the production-based effluent limitations guidelines for the cleaning and finishing water subcategory at proposal. Maximum for any one day and maximum for monthly average concentrations for BOD<sub>5</sub>, O&G, and TSS are established by the final PM&F rule. The transfer of both the activated sludge process and performance data for that process are discussed in more detail in Appendix D. The Agency believes the toxic pollutants found in treatable concentrations in cleaning waters are effectively controlled when the effluent limitations guidelines for the conventional pollutants are met.

The Agency estimates that the BPT effluent limitations guidelines for this subcategory will result in the removal of 217,500 kg/yr of conventional pollutants, 136,600 kg/yr of nonconventional pollutants, and 155 kg/yr of priority toxic pollutants from the process waters. The estimated total investment costs and total annual costs for the BPT effluent limitations guidelines are \$6.9 million and \$4.4 million, respectively, in 1984 dollars. The Agency has determined that the costs are justified by the effluent reduction benefits.



The Agency estimates that the implementation of the selected BPT option for the cleaning water subcategory will result in a net increase in electrical energy consumption of 4.1 million kilowatt-hours per year (kw-hr/yr) and a net increase in the solid waste generation rate of 7,300 metric tons per year (kkg/yr). The methodologies used to derive these estimates are discussed in Section IX. The net increase in electrical energy consumption is significantly less than one percent of the estimated total current energy usage for the PM&F category. The Agency has concluded that the increased production of solid wastes (which are not believed to be hazardous) associated with the selected option for this subcategory will not cause any significant negative environmental impacts. Therefore, there are no non-water quality impacts of the BPT effluent limitations guidelines for this subcategory.

#### Finishing Water Subcategory

The only conventional pollutant found in treatable concentrations in finishing waters was TSS. Therefore, the Agency considered only model treatment technologies that remove that pollutant as BPT options in this subcategory.

For the proposed PM&F regulation, cleaning water processes and finishing water processes were in the same subcategory. Subsequent to proposal, the Agency established separate subcategories for cleaning water processes and for finishing water processes. The activated sludge process on which the proposed BPT effluent limitations guidelines for the cleaning and finishing water subcategory were based was not considered for the final BPT effluent limitations guidelines for the finishing water subcategory because the BOD<sub>5</sub> concentration (i.e., 6 mg/l) in finishing waters is not high enough to support operation of a biological process. The Agency identified one BPT option for the final regulation to treat the pollutants found in treatable concentrations in finishing waters (see Tables VII-2, VII-3, and VII-10).

#### Option 1: Settling and pH Adjustment (as needed)

The technology for this option consists of a settling tank in which the velocity of the process water is reduced so that solid material can settle by gravitational force. The pH of the process water is adjusted if necessary. This technology removes TSS. Refer to Figure X-3 for a schematic of the Option 1 technology.

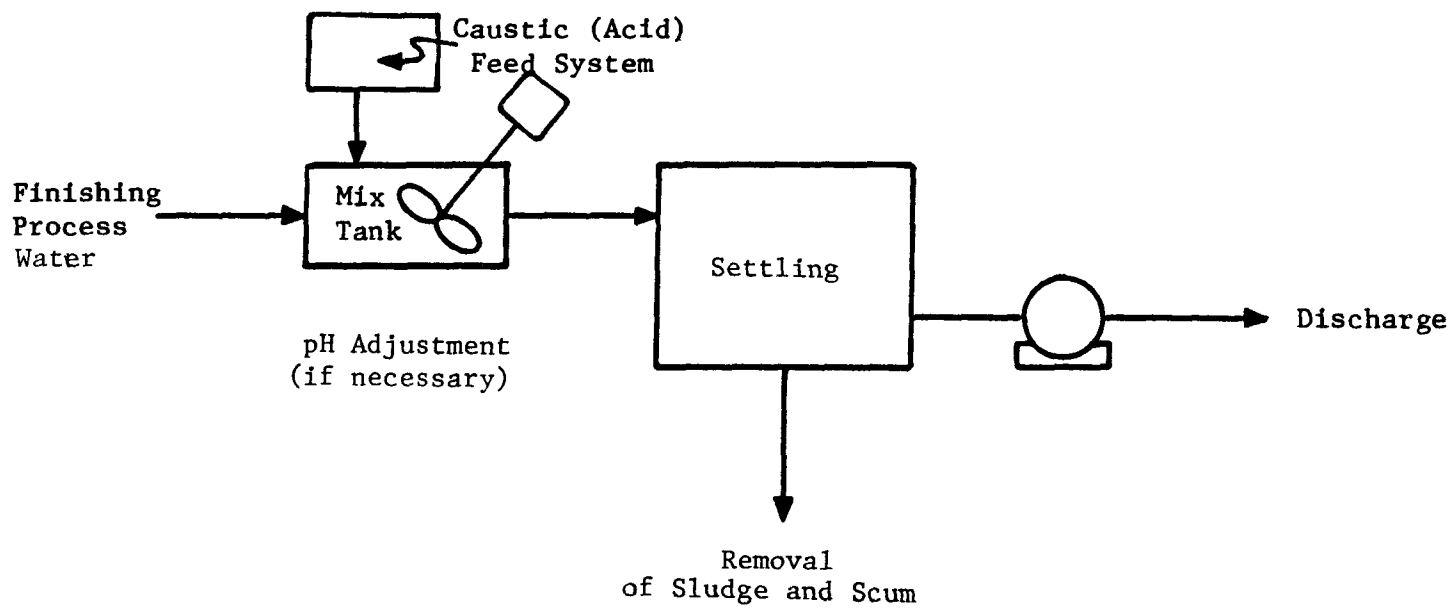

Figure X-3

SCHEMATIC OF BPT OPTION 1 - FINISHING WATER SUBCATEGORY

The estimated amounts of pollutants remaining after Option 1 are:

<u>Type of Pollutant</u>	<u>Discharged in Raw Process Water - Direct Discharger (kg/yr)</u>	<u>Remaining After Option 1 (kg/yr)</u>
Conventional	3,630	1,110
Priority Toxic	20	20

The methodology used to calculate the pollutant removals is presented in Appendix C.

The estimated investment cost and annual pollution controls for Option 1 are:

	<u>Cost (1984 Dollars) Option 1</u>
Investment Cost	\$91,000
Annual Pollution Cost*	67,500

\*Includes depreciation and interest.

Option Selected. The Agency is promulgating Option 1 as the technology basis for the BPT effluent limitations guidelines for this subcategory. This technology is demonstrated for the PM&F category. Twelve of the plants that treat PM&F process waters have a settling unit.

The Agency estimates that the BPT effluent limitations guidelines for this subcategory will result in the removal of 2,520 kg/yr of conventional pollutants from the process waters. The estimated total investment cost and total annual cost for the BPT effluent limitations guidelines are \$91,000 and \$67,500, respectively, in 1984 dollars. The Agency has determined that the costs are justified by the effluent reduction benefits.

The Agency estimates that the implementation of the selected BPT option for the finishing water subcategory will result in a net increase in electrical energy consumption of 24,000 kw-hr/yr and a solid waste generation rate of 10 metric tons per year. The methodologies used to derive these estimates are discussed in Section IX. The net increase in electrical energy consumption is significantly less than one percent of the estimated total current energy usage for the PM&F category. The Agency has concluded that the increased production of solid wastes associated with the selected option for this subcategory will not cause any significant negative environmental impacts. As discussed in Section IX of this document, EPA has determined the solid wastes

are not expected to be hazardous pursuant to RCRA. There are no non-water quality impacts of the BPT effluent limitations guidelines for this subcategory.

#### REGULATED POLLUTANTS AND POLLUTANT PROPERTIES

Pollutants and pollutant properties selected for control in the plastics molding and forming category include biochemical oxygen demand (BOD<sub>5</sub>), oil and grease (O&G), total suspended solids (TSS), and pH.

Biochemical oxygen demand was found in cleaning waters at concentrations up to 1,000 mg/l. BOD<sub>5</sub> is used to estimate the organic content of wastewater. BOD<sub>5</sub> is also an important control parameter for the activated sludge treatment process; the reduction of BOD<sub>5</sub> indicates an overall reduction of organic pollutants.

Total suspended solids was found in cleaning waters at concentrations up to 16,363 mg/l. It was found in finishing waters at concentrations up to 1,359 mg/l.

Oil and grease was detected in cleaning waters at concentrations up to 684 mg/l.

For protection of aquatic life and human welfare, pH of wastewater should be between 6.0 and 9.0. The pH of PM&F process waters is regulated because the pH of contact cooling and heating waters ranged between 5.4 and 8.3 and the pH of cleaning water ranged from 1.6 to 11.5. The pH of finishing water ranged from 6.4 to 8.4.

The Agency is establishing BPT effluent limitations guidelines for BOD<sub>5</sub>, TSS, O&G, and pH in two subcategories and for TSS and pH in the other subcategory. The Agency estimates that when these limitations are met, approximately 63 percent of the amount of treatable nonconventional pollutants discharged by PM&F processes and approximately 65 percent of the amount of treatable priority toxic pollutants discharged will be removed. These estimates are based on removal percentages reported in the literature and previous EPA studies for the nonconventional and priority toxic pollutants. The nonconventional and priority toxic pollutants in PM&F process waters are listed in Tables VII-3 and VII-10, respectively.

#### EFFLUENT CONCENTRATION VALUES

Contact Cooling and Heating Water Subcategory. For the contact cooling and heating water subcategory, the concentrations used to calculate the mass of pollutants that can be discharged are based

on a statistical evaluation of the raw waste concentrations in contact cooling and heating waters. Maximum for any one day concentrations were established for BOD<sub>5</sub>, O&G, and TSS. pH is also controlled for this subcategory. Maximum for monthly average concentrations were not established for this subcategory because there is no variability associated with the performance of a treatment technology. The maximum for any one day values are based on the concentrations currently discharged and are presented in Table X-1. A discussion of the statistical evaluation of the contact cooling and heating water raw waste concentrations is presented in Appendix D.

Cleaning Water Subcategory. A package activated sludge plant is the end-of-pipe treatment technology selected as BPT for the cleaning water subcategory. The activated sludge process and performance data for that process were transferred from the organic chemicals, plastics, and synthetic fibers (OCPSF) category because wastewater generated by processes in that category and PM&F cleaning waters have similar conventional pollutant characteristics.

The transfer of the activated sludge process was evaluated by comparing the sampling data for cleaning waters obtained during the sampling program for this regulation to process wastewater data from the organic chemicals, plastics, and synthetic fibers category, particularly the plastics only subcategory. That comparison showed that the wastewaters for the cleaning water subcategory and for the OCPSF category have similar characteristics. Specifically, data on raw waste concentrations of BOD<sub>5</sub>, TSS, and O&G were examined statistically. A detailed report on the statistical analysis is presented in Appendix D. Results of that analysis show that the concentrations for these pollutants in PM&F cleaning waters are neither significantly greater nor more variable than the concentrations of those pollutants in wastewaters generated by processes at plants that manufacture plastics. This supports the Agency's technical judgment that the activated sludge process will treat PM&F cleaning waters effectively and achieve the conventional pollutant effluent concentrations achieved by activated sludge processes that treat wastewater generated by processes at plastics manufacturing plants in the OCPSF category. The Agency's judgment that the activated sludge process will treat PM&F cleaning waters was based on the literature and knowledge of the performance of the activated sludge process.

Thus, the Agency transferred the activated sludge technology and effluent data for that technology from the OCPSF category to the PM&F cleaning water subcategory. Effluent concentration values were transferred for BOD<sub>5</sub>, TSS, and O&G. These values are presented in Table X-1.

Table X-1

EFFLUENT CONCENTRATIONS USED TO CALCULATE THE FINAL  
BPT EFFLUENT LIMITATIONS GUIDELINES

Contact Cooling and Heating Water Subcategory

<u>Pollutant</u>	<u>Maximum for Any One Day (mg/l)</u>	<u>Maximum for Monthly Average (mg/l)</u>
BOD <sub>5</sub>	26	(2)
Oil and Grease	29	(2)
TSS	19	(2)
pH	(1)	(1)

Cleaning Water Subcategory

<u>Pollutant</u>	<u>Maximum for Any One Day (mg/l)*</u>	<u>Maximum for Monthly Average (mg/l)*</u>
BOD <sub>5</sub>	49	22
Oil and Grease	71	17
TSS	117	36
pH	(1)	(1)

Finishing Water Subcategory

<u>Pollutant</u>	<u>Maximum for Any One Day (mg/l)</u>	<u>Maximum for Monthly Average (mg/l)</u>
TSS	130	37
pH	(1)	(1)

---

(1) Within the range 6.0 to 9.0 at all times.

(2) Not established for this subcategory.

\*Transferred from the OCPSF category.

Finishing Water Subcategory. The effluent concentrations for TSS for the finishing water subcategory were obtained by multiplying the subcategory average TSS concentration by a percent removal to obtain a long-term average concentration. Variability factors were then applied to the long-term average to obtain the maximum for any one day and maximum for monthly average concentration values. Calculation of both the variability factors and the concentration values is discussed in more detail in Appendix D. The TSS concentrations used to calculate the final BPT effluent limitations guidelines for the finishing water subcategory are presented in Table X-1.

#### BPT EFFLUENT LIMITATIONS GUIDELINES

BPT effluent limitations guidelines are calculated by multiplying the pollutant concentrations promulgated in the final PM&F regulation by the average process water usage flow rate for a process, which is obtained from a permittee. The maximum for any one day and maximum for monthly average concentrations used to calculate the final BPT effluent limitations guidelines are presented in Table X-1.

#### EXAMPLE OF THE APPLICATION OF THE BPT EFFLUENT LIMITATIONS GUIDELINES

The purpose of the BPT effluent limitations guidelines is to provide a uniform basis for regulating process water discharged from processes in the plastics molding and forming category. For direct dischargers, this is accomplished through NPDES permits. The plastics molding and forming category is regulated on an individual wastewater flow "building block" approach. An example that illustrates how the effluent limitations guidelines are used to determine the amount of pollutants that can be discharged from plastics molding and forming plants is presented below.

##### Example

Plant X is a hypothetical plastics molder and former that is classified as a direct discharger. Plant X, which operates for eight hours a day, 250 days per year, compounds and pelletizes 1,250,000 kg of polyethylene per year. The pelletizing process uses contact cooling water. A portion of the pelletized product is extruded in a process that also uses contact cooling water. The average process water usage flow rates for both these processes are 118,100 l/day (65 gpm) and 36,400 l/day (20 gpm), respectively.

In addition, Plant X cleans injection molds; the molds are used to shape polyethylene products. The average process usage flow rate for the cleaning water process is 16,350 l/day (3 gpm). The

shaped polyethylene is then trimmed in a finishing operation that uses an average of 1,900 l/day (0.34 gpm) of finishing water. Only de minimus levels of BOD<sub>5</sub> and oil and grease are present in the finishing water from this operation.

Based on this information, the allowable masses of pollutants that can be discharged by Plant X under the final BPT regulation are determined as follows. Plant X has processes that belong to each of the three PM&F subcategories. The two contact cooling processes are regulated under the contact cooling and heating water subcategory, the injection mold cleaning process is regulated under the cleaning water subcategory, and the trimming process is regulated under the finishing water subcategory.

The mass of BOD<sub>5</sub> that may be discharged from PM&F processes at Plant X is calculated as follows:

1. The total average process water usage flow rate for the contact cooling and heating water process is the sum of the reported average process water usage flow rates. For Plant X, this is equal to 118,100 l/day plus 36,400 l/day, or a total of 154,500 l/day.
2. From Table X-1, the maximum for any one day concentration value for BOD<sub>5</sub> is 26 mg/l.
3. Multiplying the effluent concentration (26 mg/l) by the average process water flow rate (154,500 l/day) results in the maximum for any one day mass of 4,017,000 mg/day (8.9 lbs/day) of BOD<sub>5</sub> that may be discharged from the contact cooling and heating water processes.
4. Using these calculation procedures (steps 1-3) for the cleaning water process results in the corresponding maximum for any one day BOD<sub>5</sub> discharge of 801,500 mg/day (1.8 lbs/day). The BOD<sub>5</sub> discharge from the finishing water is not considered because BOD<sub>5</sub> is not regulated in the finishing water subcategory and only de minimus levels of BOD<sub>5</sub> were reported in the finishing water by the permittee.
5. The total maximum for any one day discharge for BOD<sub>5</sub> for Plant X is the sum of 4,017,000 mg/day (from contact cooling water) and 801,150 mg/day (from cleaning water), or 4,818,150 mg/day (10.6 lbs/day).

Table X-2 illustrates the calculation of the maximum for any one day mass of pollutants that can be discharged for Plant X. Maximum for monthly average mass discharges are calculated in a similar manner.



Table X-2

## ALLOWABLE DISCHARGE OF REGULATED POLLUTANTS FOR PLANT X

Process Water	Average Process Water Usage Flow Rate (l/day)	BOD <sub>5</sub>		O&G		TSS	
		Effluent Concentration (mg/l)*	Maximum for Any One Day Mass (mg/day)	Effluent Concentration (mg/l)	Maximum for Any One Day Mass (mg/day)	Effluent Concentration (mg/l)	Maximum for Any One Day Mass (mg/day)
Contact Cooling Water for Pelletizing	118,100	26	3,070,600	29	3,424,900	19	2,243,900
Contact Cooling Water for Extrusion	36,400	26	946,400	29	1,055,600	19	691,600
Cleaning Water for Injection Molds	16,350	49	801,150	71	1,160,850	117	1,912,950
Finishing Water for Trimming	1,900	†	--	†	--	130	247,000
Total Maximum for Any One Day Discharge for Plant X (mg/day)			4,818,150		5,641,350		5,095,450

\*Effluent concentrations are from Table X-1.

†BOD<sub>5</sub> and O&G are not regulated in the finishing water subcategory. Additionally, the permittee reported only de minimus levels of BOD<sub>5</sub> and O&G in the process waters for the finishing operations.



## SECTION XI

### BEST AVAILABLE TECHNOLOGY ECONOMICALLY ACHIEVABLE

#### INTRODUCTION

This section defines the effluent limitations guidelines based on the performance of the best available technology economically achievable (BAT) pursuant to Section 304(b)(2)(B) of the Clean Water Act. BAT effluent limitations guidelines are applicable to process waters that are directly discharged by existing sources.

The factors considered in assessing BAT include the total cost of applying the technology in relation to the amount of pollutant removal, age of equipment and facilities involved, the process employed, process changes, non-water quality environmental impacts (including energy requirements) and the costs of applying such technology. At a minimum, the BAT level represents the best economically achievable performance of plants of various ages, sizes, processes, or other shared characteristics. As with BPT, where the Agency has found the existing treatment performance to be uniformly inadequate, BAT may be transferred from a different subcategory or category. BAT may include feasible process changes or internal controls even when not common industry practice.

The required assessment of BAT "considers" costs, but does not require a balancing of costs against effluent reduction benefits (see, Weyerhaeuser v. Costle, *supra*). In developing BAT, however, EPA gives substantial weight to the reasonableness of cost. The Agency considers the volume and nature of discharges expected after application of BPT, the general environmental effects of the pollutants, and the costs and economic impacts of the additional pollution control levels.

Despite this expanded consideration of costs, the primary determinant of BAT is effluent reduction capability. As a result of the Clean Water Act of 1977, the achievement of BAT effluent limitations guidelines has become the principal national means of controlling toxic pollutants. Process waters generated by PM&F processes contain five priority toxic pollutants in treatable concentrations including one toxic metal and four toxic organics.

#### IDENTIFICATION OF THE BEST AVAILABLE TECHNOLOGY ECONOMICALLY ACHIEVABLE

##### Contact Cooling and Heating Water Subcategory

The only toxic pollutant found in treatable concentrations in contact cooling and heating waters was bis(2-ethylhexyl) phthalate. It was found in treatable concentrations in 12 out of 16

processes sampled (52.6 percent of the samples analyzed) ranging from 0.011 to 1.72 mg/l. Therefore, only BAT options that remove that pollutant were considered for the final PM&F regulation.

At proposal, EPA considered a package activated sludge plant as a BAT option for this subcategory. This option was not considered for the final rule because the BOD<sub>5</sub> concentrations in contact cooling and heating waters are not high enough to support the operation of biological treatment.

Contract haul was also a BAT option for this subcategory at proposal. That option included recycle to reduce the amount of process water that had to be hauled. As discussed earlier, the Agency has determined that recycle is no longer appropriate as part of the technology basis for the effluent limitations guidelines and standards for the PM&F category. EPA believes that contract haul is not a feasible option unless the amount of process water that has to be hauled is reduced through the use of a recycle unit. For this reason, contract haul was not considered as a BAT option for the final regulation for this subcategory.

The Agency considered one option as the basis for the BAT effluent limitations guidelines in this subcategory. It is:

Option 1: pH Adjustment (as needed) and Activated Carbon Adsorption

The model treatment technology in Option 1 is the only technology EPA could identify to remove the bis(2-ethylhexyl) phthalate in contact cooling and heating water. Enough activated carbon was included in the design of that process to remove the phthalate to a level equal to its treatability limit (see Table VII-9). The technology for this option is shown in Figure XI-1.

The estimated amount of bis(2-ethylhexyl) phthalate discharged in contact cooling and heating water is 9,470 kg/yr. After application of the model treatment technology in Option 1, the Agency estimates that 8,500 kg/yr of this phthalate will be removed.

The estimated investment costs and annual pollution control costs for Option 1 are \$34,000,000 and \$13,000,000, respectively, in 1984 dollars. Detailed information on these costs is presented in Economic Impact Analysis of Effluent Limitations and Standards for the Plastics Molding and Forming Industry, EPA 440/2-84-025, December 1984.

Option Selected. The Agency is not selecting Option 1 as the basis for the final BAT effluent limitations guidelines for this subcategory at this time because EPA has no treatability data for the activated carbon process. The Agency plans to conduct further studies to obtain these data.

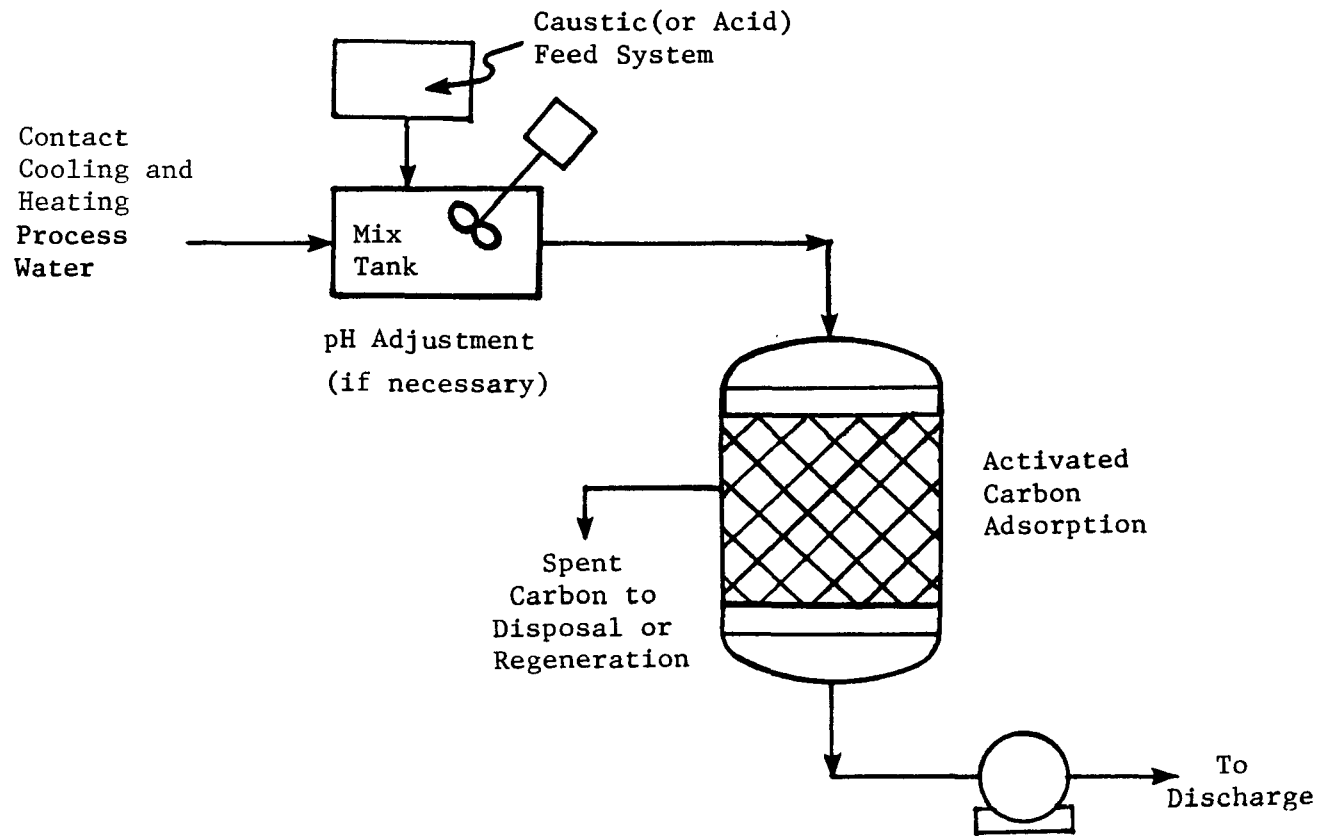

Figure XI-1

BAT OPTION 1  
CONTACT COOLING AND HEATING WATER SUBCATEGORY

As part of the treatability study, EPA will collect samples at contact cooling and heating water processes. The Agency will then conduct bench-scale studies to select the type of activated carbon to use to treat contact cooling and heating water and to determine the carbon exhaustion rates. Once carbon exhaustion rates are known, EPA can design and cost the activated carbon processes for the treatment of contact cooling and heating water.

Because of the lack of performance data for the treatment of phthalates in the activated carbon process, EPA is reserving the BAT effluent limitations for bis(2-ethylhexyl) phthalate for this subcategory at this time. When the treatability study discussed above is completed, the Agency will propose and promulgate the BAT effluent limitations guidelines for the phthalate.

The Agency is promulgating BAT equal to BPT for the other priority toxic pollutants because bis(2-ethylhexyl) phthalate is the only toxic pollutant found in treatable concentrations in contact cooling and heating waters. Therefore, except for bis(2-ethylhexyl) phthalate, the BAT effluent limitations guidelines are the same as the BPT effluent limitations guidelines for this subcategory. EPA has determined that the BAT/BPT effluent limitations guidelines for this subcategory are economically achievable.

There are no net increases in energy usage or solid waste generation for BAT compared to BPT for the contact cooling and heating water subcategory because, at this time, the Agency is not promulgating BAT effluent limitations guidelines more stringent than the BPT effluent limitations guidelines for this subcategory.

#### Cleaning Water Subcategory

The Agency only considered one option for BAT for this subcategory. This option, which is the selected BPT, is:

Option 1: Equalization, pH Adjustment, and Package Activated Sludge Plant

At proposal, the Agency considered recycle and contract haul of the discharge from the recycle unit as a BAT option. This option was rejected for this subcategory for the final regulation for the same reasons it was rejected in the contact cooling and heating water subcategory.

The Agency is not promulgating BAT effluent limitations guidelines more stringent than the BPT effluent limitations guidelines for this subcategory because there are insignificant quantities of priority toxic pollutants remaining in cleaning waters after application of BPT. The Agency estimates that 155 kg/yr of the

toxic pollutants (i.e., phenol and zinc) discharged in cleaning waters in treatable concentrations will be removed after compliance with the BPT effluent limitations guidelines. Thus, 82 kg/yr would be discharged after application of BPT. This is equal to less than 0.01 kg/day of toxic pollutants discharged per direct discharger. Table C-4 in Appendix C lists the estimated amount of phenol and zinc that would be discharged per year by direct dischargers in this subcategory after compliance with the BPT effluent limitations guidelines. Also shown on Table C-3 is the average concentration of toxic pollutants after application of BPT. The Agency has determined that the toxic pollutants are adequately controlled by the BPT effluent limitations guidelines and the amount and toxicity of those pollutants after application of BPT do not justify establishing more stringent BAT effluent limitations guidelines for toxic pollutants for this subcategory. Accordingly, EPA is excluding the toxic pollutants phenol and zinc from further national regulation for this subcategory, under Paragraph 8(a)(i) of the Settlement Agreement in NRDC v. Train, supra.

There are no net increases in energy usage or solid waste generation for BAT compared with BPT for the cleaning water subcategory because the Agency is not promulgating BAT effluent limitations guidelines more stringent than BPT effluent limitations guidelines for this subcategory. EPA has determined that the BAT/BPT effluent limitations guidelines for this subcategory are economically achievable.

#### Finishing Water Subcategory

Three toxic pollutants were found in finishing waters in treatable concentrations. Bis(2-ethylhexyl) phthalate was found in treatable concentrations in two of three sampled finishing processes (55.6 percent of the samples analyzed) ranging from 0.011 mg/l to 1.488 mg/l. Di-n-butyl phthalate was found in treatable concentrations in one of three sampled finishing processes (33.3 percent of the samples analyzed) ranging from 0.038 mg/l to 0.081 mg/l; dimethyl phthalate was found in treatable concentrations in one of three sampled finishing processes (11.1 percent of the samples analyzed) at 0.194 mg/l. Therefore, for this final regulation, only BAT options that remove bis(2-ethylhexyl) phthalate, di-n-butyl phthalate, and dimethyl phthalate were considered.

At proposal, cleaning water processes and finishing water processes were in the same subcategory. Subsequent to proposal, those processes were placed in separate subcategories.

The BAT options considered at proposal for the cleaning and finishing water subcategory were considered for the finishing water subcategory in this final regulation. Recycle and contract

haul of the discharge from the recycle unit was rejected for this subcategory for the same reasons it was rejected for the cleaning water subcategory. Recycle and treatment of the discharge from the recycle unit in a package activated sludge plant with pH adjustment was also rejected for this subcategory because the BOD<sub>5</sub> concentrations in finishing waters are not high enough to support the operation of a biological process.

The Agency considered one option as the basis for the BAT effluent limitations guidelines for this subcategory.

Option 1: pH Adjustment (as needed), Settling, and Activated Carbon Adsorption

The model treatment technology in Option 1 is the only technology EPA could identify to remove the phthalates in finishing waters. Enough activated carbon was included in the design of that process to remove the phthalates to a level equal to their treatability limits (see Table VII-9). The settling unit, which is the selected BPT, removes the TSS in the process water prior to treatment of the process water in the activated carbon process. The model treatment technology for this option is depicted in Figure XI-2.

The estimated amounts of pollutant remaining after Option 1 are:

<u>Pollutant</u>	<u>In Raw Wastewater (kg/yr)</u>	<u>Pollutant Mass Removed - Option 1 (kg/yr)</u>	<u>Remaining After Option 1 (kg/yr)</u>
Conventional	3,630	2,938	692
Priority Toxic	20	18.5	1.5

The estimated investment costs and annual pollution control cost for Option 1 are \$311,000 and \$162,000, respectively, in 1984 dollars.

Option Selected. The Agency is not selecting Option 1 as the basis for the final BAT effluent limitations for this subcategory at this time because EPA has no treatability data for phthalates for the activated carbon process. As mentioned in the discussion for the contact cooling and heating water subcategory, the Agency plans to conduct further studies to obtain these data. These studies will address the phthalates in both contact cooling and heating waters and in finishing waters.

Because of the lack of performance data for the treatment of phthalates in the activated carbon process, EPA is reserving the



305

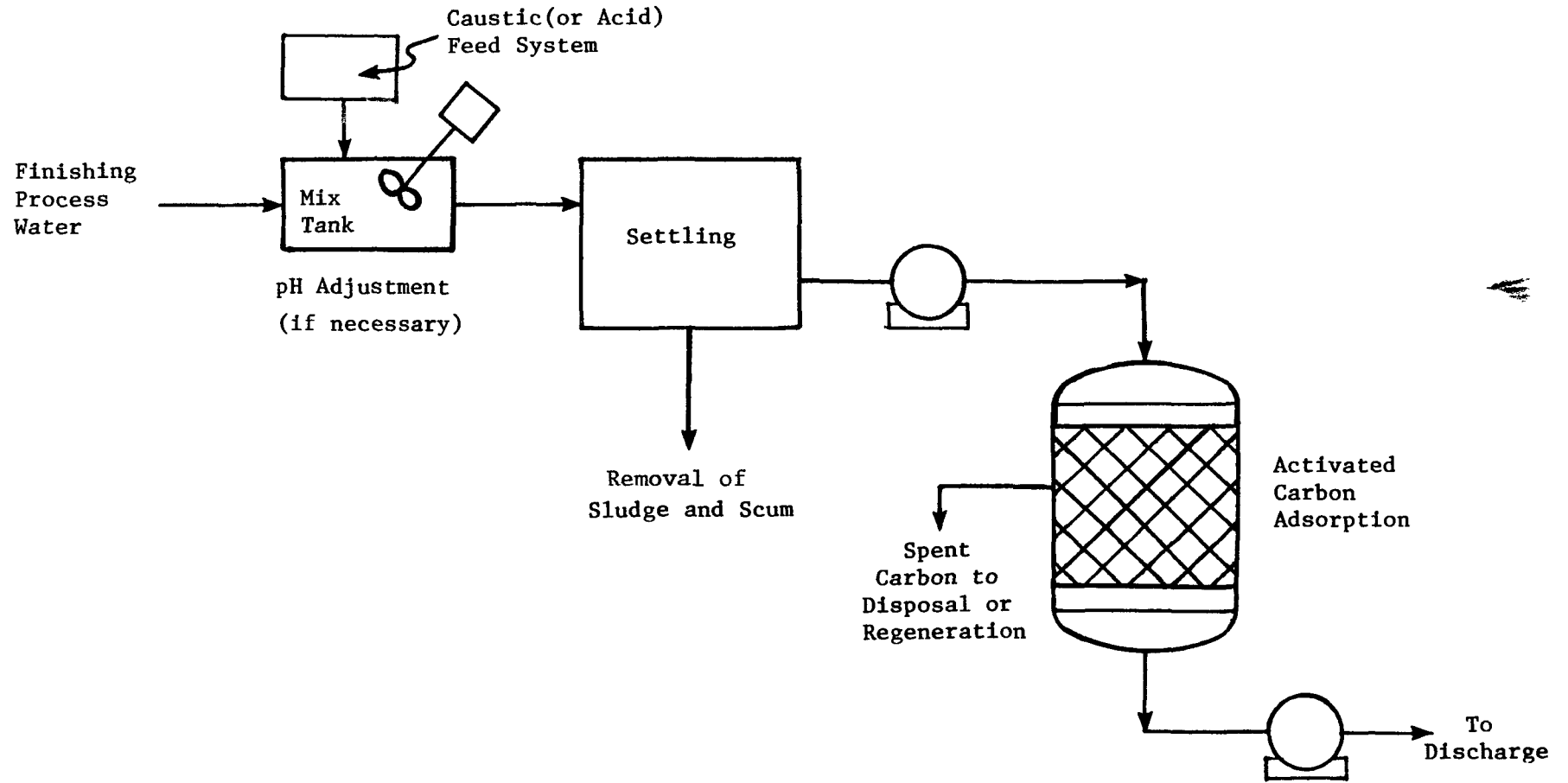

Figure XI-2  
BAT OPTION 1  
FINISHING WATER SUBCATEGORY

BAT effluent limitations guidelines for bis(2-ethylhexyl) phthalate, di-n-butyl phthalate, and dimethyl phthalate for this subcategory at this time. When the treatability study for phthalates is completed, the Agency will propose and promulgate the BAT effluent limitations guidelines for the phthalates.

The Agency is promulgating BAT equal to BPT for the other toxic pollutants because, except for the three phthalates, there are no toxic pollutants found in treatable concentrations in finishing waters. With the exception of the three phthalates listed above, the BAT effluent limitations guidelines are the same as the BPT effluent limitations guidelines for this subcategory. EPA has determined that the BAT/BPT effluent limitations guidelines for this subcategory are economically achievable.

There are no net increases in energy usage or solid waste generation for BAT compared to BPT for the finishing water subcategory because, at this time, the Agency is not promulgating BAT effluent limitations guidelines more stringent than the BPT effluent limitations guidelines for this subcategory.

## SECTION XII

### NEW SOURCE PERFORMANCE STANDARDS

#### INTRODUCTION

This section discusses new source performance standards (NSPS) for PM&F processes at new sources that discharge directly to navigable waters. New sources are defined as any building, structure, facility, or installation (including major modifications to existing sources) for which construction is started after promulgation of NSPS for the PM&F category.

The basis for NSPS under Section 306 of the Act is the best available demonstrated technology. New plants have the opportunity to design and use the best and most efficient plastics molding and forming processes and wastewater treatment technologies without facing the added costs and restrictions encountered in retrofitting an existing plant. Therefore, Congress directed EPA to consider the best demonstrated process changes, in-plant controls, and end-of-pipe treatment technologies that reduce pollution to the maximum extent feasible when developing NSPS.

#### TECHNICAL APPROACH TO NSPS

The Agency believes that characteristics of process waters discharged by new PM&F processes in each subcategory will be the same as the characteristics of process waters discharged by existing PM&F processes in those subcategories. Thus, the options considered for NSPS are the same as those considered for the BPT/BAT effluent limitations guidelines for each subcategory. These options are discussed in the BPT and BAT sections of this development document (Sections X and XI, respectively). The pollutants found in treatable concentrations in the process waters for each subcategory and their concentrations are presented in Tables VII-1, VII-3, and VII-10.

#### NSPS OPTION SELECTION

Except for phthalates in two subcategories, the Agency is promulgating NSPS based on the model treatment technologies selected as the basis for the BPT/BAT effluent limitations guidelines. EPA is not promulgating NSPS more stringent than the effluent limitations guidelines for existing sources at this time because either the amount and toxicity of the priority toxic pollutants remaining after application of the BPT/BAT model technologies do not justify more stringent controls or there are no toxic pollutants in treatable concentrations in the process waters. The mass of priority toxic pollutants remaining and their effluent

concentrations after application of BPT/BAT are presented in Tables C-3 and C-5 for the cleaning water subcategory and Tables C-7 and C-10 for the finishing water subcategory, respectively. Except for one phthalate, there are no priority toxic pollutants in treatable concentrations in contact cooling and heating process waters.

EPA is reserving NSPS for bis(2-ethylhexyl) phthalate for the contact cooling and heating water subcategory pending completion of the phthalate treatability study discussed in Section XI of this development document. NSPS for bis(2-ethylhexyl) phthalate, di-n-butyl phthalate, and dimethyl phthalate are also reserved for the finishing water subcategory until the treatability study is completed. When that study is completed, EPA will propose and promulgate NSPS for the phthalates.

The technology basis for NSPS for each subcategory is:

#### Contact Cooling and Heating Water Subcategory

NSPS for this subcategory are based on good housekeeping practices. As discussed earlier, EPA found during the sampling episodes for development of the PM&F regulation that good housekeeping practices are employed with contact cooling and heating water processes. Lubricating oils and other pollutants are kept out of the contact cooling and heating waters and those waters are used only for plastics molding and forming. Good housekeeping practices are the basis for the NSPS for this subcategory because, except for one phthalate, there are no pollutants in contact cooling and heating waters in treatable concentrations. NSPS ensure that good housekeeping practices will be employed at plants using new contact cooling and heating water processes because they are based on the current concentrations of pollutants discharged at existing sources where good housekeeping is practiced.

NSPS for this subcategory control BOD<sub>5</sub>, O&G, TSS, and pH. Results of the statistical evaluation used to establish concentration values for those pollutants are presented in Appendix D. NSPS for bis(2-ethylhexyl) phthalate for this subcategory are reserved pending completion of the phthalate treatability study.

#### Cleaning Water Subcategory

The model treatment technology for NSPS for this subcategory consists of equalization, pH adjustment (as needed), and a package activated sludge plant. A schematic of the model treatment technology for NSPS for the cleaning water subcategory is presented in Figure XII-1. NSPS for this subcategory control BOD<sub>5</sub>, O&G, TSS, and pH.

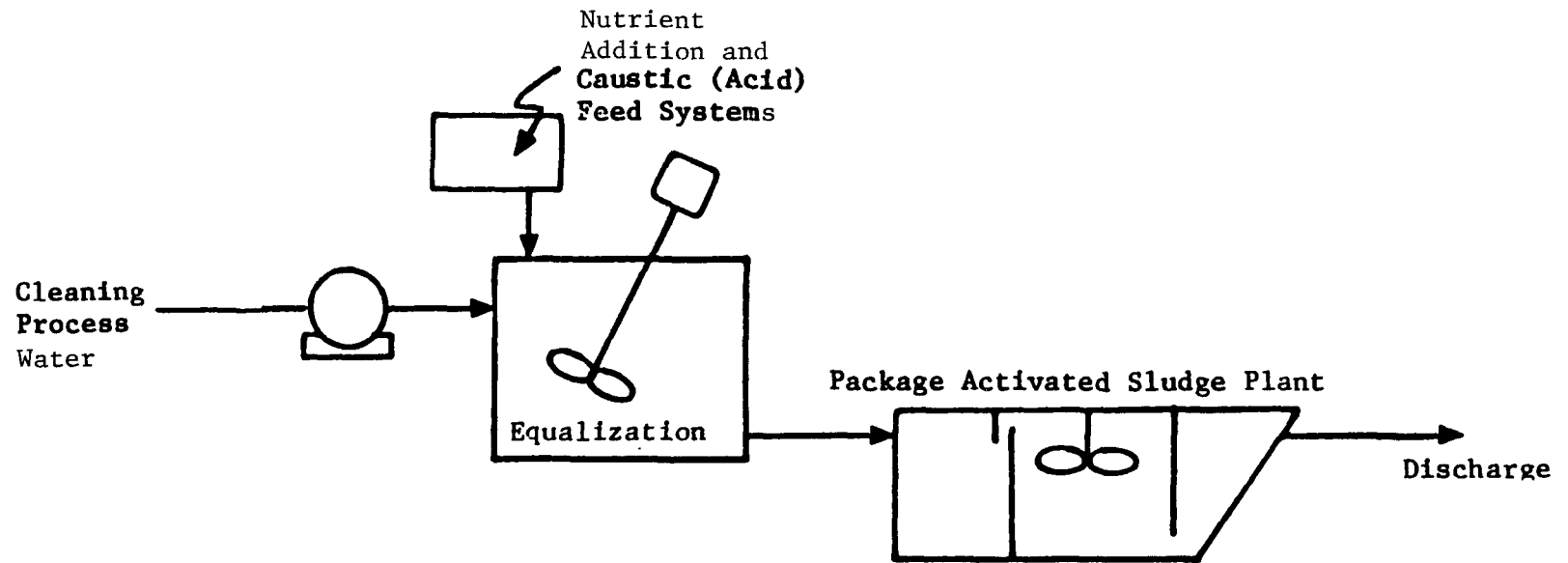

Figure XII-1

MODEL TREATMENT TECHNOLOGY FOR NSPS - CLEANING WATER SUBCATEGORY

The Agency considered a model treatment technology for NSPS for this subcategory that included a package activated sludge plant followed by a filter. However, EPA did not propose NSPS based on this more stringent technology and the Agency has no performance data using that technology for the treatment of cleaning water only. Also, EPA did not receive any comments on the proposed PM&F regulation suggesting that a filter should be included in the model technology for NSPS. This may be because, based on the "normal" plant for this subcategory discussed later in this section, the Agency estimates that 2,180 kg/yr of conventional pollutants would be removed by the activated sludge process followed by a filter (see Appendix C). This is only 80 kg/yr or 0.32 kg/day per direct discharging new source more than would be removed by a package activated sludge plant without a filter. There are no additional nonconventional and priority toxic pollutant removals by filtration, because these pollutants are dissolved, not suspended. For these reasons, EPA is not including a filter in the NSPS model technology for this subcategory at this time. However, after further study of the filtration technology for the best conventional pollutant control technology (BCT) effluent limitations guidelines for this subcategory, if the Agency finds that additional conventional pollutant removals based on the application of a filter are justified, EPA may revise NSPS for this subcategory using a model treatment technology that consists of a package activated sludge plant with pH adjustment and a filter.

#### Finishing Water Subcategory

The model treatment technology for NSPS for this subcategory consists of pH adjustment (if necessary) and settling. A schematic of this model treatment technology for the finishing water subcategory is presented in Figure XII-2. NSPS for this subcategory control TSS and pH.

NSPS for bis(2-ethylhexyl) phthalate, di-n-butyl phthalate, and dimethyl phthalate for this subcategory are reserved pending completion of the phthalate treatability study discussed in Section XI. The phthalates were the only toxic pollutants found in treatable concentrations in finishing waters.

The Agency considered a model treatment technology for NSPS for this subcategory that included pH adjustment, settling, and filtration. However, EPA did not propose NSPS based on this more stringent technology and the Agency has only limited performance data using this model treatment technology to treat finishing waters only. Also, EPA did not receive any comments on the proposed PM&F regulation suggesting that a filter should be included in the model treatment technology for NSPS (cleaning water processes and finishing water processes were in the same subcategory at proposal). This may be because, based on the

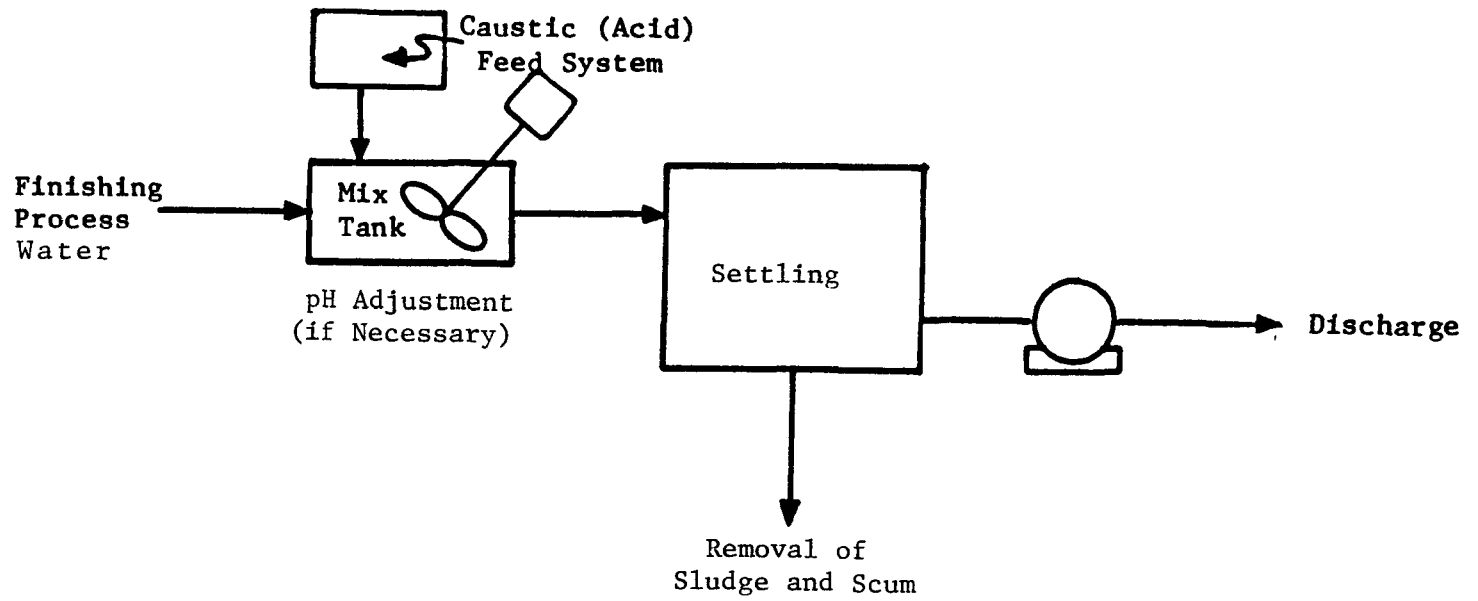

Figure XII-2

MODEL TREATMENT TECHNOLOGY FOR NSPS - FINISHING WATER SUBCATEGORY

"normal" plant for this subcategory discussed later in this section, the Agency estimates that 318 kg/yr of conventional pollutants would be removed by a settling unit followed by a filter (see Appendix C). This is only 66 kg/yr or 0.26 kg/day per direct discharging new source more than would be removed by a settling unit. For these reasons, EPA is not using a filter as with the model treatment technology for NSPS for this subcategory at this time. However, after further study of the filtration technology for the BCT effluent limitations guidelines for this subcategory, if the Agency finds that additional conventional pollutant removals based on the application of a filter are justified, EPA may revise NSPS for this subcategory using filtration as part of the model treatment technology.

### COSTS AND POLLUTANT REMOVALS FOR NSPS

The Agency conducted an economic analysis of the impact of the final NSPS on new PM&F plants. The analysis was based on a "normal" plant for each subcategory. A "normal" plant for a subcategory is a theoretical model plant that has one molding and forming process covered by the subcategory whose production, wastewater characteristics, and financial profile are typical of existing plants.

The process flow rates for the PM&F process in a "normal" plant are assumed to be the median values for plants in the questionnaire data base for a subcategory. The pollutant concentrations in the process waters discharged from the PM&F process at a "normal" plant are assumed to be equal to the subcategory average pollutant concentrations. Each "normal" plant is also assumed to operate 6,000 hours/year (24 hours/day for 250 days/year). Process flow rates and pollutant concentrations assumed for the "normal" plant in each subcategory are presented in Table XII-1.

The pollutant masses in the PM&F process waters for the "normal" plants are shown in Table XII-2. The pollutant removals for the NSPS model treatment technology for each "normal" plant are presented in Table XII-3. Data for the model treatment technologies used as the basis for the effluent limitations guidelines for existing sources were used to estimate the removals presented in Table XII-3.

The estimated investment cost and annual pollution control costs for the NSPS model treatment technology for each subcategory are presented in Table XII-4.

Data relied on for the economic analysis of NSPS were primarily data developed for existing sources, which include costs on a plant-by-plant basis along with retrofit costs where applicable. The Agency believes that costs could be lower for new sources



Table XII-1

## CHARACTERISTICS OF PM&amp;F "NORMAL" PLANTS

<u>Characteristic†</u>	<u>Subcategory</u>		
	<u>Contact Cooling and Heating Water</u>	<u>Cleaning Water</u>	<u>Finishing Water</u>
Process Flow Rate (gpm)	35	13.5	3.15
Operating Hours (hrs/yr)	6,000	6,000	6,000
Conventional Pollutants			
BOD5 (mg/l)	*	89	*
O&G (mg/l)	*	47	*
TSS (mg/l)	*	714	95
pH	5.4-8.3	1.6-11.5	6.9-8.4
Nonconventional Pollutants (mg/l)			
COD	*	115	*
TOC	*	634	*
Total Phenol	*	36	*
Priority Pollutants (mg/l)			
65. Phenol	*	0.198	*
66. Bis(2-ethylhexyl) Phthalate	0.098	*	0.479
68. Di-n-butyl phthalate	*	*	0.031
71. Dimethyl phthalate	*	*	0.034
128. Zinc	*	0.598	*

†The average values presented here are from Tables VII-1, VII-3, and VII-10.

\*Pollutant was not found in treatable concentrations in this subcategory.

Table XII-2

POLLUTANT MASS IN PROCESS WATERS FOR NSPS "NORMAL" PLANT  
(kg/yr)

<u>Pollutant</u>	<u>Contact Cooling and Heating Water Subcategory</u>	<u>Cleaning Water Subcategory</u>	<u>Finishing Water Subcategory</u>
Conventional	*	2,293	363
Nonconventional	*	2,079	*
Priority Toxic	13.6	2.3	2.1

---

\*Pollutants not found in treatable concentrations in process waters.

Table XII-3

ESTIMATED POLLUTANT REMOVALS FOR PM&F NSPS MODEL  
TREATMENT TECHNOLOGY (kg/yr)

<u>Pollutant</u>	<u>Contact Cooling and Heating Water Subcategory*</u>	<u>Cleaning Water Subcategory</u>	<u>Finishing Water Subcategory</u>
Conventional	0	2,094	252
Nonconventional	0	1,314	0
Priority Toxic	0	1.5	0

---

\*Minimal removals for this subcategory because NSPS are based on good housekeeping practices instead of performance of a treatment technology.

Table XII-4

ESTIMATED COSTS OF NSPS MODEL TREATMENT TECHNOLOGY  
 FOR PM&F "NORMAL" PLANTS  
 (\$, 1984 Dollars)

	<u>Contact Cooling and Heating Water Subcategory</u>	<u>Cleaning Water Subcategory</u>	<u>Finishing Water Subcategory</u>
Investment Cost	0	\$267,000	\$9,100
Annual Pollution Control Costs	0	\$ 83,000	\$6,800

than costs for equivalent existing sources because production processes could be designed to reduce the amount of process water discharged and there would be no costs associated with retrofitting a process. The Agency does not believe that applying the model treatment technology for NSPS to new sources, including major modifications to existing sources, creates a barrier to entry into the PM&F category because new sources will expend an amount equal to, or possibly less than, the amount required by existing sources to comply with the final PM&F regulation.

#### REGULATED POLLUTANTS AND POLLUTANT PROPERTIES

The Agency has no reason to believe that the pollutants found in treatable concentrations in PM&F process waters from new sources will be any different than pollutants found in process waters from existing sources. Consequently, pollutants selected for regulation under NSPS are the pollutants controlled at BPT for each subcategory. They are: BOD<sub>5</sub>, O&G, TSS, and pH in the contact cooling and heating water subcategory and in the cleaning water subcategory and TSS and pH in the finishing water subcategory. The effluent concentrations promulgated for NSPS are the same as those presented in Table X-1. Those values are multiplied by the average process water usage flow rate obtained from the permittee to obtain the mass of pollutants that can be discharged. The Agency estimates that, except for phthalates, 63 percent of the treatable nonconventional pollutant mass and 65 percent of the treatable priority toxic pollutant mass are removed when the NSPS for the conventional pollutants are met. NSPS for phthalates are reserved in two subcategories.

#### NEW SOURCE PERFORMANCE STANDARDS

The effluent concentration values used by a permit writer or control authority to calculate the mass of a pollutant that can be discharged are the same as those used to calculate the BPT effluent limitations guidelines. These concentration values are discussed in more detail in Section X of this development document.

The concentration values for NSPS (see Table X-1) are multiplied by the average process water usage flow rate to obtain the mass of pollutants discharged. Calculation of the effluent concentration values presented in Table X-1 is addressed in Appendix D.

The example presented in Section X, which illustrates the application of the BPT effluent limitations guidelines, is also relevant to the application of the NSPS for each subcategory for the final regulation.

## NON-WATER QUALITY IMPACTS

### A. Air Pollution

Model treatment technologies for NSPS will settle or biologically oxidize pollutants found in PM&F process waters. Emissions from these technologies are not expected to cause air pollution problems. Accordingly, NSPS will not create any substantial air pollution problem.

### B. Solid Waste

EPA believes that the amount of solid wastes generated by a new source will be approximately the same as the amount generated by an equal-sized existing source at BPT. Therefore, for equal-sized facilities, the estimated annual average plant production of solid wastes generated in compliance with NSPS would be about the same as the annual average plant production for BPT. EPA projects that this would be about 40 metric tons per year per new source in the cleaning water subcategory and about 10 metric tons per year per new source in the finishing water subcategory. EPA anticipates that only minimal quantities of solid wastes would be generated at new sources in the contact cooling and heating water subcategory because of the characteristically low levels of TSS in process water discharges from existing sources in this subcategory. The assumptions used for estimating solid waste generation rates are presented in Section IX.

In addition, it is the Agency's view that solid wastes generated by new sources as a result of these guidelines are not expected to be classified as hazardous. This conclusion is based on the results of extraction procedure (EP) toxicity tests discussed in Section IX.

### C. Consumptive Water Loss

The model treatment technologies for NSPS are not expected to cause a water loss. Therefore, NSPS are not expected to result in a consumptive water loss.

### D. Energy Requirements

EPA believes that the energy used by a new direct discharging plant to comply with NSPS will be approximately the same amount as that used by an equal-sized existing source at BPT. Therefore, for equal-sized plants, the estimated annual plant energy use for NSPS would be about the same as the annual average energy use for BPT. EPA projects that this would be about 83,000 kw-hr/yr per new source in the cleaning water subcategory and about 2,400 kw-hr/yr per new source in the finishing water

subcategory. EPA anticipates that only minimal quantities of energy will be required at new sources in the contact cooling and heating water subcategory because the technology basis of NSPS (the application of good housekeeping practices) would not involve the use of significant levels of energy. The assumptions used for estimating energy requirements are presented in Section IX.

These uses do not significantly add to the total energy consumption for the PM&F category. The Agency concludes that any increased energy use to comply with the NSPS is insignificant and that effluent reduction benefits outweigh the increased energy use.





## SECTION XIII

### PRETREATMENT STANDARDS

This section addresses pretreatment standards for existing sources (PSES) and pretreatment standards for new sources (PSNS). PSES and PSNS are applicable to PM&F process waters that are indirectly discharged (i.e., discharged to a POTW), pursuant to in Sections 307(b) and 307(c) of the Clean Water Act.

The Federal Water Pollution Control Act of 1972 stated that pretreatment standards shall prevent the discharge of any pollutant that may interfere with, pass through, or otherwise be incompatible with a POTW. The Clean Water Act of 1977 further stipulated that industrial discharges also must not interfere with the use and disposal of municipal sludges. The General Pretreatment Regulations for existing and new sources originally were published in the Federal Register (Vol. 43, No. 123; June 26, 1978) and can be found at 40 CFR Part 403. These regulations provide the general framework for categorical pretreatment standards. They describe the Agency's overall policy for establishing and enforcing categorical pretreatment standards for new and existing industrial dischargers and delineate the responsibilities and deadlines applicable to each party involved, including POTWs, States, and the involved industries. In cases where categorical pretreatment standards are not established because the Agency has determined that they are not warranted, indirect dischargers must still comply with the General Pretreatment Regulations - 40 CFR Part 403.

The remainder of this section describes the technical approach to developing PSES/PSNS for the PM&F category.

#### TECHNICAL APPROACH

The Agency examined the need for pretreatment standards in each of the PM&F subcategories. Specifically, the Agency considered whether the toxic pollutants discharged by the PM&F processes pass through a POTW. A pollutant is considered by the Agency to pass through a POTW when more of that pollutant can be removed by the application of BAT than can be removed by a POTW. If, for a particular pollutant, the average percentage removed nation-wide in well-operated POTWs meeting secondary treatment requirements is greater than the percentage removed by BAT, the pollutant does not pass through a POTW. Thus, a categorical pretreatment standard for that pollutant is not needed.

## PRETREATMENT STANDARDS FOR EXISTING SOURCES

### Contact Cooling and Heating Water Subcategory

For all pollutants except bis(2-ethylhexyl) phthalate, the Agency is not promulgating categorical PSES for this subcategory; PSES for bis(2-ethylhexyl) phthalate are being reserved pending further study. EPA has determined that the average percentage of toxic pollutant removals (ranging from 35 to 99 percent) nationwide by well-operated POTWs meeting secondary treatment requirements is greater than the percentage of toxic pollutant removals achieved by BAT (i.e., zero percent removals) in this subcategory. Therefore, the toxic pollutants do not pass through a POTW. Even though categorical pretreatment standards are not being promulgated, indirect dischargers in this subcategory must comply with the General Pretreatment Regulations - 40 CFR Part 403.

PSES for bis(2-ethylhexyl) phthalate are reserved pending proposal and promulgation of the BAT effluent limitations guidelines for that pollutant. When BAT is selected for that pollutant, EPA will determine if bis(2-ethylhexyl) phthalate passes through a POTW.

### Cleaning Water Subcategory

EPA is not promulgating PSES for the cleaning water subcategory because the priority toxic pollutants found in cleaning waters in treatable concentrations (i.e., phenol and zinc) do not pass through a POTW. The Agency compared the percent removal of phenol and zinc (i.e., 75\* percent and 62\*\* percent, respectively) achieved by applying BAT to the average percentage removal of those pollutants nation-wide by well-operated POTWs

---

\*Percent removal was calculated based on the treatability limit from U.S. EPA's Treatability of Organic Priority Pollutants - Part C - Their Estimated (30-Day Ave.) Treated Effluent Concentration - A Molecular Engineering Approach, Murray P. Strier, July 11, 1978.

\*\*Percent removal was derived from the treatability limit for zinc for the lime, settle and filtration technology listed in the U.S. EPA, Development Document for Effluent Limitations Guidelines and Standards for the Nonferrous Metals Manufacturing Point Source Category Phase II, July 1984.

meeting secondary treatment requirements (99† percent for phenol and 77† percent for zinc). Because the percent removals in a POTW are greater than the BAT percent removals, phenol and zinc do not pass through a POTW. Therefore, categorical pretreatment standards are not required for phenol and zinc. Even though no categorical pretreatment standards are being promulgated for existing sources for this subcategory, indirect dischargers must comply with the General Pretreatment Regulations - 40 CFR Part 403.

#### Finishing Water Subcategory

Except for three phthalates, the Agency is not promulgating categorical PSES for this subcategory for any pollutant; PSES for bis(2-ethylhexyl) phthalate, di-n-butyl phthalate, and dimethyl phthalate are reserved. EPA has determined that the average percentage of toxic pollutants removed nation-wide by well-operated POTWs meeting secondary treatment requirements (ranging from 35 to 99 percent) is greater than the average percent removal of toxic pollutants by direct dischargers applying BAT (i.e., zero percent removals). Therefore, the toxic pollutants do not pass through a POTW. Even though the Agency is not promulgating categorical pretreatment standards, indirect dischargers at existing sources in this subcategory must comply with the General Pretreatment Regulations - 40 CFR Part 403.

PSES for bis(2-ethylhexyl) phthalate, di-n-butyl phthalate, and dimethyl phthalate are reserved pending development of the BAT effluent limitations guidelines for those pollutants. When BAT is selected, EPA will determine if those three pollutants pass through a POTW.

#### PRETREATMENT STANDARDS FOR NEW SOURCES

##### Contact Cooling and Heating Water Subcategory

For all pollutants except bis(2-ethylhexyl) phthalate, the Agency is not promulgating categorical PSNS for the contact cooling and heating water subcategory; PSNS for bis(2-ethylhexyl) phthalate are reserved. The Agency believes that new and existing indirect discharge sources in this subcategory will discharge the same pollutants in similar amounts. As discussed in the preceding

---

†POTW percent removals were obtained from Table 10, Fate of Priority Pollutants in Publicly Owned Treatment Works, Final Report, Volume 1, EPA-440/1-82/303, September 1982.

section, the average percentage of toxic pollutants removed nation-wide by well-operated POTWs meeting secondary treatment requirements (ranging from 35 to 99 percent) is greater than the average percent removal of toxic pollutants by direct dischargers applying BAT/NSPS (i.e., zero percent removals). Therefore, the toxic pollutants do not pass through a POTW. Even though the Agency is not promulgating categorical pretreatment standards at this time, indirect dischargers at new sources in this subcategory must comply with the General Pretreatment Regulations - 40 CFR Part 403.

The Agency believes that the concentrations of bis(2-ethylhexyl) phthalate in contact cooling and heating waters discharged from new indirect sources will be similar to the concentrations of that pollutant discharged from existing indirect sources. For this reason, the Agency is reserving PSNS for bis(2-ethylhexyl) phthalate until promulgation of NSPS for that pollutant. When NSPS are developed, EPA will determine if bis(2-ethylhexyl) phthalate passes through a POTW.

#### Cleaning Water Subcategory

The Agency is not promulgating categorical PSNS for this subcategory. The Agency believes that new and existing indirect discharging sources will discharge the same pollutants in similar amounts. As discussed in the preceding section, the average toxic pollutant percentage removed nation-wide by well-operated POTWs meeting secondary treatment requirements is greater than the percentage of toxic pollutant removals achieved by applying BAT. Therefore, the toxic pollutants do not pass through a POTW.

Even though new indirect dischargers are not subject to categorical pretreatment standards, they must comply with the General Pretreatment Regulations - 40 CFR Part 403.

#### Finishing Water Subcategory

Except for three phthalates, the Agency is not promulgating categorical PSNS for this subcategory for any pollutant; PSNS for bis(2-ethylhexyl) phthalate, di-n-butyl phthalate, and dimethyl phthalate are reserved. The Agency believes that new and existing indirect discharge sources in this subcategory will discharge the same pollutants in similar amounts. As discussed in the preceding section, EPA has determined that the average percentage of toxic pollutants removed nation-wide by well-operated POTWs meeting secondary treatment requirements (ranging from 35 to 95 percent) is greater than the average percent removals achieved by applying BAT/NSPS (i.e., zero percent removals). Therefore, the toxic pollutants do not pass through a POTW. Even though the Agency is not promulgating categorical pretreatment standards,

new source indirect dischargers in this subcategory must comply with the General Pretreatment Regulations - 40 CFR Part 403.

The Agency believes that the concentration of the three phthalates in finishing waters discharged from new indirect sources will be similar to the concentrations of those pollutants discharged from existing indirect sources. For this reason, the Agency is reserving PSNS for bis(2-ethylhexyl) phthalate, di-n-butyl phthalate, and dimethyl phthalate until NSPS for those pollutants are promulgated. When NSPS are developed, EPA will determine if the pollutants pass through a POTW.



## SECTION XIV

### BEST CONVENTIONAL POLLUTANT CONTROL TECHNOLOGY

This section defines the effluent limitations guidelines for the PM&F category based on the performance of the "best conventional pollutant control technology" (BCT). BCT effluent limitations guidelines are applicable to the discharge of conventional pollutants from existing industrial point sources, as established in Section 301(b)(2)(E) of the 1977 amendments to the Clean Water Act. Section 304(a)(4) designated the following as conventional pollutants: biochemical oxygen demand (BOD), total suspended solids (TSS), fecal coliform, pH, and any additional pollutants defined by the Administrator as conventional. The Administrator designated oil and grease a "conventional" pollutant on July 30, 1979 (44 FR 44501).

BCT effluent limitations guidelines are not additional limitations but replace BAT effluent limitations guidelines for the control of conventional pollutants. In addition to other factors specified in Section 304(b)(4)(B), the Act requires that BCT effluent limitations guidelines be assessed in light of a two part "cost-reasonableness" test. See, American Paper Institute v. EPA, 660 F.2d 954 (4th Cir. 1981). The first part of the test compares the cost for private industry to reduce its conventional pollutant concentrations with the cost publicly owned treatment works incur for similar levels of reduction. The second part of the test examines the cost-effectiveness of additional industrial wastewater treatment beyond BPT. EPA must find that the BCT effluent limitations guidelines are "reasonable" under both parts of the test before the BCT effluent limitations guidelines are established. In no case may the BCT effluent limitations guidelines be less stringent than the BPT effluent limitations guidelines.

EPA published its methodology for carrying out the BCT analysis on August 29, 1979 (44 FR 50732). In the case mentioned above, the Court of Appeals ordered EPA to make certain revisions. A revised methodology for the general development of BCT effluent limitations guidelines was proposed on October 29, 1982 (47 FR 49176). On September 20, 1984, the Agency issued a major notice of data availability for the BCT methodology (49 FR 37046). When the final BCT methodology is promulgated, EPA will use this methodology to determine whether BCT effluent limitations guidelines should be established for two of the three PM&F subcategories.

The Agency reviewed treatment technologies that could be used to remove additional conventional pollutants after BPT. For the contact cooling and heating water subcategory, EPA was unable to

identify a technology that further reduces the concentrations of conventional pollutants found in contact cooling and heating waters. For this reason, the Agency is establishing BCT effluent limitations guidelines equal to the BPT effluent limitations guidelines for the contact cooling and heating water subcategory (presented in Table X-2). Because there are no technologies available to reduce conventional pollutants in contact cooling and heating waters, EPA has no reason to await promulgation of the final BCT methodology before promulgating BCT effluent limitations guidelines for this subcategory.

For both the cleaning water subcategory and the finishing water subcategory, the Agency has identified at least one technology (filtration) that can reduce the concentration of conventional pollutants remaining after the application of BPT. Therefore, EPA is reserving promulgation of BCT effluent limitations guidelines for those subcategories pending promulgation of the final BCT methodology. Once that methodology is promulgated, EPA will apply it to the costs and conventional pollutant removals associated with the filtration technology to determine if additional controls for conventional pollutants are justified for those two subcategories.



SECTION XV  
ACKNOWLEDGEMENTS

This project was conducted by the Environmental Protection Agency (EPA). EPA personnel who contributed to this project are:

Jeffery D. Denit	Director, Industrial Technology Division
Devereaux Barnes	Deputy Director, Industrial Technology Division
Ernst P. Hall	Chief, Metals Industry Branch, Industrial Technology Division
Robert W. Dellinger	Chief, Consumer Commodities Branch, Industrial Technology Division
Robert M. Southworth, P.E.	Senior Project Officer, Consumer Commodities Branch, Industrial Technology Division
Susan E. Lepow	Assistant General Council, Water Division
Jill Weller	Attorney, Office of General Counsel
Louis Dupuis	Chief, Economic Analysis Staff, Office of Analysis and Evaluation
Ann M. Watkins	Economics Project Officer, Economic Analysis Staff, Office of Analysis and Evaluation
Henry D. Kahn	Analysis and Evaluation Division
R. Clifton Bailey	Statistician, Program Integration and Environmental Staff
Alexander McBride	Chief, Water Quality Analysis Branch, Monitoring and Data Support Division

Alexandra G. Tarnay                      Environmental Project Officer,  
Water Quality Analysis Branch,  
Monitoring and Data Support  
Division

Contractor personnel who contributed to this project are:

Lee C. McCandless	Program Manager, Versar, Inc.
David C. Kennedy	Vice President, Envirodyne Engineers, Inc.
Thomas M. Lachajczyk	Senior Environmental Engineer, Envirodyne Engineers, Inc.
Daniel L. Logan	Environmental Engineer, Envirodyne Engineers, Inc.
Robert A. Bessent	Environmental Engineer, Envirodyne Engineers, Inc.
Albert P. Becker	Chemical Engineer, Envirodyne Engineers, Inc.
Cindy L. Dahl	Environmental Engineer, Envirodyne Engineers, Inc.
James S. Sherman	Program Manager, Radian Corporation
Calvin L. Spencer	Project Director, Radian Corporation
Roy E. Sieber	Chemical Engineer, Radian Corporation
Arlene A. Freyman	Chemical Engineer, Radian Corporation
Robert M. Eng	Chemical Engineer, Radian Corporation
Laura L. Murphy	Chemical Engineer, formerly with Radian Corporation
Sandra F. Moore	Secretary, Radian Corporation
Daphne K. Phillips	Secretary, Radian Corporation
Nancy E. Reid	Secretary, Radian Corporation

The cooperation of the Society of Plastics Industry, Inc., the individual PM&F companies whose plants were sampled, and the companies who submitted detailed information in response to the questionnaires is gratefully appreciated.

## SECTION XVI

### REFERENCES

Agranoff, Joan (ed). Modern Plastics Encyclopedia, 1981-1982. McGraw-Hill, Inc., New York, New York, 1981.

Agranoff, Joan (ed). "Casting of Polypropylene Film." Modern Plastics Encyclopedia, 1981-1982. McGraw-Hill, Inc., New York, New York, 1981. p. 248.

Alex, Kurt. "Melt-Processible Structural Foam Molding." Modern Plastics Encyclopedia, 1981-1982. McGraw-Hill, Inc., New York, New York, 1981. p. 248.

Allan, R. W. "Closed Mold Processing." Modern Plastics Encyclopedia, 1981-1982. McGraw-Hill, Inc., New York, New York, 1981. p. 392.

Allbee, Nancy. "Update: Flame Retardants, Part 1: Inorganic Additives." Plastics Compounding, 4(4):89, 1981.

Allbee, Nancy. "Update: Flame Retardants, Part 2: Organic Additives." Plastics Compounding, 4(5):95, 1981.

Ahmed, Makhteur. Coloring of Plastics: Theory and Practice. Van Nostrand Reinhold, New York, New York, 1979.

American Council of Government Industrial Hygienists. TLVs, Threshold Limit Values for Chemical Substances and Physical Agents in the Workroom Environment With Intended Changes. ACGIH, Cincinnati, Ohio, 1978.

Baijal, Mahendra D. (ed). Plastics Polymer Science and Technology. John Wiley and Sons, New York, New York, 1982.

Baird, R. J. Industrial Plastics. The Goodheart-Wilcox Co., Inc., South Holland, Illinois, 1971.

Bajaj, J. K. L. "Liquid and Paste Mixers." Modern Plastics Encyclopedia, 1981-1982. McGraw-Hill, Inc., New York, New York, 1981. p. 370.

Bakker, Marilyn. Structural Foam Molding: Status 1979. Business Communications Co., Stamford, Connecticut, 1979.

Bamford, C. H. and C. F. H. Tipper (eds). Comprehensive Chemical Kinetics, Vol. 14, Degradation of Polymers. Elsevier Scientific Publishing Company, New York, New York, 1975.

Beadle, John, D. (ed). Plastics Forming. The Macmillan Press Ltd., Hampshire, U.K., 1971.

Beck, R. D. Plastic Product Design. Van Nostrand Reinhold Co., New York, New York, 1980.

Becker, Walter, E. (ed). Reaction Injection Molding. Van Nostrand Reinhold Company, New York, New York, 1979.

Bejuki, Walter M. "Degradation." Encyclopedia of Polymer Science and Technology, Vol. 4, Norbert M. Bikales (ed). Interscience Publishers, New York, New York. pp. 647-725.

Berry, R. M. Plastics Additives: Marketing Guide and Company Directory. TECHNOMIC Publishing Co., Westport, Connecticut, 1972.

Bikales, Norbert M. "Compounding." Encyclopedia of Polymer Science and Technology, Vol. 4, Norbert M. Bikales (ed). Interscience Publishers, New York, New York. pp. 118-129.

Bikales, Norbert M. "Extrusion." Encyclopedia of Polymer Science and Technology, Vol. 6, Norbert M. Bikales (ed). Interscience Publishers, New York, New York. pp. 466-467.

Billmeyer, F. W. Jr. Textbook of Polymer Science. John Wiley & Sons, Inc., New York, New York, 1971.

Blumberg, John G., James S. Flacone, Jr., Leonard H. Smiley, and David I. Netting. "Fillers." Kirk-Othmer Encyclopedia of Chemical Technology, 3rd Edition, Vol. 10, Martin Grayson (ed). John Wiley and Sons, New York, New York. pp. 198-215.

Boland, R. F., T. W. Hughes, and G. M. Rinaldio, Monsanto Research Corporation. Source Assessment: Plastics Processing - State of the Art. Environmental Protection Agency, Cincinnati, Ohio, 1978.

Bown, John. Injection Molding of Plastic Components. McGraw-Hill Book Company Ltd., England, 1979.

Boysen, Robert L. "Olefin Polymers High Pressure (Low and Intermediate Density) Polyethylene." Kirk-Othmer Encyclopedia of Chemical Technology, 3rd Edition, Vol. 16, Martin Grayson (ed). John Wiley and Sons, New York, New York. pp. 402-420.

Brighton, C. A., G. Pritchard, and G. A. Skinner. Styrene Polymers: Technology and Environmental Aspects. Applied Science Publishers, Ltd., London, England, 1979.

Brighton, C. A. "Vinyl Chloride Polymers (Compounding)." Encyclopedia of Polymer Science and Technology, Vol. 14, Norbert M. Bikales (ed). Interscience Publishers, New York, New York. pp. 419-434.

Brode, George L. "Phenolic Resins." Kirk-Othmer Encyclopedia of Chemical Technology, 3rd Edition, Vol. 17, Martin Grayson (ed). John Wiley and Sons, New York, New York. pp. 384-416.

Brown Leeson Corporation, Beaverton, Michigan, Marketing Brochure, 1981.

Brown, Richard, L. E. Design and Manufacture of Plastic Parts. John Wiley and Sons, New York, New York, 1980.

Bruins, Paul F. (ed). Basic Principles of Rotational Molding. Gordon and Breach Science Publishers, New York, New York, 1971.

Bruins, Paul F. (ed). Basic Principles of Thermoforming. Gordon and Breach Science Publishers, New York, New York, 1971.

Buchanan, D. R. "Olefin Fibers." Kirk-Othmer Encyclopedia of Chemical Technology, 3rd Edition, Vol. 16, Martin Grayson (ed). John Wiley and Sons, New York, New York. pp. 357-385.

Campbell, G. A. "Fluxed Melt Mixers." Modern Plastics Encyclopedia 1981-1982. McGraw-Hill, Inc., New York, New York, 1981. p. 367.

Campbell, P. E. and R. V. Jones. "Ethylene Polymers." Encyclopedia of Polymer Science and Technology, Vol. 6, Norbert M. Bikales (ed). Interscience Publishers, New York, New York. pp. 275-336.

Cantow, Manfred J.R. "Vinyl Polymers (Chloride)." Kirk-Othmer Encyclopedia of Chemical Technology, 2nd Edition, Vol. 21, Anthony Standen (ed). John Wiley and Sons, New York, New York. pp. 369-412.

Cargile, H. M., Beloit Corp. "Procedures, Parameters, and Machinery Requirements-Structural Foam Molding." Plastic Foams. Plastics Foam Conference, El Segundo, California, 1980.

Carley, J. F. "Introduction to Plastics Extrusion." Polymer Processing. American Institute of Chemical Engineering, New York, New York, 1964.

Chemical Marketing Research Association. Additives for Rubber and Plastics. CMRA, Staten Island, New York, 1977.

Chen, S. J. "Static Mixing of Polymers." Chemical Engineering Progress, 71(8):80, 1975.

"Computerized Filament Winding." Plastics Technology, 27(5):13, 1981.

Considine, Douglas M. Chemical and Process Technology Encyclopedia. McGraw-Hill, New York, New York, 1974. pp. 743-750.

Cooper, W. "Elastomers, Synthetic." Encyclopedia of Polymer Science and Technology, Vol. 5, Norbert M. Bikales (ed). Interscience Publishers, New York, New York. pp. 406-482.

Coplan, Myron J. Fiber Spinning and Drawing. Interscience Publishers, New York, New York, 1967.

Crane, G. R. "Plastisol Processing." Modern Plastics Encyclopedia 1981-1982. McGraw-Hill, Inc., New York, New York, 1981. p. 376.

Crespi, Giovanni and Luciano Luciani. "Olefin Polymers (Polypropylene)." Kirk-Othmer Encyclopedia of Chemical Technology, 3rd Edition, Vol. 16, Martin Grayson (ed). John Wiley and Sons, New York, New York. pp. 453-469.

Crosby, E. G., and S. N. Kochis. Practical Guide to Plastics Applications. Cahners Books, Boston, Massachusetts, 1972.

Crull, A. W. Polyurethane and Other Foams, Business Opportunity Report. Business Communications Co., Inc., Stamford, Connecticut, 1979.

Curry, Susan and Susan Rich. The Kline Guide to the Chemical Industry. Charles H. Kline Co., Fairfield, New Jersey, 1980.

Dadik, Sandra and Marilyn Bakker. Blow Molding Enters the Eighties. Business Communications Co., Stamford, Connecticut, 1979.

Dannenberg, Eli M. "Carbon (Carbon Black)." Kirk-Othmer Encyclopedia of Chemical Technology, 3rd Edition, Vol. 4, Martin Grayson (ed). John Wiley and Sons, New York, New York. pp. 631-666.

Davis, C. W. and P. Shapiro. "Acrylic Fiber." Encyclopedia of Polymer Science and Technology, Vol. 1, Norman G. Gaylord (ed). Interscience Publishers, New York, New York. pp. 342-373.

Davis, Gerald W. "Polyester Fibers." Kirk-Othmer Encyclopedia of Chemical Technology, 3rd Edition, Vol. 18, Martin Grayson (ed). John Wiley and Sons, New York, New York. pp. 531-549.

Doak, K. W. and R. A. Raff (eds). Crystalline Olefin Polymers. Interscience Publishers, New York, New York, 1965.

Dolliff, E. L. "Extrusion-Blow Molding." Modern Plastics Encyclopedia, 1981-1982. McGraw-Hill, Inc., New York, New York, 1981. p. 234.

Donovan, T. A. "Motionless Mixers." Modern Plastics Encyclopedia, 1981-1982. McGraw-Hill, Inc., New York, New York, 1981. p. 373.

Doyle, E. N. The Development and Use of Polyurethane Products. McGraw-Hill, Inc., New York, New York, 1971.

Driver, Walter E. Plastics Chemistry and Technology. Van Nostrand Reinhold, New York, New York, 1979.

DuBois, J. H. and F. W. John. Plastics, 6th Edition. Van Nostrand Reinhold Company, New York, New York, 1981.

Dym, Joseph B. Injection Molds and Molding. Van Nostrand Reinhold Co., New York, New York, 1979.

Eldin, R. A., and A. D. Swan. Calendering of Plastics. American Elsevier Publishing Co., Inc., New York, New York, 1971.

Enviro Control, Inc. Engineering Control Technology Assessment for the Plastics and Resins Industry, draft. Rockville, Maryland, November 1977.

Erlich, V. L. "Olefin Fibers." Encyclopedia of Polymer Science and Technology, Vol. 9, Norbert M. Bikales (ed). Interscience Publishers, New York, New York. pp. 403-438.

Ewald, G. W. "Filament Winding." Modern Plastics Encyclopedia, 1981-1982. McGraw-Hill, Inc., New York, New York, 1981. p. 394.

Fair, R. L. "Rotational Molding." Modern Plastics Encyclopedia, 1981-1982. McGraw-Hill, Inc., New York, New York, 1981. p. 400.

Faires, Virgil M. and Clifford M. Simmang. Thermodynamics. Macmillan Publishing Co., Inc., New York, New York, 1978.

Farrow, G. and E. S. Hill. "Polyester Fibers." Encyclopedia of Polymer Science and Technology, Vol. 11, Norbert M. Bikales (ed). Interscience Publishers, New York, New York. pp. 1-41.

Fisher, Edwin George. Blow Molding of Plastics. Iliffe, London, 1971.



Fisher, Edwin George. Extrusion of Plastics. John Wiley & Sons, New York, New York, 1976.

Fleischmann, J. "Compression Molding." Modern Plastics Encyclopedia, 1981-1982. McGraw-Hill, Inc., New York, New York, 1981. p. 255.

Fox, D. W. "Polycarbonates." Kirk-Othmer Encyclopedia of Chemical Technology, 3rd Edition, Vol. 18, Martin Grayson (ed). John Wiley and Sons, New York, New York. pp. 479-494.

Frados, Joel (ed). Plastics Engineering Handbook, SPI, 4th Edition. Van Nostrand Reinhold Company, New York, New York, 1976.

"Freon Blown Structural Foam is Superior." Modern Plastics, 58(7):28, 1981.

Funt, John M. Mixing of Rubbers. Rubber and Plastics Research Association of Great Britain, Shawbury, England, 1977.

Gage, P. E. "Casting of Nylon." Modern Plastics Encyclopedia, 1981-1982. McGraw-Hill, Inc., New York, New York, 1981. p. 248.

Galli, Ed. "Update: Polymer Soluble Dyes." Plastics Compounding, 4(3):91, 1981.

Gangal, S. V. "Polytetrafluoroethylene." Kirk-Othmer Encyclopedia of Chemical Technology, 3rd Edition, Vol. 11, Martin Grayson (ed). John Wiley and Sons, New York, New York. pp. 1-24.

Gillies, M. T. Stabilizers for Synthetic Resins: Recent Developments. Noyes Data Corporation, Park Ridge, New Jersey, 1981.

Glanvill, A. B. The Plastics Engineer Data Book. Industrial Press, Inc., New York, New York, 1973.

Gogas, C. G., Z. Tadmor. Principles of Polymer Processing. John Wiley & Sons, New York, New York, 1979.

Griff, Allan L. Plastics Extrusion Technology, Second Edition. Reinhold Book Corp., New York, New York, 1968.

Grimes, J. F. "Thermoforming." Modern Plastics Encyclopedia, 1981-1982. McGraw-Hill Inc., New York, New York, 1981. p. 405.

Hallet, G. F. "Proposal Method for Evaluating Cooling Equipment." Industrial Water Engineering, May 1980.

Hansen, Sigurd P., Robert C. Gumerman, Russel L. Culp. Estimating Water Treatment Costs, Volumes 1-4. Environmental Protection Agency Report EPA-600/2-79-162a-d, 1978.

Harper, Charles A. Handbook of Plastics and Elastomers. McGraw-Hill, Inc., New York, New York, 1975. pp. 8-56.

Harrington, R. C., Jr. "Powder Coatings." Encyclopedia of Polymer Science and Technology, Supplement, Vol. 1, Norbert M. Bikales (ed). Interscience Publishers, New York, New York. pp. 544-556.

Hattori, K. "Reinforced Plastics." Encyclopedia of Polymer Science and Technology, Vol. 12, Norbert M. Bikales (ed). Interscience Publishers, New York, New York. pp. 1-41.

Haviland, R. W. "Injection Blow Molding." Modern Plastics Encyclopedia, 1981-1982. McGraw-Hill, Inc., New York, New York, 1981. p. 241.

Hawley, Gessner G. The Condensed Chemical Dictionary. Van Nostrand Reinhold Co., New York, New York, 1977.

Hay, A. S., P. Sheniar, A. C. Gowan, P. F. Erhardt, W. R. Haaf, and J. E. Theberge. "Phenols, Oxidative Polymerization." Encyclopedia of Polymer Science and Technology, Vol. 10, Norbert M. Bikales (ed). Interscience Publishers, New York, New York. pp. 92-111.

Hawthorne, J. M. and C. J. Heffelfinger. "Polyester Films." Encyclopedia of Polymer Science and Technology, Vol. 11, Norbert M. Bikales (ed). Interscience Publishers, New York, New York. pp. 42-61.

Hensley, J. C. (ed). Cooling Tower Fundamentals. The Marley Cooling Tower Company, Kansas City, Missouri, 1982.

Herbert, Victor. "Multi-Component Liquid Foam Processing." Modern Plastics Encyclopedia, 1981-1982. McGraw-Hill, Inc., New York, New York, 1981. p. 305.

Higgins, D. G. "Fabrics, Coated." Encyclopedia of Polymer Science and Technology, Vol. 6, Norbert M. Bikales (ed). Interscience Publishers, New York, New York. pp. 476-489.

Higgins, D. G. and Arthur H. Landrock. "Coating Methods." Encyclopedia of Polymer Science and Technology, Vol. 3, Norbert M. Bikales (ed). Interscience Publishers, New York, New York. pp. 764-830.

Hill, H. Wayne, Jr. and D. G. Brady. "Poly(Phenylene Sulfide) (PPS)." Kirk-Othmer Encyclopedia of Chemical Technology, 3rd Edition, Vol. 18, Martin Grayson (ed). John Wiley and Sons, New York, New York. pp. 793-814.

Hitchcock, A. B. "Molding." Encyclopedia of Polymer Science and Technology, Vol. 9, Norbert M. Bikales (ed). Interscience Publishers, New York, New York. pp. 1-157.

Hobson, P. H. and A. L. McPeters. "Acrylic and Modacrylic Fibers." Kirk-Othmer Encyclopedia of Chemical Technology, 3rd Edition, Vol. 1, Martin Grayson (ed). John Wiley and Sons, New York, New York. pp. 355-386.

The International Plastics Selector, Inc. Desk Top Data Bank. Cordura Publications, La Jolla, California, 1977.

The International Plastics Selector, Inc. Foams, 1978. Cordura Publications, La Jolla, California, 1978.

Irick, Gether, Jr. "Additives That Help Polyolefins Stand Up to Weather." Modern Plastics, 58(4):90, 1981.

Joint Editorial Board, Greenberg, A. E., APHA; Conners, J. J., AWWA; Jenkins, J., WPCF. Standard Methods for the Examination of Water and Wastewater, Fifteenth Edition. American Public Health Association, Washington, D.C., 1981.

Jones, Roger F. "Molding Principles." Polymer Processing. American Institute of Chemical Engineers, New York, New York, 1964.

Katz, Harry S. and John V. Milewski. Handbook of Fillers and Reinforcements for Plastics. Van Nostrand Reinhold, New York, New York, 1978.

Keating, Joseph Z. "Cut Cost of FRP Spray-Up With Filled Polyester Foams." Plastics Technology, 26(10):80, 1980.

Kennedy, R. K. "Modacrylic Fibers." Encyclopedia of Polymer Science and Technology, Vol. 8, Norbert M. Bikales (ed). Interscience Publishers, New York, New York. pp. 812-834.

Kent, James A. (ed). Riegels Handbook of Industrial Chemistry, 7th edition. Van Nostrand Reinhold, New York, New York, 1974. p. 250.

Keskkula, Henno. "Styrene Polymers (Plastics)." Encyclopedia of Polymer Science and Technology, Vol. 13, Norbert M. Bikales (ed). Interscience Publishers, New York, New York. pp. 395-425.

Keskkula, Henno, Alan E. Platt, and Raymond F. Boyer. "Styrene Plastics." Kirk-Othmer Encyclopedia of Chemical Technology, 2nd Edition, Vol. 19, Anthony Standen (ed). John Wiley and Sons, New York, New York. pp. 85-134.

Kine, Benjamin B. and R. W. Novak. "Methacrylic Polymers." Kirk-Othmer Encyclopedia of Chemical Technology, 3rd Edition, Vol. 15, Martin Grayson (ed). John Wiley and Sons, New York, New York. pp. 377-398.

Kobayaski, Akira. "Machining." Encyclopedia of Polymer Science and Technology, Vol. 8, Norbert M. Bikales (ed). Interscience Publishers, New York, New York. pp. 338-374.

Kovach, George P. "Thermoforming." Encyclopedia of Polymer Science and Technology, Vol. 13, Norbert M. Bikales (ed). Interscience Publishers, New York, New York. pp. 832-843.

Kozacki, John. "Tubing." Encyclopedia of Polymer Science and Technology, Vol. 14, Norbert M. Bikales (ed). Interscience Publishers, New York, New York. pp. 94-96.

Kruder, G. A. "Extrusion." Modern Plastics Encyclopedia, 1981-1982. McGraw-Hill, Inc., New York, New York, 1981. p. 268.

Lappin, G. R. "Ultraviolet Radiation Absorbers." Encyclopedia of Polymer Science and Technology, Vol. 14, Norbert M. Bikales (ed). Interscience Publishers, New York, New York. pp. 125-147.

Lasman, Henry R. "Blowing Agents." Encyclopedia of Polymer Science and Technology, Vol. 2, Norman G. Gaylord (ed). Interscience Publishers, New York, New York. pp. 532-565.

Lebovits, A. and Gerald P. Ziemba. "Acrylonitrile-Styrene Copolymers." Encyclopedia of Polymer Science and Technology, Vol. 1, Norman G. Gaylord (ed). Interscience Publishers, New York, New York. pp. 374-444.

Lee, H. and K. Neville. "Epoxy Resins." Encyclopedia of Polymer Science and Technology, Vol. 6, Norbert M. Bikales (ed). Interscience Publishers, New York, New York. pp. 209-271.

Leis, D. G. and G. D. Lewis. "Reaction Injection Molding." Modern Plastics Encyclopedia, 1981-1982. McGraw-Hill, Inc., New York, New York, 1981. p. 386.

Levy, Sidney. Plastics Extrusion Technology Handbook. Industrial Press, Inc., New York, New York, 1981.

Levy, Sidney, and Harry J. DuBois. Plastics Product Design Engineering Handbook. Van Nostrand Reinhold Company, New York, New York, 1977. p. 181.

Liptak, Beta G. (ed). Environmental Engineers Handbook. Chilton Book Company, Radnor, Pennsylvania, 1974.

Luskin, L. S. "Casting of Acrylic." Modern Plastics Encyclopedia, 1981-1982. McGraw-Hill, Inc., New York, New York, 1981. p. 246.

Maassen, G. C., R. J. Fawcett, and W. R. Connell. "Antioxidants." Encyclopedia of Polymer Science and Technology, Vol. 2, Norman G. Gaylord (ed). Interscience Publishers, New York, New York. pp. 171-197.

Mainstone, K. A. "Extrusion Coating and Laminating." Modern Plastics Encyclopedia, 1981-1982. McGraw-Hill, Inc., New York, New York, 1981. p. 250.

Mansfield, G. A. "Open Mold Processing." Modern Plastics Encyclopedia, 1981-1982. McGraw-Hill, Inc., New York, New York, 1981. p. 397.

Mascia, L. The Role of Additives in Plastics. Edward Arnold, London, 1974.

"Materials 1982." Modern Plastics, 59(1):55, 1982.

May, Clayton A. and Yoshio Tanaka. Epoxy Resins, Chemistry and Technology. Marcel Dekker, Inc., New York, New York, 1973.

McGarry, Frederick J. "Laminated and Reinforced Plastics." Kirk-Othmer Encyclopedia of Chemical Technology, 3rd Edition, Vol. 13, Martin Grayson (ed). John Wiley and Sons, New York, New York. pp. 968-978.

McIntyre, J. E. "Man-Made Fibers, Manufacture." Encyclopedia of Polymer Science and Technology, Vol. 8, Norbert M. Bikales (ed). Interscience Publishers, New York, New York. pp. 374-404.

Mead, William J. (ed). The Encyclopedia of Chemical Process Equipment. Reinhold Publishing Co., New York, New York, 1964. pp. 641-662.

Meienberg, J. T. "Calendering." Modern Plastics Encyclopedia, 1981-1982. McGraw-Hill, Inc., New York, New York, 1981. p. 243.

Meinecke, Eberhard. "Calendering." Encyclopedia of Polymer Science and Technology, Vol. 2, Norman G. Gaylord (ed). Interscience Publishers, New York, New York. p. 802.

Meltzer, Yale L. Foamed Plastics, Recent Developments. Noyes Data Corporation, Park Ridge, New Jersey, 1976.

Metcalf & Eddy, Inc. Wastewater Engineering: Treatment, Disposal, Reuse, Second Edition. McGraw-Hill Book Company, New York, New York, 1979.

Milby, R. V. Plastics Technology. McGraw-Hill Book Company, New York, New York, 1973.

Mock, John A. "Additives 1982 - A Multiplicity of Problem Solvers." Plastics Engineering, 38(6):29, 1982.

Monroe, Sam. "Bag Molding." Encyclopedia of Polymer Science and Technology, Vol. 2, Norbert M. Bikales (ed). Interscience Publishers, New York, New York. pp. 300-316.

Morneau, G. A., W. A. Pavelich, and L. G. Roeltger. "Acrylonitrile Polymers (ABS)." Kirk-Othmer Encyclopedia of Chemical Technology, 3rd Edition, Vol. 1, Martin Grayson (ed). John Wiley and Sons, New York, New York. pp. 442-456.

Morin, Richard and Thomas Tomaszek. "Granulators." Modern Plastics Encyclopedia, 1981-1982. McGraw-Hill, Inc., New York, New York, 1981. p. 307.

Myers, Lloyd W. "Wire and Cable Coverings." Encyclopedia of Polymer Science and Technology, Vol. 14, Norbert M. Bikales (ed). Interscience Publishers, New York, New York. pp. 796-805.

Nass, Leonard I. Encyclopedia of PVC, Volumes 1, 2, and 3. Marcel Dekker, Inc., New York, New York, 1977.

Nass, Leonard I. "Heat Stabilizers." Kirk-Othmer Encyclopedia of Chemical Technology, 3rd Edition, Vol. 12, Martin Grayson (ed). John Wiley and Sons, New York, New York. pp. 225-249.

National Sanitation Foundation. Wastewater Technology, Report No. S-40-1, October 1972.

National Sanitation Foundation. Wastewater Technology, Report No. S-40-5, April 1974.

National Sanitation Foundation. Wastewater Technology, Report No. S-40-6, April 1974.

National Sanitation Foundation. Wastewater Technology, Report No. S-40-7, August 1979.

National Sanitation Foundation. Wastewater Technology, Report No. S-40-8, June 1979.

National Sanitation Foundation. Wastewater Technology, Report No. S-40-9, August 1979.

National Sanitation Foundation. Wastewater Technology, Report No. S-40-10, November 1981.

National Sanitation Foundation. Wastewater Technology, Report No. S-40-11, May 1982.

Nelson, W. L. Petroleum Refinery Engineering, Fourth Edition. McGraw-Hill Book Company, New York, New York, 1958.

Nicholas, Paul P., Anthony M. Luxeder, Lester A. Brooks, and Paul A. Hammes. "Antioxidants and Antiozonants." Kirk-Othmer Encyclopedia of Chemical Technology, 3rd Edition, Vol. 3, Martin Grayson (ed). John Wiley and Sons, New York, New York. pp. 128-149.

National Institute for Occupational Safety and Health (NIOSH). Criteria for a Recommended Standard...Occupational Exposure to Fibrous Glass. NIOSH Publications, Washington, D.C., 1977.

NIOSH. Health and Safety Guide for Plastics Fabricators. NIOSH, Cincinnati, Ohio, 1975.

Occupational Safety and Health Administration (OSHA)/NIOSH. Occupational Health Guidelines for Chemical Hazards. NIOSH Publications, Washington, D.C., 1981.

Nissel, F. R. "Extruding Thermoplastic Foams." Modern Plastics Encyclopedia, 1981-1982. McGraw-Hill, Inc., New York, New York, 1981. p. 296.

Noyes Data Corporation. Polymer Additives: Guidebook and Directory. Noyes Data Corporation, Park Ridge, New Jersey, 1972.

O'Brien, J. C. "Transfer Molding." Modern Plastics Encyclopedia, 1981-1982. McGraw-Hill, Inc., New York, New York, 1981. p. 424.

Olabisi, Olagoke. "Polyblends." Kirk-Othmer Encyclopedia of Chemical Technology, 3rd Edition, Vol. 18, Martin Grayson (ed). John Wiley and Sons, New York, New York. pp. 443-478.

Oleesky, Samuel S. and J. Gilbert Mohr. Handbook of Reinforced Plastics. Reinhold Publishing Corporation, New York, New York, 1964.

Paschke, Eberhard. "Ziegler Process Polyethylene." Kirk-Othmer Encyclopedia of Chemical Technology, 3rd Edition, Vol. 16, Martin Grayson (ed). John Wiley and Sons, New York, New York. pp. 433-452.

Pedersen, K. W. "Injection Molding." Modern Plastics Encyclopedia, 1981-1982. McGraw-Hill, Inc., New York, New York, 1981. p. 315.

Peebles, L. H., Jr. "Acrylonitrile Polymers Degradation." Encyclopedia of Polymer Science and Technology, Supplement Vol. 1, Norbert M. Bikales (ed). Interscience Publishers, New York, New York. pp. 1-25.

Peerman, D.E. "Polyamides From Fatty Acids." Encyclopedia of Polymer Science and Technology, Vol. 10, Norbert M. Bikales (ed). Interscience Publishers, New York, New York. pp. 597-615.

Penn, W. S. PVC Technology, 3rd Edition. Applied Science Publishers, Ltd., London, England, 1971.

Perkins, N. A. (ed). Plastics and Plastics Additives. Proceeding of the Third International Research Association in Conjunction with CMRA, Devonshire House, London, 15-17 June 1970.

Perry, Robert H. and Cecil H. Chilton. Chemical Engineers' Handbook, Fifth Edition. McGraw-Hill Book Company, New York, New York, 1973.

Peters, Max S., Klaus D. Timmerhaus. Plant Design and Economics for Chemical Engineers, Third Edition. McGraw-Hill Book Company, New York, New York, 1980.

"Phthalates are Alive but Being Watched." Chemical Week, 128(25):18, 1981.

"Plasticizers - Where Do We Go From Here?." Plastics Engineering, 36(4):35, 1980.

Postans, J. H. Plastics Molding. Oxford University Press, New York, New York, 1978.

"Prize Winning Structural Foam Applications." Modern Plastics, 56(7):52, 1979.

Power, G. E. "Laminates." Encyclopedia of Polymer Science and Technology, Vol. 8, Norbert M. Bikales (ed). Interscience Publishers, New York, New York. pp. 121-163.



Rauch, James A. The Kline Guide to the Plastics Industry. Charles A. Kline & Co., Fairfield, New Jersey, 1978.

Rebenfeld, Ludwig. "Fibers." Encyclopedia of Polymer Science and Technology, Vol. 6, Norbert M. Bikales (ed). Interscience Publishers, New York, New York. pp. 505-572.

Reed, George V. "Improving PP with Phosphite Stabilizers." Modern Plastics, 56(11):26, 1979.

Reinhart, F. W. "Pipe." Encyclopedia of Polymer Science and Technology, Vol. 10, Norbert M. Bikales (ed). Interscience Publishers, New York, New York. pp. 219-228.

Resing, Tom. "Dry Solids Mixers." Modern Plastics Encyclopedia, 1981-1982. McGraw-Hill, Inc., New York, New York, 1981. p. 363.

Richardson Engineering Services, Inc. Process Plant Construction Estimating Standards, Volumes 1-4. Solana Beach, California, 1981.

Richardson, Paul N. "Plastics Processing." Kirk-Othmer Encyclopedia of Chemical Technology, 3rd Edition, Vol. 18, Martin Grayson (ed). John Wiley and Sons, New York, New York. pp. 184-206.

Richardson, R. J. and O. E. Snider. "Polyamide Fibers." Encyclopedia of Polymer Science and Technology, Vol. 10, Norbert M. Bikales (ed). Interscience Publishers, New York, New York. pp. 347-444.

Ritchie, P. D., Stuart W. Critchley and Allan Hill. Plasticizers, Stabilizers and Fillers. The Plastics Institute, London, 1972.

Robinson, J. S. Spinning, Extruding, and Processing of Fibers: Recent Advances. Noyes Data Corporation, Park Ridge, New Jersey, 1980.

Rodriquez, F. Principles of Polymer Systems. McGraw-Hill, Inc., New York, New York, 1970.

Rosato, D. V. "Filament Winding." Encyclopedia of Polymer Science and Technology, Vol. 6, Norbert M. Bikales (ed). Interscience Publishers, New York, New York. pp. 713-740.

Rosen, S. L. Fundamental Principles of Polymeric Materials. Manuscript, Carnegie-Mellon University, Pittsburgh, Pennsylvania, 1979. Chapter 19.

Rosenzweig, Mark D. "Motionless Mixers Move Into New Processing Roles." Chemical Engineering, 84(10):95, 1977.

Rubin, I. I. Injection Molding, Theory and Practice. John Wiley and Sons, New York, New York, 1973.

"Safety and Health Regulations: Government vs. Plastics Processors - An Assessment." Plastics Technology, 25(13):43, 1979.

Saunders, J. H. "Polyamides (Fibers)." Kirk-Othmer Encyclopedia of Chemical Technology, 3rd Edition, Vol. 18, Martin Grayson (ed). John Wiley and Sons, New York, New York. pp. 372-405.

Scharnberg, John. "Decorating." Encyclopedia of Polymer Science and Technology, Vol. 14, Norbert M. Bikales (ed). Interscience Publishers, New York, New York. pp. 605-619.

Schott, N. R., B. Weinstein and D. LaBombard. "Motionless Mixers." Chemical Engineering Progress, 71(1):54, 1975.

Schwartz, Seymour S. and Sidney H. Goodman. Plastics Material and Processes. Van Nostrand Reinhold Company, Inc., New York, New York, 1982.

Sears, J. K. and N. W. Touchette. "Plasticizers." Kirk-Othmer Encyclopedia of Chemical Technology, 3rd Edition, Vol. 18, Martin Grayson (ed). John Wiley and Sons, New York, New York. pp. 111-183.

Seymour, Raymond B. (ed). Additives for Plastics. State of the Art. Academic Press, New York, New York, 1978.

Sherman, Stanley, John Gannon, Gordon Buchi, and W. R. Howell. "Epoxy Resins." Kirk-Othmer Encyclopedia of Chemical Technology, 3rd Edition, Vol. 9, Martin Grayson (ed). John Wiley and Sons, New York, New York. pp. 267-290.

Short, James N. "Low Pressure Linear (Low Density) Polyethylene." Kirk-Othmer Encyclopedia of Chemical Technology, 3rd Edition, Vol. 16, Martin Grayson (ed). John Wiley and Sons, New York, New York. pp. 385-401.

Shreve, R. N. and J. A. Brink, Jr. Chemical Process Industries, 4th Edition. McGraw Hill, Inc., New York, New York, 1977.

Sweeney, F. M. Introduction to Reaction Injection Molding. TECHNOMIC Publishing Co., Inc., Westport, Connecticut, 1979.

TECHNOMIC. Flexible Urethane Foam Technology. TECHNOMIC Publishing Co., Westport, Connecticut, 1974.

Thompson, D. C. and A. L. Barney. "Vinylidene Polymers (Fluoride)." Kirk-Othmer Encyclopedia of Chemical Technology, 2nd Edition, Vol. 21, Anthony Standen (ed). John Wiley and Sons, New York, New York. pp. 269-275.

Tickle, J. D. "Pultrusion." Modern Plastics Encyclopedia, 1981-1982. McGraw-Hill, Inc., New York, New York, 1981. p. 398.

"Toxic Curbs: A Pro-Industry Tilt." Business Week, September 7, 1981, p. 92.

Updegraff, Ivor H., Sewell T. Moore, William F. Herbes, and Philip B. Roth. "Amino Resins and Plastics." Kirk-Othmer Encyclopedia of Chemical Technology, 3rd Edition, Vol. 2, Martin Grayson (ed). John Wiley and Sons, New York, New York. pp. 440-469.

U.S. Department of Commerce, Bureau of the Census. Water Use in Manufacturing, 1977 Census of Manufacturers. 1981.

U.S. EPA. Contractors Engineering Report, Analysis of Organic Chemicals and Plastics/Synthetic Fibers Industries Toxic Pollutants. Contract No. 68-01-6024, November 1981.

U.S. EPA. Carbon Adsorption Isotherms for Toxic Organics. EPA 600/8-80-023, April 1980.

U.S. EPA. Design Manual On-Site Wastewater Treatment and Disposal Systems. EPA-625/1-80-012, October 1980.

U.S. EPA. Development Document for Effluent Guidelines and Standards for the Nonferrous Metals Manufacturing Point Source Category Phase II, July 1984.

U.S. EPA. Industrial Process Profiles for Environmental Use: Chapter 13. Plasticizers Industry. U.S. Environmental Protection Agency, Cincinnati, Ohio, 1977.

U.S. EPA, Draft Report, prepared by P. W. Spaite, G. E. Wilkins, and Radian Corporation. Plastics Industry Analysis. Environmental Protection Agency, Cincinnati, Ohio, 1979.

U.S. EPA, Effluent Guidelines Division. Development Document for Proposed Effluent Limitations Guidelines and New Source Performance Standards for the Synthetic Polymer Segment of the Plastics and Synthetic Materials Manufacturing Point Source Category. U.S. Environmental Protection Agency, Washington, D.C., September 1974.

U.S. EPA, Effluent Guidelines Division. Development Document for Proposed Effluent Limitations Guidelines and New Source Performance Standards for the Organic Chemicals, Plastics, and Synthetics Fibers Point Source Category, Volumes I, II, and III. EPA 440/1-83-009b, February 1983.

U.S. EPA. Estimating Water Treatment Costs, Volumes 1-3. EPA-600/2-79-162, August 1979.

U.S. EPA. Fate of Priority Pollutants in Publicly Owned Treatment Works, Volume I. EPA 440/1-82/303, September 1982.

U.S. EPA. Fate of Priority Pollutants in Publicly Owned Treatment Works 30-Day Study. EPA 440/1-82/302, July 1982.

U.S. EPA. Innovative and Alternative Technology Assessment Manual. EPA 430/9-78-009, February 1980.

U.S. EPA. Treatability Manual, Volume III, Technologies for Control/Removal of Pollutants. EPA 600/8-80-842c, July 1980.

U.S. EPA. Treatability of Organic Priority Pollutants - Part C - Their Estimated (30-Day Ave.) Treated Effluent Concentrations - A Molecular Engineering Approach. Murray P. Strier. 11 July 1978.

U.S. EPA. Treatability of Organic Priority Pollutants - Part D - The Pesticides - Their Estimated (30-Day Ave.) Treated Effluent Concentrations. Murray P. Strier, 26 December, 1978.

Wallis, Benedict L. "Casting." Encyclopedia of Polymer Science and Technology, Vol. 3, Herman F. Mark (ed.). Interscience Publishers, New York, New York, pp. 1-20.

Water Purification Association. Conceptual Designs for Water Treatment in Demonstration Plants. Department of Energy Report EF-77-C-01-2635, 1977.

Webber, T. G. "Colorants for Plastics." Kirk-Othmer Encyclopedia of Chemical Technology, 3rd Edition, Vol. 6, Martin Grayson (ed). John Wiley and Sons, New York, New York. pp. 597-617.

Webber, T. G. Coloring of Plastics. John Wiley and Sons, New York, New York, 1979.

Weir, C. L. Introduction to Injection Molding. Society of Plastics Engineers, Greenwich, Connecticut, 1975.

Welgos, R. J. "Polyamides (Plastics)." Kirk-Othmer Encyclopedia of Chemical Technology, 3rd Edition, Vol. 18, Martin Grayson (ed). John Wiley and Sons, New York, New York. pp. 406-425.

Wessling, R. A. and F. G. Edwards. "Vinylidene Chloride Polymers." Encyclopedia of Polymer Science and Technology, Vol. 14, Norbert M. Bikales (ed). Interscience Publishers, New York, New York. pp. 540-579.

Wessling, R. A. and F. G. Edwards. "Poly(Vinylidene Chloride)." Kirk-Othmer Encyclopedia of Chemical Technology, 2nd Edition, Vol. 21, Anthony Standen (ed). John Wiley and Sons, New York, New York. pp. 275-303.

Westover, R. F. "Melt Extrusion." Encyclopedia of Polymer Science and Technology, Vol. 8, Norbert M. Bikales (ed). Interscience Publishers, New York, New York. pp. 533-587.

Wetzel, D. R. "New Developments in Reinforced Thermoplastics." Reinforced Plastics Conference. El Segundo, California, December 1980.

White, J. S. "Continuous RP Laminating." Modern Plastics Encyclopedia, 1981-1982. McGraw-Hill, Inc., New York, New York, 1981. p. 393.

Wilson, David C., Peter J. Young, Brinley C. Hudson, and Grant Baldwin. "Leaching of Cadmium from Pigmented Plastics in a Landfill Site." Environmental Science and Technology, September 1982, p. 560.

Wiman, J. V. "Expandable Polystyrene Molding." Modern Plastics Encyclopedia, 1981-1982. McGraw-Hill, Inc., New York, New York, 1981. p. 296.

Wolinski, L. E., "Films and Sheeting." Encyclopedia of Polymer Science and Technology, Vol. 6, Norbert M. Bikales (ed). Interscience Publishers, New York, New York. pp. 764-794.

Woolrich, Paul F. "Precautions in the Use of Urethane Materials." Plastics Compounding, 2(3):88, 1979.

## SECTION XVII

### GLOSSARY

This section contains the definitions of the technical terms used in this document. Table XVII-1 lists some common plastic polymers and their uses and properties.

#### Acidity

The acidity of water is its quantitative capacity to react with a strong base to a designated pH. Various materials may contribute to the measured acidity depending on the method of determination. These materials include strong mineral acids, weak acids such as carbonic and acetic acids, and hydrolyzing salts such as ferrous or aluminum sulfates.

#### Alkalinity

Alkalinity of a water is its quantitative capacity to react with a strong acid to a designated pH. It is an indication of the concentration of carbonate, bicarbonate, and hydroxide ions present in the water.

#### Analytical Quantification Limit

The minimum concentration at which a pollutant can be accurately measured. It is also known as the method detection limit.

#### Average Process Water Usage Flow Rate

The average process water usage flow rate of a process in liters per day is equal to the volume of the process water (liters) used per year by a process divided by the number of days per year the process operates. The average process water usage flow rate for a plant with more than one plastics molding and forming process in a subcategory is the sum of the average process water usage flow rates for those plastics molding and forming processes.

#### Batch Treatment

Batch treatment is a waste treatment method where wastewater is collected over a period of time and then treated prior to discharge. Collection may be continuous even though treatment is not. Batch treatment may be used because the processes generating wastewater are operated on a batch operation mode, or the treatment system may be oversized for the amount of wastewater generated.

Table XVII-1

THE GLASS TRANSITION AND MELTING TEMPERATURES OF SOME COMMON POLYMERS,  
AND THEIR MAIN USES\*

<u>Polymer</u>	<u>Repeat Unit</u>	<u>Abbreviation</u>	<u>T<sub>g</sub></u> (°C)	<u>T<sub>m</sub></u> (°C)	<u>Main Uses</u>
Linear polyethylene	$(-\text{CH}_2-\text{CH}_2-)$	HDPE	-110	134	Extruded and injection molded articles, bottles, and containers
Branched polyethylene	$(-\text{CH}_2-\text{CH}_2-)$	LDPE	-110	115	Flexible packaging film; flexible extruded and molded articles
Polystyrene	$(-\text{CH}_2-\underset{\text{C}_6\text{H}_5}{\text{CH}}-)$	PS	90-100	---	Extruded and molded articles that are transparent; foamed articles
Polyvinylchloride	$(-\text{CH}_2-\underset{\text{Cl}}{\text{CH}}-)$	PVC	87	---	Extruded rigid or plasticized articles, tubes, sheets, profiles
Polypropylene	$(-\text{CH}_2-\underset{\text{CH}_3}{\text{CH}}-)$	PP	-10	165	Extruded and molded articles that are rigid
Nylon 6-6	$(-\underset{\text{H}}{\text{N}}-(\text{CH}_2)_6-\overset{\text{H}}{\text{N}}-\overset{\text{O}}{\parallel}{\text{C}}-(\text{CH}_2)_4-\overset{\text{O}}{\parallel}{\text{C}}-)$	--	50	240	Fibers; molded and extruded rigid articles
Polyethylene terephthalate	$(-\text{O}-(\text{CH}_2)_2-\text{O}-\overset{\text{O}}{\parallel}{\text{C}}-\text{C}_6\text{H}_4-\overset{\text{O}}{\parallel}{\text{C}}-)$	PET	70	260	Fibers and transparent strong films
Polyoximethylene	$(-\overset{\text{H}}{\underset{\text{H}}{\text{C}}}-\text{O}-)$	Acetal	-50	180	Molded "engineering" structural components; tough

Table XVII-1 (Continued)

THE GLASS TRANSITION AND MELTING TEMPERATURES OF SOME COMMON POLYMERS,  
AND THEIR MAIN USES\*

<u>Polymer</u>	<u>Repeat Unit</u>	<u>Abbreviation</u>	<u>T<sub>g</sub></u> (°C)	<u>T<sub>m</sub></u> (°C)	<u>Main Uses</u>
Polycarbonate	$\left( -O-C_6H_4-\underset{\text{CH}_3}{\overset{\text{CH}_3}{\text{C}}}-C_6H_4-O-\overset{\text{O}}{\parallel}{\text{C}}- \right)$	PPO	150	---	Molded tough and transparent articles; structural components
Polymethylmethacrylate	$\left( -CH_2-\underset{\text{C}-O-CH_3}{\overset{\text{CH}_3}{\parallel}} \right)$	PMMA	90-100	---	Cast transparent sheet; molded articles
Polytetrafluoroethylene	$\left( -CF_2-CF_2- \right)$	Teflon, PTFE	125	327	"Extruded" tubes; sintered blocks for machining; tapes; solvent resistant
Polyacrylonitrile	$\left( -CH_2-\underset{\text{CN}}{\text{CH}}- \right)$	PAN	105	>250	High strength fibers
Polyisobutylene	$\left( -CH_2-\underset{\text{CH}_3}{\overset{\text{CH}_3}{\text{C}}}- \right)$	PIB	-70	---	Adhesives, paper coatings; together with isoprene, butyl rubber
Polybutadiene	$\left( -CH_2-CH=CH-CH_2- \right)$	---	-88	---	Styrene-butadiene rubber (SBR); nitrile rubbers (with PAN); oil resistant

\*Table is from Principles of Polymer Processing, Tadmor Z, Gogos C. G., John Wiley and Sons, 1979, pp. 38-39.



### Biological Oxygen Demand (BOD<sub>5</sub>)

The biological oxygen demand test for wastewaters determines the oxygen required for the biochemical degradation of organic material (carbonaceous demand) and the oxygen used to oxidize inorganic material such as sulfides and ferrous iron. The wastewater sample is incubated for a standard period of five days, hence the name BOD<sub>5</sub>.

### Blowing Agent

A blowing agent is the material injected into a plastic material that causes the plastic material to expand with the application of heat. Blowing agents can be gases introduced into the molten plastic or a gas producing compound that is mixed with the polymer before processing.

### Blow Molding

Blow molding expands a parison into a desired shape with compressed air. Hollow, thin-wall objects from thermoplastic resins are formed.

### Calendering Process

The calendering process squeezes pliable thermoplastic between a series of rolls to produce uniform quality polymer film and sheet, to emboss sheet and film, to perform compounding operations, and to coat textiles and papers.

### Casting Process

A casting process forms products by allowing a liquid plastic to cure at atmospheric pressure in a mold or on a mold surface.

### Chemical Oxygen Demand (COD)

The chemical oxygen demand is a measure of the oxygen equivalent of the organic matter in a wastewater sample that is susceptible to oxidation by a strong chemical oxidant.

### Cleaning Process

A cleaning process is a process in which surfaces of plastic products and shaping equipment surfaces that contact the plastic product are washed to remove residual mold release agents and other matter prior to finishing or further processing. A cleaning process contains a detergent wash cycle and a rinse cycle.

### Cleaning Water

Cleaning water is process water used to clean the surfaces of an intermediate or final plastic product or to clean the surfaces of equipment used in plastic molding and forming that contacts an intermediate or final product. It includes water used in both the detergent wash and rinse cycles of a cleaning process.

### Coating Process

A coating process covers objects with a polymer layer that is in the form of a melt, liquid, or finely divided powder. These objects that are coated include other plastic materials, metal, wood, paper, fabric, leather, glass, concrete, and ceramics.

### Compounding

Compounding is the plastics processing step where a plastic resin is mixed with additives or fillers.

### Compression Molding

Compression molding shapes a measured quantity of plastic within a mold by applying heat and pressure to form products with large surface areas and relatively simple shapes.

### Contact Cooling and Heating Water

Contact cooling and heating water is process water that contacts the raw materials or plastic product for the purpose of heat transfer during plastic molding and forming.

### Conventional Pollutants

Conventional pollutants are the pollutants defined in Section 304(a)(4) of the Clean Water Act. They include biological oxygen demand, oil and grease, suspended solids, fecal coliform, and pH.

### Cooling Trough

A cooling trough is a long open box-like container that holds water to quench a processed plastic product. It is commonly used to contact cool extruded strands before they are pelletized and to cool extruded pipe.

### Crude Intermediate Plastic Material

Crude intermediate plastic material is plastic material formulated in an on-site polymerization process.

### Direct Discharger

A direct discharger is an industrial water user that discharges wastewater directly to a navigable stream.

### Dry Process

A dry process is a process that uses no process water or uses only non-contact cooling water.

### Effluent

Effluent is the discharge from a point source after treatment.

### End-of-Pipe Treatment

End-of-pipe treatment is the treatment given wastewater before the wastewater is discharged.

### Extrusion Process

Extrusion is a process that forces molten polymer under pressure through a shaping die to produce products of uniform cross-sectional area such as pipe, tubing, sheet, and film.

### Filler

A filler is a material that when added to a plastic may reduce the end product cost by occupying a fraction of the volume of the plastic product. It may also act as a speciality additive to improve the final product.

### Finishing Process

A finishing process renders the plastic parts useful. There are three types of finishing processes: machining, decorating, and assembling.

### Finishing Water

Finishing water is process water used to remove waste plastic material generated during a finishing process or to lubricate a plastic product during a finishing process. It includes water used to machine and to assemble intermediate or final plastic products.

### Foaming Agent

A foaming agent is a gas producing compound added to a polymer that causes the polymer to foam when the gas is liberated by the addition of heat or a reduction in pressure.

### Foaming Process

A foaming process injects a blowing or foaming agent into a thermoplastic or thermoset to form a sponge-like material.

### Glass Transition Temperature

The temperature at which a polymer changes from a brittle glassy solid to a rubber-like substance.

### Indirect Discharger

An indirect discharger is an industrial source that discharges wastewater to a publicly owned treatment works.

### Influent

Influent is water used in a PM&F process. It can be the source water for a plant or the source water combined with recycled water.

### Injection Molding

Injection molding forms intricate plastic parts by forcing a heated plastic material into a mold cavity.

### In-Process Control Technology

In-process control technology is the conservation of water throughout the production processes to reduce the amount of wastewater discharged.

### Integrated Plant

An integrated plant is a plant that combines process water from all sources in the plant for treatment in a central wastewater treatment system.

### Laminating Process

The laminating process combines layers of plastic materials with other materials through high pressure. These structures are formed from layers of resins and fillers bonded together as a unit with the resin used as a reinforcing agent.

### Mass of Pollutant That Can Be Discharged

The mass of pollutant that can be discharged is the pollutant mass calculated by multiplying the allowable pollutant effluent concentration times the average process water usage flow rate.

### Melt Temperature

The temperature at which a polymer becomes fluid.

### Monomer

A monomer is a chemical compound that during a polymerization process becomes a repeating link in the polymer chain.

### New Source Performance Standards (NSPS)

NSPS for new industrial direct dischargers as defined by Section 306 of the Clean Water Act are based on the best available demonstrated technology.

### Nonconventional Pollutants

Nonconventional pollutants include pollutants that are not designated as either conventional pollutants or priority toxic pollutants.

### Oil and Grease

Oil and grease are materials that are soluble in trichlorotrifluoroethane. They include nonvolatilized materials such as hydrocarbons, fatty acids, soaps, fats, waxes, and oils.

### Parison

A parison is a preshaped sleeve usually made by extrusion. This sleeve is an intermediate product often used as the starting material for the blow molding process.

### Pelletizing

Pelletizing is a process by which long extruded strands are cut into pellets. These pellets are an intermediate product which can be the feed material for other plastic molding and forming processes.

### pH

pH is the negative logarithm of the hydronium ion concentration. Values below seven represent an acid environment; a value of seven represents a neutral environment; and values greater than seven are indicative of a basic environment.

### Pigments

A pigment is a compound that when well mixed with a polymer imparts color to the polymer. To impart color, the pigment must absorb light in the visible wavelength range.

## Plastic Material

A plastic material is a synthetic organic polymer (i.e., a thermoset polymer, a thermoplastic polymer, or a combination of a natural polymer and a thermoset or thermoplastic polymer) that is solid in its final form and that was shaped by flow. The material can be either a homogeneous polymer or a polymer combined with fillers, plasticizers, pigments, stabilizers, or other additives.

## Plasticization - Internal

A copolymerization process by which a chain is made more flexible. The chain's rigidity is caused by steric factors.

## Plasticizer - External

An external plasticizer is usually a monomeric molecule that when mixed with polar or hydrogen bonded polymer results in increasing the flexibility of the rigid polymer.

## Plastics Molding and Forming (PM&F) Processes

Plastic molding and forming processes are a group of manufacturing processes in which plastic materials are blended, molded, formed, or otherwise processed into intermediate or final plastic products.

## Plastisol

A plastisol is a low viscosity system of dispersed polyvinyl chloride (PVC) in a plasticizer.

## PM&F Category

Throughout this document, the PM&F abbreviation stands for the Plastics Molding and Forming category.

## Pollutant Concentration

A measure of the mass of pollutant per volume of wastewater. Commonly used units are milligrams per liter.

## Pollutant Effluent Limitations Guidelines

The pollutant effluent limitations guidelines is the mass of pollutant allowed to be discharged per unit of time. For the PM&F category, typical units are milligrams of pollutant per day. The pollutant mass is calculated by multiplying the effluent concentration times the average process water usage flow rate.

### Polymer

A polymer is a macromolecule comprised of linked together repeating monomers. These macromolecules have molecular weights in the range of  $10^4$  to  $10^7$ .

### Polymerization

Polymerization is the chemical reaction that produces a polymer.

### Priority Toxic Pollutants

Priority toxic pollutants are toxic pollutants selected for study from 65 compounds and classes of compounds Congress declared toxic under Section 307(a) of the Clean Water Act.

### Process Water

Process water is any raw, service, recycled, or reused water that contacts the plastic product or contacts shaping equipment surfaces such as molds and mandrels that are, or have been, in contact with the plastic product.

### Publicly Owned Treatment Works (POTW)

A POTW is a wastewater treatment facility owned by a state or municipality.

### Reaction Injection Molding (RIM)

A RIM process simultaneously injects two or more reactive liquid streams at high pressure into a mixing chamber and then injects the plastic at a lower pressure into the mold cavity.

### Recycle

Recycle is a water-saving technology that returns process water that has been used in a process to that process.

### Regrind

Regrind is processed plastic that is scrapped and mixed with pure plastic and reprocessed.

### Reinforcing Agent

A reinforcing agent primarily improves the strength and stiffness of the base polymer.

## Resin

A resin is the homogeneous polymer that forms the basis of a plastic product. The resin does not include fillers, plasticizers, pigments or stabilizers.

## Rotational Molding

A rotational molding process rotates a polymer powder or liquid inside a large, heated mold to form hollow objects from thermoplastic materials.

## Sprue

The sprue is the entrance into the mold through which the plastic flows.

## Stabilizer

A stabilizer is a compound that when added to a polymer protects it from heat, light, or oxygen.

## Thermoforming Process

A thermoforming process heats a thermoplastic sheet or film to a pliable state and forces it around the contours of a mold. Vacuum, air pressure, or mechanical force form the molten sheet to the mold.

## Thermoplastic Polymer

A thermoplastic polymer is a linear molecule that can melt and flow with the addition of heat and pressure.

## Thermoset Polymer

A thermoset polymer has crosslinks throughout the chain making it stable to heat. The polymer will not melt or flow with heat.

## Total Organic Carbon (TOC)

TOC is a measure of the organic material in a wastewater and is determined by oxidizing the organic material to carbon dioxide.

## Total Phenols

Phenols are hydroxy derivatives of benzene.

## Total Suspended Solids (TSS)

TSS is a measure of the solids in wastewater.



### Transfer Molding

Transfer molding uses a preheated plastic material and moves it into the mold cavity with pressure through a sprue. It is similar to injection molding.

### Treatability Limit

The treatability limit is the lowest concentration of a pollutant achievable by a wastewater treatment process.

### Volume of Process Water Used Per Year

The volume of process water used per year is the volume of process water that flows through a process and comes in contact with the plastic product over a period of one year.

### Wastewater Discharged

Wastewater discharged is process water from a PM&F process that is discharged to a navigable stream or a POTW.

### Water Quench

A water quench is a contact water cooling bath used to quickly cool a material. It is often used in extrusion and injection molding to cool the products.

### Water Used

Water used is water that contacts the plastic material or product. This includes any recycle and makeup water.

### Wet Process

A wet process is a process in which the plastic product comes into direct contact with water.

### Zero Discharger

A zero discharger is any industrial water user that does not discharge wastewater.

APPENDIX A  
SAMPLING DATA

APPENDIX A  
SAMPLING DATA

This appendix presents the daily concentration data for the 18 PM&F plants sampled for the final PM&F regulation. Table A-1 lists the data for the contact cooling and heating water subcategory; Table A-2 lists the data for the cleaning water subcategory; and Table A-3 presents the data for the finishing water subcategory. The concentration values for the source water sample, for process samples collected on days one, two, and three and for the duplicate samples listed in Tables A-1, A-2, and A-3 were used to develop the average concentrations presented in Table VI-19.

Processes from Plant K in Tables A-1 and A-2 have two source water concentrations listed. The first value listed represents the concentration of a make-up water flow and the second value represents a recirculated water flow to the process. Some pollutants for process K-4 from Plant K have two concentration values listed under each sampling day. The first concentration is from an unpreserved sample and the second listed value is from a preserved sample.

Wastewater treatment processes that treat primarily PM&F process waters were sampled at one plant (i.e., Plant I) in 1980. Tables A-4 and A-5 present influent and effluent data for two treatment processes at that plant (see Figure VI-9). Wastewater treatment processes that treat primarily PM&F process waters were also sampled at three plants in 1984. Refer to Tables A-6, A-7, and A-8 for influent and effluent data for these treatment processes at plants M, N, and R, respectively (see Figures VI-12, VI-13, and VI-17).

Table A-9 presents solution casting solvent recovery sampling data for Plant G. Data presented in Table A-9 may be used as a guide by the permit writer to write permits for the solvent recovery wastewater. This wastewater is not regulated by the plastics molding and forming effluent limitations guidelines and standards.

Table A-1

SAMPLING DATA BY POLLUTANT FOR  
CONTACT COOLING AND HEATING WATER SUBCATEGORY  
(RAW WASTEWATER)

<u>Pollutant</u>	<u>Process Code§</u>	<u>Sample Type†</u>	<u>Source</u>	<u>Concentrations (mg/l)</u>			<u>Duplicate</u>
				<u>Day 1</u>	<u>Day 2</u>	<u>Day 3</u>	
<u>Conventional Pollutants</u>							
biological oxygen demand (BOD <sub>5</sub> )	B-1	1	<5	<5			
	B-2	1	<5	<5			
	B-4	1	<5	<5			<5
	C-1	1	83.8	96.9	84.8	90.9	
	D-3	1	NA	NA			
	E-2	1	5.0	9.4	8.9	4.1	
	E-3	1	5	7.6	3.9	0.5	
	F-1	1	2	10	8	10	
	F-2	1	2	8	7	7	
	F-6	1	2		5	3	
	G-1	3	<5	††	††		
	J-1	2	<5	<5			
	J-2	2	<5	56			52
	K-2	3/1	<5/<5	<5	<5	<5	
	K-3	3/1	<5/<5	<5	<5	<5	<5
	K-4	3/1	<5/<5	<5	<5	<5	
	M-1	1	38	130			
	M-2	1	18	18			
	N-2	1	5.0	10			
	N-3	2	5.0		6		
O-1	2	NA	NA				
O-2	2	NA	NA				
P-1	2	8.5	2.3				
R-1	2	4	6				
R-2	2	4	4				

Table A-1 (Continued)  
 SAMPLING DATA BY POLLUTANT FOR  
 CONTACT COOLING AND HEATING WATER SUBCATEGORY  
 (RAW WASTEWATER)

Pollutant	Process Code\$	Sample Type†	Source	Concentrations (mg/l)			Duplicate
				Day 1	Day 2	Day 3	
<u>Conventional Pollutants (Continued)</u>							
oil and grease	B-1	2	<4	<4			
	B-2	2	<4	<4			
	B-4	2	<4	4			10
	C-1	1	17.0	75.0	24.5	41.0	
	D-3	2	<4	<4			<4
	E-2	1	19.6	16.8	23.8	11.8	
	E-3	1	19.6	20.0	27.8	19.4	
	F-1	1	3	1	0	4	
	F-2	1	3	3	0	5	
	F-6	1	3	3	5	4	
	G-1	2	6	<4	4		
	J-1	2	<4	11			
	J-2	2	<4	73			49
	K-2	2	<4/<4	<4	<4	<4	
	K-3	2	<4/<4	<4	<4	<4	<4
	K-4	2	<4/<4	<4	<4	<4	
	M-1	1	<1	31			
	M-2	1	74	29			
	N-2	1	<1	5			
	N-3	1	<1		3		
	O-1	1	9	5			
	O-2	1	9	3			
	P-1	1	3	3			
R-1	1	7	6				
R-2	1	7	8				

A-3

Table A-1 (Continued)

SAMPLING DATA BY POLLUTANT FOR  
CONTACT COOLING AND HEATING WATER SUBCATEGORY  
(RAW WASTEWATER)

Pollutant	Process Code	Sample Type	Source	Concentrations (mg/l)			Duplicate
				Day 1	Day 2	Day 3	
<u>Conventional Pollutants (Continued)</u>							
pH	B-1	1	5.6	5.7			
	B-2	1	5.6	5.5			
	B-4	1	5.6	5.8			5.8
	C-1	3	5.8	5.4	6.65	6.0	
	D-3	1	7.3	7.8			
	E-2	3	6.55	6.5	6.6	6.5	
	E-3	3	6.55	6.35	6.51	6.41	
	F-1	3	7.6	7.65	7.7	7.65	
	F-2	3	7.6	8.0	7.6	7.55	
	F-6	3	7.6		7.6	7.55	
	G-1	3	7.4	7.7	7.6		
	J-1	2	8.55	8.3			
	J-2	2	8.55	8.2			8.2
	K-2	3	8.0/8.0	8.2	8.3	7.9	
	K-3	3	8.0/8.0	8.0	7.9	8.0	7.9
	K-4	3	8.0/8.0	8.0	7.9	8.0	
	M-1	1	7.57	7.86			
	M-2	1	7.83	7.85			
	N-2	1	8.32	7.19			
	N-3	2	8.32		8.3		
	O-1	2	6.7	6.93			
	O-2	2	6.7	6.69			
	P-1	2	7.51	7.38			
	R-1	2	7.35	7.21			
	R-2	2	7.35	7.36			

Table A-1 (Continued)

SAMPLING DATA BY POLLUTANT FOR  
CONTACT COOLING AND HEATING WATER SUBCATEGORY  
(RAW WASTEWATER)

Pollutant	Process Code§	Sample Type†	Source	Concentrations (mg/l)			Duplicate
				Day 1	Day 2	Day 3	
<u>Conventional Pollutants (Continued)</u>							
total suspended solids (TSS)	B-1	1	<4	<4			
	B-2	1	<4	<4			
	B-4	1	<4	4			<4
	C-1	3	0	104	77.0	18.0	
	D-3	1	<4	<4			<4
	E-2	3	1	3	4	2	
	E-3	3	1	4	2	3	
	F-1	3	2	6	3	5	
	F-2	3	2	<1	2	1	
	F-6	3	2	2	1	<1	
	G-1	3	16	22	4		
	J-1	2	<4	4			
	J-2	2	<4	36			38
	K-2	3	<4/6	6	4	<4	
	K-3	3	<4/<4	<4	<4	<4	<4
	K-4	3	<4/4	4	<4	4	
	M-1	1	<1	5			
	M-2	1	9	4			
	N-2	1	3	<1			
	N-3	2	3		<1		
O-1	2	<1	<1				
O-2	2	<1	<1				
P-1	2	<1	2				
R-1	2	<1	<1				
R-2	2	<1	<1				

Table A-1 (Continued)

SAMPLING DATA BY POLLUTANT FOR  
CONTACT COOLING AND HEATING WATER SUBCATEGORY  
(RAW WASTEWATER)

Pollutant	Process Code§	Sample Type†	Source	Concentrations (mg/l)			Duplicate
				Day 1	Day 2	Day 3	
<u>Nonconventional Pollutants</u>							
aluminum	B-1	1	0.100	0.800			
	B-2	1	0.100	ND			
	B-4	1	0.100	0.500			
	C-1	3	ND	0.310	0.200	0.041	
	D-3	1	0.11	0.073			
	E-2	3	0.155	0.047	0.126	0.036	
	E-3	3	0.155	0.040	0.022	ND	
	F-2	3	ND	ND	ND	ND	
	F-1	3	ND	ND	ND	ND	
	F-6	3	ND	ND	ND	ND	
	G-1	3	ND	0.662	0.513		
	J-1	2	ND	0.163			
	J-2	2	ND	0.235			
	K-2	3/1	ND/0.200	0.100	0.100	0.100	
	K-3	3/1	ND/ND	ND	ND	ND	
	K-4	3/1	ND/0.1	ND	ND	0.1	
ammonia nitrogen	B-1	1	0.06	0.06			
	B-2	1	0.06	<0.05			
	B-4	1	0.06	<0.05			<0.05
	C-1	3	0	0	8.4	1.68	
	D-3	1	<0.05	<0.05			<0.05
	E-2	3	<0.05	<0.05	<0.05	0.09	
	E-3	3	<0.05	0.39	<0.05	<0.05	
	F-1	3	3.3	0.61	3.1	1.1	
	F-2	3	3.3	1.1	2.4	0.7	
	F-6	3	3.3	3.3	6.4	1.8	
	G-1	3	<0.05	<0.05	<0.05		
	J-1	2	<0.05	0.05			
	J-2	2	<0.05	0.05			0.05
	K-2	3	<0.05/0.24	0.10	0.12	0.14	
	K-3	3	<0.05/<0.05	<0.05	<0.05	<0.05	<0.05
	K-4	3	<0.05/<0.05	<0.05	<0.05	<0.05	



Table A-1 (Continued)

SAMPLING DATA BY POLLUTANT FOR  
CONTACT COOLING AND HEATING WATER SUBCATEGORY  
(RAW WASTEWATER)

Pollutant	Process Codes	Sample Type	Source	Concentrations (mg/l)			Duplicate
				Day 1	Day 2	Day 3	
<u>Nonconventional Pollutants</u> (Continued)							
barium	B-1	1	ND	ND			
	B-2	1	ND	ND			
	B-4	1	ND	ND			
	C-1	3	ND	0.190	0.180	0.180	
	D-3	1	0.034	0.035			
	E-2	3	0.014	0.020	0.035	0.016	
	E-3	3	0.014	0.014	0.014	0.015	
	F-1	3	0.043	0.063	0.085	0.100	
	F-2	3	0.043	0.052	0.088	0.110	
	F-6	3	0.043		0.14	0.17	
	G-1	3	ND	0.040	0.018		
	J-1	2	0.030	0.012			
	J-2	2	0.030	0.016			
	K-2	3/1	ND/ND	ND	ND	ND	
	K-3	3/1	ND/ND	ND	ND	ND	
K-4	3/1	ND/ND	ND	ND	ND		
boron	B-1	1	ND	ND			
	B-2	1	ND	ND			
	B-4	1	ND	ND			
	C-1	3	ND	ND	ND	0.030	
	D-3	1	0.050	0.038			
	E-2	3	0.207	0.016	0.007	ND	
	E-3	3	0.207	ND	0.013	0.029	
	F-1	3	0.051	0.17	0.13	0.12	
	F-2	3	0.051	0.060	0.110	0.065	
	F-6	3	0.051		0.065	0.047	
	G-1	3	ND	0.103	0.01		
	J-1	2	0.174	0.169			
	J-2	2	0.174	0.150			
	K-2	3/1	ND/ND	ND	ND	ND	
	K-3	3/1	ND/ND	ND	ND	ND	
K-4	3/1	ND/ND	ND	ND	ND		

A-7

Table A-1 (Continued)

SAMPLING DATA BY POLLUTANT FOR  
CONTACT COOLING AND HEATING WATER SUBCATEGORY  
(RAW WASTEWATER)

Pollutant	Process Codes	Sample Type	Source	Concentrations (mg/l)			Duplicate	
				Day 1	Day 2	Day 3		
<u>Nonconventional Pollutants</u> (Continued)								
bromide	B-1	1	<0.4	<0.4				
	B-2	1	<0.4	<0.4				
	B-4	1	<0.4	<0.4			<0.4	
	C-1		NA	NA	NA	NA		
	D-3	1	<0.4	<0.4			<0.4	
	E-2		NA	NA	NA	NA		
	E-3		NA	NA	NA	NA		
	F-1		NA	NA	NA	NA		
	F-2		NA	NA	NA	NA		
	F-6		NA	NA	NA	NA		
	G-1	3	0.56	0.55	0.8			
	J-1	2	<0.4	<0.4				
	J-2	2	<0.4	<0.4			<0.4	
	K-2	3/1	<0.4/<0.4	<0.4	<0.4	<0.4	<0.4	
	K-3	3/1	<0.4/<0.4	<0.4	<0.4	<0.4	<0.4	
	K-4	3/1	<0.4/<0.4	<0.4	<0.4	<0.4	<0.4	
	calcium	B-1	1	2.100	2.900			
		B-2	1	2.1	2.5			
B-4		1	2.100	2.000				
C-1		3	6.840	11.500	11.100	10.400		
D-3		1	21.4	16.1				
E-2		3	9.52	9.39	9.32	8.9		
E-3		3	9.52	9.33	9.32	9.09		
F-1		3	33.2	48.8	73.8	90.7		
F-2		3	33.2	38.1	75.6	93.6		
F-6		3	33.2		87.8	90.8		
G-1		3	0.062	394	406			
J-1		2	25.850	16.400				
J-2		2	25.850	17.900				
K-2		3/1	20.4/23.8	22.2	22.9	25.6		
K-3		3/1	20.4/20.7	20.4	20.9	20.3		
K-4		3/1	20.4/23	19.9	20.8	21.7		

A-9

Table A-1 (Continued)

SAMPLING DATA BY POLLUTANT FOR  
CONTACT COOLING AND HEATING WATER SUBCATEGORY  
(RAW WASTEWATER)

Pollutant	Process Code§	Sample Type†	Source	Concentrations (mg/l)			Duplicate
				Day 1	Day 2	Day 3	
<u>Nonconventional Pollutants (Continued)</u>							
chemical oxygen demand (COD)	B-1	1	<5	<5			
	B-2	1	<5	7			
	B-4	1	<5	<5			<5
	C-1	3	0	377.2	322.4	352.8	
	D-3	1	<5	10			14
	E-2	3	30	72.1	29.7	25.4	
	E-3	3	30	55.1	25.4	4.2	
	F-1	3	8294	645	35	81	
	F-2	3	8294	588	31	111	
	F-6	3	8294		53	461	
	G-1	3	<5	415	280		
	J-1	2	15.5	60			
	J-2	2	15.5	122			125
	K-2	3/1	<5/<5	51	12	36	
	K-3	3/1	<5/<5	192	<5	5	<5
	K-4	3/1	<5/<5	40	<5	7	
	M-1	1	90	800			
	M-2	1	46	47			
	N-2	1	20	30			
	N-3	2	20		40		
	O-1	2	60	50			
O-2	2	60	48				
P-1	2	90	<10				
R-1	2	16	16				
R-2	2	16	20				
cobolt	B-1	1	ND	ND			
	B-2	1	ND	ND			
	B-4	1	ND	ND			
	C-1	3	ND	0.043	0.032	0.028	
	D-3	1	ND	ND			
	E-2	3	ND	0.136	0.142	0.084	
	E-3	3	ND	0.136	0.115	0.060	
	F-1	3	ND	ND	ND	ND	
	F-2	1	ND	ND	ND	ND	
	F-6	3	ND	ND	ND	ND	
	G-1	3	ND	0.051	0.058		
	J-1	2	ND	ND			
	J-2	2	ND	ND			
	K-2	3/1	ND/ND	ND	ND	ND	
K-3	3/1	ND/ND	ND	ND	ND		
K-4	3/1	ND/ND	ND	ND	ND		

Table A-1 (Continued)

SAMPLING DATA BY POLLUTANT FOR  
CONTACT COOLING AND HEATING WATER SUBCATEGORY  
(RAW WASTEWATER)

<u>Pollutant</u>	<u>Process Code</u>	<u>Sample Type</u>	<u>Source</u>	<u>Concentrations (mg/l)</u>			<u>Duplicate</u>	
				<u>Day 1</u>	<u>Day 2</u>	<u>Day 3</u>		
<u>Nonconventional Pollutants (Continued)</u>								
cyanide (amenable)	B-1		NA	NA				
	B-2		NA	NA				
	B-4		NA	NA			NA	
	C-1	1	0	0	0	0		
	D-3		NA	NA				
	E-2	1	<0.005	<0.005	<0.005	<0.005		
	E-3	1	<0.005	<0.005	<0.005	<0.005		
	F-1	1	0	0	0	0		
	F-2	1	0	0	0	0		
	F-6	1	0	0	0	0		
	G-1		NA/NA	NA	NA	NA		
	J-1		NA	NA				
	J-2	2	NA	NA			NA	
	K-2		NA/NA	NA	NA	NA	NA	
	K-3		NA/NA	NA	NA	NA	NA	
	K-4		NA/NA	NA	NA	NA	NA	
	fluoride	B-1	1	1.2	0.85			
		B-2	1	1.2	0.88			
B-4		1	1.2	0.91			0.95	
C-1			NA	NA	NA	NA		
D-3		1	0.95	0.95			1.25	
E-2			NA	NA	NA	NA		
E-3			NA	NA	NA	NA		
F-1			NA	NA	NA	NA		
F-2			NA	NA	NA	NA		
F-6			NA	NA	NA	NA		
G-1		3	0.46	0.08	0.18			
J-1		2	0.595	0.54				
J-2		2	0.595	0.36			0.48	
K-2		3	0.81/1.18	1.02	1.04	1.04		
K-3		3	0.81/0.73	0.78	0.72	0.80	0.73	
K-4		3	0.81/1.12	1.05	0.95	1.2		

A-10

Table A-1 (Continued)  
 SAMPLING DATA BY POLLUTANT FOR  
 CONTACT COOLING AND HEATING WATER SUBCATEGORY  
 (RAW WASTEWATER)

Pollutant	Process Code\$	Sample Type†	Source	Concentrations (mg/l)			Duplicate
				Day 1	Day 2	Day 3	
<u>Nonconventional Pollutants (Continued)</u>							
iron	B-1	1	0.300	0.400			
	B-2	1	0.3	0.45			
	B-4	1	0.300	0.500			
	C-1	3	0.140	9.850	9.450	1.640	
	D-3	1	ND	0.066			
	E-2	3	0.094	0.112	0.172	0.110	
	E-3	3	0.094	0.132	0.126	0.094	
	F-1	3	0.036	0.47	0.37	0.074	
	F-2	3	0.036	0.064	0.19	0.30	
	F-6	3	0.036		0.038	ND	
	G-1	3	ND	0.090	0.052		
	J-1	2	ND	ND			
	J-2	2	ND	0.054			
	K-2	3/1	ND/1.05	0.85	0.80	0.75	
	K-3	3/1	ND/0.4	0.25	0.35	0.35	
	K-4	3/1	ND/0.2	0.3	0.1	0.15	
Kjeldahl nitrogen	B-1	1	<1	<1			
	B-2	1	<1	<1			
	B-4	1	<1	<1			<1
	C-1	3	0	0	0	0	
	D-3	1	<1	<1			<1
	E-2	3	<0.1	<0.1	0.1	0.22	
	E-3	3	<0.1	0.63	<0.1	<0.1	
	F-1	3	<0.02	<0.02	0.45	<0.02	
	F-2	3	<0.02	1.15	<0.02	<0.02	
	F-6	3	<0.02		0.35	0.45	
	G-1	3	<1	<1	<1		
	J-1	2	ND	ND			
	J-2	2	ND	ND			ND
	K-2	3	<1/<1	<1	<1	<1	
	K-3	3	<1/<1	<1	<1	<1	<1
	K-4	3	<1/<1	<1	<1	<1	

Table A-1 (Continued)

SAMPLING DATA BY POLLUTANT FOR  
CONTACT COOLING AND HEATING WATER SUBCATEGORY  
(RAW WASTEWATER)

Pollutant	Process Code\$	Sample Type†	Source	Concentrations (mg/l)			Duplicate
				Day 1	Day 2	Day 3	
<u>Nonconventional Pollutants (Continued)</u>							
magnesium	B-1	1	0.700	0.900			
	B-2	1	0.7	0.8			
	B-4	1	0.700	0.700			
	C-1	3	1.240	2.120	2.060	1.870	
	D-3	1	5.66	4.83			
	E-2	3	2.36	2.46	2.58	2.42	
	E-3	3	2.36	2.54	2.55	2.6	
	F-1	3	13.3	19.8	23.4	28.6	
	F-2	3	13.3	17.2	24.8	29.8	
	F-6	3	13.3		28.5	29.4	
	G-1	3	0.181	24.3	25.5		
	J-1	2	3.215	2.290			
	J-2	2	3.215	2.500			
	K-2	3/1	5.8/6.4	5.9	6.1	6.8	
	K-3	3/1	5.8/5.6	5.5	5.7	5.5	
	K-4	3/1	5.8/6.1	5.6	5.9	5.9	
manganese	B-1	1	ND	0.050			
	B-2	1	ND	ND			
	B-4	1	ND	0.050			
	C-1	3	0.072	0.210	0.210	0.160	
	D-3	1	0.008	0.006			
	E-2	3	0.011	0.035	0.039	0.040	
	E-3	3	0.011	0.032	0.044	0.032	
	F-1	3	ND	ND	ND	ND	
	F-2	3	ND	ND	ND	ND	
	F-6	3	ND	ND	ND	ND	
	G-1	3	ND	0.029	0.032		
	J-1	2	ND	ND			
	J-2	2	ND	ND			
	K-2	3/1	ND/ND	ND	ND	ND	
	K-3	3/1	ND/ND	ND	ND	ND	
	K-4	3/1	ND/ND	ND	ND	ND	

A-12

Table A-1 (Continued)

 SAMPLING DATA BY POLLUTANT FOR  
 CONTACT COOLING AND HEATING WATER SUBCATEGORY  
 (RAW WASTEWATER)

<u>Pollutant</u>	<u>Process Code</u>	<u>Sample Type</u>	<u>Source</u>	<u>Concentrations (mg/l)</u>			<u>Duplicate</u>
				<u>Day 1</u>	<u>Day 2</u>	<u>Day 3</u>	
<u>Nonconventional Pollutants (Continued)</u>							
molybdenum	B-1	1	ND	ND			
	B-2	1	ND	ND			
	B-4	1	ND	ND			
	C-1	3	ND	ND	0.021	ND	
	D-3	1	ND	ND			
	E-2	3	ND	ND	0.045	ND	
	E-3	3	ND	0.044	ND	ND	
	F-1	3	ND	ND	ND	ND	
	F-2	3	ND	ND	ND	ND	
	F-6	3	ND	ND	ND	ND	
	G-1	3	ND	ND	ND		
	J-1	2	ND	ND			
	J-2	2	ND	ND			
	K-2	3/1	ND/0.150	ND	0.15	0.15	
	K-3	3/1	ND/ND	ND	ND	ND	
	K-4	3/1	ND/ND	ND	ND	ND	
nitrate	B-1	1	<0.1	<0.1			
	B-2	1	<0.1	0.1			
	B-4	1	<0.1	<0.1			<0.1
	C-1		NA	NA	NA	NA	
	D-3	1	2.0	2.1			2.1
	E-2		NA	NA	NA	NA	
	E-3		NA	NA	NA	NA	
	F-1		NA	NA	NA	NA	
	F-2		NA	NA	NA	NA	
	F-6		NA	NA	NA	NA	
	G-1	3	5.8	6.6	6.0		
	J-1	2	1.05	0.35			
	J-2	2	1.05	0.40			0.40
	K-2	3	1.05/1.4	0.75	1.35	1.35	
	K-3	3	1.05/0.70	0.75	0.75	0.70	0.70
	K-4	3	1.05/1.2	1.1	1.1	1.15	

A-13

Table A-1 (Continued)

SAMPLING DATA BY POLLUTANT FOR  
CONTACT COOLING AND HEATING WATER SUBCATEGORY  
(RAW WASTEWATER)

Pollutant	Process Code\$	Sample Type†	Source	Concentrations (mg/l)			
				Day 1	Day 2	Day 3	Duplicate
<u>Nonconventional Pollutants (Continued)</u>							
sodium	B-1	1	1.800	2.100			
	B-2	1	1.8	2.1			
	B-4	1	1.800	1.800			
	C-1	3	11.400	18.600	18.900	17.400	
	D-3	1	26.2	22.3			
	E-2	3	10.8	10.8	8.71	10.7	
	E-3	3	10.8	10.7	8.82	11.2	
	F-1	3	177	169.0	119.0	91.4	
	F-2	3	177	170	117	88.9	
	F-6	3	177.0		97.2	86.5	
	G-1	3	ND	18.8	207		
	J-1	2	70.400	58.000			
	J-2	2	70.400	53.900			
	K-2	3/1	8.1/10.2	8.6	9.2	10.5	
	K-3	3/1	8.1/7.5	7.3	7.6	7.4	
	K-4	3/1	8.1/9.3	8.1	8.7	8.8	
	sulfate	B-1	1	9	5		
B-2		1	9	10			
B-4		1	9	<5			<5
C-1			NA	NA	NA	NA	
D-3		1	33	33			30
E-2			NA	NA	NA	NA	
E-3			NA	NA	NA	NA	
F-1			NA	NA	NA	NA	
F-2			NA	NA	NA	NA	
F-6			NA	NA	NA	NA	
G-1		3	1040	1180	890		
J-1		2	33	25			
J-2		2	33	25			25
K-2		2	10/15	11	15	15	
K-3		2	10/11	10	11	10	11
K-4	2	10/12	10	<5	11		



Table A-1 (Continued)

SAMPLING DATA BY POLLUTANT FOR  
CONTACT COOLING AND HEATING WATER SUBCATEGORY  
(RAW WASTEWATER)

Pollutant	Process Code\$	Sample Type†	Source	Concentrations (mg/l)			Duplicate	Average
				Day 1	Day 2	Day 3		
<u>Nonconventional Pollutants (Continued)</u>								
sulfide	B-1	1	<1	<1				
	B-2	1	<1	<1				
	B-4	1	<1	<1				<1
	C-1		NA	NA	NA	NA		
	D-3	1	NA	NA				
	E-2		NA	NA	NA	NA		
	E-3		NA	NA	NA	NA		
	F-1		NA	NA	NA	NA	NA	
	F-2		NA	NA	NA	NA	NA	
	F-6		NA	NA	NA	NA	NA	
	G-1	1	<1	<1	<1			
	J-1	2	<1	<1				
	J-2	2	<1	<1				<1
	K-2	1	<1/<1	<1	<1	<1	<1	<1
	K-3	1	<1/<1	<1	<1	<1	<1	<1
	K-4	1	<1/<1	<1	<1	<1	<1	
surfactants	B-1	1	<0.01	<0.01				
	B-2	1	<0.01	<0.01				
	B-4	1	<0.01	<0.01				<0.01
	C-1	3	0.08	28.86	25.7	16.09		
	D-3		NA	NA				
	E-2	3	0.12	0	0.10	0		
	E-3	3	0.12	0	0	0.11		
	F-1	3	<0.02	6	3.3	8		
	F-2	3	<0.02	0.02	0.05	0.07		
	F-6	3	<0.02		0.02	<0.02		
	G-1	3	<0.01	<0.01	0.10			
	J-1	2	<0.015	0.045				
	J-2	2	<0.015	0.032				0.057
	K-2	3	<0.01/ 0.01	<0.01	0.02	<0.01	<0.01	
	K-3	3	<0.01/ 0.01	<0.01	<0.01	<0.01	<0.01	<0.01
	K-4	3	<0.01/ 0.01	<0.01	0.03	<0.01	<0.01	

Table A-1 (Continued)

SAMPLING DATA BY POLLUTANT FOR  
CONTACT COOLING AND HEATING WATER SUBCATEGORY  
(RAW WASTEWATER)

Pollutant	Process Code	Sample Type	Source	Concentrations (mg/l)			Duplicate
				Day 1	Day 2	Day 3	
<u>Nonconventional Pollutants (Continued)</u>							
tin	B-1	1	ND	ND			
	B-2	1	ND	ND			
	B-4	1	ND	ND			
	C-1	3	ND	0.012	ND	ND	
	D-3	1	ND	ND			
	E-2	3	0.051	0.043	0.058	0.052	
	E-3	3	0.051	0.032	0.042	0.042	
	F-1	3	ND	0.12	0.080	0.050	
	F-2	3	ND	ND	ND	ND	
	F-6	3	ND	ND	ND	ND	
	G-1	3	ND	ND	ND		
	J-1	2	ND	ND			
	J-2	2	ND	ND			
	K-2	3/1	ND/ND	ND	ND	ND	
	K-3	3/1	ND/ND	ND	ND	ND	
	K-4	3/1	ND/ND	ND	ND	ND	
titanium	B-1	1	ND	ND			
	B-2	1	ND	ND			
	B-4	1	ND	ND			
	C-1	3	0.087	0.290	0.290	0.100	
	D-3	1	0.013	0.017			
	E-2	3	ND	0.006	0.009	ND	
	E-3	3	ND	ND	0.005	ND	
	F-1	3	0.130	0.12	0.085	0.039	
	F-2	3	0.13	0.096	0.094	0.053	
	F-6	3	0.13		0.097	0.063	
	G-1	3	0.010	0.023	0.036		
	J-1	2	ND	ND			
	J-2	2	ND	ND			
	K-2	3/1	ND/ND	ND	ND	ND	
	K-3	3/1	ND/ND	ND	ND	ND	
	K-4	3/1	ND/ND	ND	ND	ND	

Table A-1 (Continued)

SAMPLING DATA BY POLLUTANT FOR  
CONTACT COOLING AND HEATING WATER SUBCATEGORY  
(RAW WASTEWATER)

Pollutant	Process Code§	Sample Type†	Concentrations (mg/l)				Duplicate
			Source	Day 1	Day 2	Day 3	
<u>Nonconventional Pollutants (Continued)</u>							
total dissolved solids (TDS)	B-1		NA	NA			
	B-2		NA	NA			
	B-4		NA	NA			NA
	C-1	3	0	150.0	140.0	110	
	D-3		NA	NA			
	E-2	3	7	103	89	68	
	E-3	3	7	98	73	66	
	F-1	3	800	700	700	500	
	F-2	3	800	800	700	400	
	F-6	3	800		700	400	
	G-1		NA	NA	NA		
	J-1		NA	NA			
	J-2		NA	NA			NA
	K-2		NA/NA	NA	NA	NA	NA
	K-3		NA/NA	NA	NA	NA	NA
	K-4		NA/NA	NA	NA	NA	NA
	total organic carbon (TOC)	B-1	1	6	7		
B-2		1	6	7			
B-4		1	6	6			6
C-1		1	3.0	48.0	40.5	29.5	
D-3		1	2	6			4
E-2		1	8.9	16	10.0	6.4	
E-3		1	8.9	16.4	8.1	1.0	
F-1		1	37	27	66	65	
F-2		1	37	64	63	64	
F-6		1	37		61	59	
G-1		3	<1	144	88		
J-1		2	6.5	21			
J-2		2	6.5	46			46
K-2		3	3.0/4	30	8	14	
K-3		3	3/0/1	72	3	4	2
K-4		3	3.0/2	26	5	4	
M-1		1	<1	24			
M-2		1	30	13			
N-2		1	10	14			
N-3		2	10		10		
O-1		2	<1	<1			
O-2		2	<1	<1			
P-1		2	<1	18			
R-1	2	6	6				
R-2	2	6	5				

Table A-1 (Continued)

SAMPLING DATA BY POLLUTANT FOR  
CONTACT COOLING AND HEATING WATER SUBCATEGORY  
(RAW WASTEWATER)

Pollutant	Process Codes	Sample Type	Concentrations (mg/l)				Duplicate	
			Source	Day 1	Day 2	Day 3		
<u>Nonconventional Pollutants (Continued)</u>								
total phenols	B-1	1	<0.020	<0.020				
	B-2	1	<0.02	<0.02				
	B-4	1	<0.020	<0.020			<0.020	
	C-1	1	1.42	1.08	16.42	20.86		
	D-3	1	<0.001	<0.001			<0.001	
	E-2	1	<0.001	<0.001	<0.001	<0.001		
	E-3	1	<0.001	<0.001	<0.001	<0.001		
	F-1	1	10	36	81	238		
	F-2	1	10	<5	13	15		
	F-6	1	10		1670	108		
	G-1	2		0.023	0.100			
	J-1	2		<0.020	<0.020			
	J-2	2		<0.020	<0.020		<0.020	
	K-2	2		<0.001/0.01	<0.001	0.008	0.023	
	K-3	2		<0.001/<0.001	<0.001	0.026	<0.001	<0.001
	K-4	2		<0.001/0.026	<0.008	<0.001	<0.001	
	M-1	1		<0.005	0.056			
	M-2	1		0.28	0.26			
	N-2	1		0.39	0.67			
	N-3	1		0.39	0.47			
	O-1	1		0.42	0.15			
	O-2	1		0.42	0.09			
	P-1	1		<0.005	0.096			
R-1	1		0.4	0.42				
R-2	1		0.4	0.34				
total phosphorus	B-1	1	0.210	0.287				
	B-2	1	0.21	0.242				
	B-4	1	0.210	0.221			0.173	
	C-1	3	1.20	<0.005	<0.005	<0.003		
	D-3	1	0.10	<0.02			0.04	
	E-2	3	0.24	0.24	0.16	0.20		
	E-3	3	0.24	1.04	0.16	0.24		
	F-1	3	<0.02	3.25	3.25	2.05		
	F-2	3	<0.02	0.55	1.3	<0.02		
	F-6	3	<0.02		0.85	<0.02		
	G-1	3	0.04	0.04	0.21			
	J-1	2	0.0435	0.53				
	J-2	2	0.0435	0.78			0.52	
	K-2	3/1	0.04/0.51	0.39	0.63	0.51		
	K-3	3/1	0.04/0.08	<0.02	0.03	0.04	0.03	
	K-4	3/1	0.04/0.35	0.31	0.17	0.42		

Table A-1 (Continued)

SAMPLING DATA BY POLLUTANT FOR  
CONTACT COOLING AND HEATING WATER SUBCATEGORY  
(RAW WASTEWATER)

Pollutant	Process Code§	Sample Type†	Source	Concentrations (mg/l)			Duplicate
				Day 1	Day 2	Day 3	
<u>Nonconventional Pollutants (Continued)</u>							
vanadium	B-1	1	ND	ND			
	B-2	1	ND	ND			
	B-4	1	ND	ND			ND
	C-1	3	ND	ND	ND	ND	
	D-3	1	0.038	ND			
	E-2	3	ND	0.005	0.005	ND	
	E-3	3	ND	0.005	0.003	ND	
	F-1	3	ND	ND	ND	ND	
	F-2	3	ND	ND	ND	ND	
	F-6	3	ND	ND	ND	ND	
	G-1	3	ND	0.053	0.056		
	J-1	2	ND	ND			
	J-2	2	ND	ND			
	K-2	3/1	ND/ND	ND	ND	ND	
	K-3	3/1	ND/ND	ND	ND	ND	
	K-4	3/1	ND/ND	ND	ND	ND	
yttrium	B-1	1	ND	ND			
	B-2	1	ND	ND			
	B-4	1	ND	ND			ND
	C-1	3	ND	ND	ND	ND	
	D-3	1	ND	0.006			
	E-2	3	ND	ND	ND	ND	
	E-3	3	ND	ND	ND	ND	
	F-1	3	ND	ND	ND	ND	
	F-2	3	ND	ND	ND	ND	
	F-6	3	ND	ND	ND	ND	
	G-1	3	ND	0.007	0.019		
	J-1	2	ND	ND			
	J-2	2	ND	ND			
	K-2	3/1	ND/ND	ND	ND	ND	
	K-3	3/1	ND/ND	ND	ND	ND	
	K-4	3/1	ND/ND	ND	ND	ND	

Table A-1 (Continued)

SAMPLING DATA BY POLLUTANT FOR  
CONTACT COOLING AND HEATING WATER SUBCATEGORY  
(RAW WASTEWATER)

Pollutant	Process Code <sup>s</sup>	Sample Type <sup>t</sup>	Concentrations (mg/l)				Duplicate
			Source	Day 1	Day 2	Day 3	
<u>Priority Pollutants</u>							
1. acenaphthene	B-1	1	ND	ND			
	B-2	1	ND	ND			
	B-4	1	ND	ND			ND
	C-1	3	ND	ND	ND	ND	
	D-3	1	ND	ND			
	E-2	3	ND	ND	ND	ND	ND
	E-3	3	ND	ND	ND	ND	
	F-1	3	ND	*	*	ND	
	F-2	3	ND	*	ND	*	
	F-6	3	ND	ND	ND	ND	
	G-1	3	ND	ND	ND		
	J-1	2	ND	ND			
	J-2	2	ND	ND			ND
	K-2	3	ND	ND	ND	ND	
	K-3	3	ND	ND	ND	ND	ND
	K-4	3	ND	ND	ND	ND	
4. benzene	B-1	2	ND	ND			
	B-2	2	ND	ND			
	B-4	2	ND	ND			ND
	C-1	2	*	0.001	*	*	
	D-3	2	ND	ND			
	E-2	2	ND	ND	ND	ND	ND
	E-3	2	ND	ND	ND	ND	
	F-1	2	*	*	ND	*	
	F-2	2	*	*	*	*	
	F-6	2	*		*	*	
	G-1	2	ND	ND	0.019		
	J-1	2	0.003	0.004			
	J-2	2	0.003	ND			ND
	K-2	2	ND/0.008	ND	0.008	0.009	
	K-3	2	ND/0.008	ND	0.009	0.009	0.009
	K-4	2	ND/0.009	0.045/ND	0.034/0.008	0.005/0.008	

A-20

Table A-1 (Continued)

SAMPLING DATA BY POLLUTANT FOR  
CONTACT COOLING AND HEATING WATER SUBCATEGORY  
(RAW WASTEWATER)

Pollutant	Process Code\$	Sample Type†	Source	Concentrations (mg/l)			Duplicate
				Day 1	Day 2	Day 3	
<u>Priority Pollutants (Continued)</u>							
5. benzidine	B-1	1	ND	ND			
	B-2	1	ND	ND			
	B-4	1	ND	ND			ND
	C-1	3	ND	ND	ND	ND	
	D-3	1	ND	ND			
	E-2	3	ND	ND	ND	ND	ND
	E-3	3	ND	ND	ND		
	F-1	3	ND	ND	ND	ND	
	F-2	3	ND	ND	ND	ND	
	F-6	3	ND		*	*	
	G-1	3	ND	ND	ND		
	J-1	2	ND	ND			
	J-2	2	ND	ND			ND
	K-2	3	ND/ND	ND	ND	ND	ND
	K-3	3	ND/ND	ND	ND	ND	ND
	K-4	3	ND/ND	ND	ND	ND	ND
	6. carbon tetrachloride	B-1	2	ND	ND		
B-2		2	ND	ND			
B-4		2	ND	ND			ND
C-1		2	ND	ND	ND	ND	
D-3		2	ND	ND			
E-2		2	ND	ND	ND	0.008	ND
E-3		2	ND	ND	ND	ND	
F-1		2	ND	ND	ND	ND	
F-2		2	ND	ND	ND	ND	
F-6		2	ND		ND	ND	
G-1		2	0.001	*	*		
J-1		2	ND	ND			
J-2		2	ND	ND			ND
K-2		2	0.004/0.0055	ND	0.007	0.004	
K-3		2	0.004/0.005	0.001	0.005	ND	0.006
K-4		2	0.004/0.0075	ND/ND	ND/0.008	ND/ND	

Table A-1 (Continued)

SAMPLING DATA BY POLLUTANT FOR  
CONTACT COOLING AND HEATING WATER SUBCATEGORY  
(RAW WASTEWATER)

Pollutant	Process Code\$	Sample Type†	Source	Concentrations (mg/l)			Duplicate
				Day 1	Day 2	Day 3	
<u>Priority Pollutants (Continued)</u>							
7. chlorobenzene	B-1	2	ND	ND			
	B-2	2	ND	ND			
	B-4	2	ND	ND			ND
	C-1	2	ND	ND	ND	ND	
	D-3	2	ND	ND			
	E-2	2	ND	0.0032	ND	ND	0.0003
	E-3	2	ND	ND	ND	ND	
	F-1	2	ND	ND	ND	ND	
	F-2	2	ND	*	*	*	
	F-6	2	ND	ND	*	ND	
	G-1	2	ND	ND	ND		
	K-2	2	ND/ND	ND	ND	ND	
	K-3	2	ND/ND	ND	ND	ND	ND
	K-4	2	ND/ND	ND/ND	ND/ND	ND/ND	
10. 1,2-dichloroethane	B-1	2	ND	ND			
	B-2	2	ND	ND			
	B-4	2	ND	ND			ND
	C-1	2	ND	ND	*	ND	
	D-3	2	ND	ND			
	E-2	2	ND	ND	ND	ND	ND
	E-3	2	ND	ND	ND	ND	ND
	F-1	2	ND	ND	ND	ND	
	F-2	2	ND	ND	ND	ND	
	F-6	2	ND	ND	ND	ND	
	G-1	2	ND	ND	ND		
	J-1	2	ND	ND			
	J-2	2	ND	ND			ND
	K-2	2	ND	ND	ND	ND	
K-3	2	ND	ND	ND	ND	ND	
K-4	2	ND	ND	ND	ND		



Table A-1 (Continued)

SAMPLING DATA BY POLLUTANT FOR  
CONTACT COOLING AND HEATING WATER SUBCATEGORY  
(RAW WASTEWATER)

Pollutant	Process Code <sup>§</sup>	Sample Type <sup>†</sup>	Source	Concentrations (mg/l)			Duplicate
				Day 1	Day 2	Day 3	
<u>Priority Pollutants (Continued)</u>							
11. 1,1,1-trichloroethane	B-1	2	*	0.001			
	B-2	2	*	0.0015			
	B-4	2	*	0.001			0.001
	C-1	2	ND	ND	*	ND	
	D-3	2	0.004	0.001			
	E-2	2	ND	ND	ND	ND	ND
	E-3	2	ND	ND	ND	ND	
	F-1	2	*	ND	ND	ND	
	F-2	2	*	ND	ND	ND	
	F-6	2	*		ND	ND	
	G-1	2	0.004	0.003	0.006		
	J-1	2	0.004	0.004			
	J-2	2	0.004	*			0.001
	K-2	2	0.003/0.0115	0.001	0.036	0.007	
	K-3	2	0.003/0.001	0.001	0.001	0.004	0.002
	K-4	2	0.003/0.0275	0.011/ 0.037	0.037/ 0.093	0.015/ 0.031	
	22. p-chloro-m-cresol	B-1	1	0.008	0.008		
B-2		1	0.008	0.008			
B-4		1	0.008	0.008			0.008
C-1		3	ND	ND	ND	ND	
D-3		1	ND	ND			
E-2		3	ND	ND	ND	ND	ND
E-3		3	ND	ND	ND	ND	
F-1		3	ND	ND	ND	ND	
F-2		3	ND	ND	ND	ND	
F-6		3	ND	ND	ND	ND	
G-1		3	ND	ND	ND		
J-1		2	0.008	0.008			
J-2		2	0.008	0.008			0.008
K-2		3	ND/0.043	0.042	0.042	0.043	
K-3		3	ND/0.043	0.042	0.040	0.043	0.042
K-4	3	ND/ND	0.042	0.042	ND		

A-23

Table A-1 (Continued)

SAMPLING DATA BY POLLUTANT FOR  
CONTACT COOLING AND HEATING WATER SUBCATEGORY  
(RAW WASTEWATER)

Pollutant	Process Code <sup>s</sup>	Sample Type <sup>t</sup>	Concentrations (mg/l)				Duplicate
			Source	Day 1	Day 2	Day 3	
<u>Priority Pollutants (Continued)</u>							
23. chloroform	B-1	2	0.014	0.026			
	B-2	2	0.014	0.035			
	B-4	2	0.014	0.020			0.070
	C-1	2	ND	ND	ND	ND	
	D-3	2	0.019	0.010			
	E-2	2	0.068	0.048	0.058	0.070	0.115
	E-3	2	0.068	0.042	0.090	0.066	
	F-1	2	*	*	*	*	
	F-2	2	*	*	*	ND	
	F-6	2	*		*	*	
	G-1	2	0.006	0.005	0.008		
	J-1	2	0.0035	ND			
	J-2	2	0.0035	ND			ND
	K-2	2	0.1015/0.001	*	ND	ND	
	K-3	2	0.1015/0.003	0.001	0.002	0.002	0.003
	K-4	2	0.1015/0.062	0.003/ 0.015	0.003/ 0.012	0.029/ 0.024	
24. 2-chlorophenol	B-1	1	ND	ND			
	B-2	1	ND	ND			
	B-4	1	ND	ND			ND
	C-1	3	ND	ND	ND	*	
	D-3	1	ND	ND			
	E-2	3	ND	ND	ND	ND	ND
	E-3	3	ND	ND	ND	ND	
	F-1	3	ND	ND	ND	ND	
	F-2	3	ND	ND	ND	ND	
	F-6	3	ND	ND	ND	ND	
	G-1	3	ND	ND	ND		
	J-1	2	ND	ND			
	J-2	2	ND	ND			ND
	K-2	3	ND	ND	ND	ND	
K-3	3	ND	ND	ND	ND	ND	
K-4	3	ND	ND	ND	ND	ND	

A-24

Table A-1 (Continued)

SAMPLING DATA BY POLLUTANT FOR  
CONTACT COOLING AND HEATING WATER SUBCATEGORY  
(RAW WASTEWATER)

Pollutant	Process Codes	Sample Type	Source	Concentrations (mg/l)			Duplicate
				Day 1	Day 2	Day 3	
<u>Priority Pollutants (Continued)</u>							
25. 1,2-dichlorobenzene	B-1	1	ND	ND			
	B-2	1	ND	ND			
	B-4	1	ND	ND			ND
	C-1	3	ND	ND	ND	*	
	D-3	1	ND	ND			
	E-2	3	ND	ND	ND	ND	ND
	E-3	3	ND	ND	ND	ND	
	F-1	3	ND	ND	ND	ND	
	F-2	3	ND	ND	ND	ND	
	F-6	3	ND	ND	ND	ND	
	G-1	3	ND	ND	ND		
	J-1	2	ND	ND			
	J-2	2	ND	ND			ND
	K-2	3	ND	ND	ND	ND	
	K-3	3	ND	ND	ND	ND	ND
	K-4	3	ND	ND	ND	ND	
26. 1,3-dichlorobenzene	B-1	1	ND	ND			
	B-2	1	ND	ND			
	B-4	1	ND	ND			ND
	C-1	3	ND	ND	ND	*	
	D-3	1	ND	ND			
	E-2	3	ND	ND	ND	ND	ND
	E-3	3	ND	ND	ND	ND	
	F-1	3	ND	ND	ND	ND	
	F-2	3	ND	ND	ND	ND	
	F-6	3	ND	ND	ND	ND	
	G-1	3	ND	ND	ND		
	J-1	2	ND	ND			
	J-2	2	ND	ND			ND
	K-2	3	ND	ND	ND	ND	
	K-3	3	ND	ND	ND	ND	ND
	K-4	3	ND	ND	ND	ND	

Table A-1 (Continued)

SAMPLING DATA BY POLLUTANT FOR  
 CONTACT COOLING AND HEATING WATER SUBCATEGORY  
 (RAW WASTEWATER)

Pollutant	Process Code§	Sample Type†	Source	Concentrations (mg/l)			Duplicate
				Day 1	Day 2	Day 3	
<u>Priority Pollutants (Continued)</u>							
27. 1,4-dichlorobenzene	B-1	1	ND	ND			
	B-2	1	ND	ND			
	B-4	1	ND	ND			ND
	C-1	3	ND	ND	ND	*	
	D-3	1	ND	ND			
	E-2	3	ND	ND	ND	ND	ND
	E-3	3	ND	ND	ND	ND	ND
	F-1	3	ND	ND	ND	ND	ND
	F-2	3	ND	ND	ND	ND	ND
	F-6	3	ND	ND	ND	ND	ND
	G-1	3	ND	ND	ND		
	J-1	2	ND	ND			
	J-2	2	ND	ND			ND
	K-2	3	ND	ND	ND	ND	ND
	K-3	3	ND	ND	ND	ND	ND
	K-4	3	ND	ND	ND	ND	ND
30. 1,2-trans-dichloroethylene	B-1	2	ND	ND			
	B-2	2	ND	ND			
	B-4	2	ND	ND			ND
	C-1	2	0.008	*	ND	ND	
	D-3	2	ND	ND			
	E-2	2	ND	ND	ND	ND	ND
	E-3	2	ND	ND	ND	ND	ND
	F-1	2	ND	ND	ND	ND	ND
	F-2	2	ND	ND	ND	ND	ND
	F-6	2	ND	ND	ND	ND	ND
	G-1	2	ND	0.015	0.017		
	J-1	2	ND	ND			
	J-2	2	ND	ND			ND
	K-2	2	ND/ND	ND	ND	ND	ND
	K-3	2	ND/ND	ND	ND	ND	ND
	K-4	2	ND/ND	ND/ND	ND/ND	ND/ND	ND/ND

A-26

Table A-1 (Continued)

SAMPLING DATA BY POLLUTANT FOR  
CONTACT COOLING AND HEATING WATER SUBCATEGORY  
(RAW WASTEWATER)

Pollutant	Process Code\$	Sample Type†	Source	Concentrations (mg/l)			Duplicate
				Day 1	Day 2	Day 3	
<u>Priority Pollutants (Continued)</u>							
31. 2,4-dichlorophenol	B-1	1	ND	ND			
	B-2	1	ND	ND			
	B-4	1	ND	ND			ND
	C-1	3	ND	ND	ND	*	
	D-3	1	ND	ND			
	E-2	3	ND	ND	ND	ND	ND
	E-3	3	ND	ND	ND	ND	ND
	F-1	3	ND	ND	ND	ND	ND
	F-2	3	ND	ND	ND	ND	ND
	F-6	3	ND	ND	ND	ND	ND
	G-1	3	ND	ND	ND		
	J-1	2	ND	ND			
	J-2	2	ND	ND			ND
	K-2	3	ND	ND	ND	ND	ND
	K-3	3	ND	ND	ND	ND	ND
	K-4	3	ND	ND	ND	ND	ND
38. ethylbenzene	B-1	2	ND	ND			
	B-2	2	ND	ND			
	B-4	2	ND	ND			ND
	C-1	2	ND	*	*	ND	
	D-3	2	ND	ND			
	E-2	2	ND	ND	ND	ND	ND
	E-3	2	ND	ND	ND	ND	ND
	F-1	2	ND	ND	ND	*	*
	F-2	2	ND	*	*	*	*
	F-6	2	ND	ND	ND	*	*
	G-1	2	ND	ND	ND		
	J-1	2	ND	ND			
	J-2	2	ND	ND			ND
	K-2	2	ND/ND	ND	ND	ND	ND
	K-3	2	ND/ND	ND	ND	ND	ND
	K-4	2	ND/ND	ND/ND	ND/ND	ND/ND	ND/ND

Table A-1 (Continued)

SAMPLING DATA BY POLLUTANT FOR  
CONTACT COOLING AND HEATING WATER SUBCATEGORY  
(RAW WASTEWATER)

Pollutant	Process Code§	Sample Type†	Source	Concentrations (mg/l)			Duplicate
				Day 1	Day 2	Day 3	
<u>Priority Pollutants (Continued)</u>							
39. fluoranthene	B-1	1	ND	*			
	B-2	1	ND	*			
	B-4	1	ND	ND			ND
	C-1	3	ND	ND	ND	ND	
	D-3	1	ND	ND			
	E-2	3	ND	ND	ND	ND	ND
	E-3	3	ND	ND	ND	ND	
	F-1	3	ND	ND	ND	ND	
	F-2	3	ND	ND	ND	ND	
	F-6	3	ND	ND	ND	ND	
	G-1	3	ND	ND	ND		
	J-1	2	ND	ND			
	J-2	2	ND	ND			ND
	K-2	3	ND/ND	ND	ND	ND	
	K-3	3	ND/ND	ND	ND	ND	
	K-4	3	ND/ND	ND	ND	ND	
41. 4-bromophenylphenylether	B-1	1	ND	ND			
	B-2	1	ND	ND			
	B-4	1	ND	ND			ND
	C-1	3	ND	ND	ND	ND	
	D-3	1	ND	ND			
	E-2	3	ND	ND	ND	ND	ND
	E-3	3	ND	ND	0.00042	ND	
	F-1	3	ND	ND	ND	ND	
	F-2	3	ND	ND	ND	ND	
	F-6	3	ND	ND	ND	ND	
	G-1	3	ND	ND	ND		
	J-1	2	ND	ND			
	J-2	2	ND	ND			ND
	K-2	3	ND/ND	ND	ND	ND	
	K-3	3	ND/ND	ND	ND	ND	ND
	K-4	3	ND/ND	ND	ND	ND	ND

Table A-1 (Continued)

SAMPLING DATA BY POLLUTANT FOR  
CONTACT COOLING AND HEATING WATER SUBCATEGORY  
(RAW WASTEWATER)

Pollutant	Process Code\$	Sample Type†	Source	Concentrations (µg/l)			Duplicate
				Day 1	Day 2	Day 3	
<u>Priority Pollutants (Continued)</u>							
44. methylene chloride	B-1	2	0.001	ND			
	B-2	2	0.001	0.014			
	B-4	2	0.001	††			0.183
	C-1	2	*	0.009	0.038	0.011	
	D-3	2	0.017	0.008			
	E-2	2	0.00007	0.007	0.00006	0.0001	0.0029
	E-3	2	0.00007	0.00008	0.00005	0.00008	
	F-1	2	*	0.001	*	*	
	F-2	2	*	0.002	*	*	
	F-6	2	*		*	*	
	G-1	2	ND	0.33	0.024		
	J-1	2	0.005	ND			
	J-2	2	0.005	0.096			0.066
	K-2	2	0.015/0.0305	ND	0.156	0.028	
	K-3	2	0.015/0.028	0.026	0.023	0.031	0.037
K-4	2	0.015/0.0335	0.017/ND	0.041/ 0.157	0.010/ 0.030		
47. bromoform	B-1	2	ND	ND			
	B-2	2	ND	ND			
	B-4	2	ND	ND			ND
	C-1	2	ND	ND	ND	ND	
	D-3	2	ND	ND			
	E-2	2	ND	ND	ND	ND	ND
	E-3	2	ND	ND	ND	ND	
	F-1	2	0.086	0.015	0.015	0.024	
	F-2	2	0.086	0.005	0.020	0.009	
	F-6	2	0.086		0.011	0.017	
	G-1	2	ND	ND	ND		
	J-1	2	ND	ND			
	J-2	2	ND	ND			ND
	K-2	2	ND/ND	ND	ND	ND	
	K-3	2	ND/ND	*	ND	ND	ND
K-4	2	ND/ND	*/ND	ND/ND	ND/ND		

Table A-1 (Continued)

SAMPLING DATA BY POLLUTANT FOR  
CONTACT COOLING AND HEATING WATER SUBCATEGORY  
(RAW WASTEWATER)

Pollutant	Process Code§	Sample Type†	Source	Concentrations (mg/l)			Duplicate
				Day 1	Day 2	Day 3	
<u>Priority Pollutants (Continued)</u>							
48. dichlorobromomethane	B-1	2	ND	ND			
	B-2	2	ND	0.001			
	B-4	2	ND	ND			ND
	C-1	2	ND	ND	ND	ND	
	D-3	2	0.004	0.003			
	E-2	2	0.004	ND	ND	0.006	ND
	E-3	2	0.004	ND	ND	ND	
	F-1	2	*	ND	ND	*	
	F-2	2	*	ND	ND	ND	
	F-6	2	*	*	*	*	
	G-1	2	ND	ND	ND		
	J-1	2	0.001	ND			
	J-2	2	0.001	0.002			0.002
	K-2	2	0.018/ND	0.007	0.006	0.005	
	K-3	2	0.018/ND	0.001	0.005	0.003	ND
	K-4	2	0.018/ND	0.001/ND	ND/0.007	0.005/ 0.006	
49. trichlorofluoromethane	B-1	2	ND	ND			
	B-2	2	ND	ND			
	B-4	2	ND	ND			ND
	C-1	2	ND	0.003	0.004	*	
	D-3	2	ND	ND			
	E-2	2	ND	ND	ND	ND	ND
	E-3	2	ND	ND	ND	ND	
	F-1	2	ND	ND	ND	*	
	F-2	2	ND	*	*	*	
	F-6	2	ND		*	*	
	G-1	2	ND	ND	ND		
	J-1	2	ND	ND			
	J-2	2	0.001	0.002			0.002
	K-2	2	ND/ND	ND	ND	ND	
	K-3	2	ND/ND	ND	ND	ND	ND
	K-4	2	ND/ND	ND/ND	ND/ND	ND/ND	ND

A-30



Table A-1 (Continued)

SAMPLING DATA BY POLLUTANT FOR  
CONTACT COOLING AND HEATING WATER SUBCATEGORY  
(RAW WASTEWATER)

Pollutant	Process Code§	Sample Type†	Source	Concentrations (mg/l)			Duplicate
				Day 1	Day 2	Day 3	
<u>Priority Pollutants (Continued)</u>							
51. chlorodibromomethane	B-1	2	ND	ND			
	B-2	2	ND	ND			
	B-4	2	ND	ND			ND
	C-1	2	ND	ND	ND	ND	
	D-3	2	ND	ND			
	E-2	2	ND	ND	ND	ND	ND
	E-3	2	ND	ND	ND	ND	ND
	F-1	2	0.002	*	*	0.001	
	F-2	2	0.002	*	*	*	
	F-6	2	0.002		*	*	
	G-1	2	ND	ND	ND		
	J-1	2	ND	ND			
	J-2	2	ND	ND			ND
	K-2	2	ND/ND	ND	ND	ND	ND
	K-3	2	ND/ND	ND	ND	ND	ND
	K-4	2	ND/ND	0.001/ND	ND/ND	ND/ND	ND/ND
54. isophorone	B-1	1	ND	ND			
	B-2	1	ND	ND			
	B-4	1	ND	ND			ND
	C-1	3	ND	ND	ND	ND	
	D-3	1	ND	ND			
	E-2	3	ND	ND	ND	ND	ND
	E-3	3	ND	ND	0.00096	ND	
	F-1	3	ND	ND	ND	ND	
	F-2	3	ND	ND	ND	ND	
	F-6	3	ND	ND	ND	ND	
	G-1	3	ND	ND	ND		
	J-1	2	ND	ND			
	J-2	2	ND	ND			ND
	K-2	3	ND/ND	ND	ND	ND	ND
	K-3	3	ND/ND	ND	ND	ND	ND
	K-4	3	ND/ND	ND	ND	ND	ND

Table A-1 (Continued)

SAMPLING DATA BY POLLUTANT FOR  
CONTACT COOLING AND HEATING WATER SUBCATEGORY  
(RAW WASTEWATER)

Pollutant	Process Code\$	Sample Type†	Source	Concentrations (mg/l)			Duplicate
				Day 1	Day 2	Day 3	
<u>Priority Pollutants (Continued)</u>							
55. naphthalene	B-1	1	ND	ND			
	B-2	1	ND	ND			
	B-4	1	ND	ND			ND
	C-1	3	ND	ND	ND	ND	
	D-3	1	ND	ND			
	E-2	3	ND	ND	ND	ND	ND
	E-3	3	ND	ND	ND	ND	
	F-1	3	ND	0.018	ND	ND	
	F-2	3	ND	ND	ND	ND	
	F-6	3	ND	ND	ND	ND	
	G-1	3	ND	ND	ND		
	J-1	2	ND	ND			
	J-2	2	ND	ND			ND
	K-2	3	ND	ND	ND	ND	
	K-3	3	ND	ND	ND	ND	ND
	K-4	3	ND	ND	ND	ND	
56. nitrobenzene	B-1	1	ND	ND			
	B-2	1	ND	ND			
	B-4	1	ND	ND			ND
	C-1	3	ND	ND	ND	ND	
	D-3	1	*	ND			
	E-2	3	ND	ND	ND	ND	ND
	E-3	3	ND	ND	ND	ND	
	F-1	3	ND	ND	ND	ND	
	F-2	3	ND	ND	ND	ND	
	F-6	3	ND	ND	ND	ND	
	G-1	3	ND	ND	ND		
	J-1	2	ND	ND			
	J-2	2	ND	ND			ND
	K-2	3	ND/ND	ND	ND	ND	
	K-3	3	ND/ND	ND	ND	ND	ND
	K-4	3	ND/ND	ND	ND	ND	

Table A-1 (Continued)

SAMPLING DATA BY POLLUTANT FOR  
CONTACT COOLING AND HEATING WATER SUBCATEGORY  
(RAW WASTEWATER)

Pollutant	Process Code§	Sample Type†	Source	Concentrations (mg/l)			Duplicate
				Day 1	Day 2	Day 3	
<u>Priority Pollutants (Continued)</u>							
57. 2-nitrophenol	B-1	1	ND	ND			
	B-2	1	ND	ND			
	B-4	1	ND	ND			ND
	C-1	3	ND	0.001	0.003	ND	
	D-3	1	ND	ND			
	E-2	3	ND	ND	ND	ND	ND
	E-3	3	ND	ND	ND	ND	
	F-1	3	ND	ND	ND	ND	
	F-2	3	ND	ND	ND	ND	
	F-6	3	ND	ND	ND	ND	
	G-1	3	ND	ND	ND		
	J-1	2	ND	ND			
	J-2	2	ND	ND			ND
	K-2	3	ND/ND	*	0.001	0.001	
	K-3	3	ND/ND	ND	ND	ND	ND
	K-4	3	ND/ND	ND	ND	ND	
58. 4-nitrophenol	B-1	1	ND	ND			
	B-2	1	ND	ND			
	B-4	1	ND	ND			ND
	C-1	3	ND	ND	ND	ND	
	D-3	1	ND	ND			
	E-2	3	ND	ND	ND	ND	ND
	E-3	3	ND	ND	ND	ND	
	F-1	3	ND	ND	ND	ND	
	F-2	3	ND	ND	ND	ND	
	F-6	3	ND	ND	ND	ND	
	G-1	3	ND	ND	ND		
	J-1	2	ND	ND			
	J-2	2	ND	ND			ND
	K-2	3	0.007/*	*	ND	*	
	K-3	3	0.007/ND	ND	ND	ND	ND
	K-4	3	0.007/ND	ND	ND	0.004	

Table A-1 (Continued)

SAMPLING DATA BY POLLUTANT FOR  
CONTACT COOLING AND HEATING WATER SUBCATEGORY  
(RAW WASTEWATER)

Pollutant	Process Code§	Sample Type†	Source	Concentrations (mg/l)			Duplicate
				Day 1	Day 2	Day 3	
<u>Priority Pollutants (Continued)</u>							
60. 4,6-dinitro-o-cresol	B-1	1	ND	ND			
	B-2	1	ND	0.004			
	B-4	1	ND	ND			ND
	C-1	3	ND	ND	ND	ND	
	D-3	1	ND	ND			
	E-2	3	ND	ND	ND	ND	ND
	E-3	3	ND	ND	ND	ND	ND
	F-1	3	ND	ND	ND	ND	ND
	F-2	3	ND	ND	ND	ND	ND
	F-6	3	ND	ND	ND	ND	ND
	G-1	3	ND	ND	ND		
	J-1	2	ND	ND			
	J-2	2	ND	ND			ND
	K-2	3	ND/ND	ND	ND	ND	ND
	K-3	3	ND/ND	ND	ND	ND	ND
	K-4	3	ND/ND	ND	ND	ND	ND
61. N-nitrosodimethylamine	B-1	1	ND	ND			
	B-2	1	ND	ND			
	B-4	1	ND	ND			ND
	C-1	3	ND	ND	ND	ND	
	D-3	1	ND	ND			
	E-2	3	ND	ND	ND	ND	ND
	E-3	3	ND	ND	ND	ND	ND
	F-1	3	ND	ND	ND	ND	ND
	F-2	3	ND	ND	ND	ND	ND
	F-6	3	ND	ND	ND	ND	ND
	G-1	3	ND	ND	ND		
	J-1	2	ND	ND			
	J-2	2	ND	ND			ND
	K-2	3	ND/ND	ND	ND	ND	ND
	K-3	3	ND/ND	ND	ND	ND	ND
	K-4	3	ND/ND	ND	ND	ND	*

Table A-1 (Continued)

SAMPLING DATA BY POLLUTANT FOR  
CONTACT COOLING AND HEATING WATER SUBCATEGORY  
(RAW WASTEWATER)

Pollutant	Process Code\$	Sample Type†	Source	Concentrations (mg/l)			Duplicate
				Day 1	Day 2	Day 3	
<u>Priority Pollutants (Continued)</u>							
62. N-nitrosodiphenylamine	B-1	1	ND	*			
	B-2	1	ND	ND			
	B-4	1	ND	ND			ND
	C-1	3	ND	ND	ND	ND	
	D-3	1	ND	0.006			
	E-2	3	ND	ND	ND	ND	ND
	E-3	3	ND	ND	ND	ND	ND
	F-1	3	ND	ND	ND	ND	ND
	F-2	3	ND	ND	ND	ND	ND
	F-6	3	ND	ND	ND	ND	ND
	G-1	3	ND	ND	ND		
	J-1	2	ND	ND			
	J-2	2	ND	ND			ND
	K-2	3	*/0.001	ND	ND	ND	
	K-3	3	*/*	ND	ND	ND	ND
	K-4	3	*/*	ND	ND	ND	
	63. N-nitrosodi-n-propylamine	B-1	1	ND	ND		
B-2		1	ND	ND			
B-4		1	ND	ND			ND
C-1		3	ND	ND	ND	ND	
D-3		1	ND	ND			
E-2		3	ND	ND	ND	ND	ND
E-3		3	ND	ND	ND	ND	ND
F-1		3	ND	ND	ND	ND	ND
F-2		3	ND	ND	ND	ND	ND
F-6		3	ND	ND	ND	ND	ND
G-1		3	0.015	ND	ND		
J-1		2	ND	ND			
J-2		2	ND	ND			ND
K-2		3	ND/ND	ND	ND	ND	ND
K-3		3	ND/ND	ND	ND	ND	ND
K-4		3	ND/ND	ND	ND	ND	ND

Table A-1 (Continued)

SAMPLING DATA BY POLLUTANT FOR  
CONTACT COOLING AND HEATING WATER SUBCATEGORY  
(RAW WASTEWATER)

<u>Pollutant</u>	<u>Process Code</u>	<u>Sample Type</u>	<u>Source</u>	<u>Concentrations (mg/l)</u>			<u>Duplicate</u>
				<u>Day 1</u>	<u>Day 2</u>	<u>Day 3</u>	
<u>Priority Pollutants (Continued)</u>							
64. pentachlorophenol	B-1	1	ND	ND			
	B-2	1	ND	ND			
	B-4	1	ND	ND			ND
	C-1	3	ND	ND	ND	ND	
	D-3	1	ND	ND			
	E-2	3	ND	ND	ND	ND	ND
	E-3	3	ND	ND	ND	ND	
	F-1	3	ND	ND	ND	ND	
	F-2	3	ND	ND	ND	ND	
	F-6	3	ND	ND	ND	ND	
	G-1	3	ND	ND	ND	ND	
	J-1	2	ND	4.880+++			
	J-2	2	ND	6.000+++			5.730+++
	K-2	3	ND	ND	ND	ND	
	K-3	3	ND	ND	ND	ND	ND
K-4	3	ND	ND	ND	ND		
65. phenol	B-1	1	0.010	0.028			
	B-2	1	0.01	0.01			
	B-4	1	0.010	0.318			0.334
	C-1	3	*	0.780	0.810	0.91	
	D-3	1	*	ND			
	E-2	3	ND	ND	ND	ND	ND
	E-3	3	ND	ND	ND	ND	
	F-1	3	*	*	0.005	0.017	
	F-2	3	*	*	*	*	
	F-6	3	*	*	*	0.36	
	G-1	3	ND	0.179	0.434		
	J-1	2	ND	ND			
	J-2	2	ND	ND			ND
	K-2	3	ND/ND	ND	ND	0.012	
	K-3	3	ND/ND	ND	ND	0.0005	ND
K-4	3	ND/ND	ND	ND	0.002		

Table A-1 (Continued)

SAMPLING DATA BY POLLUTANT FOR  
CONTACT COOLING AND HEATING WATER SUBCATEGORY  
(RAW WASTEWATER)

Pollutant	Process Code\$	Sample Type†	Source	Concentrations (mg/l)			Duplicate
				Day 1	Day 2	Day 3	
<u>Priority Pollutants (Continued)</u>							
66. bis(2-ethylhexyl)phthalate	B-1	1	0.001	0.001			
	B-2	1	0.001	0.007			
	B-4	1	0.001	0.006			0.010
	C-1	3	0.003	0.048	0.024	0.011	
	D-3	1	0.289	0.017			
	E-2	3	0.00066	0.0017	0.00042	0.00063	0.0034
	E-3	3	0.00066	0.00085	0.002	0.00048	
	F-1	3	0.001	0.003	0.020	0.009	
	F-2	3	0.001	0.004	0.003	0.002	
	F-6	3	0.001	0.001	0.063	0.033	
	G-1	3	ND	ND	1.72		
	J-1	2	0.002	0.481			
	J-2	2	0.002	0.050			0.051
	K-2	3	0.005/0.113	0.240	0.258	1.006	
	K-3	3	0.005/0.161	0.072	0.107	0.314	0.122
	K-4	3	0.005/0.008	0.005	0.001	0.188	
67. butyl benzyl phthalate	B-1	1	ND	ND			
	B-2	1	ND	ND			
	B-4	1	ND	ND			ND
	C-1	3	ND	ND	ND	ND	
	D-3	1	ND	ND			
	E-2	3	ND	ND	ND	ND	ND
	E-3	3	ND	ND	0.00049	ND	
	F-1	3	ND	ND	0.006	0.004	
	F-2	3	ND	ND	ND	ND	
	F-6	3	ND	ND	*	ND	
	G-1	3	0.003	ND	ND		
	J-1	2	ND	ND			
	J-2	2	ND	ND			ND
	K-2	3	ND/ND	ND	ND	ND	
K-3	3	ND/ND	ND	ND	ND	ND	
K-4	3	ND/ND	ND	ND	ND		

Table A-1 (Continued)

SAMPLING DATA BY POLLUTANT FOR  
CONTACT COOLING AND HEATING WATER SUBCATEGORY  
(RAW WASTEWATER)

Pollutant	Process Code <sup>s</sup>	Sample Type <sup>t</sup>	Source	Concentrations (mg/l)			Duplicate
				Day 1	Day 2	Day 3	
<u>Priority Pollutants (Continued)</u>							
68. di-n-butyl phthalate	B-1	1	0.003	0.001			
	B-2	1	0.003	0.008			
	B-4	1	0.003	0.003			0.004
	C-1	3	*	0.003	0.003	0.001	
	D-3	1	0.003	0.012			
	E-2	3	0.000725	0.0011	0.00043	0.00071	0.0010
	E-3	3	0.000725	0.0078	0.0014	0.0011	
	F-1	3	*	0.001	0.003	0.003	
	F-2	3	*	0.003	0.002	0.003	
	F-6	3	*		*	*	
	G-1	3	ND	0.0010	0.0023		
	J-1	2	0.0105	0.013			
	J-2	2	0.0105	0.011			0.012
	K-2	3	0.005/ND	0.004	0.004	0.011	
	K-3	3	0.005/0.004	0.009	0.004	ND	0.005
	K-4	3	0.005/ND	0.006	0.007	ND	
69. di-n-octyl phthalate	B-1	1	ND	ND			
	B-2	1	ND	ND			
	B-4	1	ND	ND			ND
	C-1	3	ND	0.004	0.004	ND	
	D-3	1	ND	ND			
	E-2	3	ND	ND	ND	ND	ND
	E-3	3	ND	ND	0.00032	ND	
	F-1	3	ND	*	ND	0.002	
	F-2	3	ND	ND	ND	ND	
	F-6	3	ND	ND	ND	ND	
	G-1	3	0.005	ND	0.020		
	J-1	2	ND	ND			
	J-2	2	ND	ND			ND
	K-2	3	ND/ND	ND	ND	ND	
	K-3	3	ND/ND	ND	ND	0.021	ND
	K-4	3	ND/ND	ND	ND	ND	

A-38



Table A-1 (Continued)

SAMPLING DATA BY POLLUTANT FOR  
CONTACT COOLING AND HEATING WATER SUBCATEGORY  
(RAW WASTEWATER)

Pollutant	Process Code\$	Sample Type†	Source	Concentrations (mg/l)			Duplicate
				Day 1	Day 2	Day 3	
<u>Priority Pollutants (Continued)</u>							
70. diethyl phthalate	B-1	1	*	0.002			
	B-2	1	*	0.001			
	B-4	1	*	*			*
	C-1	3	ND	*	*	ND	
	D-3	1	ND	ND			
	E-2	3	0.00082	0.0013	0.00054	0.00074	0.00094
	E-3	3	0.00082	0.0011	0.0018	0.00080	
	F-1	3	ND	*	ND	ND	
	F-2	3	ND	*	ND	ND	
	F-6	3	ND	ND	*	ND	
	G-1	3	ND	0.621	0.964		
	J-1	2	0.0005	ND			
	J-2	2	0.005	0.001			0.001
	K-2	3	ND/ND	ND	ND	*	
	K-3	3	ND/ND	ND	ND	ND	ND
	K-4	3	ND/*	ND	*	ND	
71. dimethyl phthalate	B-1	1	ND	ND			
	B-2	1	ND	ND			
	B-4	1	ND	ND			ND
	C-1	3	ND	ND	ND	ND	
	D-3	1	ND	ND			
	E-2	3	ND	ND	ND	ND	ND
	E-3	3	ND	ND	ND	ND	
	F-1	3	ND	ND	0.003	0.002	
	F-2	3	ND	ND	ND	ND	
	F-6	3	ND	ND	ND	ND	
	G-1	3	ND	0.001	0.087		
	J-1	2	ND	ND			
	J-2	2	ND	ND			ND
	K-2	3	ND/ND	ND	ND	ND	
	K-3	3	ND/0.003	ND	ND	ND	ND
	K-4	3	ND/ND	ND	ND	ND	

Table A-1 (Continued)

SAMPLING DATA BY POLLUTANT FOR  
CONTACT COOLING AND HEATING WATER SUBCATEGORY  
(RAW WASTEWATER)

Pollutant	Process Codes	Sample Type	Concentrations (mg/l)			Duplicate	
			Source	Day 1	Day 2		Day 3
<u>Priority Pollutants (Continued)</u>							
72. benzo(a)anthracene	B-1	1	ND	ND			
	B-2	1	ND	ND			
	B-4	1	ND	ND		ND	
	C-1	3	ND	*	ND	ND	
	D-3	1	ND	ND			
	E-2	3	*	ND	ND	ND	ND
	E-3	3	ND	ND	0.00053	ND	
	F-1	3	ND	ND	ND	ND	
	F-2	3	ND	ND	ND	ND	
	F-6	3	ND	ND	ND	ND	
	G-1	3	ND	*	ND		
	J-1	2	ND	ND			
	J-2	2	ND	ND			ND
	K-2	3	ND/ND	ND	ND	ND	
	K-3	3	ND/ND	ND	ND	ND	ND
	K-4	3	ND/ND	ND	ND	ND	
73. benzo(a)pyrene	B-1	1	ND	ND			
	B-2	1	ND	ND			
	B-4	1	ND	ND		ND	
	C-1	3	ND	ND	ND	ND	
	D-3	1	ND	0.012			
	E-2	3	ND	ND	ND	ND	ND
	E-3	3	ND	ND	ND	ND	
	F-1	3	ND	ND	ND	ND	
	F-2	3	ND	ND	ND	ND	
	F-6	3	ND	ND	ND	ND	
	G-1	3	ND	*	ND		
	J-1	2	ND	0.001			
	J-2	2	ND	ND			ND
	K-2	3	ND/ND	ND	ND	ND	
	K-3	3	ND/*	ND	ND	ND	ND
	K-4	3	ND/ND	ND	ND	ND	

Table A-1 (Continued)

SAMPLING DATA BY POLLUTANT FOR  
CONTACT COOLING AND HEATING WATER SUBCATEGORY  
(RAW WASTEWATER)

<u>Pollutant</u>	<u>Process Code</u>	<u>Sample Type</u>	<u>Source</u>	<u>Concentrations (mg/l)</u>			<u>Duplicate</u>
				<u>Day 1</u>	<u>Day 2</u>	<u>Day 3</u>	
<u>Priority Pollutants (Continued)</u>							
76. chrysene	B-1	1	ND	ND			
	B-2	1	ND	ND			
	B-4	1	ND	ND			ND
	C-1	3	ND	*	ND	ND	
	D-3	1	ND	ND			
	E-2	3	ND	ND	ND	ND	ND
	E-3	3	ND	ND	ND	ND	
	F-1	3	ND	ND	ND	ND	
	F-2	3	ND	ND	ND	ND	
	F-6	3	ND	ND	ND	ND	
	G-1	3	ND	ND	ND		
	J-1	2	ND	ND			
	J-2	2	ND	ND			ND
	K-2	3	ND/0.004	ND	ND	ND	
	K-3	3	ND/ND	ND	ND	ND	ND
K-4	3	ND/ND	ND	ND	ND		
78. anthracene	B-1	1	ND	ND			
	B-2	1	ND	ND			
	B-4	1	ND	ND			ND
	C-1	3	ND	*	*	*	
	D-3	1	ND	ND			
	E-2	3	ND	ND	ND	ND	ND
	E-3	3	ND	ND	0.00019	ND	
	F-1	3	ND	ND	ND	ND	
	F-2	3	ND	ND	ND	ND	
	F-6	3	ND	ND	ND	ND	
	G-1	3	ND	ND	ND		
	J-1	2	ND	ND			
	J-2	2	ND	ND			ND
	K-2	3	ND/ND	ND	ND	ND	
	K-3	3	ND/ND	ND	ND	ND	ND
K-4	3	ND/ND	0.004	0.004	ND		

A-41

Table A-1 (Continued)

SAMPLING DATA BY POLLUTANT FOR  
CONTACT COOLING AND HEATING WATER SUBCATEGORY  
(RAW WASTEWATER)

Pollutant	Process Codes	Sample Type	Source	Concentrations (mg/l)			Duplicate
				Day 1	Day 2	Day 3	
<u>Priority Pollutants (Continued)</u>							
80. fluorene	B-1	1	ND	ND			
	B-2	1	ND	ND			
	B-4	1	ND	ND			ND
	C-1	3	ND	ND	*	ND	
	D-3	1	*	ND			
	E-2	3	ND	ND	ND	ND	ND
	E-3	3	ND	ND	0.00039	ND	
	F-1	3	ND	ND	ND	ND	
	F-2	3	ND	ND	ND	ND	
	F-6	3	ND	ND	ND	ND	
	G-1	3	ND	ND	ND		
	J-1	2	ND	ND			
	J-2	2	ND	ND			ND
	K-2	3	ND/ND	ND	ND	ND	ND
	K-3	3	ND/ND	ND	ND	ND	ND
	K-4	3	ND/ND	ND	ND	ND	ND
81. phenanthrene	B-1	1	ND	ND			
	B-2	1	ND	ND			
	B-4	1	ND	ND			ND
	C-1	3	ND	*	*	*	
	D-3	1	ND	ND			
	E-2	3	ND	ND	ND	ND	ND
	E-3	3	ND	ND	0.00067	ND	
	F-1	3	ND	ND	ND	ND	
	F-2	3	ND	ND	ND	ND	
	F-6	3	ND	ND	ND	ND	
	G-1	3	ND	ND	ND		
	J-1	2	ND	ND			
	J-2	2	ND	ND			ND
	K-2	3	ND/ND	ND	ND	ND	ND
	K-3	3	ND/ND	ND	ND	ND	ND
	K-4	3	ND/ND	ND	ND	ND	ND

Table A-1 (Continued)

SAMPLING DATA BY POLLUTANT FOR  
CONTACT COOLING AND HEATING WATER SUBCATEGORY  
(RAW WASTEWATER)

Pollutant	Process Code§	Sample Type†	Source	Concentrations (mg/l)			Duplicate
				Day 1	Day 2	Day 3	
<u>Priority Pollutants (Continued)</u>							
85. tetrachloroethylene	B-1	2	ND	ND			
	B-2	2	ND	ND			
	B-4	2	ND	ND			ND
	C-1	2	0.019	*	*	*	
	D-3	2	ND	ND			
	E-2	2	ND	ND	ND	ND	ND
	E-3	2	ND	ND	ND	ND	
	F-1	2	ND	ND	ND	ND	
	F-2	2	ND	ND	ND	ND	
	F-6	2	ND	ND	ND	ND	
	G-1	2	0.012	0.004	0.014		
	J-1	2	ND	ND			
	J-2	2	0.001	ND			ND
	K-2	2	ND/ND	ND	ND	ND	
	K-3	2	ND/ND	ND	ND	ND	ND
	K-4	2	ND/ND	0.001/ND	ND/ND	ND/ND	
	86. toluene	B-1	2	ND	ND		
B-2		2	ND	ND			
B-4		2	ND	ND			ND
C-1		2	*	0.006	0.005	0.002	
D-3		2	ND	ND			
E-2		2	ND	0.0022	ND	ND	0.0025
E-3		2	ND	ND	ND	ND	
F-1		2	*	*	*	*	
F-2		2	*	0.008	0.015	0.002	
F-6		2	*	*	0.002	*	
G-1		2	ND	ND	ND		
J-1		2	0.012	ND			
J-2		2	0.012	ND			ND
K-2		2	ND/0.016	ND	ND	ND	
K-3		2	ND/ND	ND	0.016	0.016	0.016
K-4		2	ND/ND	ND/ND	ND/ND	ND/ND	

A-43

Table A-1 (Continued)

SAMPLING DATA BY POLLUTANT FOR  
CONTACT COOLING AND HEATING WATER SUBCATEGORY  
(RAW WASTEWATER)

<u>Pollutant</u>	<u>Process Code</u>	<u>Sample Type</u>	<u>Source</u>	<u>Concentrations (mg/l)</u>			<u>Duplicate</u>
				<u>Day 1</u>	<u>Day 2</u>	<u>Day 3</u>	
<u>Priority Pollutants (Continued)</u>							
87. trichloroethylene	B-1	2	ND	ND			
	B-2	2	ND	ND			
	B-4	2	ND	ND			ND
	C-1	2	0.004	ND	*	ND	
	D-3	2	ND	ND			
	E-2	2	ND	ND	0.0011	ND	ND
	E-3	2	ND	ND	ND	ND	
	F-1	2	ND	ND	ND	ND	
	F-2	2	ND	ND	ND	ND	
	F-6	2	ND	ND	ND	ND	
	G-1	2	0.343	0.146	0.215		
	J-1	2	0.050	ND			
	J-2	2	0.050	0.003			0.002
	K-2	2	ND/ND	ND	ND	ND	
	K-3	2	ND/ND	0.001	ND	ND	ND
	K-4	2	ND/0.0095	0.001/ND	ND/ND	ND/ND	
89. aldrin	B-1	1	ND	0.000003			
	B-2	1	ND	ND			
	B-4	1	ND	ND			ND
	C-1	3	**	**	**	ND	
	D-3	1	ND	ND			
	E-2	3	ND	ND	ND	ND	ND
	E-3	3	ND	ND	ND	ND	
	F-1	3	ND	0.0003	ND	ND	
	F-2	3	ND	**	ND	ND	
	F-6	3	ND	ND	ND	ND	
	G-1	3	ND	ND	ND		
	J-1	2	ND	ND			
	J-2	2	ND	ND			ND
	K-2	3	ND/ND	ND	ND	ND	
	K-3	3	ND/ND	ND	ND	ND	0.000023
	K-4	3	ND/ND	ND/ND	ND/ND	ND/ND	

A-44

Table A-1 (Continued)

SAMPLING DATA BY POLLUTANT FOR  
CONTACT COOLING AND HEATING WATER SUBCATEGORY  
(RAW WASTEWATER)

Pollutant	Process Codes	Sample Type	Source	Concentrations (mg/l)			Duplicate
				Day 1	Day 2	Day 3	
<u>Priority Pollutants (Continued)</u>							
90. dieldrin	B-1	1	ND	ND			
	B-2	1	ND	ND			
	B-4	1	ND	ND			ND
	C-1	3	ND	**	**		ND
	D-3	1	ND	ND			
	E-2	3	ND	ND	0.000086		ND
	E-3	3	ND	ND	ND		0.000034
	F-1	3	ND	ND	ND		ND
	F-2	3	ND	ND	**		**
	F-6	3	ND	ND	ND		ND
	G-1	3	ND	ND	ND		ND
	J-1	2	ND	ND	ND		
	J-2	2	ND	ND	ND		ND
	K-2	3	ND/ND	ND	ND		ND
	K-3	3	ND/ND	ND	ND		ND
	K-4	3	ND/ND	ND/ND	ND/ND		ND/ND
	92. 4,4'-DDT	B-1	1	ND	ND		
B-2		1	ND	ND			
B-4		1	ND	ND			ND
C-1		3	ND	ND	ND		ND
D-3		1	ND	ND			
E-2		3	ND	ND	ND		ND
E-3		3	ND	ND	ND		ND
F-1		3	ND	ND	ND		ND
F-2		3	ND	ND	ND		ND
F-6		3	ND	ND	ND		ND
G-1		3	ND	ND	ND		ND
J-1		2	ND	ND	ND		
J-2		2	ND	ND	ND		ND
K-2		3	ND/ND	ND	ND		0.000022
K-3		3	ND/ND	ND	ND		ND
K-4		3	ND/ND	ND/ND	ND/ND		ND/ND

A-45

Table A-1 (Continued)

SAMPLING DATA BY POLLUTANT FOR  
CONTACT COOLING AND HEATING WATER SUBCATEGORY  
(RAW WASTEWATER)

Pollutant	Process Codes	Sample Type	Concentrations (mg/l)				Duplicate
			Source	Day 1	Day 2	Day 3	
<u>Priority Pollutants (Continued)</u>							
93. 4,4'-DDE	B-1	1	ND	ND			
	B-2	1	ND	ND			
	B-4	1	ND	ND			ND
	C-1	3	ND	ND	ND	ND	
	D-3	1	ND	ND			
	E-2	3	ND	ND	ND	ND	0.000027
	E-3	3	ND	ND	ND	ND	
	F-1	3	ND	ND	ND	ND	
	F-2	3	ND	ND	ND	ND	
	F-6	3	ND	ND	ND	ND	
	G-1	3	ND	ND	ND		
	J-1	2	ND	ND			
	J-2	2	ND	ND			ND
	K-2	3	ND/ND	ND	ND	ND	
	K-3	3	ND/0.000023	ND	ND	ND	0.000045 ND
K-4	3	ND/ND	ND/ND	ND/ND	ND/ND		
94. 4,4'-DDD	B-1	1	ND	ND			
	B-2	1	ND	ND			
	B-4	1	ND	ND			ND
	C-1	3	ND	ND	ND	ND	
	D-3	1	ND	ND			
	E-2	3	ND	ND	ND	ND	ND
	E-3	3	ND	0.000040	ND	ND	
	F-1	3	ND	ND	ND	ND	
	F-2	3	ND	ND	ND	ND	
	F-6	3	ND	ND	ND	ND	
	G-1	3	ND	ND	ND		
	J-1	2	ND	ND			
	J-2	2	ND	ND			ND
	K-2	3	ND/ND	ND	ND	ND	
	K-3	3	ND/ND	ND	ND	ND	ND
K-4	3	ND/ND	ND/ND	ND/ND	ND/ND		

97-A



Table A-1 (Continued)

SAMPLING DATA BY POLLUTANT FOR  
CONTACT COOLING AND HEATING WATER SUBCATEGORY  
(RAW WASTEWATER)

Pollutant	Process Code§	Sample Type†	Source	Concentrations (mg/l)			Duplicate
				Day 1	Day 2	Day 3	
<u>Priority Pollutants (Continued)</u>							
97. endosulfan sulfate	B-1	1	ND	ND			
	B-2	1	ND	ND			
	B-4	1	ND	ND			ND
	C-1	3	ND	ND	ND	ND	
	D-3	1	ND	ND			
	E-2	3	ND	ND	ND	ND	ND
	E-3	3	ND	ND	ND	ND	
	F-1	3	ND	ND	ND	ND	
	F-2	3	ND	ND	ND	ND	
	F-6	3	ND	ND	ND	ND	
	G-1	3	ND	ND	ND		
	J-1	2	ND	ND			
	J-2	2	ND	ND			ND
	K-2	3	ND/ND	ND	ND	ND	
	K-3	3	ND/ND	0.00013	ND	ND	ND
	K-4	3	ND/ND	ND	ND	ND	
98. endrin	B-1	1	ND	ND			
	B-2	1	ND	ND			
	B-4	1	ND	ND			ND
	C-1	3	ND	ND	**	ND	
	D-3	1	ND	ND			
	E-2	3	ND	ND	ND	ND	ND
	E-3	3	ND	ND	ND	ND	
	F-1	3	ND	ND	ND	ND	
	F-2	3	ND	ND	**	ND	
	F-6	3	ND	ND	ND	ND	
	G-1	3	ND	ND	ND		
	J-1	2	ND	ND			
	J-2	2	ND	ND			ND
	K-2	3	ND	ND	ND	ND	
	K-3	3	ND	ND	ND	ND	ND
	K-4	3	ND	ND	ND	ND	

A-47

Table A-1 (Continued)

SAMPLING DATA BY POLLUTANT FOR  
CONTACT COOLING AND HEATING WATER SUBCATEGORY  
(RAW WASTEWATER)

Pollutant	Process Code\$	Sample Type†	Source	Concentrations (mg/l)			Duplicate
				Day 1	Day 2	Day 3	
<u>Priority Pollutants (Continued)</u>							
99. endrin aldehyde	B-1	1	ND	0.000066			
	B-2	1	ND	ND			
	B-4	1	ND	0.000031			0.000066
	C-1	3	ND	ND	ND	ND	
	D-3	1	ND	ND			
	E-2	3	ND	ND	ND	ND	ND
	E-3	3	ND	ND	ND	ND	
	F-1	3	ND	ND	ND	ND	
	F-2	3	ND	ND	ND	ND	
	F-6	3	ND	ND	ND	ND	
	G-1	3	ND	ND	ND		
	J-1	2	ND	ND			
	J-2	2	ND	ND			ND
	K-2	3	ND/ND	ND	ND	ND	
	K-3	3	ND/ND	ND	ND	ND	ND
	K-4	3	ND/ND	ND	ND	ND	
100. heptachlor	B-1	1	0.000003	0.000002			
	B-2	1	0.000003	ND			
	B-4	1	0.000003	ND			ND
	C-1	3	ND	ND	ND	ND	
	D-3	1	ND	ND			
	E-2	3	ND	ND	ND	ND	ND
	E-3	3	ND	ND	ND	ND	
	F-1	3	ND	ND	ND	ND	
	F-2	3	ND	ND	ND	ND	
	F-6	3	ND	ND	ND	ND	
	G-1	3	ND	ND	ND		
	J-1	2	ND	ND			
	J-2	2	ND	ND			ND
	K-2	3	ND/ND	0.000026	0.000028	ND	
	K-3	3	ND/ND	ND	ND	ND	ND
	K-4	3	ND/ND	ND	ND	ND	

Table A-1 (Continued)

SAMPLING DATA BY POLLUTANT FOR  
CONTACT COOLING AND HEATING WATER SUBCATEGORY  
(RAW WASTEWATER)

Pollutant	Process Code\$	Sample Type†	Source	Concentrations (mg/l)			Duplicate
				Day 1	Day 2	Day 3	
<u>Priority Pollutants (Continued)</u>							
101. heptaclor expoxide	B-1	1	ND	ND			
	B-2	1	ND	ND			
	B-4	1	ND	ND			ND
	C-1	3	ND	ND	ND	ND	
	D-3	1	ND	ND			
	E-2	3	ND	ND	ND	0.00004	ND
	E-3	3	ND	ND	ND	ND	
	F-1	3	ND	ND	ND	ND	
	F-2	3	ND	ND	ND	ND	
	F-6	3	ND	ND	ND	ND	
	G-1	3	ND	ND	ND		
	J-1	2	ND	ND			
	J-2	2	ND	ND			ND
	K-2	3	ND/ND	ND	ND	ND	
	K-3	3	ND/ND	ND	ND	ND	ND
K-4	3	ND/ND	ND	ND	ND		
102. alpha-BHC	B-1	1	0.000003	0.000005			
	B-2	1	0.000003	0.000004			
	B-4	1	0.000003	0.000004			0.000007
	C-1	3	ND	ND	ND	ND	
	D-3	1	ND	ND			
	E-2	3	0.000121	ND	ND	0.000108	ND
	E-3	3	0.000121	0.000182	0.000178	0.000194	
	F-1	3	ND	ND	ND	ND	
	F-2	3	ND	ND	0.0006	ND	
	F-6	3	ND	ND	ND	ND	
	G-1	3	ND	ND	0.000009		
	J-1	2	0.000025	0.00022			
	J-2	2	0.000025	0.00029			ND
	K-2	3	0.000021/ 0.000008	0.000036	0.000134	0.000191	
	K-3	3	ND/0.000083	ND	0.000078	0.000113	ND
K-4	3	ND/0.000076	ND	ND	ND		

A-49

Table A-1 (Continued)

SAMPLING DATA BY POLLUTANT FOR  
CONTACT COOLING AND HEATING WATER SUBCATEGORY  
(RAW WASTEWATER)

Pollutant	Process Code\$	Sample Type†	Source	Concentrations (mg/l)			Duplicate
				Day 1	Day 2	Day 3	
<u>Priority Pollutants (Continued)</u>							
103. beta-BHC	B-1	1	ND	ND			
	B-2	1	ND	ND			
	B-4	1	ND	ND			ND
	C-1	3	ND	ND	ND	0.0006	
	D-3	1	0.000181	0.00014			
	E-2	3	ND	ND	ND	ND	ND
	E-3	3	ND	ND	ND	ND	
	F-1	3	ND	ND	ND	ND	
	F-2	3	ND	ND	ND	ND	
	F-6	3	ND	ND	ND	ND	
	G-1	3	0.000166	ND	ND		
	J-1	2	ND	ND			
	J-2	2	ND	ND			ND
	K-2	3	ND/0.000025	0.000062	0.000072	0.000335	
	K-3	3	0.000021/ 0.000046	0.000035	0.000047	0.000183	0.000043
	K-4	3	0.000021/ 0.000050	0.000025	0.000041	ND	
	104. gamma-BHC	B-1	1	ND	0.000002		
B-2		1	ND	ND			
B-4		1	ND	ND			ND
C-1		3	ND	**	ND	ND	
D-3		1	0.000006	0.000099			
E-2		3	0.000110	ND	0.000349	0.000057	ND
E-3		3	0.00011	0.000122	ND	0.000096	
F-1		3	**	ND	ND	ND	
F-2		3	**	ND	0.0003	ND	
F-6		3	**	ND	ND	ND	
G-1		3	ND	ND	ND		
J-1		2	0.000025	ND			
J-2		2	0.000025	ND			ND
K-2		3	0.000018/ND	0.000032	0.000038	0.000076	
K-3		3	ND/0.000027	0.000018	ND	0.000061	0.000022
K-4		3	ND/ND	ND	ND	ND	

Table A-1 (Continued)

SAMPLING DATA BY POLLUTANT FOR  
CONTACT COOLING AND HEATING WATER SUBCATEGORY  
(RAW WASTEWATER)

Pollutant	Process Code\$	Sample Type†	Concentrations (mg/l)			Duplicate
			Source	Day 1	Day 2	
<u>Priority Pollutants (Continued)</u>						
105. delta-BHC	B-1	1	0.000005	0.000009		
	B-2	1	0.000005	0.000006		
	B-4	1	0.000005	0.000005		0.000005
	C-1	3	**	**	ND	ND
	D-3	1	ND	ND		
	E-2	3	ND	ND	ND	ND
	E-3	3	ND	ND	ND	ND
	F-1	3	ND	ND	ND	ND
	F-2	3	ND	ND	ND	ND
	F-6	3	ND	ND	ND	ND
	G-1	3	ND	ND	ND	
	J-1	2	0.0000085	0.000035		
	J-2	2	0.0000085	ND		ND
	K-2	3	0.000018/ND	ND	0.000039	ND
	K-3	3	0.000018/ND	ND	0.000027	ND
K-4	3	0.000018/ND	0.000058	0.000061	0.000107	
114. antimony	B-1	1	ND	ND		
	B-2	1	ND	ND		
	B-4	1	ND	ND		ND
	C-1	3	ND	ND	ND	ND
	D-3	1	ND	ND		
	E-2	3	0.002	0.002	0.004	0.003
	E-3	3	0.002	ND	0.003	0.003
	F-1	3	ND	ND	ND	ND
	F-2	3	ND	ND	ND	ND
	F-6	3	ND	ND	ND	ND
	G-1	3	ND	ND	ND	
	J-1	2	ND	ND		
	J-2	2	ND	ND		
	K-2	3/1	ND/0.04	0.02	0.03	0.03
	K-3	3/1	ND/ND	ND	ND	ND
K-4	3/1	ND/ND	ND	ND	ND	

A-51

Table A-1 (Continued)

SAMPLING DATA BY POLLUTANT FOR  
CONTACT COOLING AND HEATING WATER SUBCATEGORY  
(RAW WASTEWATER)

Pollutant	Process Code\$	Sample Type†	Source	Concentrations (mg/l)			Duplicate
				Day 1	Day 2	Day 3	
<u>Priority Pollutants (Continued)</u>							
115. arsenic	B-1	1	ND	ND			
	B-2	1	ND	ND			
	B-4	1	ND	ND			
	C-1	3	ND	ND	ND	ND	
	D-3	1	ND	ND			
	E-2	3	ND	ND	ND	ND	
	E-3	3	ND	ND	ND	ND	0.001
	F-1	3	ND	ND	ND	ND	ND
	F-2	3	ND	ND	ND	ND	ND
	F-6	3	ND	ND	ND	ND	ND
	G-1	3	ND	ND	ND	ND	
	J-1	2	ND	0.016			
	J-2	2	ND	ND			
	K-2	3/1	ND/ND	ND	ND	ND	ND
	K-3	3/1	ND/ND	ND	ND	ND	ND
	K-4	3/1	ND/ND	ND	ND	ND	ND
117. beryllium	B-1	1	ND	ND			
	B-2	1	ND	ND			
	B-4	1	ND	ND			ND
	C-1	3	ND	ND	ND	ND	
	D-3	1	ND	ND			
	E-2	3	ND	ND	ND	ND	
	E-3	3	ND	ND	ND	ND	
	F-1	3	ND	ND	ND	ND	
	F-2	3	ND	ND	ND	ND	
	F-6	3	ND	ND	ND	ND	
	G-1	3	ND	0.003	0.003		
	J-1	2	ND	ND			
	J-2	2	ND	ND			
	K-2	3/1	ND/ND	ND	ND	ND	ND
	K-3	3/1	ND/ND	ND	ND	ND	ND
	K-4	3/1	ND/ND	ND	ND	ND	ND

Table A-1 (Continued)

SAMPLING DATA BY POLLUTANT FOR  
CONTACT COOLING AND HEATING WATER SUBCATEGORY  
(RAW WASTEWATER)

Pollutant	Process Code§	Sample Type†	Source	Concentrations (mg/l)			Duplicate
				Day 1	Day 2	Day 3	
<u>Priority Pollutants (Continued)</u>							
118. cadmium	B-1	1	ND	ND			
	B-2	1	ND	ND			
	B-4	1	ND	ND			
	C-1	3	ND	0.025	0.019	0.015	
	D-3	1	ND	ND			
	E-2	3	0.005	0.006	0.005	0.006	
	E-3	3	0.005	0.006	0.003	0.006	
	F-1	3	ND	ND	ND	ND	
	F-2	3	ND	ND	ND	ND	
	F-6	3	ND	ND	0.053	0.071	
	G-1	3	ND	ND	ND		
	J-1	2	0.018	0.014			
	J-2	2	0.018	0.017			
	K-2	3/1	ND/ND	ND	ND	ND	
	K-3	3/1	ND/ND	ND	ND	ND	
	K-4	3/1	ND/ND	ND	ND	ND	
	119. chromium	B-1	1	ND	ND		
B-2		1	ND	ND			
B-4		1	ND	ND			
C-1		3	ND	0.200	0.170	0.012	
D-3		1	0.010	0.015			
E-2		3	ND	0.007	0.008	0.003	
E-3		3	ND	0.009	0.008	ND	
F-1		3	ND	ND	ND	ND	
F-2		3	ND	ND	ND	0.073	
F-6		3	ND	ND	ND	ND	
G-1		3	ND	0.143	0.077		
J-1		2	ND	ND			
J-2		2	ND	ND			
K-2		3/1	ND/0.02	ND	ND	ND	
K-3		3/1	ND/ND	ND	ND	ND	
K-4		3/1	ND/ND	ND	ND	ND	

Table A-1 (Continued)

SAMPLING DATA BY POLLUTANT FOR  
CONTACT COOLING AND HEATING WATER SUBCATEGORY  
(RAW WASTEWATER)

Pollutant	Process Code§	Sample Type†	Concentrations (mg/l)				Duplicate
			Source	Day 1	Day 2	Day 3	
<u>Priority Pollutants (Continued)</u>							
120. copper	B-1	1	2.600	1.200			
	B-2	1	2.6	2.2			
	B-4	1	2.600	1.550			
	C-1	3	0.068	0.940	0.530	0.310	
	D-3	1	0.106	0.106			
	E-2	3	0.196	0.058	0.055	0.066	
	E-3	3	0.196	0.058	0.061	0.060	
	F-1	3	0.700	0.034	0.026	0.036	
	F-2	3	0.7	0.016	ND	ND	
	F-6	3	0.7		0.022	0.041	
	G-1	3	ND	0.06	0.045		
	J-1	2	ND	ND			
	J-2	2	ND	0.037			
	K-2	3/1	ND/ND	ND	ND	ND	
	K-3	3/1	ND/0.1	0.05	0.1	0.1	
	K-4	3/1	ND/0.1	ND	ND	ND	
121. cyanide (total)	B-1	1	<0.01	<0.01			
	B-2	1	<0.01	<0.01			
	B-4	1	<0.01	<0.01			<0.01
	C-1	1	0	0	0	0	
	D-3	1	<0.02	<0.02			<0.02
	E-2	1	<0.01	<0.01	<0.01	<0.01	
	E-3	1	<0.01	<0.01	<0.01	<0.01	
	F-1	1	<0.02	<0.02	<0.02	<0.02	
	F-2	1	<0.02	<0.02	<0.02	<0.02	
	F-6	1	<0.02	<0.02	<0.02	<0.02	
	G-1	2	<0.02	<0.02	<0.02		
	J-1	2	<0.01	<0.01			
	J-2	2	<0.01	ND			ND
	K-2	1	<0.02/<0.02	<0.02	<0.02	<0.02	
	K-3	1	<0.02/<0.02	<0.02	<0.02	<0.02	<0.02
	K-4	1	<0.02/<0.02	<0.02	<0.02	<0.02	



Table A-1 (Continued)

SAMPLING DATA BY POLLUTANT FOR  
CONTACT COOLING AND HEATING WATER SUBCATEGORY  
(RAW WASTEWATER)

Pollutant	Process Code§	Sample Type†	Source	Concentrations (mg/l)			Duplicate
				Day 1	Day 2	Day 3	
<u>Priority Pollutants (Continued)</u>							
122. lead	B-1	1	ND	ND			
	B-2	1	ND	ND			
	B-4	1	ND	ND			
	C-1	3	ND	0.260	0.160	ND	
	D-3	1	ND	ND			
	E-2	3	0.080	0.122	0.292	0.126	
	E-3	3	0.080	0.057	0.059	0.064	
	F-1	3	ND	ND	ND	ND	
	F-2	3	ND	ND	ND	ND	
	F-6	3	ND	ND	ND	ND	
	G-1	3	ND	ND	ND		
	J-1	2	ND	ND			
	J-2	2	ND	ND			
	K-2	3/1	ND/0.25	0.15	0.15	0.10	
K-3	3/1	ND/0.05	0.1	ND	0.1		
K-4	3/1	ND/ND	ND	ND	0.5		
123. mercury	B-1	1	ND	ND			
	B-2	1	ND	ND			
	B-4	1	ND	ND			
	C-1	3	ND	0.0007	0.0003	0.0003	
	D-3	1	ND	ND			
	E-2	3	ND	ND	ND	ND	
	E-3	3	ND	ND	ND	ND	
	F-1	3	ND	ND	ND	ND	
	F-2	3	ND	ND	ND	ND	
	F-6	3	ND	ND	ND	ND	
	G-1	3	ND	ND	ND		
	J-1	2	ND	ND			
	J-2	2	ND	ND			
	K-2	3/1	ND	ND	ND	ND	
K-3	3/1	ND	ND	ND	ND		
K-4	3/1	ND	ND	ND	ND		

Table A-1 (Continued)

SAMPLING DATA BY POLLUTANT FOR  
CONTACT COOLING AND HEATING WATER SUBCATEGORY  
(RAW WASTEWATER)

Pollutant	Process Code§	Sample Type†	Source	Concentrations (mg/l)			Duplicate
				Day 1	Day 2	Day 3	
<u>Priority Pollutants (Continued)</u>							
124. nickel	B-1	1	ND	ND			
	B-2	1	ND	ND			
	B-4	1	ND	ND			
	C-1	3	ND	3.880	3.240	2.770	
	D-3	1	ND	ND			
	E-2	3	ND	0.012	0.021	ND	
	E-3	3	ND	0.021	0.014	ND	
	F-1	3	ND	ND	ND	ND	
	F-2	3	ND	ND	ND	ND	
	F-6	3	ND	ND	ND	ND	
	G-1	3	ND	0.073	ND		
	J-1	2	ND	ND			
	J-2	2	ND	ND			
	K-2	3/1	ND/ND	ND	ND	ND	
	K-3	3/1	ND/ND	ND	ND	ND	
K-4	3/1	ND/ND	ND	ND	ND		
125. selenium	B-1	1	ND	ND			
	B-2	1	ND	ND			
	B-4	1	ND	ND			
	C-1	3	ND	ND	ND	ND	
	D-3	1	ND	ND			
	E-2	3	0.002	0.001	0.002	0.001	
	E-3	3	0.002	0.002	ND	0.001	
	F-1	3	ND	ND	ND	ND	
	F-2	3	ND	ND	ND	ND	
	F-6	3	ND	ND	ND	ND	
	G-1	3	ND	ND	ND		
	J-1	2	0.0345	0.012			
	J-2	2	0.0345	ND			
	K-2	3/1	ND/ND	ND	ND	ND	
	K-3	3/1	ND/ND	ND	ND	ND	
K-4	3/1	ND/ND	ND	ND	ND		

Table A-1 (Continued)

SAMPLING DATA BY POLLUTANT FOR  
CONTACT COOLING AND HEATING WATER SUBCATEGORY  
(RAW WASTEWATER)

Pollutant	Process Code\$	Sample Type†	Source	Concentrations (mg/l)			Duplicate
				Day 1	Day 2	Day 3	
<u>Priority Pollutants (Continued)</u>							
126. silver	B-1	1	ND	ND			
	B-2	1	ND	ND			
	B-4	1	ND	ND			
	C-1	3	ND	0.012	0.0088	ND	
	D-3	1	ND	ND			
	E-2	3	0.001	0.001	0.001	ND	
	E-3	3	0.001	0.001	ND	0.002	
	F-1	3	ND	ND	ND	ND	
	F-2	3	ND	ND	ND	ND	
	F-6	3	ND	ND	ND	ND	
	G-1	3	ND	ND	ND		
	J-1	2	0.016	0.016			
	J-2	2	0.016	0.014			
	K-2	3/1	ND/ND	ND	ND	ND	
	K-3	3/1	ND/ND	ND	ND	ND	
	K-4	3/1	ND/ND	ND	ND	ND	
127. thallium	B-1	1	ND	ND			
	B-2	1	ND	ND			
	B-4	1	ND	ND			
	C-1	3	ND	ND	ND	ND	
	D-3	1	ND	ND			
	E-2	3	ND	ND	ND	ND	
	E-3	3	ND	ND	ND	ND	
	F-1	3	ND	ND	ND	ND	
	F-2	3	ND	ND	ND	ND	
	F-6	3	ND	ND	ND	ND	
	G-1	3	ND	0.126	0.126		
	J-1	2	0.1385	ND			
	J-2	2	0.1385	ND			
	K-2	3/1	ND/ND	ND	ND	ND	
	K-3	3/1	ND/ND	ND	ND	ND	
	K-4	3/1	ND/ND	ND	ND	ND	

A-57

Table A-1 (Continued)

SAMPLING DATA BY POLLUTANT FOR  
CONTACT COOLING AND HEATING WATER SUBCATEGORY  
(RAW WASTEWATER)

Pollutant	Process Code§	Sample Type†	Concentrations (mg/l)				Duplicate
			Source	Day 1	Day 2	Day 3	
<u>Priority Pollutants (Continued)</u>							
128. zinc	B-1	1	0.120	0.180			
	B-2	1	0.12	0.16			
	B-4	1	0.120	0.120			
	C-1	3	ND	0.750	0.770	0.490	
	D-3	1	0.017	0.018			
	E-2	3	1.46	0.627	0.658	0.637	
	E-3	3	1.46	0.664	0.662	0.712	
	F-1	3	0.015	ND	ND	ND	
	F-2	3	0.015	0.14	0.21	0.21	
	F-6	3	0.015		ND	ND	
	G-1	3	ND	0.067	0.125		
	J-1	2	ND	0.054			
	J-2	2	ND	0.125			
	K-2	3/1	ND/0.08	0.06	0.06	0.08	
	K-3	3/1	ND/0.04	ND	0.04	0.04	
	K-4	3/1	ND/0.36	ND	ND	ND	

## †Sample Type

- 1 - grab
- 2 - grab composite
- 3 - automatic composite

§See Figures VI-1 through VI-17.

††Value was not used because it was suspected to be result of laboratory contamination.

†††Pentachlorophenol was added to plant J's cooling tower as an algicide. Its use as an algicide was recently discontinued at plant J. For this reason, these data were not used in this project.

\*Indicates a reported less than value of <0.001 mg/l.

\*\*Indicates a reported less than value of <0.0001 mg/l.

¶Total phenols data from plant F were not used based on verification sampling.

NA - Pollutant was not analyzed.

ND - Not detected.

Table A-2

SAMPLING DATA BY POLLUTANT FOR  
CLEANING WATER SUBCATEGORY  
(RAW WASTEWATER)

Pollutant	Process Code§	Sample Type†	Source	Concentrations (mg/l)			Duplicate
				Day 1	Day 2	Day 3	
<u>Conventional Pollutants</u>							
biological oxygen demand (BOD <sub>5</sub> )	A-1	1	<5	9			
	A-2	1	<5	450			
	B-3	1	<5	48	46	52	
	C-2	1	83.8	84.8	48.5	72.7	
	D-1		NA	NA			
	D-2		NA	NA			
	F-3	1	2	510	247	52	
	F-4	1	2	198	34	26	
	H-1	1	<5.0	1000	630		850
	I-1	1	1.7	6.3	6.1	6.2	
	I-2	1	1.7	2.6	5.95	5.65	
	I-3	1	1.7	3.2		6.6	
	K-1	2	<5	20			
	oil and grease	A-1	2	<4	<4		
A-2		2	<4	<4			
B-3		2	<4	<4	<4	<4	
C-2		1	17.0	31.0	0	17.5	
D-1		2	<4	<4			
D-2		2	<4	<4			
F-3		1	3	548	684		
F-4		1	3	3	89		
H-1		2	<4.0	<4.0	<4.0		<4.0
I-1		1	0	18	7	44.7	
I-2		1	0	234.5	21.8	174.1	
I-3		1	0	21.2		7.8	
K-1		2	<4	<4			
pH		A-1	1	8.6	9.2		
	A-2	1	8.6	1.6			
	B-3	3	6.8	7.1	7.1	6.2	
	C-2	3	5.8	6.85	6.25	6.55	
	D-1		NA	NA			
	D-2		NA	NA			
	F-3	3	7.6	7.9	8.1	8.0	
	F-4	3	7.6	7.9	8.5	8.4	
	H-1	1	5.7	4.8	5.7		4.8
	I-1	3	6.6	7.2	7.5	7.5	
	I-2	1	6.6	11.5	10.0	10.8	
	I-3	1	6.6	11.0		8.0	
	K-1	2	8.0	9.3			

A-59

Table A-2 (Continued)

SAMPLING DATA BY POLLUTANT FOR  
CLEANING WATER SUBCATEGORY  
(RAW WASTEWATER)

Pollutant	Process Code\$	Sample Type†	Source	Concentrations (mg/l)			Duplicate
				Day 1	Day 2	Day 3	
<u>Conventional Pollutants (Continued)</u>							
total suspended solids (TSS)	A-1	1	8	12			
	A-2	1	8	39			
	B-3	3	<4	<4	<4	<4	
	C-2	3	0	8.0	2.0	11.0	
	D-1	1	<4	13			
	D-2	1	<4	8			
	F-3	3	2	198	274	466	
	F-4	3	2	90	1310	68	
	H-1	1	5.0	11.0	<4.0		10.0
	I-1	3	56.0	16363	11738	12597	
	I-2	1	56.0	5825	244	1039	
	I-3	1	56.0	1136		5671	
	K-1	2	<4	6			
<u>Nonconventional Pollutants</u>							
aluminum	A-1	1	ND	ND			
	A-2	1	ND	0.1			
	B-3	1	0.2	0.2	0.2	0.1	
	C-2	3	ND	ND	ND	ND	
	D-1	1	0.11	0.07			
	D-2	1	0.11	ND			
	F-3	3	ND	0.1	0.058		
	F-4	3	ND	ND	0.071		
	H-1	1	ND	ND	ND		
	I-1	3	0.2	0.2	0.1	0.2	
	I-2	1	0.2	8.1	0.3	5	
	I-3	1	0.2	4.2		5.2	
	K-1	2	ND	0.1			
ammonia nitrogen	A-1	1	<0.1	<0.1			
	A-2	1	<0.1	<0.1			
	B-3	3	<0.05	0.06	0.06	0.17	
	C-2	3	0	0	9.52	5.60	
	D-1	1	<0.05	399			
	D-2	1	<0.05	198			
	F-3	1	3.3	<1	2.7	1.1	
	F-4	1	3.3	1.5	4.0	1.4	
	H-1	1	0.09	<0.05	0.05		0.07
	I-1	1	0.20	137.5	75.0	93.1	
	I-2	1	0.20	20.4	51.25	4.25	
	I-3	1	0.20	75.0		67.5	
	K-1	2	<0.05	0.66			

Table A-2 (Continued)

SAMPLING DATA BY POLLUTANT FOR  
CLEANING WATER SUBCATEGORY  
(RAW WASTEWATER)

Pollutant	Process Code§	Sample Type†	Source	Concentrations (mg/l)			Duplicate
				Day 1	Day 2	Day 3	
<u>Nonconventional Pollutants (Continued)</u>							
barium	A-1	1	ND	0.014			
	A-2	1	ND	0.062			
	B-3	1	ND	ND	ND	ND	
	C-2	3	ND	0.012	0.012	0.015	
	D-1	1	0.034	0.035			
	D-2	1	0.034	0.035			
	F-3	3	0.043	0.065	0.091		
	F-4	3	0.043	0.047	0.037		
	H-1	1	ND	ND	ND		ND
	I-1	3	0.03	0.04	0.04	0.03	
	I-2	1	0.03	0.8	0.09	0.65	
	I-3	1	0.03	0.16		0.05	
	K-1	2	ND	ND			
	boron	A-1	1	ND	ND		
A-2		1	ND	0.024			
B-3		1	ND	ND	ND	ND	
C-2		3	ND	ND	ND	ND	
D-1		1	0.050	0.034			
D-2		1	0.050	0.053			
F-3		3	0.051	0.19	0.18		
F-4		3	0.051	0.14	0.15		
H-1		1	ND	ND	ND		ND
I-1		3	0.050	0.06	0.12	0.06	
I-2		1	0.050	0.23	0.07	0.21	
I-3		1	0.050	0.52		0.58	
K-1		2	ND	2.9			
bromide		A-1	1	<0.4	<0.4		
	A-2	1	<0.4	<0.4			
	B-3	3	<0.4	<0.4	<0.4	<0.4	
	C-2		NA	NA	NA	NA	
	D-1	1	<0.4	<0.4			
	D-2		NA	NA			
	F-3		NA	NA	NA	NA	
	F-4		NA	NA	NA	NA	
	H-1	1	<0.4	<0.4	<0.4		<0.4
	I-1		NA	NA	NA	NA	
	I-2		NA	NA	NA	NA	
	I-3		NA	NA		NA	
	K-1	2	<0.4	<0.4			

I9-V

Table A-2 (Continued)

SAMPLING DATA BY POLLUTANT FOR  
CLEANING WATER SUBCATEGORY  
(RAW WASTEWATER)

Pollutant	Process Code§	Sample Type†	Concentrations (mg/l)				Duplicate
			Source	Day 1	Day 2	Day 3	
<u>Nonconventional Pollutants (Continued)</u>							
calcium	A-1	1	4.8	5.0			
	A-2	1	4.8	7.58			
	B-3	1	4.5	4.3	4.3	4.8	
	C-2	3	6.84	6.86	6.46	6.58	
	D-1	1	21.4	16.0			
	D-2	1	21.4	16.6			
	F-3	3	33.2	40.7	72.7		
	F-4	3	33.2	34.3	20.5		
	H-1	1	0.194	0.073	ND		0.123
	I-1	3	51.3	46.3	47.9	45.9	
	I-2	1	51.3	182.0	30.7	207.0	
	I-3	1	51.3	45.2		26.8	
	K-1	2	20.4	5.7			
chemical oxygen demand (COD)	A-1	1	19	460			
	A-2	1	19	958			
	B-3	1	<5	96	86	62	
	C-2	3	0	453.9	278.5	148.8	
	D-1	1	<5	48			
	D-2	1	<5	172			
	F-3	3	8294	1321	261	983	
	F-4	3	8294	380	346	111	
	H-1	1	<5.0	2280	1150		2220
	I-1	3	290	680	1150	640	
	I-2	1	290	480	520	560	
	I-3	1	290	200		950	
	K-1	2	<5	195			
cyanide (amenable)	A-1	1	NA	NA			
	A-2	1	NA	NA			
	B-3	1	NA	NA	NA	NA	
	C-2	1	0	0	0	0	
	D-1	1	NA	NA			
	D-2	1	NA	NA			
	F-3	1	0	0	0	0	
	F-4	1	0	0	0	0	
	H-1	1	NA	NA	NA		
	I-1	1	0.6	0.025	0.174	0.01	
	I-2	1	0.6	0	0.034	0	
	I-3	1	0.6	0		0.01	
	K-1	1	NA	NA			



Table A-2 (Continued)

SAMPLING DATA BY POLLUTANT FOR  
CLEANING WATER SUBCATEGORY  
(RAW WASTEWATER)

Pollutant	Process Code\$	Sample Type†	Concentrations (mg/l)				Duplicate
			Source	Day 1	Day 2	Day 3	
<u>Nonconventional Pollutants (Continued)</u>							
fluoride	A-1	1	0.20	0.19			
	A-2	1	0.20	6.8			
	B-3	3	0.44	0.12	0.37	0.11	
	C-2		NA	NA	NA	NA	
	D-1	1	0.95	0.99			
	D-2		0.95	0.99			
	F-3		NA	NA	NA	NA	
	F-4		NA	NA	NA	NA	
	H-1	1	0.14	<0.1	0.14		<0.1
	I-1		NA	NA	NA	NA	
	I-2		NA	NA	NA	NA	
	I-3		NA	NA			
	K-1	2	0.81	0.27			
	iron	A-1	1	0.171	1.95		
A-2		1	0.171	2.20			
B-3		1	0.1	0.1	0.05	0.05	
C-2		3	0.14	1.44	1.15	1.25	
D-1		1	ND	0.118			
D-2		1	ND	ND			
F-3		3	0.036	1.49	1.31		
F-4		3	0.036	1.46	2.63		
H-1		1	ND	ND	ND		ND
I-1		3	0.067	0.538	ND	0.269	
I-2		1	0.067	51.3	0.023	39.1	
I-3		1	0.067	10.6		4.73	
K-1		2	ND	ND			
Kjeldahl nitrogen		A-1	1	<1	21.6		
	A-2	1	<1	<1			
	B-3	3	<1	<1	<1	<1	
	C-2	3	0	0	0	0	
	D-1	1	<1	361			
	D-2	1	<1	210			
	F-3	3	<0.02	7.55	3.7	2.5	
	F-4	3	<0.02	0.65	1.05	0.25	
	H-1	1	<1.0	<1.0	<1.0		<1.0
	I-1	3	3.85	3070	1248	1718	
	I-2	1	3.85	45.5	1153	60.1	
	I-3	1	3.85	1310		1188	
	K-1	2	<1	12			

A-63

Table A-2 (Continued)

SAMPLING DATA BY POLLUTANT FOR  
CLEANING WATER SUBCATEGORY  
(RAW WASTEWATER)

Pollutant	Process Code§	Sample Type†	Source	Concentrations (mg/l)			Duplicate
				Day 1	Day 2	Day 3	
<u>Nonconventional Pollutants (Continued)</u>							
magnesium	A-1	1	0.820	0.847			
	A-2	1	0.820	0.83			
	B-3	1	1.4		1.4	1.4	
	C-2	3	1.24	1.16	1.17	1.15	
	D-1	1	5.66	4.82			
	D-2	1	5.66	4.97			
	F-3	3	13.3	18.7	24.9		
	F-4	3	13.3	17.3	14.9		
	H-1	1	0.179	0.154	0.167		0.198
	I-1	3	7.17	7.03	7.04	6.89	
	I-2	1	7.17	17.5	4.26	13.4	
	I-3	1	7.17	6.42		5.27	
	K-1	2	5.8	0.2			
	manganese	A-1	1	ND	0.02		
A-2		1	ND	0.176			
B-3		1	ND	ND	ND	ND	
C-2		3	0.072	0.070	0.072	0.071	
D-1		1	0.008	0.01			
D-2		1	0.008	0.003			
F-3		3	ND	0.020	0.016		
F-4		3	ND	0.011	0.024		
H-1		1	ND	ND	ND		ND
I-1		3	ND	0.022	ND	ND	
I-2		1	ND	0.519	ND	0.424	
I-3		1	ND	0.111		0.084	
K-1		2	ND	ND			
molybdenum		A-1	1	ND	ND		
	A-2	1	ND	ND			
	B-3	1	ND	ND	ND	ND	
	C-2	3	ND	ND	ND	ND	
	D-1	1	ND	ND			
	D-2	1	ND	ND			
	F-3	3	ND	ND	ND		
	F-4	3	ND	0.021	0.065		
	H-1	1	ND	ND	ND		ND
	I-1	3	ND	ND	0.3	ND	
	I-2	1	ND	ND	ND	ND	
	I-3	1	ND	ND		ND	
	K-1	2	ND	ND			

A-64

Table A-2 (Continued)

SAMPLING DATA BY POLLUTANT FOR  
CLEANING WATER SUBCATEGORY  
(RAW WASTEWATER)

Pollutant	Process Code§	Sample Type†	Concentrations (mg/l)				Duplicate
			Source	Day 1	Day 2	Day 3	
<u>Nonconventional Pollutants (Continued)</u>							
nitrate/nitrite	A-1	1	<0.1	<0.1			
	A-2	1	<0.1	<0.1			
	B-3	3	0.25	0.25	0.20	0.28	
	C-2		NA	NA	NA	NA	
	D-1	1	2.0	2.1			
	D-2		2.0	2.1			
	F-3		NA	NA	NA	NA	
	F-4		NA	NA	NA	NA	
	H-1	1	<0.1	0.2	<0.1		<0.1
	I-1		NA	NA	NA	NA	
	I-2		NA	NA	NA	NA	
	I-3		NA	NA		NA	
	K-1	2	1.05	<0.1			
	sodium	A-1	1	12.8	58.1		
A-2		1	12.8	15.1			
B-3		1	11.1	11.3	10.6	12.0	
C-2		3	11.4	13.6	12.6	14.4	
D-1		1	26.2	24.3			
D-2		1	26.2	24.2			
F-3		3	17.7	358	311		
F-4		3	17.7	198	180		
H-1		1	ND	5.93	ND		5.57
I-1		3	12.4	24.5	24.0	19.7	
I-2		1	12.4	1830	3860	510	
I-3		1	12.4	272		317	
K-1		2	8.1	0.8			
sulfate	A-1	1	12	40			
	A-2	1	12	45			
	B-3	3	11	12	10	10	
	C-2		NA	NA	NA	NA	
	D-1	1	33	33			
	D-2		33	30			
	F-3		NA	NA	NA	NA	
	F-4		NA	NA	NA	NA	
	H-1	1	<5.0	<5.0	<5.0		<5.0
	I-1		NA	NA	NA	NA	
	I-2		NA	NA	NA	NA	
	I-3		NA	NA		NA	
	K-1	2	10	<5			

A-65

Table A-2 (Continued)

SAMPLING DATA BY POLLUTANT FOR  
CLEANING WATER SUBCATEGORY  
(RAW WASTEWATER)

Pollutant	Process Code§	Sample Type†	Source	Concentrations (mg/l)			Duplicate
				Day 1	Day 2	Day 3	
<u>Nonconventional Pollutants (Continued)</u>							
sulfide	A-1	1	<1	<1			
	A-2	1	<1	<1			
	B-3	1	<1	<1	<1	<1	
	C-2			NA	NA	NA	NA
	D-1			NA	NA		
	D-2			NA	NA		
	F-3			NA	NA	NA	NA
	F-4			NA	NA	NA	NA
	H-1	1		<1.0	<1.0	<1.0	<1.0
	I-1			NA	NA	NA	NA
	I-2			NA	NA	NA	NA
	I-3			NA	NA	NA	NA
	K-1	2		<1	<1		
surfactants	A-1	1	<0.01	0.020			
	A-2	1	<0.01	<0.01			
	B-3	3	<0.01	<0.01	<0.01	<0.01	
	C-2	3	0.08	0.92	0.04	1.06	
	D-1			NA			
	D-2	1		NA			
	F-3	3	<0.02	148	66	50	
	F-4	3	<0.02	0.05	0.15	0.07	
	H-1	1	<0.01	<0.01	<0.01		<0.01
	I-1	3	0.15	0.10	0.112	0.05	
	I-2	1	0.15	0.05	0.40	0.025	
	I-3	1	0.15	0.15		0.112	
	K-1	2		<0.01	0.03		
tin	A-1	1	ND	ND			
	A-2	1	ND	ND			
	B-3	1	ND	ND	ND	ND	
	C-2	3	ND	0.042	ND	0.021	
	D-1	1	ND	ND			
	D-2	1	ND	ND			
	F-3	3	ND	0.077	ND		
	F-4	3	ND	ND	ND		
	H-1	1	ND	ND	ND		ND
	I-1	3	ND	ND	ND	1.1	
	I-2	1	ND	0.9	1.1	1.2	
	I-3	1	ND	ND		ND	
	K-1	2		ND	ND		

A-66

Table A-2 (Continued)

SAMPLING DATA BY POLLUTANT FOR  
CLEANING WATER SUBCATEGORY  
(RAW WASTEWATER)

A-67

Pollutant	Process Code§	Sample Type†	Source	Concentrations (mg/l)			Duplicate
				Day 1	Day 2	Day 3	
<u>Nonconventional Pollutants (Continued)</u>							
titanium	A-1	1	ND	ND			
	A-2	1	ND	ND			
	B-3	1	ND	ND	ND	ND	
	C-2	3	0.087	0.081	0.095	0.084	
	D-1	1	0.013	0.021			
	D-2	1	0.013	0.018			
	F-3	3	0.13	0.12	0.027		
	F-4	3	0.13	0.092	0.085		
	H-1	1	ND	0.01	ND		0.01
	I-1	3	ND	0.016	ND	0.041	
	I-2	1	ND	0.199	ND	0.174	
	I-3	1	ND	0.06		0.075	
	K-1	2	ND	ND			
total dissolved solids (TDS)	A-1	1	NA	NA			
	A-2	1	NA	NA			
	B-3	1	NA	NA	NA	NA	
	C-2	3	0	5.0	100	5.0	
	D-1	1	NA	NA			
	D-2	1	NA	NA			
	F-3	3	800	1300	1300	900	
	F-4	3	800	800	1400	600	
	H-1	1	NA	NA	NA		
	I-1	3	201.5	221	227.5	214.5	
	I-2	1	201.5	4907.5	3250	1430	
	I-3	1	201.5	13000		812.5	
	K-1	2	NA	NA			
total organic carbon (TOC)	A-1	1	13	150			
	A-2	1	13	1010			
	B-3	3	5	36	34	39	
	C-2	1	3.0	74.0	19.5	30	
	D-1	1	2	22			
	D-2	1	2	56			
	F-3	1	37	875	455	242	
	F-4	1	37	70	103	52	
	H-1	1	2.0	800	600		792
	I-1	1	11.0	9267	5412	10038	
	I-2	1	11.0	1472	3282	2604	
	I-3	1	11.0	5316		4998	
	K-1	2	3	58			

Table A-2 (Continued)

SAMPLING DATA BY POLLUTANT FOR  
CLEANING WATER SUBCATEGORY  
(RAW WASTEWATER)

Pollutant	Process Code§	Sample Type†	Concentrations (mg/l)				Duplicate	
			Source	Day 1	Day 2	Day 3		
<u>Nonconventional Pollutants (Continued)</u>								
total phenols	A-1	1	<0.020	<0.020				
	A-2	1	<0.020	<0.050				
	B-3	1	<0.02	<0.02	<0.02	<0.02		
	C-2	1	1.42	0.1	20.86	1.42		
	D-1	1	<0.001	<0.001				
	D-2	1	<0.001	<0.001				
	F-3††	1	10	32	82	222		
	F-4††	1	10	30	62	16		
	H-1	1	<0.02	<0.02	<0.02		<0.02	
	I-1	1	2.7	2.95	3.13	3.75		
	I-2	1	2.7	585	575	284.5		
	I-3	1	2.7	730		0.83		
	K-1	2	<0.001	0.31				
	total phosphorus	A-1	1	0.03	0.04			
		A-2	1	0.03	0.14			
B-3		3	<0.02	0.052	<0.02	<0.02		
C-2		3	1.2	<0.005	0.345	1.06		
D-1		1	0.1	0.03				
D-2		1	<0.1	<0.03				
F-3		3	<0.02	10.5	23.85	13.4		
F-4		3	<0.02	15.95	20.75	13.55		
H-1		1	<0.02	<0.02	0.04		0.05	
I-1		3	3.18	6.13	10.45	5.5		
I-2		1	3.18	103.4	28.77	123		
I-3		1	3.18	32.1		5.17		
K-1		2	0.04	0.17				
vanadium	A-1	1	ND	ND				
	A-2	1	ND	ND				
	B-3	1	ND	ND	ND	ND		
	C-2	3	ND	ND	ND	ND		
	D-1	1	0.038	ND				
	D-2	1	0.038	ND				
	F-3	3	ND	ND	ND			
	F-4	3	ND	ND	ND			
	H-1	1	0.077	ND	ND			
	I-1	3	ND	ND	ND	ND		
	I-2	1	ND	ND	ND	ND		
	I-3	1	ND	ND		ND		
	K-1	2	ND	ND				

Table A-2 (Continued)

SAMPLING DATA BY POLLUTANT FOR  
CLEANING WATER SUBCATEGORY  
(RAW WASTEWATER)

Pollutant	Process Code\$	Sample Type†	Concentrations (mg/l)				Duplicate
			Source	Day 1	Day 2	Day 3	
<u>Nonconventional Pollutants (Continued)</u>							
yttrium	A-1	1	ND	ND			
	A-2	1	ND	ND			
	B-3	3	ND	ND	ND	ND	
	C-2	3	ND	ND	ND	ND	
	D-1	1	ND	0.006			
	D-2	1	ND	0.006			
	F-3	3	ND	ND	ND		
	F-4	3	ND	ND	ND		
	H-1	1	ND	0.005	ND		
	I-1	3	ND	ND	ND	ND	
	I-2	1	ND	ND	ND	ND	
	I-3	1	ND	ND		ND	
	K-1	2	ND	ND			
	<u>Priority Pollutants</u>						
4. benzene	A-1	2	0.005	0.006			
	A-2	2	ND	ND			
	B-3	2	ND	ND	ND	ND	
	C-2	2	*	0.003	*	*	
	D-1	2	ND	0.018			
	D-2	2	ND	0.018			
	F-3	2	*	0.01	0.005		
	F-4	2	*	*	*		
	H-1	2	ND	ND	ND		ND
	I-1	2	0.007	0.099	0.012	ND	
	I-2	2	0.007	0.011	0.012	0.009	
	I-3	2	0.007	0.01		0.009	
	K-1	2	ND	0.008			
6. carbon tetrachloride	A-1	2	ND	ND			
	A-2	2	ND	ND			
	B-3	2	ND	ND	ND	ND	
	C-2	2	ND	ND	ND	ND	
	D-1	2	ND	ND			
	D-2	2	ND	ND			
	F-3	2	ND	ND	ND		
	F-4	2	ND	ND	ND		
	H-1	2	ND	ND	ND		ND
	I-1	2	ND	ND	ND	ND	
	I-2	2	ND	ND	ND	ND	
	I-3	2	ND	ND		ND	
	K-1	2	0.004	ND			

A-69

Table A-2

SAMPLING DATA BY POLLUTANT FOR  
CLEANING WATER SUBCATEGORY  
(RAW WASTEWATER)

Pollutant	Process Code§	Sample Type†	Source	Concentrations (mg/l)			Duplicate
				Day 1	Day 2	Day 3	
<u>Priority Pollutants</u> (Continued)							
7. chlorobenzene	A-1	2	ND	ND			
	A-2	2	ND	ND			
	B-3	2	ND	ND	ND	ND	
	C-2	2	ND	ND	ND	ND	
	D-1	2	ND	ND			
	D-2	2	ND	0.0004			
	F-3	2	ND	ND	ND		
	F-4	2	ND	ND	*		
	H-1	2	ND	ND	ND		ND
	I-1	2	ND	ND	ND		ND
	I-2	2	ND	ND	ND		ND
	I-3	2	ND	ND	ND		ND
	K-1	2	ND	ND			
11. 1,1,1-trichloroethane	A-1	2	0.003	*			
	A-2	2	0.003	0.010			
	B-3	2	*	0.001	0.001	0.001	
	C-2	2	ND	ND	ND	ND	
	D-1	2	0.004	0.003			
	D-2	2	0.004	0.001			
	F-3	2	*	ND	ND		
	F-4	2	*	ND	ND		
	H-1	2	*	0.001	0.002		0.001
	I-1	2	ND	ND	ND		ND
	I-2	2	ND	0.011	0.010		0.020
	I-3	2	ND	ND			ND
	K-1	2	0.003	0.009			
13. 1,1-dichloroethane	A-1	2	ND	ND			
	A-2	2	ND	ND			
	B-3	2	ND	ND	ND	ND	
	C-2	2	ND	ND	ND	ND	
	D-1	2	ND	ND			
	D-2	2	ND	ND			
	F-3	2	ND	ND	ND		
	F-4	2	ND	ND	ND		
	H-1	2	ND	ND	ND		ND
	I-1	2	ND	ND	ND		ND
	I-2	2	ND	ND	ND		ND
	I-3	2	ND	0.003			ND
	K-1	2	ND	ND			

A-70



Table A-2 (Continued)

SAMPLING DATA BY POLLUTANT FOR  
CLEANING WATER SUBCATEGORY  
(RAW WASTEWATER)

Pollutant	Process Code\$	Sample Type†	Concentrations (mg/l)				Duplicate
			Source	Day 1	Day 2	Day 3	
<u>Priority Pollutants (Continued)</u>							
22. p-chloro-m-cresol	A-1	1	0.042	0.042			
	A-2	1	0.042	0.042			
	B-3	3	0.008	0.005	0.008	0.008	
	C-2	3	ND	ND	ND	ND	
	D-1	1	ND	ND			
	D-2	1	ND	0.014			
	F-3	3	ND	ND	ND		
	F-4	3	ND	ND	ND		
	H-1	1	0.008	0.042	0.040		0.042
	I-1	3	ND	ND	ND	ND	
	I-2	1	ND	ND	ND	ND	
	I-3	1	ND	ND		ND	
	K-1	2	ND	ND			
23. chloroform	A-1	2	0.087	0.038			
	A-2	2	0.087	*			
	B-3	2	ND	ND	ND	ND	
	C-2	2	ND	ND	ND	ND	
	D-1	2	0.019	0.048			
	D-2	2	0.019	0.053			
	F-3	2	*	ND	*		
	F-4	2	*	ND	ND		
	H-1	2	ND	ND	ND		ND
	I-1	2	0.12	0.013	0.007	ND	
	I-2	2	0.12	0.005	0.004	0.019	
	I-3	2	0.12	0.004		0.002	
	K-1	2	0.1015	ND			
24. 2-chlorophenol	A-1	1	ND	ND			
	A-2	1	ND	ND			
	B-3	3	ND	ND	ND	ND	
	C-2	3	ND	ND	ND	ND	
	D-1	1	ND	ND			
	D-2	1	ND	ND			
	F-3	3	ND	ND	ND		
	F-4	3	ND	ND	ND		
	H-1	1	ND	ND	ND		ND
	I-1	3	ND	ND	ND	ND	
	I-2	1	ND	ND	ND	ND	
	I-3	1	ND	0.006		ND	
	K-1	2	ND	ND			

A-71

Table A-2 (Continued)

SAMPLING DATA BY POLLUTANT FOR  
CLEANING WATER SUBCATEGORY  
(RAW WASTEWATER)

Pollutant	Process Code§	Sample Type†	Concentrations (mg/l)				Duplicate
			Source	Day 1	Day 2	Day 3	
<u>Priority Pollutants (Continued)</u>							
26. 1,3-dichlorobenzene	A-1	1	ND	ND			
	A-2	1	ND	ND			
	B-3	3	ND	ND	ND	ND	
	C-2	3	ND	ND	ND	ND	
	D-1	1	ND	ND			
	D-2	1	ND	ND			
	F-3	3	ND	ND	ND		
	F-4	3	ND	ND	ND		
	H-1	1	ND	ND	ND		ND
	I-1	3	ND	ND	ND	ND	
	I-2	1	ND	0.001	ND	ND	
	I-3	1	ND	ND		ND	
K-1	2	ND	ND				
30. 1,2-trans-dichloroethylene	A-1	2	ND	ND			
	A-2	2	ND	ND			
	B-3	2	ND	ND	ND	ND	
	C-2	2	0.008	*	*	ND	
	D-1	2	ND	ND			
	D-2	2	ND	ND			
	F-3	2	ND	ND	ND		
	F-4	2	ND	ND	ND		
	H-1	2	ND	ND	ND		ND
	I-1	2	ND	ND	ND	ND	
	I-2	2	ND	ND	ND	ND	
	I-3	2	ND	ND		ND	
	K-1	2	ND	ND			
31. 2,4-dichlorophenol	A-1	1	ND	ND			
	A-2	1	ND	ND			
	B-3	3	ND	ND	ND	ND	
	C-2	3	ND	ND	ND	ND	
	D-1	1	ND	ND			
	D-2	1	ND	ND			
	F-3	3	ND	ND	ND		
	F-4	3	ND	ND	ND		
	H-1	1	ND	ND	ND		ND
	I-1	3	ND	ND	ND	ND	
	I-2	1	ND	ND	ND	ND	
	I-3	1	ND	0.001		ND	
	K-1	2	ND	ND			

Table A-2 (Continued)

SAMPLING DATA BY POLLUTANT FOR  
CLEANING WATER SUBCATEGORY  
(RAW WASTEWATER)

A-73

Pollutant	Process Codes	Sample Type†	Concentrations (mg/l)				Duplicate
			Source	Day 1	Day 2	Day 3	
<u>Priority Pollutants (Continued)</u>							
38. ethylbenzene	A-1	2	ND	ND			
	A-2	2	ND	ND			
	B-3	2	ND	ND	ND	ND	
	C-2	2	ND	*	*	ND	
	D-1	2	ND	ND			
	D-2	2	ND	ND			
	F-3	2	ND	ND	0.001		
	F-4	2	ND	ND	ND		
	H-1	2	ND	ND	ND		ND
	I-1	2	ND	ND	ND	ND	
	I-2	2	ND	ND	ND	ND	
	I-3	2	ND	ND		ND	
	K-1	2	ND	ND			
	39. fluoranthene	A-1	1	*	*		
A-2		1	*	*			
B-3		3	ND	ND	ND	ND	
C-2		3	ND	*	ND	ND	
D-1		1	ND	ND			
D-2		1	ND	*			
F-3		3	ND	ND	ND		
F-4		3	ND	ND	ND		
H-1		1	ND	ND	ND		ND
I-1		3	ND	ND	ND	ND	
I-2		1	ND	0.006	ND	0.002	
I-3		1	ND	0.0004		ND	
K-1		2	ND	ND			
44. methylene chloride	A-1	2	0.029	0.084			
	A-2	2	0.029	0.310			
	B-3	2	0.002	0.039	0.005	0.003	
	C-2	2	*	*	*	*	
	D-1	2	0.017	0.019			
	D-2	2	0.017	0.018			
	F-3	2	*	*	0.002		
	F-4	2	*	0.002	*		
	H-1	2	0.003	0.003	0.043		0.008
	I-1	2	0.005	0.005	ND	0.016	
	I-2	2	0.005	0.005	0.005	ND	
	I-3	2	0.005	0.005		ND	
	K-1	2	0.015	0.032			

Table A-2 (Continued)

SAMPLING DATA BY POLLUTANT FOR  
CLEANING WATER SUBCATEGORY  
(RAW WASTEWATER)

Pollutant	Process Code§	Sample Type†	Concentrations (mg/l)			Duplicate
			Source	Day 1	Day 2	
<u>Priority Pollutants (Continued)</u>						
47. bromoform	A-1	2	ND	ND		
	A-2	2	ND	ND		
	B-3	2	ND	ND	ND	ND
	C-2	2	ND	ND	ND	ND
	D-1	2	ND	ND		
	D-2	2	ND	0.001		
	F-3	2	0.086	ND	0.010	
	F-4	2	0.086	0.004	ND	
	H-1	2	ND	ND	ND	ND
	I-1	2	ND	ND	ND	ND
	I-2	2	ND	ND	ND	ND
	I-3	2	ND	ND		ND
	K-1	2	ND	ND		
48. dichlorobromomethane	A-1	2	ND	ND		
	A-2	2	ND	ND		
	B-3	2	ND	ND	ND	ND
	C-2	2	ND	ND	ND	ND
	D-1	2	0.004	0.015		
	D-2	2	0.004	0.011		
	F-3	2	*	ND	ND	
	F-4	2	*	ND	ND	
	H-1	2	ND	ND	ND	ND
	I-1	2	0.009	ND	ND	ND
	I-2	2	0.009	ND	ND	ND
	I-3	2	0.009	ND		ND
	K-1	2	0.018	ND		
49. trichlorofluoromethane	A-1	2	ND	ND		
	A-2	2	ND	ND		
	B-3	2	ND	ND	ND	ND
	C-2	2	ND	0.017	0.034	0.017
	D-1	2	ND	ND		
	D-2	2	ND	ND		
	F-3	2	ND	ND	ND	
	F-4	2	ND	0.003	*	
	H-1	2	ND	ND	ND	ND
	I-1	2	ND	ND	ND	ND
	I-2	2	ND	ND	ND	ND
	I-3	2	ND	ND		ND
	K-1	2	ND	ND		

A-74

Table A-2 (Continued)

SAMPLING DATA BY POLLUTANT FOR  
CLEANING WATER SUBCATEGORY  
(RAW WASTEWATER)

Pollutant	Process Code\$	Sample Type†	Source	Concentrations (mg/l)			Duplicate
				Day 1	Day 2	Day 3	
<u>Priority Pollutants (Continued)</u>							
51. chlorodibromomethane	A-1	2	ND	ND			
	A-2	2	ND	ND			
	B-3	2	ND	ND	ND	ND	
	C-2	2	ND	ND	ND	ND	
	D-1	2	ND	0.001			
	D-2	2	ND	0.002			
	F-3	2	0.002	ND	ND		
	F-4	2	0.002	ND	ND		
	H-1	2	ND	ND	ND		ND
	I-1	2	0.004	ND	ND	ND	
	I-2	2	0.004	ND	ND	ND	
	I-3	2	0.004	ND		ND	
	K-1	2	ND	ND			
55. naphthalene	A-1	1	ND	ND			
	A-2	1	ND	ND			
	B-3	3	ND	ND	ND	ND	
	C-2	3	ND	ND	ND	ND	
	D-1	1	ND	ND			
	D-2	1	*	ND			
	F-3	3	ND	*	ND		
	F-4	3	ND	ND	ND		
	H-1	1	ND	ND	ND		ND
	I-1	3	ND	ND	ND	ND	
	I-2	1	ND	ND	ND	ND	
	I-3	1	ND	ND		ND	
	K-1	2	ND	ND			
56. nitrobenzene	A-1	1	ND	ND			
	A-2	1	ND	ND			
	B-3	3	ND	ND	ND	ND	
	C-2	3	ND	ND	ND	ND	
	D-1	1	*	ND			
	D-2	1	ND	ND			
	F-3	3	ND	ND	ND		
	F-4	3	ND	ND	ND		
	H-1	1	ND	ND	ND		ND
	I-1	3	ND	ND	ND	ND	
	I-2	1	ND	ND	ND	ND	
	I-3	1	ND	ND		ND	
	K-1	2	ND	ND			

A-75

Table A-2 (Continued)

SAMPLING DATA BY POLLUTANT FOR  
CLEANING WATER SUBCATEGORY  
(RAW WASTEWATER)

Pollutant	Process Code§	Sample Type†	Source	Concentrations (mg/l)			Duplicate
				Day 1	Day 2	Day 3	
<u>Priority Pollutants (Continued)</u>							
57. 2-nitrophenol	A-1	1	ND	ND			
	A-2	1	ND	ND			
	B-3	3	ND	ND	ND	ND	
	C-2	3	ND	ND	ND	ND	
	D-1	1	ND	ND			
	D-2	1	ND	ND			
	F-3	3	ND	ND	ND		
	F-4	3	ND	ND	ND		
	H-1	1	ND	ND	ND		ND
	I-1	3	ND	ND	ND	ND	
	I-2	1	ND	ND	ND	ND	
	I-3	1	ND	ND	ND	ND	
	K-1	2	ND	*			
58. 4-nitrophenol	A-1	1	ND	ND			
	A-2	1	ND	ND			
	B-3	3	ND	ND	ND	ND	
	C-2	3	ND	ND	ND	ND	
	D-1	1	ND	ND			
	D-2	1	ND	ND			
	F-3	3	ND	ND	ND		
	F-4	3	ND	ND	ND		
	H-1	1	ND	ND	ND		ND
	I-1	3	ND	ND	ND	ND	
	I-2	1	ND	ND	ND	ND	
	I-3	1	ND	ND	ND	ND	
	K-1	2	0.007	ND			
60. 4,6-dinitro-o-cresol	A-1	1	ND	ND			
	A-2	1	ND	0.004			
	B-3	3	ND	ND	ND	ND	
	C-2	3	ND	ND	ND	ND	
	D-1	1	ND	ND			
	D-2	1	ND	ND			
	F-3	3	ND	ND	ND		
	F-4	3	ND	ND	ND		
	H-1	1	ND	ND	ND		ND
	I-1	3	ND	ND	ND	ND	
	I-2	1	ND	ND	ND	ND	
	I-3	1	ND	ND	ND	ND	
	K-1	2	ND	ND			

Table A-2 (Continued)

SAMPLING DATA BY POLLUTANT FOR  
CLEANING WATER SUBCATEGORY  
(RAW WASTEWATER)

Pollutant	Process Code§	Sample Type†	Source	Concentrations (mg/l)			Duplicate
				Day 1	Day 2	Day 3	
<u>Priority Pollutants (Continued)</u>							
62. N-nitrosodiphenylamine	A-1	1	0.001	0.001			
	A-2	1	0.001	0.028			
	B-3	3	ND	*	ND	ND	
	C-2	3	ND	ND	ND	ND	
	D-1	1	ND	0.006			
	D-2	1	ND	0.006			
	F-3	3	ND	ND	ND		
	F-4	3	ND	ND	ND		
	H-1	1	ND	*	*		*
	I-1	3	ND	ND	ND	ND	
	I-2	1	ND	ND	0.005	0.064	
	I-3	1	ND	0.016		0.001	
	K-1	2	*	0.004			
64. pentachlorophenol	A-1	1	ND	ND			
	A-2	1	ND	ND			
	B-3	3	ND	ND	ND	ND	
	C-2	3	ND	ND	ND	ND	
	D-1	1	ND	ND			
	D-2	1	ND	ND			
	F-3	3	ND	ND	ND		
	F-4	3	ND	ND	ND		
	H-1	1	ND	ND	ND		
	I-1	3	ND	0.020	0.001	ND	
	I-2	1	ND	ND	ND	ND	
	I-3	1	ND	ND		ND	
	K-1	2	ND	ND			ND
65. phenol	A-1	1	ND	ND			
	A-2	1	ND	ND			
	B-3	3	0.001	0.11	0.1	0.1	
	C-2	3	*	0.022	0.014	0.012	
	D-1	1	*	ND			
	D-2	1	*	ND			
	F-3	3	*	0.005	0.006		
	F-4	3	*	0.002	*		
	H-1	1	ND	ND	ND		
	I-1	3	0.030	0.051	0.030	0.062	
	I-2	1	0.030	2.8	6.0	5.1	
	I-3	1	0.030	2.6		0.74	
	K-1	2	ND	0.214			ND

A-77

Table A-2 (Continued)

SAMPLING DATA BY POLLUTANT FOR  
CLEANING WATER SUBCATEGORY  
(RAW WASTEWATER)

Pollutant	Process Code§	Sample Type†	Source	Concentrations (mg/l)			Duplicate
				Day 1	Day 2	Day 3	
<u>Priority Pollutants (Continued)</u>							
66. bis(2-ethylhexyl)phthalate	A-1	1	ND	ND			
	A-2	1	ND	0.025			
	B-3	3	0.057	*	*	0.046	
	C-2	3	0.003	0.013	0.018	0.011	
	D-1	1	0.289	0.032			
	D-2	1	0.289	0.029			
	F-3	3	0.001	0.032	0.013		
	F-4	3	0.001	0.004	ND		
	H-1	1	*	0.134	0.085		0.196
	I-1	3	0.001	0.002	0.004	0.140	
	I-2	1	0.001	0.080	0.001	0.062	
	I-3	1	0.001	0.004		0.007	
	K-1	2	0.005	0.083			
	67. butyl benzyl phthalate	A-1	1	ND	ND		
A-2		1	ND	ND			
B-3		3	ND	ND	ND	ND	
C-2		3	ND	*	ND	ND	
D-1		1	ND	ND			
D-2		1	ND	ND			
F-3		3	ND	ND	ND		
F-4		3	ND	ND	ND		
H-1		1	ND	ND	ND		ND
I-1		3	ND	ND	ND	0.002	
I-2		1	ND	ND	ND	ND	
I-3		1	ND	ND	ND	ND	
K-1		2	ND	ND			
68. di-n-butyl phthalate		A-1	1	ND	ND		
	A-2	1	ND	0.002			
	B-3	3	0.001	0.003	0.003	0.003	
	C-2	3	*	0.002	0.003	*	
	D-1	1	0.003	0.008			
	D-2	1	0.003	0.008			
	F-3	3	*	*	0.023		
	F-4	3	*	*	ND		
	H-1	1	ND	ND	0.001		ND
	I-1	3	ND	ND	ND	ND	
	I-2	1	ND	ND	0.001	ND	
	I-3	1	ND	ND		0.006	
	K-1	2	0.005	0.007			

A-78



Table A-2 (Continued)

SAMPLING DATA BY POLLUTANT FOR  
CLEANING WATER SUBCATEGORY  
(RAW WASTEWATER)

Pollutant	Process Code\$	Sample Type†	Source	Concentrations (mg/l)			Duplicate
				Day 1	Day 2	Day 3	
<u>Priority Pollutants (Continued)</u>							
69. di-n-octyl phthalate	A-1	1	ND	ND			
	A-2	1	ND	ND			
	B-3	3	ND	ND	ND	ND	
	C-2	3	ND	*	ND	ND	
	D-1	1	ND	ND			
	D-2	1	ND	ND			
	F-3	3	ND	ND	ND		
	F-4	3	ND	ND	ND		
	H-1	1	ND	ND	ND		ND
	I-1	3	ND	ND	ND	ND	
	I-2	1	ND	ND	ND	ND	
	I-3	1	ND	ND	ND	ND	
	K-1	2	ND	ND			
70. diethyl phthalate	A-1	1	ND	ND			
	A-2	1	ND	ND			
	B-3	3	ND	*	0.001	*	
	C-2	3	ND	*	*	*	
	D-1	1	ND	*			
	D-2	1	ND	0.001			
	F-3	3	ND	*	ND		
	F-4	3	ND	*	ND		
	H-1	1	ND	ND	ND		ND
	I-1	3	ND	0.002	0.002	0.002	
	I-2	1	ND	ND	ND	ND	
	I-3	1	ND	ND	ND	ND	
	K-1	2	ND	*			
72. benzo(a)anthracene	A-1	1	ND	ND			
	A-2	1	ND	ND			
	B-3	3	ND	ND	ND	ND	
	C-2	3	ND	*	ND	ND	
	D-1	1	*	ND			
	D-2	1	*	ND			
	F-3	3	ND	ND	ND		
	F-4	3	ND	ND	ND		
	H-1	1	ND	ND	ND		ND
	I-1	3	ND	ND	ND	ND	
	I-2	1	ND	ND	ND	0.001	
	I-3	1	ND	ND	ND	ND	
	K-1	2	ND	ND			

A-79

Table A-2 (Continued)  
 SAMPLING DATA BY POLLUTANT FOR  
 CLEANING WATER SUBCATEGORY  
 (RAW WASTEWATER)

Pollutant	Process Code\$	Sample Type†	Source	Concentrations (mg/l)			Duplicate
				Day 1	Day 2	Day 3	
<u>Priority Pollutants (Continued)</u>							
73. benzo(a)pyrene	A-1	1	ND	ND			
	A-2	1	ND	*			
	B-3	3	ND	0.005	ND	ND	
	C-2	3	ND	ND	ND	ND	
	D-1	1	ND	ND			
	D-2	1	ND	ND			
	F-3	3	ND	ND	ND		
	F-4	3	ND	ND	ND		
	H-1	1	ND	ND	ND		ND
	I-1	3	ND	ND	ND		ND
	I-2	1	ND	ND	ND		ND
	I-3	1	ND	ND	ND		ND
	K-1	2	ND	ND	ND		
76. chrysene	A-1	1	0.004	0.004			
	A-2	1	0.004	0.004			
	B-3	3	ND	ND	ND	ND	
	C-2	3	ND	*	ND	ND	
	D-1	1	ND	ND			
	D-2	1	ND	ND			
	F-3	3	ND	ND	ND		
	F-4	3	ND	0.001	ND		
	H-1	1	ND	0.004	0.004		0.004
	I-1	3	ND	ND	ND		ND
	I-2	1	ND	0.005	ND		0.001
	I-3	1	ND	ND	ND		ND
	K-1	2	ND	ND	ND		
78. anthracene	A-1	1	ND	ND			
	A-2	1	ND	ND			
	B-3	3	ND	ND	ND	ND	
	C-2	3	ND	*	*	ND	
	D-1	1	ND	ND			
	D-2	1	ND	ND			
	F-3	3	ND	ND	ND		
	F-4	3	ND	ND	ND		
	H-1	1	ND	ND	ND		ND
	I-1	3	ND	ND	ND		ND
	I-2	1	ND	0.008	ND		0.003
	I-3	1	ND	ND	ND		ND
	K-1	2	ND	0.003	ND		

A-80

Table A-2 (Continued)  
 SAMPLING DATA BY POLLUTANT FOR  
 CLEANING WATER SUBCATEGORY  
 (RAW WASTEWATER)

Pollutant	Process Code\$	Sample Type†	Source	Concentrations (mg/l)			Duplicate
				Day 1	Day 2	Day 3	
<u>Priority Pollutants (Continued)</u>							
80. fluorene	A-1	1	ND	ND			
	A-2	1	ND	ND			
	B-3	3	ND	ND	ND	ND	
	C-2	3	ND	ND	*	ND	
	D-1	1	ND	ND			
	D-2	1	*	ND			
	F-3	3	ND	ND	ND		
	F-4	3	ND	ND	ND		
	H-1	1	ND	ND	ND		ND
	I-1	3	ND	ND	ND	ND	
	I-2	1	ND	ND	ND	ND	
	I-3	1	ND	ND		ND	
	K-1	2	ND	ND			
81. phenanthrene	A-1	1	ND	ND			
	A-2	1	ND	ND			
	B-3	3	ND	ND	ND	ND	
	C-2	3	ND	*	*	ND	
	D-1	1	ND	ND			
	D-2	1	ND	ND			
	F-3	3	ND	ND	ND		
	F-4	3	ND	ND	ND		
	H-1	1	ND	ND	ND		ND
	I-1	3	ND	ND	ND	ND	
	I-2	1	ND	0.008	ND	ND	0.003
	I-3	1	ND	ND		ND	
	K-1	2	ND	ND			
84. pyrene	A-1	1	ND	ND			
	A-2	1	ND	ND			
	B-3	3	ND	ND	ND	ND	
	C-2	3	ND	*	ND	ND	
	D-1	1	ND	ND			
	D-2	1	ND	ND			
	F-3	3	ND	ND	ND		
	F-4	3	ND	ND	ND		
	H-1	1	ND	ND	ND		ND
	I-1	3	ND	ND	ND	ND	
	I-2	1	ND	0.006	ND	ND	0.002
	I-3	1	ND	0.0004		ND	
	K-1	2	ND	ND			

A-81

Table A-2 (Continued)

SAMPLING DATA BY POLLUTANT FOR  
CLEANING WATER SUBCATEGORY  
(RAW WASTEWATER)

Pollutant	Process Code§	Sample Type†	Source	Concentrations (mg/l)			Duplicate
				Day 1	Day 2	Day 3	
<u>Priority Pollutants (Continued)</u>							
85. tetrachloroethylene	A-1	2	ND	ND			
	A-2	2	ND	ND			
	B-3	2	ND	ND	ND	ND	
	C-2	2	0.019	*	0.003	*	
	D-1	2	ND	ND			
	D-2	2	ND	ND			
	F-3	2	ND	ND	ND		
	F-4	2	ND	ND	ND		
	H-1	2	ND	ND	ND		ND
	I-1	2	ND	ND	ND	ND	
	I-2	2	ND	ND	ND	ND	
	I-3	2	ND	ND		ND	
	K-1	2	ND	ND			
86. toluene	A-1	2	ND	ND			
	A-2	2	ND	ND			
	B-3	2	ND	ND	ND	ND	
	C-2	2	*	0.001	0.001	*	
	D-1	2	ND	0.036			
	D-2	2	ND	0.033			
	F-3	2	*	0.032	0.030		
	F-4	2	*	*	*		
	H-1	2	ND	ND	ND		ND
	I-1	2	ND	0.002	ND	0.003	
	I-2	2	ND	0.69	0.11	0.25	
	I-3	2	ND	0.15		ND	
	K-1	2	ND	ND			
87. trichloroethylene	A-1	2	ND	ND			
	A-2	2	ND	ND			
	B-3	2	ND	ND	ND	ND	
	C-2	2	0.004	*	ND	ND	
	D-1	2	ND	0.001			
	D-2	2	ND	0.001			
	F-3	2	ND	ND	ND		
	F-4	2	ND	ND	ND		
	H-2	2	ND	ND	ND		ND
	I-1	2	ND	ND	ND	0.003	
	I-2	2	ND	ND	ND	ND	
	I-3	2	ND	ND		ND	
	K-1	2	ND	0.002			

A-82

Table A-2 (Continued)

SAMPLING DATA BY POLLUTANT FOR  
CLEANING WATER SUBCATEGORY  
(RAW WASTEWATER)

Pollutant	Process Code§	Sample Type†	Source	Concentrations (mg/l)			Duplicate
				Day 1	Day 2	Day 3	
<u>Priority Pollutants (Continued)</u>							
89. aldrin	A-1	1	ND	ND			
	A-2	1	ND	ND			
	B-3	3	ND	ND	ND	0.000006	
	C-2	3	**	**	ND	0.0001	
	D-1	1	ND	ND			
	D-2	1	ND	ND			
	F-3	3	ND	ND	ND		
	F-4	3	ND	0.0001	ND		
	H-1	1	ND	ND	ND		ND
	I-1	3	ND	ND	ND		ND
	I-2	1	ND	ND	ND		ND
	I-3	1	ND	ND	ND		ND
	K-1	2	ND	ND			
	90. dieldrin	A-1	1	ND	ND		
A-2		1	ND	ND			
B-3		3	ND	ND	ND	ND	
C-2		3	ND	ND	ND	ND	
D-1		1	ND	ND			
D-2		1	ND	ND			
F-3		3	ND	**	ND		
F-4		3	ND	ND	ND		
H-1		1	ND	ND	ND		ND
I-1		3	ND	ND	ND		ND
I-2		1	ND	ND	ND		ND
I-3		1	ND	ND	ND		ND
K-1		2	ND	ND			
97. endosulfan sulfate		A-1	1	ND	ND		
	A-2	1	ND	ND			
	B-3	3	ND	ND	ND	ND	
	C-2	3	ND	**	ND	ND	
	D-1	1	ND	ND			
	D-2	1	ND	ND			
	F-3	3	ND	**	ND		
	F-4	3	ND	ND	ND		
	H-1	1	ND	ND	ND		ND
	I-1	3	ND	ND	ND		ND
	I-2	1	ND	ND	ND		ND
	I-3	1	ND	ND	ND		ND
	K-1	2	ND	ND			

A-83

Table A-2 (Continued)

SAMPLING DATA BY POLLUTANT FOR  
CLEANING WATER SUBCATEGORY  
(RAW WASTEWATER)

Pollutant	Process Code§	Sample Type†	Concentrations (mg/l)				Duplicate
			Source	Day 1	Day 2	Day 3	
<u>Priority Pollutants (Continued)</u>							
98. endrin	A-1	1	ND	ND			
	A-2	1	ND	ND			
	B-3	3	ND	ND	ND	0.00227	
	C-2	3	ND	**	ND	ND	
	D-1	1	ND	ND			
	D-2	1	ND	ND			
	F-3	3	ND	ND	ND		
	F-4	3	ND	ND	ND		
	H-1	1	ND	ND	ND		ND
	I-1	3	ND	ND	ND	ND	
	I-2	1	ND	ND	ND	ND	
	I-3	1	ND	ND		ND	
	K-1	2	ND	ND			
	100. heptachlor	A-1	1	ND	ND		
A-2		1	ND	ND			
B-3		3	ND	ND	ND	0.000004	
C-2		3	ND	**	ND	0.0001	
D-1		1	ND	ND			
D-2		1	ND	ND			
F-3		3	ND	ND	ND		
F-4		3	ND	**	ND		
H-1		1	ND	ND	ND		ND
I-1		3	ND	ND	ND	ND	
I-2		1	ND	ND	ND	ND	
I-3		1	ND	ND		ND	
K-1		2	ND	ND			
102. alpha-BHC		A-1	1	ND	ND		
	A-2	1	ND	ND			
	B-3	3	ND	ND	ND	ND	
	C-2	3	ND	ND	ND	ND	
	D-1	1	ND	0.000004			
	D-2	1	ND	0.000006			
	F-3	3	ND	ND	ND		
	F-4	3	ND	ND	ND		
	H-1	1	0.000002	0.000002	0.000003		0.000003
	I-1	3	ND	ND	ND	ND	
	I-2	1	ND	ND	ND	ND	
	I-3	1	ND	ND		ND	
	K-1	2	ND	ND			

A-84

Table A-2 (Continued)

SAMPLING DATA BY POLLUTANT FOR  
CLEANING WATER SUBCATEGORY  
(RAW WASTEWATER)

Pollutant	Process Code\$	Sample Type†	Concentrations (mg/l)				Duplicate
			Source	Day 1	Day 2	Day 3	
<u>Priority Pollutants (Continued)</u>							
103. beta-BHC	A-1	1	0.000264	0.000005			
	A-2	1	ND	ND			
	B-3	3	0.000008	ND	0.00001	ND	
	C-2	3	ND	ND	ND	ND	
	D-1	1	0.000181	ND			
	D-2	1	0.000181	ND			
	F-3	3	ND	0.0002	ND		
	F-4	3	ND	ND	ND		
	H-1	1	0.000013	0.000016	ND		0.000012
	I-1	3	ND	ND	ND	ND	
	I-2	1	ND	ND	ND	ND	
	I-3	1	ND	ND		ND	
	K-1	2	0.000021	ND			
104. gamma-BHC	A-1	1	ND	ND			
	A-2	1	ND	0.000003			
	B-3	3	ND	ND	ND	0.000005	
	C-2	3	ND	**	ND	**	
	D-1	1	0.000006	ND			
	D-2	1	0.000006	ND			
	F-3	3	**	0.0016	ND		
	F-4	3	**	ND	ND		
	H-1	1	ND	ND	ND		ND
	I-1	3	ND	ND	ND	ND	
	I-2	1	ND	ND	ND	ND	
	I-3	1	ND	ND		ND	
	K-1	2	ND	0.000002			
105. delta-BHC	A-1	1	0.000009	0.000015			
	A-2	1	0.000009	0.000033			
	B-3	3	0.000009	ND	ND	0.000013	
	C-2	3	**	ND	ND	ND	
	D-1	1	ND	ND			
	D-2	1	ND	ND			
	F-3	3	ND	0.0005	ND		
	F-4	3	ND	0.0002	ND		
	H-1	1	0.000006	0.000011	0.000135		0.000012
	I-1	3	ND	ND	ND	ND	
	I-2	1	ND	ND	ND	ND	
	I-3	1	ND	ND		ND	
	K-1	2	0.000018	0.000008			

A-85

Table A-2 (Continued)

SAMPLING DATA BY POLLUTANT FOR  
CLEANING WATER SUBCATEGORY  
(RAW WASTEWATER)

Pollutant	Process Code\$	Sample Type†	Concentrations (mg/l)			Duplicate
			Source	Day 1	Day 2	
<u>Priority Pollutants (Continued)</u>						
114. antimony	A-1	1	ND	ND		
	A-2	1	ND	ND		
	B-3	1	ND	ND	ND	ND
	C-2	3	ND	ND	ND	ND
	D-1	1	ND	ND		
	D-2	1	ND	ND		
	F-3	3	ND	ND	ND	
	F-4	3	ND	ND	ND	
	H-1	1	ND	ND	ND	ND
	I-1	3	0.009	ND	0.081	0.010
	I-2	1	0.009	0.105	ND	0.133
	I-3	1	0.009	0.035		0.019
	K-1	2	ND	ND		
	115. arsenic	A-1	1	ND	ND	
A-2		1	ND	ND		
B-3		1	ND	ND	ND	ND
C-2		3	ND	ND	ND	ND
D-1		1	ND	ND		
D-2		1	ND	ND		
F-3		3	ND	ND	ND	
F-4		3	ND	ND	ND	
H-1		1	ND	ND	ND	ND
I-1		3	0.080	0.095	0.050	0.004
I-2		1	0.080	0.040	0.120	0.010
I-3		1	0.080	0.080		0.080
K-1		2	ND	ND		
119. chromium		A-1	1	ND	ND	
	A-2	1	ND	0.077		
	B-3	1	ND	ND	ND	ND
	C-2	3	ND	ND	0.049	ND
	D-1	1	0.010	ND		
	D-2	1	0.010	0.013		
	F-3	3	ND	ND	0.030	
	F-4	3	ND	0.020	ND	
	H-1	1	ND	ND	ND	ND
	I-1	3	ND	0.070	ND	ND
	I-2	1	ND	0.510	ND	0.53
	I-3	1	ND	0.12		ND
	K-1	2	ND	ND		

A-86



Table A-2 (Continued)

SAMPLING DATA BY POLLUTANT FOR  
CLEANING WATER SUBCATEGORY  
(RAW WASTEWATER)

Pollutant	Process Code§	Sample Type†	Source	Concentrations (mg/l)			Duplicate
				Day 1	Day 2	Day 3	
<u>Priority Pollutants (Continued)</u>							
120. copper	A-1	1	ND	0.054			
	A-2	1	ND	0.626			
	B-3	1	0.15	ND	ND	ND	
	C-2	3	0.068	0.055	0.028	0.046	
	D-1	1	0.106	0.207			
	D-2	1	0.106	0.156			
	F-3	3	0.700	0.045	0.055		
	F-4	3	0.700	0.021	0.042		
	H-1	1	ND	ND	ND		ND
	I-1	3	ND	0.01	ND	0.01	
	I-2	1	ND	1.44	ND	0.91	
	I-3	1	ND	0.23		0.03	
	K-1	2	ND	0.85			
121. cyanide (total)	A-1	1	<0.01	<0.01			
	A-2	1	<0.01	<0.01			
	B-3	1	<0.01	<0.01	<0.01	<0.01	
	C-2	1	0	0	0	0	
	D-1	1	<0.02	<0.02			
	D-2	1	<0.02	<0.02			
	F-3	1	<0.02	<0.02	<0.02	<0.02	
	F-4	1	<0.02	<0.02	<0.02	<0.02	
	H-1	1	<0.01	<0.01	<0.01		<0.01
	I-1	1	0.7	0.025	0.18	0.01	
	I-2	1	0.7	0	0.034	0	
	I-3	1	0.7	0		0.014	
	K-1	2	<0.02	<0.02			
122. lead	A-1	1	ND	ND			
	A-2	1	ND	ND			
	B-3	1	0.1	ND	ND	ND	
	C-2	3	ND	ND	ND	ND	
	D-1	1	ND	ND			
	D-2	1	ND	ND			
	F-3	3	ND	ND	ND		
	F-4	3	ND	ND	ND		
	H-1	1	ND	ND	ND		ND
	I-1	3	ND	ND	ND	ND	
	I-2	1	ND	ND	ND	ND	
	I-3	1	ND	ND		ND	
	K-1	2	ND	ND			

A-87

Table A-2 (Continued)

SAMPLING DATA BY POLLUTANT FOR  
CLEANING WATER SUBCATEGORY  
(RAW WASTEWATER)

Pollutant	Process Code\$	Sample Type†	Source	Concentrations (mg/l)			Duplicate
				Day 1	Day 2	Day 3	
<u>Priority Pollutants (Continued)</u>							
123. mercury	A-1	1	ND	ND			
	A-2	1	ND	ND			
	B-3	1	ND	ND	ND	ND	
	C-2	3	ND	ND	ND	ND	
	D-1	1	ND	ND			
	D-2	1	ND	ND			
	F-3	3	ND	ND	ND		
	F-4	3	ND	ND	ND		
	H-1	1	ND	ND	ND		ND
	I-1	3	ND	ND	ND		ND
	I-2	1	ND	0.0005	ND		0.0003
	I-3	1	ND	0.0001			ND
	K-1	2	ND	ND			
124. nickel	A-1	1	ND	ND			
	A-2	1	ND	0.166			
	B-3	1	ND	ND	ND	ND	
	C-2	3	ND	ND	ND	ND	
	D-1	1	ND	ND			
	D-2	1	ND	ND			
	F-3	3	ND	ND	ND		
	F-4	3	ND	ND	ND		
	H-1	1	ND	ND	ND		ND
	I-1	3	ND	ND	ND		ND
	I-2	1	ND	0.110	ND		0.1
	I-3	1	ND	ND			ND
	K-1	2	ND	ND			
125. selenium	A-1	1	ND	ND			
	A-2	1	ND	ND			
	B-3	1	ND	ND	ND	ND	
	C-2	3	ND	ND	ND	ND	
	D-1	1	ND	ND			
	D-2	1	ND	ND			
	F-3	3	ND	ND	ND		
	F-4	3	ND	ND	ND		
	H-1	1	ND	ND	ND		ND
	I-1	3	0.020	0.010	0.050		0.110
	I-2	1	0.020	0.030	0.110		0.220
	I-3	1	0.020	0.220			0.28
	K-1	2	ND	ND			

A-88

Table A-2 (Continued)

SAMPLING DATA BY POLLUTANT FOR  
CLEANING WATER SUBCATEGORY  
(RAW WASTEWATER)

Pollutant	Process Code§	Sample Type†	Source	Concentrations (mg/l)			Duplicate
				Day 1	Day 2	Day 3	
<u>Priority Pollutants (Continued)</u>							
126. silver	A-1	1	ND	ND			
	A-2	1	ND	ND			
	B-3	1	ND	ND	ND	ND	
	C-2	3	ND	ND	ND	ND	
	D-1	1	ND	ND			
	D-2	1	ND	ND			
	F-3	3	ND	ND	ND		
	F-4	3	ND	ND	ND		
	H-1	1	ND	ND	ND		ND
	I-1	3	ND	ND	ND		ND
	I-2	1	ND	0.018	ND		0.006
	I-3	1	ND	0.002			ND
	K-1	2	ND	ND			
128. zinc	A-1	1	ND	0.108			
	A-2	1	ND	0.71			
	B-3	1	0.06	0.02	ND	0.02	
	C-2	3	ND	0.12	0.080	0.10	
	D-1	1	0.017	0.033			
	D-2	1	0.017	0.027			
	F-3	3	0.015	0.38	0.45		
	F-4	3	0.015	0.029	0.20		
	H-1	1	ND	ND	ND		ND
	I-1	3	1.13	0.253	0.99	0.269	
	I-2	1	1.13	29.8	0.583	17.0	
	I-3	1	1.13	11.9		0.43	
	K-1	2	ND	0.16			

68-A

†Sample Type

- 1 - grab
- 2 - grab composite
- 3 - automatic composite

§See Figures VI-1 through VI-11.

\*Indicates a reported less than value of <0.001 mg/l.

\*\*Indicates a reported less than value of <0.0001 mg/l.

††Total phenols data from plant F were not used based on verification sampling.

NA - Pollutant was not analyzed.

ND - Not detected.

Table A-3

SAMPLING DATA BY POLLUTANT FOR  
FINISHING WATER SUBCATEGORY  
(RAW WASTEWATER)

Pollutant	Process Code§	Sample Type†	Concentrations (mg/l)				
			Source	Day 1	Day 2	Day 3	Duplicate
<u>Conventional Pollutants</u>							
biological oxygen demand (BOD <sub>5</sub> )	I-4	3	0.75	3.8	6.4	5.7	
	N-1	3	5	7	7		8
	Q-1	3	1	11	6		14
oil and grease	I-4	1	0	2.4	2.0	19.7	
	N-1	1	<1	22	16		19
	Q-1	1	<1	<1	<1		<1
pH	I-4	3	7.8	8.4	8.0	8.4	
	N-1	3	8.32	7.89	7.63		7.92
	Q-1	3	5.99	6.36	6.59		6.41
total suspended solids (TSS)	I-4	3	33	63	289	1359	
	N-1	3	3	7	<1		<1
	Q-1	3	<1	9.1	6.3		16
<u>Nonconventional Pollutants</u>							
aluminum	I-4	3	0.20	6.7	9.75	10.9	
	N-1	3	ND	ND	ND		ND
	Q-1	3	ND	2.48	0.574		2.640
barium	I-4	3	0.03	0.03	0.04	0.03	
	N-1	3	ND	ND	ND		0.010
	Q-1	3	ND	0.062	ND		0.065
boron	I-4	3	0.70	0.70	0.59	0.62	
	N-1	3	ND	ND	ND		0.012
	Q-1	3	ND	ND	ND		0.018
calcium	I-4	3	7.04	12.4	13.6	11.3	
	N-3	3	22.1	2.97	19.3		3.04
	Q-1	3	16.3	17.0	12.9		17.2
chemical oxygen demand (COD)	I-4	3	225	170	325	290	
	N-1	3	20	20	20		25
	Q-1	3	16	47	<5		31

A-90

Table A-3 (Continued)

SAMPLING DATA BY POLLUTANT FOR  
FINISHING WATER SUBCATEGORY  
(RAW WASTEWATER)

Pollutant	Process Code§	Sample Type†	Source	Concentrations (mg/l)			Duplicate
				Day 1	Day 2	Day 3	
<u>Nonconventional Pollutants</u> (Continued)							
iron	I-4	3	0.247	5.04	8.61	9.66	
	N-1	3	ND	0.051	ND		1.13
	Q-1	3	0.218	1.09	0.386		1.130
magnesium	I-4	3	3.05	3.58	3.82	3.63	
	N-1	3	3.19	0.386	2.96		0.401
	Q-1	3	5.050	5.050	3.46		5.100
manganese	I-4	3	0.009	0.084	0.064	0.152	
	N-1	3	ND	ND	ND		ND
	Q-1	3	0.186	0.304	0.266		0.308
sodium	I-4	3	359.0	317.0	318.0	326.0	
	N-1	3	34.3	67.3	37.2		60.8
	Q-1	3	8.28	11.70	15.6		11.900
titanium	I-4	3	0.01	0.054	0.076	0.076	
	N-1	3	ND	ND	ND		ND
	Q-1	3	ND	ND	ND		0.030
total organic carbon (TOC)	I-4	3	1.7	11.2	27.0	238	
	N-1	3	10	14	14		14
	Q-1	3	<1	15	2		26
total phenols	I-4	1	4.5	2.55	8.75	1.22	
	N-1	1	0.39	0.39	0.45		0.51
	Q-1	1	<0.01	<0.01	<0.01		<0.01
<u>Priority Pollutants</u>							
4. benzene	I-4	2	0.003	ND	0.009	0.007	
	N-1	2	ND	ND	ND		ND
	Q-1	2	ND	ND	ND		ND
8. 1,2,4-trichlorobenzene	I-4	3	ND	ND	ND	ND	
	N-1	3	ND	ND	ND		ND
	Q-1	3	ND	0.015377	ND		0.019457

I6-V

Table A-3 (Continued)

SAMPLING DATA BY POLLUTANT FOR  
FINISHING WATER SUBCATEGORY  
(RAW WASTEWATER)

Pollutant	Process Code§	Sample Type†	Concentrations (mg/l)				Duplicate
			Source	Day 1	Day 2	Day 3	
<u>Priority Pollutants (Continued)</u>							
11. 1,1,1-trichloroethane	I-4	2	ND	0.018	ND	ND	
	N-1	2	ND	ND	ND		ND
	Q-1	2	ND	ND	ND		ND
12. hexachloroethane	I-4	3	ND	ND	ND	ND	
	N-1	3	0.00706	0.006641	ND		ND
	Q-1	3	ND	ND	ND		ND
28. 3,3'-dichlorobenzidine	I-4	3	ND	ND	ND	ND	
	N-1	3	ND	ND	ND		ND
	Q-1	3	ND	0.012897	ND		ND
34. 2,4-dimethyl phenol	I-4	3	ND	ND	ND	ND	
	N-1	3	ND	ND	ND		ND
	Q-1	3	0.006066	0.005919	0.005775		ND
38. ethylbenzene	I-4	2	ND	ND	ND	ND	
	N-1	2	ND	ND	ND		ND
	Q-1	2	ND	0.007981	0.011498		0.008547
44. methylene chloride	I-4	2	0.0090	ND	0.0060	ND	
	N-1	2	ND	ND	ND		ND
	Q-1	2	ND	ND	ND		ND
65. phenol	I-4	3	0.081	0.014	0.073	0.20	
	N-1	3	ND	ND	ND		ND
	Q-1	3	ND	ND	ND		ND
66. bis(2-ethylhexyl)phthalate	I-4	3	ND	0.005	0.040	0.014	
	N-1	3	ND	0.003189	0.006894		0.008537
	Q-1	3	0.00613	1.31412	0.011232		1.48768
68. di-n-butyl phthalate	I-4	3	ND	0.014	ND	0.017	
	N-1	3	ND	ND	0.009198		ND
	Q-1	3	0.003012	0.038445	0.080856		0.056065
71. dimethyl phthalate	I-4	3	ND	ND	ND	ND	
	N-1	3	ND	ND	ND		ND
	Q-1	3	ND	0.003509	0.194388		ND

A-92

Table A-3 (Continued)  
 SAMPLING DATA BY POLLUTANT FOR  
 FINISHING WATER SUBCATEGORY  
 (RAW WASTEWATER)

Pollutant	Process Code\$	Sample Type†	Source	Concentrations (mg/l)			Duplicate
				Day 1	Day 2	Day 3	
<u>Priority Pollutants (Continued)</u>							
87. trichloroethylene	I-4	2	ND	ND	ND	ND	
	N-1	2	ND	0.009976	0.015113		0.010828
	Q-1	2	ND	ND	ND		ND
114. antimony	I-4	3	ND	ND	0.01	0.01	
	N-1	3	ND	ND	ND		ND
	Q-1	3	ND	ND	ND		ND
115. arsenic	I-4	3	0.10	0.11	0.11	0.01	
	N-1	3	ND	ND	ND		ND
	Q-1	3	ND	ND	ND		ND
119. chromium	I-4	3	ND	ND	0.01	0.01	
	N-1	3	ND	ND	ND		ND
	Q-1	3	ND	ND	ND		ND
120. copper	I-4	3	ND	ND	0.02	0.01	
	N-1	3	ND	ND	ND		0.018
	Q-1	3	ND	0.073	ND		0.072
121. cyanide	I-4	1	0	0.015	0	0.013	
	N-1			NA			
	Q-1			NA			
122. lead	I-4	3	ND	ND	ND	ND	
	N-1	3	ND	ND	ND		ND
	Q-1	3	ND	ND	0.179		ND
123. mercury	I-4	3	ND	0.0002	ND	0.0001	
	N-1	3	ND	ND	ND		ND
	Q-1	3	ND	0.00025	ND		ND
124. nickel	I-4	3	ND	0.04	ND	0.04	
	N-1	3	ND	ND	ND		ND
	Q-1	3	ND	ND	ND		ND

E6-V

Table A-3 (Continued)  
 SAMPLING DATA BY POLLUTANT FOR  
 FINISHING WATER SUBCATEGORY  
 (RAW WASTEWATER)

<u>Pollutant</u>	<u>Process Codes</u>	<u>Sample Type</u>	<u>Concentrations (mg/l)</u>				
			<u>Source</u>	<u>Day 1</u>	<u>Day 2</u>	<u>Day 3</u>	<u>Duplicate</u>
<u>Priority Pollutants (Continued)</u>							
125. selenium	I-4	3	0.06	0.20	0.30	0.28	
	N-1	3	ND	ND	ND		ND
	Q-1	3	ND	ND	ND		ND
128. zinc	I-4	3	ND	0.084	0.229	0.176	
	N-1	3	ND	ND	ND		0.009
	Q-1	3	0.022	0.196	0.028		0.204

A-94

---

†Sample Type

- 1 - grab
- 2 - grab composite
- 3 - automatic composite

§See Figures VI-9, VI-12, and VI-15.

NA - Pollutant was not analyzed.

ND - Not detected.



Table A-4

SAMPLING DATA BY POLLUTANT FOR  
WASTEWATER TREATMENT SYSTEM ONE  
(PLANT 1)

Pollutant	Process Code†	Sample Type††	Source	Concentrations (mg/l)			Duplicate
				Day 1	Day 2	Day 3	
<u>Conventional Pollutants</u>							
biological oxygen demand (BOD <sub>5</sub> )	I-3	1	1.7	3.2	6.6		
	I-5	1	1.7	5.1	1.6	4.4	
oil and grease	I-3	1	0	21.2	7.8		
	I-5	1	0	13.4	11.6	8.3	
pH	I-3	1	6.6	11.0	8.0		
	I-5	1	6.6	11.1	8.0	9.0	
total suspended solids (TSS)	I-3	1	56	1136	5671		
	I-5	1	56	356	305	329	
<u>Nonconventional Pollutants</u>							
aluminum	I-3	1	0.2	4.2	5.2		
	I-5	1	0.2	0.4	0.4	0.3	
ammonia nitrogen	I-3	1	0.2	75.0	67.5		
	I-5	1	0.2	95	40.3	166.2	
barium	I-3	1	0.03	0.16	0.05		
	I-5	1	0.03	0.07	0.07	ND	
boron	I-3	1	0.05	0.52	0.58		
	I-5	1	0.05	0.061	0.07	0.20	
calcium	I-3	1	51.3	45.2	26.8		
	I-5	1	51.3	36.0	31.5	7.23	
chemical oxygen demand (COD)	I-3	1	290	200	950		
	I-5	1	290	320	880	600	
cyanide amenable	I-3	1	0.6	0	0.01		
	I-5	1	0.6	0.021	0.021	0.022	
iron	I-3	1	0.067	10.6	4.73		
	I-5	1	0.067	0.404	0.202	0.224	

Table A-4 (Continued)

SAMPLING DATA BY POLLUTANT FOR  
WASTEWATER TREATMENT SYSTEM ONE  
(PLANT I)

Pollutant	Process Code	Sample Type	Source	Concentrations (mg/l)			Duplicate
				Day 1	Day 2	Day 3	
<u>Nonconventional Pollutants (Continued)</u>							
Kjeldahl nitrogen	I-3	1	3.85	1310	1188		
	I-5	1	3.85	1377	84.7	4750	
magnesium	I-3	1	7.17	6.42	5.27		
	I-5	1	7.17	3.28	49.3	1.12	
manganese	I-3	1	ND	0.111	0.084		
	I-5	1	ND	ND	ND	ND	
sodium	I-3	1	12.4	272	317		
	I-5	1	12.4	3970	2320	958	
surfactants	I-3	1	0.15	0.15	0.112		
	I-5	1	0.15	0.70	0.125	0.07	
tin	I-3	1	ND	ND	ND		
	I-5	1	ND	ND	ND	0.8	
titanium	I-3	1	ND	0.060	0.075		
	I-5	1	ND	ND	ND	ND	
total dissolved solids (TDS)	I-3	1	201.5	13000	812.5		
	I-5	1	201.5	4517.5	3315	1950	
total organic carbon (TOC)	I-3	1	11.0	5316	4998		
	I-5	1	11.0	2813	4628	5250	
total phenols	I-3	1	2.7	730	0.83		
	I-5	1	2.7	322	591	0.72	
total phosphorus	I-3	1	3.18	32.1	5.17		
	I-5	1	3.18	99.6	224	45.2	
vanadium	I-3	1	ND	ND	ND		
	I-5	1	ND	0.022	0.022	0.022	
<u>Priority Pollutants</u>							
4. benzene	I-3	2	0.007	0.01	0.009		
	I-5	2	0.007	0.009	0.010	0.003	0.010

Table A-4 (Continued)

SAMPLING DATA BY POLLUTANT FOR  
WASTEWATER TREATMENT SYSTEM ONE  
(PLANT I)

Priority	Pollutant	Process Code†	Sample Type††	Source	Concentrations (mg/l)			Duplicate
					Day 1	Day 2	Day 3	
<u>Priority Pollutants (Continued)</u>								
11.	1,1,1-trichloroethane	I-3	2	ND	ND	ND		
		I-5	2	ND	0.002	0.003	ND	ND
15.	1,1,2,2-tetrachloroethane	I-3	2	ND	ND	ND		
		I-5	2	ND	ND	ND	ND	0.002
21.	2,4,6-trichlorophenol	I-3	1	ND	ND	ND		
		I-5	1	ND	0.001	0.0005	ND	0.002
23.	chloroform	I-3	2	0.12	0.004	0.002		
		I-5	2	0.12	ND	0.007	0.010	0.006
24.	2-chlorophenol	I-3	1	ND	0.006	ND		
		I-5	1	ND	0.014	0.005	0.002	0.009
31.	2,4-dichlorophenol	I-3	1	ND	0.001	ND		
		I-5	1	ND	0.005	0.002	ND	0.006
39.	fluoranthene	I-3	1	ND	0.004	ND	ND	
		I-5	1	ND	ND	ND	ND	ND
44.	methylene chloride	I-3	2	0.005	0.005	ND		
		I-5	2	0.005	0.010	ND	ND	ND
48.	dichlorobromomethane	I-3	2	0.009	ND	ND		
		I-5	2	0.009	ND	ND	ND	ND
51.	chlorodibromomethane	I-3	2	0.004	ND	ND		
		I-5	2	0.004	ND	ND	ND	ND
62.	N-nitrosodiphenylamine	I-3	1	ND	0.016	0.001		
		I-5	1	ND	0.004	0.004	0.006	0.003
64.	pentachlorophenol	I-3	1	ND	ND	ND		
		I-5	1	ND	0.002	ND	ND	0.001
65.	phenol	I-3	1	0.030	2.6	0.74		
		I-5	1	0.030	7.7	2.0	1.5	2.7
66.	bis(2-ethylhexyl)phthalate	I-3	1	0.001	0.004	0.007		
		I-5	1	0.001	0.0007	0.006	0.012	0.003

Table A-4 (Continued)

SAMPLING DATA BY POLLUTANT FOR  
WASTEWATER TREATMENT SYSTEM ONE  
(PLANT I)

Pollutant	Process Code†	Sample Type††	Concentrations (mg/l)				
			Source	Day 1	Day 2	Day 3	Duplicate
<u>Priority Pollutants (Continued)</u>							
68. di-n-butyl phthalate	I-3	1	ND	ND	0.006		
	I-5	1	ND	0.002	0.002	0.002	0.004
84. pyrene	I-3	1	ND	0.0004	ND		
	I-5	1	ND	ND	ND	ND	ND
86. toluene	I-3	2	ND	0.15	ND		
	I-5	2	ND	0.11	0.039	0.032	0.103
114. antimony	I-3	1	0.009	0.035	0.019		
	I-5	1	0.009	0.141	0.038	0.087	
115. arsenic	I-3	1	0.080	0.080	0.080		
	I-5	1	0.080	0.095	0.22	0.036	
119. chromium	I-3	1	ND	0.12	ND		
	I-5	1	ND	ND	ND	ND	
121. cyanide (total)	I-3	1	0.700	0	0.014		
	I-5	1	0.700	0.024	0.017	0.018	
123. mercury	I-3	1	ND	0.0001	ND		
	I-5	1	ND	ND	ND	0.0001	
124. nickel	I-3	1	ND	ND	ND		
	I-5	1	ND	ND	ND	0.110	
125. selenium	I-3	1	0.020	0.220	0.28		
	I-5	1	0.020	0.110	0.090	0.16	
126. silver	I-3	1	ND	0.002	ND		
	I-5	1	ND	ND	ND	ND	

†I-3 is influent, I-5 is effluent; see Figure VI-9.

††Sample Type

- 1 - grab
- 2 - grab composite

ND - Not detected.

Table A-5

SAMPLING DATA BY POLLUTANT FOR  
WASTEWATER TREATMENT SYSTEM TWO  
(PLANT I)

<u>Pollutant</u>	<u>Process Code†</u>	<u>Sample Type††</u>	<u>Source</u>	<u>Concentrations (mg/l)</u>			<u>Duplicate</u>
				<u>Day 1</u>	<u>Day 2</u>	<u>Day 3</u>	
<u>Conventional Pollutants</u>							
biological oxygen demand (BOD <sub>5</sub> )	I-4	3	0.75	3.8	6.4	5.7	
	I-6	1	0.75	2.65	3.8	5.6	
oil and grease	I-4	1	0	2.4	2.0	19.7	
	I-6	1	0	0	0	0	
pH	I-4	3	7.8	8.4	8.0	8.4	
	I-6	1	7.8	9.1	6.5	7.5	
total suspended solids (TSS)	I-4	3	33	63	289	1359	
	I-6	1	33	12	7	0	
<u>Nonconventional Pollutants</u>							
aluminum	I-4	3	0.200	6.7	9.75	10.9	
	I-6	1	0.200	0.200	0.200	0.300	
ammonia nitrogen	I-4	3	0.45	0.25	57.5	3.0	
	I-6	1	0.45	0.38	0.35	0	
barium	I-4	3	0.030	0.030	0.040	0.030	
	I-6	1	0.030	0.030	ND	0.030	
boron	I-4	3	0.700	0.700	0.590	0.620	
	I-6	1	0.700	0.520	0.520	0.730	
calcium	I-4	3	7.04	12.4	13.6	11.3	
	I-6	1	7.04	17.1	11.6	11.4	
chemical oxygen demand (COD)	I-4	3	225	170	325	290	
	I-6	1	225	125	295	40	
cyanide amenable	I-4	3	0	0.013	0	0.013	
	I-6	1	0	0.008	0.006	0.006	
iron	I-4	3	0.247	5.04	8.61	9.66	
	I-6	1	0.247	0.089	0.314	0.089	

Table A-5 (Continued)

SAMPLING DATA BY POLLUTANT FOR  
WASTEWATER TREATMENT SYSTEM TWO  
(PLANT I)

Pollutant	Process Code#	Sample Type#	Concentrations (mg/l)			
			Source	Day 1	Day 2	Day 3
<u>Nonconventional Pollutants (Continued)</u>						
Kjeldahl nitrogen	I-4	3	8.55	4.5	1380	51.9
	I-6	1	8.55	7.22	6.2	1.76
magnesium	I-4	3	3.05	3.58	3.82	3.63
	I-6	1	3.05	3.76	3.24	3.22
manganese	I-4	3	0.009	0.084	0.064	0.152
	I-6	1	0.009	0.016	ND	ND
sodium	I-4	3	359	317	318	326
	I-6	1	359	291	325	328
surfactants	I-4	3	0.25	0.20	0.20	0.30
	I-6	1	0.25	0.15	0.15	0.10
tin	I-4	3	ND	ND	ND	ND
	I-6	1	ND	1.9	ND	ND
titanium	I-4	3	0.010	0.054	0.076	0.076
	I-6	1	0.010	ND	ND	ND
total dissolved solids (TDS)	I-4	3	981.5	1040	910	910
	I-6	1	981.5	715	897	981.5
total organic carbon (TOC)	I-4	3	1.7	11.2	27.0	238
	I-6	1	1.7	25.2	1.3	5.6
total phenols	I-4	3	4.5	2.55	8.75	1.22
	I-6	1	4.5	15.10	0.08	4.93
total phosphorus	I-4	3	0.52	0.10	0.96	1.94
	I-6	1	0.52	4.22	1.06	0
vanadium	I-4	3	ND	ND	ND	0.006
	I-6	1	ND	ND	ND	ND
<u>Priority Pollutants</u>						
4. benzene	I-4	2	0.003	ND	0.009	0.007
	I-6	2	0.003	0.008	0.008	ND

Table A-5 (Continued)

SAMPLING DATA BY POLLUTANT FOR  
WASTEWATER TREATMENT SYSTEM TWO  
(PLANT I)

Pollutant	Process Code†	Sample Type††	Source	Concentrations (mg/l)			Duplicate
				Day 1	Day 2	Day 3	
<u>Priority Pollutants (Continued)</u>							
11. 1,1,1-trichloroethane	I-4	2	ND	0.018	ND	ND	
	I-6	2	ND	ND	ND	ND	
44. methylene chloride	I-4	2	0.009	ND	0.006	ND	
	I-6	2	0.009	0.004	0.014	ND	
65. phenol	I-4	3	0.081	0.014	0.073	0.200	
	I-6	1	0.081	0.016	0.250	0.130	
66. bis(2-ethylhexyl)phthalate	I-4	3	ND	0.005	0.040	0.014	
	I-6	1	ND	0.020	0.002	ND	
68. di-n-butyl phthalate	I-4	3	ND	0.014	ND	0.017	
	I-6	1	ND	ND	0.012	ND	
69. di-n-octyl phthalate	I-4	3	ND	ND	ND	ND	
	I-6	1	ND	ND	0.053	ND	
70. diethyl phthalate	I-4	3	ND	ND	ND	ND	
	I-6	1	ND	ND	0.0009	ND	
86. toluene	I-4	2	ND	ND	ND	ND	
	I-6	2	ND	0.001	ND	ND	
114. antimony	I-4	3	ND	ND	0.010	0.010	
	I-6	1	ND	ND	0.005	0.009	
115. arsenic	I-4	3	0.100	0.110	0.110	0.010	
	I-6	1	0.100	0.095	0.110	0.018	
119. chromium	I-4	3	ND	ND	0.010	0.010	
	I-6	1	ND	ND	ND	ND	
120. copper	I-4	3	ND	ND	0.020	0.010	
	I-6	1	ND	ND	ND	ND	
121. cyanide (total)	I-4	1	0	0.015	0	0.013	
	I-6	1	0	0.008	0.006	0.006	
123. mercury	I-4	3	ND	0.0002	ND	0.0001	
	I-6	1	ND	ND	0.0001	0.0004	

A-101

Table A-5 (Continued)

SAMPLING DATA BY POLLUTANT FOR  
WASTEWATER TREATMENT SYSTEM TWO  
(PLANT 1)

<u>Pollutant</u>	<u>Process Code†</u>	<u>Sample Type††</u>	<u>Concentrations (mg/l)</u>			
			<u>Source</u>	<u>Day 1</u>	<u>Day 2</u>	<u>Day 3</u>
<u>Priority Pollutants (Continued)</u>						
124. nickel	I-4	3	ND	0.040	ND	0.040
	I-6	1	ND	ND	0.040	ND
125. selenium	I-4	3	0.060	0.200	0.300	0.280
	I-6	1	0.060	0.160	0.060	0.090
128. zinc	I-4	3	ND	0.084	0.229	0.176
	I-6	1	ND	0.015	ND	ND

A-102

†I-4 is influent, I-6 is effluent; see Figure VI-9.

††Sample Type

- 1 - grab
- 2 - grab composite
- 3 - automatic composite

ND - Not detected.



Table A-6

SAMPLING DATA BY POLLUTANT FOR  
WASTEWATER TREATMENT SYSTEM AT PLANT M

Pollutant	Process Code†	Sample Type††	Concentrations (mg/l)			
			Source	Day 1	Day 2	Day 3
<u>Conventional Pollutants</u>						
biological oxygen demand (BOD <sub>5</sub> )	M-3	1	38	3.5		
	M-4	1	38	18		
oil and grease	M-3	1	<1	72		
	M-4	1	<1	74		
pH	M-3	1	7.57	7.99		
	M-4	1	7.57	7.83		
total suspended solids (TSS)	M-3	1	<1	23		
	M-4	1	<1	9		
<u>Nonconventional Pollutants</u>						
chemical oxygen demand (COD)	M-3	1	90	<10		
	M-4	1	90	46		
total organic carbon (TOC)	M-3	1	<1	21		
	M-4	1	<1	30		
total phenols	M-3	1	<0.005	0.075		
	M-4	1	<0.005	0.280		

†M-3 is influent, M-4 is effluent; see Figure VI-13.

††Sample Type

1 - grab

Table A-7

SAMPLING DATA BY POLLUTANT FOR  
WASTEWATER TREATMENT SYSTEM AT PLANT N

Pollutant	Process Code†	Sample Type††	Concentrations (mg/l)			
			Source	Day 1	Day 2	Day 3
<u>Conventional Pollutants</u>						
biological oxygen demand (BOD <sub>5</sub> )	N-1	3	5	7	7	8
	N-4	3	5	7	9	
oil and grease	N-1	1	<1	22	16	19
	N-4	1	<1	15	<1	
pH	N-1	3	8.32	7.89	7.63	7.92
	N-4	3	8.32	7.9	7.21	
total suspended solids (TSS)	N-1	3	3	9	<1	<1
	N-4	3	3	4	8	
<u>Nonconventional Pollutants</u>						
chemical oxygen demand (COD)	N-1	3	20	20	20	25
	N-4	3	20	30	25	
total organic carbon (TOC)	N-1	3	10	14	14	14
	N-4	3	10	14	13	
total phenols	N-1	1	0.39	0.39	0.45	0.51
	N-4	1	0.39	0.38	7.49	

†N-1 is influent, N-4 is effluent; see Figure VI-13.

††Sample Type

- 1 - grab
- 3 - grab composite

Table A-8

SAMPLING DATA BY POLLUTANT FOR  
WASTEWATER TREATMENT SYSTEM AT PLANT R

<u>Pollutant</u>	<u>Process Codet</u>	<u>Sample Type††</u>	<u>Concentrations (mg/l)</u>			
			<u>Source</u>	<u>Day 1</u>	<u>Day 2</u>	<u>Day 3</u>
<u>Conventional Pollutants</u>						
biological oxygen demand (BOD <sub>5</sub> )	R-1	2	4	6		
	R-2	2	4	4		
	R-4	1	4	4		
oil and grease	R-1	2	9	6		
	R-2	2	9	8		
	R-4	1	9	7		
pH	R-1	1	7.35	7.21		
	R-2	1	7.35	7.36		
	R-4	1	7.35	7.35		
total suspended solids (TSS)	R-1	2	<1	<1		
	R-2	2	<1	<1		
	R-4	1	<1	<1		
<u>Nonconventional Pollutants</u>						
chemical oxygen demand (COD)	R-1	2	50	16		
	R-2	2	50	20		
	R-4	1	50	16		
total organic carbon (TOC)	R-1	2	7	6		
	R-2	2	7	5		
	R-4	1	7	6		
total phenols	R-1	1	0.17	0.42		
	R-2	1	0.17	0.34		
	R-4	1	0.17	0.40		

†R-1 and R-2 are influent, R-4 is recycle; see Figure VI-17.

††Sample Type

- 1 - grab
- 2 - grab composite

Table A-9

## SOLVENT RECOVERY WASTEWATER DATA - PLANT G

Pollutant	Process Code\$	Sample Type†	Source	Concentrations (mg/l)			
				Day 1	Day 2	Day 3	Duplicate
<u>Conventional Pollutants</u>							
biological oxygen demand (BOD <sub>5</sub> )	G-2	3	<5.0	7.0	††	††	10.0
oil and grease	G-2	2	6.0	8.0	8.0	<4.0	<4.0
pH	G-2	2	7.4	3.6	3.6	3.6	3.6
total suspended solids	G-2	3	16.0	14.0	14.0	<4.0	18.0
<u>Nonconventional Pollutants</u>							
acetone	G-2	3	NA	0.020	0.077	0.144	0.027
ammonia nitrogen	G-2	3	<0.05	<0.05	0.19	0.05	<0.05
boron	G-2	3	ND	0.042	ND	ND	
bromide	G-2	3	0.56	<0.4	<0.4	0.8	<0.4
calcium	G-2	3	0.062	0.041	0.144	0.044	
chemical oxygen demand (COD)	G-2	3	<5.0	435	465	482	470
fluoride	G-2	3	0.46	0.13	0.18	0.25	0.18
iron	G-2	3	ND	1.009	0.886	0.862	
Kjeldahl nitrogen	G-2	3	<1.0	<1.0	<1.0	<1.0	<1.0
magnesium	G-2	3	0.181	0.163	0.17	0.167	
nitrate/nitrite	G-2	3	5.8	<0.1	0.2	<0.1	<0.1
sodium	G-2	3	ND	ND	ND	ND	
sulfate	G-2	2	1040	<5.0	<5.0	<5.0	<5.0
sulfide	G-2	3	<1.0	<1.0	<1.0	<1.0	<1.0
surfactants	G-2	3	<0.01	<0.01	0.02	0.03	<0.01

A-106

Table A-9 (Continued)

## SOLVENT RECOVERY WASTEWATER DATA - PLANT G

Pollutant	Process Code§	Sample Type†	Source	Concentrations (mg/l)			Duplicate
				Day 1	Day 2	Day 3	
<u>Nonconventional Pollutants (Continued)</u>							
titanium	G-2	3	0.01	ND	0.008	0.011	
total organic carbon (TOC)	G-2	3	<1.0	165	179	174	178
total phenols	G-2	2	0.023	0.170	0.19	0.15	0.150
total phosphorus	G-2	3	0.04	0.04	0.04	<0.02	0.04
vanadium	G-2	3	ND	0.046	ND	ND	
yttrium	G-2	3	ND	ND	ND	ND	
<u>Priority Pollutants</u>							
1. acenaphthene	G-2	3	ND	ND	0.094	ND	ND
6. carbon tetrachloride	G-2	2	0.001	ND	0.018	ND	ND
11. 1,1,1-trichloroethane	G-2	2	0.004	0.001	0.002	0.001	0.001
18. bis(2-chloroethyl)ether	G-2	3	ND	0.001	ND	ND	0.003
23. chloroform	G-2	2	0.006	0.002	0.004	0.001	0.002
44. methylene chloride	G-2	2	0.001	0.008	0.026	0.007	0.008
47. bromoform	G-2	2	ND	ND	*	ND	*
62. N-nitrosodiphenylamine	G-2	3	ND	ND	*	*	ND
65. phenol	G-2	3	ND	0.011	*	0.090	ND
66. bis(2-ethylhexyl)phthalate	G-2	3	0.015	0.005	0.003	0.004	0.116
68. di-n-butyl phthalate	G-2	3	0.003	0.007	0.012	0.008	0.003
70. diethyl phthalate	G-2	3	0.005	0.136	0.439	0.177	ND
71. dimethyl phthalate	G-2	3	ND	0.002	0.0730	.043	ND

A-107

Table A-9 (Continued)

## SOLVENT RECOVERY WASTEWATER DATA - PLANT G

Pollutant	Process Code§	Sample Type†	Source	Concentrations (mg/l)			Duplicate
				Day 1	Day 2	Day 3	
<u>Priority Pollutants (Continued)</u>							
72. benzo(a)anthracene	G-2	3	ND	*	*	*	ND
73. benzo(a)pyrene	G-2	3	ND	*	0.002	*	0.002
80. fluorene	G-2	3	ND	ND	*	ND	ND
84. pyrene	G-2	3	ND	ND	ND	*	ND
85. tetrachloroethylene	G-2	2	0.012	ND	ND	ND	ND
86. toluene	G-2	3	ND	ND	ND	ND	0.001
87. trichloroethylene	G-2	2	0.343	ND	ND	0.001	ND
100. heptachlor	G-2	3	ND	0.000150	ND	ND	ND
101. heptachlor epoxide	G-2	3	ND	ND	0.000084	ND	ND
102. alpha-BHC	G-2	3	ND	ND	ND	0.000006	ND
103. beta-BHC	G-2	3	0.000166	0.000225	ND	ND	0.000011
120. copper	G-2	3	ND	0.037	0.086	0.072	
121. cyanide (total)	G-2	2	<0.02	<0.02	<0.02	<0.02	<0.02
128. zinc	G-2	3	ND	0.026	0.004	ND	

A-108

## †Sample Type

- 2 - grab composite
- 3 - automatic composite

§See Figures VI-1 through VI-11.

††Value not used in the subcategory average calculation because it was suspected to be result of laboratory contamination.

\*Indicates a reported less than value of &lt;0.001 mg/l.

NA - Pollutant was not analyzed.

ND - Not detected.

APPENDIX B

STATE INDUSTRIAL GUIDES

APPENDIX B  
STATE INDUSTRIAL GUIDES

This appendix lists the State Industrial Guides used to estimate the size of the PM&F category. This estimate is described in Section IV.

<u>State</u>	<u>Edition</u>	<u>Title and Publisher</u>
Alabama	1980-81	<u>Alabama Director of Mining and Manufacturing, Industrial Research Department, Alabama Development Office</u>
Arizona	1982	<u>Arizona Directory of Manufacturers, Phoenix Metropolitan Chamber of Commerce</u>
Arkansas	1982	<u>Arkansas Directory of Manufacturers, Arkansas Industrial Development Foundation</u>
California	1983	<u>California Manufacturer's Register, California Manufacturer's Association</u>
Colorado	1982	<u>Directory of Colorado Manufacturers, University of Colorado, Boulder, Business Division, College of Business and Administration</u>
Connecticut	1982	<u>MacRae's Connecticut State Industrial Directory</u>
Delaware	1981-82	<u>Delaware Directory of Commerce and Industry, Delaware State Chamber of Commerce</u>
Florida	1982	<u>Directory of Florida Industries, The Florida Chamber of Commerce c 1981</u>
Georgia	1980-81	<u>Georgia Manufacturing Directory, Georgia Department of Industry and Trade, c. 1980</u>



<u>State</u>	<u>Edition</u>	<u>Title and Publisher</u>
Idaho	1982	<u>Idaho Manufacturing Directory</u> University of Idaho Center for Business Development and Research
Illinois	1983	<u>Illinois Manufacturers Directory, Manufacturer's News Inc., Chicago, IL</u> Editor, Louise M. West
Indiana	1983	<u>Harris Indiana Marketer's Industrial Directory, Harris Publishing Company (1983, Ohio), State Directory Division</u>
Iowa	1981-82	<u>Directory of Iowa Manufacturers, Iowa Development Commission</u>
Kansas	1981-82	<u>Directory of Kansas Manufacturers and Products, Kansas Department of Economic Development</u>
Kansas	1981-82	<u>Directory of Kansas Manufacturers and Products, Kansas Economic Development Commission</u>
Kentucky	1983	<u>Kentucky Directory of Manufacturers, Kentucky Department of Economic Development</u>
Louisiana	1982	<u>Directory of Louisiana Manufacturers, Louisiana Department of Commerce</u>
Maine	1981-82	<u>Directory of New England Manufacturers, New England Council, George D. Hall Company</u>
Maryland	1981-82	<u>The Directory of Maryland Manufacturers, State of Maryland, Department of Economic and Community Development</u>
Massachusetts	1981-82	<u>Directory of Massachusetts Manufacturers, George D. Hall's Association Industires of Mass c. 1981</u>
Michigan	1982	<u>The Directory of Michigan Manufacturers, Pick Publications, Inc.</u>
Minnesota	1981	<u>Minnesota Directory of Manufacturers, Minnesota Department of Economic Development</u>

<u>State</u>	<u>Edition</u>	<u>Title and Publisher</u>
Mississippi	1980	<u>Mississippi Manufacturers Directory</u> Mississippi Research and Development Center, printed 1979
Missouri	1982	<u>Missouri Directory, Mining and Manu- facturing Industires Services and Supplies</u> , Information Data Company
Nebraska	1982-83	<u>A Directory of Nebraska Manufacturers and Their Products</u> , Nebraska Depart- ment of Economic Development
Nevada	1981	<u>Nevada Industrial Directory</u> , Nevada Department of Economic Development
New Hampshire	1982-83	<u>Made in New Hampshire, State of New Hampshire</u> , Office of Industrial Development, Division of Economic Development
New Jersey	1983	<u>New Jersey State Industrial Directory</u> MacRae's Blue Book, Inc.
New York	1983	<u>New York State Industrial Directory</u> , MacRae's Blue Book, Inc. Editor, Barbara Sadic
North Carolina	1981-82	<u>Directory of North Carolina Manufac- turing Firms</u> , North Carolina Depart- ment of Commerce
North Dakota	1978-79	<u>Directory of North Dakota Manufactur- ing</u> , North Dakota Business and Industrial Development Department
Ohio	1983	<u>Ohio Marketers Industrial Directory</u> , Harris Publishing Company
Oklahoma	1980	<u>Oklahoma Directory of Manufacturers and Products</u> , Industrial Development Department
Pennsylvania	1982	<u>MacRae's Pennsylvania State Indus- trial Directory</u>
Rhode Island	1981-82	<u>Rhode Island Directory of Manufac- turers</u> , Rhode Island Directory of Economic Development

<u>State</u>	<u>Edition</u>	<u>Title and Publisher</u>
South Carolina	1983	<u>South Carolina 1983 Industrial Directory, South Carolina State Development Board</u>
South Dakota	1981-82	<u>South Dakota Manufacturers &amp; Processors Directory, Department of Economic and Tourism Development</u>
Tennessee	1982	<u>Tennessee Directory of Manufacturers, Tennessee Department of Economic and Community Development</u>
Texas	1983	<u>Directory of Texas Manufacturers, Bureau of Business Research, University of Texas, Austin</u>
Virginia	1981-82	<u>Virginia Industrial Directory, Virginia State Chamber of Commerce</u>
Washington	1982-83	<u>Washington Manufacturers Register, Times Mirror Press, Washington State Department of Commerce and Economic Development</u>
West Virginia	1980	<u>West Virginia Manufacturer's Directory, Governor's Office of Economic and Community Development Department</u>
Wisconsin	1983	<u>Classified Directory of Wisconsin Manufacturers, Wisconsin Association of Manufacturers and Commerce</u>

APPENDIX C  
POLLUTANT REMOVALS

## APPENDIX C

### POLLUTANT REMOVALS

This appendix explains how PM&F subcategory pollutant mass removals were calculated for the model treatment technologies. These removals apply to the BPT and BAT effluent limitations guidelines and to NSPS. Table C-1 contains the subcategory pollutant average concentrations and total estimated direct discharge masses for pollutants found in treatable concentrations for each subcategory.

#### CONTACT COOLING AND HEATING WATER SUBCATEGORY

##### BPT Effluent Limitations Guidelines Pollutant Mass Removals

No model treatment technology was selected as the basis for the BPT effluent limitations guidelines for this subcategory. BPT effluent limitations guidelines were established to ensure that plants continue the good housekeeping practices observed during the sampling episodes conducted during development of this regulation. They are based on the results of a statistical evaluation of the pollutant concentrations in contact cooling and heating process waters. There are only minimal costs associated with the final BPT effluent limitations guidelines and there are only minimal pollutant mass removals. See Section X for a discussion of the BPT effluent limitation guidelines for this subcategory.

##### BAT Effluent Limitations Guidelines Pollutant Mass Removals

BAT effluent limitations guidelines for this subcategory are equal to BPT effluent limitations guidelines except for the priority pollutant bis(2-ethylhexyl) phthalate. BAT effluent limitations guidelines are reserved for bis(2-ethylhexyl) phthalate. After further study, EPA will propose and promulgate BAT effluent limitations guidelines for this pollutant. The technology considered to treat bis(2-ethylhexyl) phthalate is activated carbon adsorption.

To estimate mass removals at BAT for bis(2-ethylhexyl) phthalate, the theoretical treatability limit for this pollutant presented in Table VII-9 was used. This limit was based on technology that includes activated carbon adsorption. Refer to Table C-2 for the influent and effluent concentrations and the estimated pollutant mass removals for the activated carbon process.

The influent and effluent concentrations listed on Table C-2 are from Tables C-1 and VII-9, respectively. The percentage removal (i.e., 89.8 percent) based on these concentrations was applied to

Table C-1

AVERAGE CONCENTRATIONS AND ESTIMATED MASSES FOR  
POLLUTANTS FOUND IN TREATABLE CONCENTRATIONS

Conventional Pollutants	Average Concentrations (mg/l)			Estimated Pollutant Mass for Direct Dischargers (kg/yr)		
	Contact Cooling and Heating Water	Cleaning Water	Finishing Water	Contact Cooling and Heating Water	Cleaning Water	Finishing Water
BOD <sub>5</sub>	*	90	*	*	25,600	*
Oil and Grease	*	48	*	*	14,200	*
TSS	*	714	*	*	199,000	3,630
pH Range	5.4-8.3	1.6-11.5	6.0-8.4	NA	NA	NA
<u>Nonconventional Pollutants</u>						
COD	*	115	*	*	32,000	*
TOC	*	634	*	*	177,000	*
Total Phenols	*	36	*	*	7,400	*
<u>Priority Pollutants</u>						
65. phenol	*	0.198	*	*	59	*
66. bis(2-ethylhexyl) phthalate	0.098	*	0.479	9,470	*	18
68. di-n-butyl phthalate	*	*	0.031	*	*	1
71. dimethyl phthalate	*	*	0.034	*	*	1
128. zinc	*	0.598	*	*	178	*

\*Average concentration is below treatability limit.

NA - Not applicable.

Table C-2

POLLUTANT REMOVAL - ACTIVATED CARBON ADSORPTION  
CONTACT COOLING AND HEATING WATER SUBCATEGORY

<u>Priority Pollutant</u>	<u>Influent Concentration (mg/l)</u>	<u>Effluent Concentration (mg/l)</u>	<u>Pollutant* % Removal</u>	<u>Pollutant Mass in Process Water (kg/yr)</u>	<u>Pollutant Mass Removal (kg/yr)</u>	<u>Pollutant Mass Remaining After Treatment (kg/yr)</u>
66. bis(2-ethylhexyl) phthalate	0.098	0.010	89.8	9,470	8,500	970

C-3

---

\*Pollutant percent removal is based on treatability limit (i.e., 0.010 mg/l) of bis(2-ethylhexyl) phthalate from U.S. EPA, Treatability of Organic Priority Pollutants - Part C - Their Estimated (30-Day Ave.) Treated Effluent Concentration - A Molecular Engineering Approach, Murray P. Strier, 11 July 1978.

the mass of bis(2-ethylhexyl) phthalate in contact cooling and heating waters listed in Table C-1 to estimate the pollutant mass removal.

#### NSPS Pollutant Mass Removals

NSPS are equal to BPT effluent limitations guidelines except for bis(2-ethylhexyl) phthalate. NSPS are reserved for bis(2-ethylhexyl) phthalate. After further study, EPA will propose and promulgate NSPS for this pollutant. The model treatment technology considered to treat bis(2-ethylhexyl) phthalate is pH adjustment (as needed) and activated carbon adsorption.

NSPS ensure that the good housekeeping practices observed during the sampling episodes conducted during development of this regulation will be employed at new sources. They are based on the results of a statistical evaluation of pollutant concentrations in contact cooling and heating waters. The pollutant concentrations used to calculate NSPS for this subcategory are presented in Table X-1. There are only minimal costs and there are minimal pollutant mass removals for NSPS for this subcategory.

#### CLEANING WATER SUBCATEGORY

##### BPT Effluent Limitations Guidelines Pollutant Mass Removals

The model treatment technology for the BPT effluent limitations guidelines for the cleaning water subcategory consists of equalization, pH adjustment, and a package activated sludge plant. Table C-3 presents the model treatment technology influent and effluent pollutant concentrations and the treatment technology percent removals. The sources of the pollutant percent removals are also listed in Table C-3.

The percent removal for the priority pollutant zinc is based on a technology that includes lime addition, settling, and filtration. The treatability limit for this technology is 0.230 mg/l.

There are no treatability data for zinc removal in activated sludge. However, literature does report a percent removal (99 percent). This percent removal, when applied to the influent concentration of 0.598 mg/l, gives an effluent concentration of 0.006 mg/l. Because this concentration is well below the treatability limit of the technology described above to treat metals (i.e., lime addition, settle, and filter), the effluent concentration for zinc was adjusted to 0.230 mg/l and the percent removal was correspondingly adjusted to 61.5 percent.

The percent removals in Table C-3 were applied to the cleaning water pollutant masses presented in Table C-1 to estimate the



Table C-3

POLLUTANT CONCENTRATIONS AND PERCENT REMOVALS  
BPT MODEL TREATMENT TECHNOLOGY  
CLEANING WATER SUBCATEGORY

<u>Conventional Pollutants</u>	<u>Influent Concentration (mg/l)</u>	<u>Effluent Concentration (mg/l)</u>	<u>Pollutant % Removal</u>	<u>% Removal Source</u>
BOD <sub>5</sub>	90	22	76	1
Oil and Grease	48	17	65	1
TSS	714	36	95	1
<u>Nonconventional Pollutants</u>				
COD	115	43	63	2
TOC	634	234	63	2
Total Phenols	36	14	60	2
<u>Priority Pollutants</u>				
65. phenol	0.198	0.050	74.7	3
128. zinc	0.598	0.230	61.5	4

1. Percent removals were calculated using the effluent concentration data transferred from the organic chemicals, plastics, and synthetic fibers category. Refer to Appendix D for details.
2. Percent removals are from U.S. EPA, Treatability Manual, Volume III, Technologies for Control/Removal of Pollutants, July 1980, EPA 600/8-80-842c.
3. Percent removal was calculated using the pollutant treatability limit from U.S. EPA, Treatability of Organic Priority Pollutants - Part C - Their Estimated (30-Day Ave.) Treated Effluent Concentration - A Molecular Engineering Approach, Murray P. Strier, 11 July 1978.
4. Percent removal was calculated from treatability limit for lime, settle, and filtration technology in the U.S. EPA Development Document for Effluent Guidelines and Standards for the Nonferrous Metals Manufacturing Point Source Category Phase II, July, 1984.

pollutant mass removals for the BPT effluent limitations guidelines. Table C-4 lists the estimated cleaning water subcategory pollutant mass removals at BPT and the mass of pollutants remaining after BPT.

#### BAT Effluent Limitations Guidelines Pollutant Mass Removals

For the cleaning water subcategory, BAT effluent limitations guidelines are equal to BPT effluent limitations guidelines. Consequently, the BAT pollutant mass removals are equal to BPT removals as listed in Table C-4.

#### NSPS Pollutant Mass Removals

Pollutant mass removals for direct dischargers at a new plant in the cleaning water subcategory were based on the performance of the model treatment technology that was selected at BPT. To estimate the pollutant masses discharged and the pollutant mass removals for NSPS, the pollutant masses at BPT were divided by the estimated number of direct discharging cleaning processes (i.e., 104 cleaning processes). This approach assumes that process waters at a new discharging source have the same pollutant influent and effluent concentrations as listed in Table C-3. Hence, the pollutant percent removals are the same. Refer to Table C-5 for the cleaning water subcategory new source pollutant masses, mass removals, and masses remaining after treatment.

EPA considered NSPS based on the performance of a package activated sludge plant followed by a filter. Refer to Table C-6 for the filter pollutant mass removals and for filter influent and effluent concentrations. The mass of pollutants in the influent to the filter and the filter influent pollutant concentrations are equal to the pollutant masses remaining after activated sludge treatment (see Table C-5) and the effluent concentrations presented on Table C-3, respectively.

#### FINISHING WATER SUBCATEGORY

##### BPT Effluent Limitations Guidelines Pollutant Mass Removals

The model treatment technology (i.e., settling) for BPT for this subcategory removes total suspended solids (TSS). Table C-7 presents the TSS influent and effluent concentrations, the TSS percent removal, the pollutant mass removals based on the percent removal, and the pollutant mass remaining after treatment. The TSS pollutant mass removal for the BPT effluent limitations guidelines is 2,520 kg/yr.

The TSS percent removal is 69.5 percent. This removal was calculated using the influent concentration of 95 mg/l and the median

Table C-4

BPT POLLUTANT MASS REMOVALS  
CLEANING WATER SUBCATEGORY

<u>Conventional Pollutants</u>	<u>Pollutant Mass in Process Waters (kg/yr)</u>	<u>Pollutant Mass Removal (kg/yr)</u>	<u>Pollutant Mass Remaining After Treatment (kg/yr)</u>
BOD <sub>5</sub>	25,600	19,300	6,300
Oil and Grease	14,200	9,170	5,030
TSS	<u>199,000</u>	<u>189,000</u>	<u>10,000</u>
TOTAL	238,800	217,470	21,330
<u>Nonconventional Pollutants</u>			
COD	32,000	20,200	11,800
TOC	177,000	112,000	65,000
Total Phenols	<u>7,400</u>	<u>4,440</u>	<u>3,040</u>
TOTAL	216,400	136,640	79,840
<u>Priority Pollutants</u>			
65. phenol	59	44.3	14.7
128. zinc	<u>178</u>	<u>110</u>	<u>68.0</u>
TOTAL	237	154.3	82.7

C-7

Table C-5

NSPS POLLUTANT MASS REMOVALS  
CLEANING WATER SUBCATEGORY

<u>Conventional Pollutant</u>	<u>New Source* Pollutant Mass (kg/yr)</u>	<u>Pollutant Mass Removal (kg/yr)</u>	<u>Pollutant Mass Remaining After Treatment (kg/yr)</u>
BOD <sub>5</sub>	246	186	60
Oil and Grease	137	88.2	48.8
TSS	<u>1,910</u>	<u>1,820</u>	<u>90</u>
TOTAL	2,293	2,094.2	198.8
<u>Nonconventional Pollutant</u>			
COD	308	194	114
TOC	1,700	1,080	620
Total Phenols	<u>71</u>	<u>42.7</u>	<u>28.3</u>
TOTAL	2,079	1,316.7	762.3
<u>Priority Pollutant</u>			
65. phenol	0.569	0.426	0.143
128. zinc	<u>1.71</u>	<u>1.06</u>	<u>0.650</u>
TOTAL	2.279	1.486	0.793

---

\*Obtained by dividing the pollutant mass listed in Table C-1 for the cleaning water subcategories by the estimated number of direct discharging cleaning water processes.

Table C-6

NSPS CONVENTIONAL POLLUTANT MASS REMOVALS FOR FILTRATION  
CLEANING WATER SUBCATEGORY

<u>Conventional Pollutants</u>	<u>Pollutant Mass Entering Filter from Package Activated Sludge Plant Unit (kg/yr)</u>	<u>Influent Concentration (mg/l)*</u>	<u>Percent Removal†</u>	<u>Effluent Concentration (mg/l)**</u>	<u>Filter Pollutant Mass Removal (kg/yr)</u>
BOD <sub>5</sub>	60	22	13.6	19	10
Oil and Grease	48.8	17	20.0	13.6	10
TSS	90	36	67	12	60
	<hr/>				<hr/>
TOTAL	198.8				80

C-9

\*Effluent from package activated sludge plant.

†Percent removals for BOD<sub>5</sub> and TSS were calculated using the median effluent concentrations for granular media filtration in the U.S. EPA, Treatability Manual, Volume III, Technologies for Control/Removal of Pollutants, July 1980, EPA 600/8-80-842c.

The oil and grease percent removal is the median percent removal for granular media filtration from the same source.

\*\*Calculated by multiplying the influent concentration times one minus the percent removal.

Table C-7

TOTAL SUSPENDED SOLIDS CONCENTRATIONS AND MASS REMOVALS  
FINISHING WATER SUBCATEGORY

TSS Influent Concentration	95 mg/l
TSS Effluent Concentration	29 mg/l
TSS Percent Removal*	69.5 %
TSS Mass	3,630 kg/yr
TSS Mass Removal	2,520 kg/yr
TSS Mass Remaining After Treatment	1,110 kg/yr

---

\*Percent removal is based on a median effluent concentration of 29 mg/l for settling technology. This is the median effluent concentration for settling technology in the U.S. EPA, Treatability Manual, Volume III, Technologies for Control/Removal of Pollutants, July 1980, EPA 600/8-80-842c.

effluent concentration of 29 mg/l from the U.S. EPA, Treatability Manual, Volume III, Technologies for Control/Removal of Pollutants, July 1980, EPA 600/8-80-842C for settling technology.

#### BAT Effluent Limitations Guidelines Pollutant Mass Removals

BAT effluent limitations guidelines for this subcategory are equal to BPT effluent limitations guidelines for all pollutants except for bis(2-ethylhexyl) phthalate, di-n-butyl phthalate, and dimethyl phthalate. Therefore, the estimated pollutant removals are the same as at BPT.

The three phthalates are reserved at BAT. The technology identified for treatment of the phthalates is settling followed by activated carbon adsorption. The activated carbon also removes additional quantities of TSS. The Agency estimated the amounts of the three phthalates that would be removed by the activated carbon process so that the technology could be evaluated economically. Refer to Table C-8 for the activated carbon adsorption process influent and effluent concentrations and the percent removals for the three phthalates.

The pollutant removals for the settling unit are equal to the removals at BPT and the TSS concentration of the process water entering the activated carbon adsorption process is equal to the TSS concentration in the settling unit effluent (i.e., 29 mg/l from Table C-7).

The pollutant mass removals for the finishing water subcategory are presented in Table C-9. These removals reflect the pollutant removals for the settling and activated carbon adsorption technologies. Also presented in Table C-9 are the finishing water subcategory pollutant masses remaining after treatment.

#### NSPS Pollutant Mass Removals

NSPS for this subcategory are equal to BPT effluent limitations guidelines except for bis(2-ethylhexyl) phthalate, di-n-butyl phthalate, and dimethyl phthalate. NSPS are reserved for the phthalates pending completion of a phthalate treatability study.

Estimated pollutant mass removals for direct discharge finishing water processes at a new plant were based on two model treatment technologies:

1. Settling (the selected technology for BPT and BAT) and
2. Settling followed by filtration.

To estimate the pollutant masses discharged and the pollutant mass removals for NSPS, the pollutant masses at BPT were divided

Table C-8

POLLUTANT CONCENTRATIONS AND PERCENT REMOVALS - ACTIVATED CARBON PROCESS  
FINISHING WATER SUBCATEGORY

<u>Conventional Pollutant</u>	<u>Influent Concentration from Settling Unit (mg/l)</u>	<u>Effluent Concentration from Activated Carbon Adsorption (mg/l)</u>	<u>Pollutant Percent Removal</u>	<u>Pollutant Percent Removal Source</u>
TSS	29	12	37.7	1
<u>Priority Pollutant</u>				
66. bis(2-ethylhexyl) phthalate	0.479	0.010	97.9	2
68. di-n-butyl phthalate	0.031	0.025	19.4	2
71. dimethyl phthalate	0.034	0.025	25.5	2

C-12

- 
1. Percent removal is based on the median effluent concentration for granular activated carbon technology presented in the U.S. EPA, Treatability Manual, Volume III, Technologies for Control/Removal of Pollutants, July 1980, EPA 600/8-80-842c.
  2. Percent removal is based on the pollutant treatability limit from U.S. EPA, Treatability of Organic Priority Pollutants - Part C - Their Estimated (30-Day Ave.) Treated Effluent Concentration - A Molecular Engineering Approach, Murray P. Strier, 11 July 1978.



Table C-9

BAT MASS REMOVALS  
FINISHING WATER SUBCATEGORY

	<u>Pollutant Mass Removal - Settling Unit (kg/yr)</u>	<u>Pollutant Mass Removal - Activated Carbon Adsorption (kg/yr)</u>	<u>Total Pollutant Mass Removal (kg/yr)</u>	<u>Pollutant Mass Remaining After Treatment (kg/yr)</u>
<u>Conventional Pollutant</u>				
TSS	2,520	418	2,938	692
<u>Priority Pollutant</u>				
66. bis(2-ethylhexyl) phthalate	0	17.9	17.9	0.1
67. di-n-butyl phthalate	0	0.227	0.227	0.773
71. dimethyl phthalate	<u>0</u>	<u>0.339</u>	<u>0.339</u>	<u>0.661</u>
TOTAL	0	18.5	18.5	1.53

C-13

by the estimated number of finishing processes (i.e., 10 finishing processes). This approach assumes that settling units at new discharging sources have the influent and effluent concentrations listed on Table C-7. Hence, the pollutant percent removal is the same for a settling unit at an existing source and at a new source. Table C-10 presents the mass removals for the settling technology for the finishing water subcategory.

EPA considered a model treatment technology for NSPS that included a settling unit followed by filtration. The filter influent and effluent concentrations and pollutant mass removals are presented in Table C-11. The filter influent TSS concentration and influent TSS mass are equal to the effluent TSS concentration and effluent TSS mass from the settling unit at BPT (see Table C-7).

Table C-10

NSPS MASS REMOVALS - SETTLING UNIT  
FINISHING WATER SUBCATEGORY

<u>Conventional Pollutant</u>	<u>New Source Pollutant Mass (kg/yr)*</u>	<u>Pollutant Mass Removal (kg/yr)**</u>	<u>Pollutant Mass Remaining After Treatment (kg/yr)</u>
TSS	363	252	111

---

\*Calculated by dividing the estimated subcategory pollutant mass for TSS by the estimated number of finishing processes.

\*\*For settling unit, based on percent removal presented in Table C-7.

Table C-11

NSPS MASS REMOVALS - FILTER  
FINISHING WATER SUBCATEGORY\*

TSS Influent Concentration	29 mg/l
TSS Effluent Concentration	12 mg/l
TSS Percent Removal**	59 percent
TSS Pollutant Mass	111 kg/yr
TSS Pollutant Mass Removal	65.5 kg/yr
TSS Mass Remaining After Treatment	45.5 kg/yr

---

\*For a filter following the settling unit.

\*\*Percent removal was calculated using the median effluent concentration for granular media filtration from U.S. EPA, Treatability Manual, Volume III, Technologies for Control/Removal of Pollutants, July 1980, EPA 600/8-80-842c.

APPENDIX D  
POLLUTANT CONCENTRATIONS USED TO  
CALCULATE THE BEST PRACTICABLE TECHNOLOGY (BPT)  
EFFLUENT LIMITATIONS GUIDELINES



UNITED STATES ENVIRONMENTAL PROTECTION AGENCY  
WASHINGTON, D.C. 20460

MEMORANDUM

SUBJECT: Calculation of Final Best Practicable Technology (BPT) Limitations Guidelines - Plastics Molding and Forming (PM&F)

FROM: R. Clifton Bailey, Statistician  
Analysis and Evaluation Division (WH-586) R. CB.

TO: Robert M. Southworth, PM&F Project Officer  
Industrial Technology Division (WH-552)

Purpose

This memorandum describes the development of the final BPT effluent limitations guidelines for the PM&F category. Pollutants regulated by the effluent limitations guidelines are biochemical oxygen demand (BOD<sub>5</sub>), oil and grease (O&G), and total suspended solids (TSS).

Background

Proposed BPT effluent limitations guidelines for the PM&F category were published in the Federal Register on February 15, 1984 (49 FR 5862). They control BOD<sub>5</sub>, O&G, and TSS in two subcategories. The limitations were based on concentration values that were transferred from the organic chemicals, plastics, and synthetic fibers (OCPSF) category and a production normalized flow calculated using information from two questionnaire surveys of the PM&F industry.

In response to comments, the Agency collected additional pollutant concentration data and calculated flow-weighted subcategory pollutant average concentrations using both the new sampling data and data from previous sampling episodes. Based on the flow-weighted average concentrations and information provided by commenters, the Agency determined that the PM&F category should be divided into three subcategories for the final PM&F regulation. They are:

- contact cooling and heating water subcategory;
- cleaning water subcategory; and
- finishing water subcategory.

This memorandum discusses the concentration values used to calculate the final BPT effluent limitations guidelines for each subcategory. These concentrations are multiplied by the average process water usage flow rate for a process to determine the mass of pollutants that can be discharged from a process.

The final BPT effluent limitations guidelines for the contact cooling and heating water subcategory are based on a statistical evaluation of the raw waste concentrations of BOD<sub>5</sub>, O&G, and TSS in contact cooling and heating water. This approach was used because the concentrations of BOD<sub>5</sub> in contact cooling and heating water are too low to support the operation of the proposed technology for BPT (i.e., the activated sludge process) and the Agency could not identify any other technology that would reduce those concentrations.

Final BPT effluent limitations guidelines for the cleaning water subcategory are based on the application of a package activated sludge plant with equalization and pH adjustment because the BOD<sub>5</sub> concentrations found in cleaning water are high enough to support biological treatment. However, no effluent data on activated sludge treatment of cleaning water only were available. Therefore, as at proposal, we compared the cleaning water untreated concentration data for BOD<sub>5</sub>, O&G, and TSS to data from those pollutants in wastewater generated at plastics manufacturing plants (PMP) in the organic chemicals, plastics, and synthetic fibers category (OCPSF) category. Results of that comparison are presented in this memorandum. Because wastewaters from cleaning processes at PM&F plants and wastewaters generated at PMP plants have similar BOD<sub>5</sub>, O&G, and TSS characteristics, it is appropriate to use activated sludge effluent data from those pollutants from the OCPSF category to determine effluent limitations guidelines for the PM&F cleaning water subcategory. Those data are presented in Appendices I and IIA to this memorandum.

For the finishing water subcategory, only TSS was present in treatable concentrations. For this reason, the BPT effluent limitations guidelines for this subcategory are based on the performance of a settling unit. Calculation of the maximum TSS concentration for any one-day and the maximum TSS concentration for the monthly average is discussed in this memorandum.

#### Data

##### Plastics Molding and Forming Process Sample Data

Samples of untreated process water were collected at 18 plastics molding and forming (PM&F) plants. BOD<sub>5</sub>, O&G, and TSS concentrations found in these samples are presented in Appendix I. Concentration data are presented for all three subcategories.

##### Plastics Manufacturing Plant Data

The BPT effluent limitations guidelines for the cleaning water subcategory are based on data from well-operated activated sludge processes at six plastics manufacturing plants (Nos. 9, 44, 45, 96, 111, 126). These well-operated treatment processes were identified through an engineering analysis of the performance data for those processes (see page 190 of the OCPSF technical development document-proposal for a summary). BOD<sub>5</sub> and TSS data were available from effluent samples collected at five of the six plants (Nos. 9, 44, 45, 111, 126). These data are presented in Appendix IIA.

Oil and grease (O&G) data were not available for the six well-operated wastewater treatment processes at the plastics manufacturing plants in the plastics only subcategory. Therefore, the PM&F effluent limitations guidelines for O&G were developed based on data from four plants (Nos. 3, 61, 124, 170) in the OCPSF data base that manufacture plastics (not necessarily plastics only plants) and that use activated sludge treatment. Those data are also presented in Appendix IIA.

Subsequent to proposal, we investigated using an expanded data base for the OCPSF category to see if the transferred effluent concentrations for the final regulation for the cleaning water subcategory should be based on the expanded data base. Although additional data had been collected for the OCPSF category, those data had neither been input to the data base nor been verified. Because the estimated date for completion of the expanded and verified data base was after the promulgation date for the final PM&F regulation, we used the same data base for the transfer of the activated sludge performance data for the final PM&F regulation that was used for the proposed regulation. This data base is the only verified data base available for the development of the PM&F regulation. Because it is a verified data base, the Agency believes it is appropriate to use that data base for the final PM&F Regulation.

The final BPT effluent limitations guidelines for the cleaning water subcategory were developed based on a log-normal distribution fit to the data. The goodness-of-fit of the log-normal model for O&G effluent data was examined using a graphical procedure described in Appendix III. As stated, the plots presented in Appendix IIC support the log-normal distribution as a model for the O&G effluent data. The graphical procedure used to demonstrate log-normality for O&G was the same procedure used to demonstrate log-normality for BOD<sub>5</sub> and TSS for the proposed OCPSF Regulation (see the technical development document for the proposed OCPSF regulation).

#### Performance Data Transfer - Cleaning Water Subcategory

Effluent concentration values for BOD<sub>5</sub>, O&G, and TSS for the cleaning water subcategory were developed in a manner similar to the effluent concentrations for those pollutants for the cleaning and finishing water subcategory at proposal. However, as discussed above, cleaning water processes and finishing water processes are in separate subcategories for the final regulation. Therefore, only PM&F cleaning water data were used for the comparison with the influent data from PMP in the OCPSF category. The revised data summary shown in Table 1 presents the plant average pollutant concentrations and log-variances for plants in the cleaning water subcategory and for the PMP plants used in the comparisons.

As at proposal, the statistical comparisons use a nonparametric test, the Mann-Whitney U/Wilcoxon Test, for independent samples. The revised comparisons (summarized in Table 2) were made separately for the plant means and plant log-variances. In these tests, neither the medians of the PM&F means nor the medians of the PM&F log-variances were found to be significantly greater than the corresponding PMP values. Consequently, the process water for the PM&F cleaning water subcategory is neither significantly greater nor more variable than the PMP process wastewater with respect to BOD<sub>5</sub>, TSS, and O&G concentrations.



Results of the statistical analysis also support the judgement that BOD<sub>5</sub>, TSS, and O&G effluent concentrations for activated sludge treatment of cleaning water should neither be greater nor more variable than effluent concentrations for those pollutants for an activated sludge process used to treat PMP process wastewater. We conclude, therefore, that the cleaning water concentration values shown in Table 6 of this memorandum can be met using the activated sludge process to treat PM&F wastewater.

TABLE 1

RANK COMPARISON OF MEAN POLLUTANT CONCENTRATIONS AND LOG-VARIANCES:  
 PLASTICS MOLDING AND FORMING (PM&F) PLANTS IN THE  
 CLEANING WATER SUBCATEGORY AND PLASTICS MANUFACTURING (PMP) PLANTS

POLLUTANT	PLANT TYPE	PLANT ID	SAMPLE SIZE	CONCENTRATION (mg/l):	
				MEAN	RANK
BOD <sub>5</sub>	PMF	I	8	5.33	1
	PMF	K	1	20.00	2
	PMF	B	3	48.67	3
	PMF	C	3	62.89	4
	PMP	9	23	84.74	5
	PMP	111	157	94.82	6
	PMF	F	6	200.97	7
	PMF	A	2	361.52	8
	PMP	45	148	381.14	9
	PMP	44	45	754.00	10
	PMF	H	2	777.50	11
	PMP	126	247	1087.47	12
O&G	PMF	A	2	4.000	3
	PMF	R	3	4.000	3
	PMF	D	2	4.000	3
	PMF	H	2	4.000	3
	PMF	K	1	4.000	3
	PMF	C	3	12.544	6
	PMP	61	234	17.393	7
	PMP	124	59	22.902	8
	PMP	3	157	41.139	9
	PMP	1	8	54.215	10
	PMP	170	203	79.277	11
	PMF	F	4	133.321	12
TSS	PMF	B	3	4.00	1
	PMF	K	1	6.00	2
	PMF	C	3	6.24	3
	PMF	H	2	7.25	4
	PMF	D	2	10.50	5
	PMP	9	23	27.25	6
	PMF	A	2	33.58	7
	PMP	111	157	42.84	8
	PMF	F	6	234.65	9
	PMP	45	148	304.32	10
	PMP	126	247	557.00	11
	PMP	44	45	3780.76	12
	PMF	I	8	7360.98	13

TABLE 1 (CONT'D)

POLLUTANT	PLANT TYPE	PLANT ID	SAMPLE SIZE	LOG-VARIANCE OF POLLUTANT CONCENTRATION:	
				MEAN	RANK
BOD <sub>5</sub>	PMF	K	1	.	.
	PMF	B	3	0.00387	1
	PMF	H	2	0.07376	2
	PMF	C	3	0.08329	3
	PMP	44	45	0.12644	4
	PMF	I	8	0.12665	5
	PMP	III	157	0.16975	6
	PMP	45	148	0.17588	7
	PMP	126	247	0.26334	8
	PMP	9	23	0.67626	9
	PMF	F	6	1.46832	10
	PMF	A	2	7.65196	11
O&G	PMF	K	1	.	.
	PMF	A	2	0.0000	2.5
	PMF	B	3	0.0000	2.5
	PMF	D	2	0.0000	2.5
	PMF	H	2	0.0000	2.5
	PMP	61	234	0.39147	5.0
	PMP	170	203	0.39781	6.0
	PMP	3	157	0.61599	7.0
	PMP	124	59	1.11618	8.0
	PMF	C	3	1.48186	9.0
	PMF	I	8	1.69834	10.0
	PMF	F	4	6.30013	11.0
	TSS	PMF	K	1	.
PMF		B	3	0.0000	1
PMF		D	2	0.11786	2
PMP		111	157	0.17684	3
PMF		H	2	0.46569	4
PMP		126	247	0.55877	5
PMP		9	23	0.56581	6
PMF		A	2	0.69461	7
PMF		C	3	0.82157	8
PMF		F	6	1.18541	9
PMP		45	148	1.47319	10
PMF		I	8	2.25857	11
PMP		44	45	2.61015	12

TABLE 2

RESULTS OF THE COMPARISON OF POLLUTANT CONCENTRATION IN  
PMP PROCESS WASTEWATER AND IN PROCESS WASTEWATER FOR  
THE PM&F CLEANING WATER SUBCATEGORY

Using Wilcoxon - T Test for 2 Independent Samples

One-Tailed Test  $H_0$ : PMF  $\leq$  PMP

$H_A$ : PMF  $>$  PMP

	POLLUTANT	NUMBER OF PLANTS		RANK MEAN		$T_x$ <sup>1</sup>	P	
		PMF	PMP	PMF	PMP			
PLANT MEANS RANKED	BOD <sub>5</sub>	7	5	5.14	8.40	42	.926	NS <sup>2</sup>
	O&G	8	4	5.38	8.75	35	.923	NS
	TSS	8	5	5.50	9.40	47	.953	NS
PLANT LOG- VARIANCES RANKED	BOD <sub>5</sub>	6	5	5.53	6.80	40	.959	NS
	O&G	7	4	5.71	6.50	26	.606	NS
	TSS	7	5	6.00	7.20	36	.681	NS

1 As defined by Gibbons, J.D., "Nonparametric Methods for Quantitative Analysis," Holt, Rinehard and Winston, 1976, p. 163.

2 NS - Not significant.

[This updates Table 3, page D-11, technical development document for the proposed PM&F regulations].

Statistical Evaluation of Raw Waste Concentrations - Contact Cooling and Heating Water Subcategory

The final BPT effluent limitations guidelines for BOD<sub>5</sub>, O&G, and TSS for the contact cooling and heating water subcategory are based on the raw waste concentrations of those pollutants in contact cooling and heating waters. This approach was used because commenters correctly pointed out that the concentrations of BOD<sub>5</sub> in contact cooling and heating water were too low to support the proposed activated sludge treatment. Furthermore, during the sampling episodes for this regulation, the Agency found that, for contact cooling and heating water, the industry employed good housekeeping practices such as keeping lubricating oil and other pollutants out of the process water. A regulation based on the raw waste concentrations ensures the continuation of the good housekeeping practices. An evaluation of the raw waste concentrations, shown in Table 3, was selected as the basis for the final BPT effluent limitations guidelines for this subcategory because the Agency could not identify a technology that would reduce the low BOD<sub>5</sub>, O&G and TSS concentrations in contact cooling and heating waters.

TABLE 3

PM&F DATA FOR THE CONTACT COOLING AND HEATING WATER SUBCATEGORY

PM&F DATA FOR CONTACT COOLING AND HEATING SUBCATEGORY STREAMS M-1 AND M-2 DELETED													
POLLUTANT	PROCESS	STREAM	DAY1	DAY2	DAY3	DF	LOGMEAN	SUM SQUARE	EIJ	VIJ	AVG FLOW		
dJDS	CALEND	H=2	5.0000	.	.	0	1.6094	0.0000	5.2985	3.4523	410.0000		
	CALEND	E=2	9.4000	8.9000	4.1000	2	1.9459	0.4307	7.4180	6.7667	3157.0000		
	CALEND	F=1	10.0000	8.0000	10.0000	2	2.2282	0.0332	9.8374	11.9005	530.0000		
	PROC POOLED SD = 0.3406 PROC EXPECTED VALUE = 7.518854							2	PROCESS WGTED VARIANCE = 7.099109				FLOW TOT = 4097.00
	CAST	P=1	2.3000	.	.	0	0.8329	0.0000	2.6362	2.1801	1090.0000		
	PROC POOLED SD = 0.5224 PROC EXPECTED VALUE = 2.636193								PROCESS WGTED VARIANCE = 2.180112				FLOW TOT = 1090.00
	EXTRUDE	R=1	5.0000	.	.	0	1.6094	0.0000	6.2978	23.2623	181.0000		
	EXTRUDE	D=3	.	.	.	.	.	0.0000	.	.	23.7000		
	EXTRUDE	E=3	7.6000	3.9000	0.5000	2	0.8987	4.0233	3.0939	5.6141	8040.0000		
	EXTRUDE	F=6	.	5.0000	3.0000	1	1.3540	0.1305	4.8763	13.9574	454.0000		
EXTRUDE	G=1	.	.	.	.	.	0.0000	.	.	313.5000			
EXTRUDE	K=2	5.0000	5.0000	5.0000	2	1.6094	0.0000	6.2978	23.2623	908.0000			
EXTRUDE	K=3	5.0000	5.0000	5.0000	2	1.6094	0.0000	6.2978	23.2623	454.0000			
EXTRUDE	K=4	5.0000	5.0000	5.0000	2	1.6094	0.0000	6.2978	23.2623	33154.0000			
EXTRUDE	N=2	10.0000	.	.	0	2.3026	0.0000	12.5957	93.0493	6.6000			
EXTRUDE	N=3	.	6.0000	.	0	1.7918	0.0000	7.5574	33.4978	213.0000			
EXTRUDE	U=1	.	.	.	.	.	0.0000	.	.	559.0000			
EXTRUDE	Q=2	.	.	.	.	.	0.0000	.	.	416.0000			
EXTRUDE	R=1	6.0000	.	.	0	1.7918	0.0000	7.5574	33.4978	881.0000			
EXTRUDE	R=2	6.0000	.	.	0	1.3863	0.0000	5.0383	14.8879	1240.0000			
PROC POOLED SD = 0.6794 PROC EXPECTED VALUE = 5.455343								PROCESS WGTED VARIANCE = 18.6277				FLOW TOT = 58003.80	
MOLD	B=4	5.0000	.	.	0	1.6094	0.0000	5.0111	0.1120	5.6000			
MOLD	C=1	96.9000	84.8000	90.9000	2	4.5079	0.0069	90.9343	36.8824	63.6000			
MOLD	J=1	5.0000	.	.	0	1.6094	0.0000	5.0111	0.1120	27260.0000			
MOLD	J=2	54.0000	.	.	0	3.9890	0.0000	54.1203	13.0642	2010.0000			
PROC POOLED SD = 0.0667 PROC EXPECTED VALUE = 4.561618								PROCESS WGTED VARIANCE = 1.07906				FLOW TOT = 29339.20	
THERM	F=2	8.0000	7.0000	7.0000	2	1.9904	0.0119	7.3404	0.3212	408.0000			
PROC POOLED SD = 0.0771 PROC EXPECTED VALUE = 7.340393								PROCESS WGTED VARIANCE = 0.3211999				FLOW TOT = 408.00	

PROCESS STREAMS M1 AND M2 DELETED BECAUSE CONTAMINATED.

TABLE 3

PM&F DATA FOR THE CONTACT COOLING AND HEATING WATER SUBCATEGORY

PM&F DATA FOR CONTACT COOLING AND HEATING SUBCATEGORY  
STREAMS M-1 AND M-2 DELETED

POLLUTANT	PROCESS	STREAM	DAY1	DAY2	DAY3	DF	LOGMEAN	SUM SQUARE	EIJ	VIJ	AVG FLOW	
U&G	CALEND	B-2	4.0000	.	.	0	1.3863	0.0000	4.8414	10.8985	410.0000	
	CALEND	E-2	16.8000	23.8000	11.8000	2	2.8197	0.2461	20.3003	191.6133	3157.0000	
	CALEND	F-1	1.0000	1.0000	4.0000	2	0.4621	1.2812	1.9213	1.7164	530.0000	
	PROC POOLED SD = 0.6179						FLOW TOT = 4097.00					
	PROC EXPECTED VALUE = 16.37574						PROCESS WGTED VARIANCE = 148.9629					
	CAST	P-1		3.0000	1.0000	.	1	0.5493	0.6035	2.3421	4.5444	1090.0000
	PROC POOLED SD = 0.7768						FLOW TOT = 1090.00					
	PROC EXPECTED VALUE = 2.342089						PROCESS WGTED VARIANCE = 4.544424					
	EXTRUDE	H-1		4.0000	.	.	0	1.3863	0.0000	4.0210	0.1698	181.0000
	EXTRUDE	D-3		4.0000	.	.	0	1.3863	0.0000	4.0210	0.1698	23.7000
	EXTRUDE	E-3		20.0000	27.8000	19.4000	2	3.0953	0.0796	22.2107	5.1819	8040.0000
	EXTRUDE	F-6		.	5.0000	4.0000	1	1.4979	0.0249	4.4956	0.2123	454.0000
EXTRUDE	G-1		4.0000	4.0000	.	1	1.3863	0.0000	4.0210	0.1698	313.5000	
EXTRUDE	K-2		4.0000	4.0000	4.0000	2	1.3863	0.0000	4.0210	0.1698	908.0000	
EXTRUDE	K-3		4.0000	4.0000	4.0000	2	1.3863	0.0000	4.0210	0.1698	454.0000	
EXTRUDE	K-4		4.0000	4.0000	4.0000	2	1.3863	0.0000	4.0210	0.1698	33154.0000	
EXTRUDE	N-2		5.0000	.	.	0	1.6094	0.0000	5.0262	0.2654	6.6000	
EXTRUDE	N-3		.	3.0000	.	0	1.0986	0.0000	3.0157	0.0955	213.0000	
EXTRUDE	O-1		5.0000	.	.	0	1.6094	0.0000	5.0262	0.2654	559.0000	
EXTRUDE	O-2		3.0000	.	.	0	1.0986	0.0000	3.0157	0.0955	416.0000	
EXTRUDE	P-1		6.0000	.	.	0	1.7918	0.0000	6.0314	0.3821	881.0000	
EXTRUDE	R-2		8.0000	.	.	0	2.0794	0.0000	8.0419	0.6793	12400.0000	
PROC POOLED SD = 0.1022						FLOW TOT = 58003.80						
PROC EXPECTED VALUE = 7.435005						PROCESS WGTED VARIANCE = 0.9771765						
MOLD	R-4		7.0000	.	.	0	1.9459	0.0000	8.1883	24.6966	5.6000	
MOLD	C-1		75.0000	24.5000	41.0000	2	3.7432	0.6272	49.4046	899.0445	63.6000	
MOLD	J-1		11.0000	.	.	0	2.3979	0.0000	12.8674	60.9854	27260.0000	
MOLD	J-2		61.0000	.	.	0	4.1109	0.0000	71.3554	1875.4264	2010.0000	
PROC POOLED SD = 0.5600						FLOW TOT = 29339.20						
PROC EXPECTED VALUE = 16.95263						PROCESS WGTED VARIANCE = 187.1007						
INERM	F-2		3.0000	.	5.0000	1	1.3540	0.1305	4.1341	2.3818	408.0000	
PROC POOLED SD = 0.3612						FLOW TOT = 408.00						
PROC EXPECTED VALUE = 4.133063						PROCESS WGTED VARIANCE = 2.361821						

PROCESS STREAMS M1 AND M2 DELETED BECAUSE CONTAMINATED.

TABLE 3

PM&F DATA FOR THE CONTACT COOLING AND HEATING WATER SUBCATEGORY

PM&F DATA FOR CONTACT COOLING AND HEATING SUBCATEGORY  
STREAMS M-1 AND M-2 DELETED

POLLUTANT	PROCESS	STREAM	DAY1	DAY2	DAY3	DF	LOGMEAN	SUM SQUARE	EIJ	VIJ	AVG FLOW
ISS	CALEND	B-2	4.0000	.	.	0	1.3863	0.0000	4.2584	2.4183	410.0000
	CALEND	E-2	3.0000	4.0000	2.0000	2	1.0594	0.2425	3.0708	1.2576	3157.0000
	CALEND	F-1	6.0000	3.0000	5.0000	2	1.4999	0.2582	4.7709	3.0355	530.0000
	PROC POOLED SD = 0.3538									FLOW TOT = 4097.00	
	PROC EXPECTED VALUE = 3.409589									PROCESS WGTED VARIANCE = 1.603742	
	CAST	P-1	2.0000	.	.	0	0.6931	0.0000	2.2591	1.4082	1090.0000
	PROC POOLED SD = 0.4936									FLOW TOT = 1090.00	
	PROC EXPECTED VALUE = 2.259137									PROCESS WGTED VARIANCE = 1.408235	
	EXTRUDE	B-1	4.0000	.	.	0	1.3863	0.0000	4.3778	3.7918	181.0000
	EXTRUDE	D-3	4.0000	.	.	0	1.3863	0.0000	4.3778	3.7918	23.7000
	EXTRUDE	E-3	4.0000	2.0000	3.0000	2	1.0594	0.2425	3.1570	1.9718	8040.0000
	EXTRUDE	F-6	.	1.0000	1.0000	1	0.0000	0.0000	1.0945	0.2370	454.0000
	EXTRUDE	G-1	22.0000	4.0000	.	1	2.2387	1.4531	10.2869	20.8546	313.5000
	EXTRUDE	K-2	6.0000	4.0000	4.0000	2	1.5214	0.1096	5.0114	4.9686	908.0000
	EXTRUDE	N-3	4.0000	4.0000	4.0000	2	1.3863	0.0000	4.3778	3.7918	454.0000
	EXTRUDE	K-4	4.0000	4.0000	4.0000	2	1.3863	0.0000	4.3778	3.7918	33154.0000
	EXTRUDE	N-2	1.0000	.	.	0	0.0000	0.0000	1.0945	0.2370	6.6000
	EXTRUDE	N-3	.	1.0000	.	0	0.0000	0.0000	1.0945	0.2370	213.0000
	EXTRUDE	O-1	1.0000	.	.	0	0.0000	0.0000	1.0945	0.2370	559.0000
	EXTRUDE	O-2	1.0000	.	.	0	0.0000	0.0000	1.0945	0.2370	416.0000
	EXTRUDE	R-1	1.0000	.	.	0	0.0000	0.0000	1.0945	0.2370	881.0000
	EXTRUDE	R-2	1.0000	.	.	0	0.0000	0.0000	1.0945	0.2370	12400.0000
	PROC POOLED SD = 0.4249									FLOW TOT = 58003.80	
	PROC EXPECTED VALUE = 3.405251									PROCESS WGTED VARIANCE = 2.735168	
	MOLD	H-4	4.0000	.	.	0	1.3863	0.0000	6.2105	54.4100	5.6000
	MOLD	C-1	104.0000	77.0000	18.0000	2	3.9595	1.7598	81.4080	9348.8067	63.6000
	MOLD	J-1	4.0000	.	.	0	1.3863	0.0000	6.2105	54.4100	27260.0000
	MOLD	J-2	36.0000	.	.	0	3.5835	0.0000	55.8947	4407.2072	2010.0000
	PROC POOLED SD = 0.9300									FLOW TOT = 29339.20	
	PROC EXPECTED VALUE = 9.777343									PROCESS WGTED VARIANCE = 372.7638	
	THERM	F-2	1.0000	2.0000	1.0000	2	0.2310	0.3203	1.3650	0.3236	408.0000
	PROC POOLED SD = 0.4002									FLOW TOT = 408.00	
	PROC EXPECTED VALUE = 1.364959									PROCESS WGTED VARIANCE = 0.3236007	

PROCESS STREAMS M1 AND M2 DELETED BECAUSE CONTAMINATED.



In basing the effluent limitations guidelines for BOD<sub>5</sub>, O&G, and TSS on the raw waste concentrations, the Agency developed effluent limitations that reflect the distribution of the process-types within the contact cooling and heating water subcategory. To do this, EPA used the PM&F data for the questionnaire surveys of the industry to estimate the relative number of processes by process-type within the contact cooling and heating water subcategory. The relative number of processes by process-type establishes a weight for each process-type which is the ratio of the number of processes of each type to the total number of processes in the survey data base for this subcategory. The weights are:

<u>Type of Process</u>	<u>Weight</u>
Calendering	0.0093
Casting	0.0140
Extrusion	0.8528
Molding	0.0724
Thermoforming	0.0211
Coating & Laminating	0.0304.

Consequently, the extrusion process type has the most weight because the largest number of processes for the contact cooling and heating water subcategory are extrusion processes. Within each process type, process streams were flow-weighted. As suggested by commenters, flow-weighting gives more weight to sampled process streams where water use was most intense. To obtain the flow-weight for a process stream within a process type, the average process stream flow (shown in Table 3) is normalized to sum to one within the process-type by dividing the process stream flow by the total stream flow within the process-type. For the limitations computation, each process stream is assigned a weight that is the product of the weight for the process type (shown above) and the individual flow-weight within the process-type. For example, to compute the weight for extrusion process stream, E3, of 0.1182 shown in Table IV.A.1 in Appendix IVA to this memorandum, we use the weight for the extrusion process-type of 0.8528 shown above, the average stream flow for E3 of 8040 l/hr. (Table 3) and the total flow for sampled extrusion processes of 58003.8 l/hr. (Table 3). The weight for process stream E3 is determined by:

$$\begin{aligned} & \text{Extrusion weight} \times \text{flow for E3} / \text{total flow for extrusion processes} \\ & = 0.8528 \times 8040 / 58003.8 \\ & = 0.8528 \times 0.1386 \\ & = 0.1182. \end{aligned}$$

The resulting process stream weights used in the limitations computations are displayed in Appendix IVA.

The 99th percentile daily limitations for the contact cooling and heating water subcategory were computed according to the methodology shown in Appendix IVA. This methodology was used to represent the subcategory process-types and the flow within the process-types. The daily 99th percentile concentration values for this subcategory are shown in Table 6.

### Calculation of TSS Concentration - Finishing Water Subcategory

The only pollutant regulated in the finishing water subcategory is TSS. Since proposal, the cleaning and finishing water subcategory was split into two subcategories. In response to comments, the Agency collected additional data and found that TSS was the only pollutant present in treatable concentrations in finishing water. The Agency based the TSS concentration values shown in Table 6 for the finishing water subcategory on settling technology. The TSS effluent concentrations were obtained by multiplying the estimated long-term average TSS effluent concentration for a settling unit by the daily and monthly variability factors described below.

#### Long-Term Average TSS Concentration

A long-term average TSS effluent concentration for a settling unit was calculated by multiplying the flow-weighted TSS concentration in finishing water (see Table 4) times a percent removal. The percent removal (i.e., 82 percent) was reported in the technical development document for the proposed PM&F regulation (pg. 194). It was obtained from the Treatability Manual, Volume III, Technologies for Control/Removal of Pollutants, July 1980, US EPA 600-8-80-042C. The estimated long-term TSS effluent concentration for the settling unit is:

$$91 \text{ mg/l} \times 0.18 = 16 \text{ mg/l.}$$

This concentration was used to calculate the maximum for one day and the maximum of monthly average concentrations for TSS because effluent data for the treatment of finishing water alone in a settling unit are not available.

#### Variability Factors

In the absence of effluent data for a settling unit that treats only finishing water, we considered the transfer of variability factors from other industrial categories. However, we were unable to find an appropriate data base for the transfer of those factors. For this reason, the variability factors used to calculate the final BPT effluent limitations guidelines for the finishing water subcategory are based on the variability of the raw TSS concentrations found in finishing waters.

The TSS daily variability factor, VF(1), for the finishing processes is the ratio of the flow-weighted average of the lognormal 99-th percentile estimates to the flow-weighted average of the lognormal expectations. In Appendix IVB, we shown that this ratio is

$$VF(1) = \exp(2.326\hat{\sigma} - \hat{\sigma}^2/2)$$

when a pooled estimate of  $\sigma$  is used. In this case  $\hat{\sigma} = 1.216$  and

$$VF(1) = 8.1.$$

The Central Limit Theorem was used to compute the 95th percentile variability factor for an average of 30 samples. For this approximation,

we used the flow weighted averages of the log-normal expectations and the variances to compute a subcategory expectation and variance. As shown in Appendix IVB, the monthly variability factor is

$$\begin{aligned}VF(30) &= 1 + 1.6449(V/30)^{.5}/E \\ &= 1 + 1.6449(1.89781 \times 10^5/30)^{.5}/102.4 \\ &= 2.3\end{aligned}$$

The maximum for one day and the maximum for average monthly pollutant concentrations used to calculate the final BPT effluent limitations guidelines for TSS for the finishing water subcategory are presented in Table 5.

#### BPT Effluent Limitations Guidelines

The concentrations used to calculate the final BPT effluent limitations guidelines for the PM&F category are presented in Table 6. These concentrations are multiplied by the average process water usage flow rate for a process to obtain the mass of a pollutant that can be discharged from that process.

TABLE 4

SUMMARY OF TSS CONCENTRATION DATA FOR THE FINISHING WATER SUBCATEGORY

Process	TSS (mg/l)*			Average (mg/l)	Log Mean ( $\mu_i$ )	Sum Squares ( $SS_i$ )	D.F. ( $\nu_i$ )**	Flow (l/hr.)
	Day 1	Day 2	Day 3					
I-4	63	289	1359	570.3	5.675	4.717	2	1220
N-1	4	1	-	2.5	0.693	0.961	1	2760
Q-1	12.55	6.3	-	9.4	2.185	0.237	1	4160

Pooled standard deviation 1.216

Flow-weighted:

Average Concentration 91 mg/l

Average log-normal expectation, E 102.4 mg/l

Average of log-normal  
99th percentiles 827.4 mg/l

Average log-normal variance, V  $1.89781 \times 10^5 (\text{mg/l})^2$

\* Duplicate concentrations for TSS samples were averaged.

\*\* Degrees of freedom equal to number of samples for the process minus one.

TABLE 5

EFFLUENT TSS CONCENTRATIONS - FINISHING WATER SUBCATEGORIES

	<u>Variability Factor</u>	<u>Long-Term Average</u>	<u>Concentration*</u>
Maximum for One Day	8.1	16 mg/l	130 mg/l
Maximum for Monthly Average	2.3	16 mg/l	37 mg/l

\* Long-term average multiplied by variability factor.

TABLE 6

CONCENTRATIONS USED TO CALCULATE THE FINAL BPT EFFLUENT LIMITATIONS GUIDELINES\*

<u>Subcategory</u>	<u>Pollutant</u>	<u>Maximum for One Day (mg/l)</u>	<u>Maximum for Monthly Averages (mg/l)</u>
Cooling & Heating Water	BOD5	26	-
	O&G	29	-
	TSS	19	-
Cleaning Water	BOD5	49	22
	O&G	71	17
	TSS	117	36
Finishing Water	TSS	130	37

\* These values are multiplied by the average process water usage flow rate for a process to obtain the mass of pollutants that can be discharged from the process.

APPENDIX I

BOD<sub>5</sub>, O&G and TSS Data for Untreated PM&F Process Water by Subcategory

P M & F DATA BASE - RAW VALUES

----- SUBCAT=CC & H -----

POLL	SAMPTYPE	PROCESS	STREAM	SOURCE	DETECTS	DAY1	DETECT1	FLOW1	DAY2	DETECT2	FLOW2	DAY3	DETECT3	FLOW3	DUPLICAT	DETECTD
BOD5	1	CALEND	B-2	5.0	<	5.0	<	410.0	0.0	NS	0.0	0.0	NS	0.0	0	NS
BOD5	1	CALEND	E-2	5.0		9.4		3157.0	8.9		3157.0	4.1		3157.0	0	NS
BOD5	1	CALEND	F-1	2.0		10.0		568.0	8.0		454.0	10.0		568.0	0	NS
BOD5	2	CAST	P-1	8.5		2.3		1090.0	0.0	NS	0.0	0.0	NS	0.0	0	NS
BOD5	1	EXTRUDE	B-1	5.0	<	5.0	<	181.0	0.0	NS	0.0	0.0	NS	0.0	0	NS
BOD5	1	EXTRUDE	D-3	0.0	NS	0.0	NS	23.7	0.0	NS	0.0	0.0	NS	0.0	0	NS
BOD5	1	EXTRUDE	E-3	5.0		7.6		8040.0	3.9		8040.0	0.5		8040.0	0	NS
BOD5	1	EXTRUDE	F-6	2.0		0.0	NS	0.0	5.0		454.0	3.0		454.0	0	NS
BOD5	3	EXTRUDE	G-1	5.0	<	0.0	NS	414.0	0.0	NS	213.0	0.0	NS	0.0	0	NS
BOD5	3	EXTRUDE	K-2	5.0	<	5.0	<	908.0	5.0	<	908.0	5.0	<	908.0	0	NS
BOD5	3	EXTRUDE	K-3	5.0	<	5.0	<	454.0	5.0	<	454.0	5.0	<	454.0	5	<
BOD5	3	EXTRUDE	K-4	5.0	<	5.0	<	37854.0	5.0	<	33217.0	5.0	<	28391.0	0	NS
BOD5	1	EXTRUDE	M-1	38.0		130.0		818.0	0.0	NS	0.0	0.0	NS	0.0	0	NS
BOD5	1	EXTRUDE	N-2	5.0		10.0		6.6	0.0	NS	0.0	0.0	NS	0.0	0	NS
BOD5	2	EXTRUDE	N-3	5.0		0.0	NS	0.0	6.0		213.0	0.0	NS	0.0	0	NS
BOD5	2	EXTRUDE	O-1	0.0	NA	0.0	NA	559.0	0.0	NS	0.0	0.0	NS	0.0	0	NS
BOD5	2	EXTRUDE	O-2	0.0	NA	0.0	NA	416.0	0.0	NS	0.0	0.0	NS	0.0	0	NS
BOD5	2	EXTRUDE	R-1	4.0		6.0		881.0	0.0	NS	0.0	0.0	NS	0.0	0	NS
BOD5	2	EXTRUDE	R-2	4.0		4.0		12400.0	0.0	NS	0.0	0.0	NS	0.0	0	NS
BOD5	1	MOLD	B-4	5.0	<	5.0	<	5.6	0.0	NS	0.0	0.0	NS	0.0	5	<
BOD5	1	MOLD	C-1	83.8		96.9		63.6	84.8		63.6	90.9		63.6	0	NS
BOD5	2	MOLD	J-1	5.0	<	5.0	<	27260.0	0.0	NS	0.0	0.0	NS	0.0	0	NS
BOD5	2	MOLD	J-2	5.0	<	56.0		2010.0	0.0	NS	0.0	0.0	NS	0.0	52	
BOD5	1	THERM	F-2	2.0		8.0		408.0	7.0		408.0	7.0		408.0	0	NS
BOD5	1	THERM	M-2	18.0		18.0		1140.0	0.0	NS	0.0	0.0	NS	0.0	0	NS
O&G	2	CALEND	B-2	4.0	<	4.0	<	410.0	0.0	NS	0.0	0.0	NS	0.0	0	NS
O&G	1	CALEND	E-2	19.6		16.8		3157.0	23.8		3157.0	11.8		3157.0	0	NS
O&G	1	CALEND	F-1	3.0		1.0		568.0	0.0		454.0	4.0		568.0	0	NS
O&G	1	CAST	P-1	3.0		3.0		1090.0	0.0	NS	0.0	0.0	NS	0.0	0	NS

D-19



P M & F DATA BASE - RAW VALUES

----- SUBCAT=CC & H -----

POLL	SAMPLES	PROCESS	STREAM	SOURCE	DET	DETECT	FLOW	DETECT	FLOW	DETECT	FLOW	DETECT	FLOW	DETECT	FLOW	
						ACTY 1		ACTY 2		ACTY 3		ACTY 3		ACTY 3		
O&G	2	EXTRUDE	B-1	4.000	<	4.000	<	181.0	0.00	NS	0.0	0.000	NS	0.0	0.000	NS
O&G	2	EXTRUDE	D-3	4.000	<	4.000	<	23.7	0.00	NS	0.0	0.000	NS	0.0	4.000	<
O&G	1	EXTRUDE	E-3	19.600		20.000		8040.0	27.80		8040.0	19.400		8040.0	0.000	NS
O&G	1	EXTRUDE	F-6	3.000		0.000	NS	0.0	5.00		454.0	4.000		454.0	0.000	NS
O&G	2	EXTRUDE	G-1	6.000		4.000	<	414.0	4.00		213.0	0.000	NS	0.0	0.000	NS
O&G	2	EXTRUDE	K-2	4.000	<	4.000	<	908.0	4.00	<	908.0	4.000	<	908.0	0.000	NS
O&G	2	EXTRUDE	K-3	4.000	<	4.000	<	454.0	4.00	<	454.0	4.000	<	454.0	4.000	<
O&G	2	EXTRUDE	K-4	4.000	<	4.000	<	37854.0	4.00	<	33217.0	4.000	<	28391.0	0.000	NS
O&G	1	EXTRUDE	M-1	1.000	<	31.000		818.0	0.00	NS	0.0	0.000	NS	0.0	0.000	NS
O&G	1	EXTRUDE	N-2	1.000	<	5.000		6.6	0.00	NS	0.0	0.000	NS	0.0	0.000	NS
O&G	1	EXTRUDE	N-3	1.000	<	0.000	NS	0.0	3.00		213.0	0.000	NS	0.0	0.000	NS
O&G	1	EXTRUDE	O-1	9.000		5.000		559.0	0.00	NS	0.0	0.000	NS	0.0	0.000	NS
O&G	1	EXTRUDE	O-2	9.000		3.000		416.0	0.00	NS	0.0	0.000	NS	0.0	0.000	NS
O&G	1	EXTRUDE	R-1	7.000		6.000		881.0	0.00	NS	0.0	0.000	NS	0.0	0.000	NS
O&G	1	EXTRUDE	R-2	7.000		8.000		12400.0	0.00	NS	0.0	0.000	NS	0.0	0.000	NS
O&G	2	MOLD	B-4	4.000	<	4.000		5.6	0.00	NS	0.0	0.000	NS	0.0	10.000	
O&G	1	MOLD	C-1	17.000		75.000		63.6	24.50		63.6	41.000		63.6	0.000	NS
O&G	2	MOLD	J-1	4.000	<	11.000		27260.0	0.00	NS	0.0	0.000	NS	0.0	0.000	NS
O&G	2	MOLD	J-2	4.000	<	73.000		2010.0	0.00	NS	0.0	0.000	NS	0.0	49.000	
O&G	1	THERM	F-2	3.000		3.000		408.0	0.00		408.0	5.000		408.0	0.000	NS
O&G	1	THERM	M-2	74.000		29.000		1140.0	0.00	NS	0.0	0.000	NS	0.0	0.000	NS

P M & F DATA BASE - RAW VALUES

SUBCAT=CC & H

POLL	SAMPTYPE	PROCESS	STREAM	SOURCE	DETECTS	DAY1	DETECT1	FLOW1	DAY2	DETECT2	FLOW2	DAY3	DETECT3	FLOW3	DUPLICAT	DETECTD
TSS	1	CALEND	B-2	4.000	<	4.000	<	410.0	0.0	NS	0.0	0.0	NS	0.0	0	NS
TSS	3	CALEND	E-2	1.000	<	3.000	<	3157.0	4.0		3157.0	2.0		3157.0	0	NS
TSS	3	CALEND	F-1	2.000	<	6.000	<	568.0	3.0		454.0	5.0		568.0	0	NS
TSS	2	CAST	P-1	1.000	<	2.000	<	1090.0	0.0	NS	0.0	0.0	NS	0.0	0	NS
TSS	1	EXTRUDE	B-1	4.000	<	4.000	<	181.0	0.0	NS	0.0	0.0	NS	0.0	0	NS
TSS	1	EXTRUDE	D-3	4.000	<	4.000	<	23.7	0.0	NS	0.0	0.0	NS	0.0	4	<
TSS	3	EXTRUDE	E-3	1.000	<	4.000	<	8040.0	2.0		8040.0	3.0		8040.0	0	NS
TSS	3	EXTRUDE	F-6	2.000	<	0.000	NS	0.0	1.0		454.0	1.0	<	454.0	0	NS
TSS	3	EXTRUDE	G-1	16.000	<	22.000	<	414.0	4.0		213.0	0.0	NS	0.0	0	NS
TSS	3	EXTRUDE	K-2	4.000	<	6.000	<	908.0	4.0		908.0	4.0	<	908.0	0	NS
TSS	3	EXTRUDE	K-3	4.000	<	4.000	<	454.0	4.0	<	454.0	4.0	<	454.0	4	<
TSS	3	EXTRUDE	K-4	4.000	<	4.000	<	37854.0	4.0	<	33217.0	4.0	<	28391.0	0	NS
TSS	1	EXTRUDE	M-1	1.000	<	5.000	<	818.0	0.0	NS	0.0	0.0	NS	0.0	0	NS
TSS	1	EXTRUDE	N-2	3.000	<	1.000	<	6.6	0.0	NS	0.0	0.0	NS	0.0	0	NS
TSS	2	EXTRUDE	N-3	3.000	<	0.000	NS	0.0	1.0	<	213.0	0.0	NS	0.0	0	NS
TSS	2	EXTRUDE	O-1	1.000	<	1.000	<	559.0	0.0	NS	0.0	0.0	NS	0.0	0	NS
TSS	2	EXTRUDE	O-2	1.000	<	1.000	<	416.0	0.0	NS	0.0	0.0	NS	0.0	0	NS
TSS	2	EXTRUDE	R-1	1.000	<	1.000	<	881.0	0.0	NS	0.0	0.0	NS	0.0	0	NS
TSS	2	EXTRUDE	R-2	1.000	<	1.000	<	12400.0	0.0	NS	0.0	0.0	NS	0.0	0	NS
TSS	1	MOLD	B-4	4.000	<	4.000	<	5.6	0.0	NS	0.0	0.0	NS	0.0	4	<
TSS	3	MOLD	C-1	0.000	<	104.000	<	63.6	77.0		63.6	18.0		63.6	0	NS
TSS	2	MOLD	J-1	4.000	<	4.000	<	27260.0	0.0	NS	0.0	0.0	NS	0.0	0	NS
TSS	2	MOLD	J-2	4.000	<	36.000	<	2010.0	0.0	NS	0.0	0.0	NS	0.0	38	
TSS	3	THERM	F-2	2.000	<	1.000	<	408.0	2.0		408.0	1.0		408.0	0	NS
TSS	1	THERM	M-2	9.000	<	4.000	<	1140.0	0.0	NS	0.0	0.0	NS	0.0	0	NS

P M & F DATA BASE - RAW VALUES

SUBCAT=CLEAN

POLL	SAMPLE	PROCESS	STREAM	SOURCE	DETECTS	DAY 1	DETECT 1	FLOW 1	DAY 2	DETECT 2	FLOW 2	DAY 3	DETECT 3	FLOW 3	DUPLICATE	DETECT D
BOD5	1	CLEAN	A-1	5.00	<	9.00		37.9	0.00	NS	0.0	0.00	NS	0	0.00	NS
BOD5	1	CLEAN	A-2	5.00	<	450.00		151.0	0.00	NS	0.0	0.00	NS	0	0.00	NS
BOD5	1	CLEAN	B-3	5.00	<	48.00		4540.0	46.00		4540.0	52.00		4540	0.00	NS
BOD5	1	CLEAN	C-2	83.80		84.80		200.0	48.50		649.0	72.70		505	0.00	NS
BOD5	0	CLEAN	D-1	0.00	NS	0.00	NS	56.8	0.00	NS	0.0	0.00	NS	0	0.00	NS
BOD5	0	CLEAN	D-2	0.00	NS	0.00	NS	56.8	0.00	NS	0.0	0.00	NS	0	0.00	NS
BOD5	1	CLEAN	F-3	2.00		510.00		780.0	247.00		519.0	52.00		1110	0.00	NS
BOD5	1	CLEAN	F-4	2.00		198.00		4540.0	34.00		397.0	26.00		113	0.00	NS
BOD5	1	CLEAN	H-1	5.00	<	1000.00		15.1	630.00		15.1	0.00	NS	0	850.00	
BOD5	1	CLEAN	I-1	1.70		6.30		228.0	6.10		355.0	6.20		344	0.00	NS
BOD5	1	CLEAN	I-2	1.70		2.60		178.0	5.95		77.6	5.65		234	0.00	NS
BOD5	1	CLEAN	I-3	1.70		3.20		405.0	0.00	NS	0.0	6.60		344	0.00	NS
BOD5	2	CLEAN	K-1	5.00	<	20.00		115.0	0.00	NS	0.0	0.00	NS	0	0.00	NS
O&G	2	CLEAN	A-1	4.00	<	4.00	<	37.9	0.00	NS	0.0	0.00	NS	0	0.00	NS
O&G	2	CLEAN	A-2	4.00	<	4.00	<	151.0	0.00	NS	0.0	0.00	NS	0	0.00	NS
O&G	2	CLEAN	B-3	4.00	<	4.00	<	4540.0	4.00	<	4540.0	4.00	<	4540	0.00	NS
O&G	1	CLEAN	C-2	17.00		31.00		200.0	0.00		649.0	17.50		505	0.00	NS
O&G	2	CLEAN	D-1	4.00	<	4.00	<	56.8	0.00	NS	0.0	0.00	NS	0	0.00	NS
O&G	2	CLEAN	D-2	4.00	<	4.00	<	56.8	0.00	NS	0.0	0.00	NS	0	0.00	NS
O&G	1	CLEAN	F-3	3.00		548.00		780.0	684.00		519.0	0.00	NS	1110	0.00	NS
O&G	1	CLEAN	F-4	3.00		3.00		4540.0	89.00		397.0	0.00	NS	113	0.00	NS
O&G	2	CLEAN	H-1	4.00	<	4.00	<	15.1	4.00	<	15.1	0.00	NS	0	4.00	<
O&G	1	CLEAN	I-1	0.00		18.00		228.0	7.00		355.0	44.70		344	0.00	NS
O&G	1	CLEAN	I-2	0.00		234.50		178.0	21.80		77.6	174.10		234	0.00	NS
O&G	1	CLEAN	I-3	0.00		21.20		405.0	0.00	NS	0.0	7.80		344	0.00	NS
O&G	2	CLEAN	K-1	4.00	<	4.00	<	115.0	0.00	NS	0.0	0.00	NS	0	0.00	NS

D-22

P M & F DATA BASE - RAW VALUES

SUBCAT=CLEAN

POLL	SAMP TYPE	PROCESS	STREAM	SOURCE	DETECTS	DETECT 1			DETECT 2			DETECT 3			DUPLICATE	DETECT D
						DAY	1	FLD	DAY	2	FLD	DAY	3	FLD		
TSS	1	CLEAN	A-1	8.000		12.0		37.9	0.0	NS	0.0	0.0	NS	0	0.00	NS
TSS	1	CLEAN	A-2	8.000		39.0		151.0	0.0	NS	0.0	0.0	NS	0	0.00	NS
TSS	3	CLEAN	B-3	4.000	<	4.0	<	4540.0	4.0	<	4540.0	4.0	<	4540	0.00	NS
TSS	3	CLEAN	C-2	0.000		8.0		200.0	2.0		649.0	11.0		505	0.00	NS
TSS	1	CLEAN	D-1	4.000	<	13.0		56.8	0.0	NS	0.0	0.0	NS	0	0.00	NS
TSS	1	CLEAN	D-2	4.000	<	8.0		56.8	0.0	NS	0.0	0.0	NS	0	0.00	NS
TSS	3	CLEAN	F-3	2.000		198.0		780.0	274.0		519.0	466.0		1110	0.00	NS
TSS	3	CLEAN	F-4	2.000		90.0		4540.0	1310.0		397.0	68.0		113	0.00	NS
TSS	1	CLEAN	H-1	5.000		11.0		15.1	4.0	<	15.1	0.0	NS	0	10.00	
TSS	3	CLEAN	I-1	56.000		16363.0		228.0	11738.0		355.0	12597.0		344	0.00	NS
TSS	1	CLEAN	I-2	56.000		5825.0		178.0	244.0		77.6	1039.0		234	0.00	NS
TSS	1	CLEAN	I-3	56.000		1136.0		405.0	0.0	NS	0.0	5671.0		344	0.00	NS
TSS	2	CLEAN	K-1	4.000	<	6.0		115.0	0.0	NS	0.0	0.0	NS	0	0.00	NS

P M & F DATA BASE - RAW VALUES

----- SUBCAT=FINISH -----

POLL	SAMPTYPE	PROCESS	STREAM	SOURCE	DETECTS	DAY1	DETECT1	FLOW1	DAY2	DETECT2	FLOW2	DAY3	DETECT3	FLOW3	DUPLICAT	DETECTD
TSS	3	FINISH	I-4	33.0000		63.0000		1100	289.000		1140	1359.00		1420	0.0000	NS
TSS	3	FINISH	N-1	3.0000		7.0000		2880	1.000	<	2640	0.00	NS	0	1.0000	<
TSS	3	FINISH	Q-1	1.0000	<	9.1000		4160	6.300		4160	0.00	NS	0	16.0000	

## APPENDIX II

### Plastics Manufacturing Plants (PMP)

- A) PM&P Data: Influent and Effluent  
BOD<sub>5</sub>, O&G and TSS
- B) Summary Statistics for PMP Data
- C) Probit Plots for PMP Oil and  
Grease Data

APPENDIX IIA

PMP Data: Influent and Effluent BOD, O&G and TSS

LISTING OF PMP DATA BY POLLUTANT

POLL=BOD

OBS	PLANT	DATE	FLOW(MGD)	INFLUENT (PPM)	EFFLUENT (PPM)
1	9	101575	0.05	56	4
2	9	102275	0.05	70	5
3	9	111275	0.25	194	5
4	9	111975	0.07	54	1
5	9	121075	0.06	49	5
6	9	121775	0.06	32	5
7	9	010776	0.10	71	14
8	9	011476	.	120	5
9	9	021176	0.07	59	4
10	9	021876	.	226	2
11	9	031076	0.08	52	7
12	9	032576	.	.	7
13	9	041476	0.06	20	4
14	9	042176	.	108	8
15	9	051276	0.09	192	4
16	9	051976	.	17	8
17	9	060976	0.13	56	3
18	9	061676	0.13	54	6
19	9	072176	0.07	92	10
20	9	072876	0.09	80	7
21	9	080476	0.05	9	4
22	9	081876	0.06	132	10
23	9	090876	0.02	27	4
24	9	092276	.	179	5
25	44	060179	0.92	.	13
26	44	060479	0.88	.	6
27	44	060579	1.00	.	14
28	44	060679	0.80	.	15
29	44	060779	0.38	.	9
30	44	060879	0.83	.	16
31	44	061179	0.94	.	4
32	44	061279	0.79	.	5
33	44	061379	0.80	.	18
34	44	061479	1.13	.	18
35	44	061579	0.45	.	17
36	44	061879	0.57	.	1
37	44	061979	0.71	.	16
38	44	062079	0.39	.	17
39	44	062179	0.57	.	16
40	44	062279	0.36	.	14
41	44	062579	0.83	.	3
42	44	062679	0.68	.	13
43	44	062779	0.60	.	12
44	44	062879	0.62	.	10
45	44	062979	0.80	.	14
46	44	070279	0.81	.	2
47	44	070379	0.63	1000	5
48	44	070479	0.51	.	10
49	44	070579	0.25	.	10
50	44	070679	0.34	.	13
51	44	070979	0.79	.	8
52	44	071079	0.71	.	17
53	44	071179	0.73	.	8
54	44	071279	0.74	.	27



LISTING OF PMP DATA BY POLLUTANT

POLL=BOD

OBS	PLANT	DATE	FLOW(MGD)	INFLUENT (PPM)	EFFLUENT (PPM)
55	44	071379	0.80	.	14
56	44	071679	0.74	.	7
57	44	071779	0.79	.	8
58	44	071879	0.73	.	3
59	44	071979	0.73	.	15
60	44	072079	0.90	.	22
61	44	072379	0.54	.	5
62	44	072479	0.63	.	4
63	44	072579	0.73	.	15
64	44	072679	0.81	.	29
65	44	072779	0.71	.	22
66	44	073079	0.79	.	4
67	44	073179	0.43	.	11
68	44	080179	0.38	769	4
69	44	080279	0.46	.	7
70	44	080379	0.66	.	4
71	44	080679	0.74	.	5
72	44	080779	0.26	.	6
73	44	080879	0.56	1090	13
74	44	080979	0.73	.	9
75	44	081079	0.75	.	9
76	44	081379	0.74	.	7
77	44	081479	0.65	.	24
78	44	081579	0.79	1689	16
79	44	081679	0.73	.	20
80	44	081779	0.84	.	21
81	44	082079	0.83	.	10
82	44	082179	0.85	.	22
83	44	082279	0.73	1311	13
84	44	082379	0.67	.	31
85	44	082479	0.94	.	21
86	44	082779	0.96	.	3
87	44	082879	0.96	.	15
88	44	082979	0.91	700	13
89	44	083079	0.90	.	14
90	44	083179	.	.	9
91	44	090379	0.19	622	7
92	44	090479	0.34	.	5
93	44	090579	0.28	.	7
94	44	090679	0.38	.	8
95	44	090779	0.33	.	9
96	44	091079	0.62	.	11
97	44	091179	0.70	.	13
98	44	091279	0.67	.	9
99	44	091379	0.72	.	13
100	44	091479	0.85	.	13
101	44	091779	0.88	304	11
102	44	091879	0.88	.	13
103	44	091979	0.46	648	5
104	44	092079	0.33	.	4
105	44	092179	0.43	.	4
106	44	092479	0.31	225	5
107	44	092579	0.27	.	3
108	44	092679	0.37	.	3

D-28

LISTING OF PMP DATA BY POLLUTANT

POLL=BOD

OBS	PLANT	DATE	FLOW(MGD)	INFLUENT (PPM)	EFFLUENT (PPM)
109	44	092779	0.36	.	8
110	44	092879	0.35	.	9
111	44	100179	0.55	794	7
112	44	100279	0.57	.	8
113	44	100379	0.45	.	8
114	44	100479	0.36	.	6
115	44	100579	0.57	.	7
116	44	100879	0.96	806	4
117	44	100979	0.46	.	7
118	44	101079	0.64	.	9
119	44	101179	0.70	.	6
120	44	101279	0.68	.	6
121	44	101579	0.23	500	3
122	44	101679	0.67	.	8
123	44	101779	0.67	.	6
124	44	101879	0.60	.	5
125	44	101979	0.62	.	8
126	44	102279	0.60	369	3
127	44	102379	0.68	.	7
128	44	102479	0.69	.	6
129	44	102579	0.60	.	11
130	44	102679	0.59	.	8
131	44	102979	0.60	.	10
132	44	103079	0.67	.	17
133	44	103179	0.10	.	18
134	44	110179	0.52	1019	11
135	44	110279	0.72	.	11
136	44	110579	0.58	.	4
137	44	110679	0.59	.	7
138	44	110779	0.68	.	9
139	44	110879	0.68	816	10
140	44	110979	0.53	.	9
141	44	111279	0.66	.	11
142	44	111379	0.98	.	9
143	44	111479	0.65	.	11
144	44	111579	0.51	781	8
145	44	111679	0.51	.	11
146	44	111979	0.72	.	15
147	44	112079	0.78	.	15
148	44	112179	0.78	.	12
149	44	112279	0.35	906	14
150	44	112379	0.11	.	5
151	44	112679	0.58	.	5
152	44	112779	0.78	.	5
153	44	112879	0.69	.	5
154	44	112979	0.70	925	13
155	44	113079	0.78	.	6
156	44	120379	0.74	654	1
157	44	120479	0.55	.	7
158	44	120579	0.60	.	6
159	44	120679	0.66	.	4
160	44	120779	0.70	.	4
161	44	121079	1.12	721	5
162	44	121179	0.63	.	14

LISTING OF PMP DATA BY POLLUTANT

FOU = BOD

OBS	PLANT	DATE	FLOW(MGD)	INFLUENT (PPM)	EFFLUENT(PPM)
163	44	121279	0.79	.	4
164	44	121379	0.60	.	3
165	44	121479	0.63	.	5
166	44	121779	0.61	956	3
167	44	121879	0.58	.	4
168	44	121979	0.57	.	5
169	44	122079	0.52	.	5
170	44	122179	0.65	.	8
171	44	122479	0.36	1020	9
172	44	122579	0.47	.	14
173	44	122679	0.41	.	10
174	44	122779	0.30	.	7
175	44	122879	0.41	.	8
176	44	123179	0.63	.	6
177	44	010180	0.53	697	15
178	44	010280	0.15	.	20
179	44	010380	0.59	.	10
180	44	010480	0.50	.	13
181	44	010780	0.67	587	14
182	44	010880	0.63	1157	7
183	44	010980	0.65	.	5
184	44	011080	0.47	.	6
185	44	011180	0.69	.	8
186	44	011480	0.32	.	3
187	44	011580	0.60	722	13
188	44	011680	0.76	.	7
189	44	011780	0.74	.	10
190	44	011880	0.56	.	11
191	44	012180	0.62	.	3
192	44	012280	0.60	1010	10
193	44	012380	0.85	.	14
194	44	012480	0.53	.	12
195	44	012580	0.61	.	11
196	44	012880	0.56	.	5
197	44	012980	0.48	.	10
198	44	013080	0.48	.	9
199	44	013180	0.54	.	6
200	44	020180	0.67	611	5
201	44	020480	0.87	.	12
202	44	020580	0.55	.	8
203	44	020680	0.49	.	6
204	44	020780	0.46	.	5
205	44	020880	0.94	802	10
206	44	021180	0.69	.	5
207	44	021280	0.25	.	6
208	44	021380	0.51	.	10
209	44	021480	0.63	.	7
210	44	021580	0.57	855	8
211	44	021880	0.47	.	10
212	44	021980	0.65	.	14
213	44	022080	0.69	.	13
214	44	022180	0.74	.	13
215	44	022280	0.71	590	15
216	44	022580	0.89	.	6

## LISTING OF FMP DATA BY POLLUTANT

5

POLL=BOD

OBS	PLANT	DATE	FLOW(MGD)	INFLUENT (PPM)	EFFLUENT (PPM)
217	44	022680	0.85	.	9
218	44	022780	0.78	.	6
219	44	022880	0.58	.	3
220	44	022980	0.46	.	3
221	44	030380	0.44	710	9
222	44	030480	0.50	.	9
223	44	030580	0.57	.	5
224	44	030680	0.61	.	12
225	44	030780	1.04	.	7
226	44	031080	0.79	666	10
227	44	031180	0.64	.	8
228	44	031280	0.63	.	8
229	44	031380	0.82	.	9
230	44	031480	0.80	.	8
231	44	031780	0.91	599	8
232	44	031880	0.86	.	7
233	44	031980	0.82	.	3
234	44	032080	1.00	.	8
235	44	032180	0.97	.	8
236	44	032480	0.62	618	4
237	44	032580	0.78	.	3
238	44	032680	0.75	.	3
239	44	032780	0.71	.	3
240	44	032880	0.82	.	3
241	44	033180	0.73	.	3
242	44	040180	0.81	552	12
243	44	040280	0.82	.	3
244	44	040380	0.56	.	7
245	44	040480	0.21	.	10
246	44	040780	0.64	.	4
247	44	040880	0.90	736	3
248	44	040980	0.71	.	3
249	44	041080	0.92	.	3
250	44	041180	0.93	.	3
251	44	041480	0.95	.	3
252	44	041580	0.74	583	3
253	44	041680	0.74	.	7
254	44	041780	0.87	.	6
255	44	041880	0.86	.	3
256	44	042180	0.76	.	4
257	44	042280	0.55	549	5
258	44	042380	0.73	.	3
259	44	042480	0.73	.	3
260	44	042580	0.59	.	3
261	44	042880	0.62	.	4
262	44	042980	0.60	.	6
263	44	043080	0.62	.	7
264	44	050180	0.70	675	4
265	44	050280	0.67	.	4
266	44	050580	0.87	.	5
267	44	050680	0.96	.	10
268	44	050780	0.87	.	14
269	44	050880	0.32	911	13
270	44	050980	0.60	.	15

D-31

## LISTING OF PMP DATA BY POLLUTANT

6

----- POLI=BOD -----

OBS	PLANT	DATE	FLOW (MGD)	INFLUENT (PPM)	EFFLUENT (PPM)
271	44	051280	0.72	.	8
272	44	051380	0.80	.	12
273	44	051480	0.64	.	11
274	44	051580	0.35	555	9
275	44	051680	0.60	.	9
276	44	051980	0.50	.	5
277	44	052080	0.25	.	8
278	44	052180	0.11	.	9
279	44	052280	0.57	576	11
280	44	052380	0.44	.	11
281	44	052680	0.30	.	7
282	44	052780	0.48	.	6
283	44	052880	0.54	.	7
284	44	052980	.	544	10
285	44	053080	.	.	5
286	45	062879	3.31	350	1
287	45	070379	1.73	360	2
289	45	070479	1.46	308	2
289	45	070579	2.13	175	2
290	45	071079	2.35	368	11
291	45	071179	2.84	325	7
292	45	071279	2.95	288	5
293	45	071779	2.07	278	2
294	45	071879	2.43	280	2
295	45	071979	2.70	338	2
296	45	072479	3.49	310	5
297	45	072579	3.17	375	6
298	45	072679	3.26	393	5
299	45	073179	3.12	.	1
300	45	080179	3.03	165	2
301	45	080279	2.87	170	3
302	45	080779	2.94	245	1
303	45	080879	3.04	205	1
304	45	080979	2.48	283	2
305	45	081479	2.71	.	1
306	45	081579	2.56	358	5
307	45	081679	2.82	458	1
308	45	082179	3.41	315	4
309	45	082279	3.62	325	3
310	45	082379	3.56	403	2
311	45	082879	2.63	325	3
312	45	082979	2.50	308	2
313	45	083079	3.40	372	1
314	45	090479	1.61	195	2
315	45	090579	2.21	240	1
316	45	090679	2.86	200	2
317	45	091179	2.44	293	2
318	45	091279	1.92	313	1
319	45	091379	1.85	240	2
320	45	091879	2.39	331	1
321	45	091979	1.86	323	2
322	45	092079	3.04	313	2
323	45	092579	2.85	345	1
324	45	092679	2.77	325	1

D-32

## LISTING OF PMP DATA BY POLLUTANT

7

----- POLL = BOD -----

OBS	PLANT	DATE	FLOW(MGD)	INFLUENT (PPM)	EFFLUENT (PPM)
325	45	092779	2.52	298	1
326	45	100279	2.24	288	2
327	45	100379	2.27	255	2
328	45	100479	2.66	288	3
329	45	100979	2.19	353	4
330	45	101079	2.52	420	2
331	45	101679	2.10	.	5
332	45	101779	1.95	468	4
333	45	101879	1.42	479	3
334	45	102379	2.26	.	6
335	45	102479	1.22	.	8
336	45	102579	1.55	.	2
337	45	103079	2.26	.	3
338	45	103179	1.86	320	3
339	45	110179	1.56	345	2
340	45	110679	1.59	395	5
341	45	110779	1.57	520	5
342	45	110879	1.73	425	3
343	45	111379	2.17	570	6
344	45	111479	1.41	678	4
345	45	111579	1.19	435	3
346	45	112079	1.65	385	2
347	45	112179	1.49	410	3
348	45	112279	0.96	430	3
349	45	112779	1.36	260	1
350	45	112879	1.48	303	1
351	45	112979	2.01	330	5
352	45	120479	1.36	273	1
353	45	120579	1.98	400	4
354	45	120679	1.54	315	3
355	45	121179	2.12	425	4
356	45	121279	2.03	477	6
357	45	121379	2.21	528	3
358	45	121879	2.09	487	4
359	45	121979	2.20	360	6
360	45	122079	2.22	513	3
361	45	122579	1.04	330	4
362	45	122679	1.65	320	4
363	45	122779	2.09	305	4
364	45	010180	0.74	430	3
365	45	010280	2.06	483	4
366	45	010380	1.93	482	6
367	45	010880	1.61	545	4
368	45	010980	1.74	660	3
369	45	011080	1.60	680	4
370	45	011580	1.59	450	4
371	45	011680	1.55	344	6
372	45	011780	1.53	365	2
373	45	012280	1.72	550	12
374	45	012380	1.91	760	4
375	45	012480	1.47	495	3
376	45	012980	1.80	510	5
377	45	013080	1.66	495	9
378	45	013180	1.64	518	6

D-33

## LISTING OF PMP DATA BY POLLUTANT

8

POL = BOD

OBS	PLANT	DATE	FLOW(MGD)	INFLUENT (PPM)	EFFLUENT (PPM)
379	45	020580	1.64	570	3
380	45	020680	1.48	475	7
381	45	020780	1.98	378	3
382	45	021280	2.02	390	4
383	45	021380	2.15	533	3
384	45	021480	1.92	513	2
385	45	021980	1.93	465	3
386	45	022080	2.13	425	3
387	45	022180	1.66	645	2
388	45	022680	1.40	470	5
389	45	022780	1.70	.	3
390	45	022880	1.06	455	3
391	45	030480	1.57	593	3
392	45	030580	1.72	497	3
393	45	030680	1.55	472	3
394	45	031180	2.58	583	6
395	45	031280	2.70	492	4
396	45	031380	2.05	542	3
397	45	031880	2.03	595	2
398	45	031980	2.23	690	2
399	45	032080	2.40	508	4
400	45	032580	1.55	540	3
401	45	032680	1.68	458	4
402	45	032780	1.67	483	3
403	45	040180	2.07	410	3
404	45	040280	1.54	420	2
405	45	040380	1.53	588	3
406	45	040880	1.85	493	3
407	45	040980	1.86	473	4
408	45	041080	1.8J	370	3
409	45	041580	1.67	330	1
410	45	041680	2.80	535	1
411	45	041780	2.51	440	2
412	45	042280	2.01	425	4
413	45	042380	1.73	410	1
414	45	042480	1.44	413	2
415	45	042980	1.76	475	1
416	45	043080	2.05	310	1
417	45	050180	1.72	323	1
418	45	050680	1.91	468	5
419	45	050780	2.30	368	5
420	45	050880	2.14	333	5
421	45	051380	1.88	343	2
422	45	051480	1.93	390	1
423	45	051580	1.53	435	2
424	45	052080	1.23	305	1
425	45	052180	1.17	330	2
426	45	052280	0.87	230	1
427	45	052780	1.30	55	3
428	45	052880	1.67	79	1
429	45	052980	0.99	128	1
430	45	060380	1.01	116	3
431	45	060480	0.93	160	3
432	45	060580	0.90	140	3

D-34

LISTING OF PMP DATA BY POLLUTANT

POLL = BOD

OBS	PLANT	DATE	FLOW (MGD)	INFLUENT (PPM)	EFFLUENT (PPM)
433	45	061080	1.45	215	1
434	45	061180	1.48	210	1
435	45	061280	1.66	210	1
436	45	061780	1.34	100	1
437	45	061880	1.41	195	1
438	45	061980	1.45	170	2
439	45	062480	1.26	293	1
440	45	062580	1.21	270	1
441	45	062680	1.54	320	2
442	96	093075	3.20	.	5
443	96	100375	3.20	.	4
444	96	100775	3.20	.	4
445	96	101075	3.10	.	11
446	96	101475	3.10	.	9
447	96	101775	3.20	.	5
448	96	102175	3.00	.	6
449	96	102475	3.20	.	8
450	96	102875	3.20	.	8
451	96	110175	3.20	.	6
452	96	110475	3.40	.	1
453	96	110775	3.40	.	1
454	96	111175	3.10	.	2
455	96	111475	3.10	.	2
456	96	111875	3.40	.	2
457	96	112175	3.40	.	1
458	96	112475	3.40	.	1
459	96	112775	3.30	.	2
460	96	120175	3.30	.	2
461	96	120475	3.30	.	2
462	96	120875	3.40	.	1
463	96	121175	3.20	.	1
464	96	121575	3.00	.	2
465	96	121875	3.10	.	2
466	96	122275	3.30	.	1
467	96	122575	3.50	.	3
468	96	122975	3.50	.	3
469	96	010176	3.50	.	2
470	96	010576	3.60	.	3
471	96	010876	3.50	.	2
472	96	011276	3.60	.	2
473	96	011576	3.50	.	3
474	96	012076	3.40	.	9
475	96	012276	3.20	.	3
476	96	012676	3.30	.	5
477	96	012976	3.20	.	2
478	96	020276	3.20	.	2
479	96	020576	3.30	.	3
480	96	020976	3.20	.	2
481	96	021276	3.50	.	1
482	96	021676	3.50	.	1
483	96	021976	3.20	.	3
484	96	022376	3.50	.	2
485	96	022676	3.20	.	1
486	96	030176	3.40	.	2



LISTING OF PMP DATA BY POLLUTANT

----- POL! =BOD -----

OBS	PLANT	DATE	FLOW(MGD)	INFLUENT (PPM)	EFFLUENT (PPM)
487	96	030476	3.4	.	3
488	96	030876	3.3	.	1
489	96	031176	3.1	.	2
490	96	031576	3.5	.	3
491	96	031876	3.2	.	3
492	96	032276	3.2	.	1
493	96	032676	3.2	.	2
494	96	033076	3.1	.	2
495	96	040176	3.2	.	2
496	96	040576	3.4	.	2
497	96	040876	3.1	.	2
498	96	041276	3.0	.	1
499	96	041576	3.8	.	2
500	96	041976	3.5	.	2
501	96	042276	3.2	.	1
502	96	042676	3.0	.	2
503	96	042976	3.0	.	3
504	96	050376	3.1	.	3
505	96	050676	3.2	.	1
506	96	051076	3.1	.	2
507	96	051376	3.0	.	1
508	96	051776	3.2	.	3
509	96	052076	3.0	.	1
510	96	052476	3.0	.	2
511	96	052776	2.9	.	1
512	96	053176	3.1	.	1
513	96	060376	3.0	.	1
514	96	060776	3.0	.	4
515	96	061076	3.1	.	3
516	96	061476	3.2	.	3
517	96	061776	3.1	.	4
518	96	062176	3.1	.	2
519	96	062476	2.9	.	2
520	96	062876	2.9	.	2
521	96	070176	3.4	.	1
522	96	070576	3.1	.	2
523	96	070876	3.0	.	1
524	96	071276	3.0	.	2
525	96	071576	3.0	.	1
526	96	071976	3.0	.	2
527	96	072276	2.8	.	1
528	96	072676	2.9	.	1
529	96	072976	2.8	.	1
530	96	080276	2.8	.	2
531	96	080576	2.7	.	2
532	96	080976	2.9	.	1
533	96	081276	3.1	.	1
534	96	081676	3.1	.	1
535	96	081976	2.9	.	2
536	96	082376	2.7	.	1
537	96	082676	2.8	.	1
538	96	083076	2.6	.	1
539	96	090276	2.6	.	2
540	96	090676	1.7	.	1

## LISTING OF PMP DATA BY POLLUTANT

11

----- PDL = BOD -----

OBS	PLANT	DATE	FLOW(MGD)	INFLUENT (PPM)	EFFLUENT (PPM)
541	96	090976	2.50	.	1
542	96	091376	2.20	.	2
543	96	091676	2.60	.	2
544	96	092076	2.50	.	1
545	96	092376	2.20	.	1
546	96	092776	2.60	.	1
547	111	010477	0.83	55	12
548	111	010577	0.96	65	11
549	111	010677	0.93	80	6
550	111	011177	0.91	105	10
551	111	011277	0.83	90	10
552	111	011377	0.70	87	12
553	111	011877	0.78	65	10
554	111	011977	0.98	80	9
555	111	012077	0.65	100	6
556	111	012577	0.84	79	8
557	111	012677	0.99	76	13
558	111	012777	0.98	75	13
559	111	020177	0.63	80	7
560	111	020277	0.61	100	12
561	111	020377	0.73	90	6
562	111	020877	0.87	80	6
563	111	020977	0.99	85	5
564	111	021077	0.36	88	6
565	111	021577	0.92	65	10
566	111	021677	0.69	65	8
567	111	021777	1.00	60	20
568	111	022277	0.74	85	8
569	111	022377	1.14	90	6
570	111	022477	1.08	100	5
571	111	030177	0.74	80	8
572	111	030277	0.68	90	10
573	111	030377	0.43	80	5
574	111	030877	0.73	88	9
575	111	030977	0.57	83	10
576	111	031077	1.15	75	8
577	111	031577	1.37	50	10
578	111	031677	1.01	75	8
579	111	031777	1.18	84	12
580	111	032277	1.11	75	18
581	111	032377	1.06	68	8
582	111	032477	0.96	65	8
583	111	032977	0.98	70	8
584	111	033077	0.89	80	6
585	111	033177	0.95	80	6
586	111	040477	0.93	95	12
587	111	040577	1.15	70	6
588	111	040677	0.74	80	5
589	111	041277	0.92	53	10
590	111	041377	1.10	60	10
591	111	041477	0.87	55	8
592	111	041977	0.45	60	8
593	111	042077	0.94	70	8
594	111	042177	1.02	64	8

## LISTING OF PMP DATA BY POLLUTANT

12

----- POLI = BOD -----

OBS	PLANT	DATE	FLOW(MGD)	INFLUENT (PPM)	EFFLUENT (PPM)
595	111	042677	0.83	68	8
596	111	042777	0.96	77	6
597	111	042877	0.55	75	6
598	111	050377	0.77	68	6
599	111	050477	0.65	65	8
600	111	050577	0.81	64	6
601	111	051077	0.82	95	8
602	111	051177	0.72	100	8
603	111	051277	0.75	100	8
604	111	051777	0.93	58	8
605	111	051877	0.93	60	6
606	111	051977	0.87	60	7
607	111	052477	0.98	36	7
608	111	052577	1.07	32	7
609	111	052677	1.17	32	6
610	111	053177	1.03	32	5
611	111	060177	0.85	40	6
612	111	060277	1.17	45	7
613	111	060777	1.09	32	15
614	111	060877	1.08	40	8
615	111	060977	0.77	38	8
616	111	061477	0.85	37	5
617	111	061577	0.82	40	4
618	111	061677	0.84	50	6
619	111	062177	0.42	32	5
620	111	062277	0.92	24	4
621	111	062377	1.01	32	4
622	111	062877	1.01	73	14
623	111	062977	0.52	75	10
624	111	063077	0.87	90	8
625	111	070577	0.66	160	4
626	111	070677	0.74	120	4
627	111	070777	0.67	115	4
628	111	071277	0.82	130	4
629	111	071377	0.99	118	5
630	111	071477	1.01	125	4
631	111	071977	0.88	140	5
632	111	072077	0.85	120	4
633	111	072177	0.97	100	4
634	111	072677	0.74	110	8
635	111	072777	0.96	100	4
636	111	072877	0.93	100	5
637	111	080277	1.08	110	16
638	111	080377	1.09	117	14
639	111	080477	1.09	118	12
640	111	080977	1.03	102	4
641	111	081077	0.93	88	4
642	111	081177	0.92	110	4
643	111	081677	0.99	75	2
644	111	081777	0.87	89	3
645	111	081877	1.16	80	3
646	111	082377	0.75	116	4
647	111	082477	0.74	120	3
648	111	082577	0.94	125	4

D-38

## LISTING OF PMP DATA BY POLLUTANT

13

----- POLI = BOD -----

OBS	PLANT	DATE	FLOW(MGD)	INFLUENT (PPM)	EFFLUENT (PPM)
649	111	083077	0.85	125	4
650	111	083177	0.80	110	5
651	111	090177	0.76	120	4
652	111	090677	1.00	119	3
653	111	090777	1.01	98	3
654	111	090877	0.84	95	4
655	111	091377	1.15	108	4
655	111	091477	0.97	130	4
657	111	091577	0.67	142	5
658	111	092077	1.10	106	5
659	111	092177	1.12	93	4
660	111	092277	1.30	94	5
661	111	092777	0.67	94	4
662	111	092877	0.95	107	3
663	111	092977	0.91	115	4
664	111	100477	0.76	108	3
665	111	100577	1.02	110	3
666	111	100677	0.88	109	3
667	111	101177	0.76	115	3
668	111	101277	0.86	111	3
669	111	101377	1.04	110	2
670	111	101877	1.10	92	3
671	111	101977	0.58	104	3
672	111	102077	0.85	113	3
673	111	102577	0.86	119	4
674	111	102677	0.92	120	3
675	111	102777	0.72	145	3
676	111	110177	0.81	138	3
677	111	110277	0.93	124	3
678	111	110377	1.18	123	4
679	111	110877	0.87	100	3
680	111	110977	1.01	100	3
681	111	111077	1.02	110	3
682	111	111577	0.91	147	4
683	111	111677	0.75	150	3
684	111	111777	0.88	165	3
685	111	112077	0.72	186	3
686	111	112177	0.82	200	2
687	111	112277	0.79	340	7
688	111	112377	0.65	180	13
689	111	112977	0.84	175	2
690	111	113077	1.15	130	2
691	111	120177	0.97	130	2
692	111	120677	1.03	120	2
693	111	120777	1.11	120	2
694	111	120877	0.68	110	3
695	111	121377	0.91	105	8
696	111	121477	1.06	95	7
697	111	121577	0.68	95	4
698	111	121977	0.73	100	3
699	111	122077	0.86	100	3
700	111	122177	0.92	95	3
701	111	122777	0.79	130	4
702	111	122877	0.71	128	3

D-39

LISTING OF PMP DATA BY POLLUTANT

POLL=BOD

OBS	PLANT	DATE	FLOW(MGD)	INFLUENT (PPM)	EFFLUENT (PPM)
703	111	122977	0.86	127	3.0
704	126	100275	0.38	1500	6.8
705	126	100575	0.28	640	4.4
706	126	100675	0.33	670	4.5
707	126	100775	0.30	460	6.2
708	126	100875	0.38	1500	6.2
709	126	100975	0.34	1800	6.9
710	126	101275	0.32	1300	4.7
711	126	101375	0.36	1100	5.1
712	126	101475	0.38	1100	4.4
713	126	101575	0.43	1100	4.4
714	126	101675	0.49	1200	4.7
715	126	101975	0.38	460	3.1
716	126	102075	0.32	330	4.8
717	126	102175	0.33	500	3.9
718	126	102275	0.31	1100	5.9
719	126	102375	0.32	1000	3.5
720	126	102675	0.30	1200	6.2
721	126	102775	0.44	1300	4.4
722	126	102875	0.53	1300	4.0
723	126	102975	0.41	910	4.4
724	126	103075	0.36	1100	3.9
725	126	110275	0.29	530	2.2
726	126	110375	0.30	540	2.5
727	126	110475	0.30	430	2.1
728	126	110575	0.37	1500	2.4
729	126	110675	0.39	1500	2.6
730	126	110975	0.44	1400	4.1
731	126	111075	0.58	1500	3.1
732	126	111175	0.48	1500	2.4
733	126	111275	0.45	1500	2.4
734	126	111375	0.49	1000	3.4
735	126	111675	0.41	1200	3.3
736	126	111775	0.43	660	1.7
737	126	111875	0.44	1100	2.5
738	126	111975	0.46	1100	1.8
739	126	112075	0.46	1500	1.6
740	126	112375	0.36	910	1.7
741	126	112475	0.38	1000	2.3
742	126	112575	0.41	370	2.4
743	126	112775	0.40	300	1.6
744	126	113075	0.35	570	2.0
745	126	120175	0.38	910	0.9
746	126	120275	0.33	900	1.7
747	126	120375	0.33	630	1.1
748	126	120475	0.40	490	2.6
749	126	120775	0.38	410	0.6
750	126	120875	0.35	760	1.1
751	126	120975	0.40	500	2.4
752	126	121075	0.30	570	1.5
753	126	121175	0.26	360	1.5
754	126	121475	0.39	520	2.0
755	126	121575	0.38	670	3.0
756	126	121675	0.35	750	1.4

D-40

## LISTING OF PMP DATA BY POLLUTANT

15

----- POLL=BOD -----

OBS	PLANT	DATE	FLOW(MGD)	INFLUENT (PPM)	EFFLUENT (PPM)
757	126	121775	0.33	720	2.9
758	126	121875	0.36	490	3.2
759	126	122175	0.25	560	2.0
760	126	122275	0.31	370	2.7
761	126	122375	0.34	410	2.1
762	126	122575	0.43	370	5.7
763	126	122875	0.45	700	1.7
764	126	122975	0.45	330	1.1
765	126	123075	0.42	720	1.8
766	126	010176	0.29	720	3.7
767	126	010476	0.45	520	13.0
768	126	010576	0.42	400	5.3
769	126	010676	0.43	430	3.5
770	126	010776	0.32	370	4.4
771	126	010876	0.35	770	4.1
772	126	011176	0.39	1700	3.2
773	126	011276	0.40	830	3.2
774	126	011376	0.37	1000	3.8
775	126	011476	0.35	1500	1.8
776	126	011576	0.32	1700	2.0
777	126	011876	0.30	430	2.1
778	126	011976	0.34	660	5.5
779	126	012076	0.35	440	2.1
780	126	012176	0.36	1000	2.5
781	126	012276	0.33	660	1.3
782	126	012576	0.39	370	2.0
783	126	012676	0.35	970	3.3
784	126	012776	0.35	1300	1.6
785	126	012876	0.46	1200	9.9
786	126	012976	0.44	1500	4.4
787	126	020176	0.45	1700	5.0
788	126	020276	0.34	2100	4.0
789	126	020376	0.37	890	4.2
790	126	020476	0.38	2000	4.5
791	126	020576	0.41	500	7.2
792	126	020876	0.46	800	4.3
793	126	020976	0.42	630	3.3
794	126	021076	0.35	1700	4.4
795	126	021176	0.37	1200	3.9
796	126	021276	0.34	930	4.3
797	126	021676	0.35	1900	5.9
798	126	021776	0.34	2400	4.6
799	126	021876	0.36	1400	4.7
800	126	021976	0.41	1100	4.7
801	126	022275	0.37	1000	4.3
802	126	022376	0.31	430	4.0
803	126	022476	0.33	540	4.0
804	126	022576	0.21	540	3.3
805	126	022676	0.30	560	3.9
806	126	022976	0.29	760	3.7
807	126	030176	0.25	310	3.6
808	126	030276	0.31	420	7.6
809	126	030376	0.33	430	5.4
810	126	030476	0.29	470	5.6

D-41

LISTING OF PMP DATA BY POLLUTANT

POLL=BOD

OBS	PLANT	DATE	FLOW(MGD)	INFLUENT (PPM)	EFFLUENT (PPM)
811	126	030776	0.23	820	6.9
812	126	030876	0.38	820	7.2
813	126	030976	0.45	820	8.0
814	126	031076	0.37	1500	7.7
815	126	031176	0.39	1300	7.5
816	126	031476	0.24	1400	12.0
817	126	031576	0.33	1800	10.0
818	126	031676	0.40	1100	12.0
819	126	031776	0.35	930	9.2
820	126	031876	0.29	1600	9.2
821	126	032176	0.26	2200	19.0
822	126	032276	0.25	630	18.0
823	126	032376	0.26	1500	11.0
824	126	032476	0.27	1300	12.0
825	126	032576	0.27	1300	14.0
826	126	032876	0.26	490	13.0
827	126	032976	0.32	660	11.0
828	126	033076	0.39	1600	13.0
829	126	033176	0.51	1154	19.0
830	126	040176	0.44	1500	16.0
831	126	040476	0.38	1800	15.0
832	126	040576	0.30	1800	20.0
833	126	040576	0.23	2000	18.0
834	126	040776	0.26	2600	15.0
835	126	040876	0.25	2500	14.0
836	126	041176	0.23	1600	11.0
837	126	041276	0.23	1000	8.4
838	126	041376	0.26	1500	14.0
839	126	041476	0.27	600	7.8
840	126	041876	0.28	640	11.0
841	126	041976	0.33	660	13.0
842	126	042076	0.36	840	12.0
843	126	042176	0.33	1100	12.0
844	126	042276	0.33	1800	12.0
845	126	042576	0.31	820	5.4
846	126	042676	0.33	930	6.6
847	126	042776	0.28	730	5.7
848	126	042876	0.29	1200	7.5
849	126	050576	0.30	2300	18.0
850	126	050676	0.40	1900	15.0
851	126	050976	0.33	1300	11.0
852	126	051076	0.37	1300	12.0
853	126	051176	0.38	1300	9.1
854	126	051276	0.32	1100	8.5
855	126	051376	0.43	930	6.9
856	126	051676	0.19	1200	6.6
857	126	051776	0.36	560	6.3
858	126	051876	0.35	1700	4.6
859	126	051976	0.34	2100	8.1
860	126	052076	0.34	2600	7.7
861	126	052376	0.25	2000	10.0
862	126	052476	0.20	1600	8.7
863	126	052576	0.22	1600	10.0
864	126	052676	0.20	1100	8.3

## LISTING OF PMP DATA BY POLLUTANT

17

----- POLI=BOD -----

OBS	PLANT	DATE	FLOW(MGD)	INFLUENT (PPM)	EFFLUENT (PPM)
865	126	052776	0.28	2100	4.6
866	126	053176	0.20	1000	8.0
867	126	060176	0.25	640	9.9
868	126	060276	0.41	840	8.3
869	126	060376	0.27	850	7.7
870	126	060676	0.23	540	9.2
871	126	060776	0.23	1100	12.0
872	126	060876	0.23	600	12.0
873	126	060976	0.24	530	11.0
874	126	061076	0.27	1200	13.0
875	126	061376	0.27	1600	6.9
876	126	061476	0.41	1800	5.6
877	126	061576	0.28	1000	9.3
878	126	061676	0.38	400	5.3
879	126	061776	0.45	540	6.9
880	126	062076	0.37	1600	6.2
881	126	062176	0.42	2100	10.0
882	126	062276	0.50	1500	5.9
883	126	062376	0.43	1800	4.5
884	126	062476	0.37	1300	3.5
885	126	062776	0.33	910	4.2
886	126	062876	0.37	1500	8.3
887	126	062976	0.39	950	6.3
888	126	063076	0.35	1400	5.0
889	126	070176	0.27	1000	6.8
890	126	070576	0.28	1200	2.4
891	126	070676	0.30	1800	8.3
892	126	070776	0.42	2200	4.4
893	126	070876	0.38	1100	4.3
894	126	071176	0.27	1800	12.0
895	126	071276	0.29	2300	14.0
896	126	071376	0.25	1900	10.0
897	126	071476	0.30	1100	6.0
898	126	071576	0.37	1300	8.0
899	126	071876	0.29	.	5.9
900	126	071976	0.28	1000	4.1
901	126	072076	0.28	600	6.0
902	126	072176	0.28	2000	5.0
903	126	072276	0.37	1400	5.1
904	126	072576	0.33	.	2.8
905	126	072676	0.41	2300	8.4
906	126	072776	0.46	2400	5.4
907	126	072876	0.38	2200	8.4
908	126	072976	0.72	730	11.0
909	126	080176	0.41	1000	8.7
910	126	080276	0.33	950	5.3
911	126	080376	0.35	930	5.1
912	126	080476	0.33	1300	6.3
913	126	080576	0.37	1300	5.3
914	126	080876	0.33	700	5.1
915	126	080976	0.31	890	5.9
916	126	081076	0.28	820	4.1
917	126	081176	0.28	640	2.4
918	126	081276	0.36	530	4.2

D-43



LISTING OF PMP DATA BY POLLUTANT

POLL=BOD

OBS	PLANT	DATE	FLOW(MGD)	INFLUENT (PPM)	EFFLUENT (PPM)
919	126	081576	0.40	530	5.1
920	126	081676	0.43	710	3.6
921	126	081776	0.35	2000	7.4
922	126	081876	0.33	2000	11.0
923	126	081976	0.31	1500	8.0
924	126	082276	0.21	540	6.9
925	126	082376	0.24	870	4.8
926	126	082476	0.25	980	3.8
927	126	082576	0.29	1200	6.3
928	126	082676	0.37	980	12.0
929	126	082976	0.28	640	2.0
930	126	083076	0.32	670	1.9
931	126	083176	0.38	930	2.8
932	126	090176	0.42	1400	3.8
933	126	090276	0.54	1300	2.6
934	126	090676	0.33	1400	2.3
935	126	090776	0.46	400	2.7
936	126	090876	0.38	870	2.7
937	126	090976	0.30	870	4.2
938	126	091276	0.43	1100	3.0
939	126	091376	0.52	840	4.2
940	126	091476	0.55	570	2.1
941	126	091576	0.63	640	3.1
942	126	091676	0.45	440	3.3
943	126	091976	0.34	530	2.0
944	126	092076	0.47	610	3.2
945	126	092176	0.55	1800	2.0
946	126	092276	0.52	890	2.0
947	126	092376	0.47	1500	2.1
948	126	092676	0.45	870	2.3
949	126	092776	0.53	930	1.8
950	126	092876	0.43	1100	1.2
951	126	092976	0.38	630	1.1
952	126	093076	0.47	980	1.5

POLL=OAG

OBS	PLANT	DATE	FLOW(MGD)	INFLUENT (PPM)	EFFLUENT (PPM)
953	3	010377	0.19	.	27.0
954	3	011077	0.20	52.0	.
955	3	011677	0.19	86.5	.
956	3	012477	0.17	62.0	.
957	3	013177	0.16	46.0	.
958	3	020777	0.19	82.0	.
959	3	021477	0.16	52.0	12.0
960	3	022177	0.20	39.0	.
961	3	022877	0.20	31.0	.
962	3	030777	0.21	62.0	.
963	3	031477	0.18	62.0	.
964	3	031777	0.20	.	22.0
965	3	032177	0.24	44.0	.
966	3	032877	0.22	38.0	.

D-44

## LISTING OF PMP DATA BY POLLUTANT

19

----- POLL=OAG -----

OBS	PLANT	DATE	FLOW(MGD)	INFLUENT (PPM)	EFFLUENT (PPM)
967	3	040477	0.23	119.0	.
968	3	041177	0.20	83.0	.
969	3	041477	0.22	.	17.5
970	3	041877	0.21	46.0	.
971	3	042577	0.22	44.0	.
972	3	050277	0.26	43.0	12.0
973	3	050977	0.21	61.0	.
974	3	051677	0.27	27.0	.
975	3	052377	0.26	35.0	.
976	3	060677	0.26	56.0	27.5
977	3	061377	0.29	52.0	.
978	3	062077	0.26	35.0	.
979	3	062777	0.25	23.0	.
980	3	070477	0.30	44.0	.
981	3	071177	0.31	31.0	.
982	3	071877	0.26	29.0	.
983	3	072577	0.29	24.0	16.0
984	3	080877	0.27	41.0	7.0
985	3	081577	0.25	37.0	.
986	3	082277	0.32	16.0	.
987	3	082977	0.27	27.0	.
988	3	090577	0.27	30.0	22.0
989	3	091277	0.26	38.0	.
990	3	091977	0.28	75.0	.
991	3	092677	0.26	61.0	.
992	3	101077	0.26	31.0	.
993	3	102477	0.32	41.0	22.0
994	3	103177	0.33	24.0	.
995	3	110777	0.26	21.0	.
996	3	111477	0.27	30.5	.
997	3	111577	0.29	.	12.5
998	3	112177	0.26	27.0	.
999	3	112877	0.26	37.0	.
1000	3	120577	0.28	36.5	12.5
1001	3	121277	0.28	31.0	.
1002	3	121977	0.29	46.5	.
1003	3	122777	0.29	32.5	.
1004	3	010978	0.28	25.0	.
1005	3	011678	0.31	10.5	8.5
1006	3	012378	0.34	12.0	.
1007	3	013078	0.23	36.0	.
1008	3	020678	0.24	16.0	13.0
1009	3	021378	0.25	19.0	.
1010	3	022778	0.24	26.0	.
1011	3	030678	0.26	225.0	.
1012	3	030778	0.26	.	26.0
1013	3	031378	0.26	188.0	.
1014	3	032078	0.26	56.0	3.3
1015	3	032178	0.25	.	11.0
1016	3	032778	0.26	42.0	.
1017	3	040378	0.32	41.0	.
1018	3	041078	0.34	36.5	.
1019	3	041778	0.26	38.0	.
1020	3	042478	0.25	36.0	11.0

D-45

## LISTING OF PMP DATA BY POLLUTANT

20

POLL=DAG

CBS	PLANT	DATE	FLOW(MGD)	INFLUENT (PPM)	EFFLUENT (PPM)
1021	3	050178	0.25	56.5	.
1022	3	050278	0.25	.	31.0
1023	3	050878	0.24	32.0	.
1024	3	051578	0.23	8.0	.
1025	3	052278	0.22	6.0	.
1026	3	062678	0.26	312.0	.
1027	3	062778	0.24	.	16.5
1028	3	070378	0.27	133.0	.
1029	3	071078	0.29	67.5	.
1030	3	071178	0.27	.	20.5
1031	3	071778	0.26	78.5	.
1032	3	073178	0.27	85.0	.
1033	3	080778	0.27	65.9	.
1034	3	080978	0.30	.	22.5
1035	3	081478	0.33	77.5	.
1036	3	082178	0.30	100.5	.
1037	3	082878	0.29	93.0	.
1038	3	090478	0.27	230.0	.
1039	3	091178	0.33	16.0	.
1040	3	091278	0.29	.	10.0
1041	3	091878	0.28	47.0	.
1042	3	092578	0.29	99.0	.
1043	3	100278	0.30	99.5	.
1044	3	100978	0.27	61.5	.
1045	3	101678	0.28	55.0	12.0
1046	3	102378	0.28	57.5	.
1047	3	103078	0.29	9.9	.
1048	3	110678	0.30	48.0	.
1049	3	111378	0.31	10.1	.
1050	3	111578	0.32	.	3.0
1051	3	112078	0.33	12.5	.
1052	3	112778	0.32	15.0	.
1053	3	120478	0.32	7.5	5.0
1054	3	121178	0.27	9.1	.
1055	3	121878	0.30	8.7	.
1056	3	122578	0.30	11.9	.
1057	3	010879	0.27	9.2	8.8
1058	3	011579	0.29	16.0	.
1059	3	012279	0.31	17.1	.
1060	3	012979	0.29	15.3	.
1061	3	020579	0.33	17.2	.
1062	3	021279	0.28	24.4	.
1063	3	021979	0.30	10.5	.
1064	3	022779	0.31	11.7	4.2
1065	3	030579	0.32	37.9	.
1066	3	031279	0.31	22.0	.
1067	3	031979	0.33	21.8	.
1068	3	032879	0.32	.	18.6
1069	3	032979	0.32	.	26.1
1070	3	033079	0.30	26.1	.
1071	3	040279	0.36	27.8	.
1072	3	040979	0.37	34.0	.
1073	3	041679	0.27	46.0	.
1074	3	042479	0.30	30.0	14.7

D-46

## LISTING OF PMP DATA BY POLLUTANT

21

----- POLI=OAG -----

OBS	PLANT	DATE	FLOW(MGD)	INFLUENT (PPM)	EFFLUENT (PPM)
1075	3	050779	0.33	39.6	.
1076	3	051479	0.33	38.2	.
1077	3	052179	0.31	37.0	24.5
1078	3	052879	0.31	30.9	.
1079	3	060479	0.34	28.9	12.9
1080	3	061179	0.31	35.6	.
1081	3	061879	0.34	13.5	.
1082	3	062579	0.34	32.6	.
1083	3	070279	0.35	38.2	.
1084	3	070979	0.30	2.3	1.7
1085	3	071779	0.36	14.2	.
1086	3	073079	0.33	25.9	.
1087	3	080679	0.36	29.0	21.0
1088	3	081379	0.33	28.6	.
1089	3	081679	0.34	.	6.7
1090	3	082079	0.30	25.6	.
1091	3	082779	0.35	26.0	.
1092	3	090379	0.31	23.8	.
1093	3	091079	0.38	28.3	.
1094	3	091779	0.38	19.0	.
1095	3	092479	0.36	9.9	1.4
1096	3	100179	.	23.0	.
1097	3	100879	0.31	6.2	.
1098	3	100979	0.36	.	2.3
1099	3	102279	0.30	4.3	.
1100	3	102979	0.32	11.0	.
1101	3	110579	0.31	17.0	.
1102	3	110679	0.30	.	3.7
1103	3	111979	0.32	32.9	.
1104	3	112679	0.33	28.1	.
1105	3	120379	0.30	5.7	1.4
1106	3	121079	0.29	22.4	.
1107	3	121779	0.29	38.2	.
1108	3	011080	0.34	20.6	17.3
1109	3	011180	0.34	.	21.9
1110	3	011480	0.35	32.4	.
1111	3	012180	0.29	28.6	.
1112	3	012880	0.28	33.1	.
1113	3	020480	0.35	46.9	.
1114	3	021280	0.29	82.8	.
1115	3	021380	0.30	.	1.3
1115	3	021880	0.26	58.5	.
1117	3	022580	0.28	37.3	.
1118	3	030380	0.28	37.3	.
1119	3	031080	0.32	24.0	.
1120	3	031280	0.34	3.6	.
1121	3	031780	0.35	.	0.4
1122	3	032480	0.30	24.5	.
1123	3	032180	0.35	34.7	.
1124	3	040780	0.30	18.8	.
1125	3	041480	0.36	13.9	.
1126	3	041580	0.32	.	5.0
1127	3	042880	0.32	27.6	.
1128	3	050580	0.28	11.3	.

D-47

## LISTING OF IMP DATA BY POLLUTANT

22

POLL=OAG

OBS	PLANT	DATE	FLOW(MGD)	INFLUENT (PPM)	EFFLUENT (PPM)
1129	3	051280	0.29	11.1	.
1130	3	051380	0.30	.	2
1131	3	051980	0.28	16.9	.
1132	61	010375	.	.	28
1133	61	010675	.	.	18
1134	61	010875	.	.	16
1135	61	011575	.	.	26
1136	61	012075	.	.	49
1137	61	012275	.	.	50
1138	61	012975	.	.	18
1139	61	020375	.	.	130
1140	61	020575	.	.	21
1141	61	021075	.	.	21
1142	61	021275	.	.	30
1143	61	021775	.	.	24
1144	61	021975	.	.	31
1145	61	022475	.	.	46
1146	61	022675	.	.	19
1147	61	030375	.	.	4
1148	61	030575	.	.	6
1149	61	031075	.	.	6
1150	61	031275	.	.	7
1151	61	031775	.	.	11
1152	61	031975	.	.	76
1153	61	032475	.	.	7
1154	61	032675	.	.	14
1155	61	040175	.	.	11
1156	61	040275	.	.	7
1157	61	040375	.	.	9
1158	61	040475	.	.	10
1159	61	040775	.	.	20
1160	61	040875	.	.	19
1161	61	040975	.	.	11
1162	61	041075	.	.	22
1163	61	041175	.	.	11
1164	61	041475	.	.	31
1165	61	041575	.	.	42
1166	61	041675	.	.	18
1167	61	041775	.	.	23
1168	61	041875	.	.	5
1169	61	042175	.	.	10
1170	61	042275	.	.	13
1171	61	042375	.	.	12
1172	61	042475	.	.	19
1173	61	042575	.	.	5
1174	61	042875	.	.	29
1175	61	042975	.	.	16
1176	61	043075	.	.	38
1177	61	050175	.	.	13
1178	61	050275	.	.	6
1179	61	050575	.	.	11
1180	61	050675	.	.	13
1181	61	050775	.	.	14
1182	61	050875	.	.	10

D-48

## LISTING OF PMP DATA BY POLLUTANT

23

----- POLL=DAG -----

OBS	PLANT	DATE	FLOW(MGD)	INFLUENT (PPM)	EFFLUENT (PPM)
1183	61	050975	.	.	3
1184	61	051275	.	.	9
1185	61	051375	.	.	13
1186	61	051475	.	.	24
1187	61	051575	.	.	11
1188	61	051675	.	.	13
1189	61	051975	.	.	9
1190	61	052075	.	.	17
1191	61	052175	.	.	36
1192	61	052275	.	.	14
1193	61	052375	.	.	16
1194	61	052675	.	.	75
1195	61	052775	.	.	19
1196	61	052875	.	.	265
1197	61	052975	.	.	13
1198	61	053075	.	.	14
1199	61	060275	.	.	15
1200	61	060375	.	.	13
1201	61	060975	.	.	9
1202	61	061675	.	.	6
1203	61	061875	.	.	13
1204	61	062075	.	.	3
1205	61	062475	.	.	17
1206	61	062675	.	.	10
1207	61	062775	.	.	16
1208	61	070175	.	.	14
1209	61	070275	.	.	12
1210	61	070375	.	.	11
1211	61	070475	.	.	15
1212	61	070875	.	.	8
1213	61	071075	.	.	13
1214	61	071175	.	.	5
1215	61	071575	.	.	5
1216	61	071675	.	.	4
1217	61	071775	.	.	5
1218	61	071875	.	.	11
1219	61	072275	.	.	15
1220	61	072475	.	.	14
1221	61	072575	.	.	14
1222	61	072875	.	.	12
1223	61	072975	.	.	25
1224	61	073075	.	.	10
1225	61	080675	.	.	6
1226	61	080775	.	.	11
1227	61	080875	.	.	12
1228	61	081175	.	.	13
1229	61	081275	.	.	8
1230	61	081375	.	.	17
1231	61	081475	.	.	11
1232	61	081575	.	.	20
1233	61	081875	.	.	29
1234	61	081975	.	.	10
1235	61	082075	.	.	11
1236	61	082175	.	.	10

## LISTING OF PMP DATA BY POLLUTANT

24

----- POLL=QAG -----

OBS	PLANT	DATE	FLOW(MGD)	INFLUENT (PPM)	EFFLUENT (PPM)
1237	61	082275	.	.	55
1238	61	082575	.	.	9
1239	61	082675	.	.	6
1240	61	082775	.	.	14
1241	61	082875	.	.	7
1242	61	082975	.	.	6
1243	61	090175	2.73	9	6
1244	61	090275	2.73	9	7
1245	61	090375	2.73	26	8
1246	61	090475	2.73	12	10
1247	61	090575	2.73	17	8
1248	61	090875	2.73	21	13
1249	61	090975	2.59	.	13
1250	61	091075	2.73	28	12
1251	61	091175	2.59	13	11
1252	61	091275	2.59	12	.
1253	61	091575	2.88	6	.
1254	61	091775	2.88	12	.
1255	61	091875	2.88	8	12
1256	61	091975	2.88	8	8
1257	61	092275	2.88	7	11
1258	61	092375	2.88	8	14
1259	61	092475	2.88	12	7
1260	61	092575	3.60	7	5
1261	61	092975	1.58	.	17
1262	61	093075	1.87	10	9
1263	61	100275	2.01	12	8
1264	61	100375	2.01	58	.
1265	61	100675	1.65	16	8
1266	61	100775	1.64	22	7
1267	61	100875	1.64	14	10
1268	61	100975	1.65	12	8
1269	61	101075	1.72	13	14
1270	61	101375	2.16	17	11
1271	61	101475	2.59	23	6
1272	61	101575	2.59	24	12
1273	61	101675	2.59	11	17
1274	61	101775	2.59	8	7
1275	61	102075	2.01	14	6
1276	61	102175	2.01	11	5
1277	61	102375	1.44	11	7
1278	61	102475	1.87	7	.
1279	61	102775	2.59	35	20
1280	61	102875	2.59	7	6
1281	61	102975	2.59	9	5
1282	61	103075	2.59	13	7
1283	61	103175	2.59	8	7
1284	61	110375	2.59	10	12
1285	61	110475	2.59	5	5
1286	61	110575	2.59	21	6
1287	61	110675	2.44	14	6
1288	61	110775	2.44	7	3
1289	61	111175	2.44	19	5
1290	61	111275	2.44	14	9

D-50

## LISTING OF PMP DATA BY POLLUTANT

25

POLL=DAG

OBS	PLANT	DATE	FLOW(MGD)	INFLUENT (PPM)	EFFLUENT (PPM)
1291	61	111375	2.44	.	8
1292	61	111475	2.44	6	.
1293	61	111775	2.44	9	3
1294	61	111875	2.44	6	4
1295	61	111975	2.52	63	4
1296	61	112075	2.59	2	5
1297	61	112175	2.59	3	4
1298	61	112475	2.16	4	9
1299	61	112575	2.30	15	9
1300	61	112675	2.59	13	4
1301	61	120275	2.52	12	.
1302	61	120375	2.59	9	7
1303	61	120475	2.44	.	8
1304	61	120575	2.30	.	64
1305	61	120875	.	7	9
1306	61	120975	2.66	8	8
1307	61	121075	2.73	4	5
1308	61	121175	2.66	6	6
1309	61	121275	2.59	8	6
1310	61	121575	2.59	9	6
1311	61	121675	2.73	8	6
1312	61	121775	2.80	9	7
1313	61	121975	2.73	9	5
1314	61	122275	2.73	9	8
1315	61	122975	2.73	8	8
1316	61	123075	2.73	6	8
1317	61	123175	2.73	15	11
1318	61	010276	2.91	7	10
1319	61	010576	2.88	15	18
1320	61	010676	2.73	9	8
1321	61	010776	2.88	9	9
1322	61	010876	2.88	.	10
1323	61	011276	2.88	11	14
1324	61	011376	2.88	19	8
1325	61	011576	2.95	6	9
1326	61	011676	2.80	7	3
1327	61	011976	2.08	8	5
1328	61	012076	2.09	3	4
1329	61	012176	2.37	8	8
1330	61	012276	2.66	10	7
1331	61	012376	2.66	7	7
1332	61	013076	3.09	.	9
1333	61	020376	2.80	5	5
1334	61	020476	2.30	6	9
1335	61	020576	2.01	8	8
1336	61	020676	2.44	5	.
1337	61	020976	2.59	12	9
1338	61	021176	2.30	7	6
1339	61	021376	2.03	9	14
1340	61	021675	2.16	.	13
1341	61	021776	2.16	9	9
1342	61	021876	2.01	20	10
1343	61	022376	2.44	7	16
1344	61	022476	2.37	9	10

D-51



LISTING OF PMP DATA BY POLLUTANT

POLL=OAG

OBS	PLANT	DATE	FLOW(MGD)	INFLUENT (PPM)	EFFLUENT (PPM)
1345	61	022576	2.23	.	7
1346	61	022776	2.23	9	6
1347	61	030176	1.58	10	9
1348	61	030276	1.58	8	6
1349	61	030476	1.58	8	10
1350	61	030576	1.58	.	10
1351	61	030876	2.03	6	4
1352	61	030976	2.30	11	7
1353	61	031076	2.44	5	8
1354	61	031176	2.44	8	2
1355	61	031276	2.44	10	7
1356	61	031576	2.73	6	8
1357	61	031776	2.16	14	6
1358	61	031876	1.72	14	11
1359	61	031976	1.58	7	12
1360	61	032276	2.01	19	8
1361	61	032376	2.30	17	8
1362	61	032476	2.37	20	8
1363	61	032576	2.52	13	6
1364	61	032676	2.59	10	6
1365	61	032976	2.59	8	9
1366	61	033076	2.59	13	10
1367	61	033176	2.59	10	8
1368	61	040176	2.59	8	12
1369	61	040576	2.30	12	9
1370	61	040676	2.30	12	8
1371	61	040776	2.30	8	6
1372	61	040876	2.30	11	7
1373	61	041176	2.30	8	8
1374	61	041276	2.30	20	3
1375	61	041376	2.01	22	7
1376	61	041476	2.01	16	10
1377	61	041876	1.87	9	12
1378	61	041976	1.67	14	7
1379	61	042076	1.87	17	8
1380	61	042276	2.47	18	10
1391	61	042576	2.30	.	8
1382	61	042676	2.30	18	13
1383	61	042776	2.44	26	9
1384	61	042876	2.52	27	7
1385	61	042976	2.12	17	15
1386	61	050276	2.13	31	9
1387	61	050376	2.23	10	10
1388	61	050476	2.30	12	9
1389	61	050576	2.30	21	11
1390	61	050676	2.44	5	10
1391	61	050976	2.88	28	11
1392	61	051076	2.88	6	1
1393	61	051176	2.88	9	4
1394	61	051276	2.88	27	5
1395	61	051376	2.88	8	2
1396	61	051676	1.87	14	6
1397	61	051776	1.87	12	5
1398	61	051876	2.13	10	31

D-52

## LISTING OF FMP DATA BY POLLUTANT

27

----- POLL=DAG -----

OBS	PLANT	DATE	FLOW(MGD)	INFLUENT (PPM)	EFFLUENT (PPM)
1399	61	051976	2.10	9	6
1400	61	052076	1.97	9	5
1401	61	052376	1.72	11	7
1402	61	052476	1.58	10	5
1403	61	052576	1.58	11	7
1404	61	052676	2.16	11	8
1405	61	052776	2.05	10	3
1406	61	053076	1.80	12	6
1407	61	053176	2.26	20	7
1408	61	060176	2.79	7	4
1409	61	060276	2.88	7	9
1410	61	060376	2.88	17	21
1411	61	060676	2.16	17	11
1412	61	060776	2.37	20	18
1413	61	060876	2.37	20	10
1414	61	060976	2.37	20	13
1415	61	061076	2.37	23	13
1416	61	061376	1.88	46	41
1417	61	061476	1.69	36	45
1418	61	061576	2.14	16	31
1419	61	061676	2.69	42	31
1420	61	061776	2.88	44	41
1421	61	062076	2.88	19	22
1422	61	062176	2.88	20	11
1423	61	062276	2.88	26	23
1424	61	062376	2.88	22	19
1425	61	062476	2.88	26	26
1426	61	062776	2.88	22	20
1427	61	062876	2.88	18	18
1428	61	062976	2.88	19	17
1429	61	063076	2.88	23	23
1430	61	070176	2.88	19	27
1431	61	070576	2.88	25	17
1432	61	070676	2.88	31	29
1433	61	071176	2.88	35	22
1434	61	071276	2.80	39	33
1435	61	071376	1.62	29	31
1436	61	071476	2.01	22	29
1437	61	071876	2.35	28	10
1438	61	071976	2.86	28	16
1439	61	072076	2.85	30	26
1440	61	072176	2.88	30	29
1441	61	072276	2.88	30	19
1442	61	072576	2.88	33	29
1443	61	072676	2.88	28	27
1444	61	072776	2.24	17	14
1445	61	072876	2.13	16	13
1446	61	072976	2.59	19	16
1447	61	073076	2.01	.	13
1448	61	080176	2.01	14	13
1449	61	080376	2.70	26	14
1450	61	080476	2.56	31	4
1451	61	080576	2.44	31	16
1452	61	080876	2.27	31	18

D-53

LISTING OF PMP DATA BY POLLUTANT

----- POLL-OAG -----

OBS	PLANT	DATE	FLOW(MGD)	INFLUENT (PPM)	EFFLUENT (PPM)
1453	61	080976	1.90	22	15.0
1454	61	081076	1.65	34	17.0
1455	61	081176	1.58	32	19.0
1456	61	081276	1.69	27	15.0
1457	61	081576	2.16	27	19.0
1458	61	081676	2.16	25	19.0
1459	61	081776	2.16	26	20.0
1460	61	081876	2.26	33	22.0
1461	61	081976	2.45	41	24.0
1462	61	082276	2.10	31	17.0
1463	61	082376	1.62	34	16.0
1464	61	082476	2.16	25	15.0
1465	61	082576	2.16	21	14.0
1466	61	082676	2.16	22	21.0
1467	61	082976	2.16	28	12.0
1468	61	083076	2.16	30	.
1469	61	083176	2.23	23	14.0
1470	61	090176	2.32	25	12.0
1471	61	090276	2.62	230	18.0
1472	61	090776	2.72	19	12.0
1473	61	090876	2.70	30	.
1474	61	090976	2.70	30	24.0
1475	61	091276	2.70	22	20.0
1476	61	091376	2.70	28	25.0
1477	61	091476	2.67	19	27.0
1478	61	091576	2.66	25	24.0
1479	61	091676	2.66	14	11.0
1480	61	091976	2.72	16	13.0
1481	61	092076	2.73	8	17.0
1482	61	092176	2.73	12	10.0
1483	61	092276	2.75	14	12.0
1484	61	092376	2.80	13	18.0
1485	61	092676	2.85	22	11.0
1485	61	092776	2.85	13	15.0
1487	61	092876	2.85	15	9.0
1488	61	092976	2.85	23	15.0
1489	61	093076	2.85	.	13.0
1490	124	011475	.	.	1.3
1491	124	012375	0.28	.	6.4
1492	124	012875	0.20	.	1.5
1493	124	013075	0.18	.	9.0
1494	124	020475	.	.	1.5
1495	124	020675	.	.	7.8
1496	124	021175	.	.	13.3
1497	124	021375	.	.	3.0
1498	124	021475	.	.	3.0
1499	124	031375	.	.	0.4
1500	124	031875	.	.	0.8
1501	124	032575	.	.	0.6
1502	124	041175	.	8	.
1503	124	041375	.	.	2.6
1504	124	041875	.	.	4.0
1505	124	042075	.	.	11.9
1506	124	042275	.	.	11.1

D-54

## LISTING OF PMP DATA BY POLLUTANT

29

----- POLL=DAG -----

OBS	PLANT	DATE	FLOW(MGD)	INFLUENT(PPM)	EFFLUENT(PPM)
1507	124	042775	.	.	3.2
1508	124	042975	.	.	11.1
1509	124	050475	.	.	1.6
1510	124	051175	.	.	0.8
1511	124	051675	.	.	0.9
1512	124	051875	.	.	8.5
1513	124	052075	.	.	3.8
1514	124	052375	.	.	0.5
1515	124	052575	.	.	1.4
1516	124	052775	.	.	0.8
1517	124	060175	.	.	0.4
1518	124	060675	.	4.0	.
1519	124	061075	.	.	2.0
1520	124	062075	.	.	0.4
1521	124	062275	.	.	5.9
1522	124	062375	.	.	0.3
1523	124	062775	.	.	2.7
1524	124	062975	.	.	0.6
1525	124	070475	.	.	0.9
1526	124	070675	.	.	2.8
1527	124	070875	.	.	0.2
1528	124	071375	.	.	0.3
1529	124	071575	.	.	4.5
1530	124	072275	.	.	0.2
1531	124	072575	.	.	5.7
1532	124	072775	.	.	3.6
1533	124	072975	.	.	4.0
1534	124	080175	.	.	17.3
1535	124	080375	.	.	7.3
1536	124	080575	.	.	14.2
1537	124	080875	.	1.8	5.2
1538	124	081075	.	.	23.5
1539	124	081275	.	.	15.8
1540	124	081575	.	.	1.0
1541	124	081775	.	.	36.0
1542	124	081975	.	.	2.7
1543	124	082275	.	33.0	10.8
1544	124	082475	.	51.1	1.2
1545	124	082675	.	.	17.0
1546	124	082775	.	14.2	.
1547	124	082975	.	.	21.2
1548	124	083175	.	.	20.4
1549	124	090175	.	52.4	.
1550	124	090275	.	.	1.2
1551	124	090575	.	16.7	6.2
1552	124	090775	.	.	29.3
1553	124	090975	.	.	34.4
1554	124	091275	.	.	1.2
1555	124	091475	.	.	1.8
1556	124	091675	.	.	6.1
1557	124	091975	.	.	4.4
1558	124	092175	.	.	4.6
1559	124	092375	.	.	1.0
1560	124	092675	.	.	1.9

D-55

## LISTING OF PMP DATA BY POLLUTANT

30

POLL=DAG

OBS	PLANT	DATE	FLOW(MGD)	INFLUENT (PPM)	EFFLUENT (PPM)
1561	124	092875	.	.	4.0
1562	124	093075	.	.	3.2
1563	124	100375	.	.	3.8
1564	124	100575	.	.	0.4
1565	124	101075	.	13.2	.
1566	124	101475	.	24.3	.
1567	124	102175	.	55.2	.
1568	124	102875	.	23.1	1.1
1569	124	110475	.	15.7	4.1
1570	124	111175	.	3.5	2.3
1571	124	111875	.	24.9	.
1572	124	112575	.	15.8	0.1
1573	124	120275	.	13.1	5.4
1574	124	120975	.	17.2	.
1575	124	121675	.	40.2	1.1
1576	124	122375	.	60.6	.
1577	124	123075	.	22.1	4.0
1578	124	010676	.	30.5	3.3
1579	124	011376	.	30.7	2.4
1580	124	012076	.	7.1	.
1581	124	012776	.	9.0	2.9
1582	124	020376	0.36	6.7	0.7
1583	124	021076	0.57	7.9	.
1584	124	021776	0.60	13.2	.
1585	124	022476	0.17	45.1	0.5
1586	124	030276	0.29	26.6	0.2
1587	124	030976	0.31	37.4	0.6
1588	124	031676	0.35	12.5	0.6
1589	124	032376	0.47	20.6	2.4
1590	124	033076	0.42	17.9	2.2
1591	124	040676	0.37	8.4	2.4
1592	124	041376	0.53	25.2	.
1593	124	042076	0.33	76.3	.
1594	124	042776	.	103.2	1.1
1595	124	050476	0.33	11.1	3.0
1596	124	051176	0.51	17.2	2.6
1597	124	051876	0.44	14.9	3.5
1598	124	052576	0.29	26.1	.
1599	124	060176	0.41	39.2	.
1600	124	060876	0.50	0.4	.
1601	124	061576	0.36	1.9	.
1602	124	062276	.	25.8	.
1603	124	062976	0.31	10.1	.
1604	124	070676	.	11.0	.
1605	124	071276	0.32	16.1	.
1606	124	071376	0.27	.	5.1
1607	124	072076	0.59	10.7	1.8
1608	124	072776	0.58	18.7	0.1
1609	124	080376	0.40	18.3	.
1610	124	081076	0.46	0.4	.
1611	124	082476	0.38	11.6	.
1612	124	082676	0.34	.	17.6
1613	124	082776	.	.	0.1
1614	124	083176	0.24	23.6	.

D-56

## LISTING OF PMP DATA BY POLLUTANT

31

POLL=DAG

OBS	PLANT	DATE	FLOW(MGD)	INFLUENT (PPM)	EFFLUENT (PPM)
1615	124	090776	0.29	46.4	2.4
1616	124	091476	0.81	17.3	.
1617	124	092176	0.46	23.6	0.7
1618	124	092876	0.66	18.4	.
1619	170	060478	3.58	48.6	2.2
1620	170	060778	4.18	62.4	15.6
1621	170	061178	2.47	28.6	3.6
1622	170	061478	3.17	55.8	9.6
1623	170	061878	3.42	50.8	2.4
1624	170	062178	3.02	81.8	6.6
1625	170	062578	3.66	134.6	2.0
1626	170	062978	3.49	42.2	8.0
1627	170	070478	3.82	35.6	6.0
1628	170	070578	3.16	61.0	3.0
1629	170	070978	3.02	52.0	9.0
1630	170	071278	2.66	64.0	3.0
1631	170	071678	3.17	12.0	3.0
1632	170	071978	3.06	52.0	6.0
1633	170	072378	3.15	24.0	8.8
1634	170	072678	3.14	71.0	2.4
1635	170	073078	2.86	34.0	5.4
1636	170	080278	2.99	159.8	17.8
1637	170	080678	2.74	50.0	4.6
1638	170	080978	2.74	64.2	7.2
1639	170	081378	2.96	33.0	4.0
1640	170	081678	2.59	29.0	9.0
1641	170	082078	2.66	167.0	7.0
1642	170	082378	2.98	32.0	4.0
1643	170	082778	2.66	76.6	3.8
1644	170	083078	3.58	53.6	0.6
1645	170	090378	2.51	102.6	2.4
1646	170	090678	2.64	91.0	9.0
1647	170	091078	3.02	104.2	5.6
1648	170	091378	3.64	58.8	14.6
1649	170	092078	2.64	34.0	8.0
1650	170	092178	2.88	28.0	7.0
1651	170	092478	2.75	72.0	11.0
1652	170	092778	2.62	65.4	7.2
1653	170	100178	2.62	107.0	20.0
1654	170	100478	2.83	26.0	6.0
1655	170	100878	3.05	84.0	17.0
1656	170	101178	2.66	166.0	5.0
1657	170	101578	2.86	95.0	8.0
1658	170	101878	3.35	20.0	5.0
1659	170	102278	2.76	115.0	19.0
1660	170	102578	2.90	31.0	5.0
1661	170	102978	3.19	27.0	1.0
1662	170	110178	2.33	71.0	13.0
1663	170	110578	2.33	19.2	2.0
1664	170	110678	2.33	127.0	20.0
1665	170	111278	2.62	31.6	12.4
1666	170	111578	2.98	147.2	11.6
1667	170	111978	2.40	21.0	6.0
1668	170	112278	2.04	143.0	7.4

D-57

## LISTING OF PMP DATA BY POLLUTANT

32

----- POLL = QAG -----

OBS	PLANT	DATE	FLOW(MGD)	INFLUENT (PPM)	EFFLUENT (PPM)
1669	170	112678	2.50	38.0	13.0
1670	170	112978	2.54	67.0	11.0
1671	170	120378	2.86	75.6	10.2
1672	170	120678	2.82	64.0	6.4
1673	170	121078	3.32	85.1	10.0
1674	170	121378	2.73	89.8	21.8
1675	170	121778	3.01	104.0	9.0
1676	170	122078	2.55	95.0	5.0
1677	170	122478	2.45	180.0	6.0
1678	170	122778	3.02	88.0	6.0
1679	170	123178	3.29	.	11.0
1680	170	010379	3.00	109.0	17.0
1681	170	010779	3.00	176.0	10.0
1682	170	011079	3.00	187.0	13.0
1683	170	011479	3.00	43.0	10.0
1684	170	011779	3.00	40.0	7.0
1685	170	012179	3.20	52.0	4.0
1686	170	012479	2.71	123.0	15.0
1687	170	012879	2.72	109.0	28.0
1688	170	013179	2.89	32.0	7.0
1689	170	020479	3.13	65.0	8.0
1690	170	020779	2.86	92.0	4.6
1691	170	021179	2.72	140.0	12.0
1692	170	021479	3.50	58.0	10.0
1693	170	021879	2.32	276.0	12.0
1694	170	022179	3.28	246.0	.
1695	170	022579	3.43	110.0	25.0
1696	170	022879	3.47	66.0	16.0
1697	170	030479	2.60	43.0	13.0
1698	170	030779	2.53	94.0	15.3
1699	170	031179	1.75	54.0	18.0
1700	170	031579	2.22	70.0	17.0
1701	170	031879	2.32	94.0	26.0
1702	170	032179	1.74	70.0	18.0
1703	170	032579	3.05	95.0	29.0
1704	170	032879	2.42	146.0	35.0
1705	170	040179	3.12	116.0	14.0
1706	170	040479	1.34	73.0	12.0
1707	170	040879	2.04	62.0	6.0
1708	170	041179	2.78	71.0	4.0
1709	170	041579	2.54	326.0	8.0
1710	170	041879	2.50	137.0	3.0
1711	170	042279	2.50	56.0	5.0
1712	170	042579	2.48	85.0	6.0
1713	170	042979	2.27	40.0	8.0
1714	170	050279	2.53	231.0	14.0
1715	170	050679	2.08	80.0	20.0
1716	170	050979	2.03	75.0	18.0
1717	170	051379	3.48	51.8	23.0
1718	170	051679	2.52	81.8	6.8
1719	170	052079	2.66	71.0	11.0
1720	170	052379	2.94	56.0	8.0
1721	170	052779	2.63	70.0	12.0
1722	170	053079	2.68	52.0	3.2

D-58

## LISTING OF PMP DATA BY POLLUTANT

33

----- POLL = OAG -----

OBS	PLANT	DATE	FLOW(MGD)	INFLUENT (PPM)	EFFLUENT (PPM)
1723	170	060379	2.74	78.6	17.8
1724	170	060679	2.21	39.0	17.0
1725	170	061079	2.96	163.0	24.0
1726	170	061379	2.30	409.0	39.0
1727	170	061779	3.90	202.0	28.0
1728	170	062079	2.99	56.4	3.2
1729	170	062479	2.90	106.0	8.0
1730	170	062779	2.57	200.0	10.6
1731	170	070179	3.22	56.0	19.6
1732	170	070479	3.64	46.0	11.0
1733	170	070879	1.97	56.0	9.0
1734	170	071179	2.90	54.0	16.0
1735	170	071579	2.51	49.0	2.0
1736	170	071879	3.36	61.0	10.0
1737	170	072279	3.00	42.0	13.0
1738	170	072579	3.01	82.0	11.0
1739	170	072979	3.32	42.0	12.0
1740	170	080179	3.32	139.8	21.2
1741	170	080579	2.90	86.4	5.4
1742	170	080879	2.30	98.0	5.2
1743	170	081279	2.83	58.2	14.6
1744	170	081579	2.57	20.8	2.8
1745	170	081979	3.70	40.0	7.0
1746	170	082279	3.44	56.0	16.0
1747	170	082679	2.78	95.0	18.0
1748	170	082979	3.71	55.0	17.8
1749	170	090279	3.19	47.2	6.2
1750	170	090579	3.19	28.6	5.8
1751	170	090979	3.05	56.8	18.6
1752	170	091279	3.10	50.2	10.6
1753	170	091679	3.05	79.4	8.8
1754	170	091979	3.05	111.0	10.2
1755	170	092379	3.57	95.6	11.2
1756	170	092679	2.64	85.8	15.4
1757	170	093079	3.05	68.2	14.2
1758	170	100379	3.77	25.0	7.6
1759	170	100779	3.37	67.0	11.0
1760	170	101079	3.36	37.0	9.0
1761	170	101479	2.90	22.0	10.0
1762	170	101779	2.90	42.6	13.0
1763	170	102379	2.86	29.4	8.2
1764	170	102579	2.78	21.2	1.4
1765	170	103079	3.05	90.8	1.2
1766	170	110179	2.38	32.0	8.0
1767	170	110679	3.07	149.4	10.8
1768	170	110879	2.40	168.0	10.4
1769	170	111379	3.41	26.0	6.0
1770	170	111579	2.90	52.0	3.0
1771	170	112079	2.86	32.0	2.0
1772	170	112279	2.93	44.0	4.2
1773	170	112779	2.89	96.0	9.0
1774	170	112979	2.79	194.0	10.2
1775	170	120479	3.17	150.0	18.0
1776	170	120679	3.19		22.0

D-59



## LISTING OF PMP DATA BY POLLUTANT

34

----- POLL=DAG -----

OBS	PLANT	DATE	FLOW(MGD)	INFLUENT (PPM)	EFFLUENT (PPM)
1777	170	121179	3.23	257.0	18.0
1778	170	121379	3.48	.	22.0
1779	170	121879	2.63	126.0	7.4
1780	170	122079	2.83	66.0	13.0
1781	170	122579	3.43	80.6	23.4
1782	170	122779	2.86	34.0	10.0
1783	170	010180	3.38	18.2	.
1784	170	010380	2.90	108.0	.
1785	170	010880	3.05	30.0	.
1786	170	011080	3.19	101.0	.
1787	170	011680	3.31	75.0	.
1788	170	011780	3.31	90.0	.
1789	170	012280	2.90	26.0	.
1790	170	012480	2.62	92.0	.
1791	170	012980	3.01	96.0	.
1792	170	013180	3.25	26.0	.
1793	170	020580	3.14	62.0	.
1794	170	021280	3.19	160.0	.
1795	170	021480	2.95	29.4	.
1796	170	021980	2.84	50.0	.
1797	170	022280	3.20	87.0	.
1798	170	022680	2.97	88.0	.
1799	170	022880	3.04	86.0	.
1800	170	030480	3.29	84.0	.
1801	170	030680	3.46	96.0	.
1802	170	031180	2.94	105.0	.
1803	170	031380	3.42	52.0	.
1804	170	031880	3.50	68.0	.
1805	170	032080	3.78	67.6	.
1806	170	032580	3.45	34.0	.
1807	170	032780	1.96	25.0	.
1808	170	040180	3.40	82.6	.
1809	170	040380	3.37	64.2	.
1810	170	040880	3.66	37.4	.
1811	170	041680	2.90	18.0	.
1812	170	041780	3.05	30.2	.
1813	170	042280	3.31	49.0	.
1814	170	042480	2.10	54.0	.
1815	170	042980	2.70	94.2	.
1816	170	050180	2.33	51.4	.
1817	170	050680	2.47	20.0	.
1818	170	050980	2.33	61.0	.
1819	170	051380	2.16	22.2	.
1820	170	051580	2.09	62.0	.
1821	170	052080	2.94	28.0	.
1822	170	052280	2.25	27.0	.
1823	170	052780	2.00	108.0	.
1824	170	052980	2.18	94.0	.

D-60

## LISTING OF PMP DATA BY POLLUTANT

35

----- PQLL=TSS -----

OBS	PLANT	DATE	FLOW(MGD)	INFLUENT (PPM)	EFFLUENT (PPM)
1825	9	101575	0.05	36	31.0
1826	9	102275	0.05	28	21.0
1827	9	111275	0.25	41	47.0
1828	9	111975	0.07	14	45.0
1829	9	121075	0.06	22	6.0
1830	9	121775	0.06	4	13.0
1831	9	010776	0.10	13	13.0
1832	9	011476	.	50	52.0
1833	9	021176	0.07	31	20.0
1834	9	021876	.	50	16.0
1835	9	031076	0.08	25	41.0
1838	9	032576	.	49	53.0
1837	9	041476	0.06	19	20.0
1838	9	042176	.	49	47.0
1839	9	051276	0.09	27	17.0
1840	9	051976	.	20	50.0
1841	9	060976	0.13	57	41.2
1842	9	061676	0.13	12	17.0
1843	9	072176	0.07	14	15.0
1844	9	072876	0.09	20	40.0
1845	9	080476	0.05	11	40.0
1846	9	081876	0.06	48	17.0
1847	9	090876	0.02	10	17.0
1848	9	092276	.	4	19.0
1849	44	060179	0.92	88	3.0
1850	44	060479	0.88	224	10.0
1851	44	060579	1.00	268	9.0
1852	44	060679	0.80	306	20.0
1853	44	060779	0.38	212	6.0
1854	44	060879	0.83	512	20.0
1855	44	061179	0.94	18	11.0
1856	44	061279	0.79	138	33.0
1857	44	061379	0.80	3944	47.0
1858	44	061479	1.13	1234	18.0
1859	44	061579	0.45	508	22.0
1860	44	061879	0.57	760	10.0
1861	44	061979	0.71	1016	82.0
1862	44	062079	0.39	.	33.0
1863	44	062179	0.57	.	8.0
1864	44	062279	0.36	.	16.0
1865	44	062579	0.83	.	5.0
1866	44	062679	0.68	.	21.0
1867	44	062779	0.60	.	4.0
1868	44	062879	0.62	.	9.0
1869	44	062979	0.80	.	5.0
1870	44	070279	0.81	176	17.0
1871	44	070379	0.63	82	11.0
1872	44	070479	0.51	896	17.0
1873	44	070579	0.25	450	16.0
1874	44	070679	0.34	602	30.0
1875	44	070979	0.79	182	4.0
1876	44	071079	0.71	300	7.0
1877	44	071179	0.73	138	11.0
1878	44	071279	0.74	390	8.0

D-61

LISTING OF PMP DATA BY POLLUTANT

----- POLL=TSS -----

OBS	PLANT	DATE	FLOW(MGD)	INFLUENT (PPM)	EFFLUENT (PPM)
1879	44	071379	0.80	830	5
1880	44	071679	0.74	342	4
1881	44	071779	0.79	5478	1
1882	44	071879	0.73	10050	7
1883	44	071979	0.73	15150	10
1884	44	072079	0.90	11900	4
1885	44	072379	0.54	410	4
1886	44	072479	0.69	662	13
1887	44	072579	0.73	1078	9
1888	44	072679	0.81	15400	19
1889	44	072779	0.71	10300	17
1890	44	073079	0.79	17660	5
1891	44	073179	0.43	314	5
1892	44	080179	0.38	508	5
1893	44	080279	0.46	600	18
1894	44	080379	0.66	1258	3
1895	44	080679	0.74	792	4
1896	44	080779	0.26	272	7
1897	44	080879	0.56	248	28
1898	44	080979	0.73	1440	2
1899	44	081079	0.75	2084	13
1900	44	081379	0.74	1176	2
1901	44	081479	0.65	2502	6
1902	44	081579	0.79	20700	2
1903	44	081679	0.73	17160	3
1904	44	081779	0.84	20700	2
1905	44	082079	0.83	17380	11
1906	44	082179	0.85	21270	8
1907	44	082279	0.73	11000	16
1908	44	082379	0.67	706	8
1909	44	082479	0.94	1846	13
1910	44	082779	0.96	9000	10
1911	44	082879	0.96	69600	14
1912	44	082979	0.91	2160	11
1913	44	083079	0.90	7320	54
1914	44	083179	.	.	10
1915	44	090379	0.19	3320	2
1916	44	090479	0.34	8212	3
1917	44	090579	0.28	3980	2
1918	44	090679	0.39	2580	1
1919	44	090779	0.33	1052	2
1920	44	091079	0.62	430	5
1921	44	091179	0.70	7140	2
1922	44	091279	0.67	10560	1
1923	44	091379	0.72	18940	2
1924	44	091479	0.85	18820	2
1925	44	091779	0.88	13380	25
1926	44	091879	0.88	2860	83
1927	44	091979	0.48	1900	10
1928	44	092079	0.33	1080	6
1929	44	092179	0.43	3240	14
1930	44	092479	0.31	2900	3
1931	44	092579	0.27	16100	5
1932	44	092679	0.37	4020	2

D-62

## LISTING OF PMP DATA BY POLLUTANT

37

----- POLL-TSS -----

OBS	PLANT	DATE	FLOW(MGD)	INFLUENT (PPM)	EFFLUENT (PPM)
1933	44	092779	0.36	11440	65
1934	44	092879	0.35	19280	95
1935	44	100179	0.55	4120	20
1936	44	100279	0.57	3300	24
1937	44	100379	0.45	182	34
1938	44	100479	0.36	204	37
1939	44	100579	0.57	680	4
1940	44	100879	0.96	5420	6
1941	44	100979	0.46	360	13
1942	44	101079	0.64	5280	19
1943	44	101179	0.70	1920	9
1944	44	101279	0.68	4940	16
1945	44	101579	0.23	10540	11
1946	44	101679	0.67	9800	15
1947	44	101779	0.67	12120	33
1948	44	101879	0.60	6200	16
1949	44	101979	0.62	12740	35
1950	44	102279	0.60	13500	16
1951	44	102379	0.68	20440	18
1952	44	102479	0.69	14960	20
1953	44	102579	0.60	1700	38
1954	44	102679	0.59	560	34
1955	44	102979	0.60	7360	25
1956	44	103079	0.67	16060	6
1957	44	103179	0.10	1380	28
1958	44	110179	0.52	640	18
1959	44	110279	0.72	1180	9
1960	44	110579	0.58	2640	16
1961	44	110679	0.59	1780	2
1962	44	110779	0.68	3520	12
1963	44	110879	0.68	2640	22
1964	44	110979	0.53	580	4
1965	44	111279	0.66	2460	7
1966	44	111379	0.98	5640	24
1967	44	111479	0.65	8160	22
1968	44	111579	0.51	340	26
1969	44	111679	0.51	760	4
1970	44	111979	0.72	1260	21
1971	44	112079	0.78	2560	9
1972	44	112179	0.78	2100	4
1973	44	112279	0.35	560	4
1974	44	112379	0.11	640	3
1975	44	112679	0.58	2620	1
1976	44	112779	0.78	1750	12
1977	44	112879	0.69	1185	1
1978	44	112979	0.70	1480	5
1979	44	113079	0.73	2620	2
1980	44	120379	0.74	2300	2
1981	44	120479	0.55	4360	5
1982	44	120579	0.60	2060	1
1983	44	120679	0.66	240	4
1984	44	120779	0.70	920	2
1985	44	121079	1.12	2080	1
1986	44	121179	0.63	1360	1

D-63

## LISTING OF PMP DATA BY POLLUTANT

38

----- P O L L U T A N T -----

OBS	PLANT	DATE	FLOW(MGD)	INFLUENT (PPM)	EFFLUENT (PPM)
1987	44	121279	0.79	1240	4
1988	44	121379	0.60	3760	1
1989	44	121479	0.63	5080	9
1990	44	121779	0.61	1000	2
1991	44	121879	0.58	1480	4
1992	44	121979	0.57	373	2
1993	44	122079	0.52	880	4
1994	44	122179	0.65	3880	1
1995	44	122479	0.36	100	2
1996	44	122579	0.47	940	5
1997	44	122679	0.41	720	5
1998	44	122779	0.30	380	6
1999	44	122879	0.41	400	8
2000	44	123179	0.63	.	12
2001	44	010180	0.53	1600	3
2002	44	010280	0.15	670	16
2003	44	010380	0.59	920	6
2004	44	010480	0.50	154	7
2005	44	010780	0.67	150	680
2006	44	010880	0.63	180	18
2007	44	010980	0.65	790	6
2008	44	011080	0.47	1255	4
2009	44	011180	0.69	744	14
2010	44	011480	0.32	160	7
2011	44	011580	0.60	360	6
2012	44	011680	0.76	480	2
2013	44	011780	0.74	720	6
2014	44	011880	0.56	1040	7
2015	44	012180	0.62	1440	4
2016	44	012280	0.60	940	3
2017	44	012380	0.65	280	25
2018	44	012480	0.53	220	2
2019	44	012580	0.61	280	2
2020	44	012880	0.56	260	2
2021	44	012980	0.48	186	11
2022	44	013080	0.43	340	2
2023	44	013180	0.54	160	1
2024	44	020180	0.67	100	2
2025	44	020480	0.87	90	17
2026	44	020580	0.55	122	4
2027	44	020680	0.49	55740	7
2028	44	020780	0.45	13400	2
2029	44	020880	0.74	1280	41
2030	44	021180	0.69	340	15
2031	44	021280	0.25	34100	3
2032	44	021380	0.51	80	2
2033	44	021480	0.63	180	3
2034	44	021580	0.57	260	4
2035	44	021880	0.47	13300	3
2036	44	021980	0.65	380	2
2037	44	022080	0.60	2780	2
2038	44	022180	0.74	3340	6
2039	44	022280	0.71	3520	65
2040	44	022580	0.89	3920	7

D-64

## LISTING OF PMP DATA BY POLLUTANT

39

POLI 5,55

OBS	PLANT	DATE	FLOW(MGD)	INFLUENT (PPM)	EFFLUENT (PPM)
2041	44	022680	0.85	1840	10
2042	44	022780	0.78	5500	2
2043	44	022880	0.58	4320	6
2044	44	030380	0.44	1920	7
2045	44	030480	0.50	8080	7
2046	44	030580	0.57	120	2
2047	44	030680	0.61	15060	3
2048	44	030780	1.04	2440	4
2049	44	031080	0.79	1080	9
2050	44	031180	0.64	340	2
2051	44	031280	0.63	820	2
2052	44	031380	0.82	140	2
2053	44	031480	0.80	1060	2
2054	44	031780	0.91	2940	2
2055	44	031880	0.86	620	6
2056	44	031980	0.82	760	8
2057	44	032080	1.00	100	5
2058	44	032180	0.97	7064	3
2059	44	032480	0.62	3560	3
2060	44	032580	0.78	1480	15
2061	44	032680	0.75	2280	7
2062	44	032780	0.71	1860	5
2063	44	032880	0.82	3604	3
2064	44	033180	0.73	.	4
2065	44	040180	0.81	86	10
2066	44	040280	0.82	4640	2
2067	44	040380	0.56	800	7
2068	44	040480	0.21	460	2
2069	44	040780	0.64	1460	2
2070	44	040880	0.90	4780	11
2071	44	040980	0.71	1780	5
2072	44	041080	0.92	1340	2
2073	44	041180	0.93	1260	2
2074	44	041480	0.95	780	3
2075	44	041580	0.70	280	2
2076	44	041680	0.74	580	2
2077	44	041780	0.87	280	2
2078	44	041880	0.86	780	2
2079	44	042180	0.76	420	5
2080	44	042280	0.55	160	2
2081	44	042380	0.73	500	2
2082	44	042480	0.73	460	2
2083	44	042580	0.59	740	2
2084	44	042880	0.62	680	7
2085	44	042980	0.60	600	2
2086	44	043080	0.62	380	4
2087	44	050180	0.70	500	2
2088	44	050280	0.67	460	2
2089	44	050580	0.87	1460	2
2090	44	050680	0.96	940	2
2091	44	050780	0.87	260	10
2092	44	050880	0.32	240	18
2093	44	050980	0.60	80	9
2094	44	051260	0.72	420	10

D-65

## LISTING OF PMP DATA BY POLLUTANT

40

## ----- POLL=TSS -----

OBS	PLANT	DATE	FLOW(MGD)	INFLUENT (PPM)	EFFLUENT (PPM)
2095	44	051380	0.80	120	4
2096	44	051480	0.64	440	5
2097	44	051580	0.35	520	10
2098	44	051680	0.60	720	7
2099	44	051980	0.50	350	3
2100	44	052080	0.25	80	2
2101	44	052180	0.11	30	12
2102	44	052280	0.57	20	320
2103	44	052380	0.44	310	25
2104	44	052680	0.30	310	10
2105	44	052780	0.48	60	2
2106	44	052880	0.54	30	2
2107	44	052980	.	20	44
2108	44	053080	.	40	59
2109	45	070279	2.17	12	2
2110	45	070379	1.73	6	4
2111	45	070479	1.46	26	22
2112	45	070579	2.13	26	10
2113	45	070679	1.90	.	12
2114	45	070779	2.11	.	10
2115	45	070879	2.24	14	16
2116	45	070979	2.26	90	64
2117	45	071079	2.35	306	54
2118	45	071179	2.84	110	26
2119	45	071279	2.95	136	46
2120	45	071379	3.26	.	10
2121	45	071479	3.43	.	6
2122	45	071579	2.49	44	12
2123	45	071679	2.47	22	8
2124	45	071779	2.07	66	10
2125	45	071879	2.43	40	10
2126	45	071979	2.70	38	8
2127	45	072079	2.55	.	4
2128	45	072179	2.48	.	10
2129	45	072279	2.45	60	6
2130	45	072379	3.28	6	10
2131	45	072479	3.43	20	16
2132	45	072579	3.17	522	22
2133	45	072679	3.26	980	10
2134	45	072779	3.24	.	4
2135	45	072879	3.07	.	4
2136	45	072979	3.20	94	6
2137	45	073079	3.20	62	10
2138	45	073179	3.12	496	6
2139	45	080179	3.03	104	4
2140	45	080279	2.87	534	6
2141	45	080379	2.97	.	6
2142	45	080479	3.18	.	6
2143	45	080579	2.98	446	4
2144	45	080679	3.10	320	4
2145	45	080779	2.94	556	30
2146	45	080879	3.04	668	8
2147	45	080979	2.48	618	10
2148	45	081079	3.21	.	46

D-66

## LISTING OF PMP DATA BY POLLUTANT

41

----- POLL=TSS -----

OBS	PLANT	DATE	FLOW(MGD)	INFLUENT (PPM)	EFFLUENT (PPM)
2149	45	081279	2.90	672	44
2150	45	081379	2.66	490	42
2151	45	081479	2.71	564	20
2152	45	081579	2.56	398	14
2153	45	081679	2.82	412	4
2154	45	081779	2.73	.	20
2155	45	081879	2.63	.	6
2156	45	081979	2.52	494	2
2157	45	082079	2.87	512	10
2158	45	082179	3.41	482	4
2159	45	082279	3.62	552	10
2160	45	082379	3.56	398	8
2161	45	082479	3.58	.	8
2162	45	082579	3.29	.	12
2163	45	082679	2.55	64	8
2164	45	082779	3.01	36	10
2165	45	082879	2.63	80	4
2166	45	082979	2.56	82	6
2167	45	083079	3.40	128	18
2168	45	083179	2.72	.	20
2169	45	090179	2.21	.	14
2170	45	090279	2.00	86	16
2171	45	090379	0.63	1118	6
2172	45	090479	1.61	72	18
2173	45	090579	2.21	74	8
2174	45	090679	2.86	52	4
2175	45	090779	2.82	.	30
2176	45	090879	2.34	.	46
2177	45	090979	1.88	202	20
2178	45	091079	2.39	224	6
2179	45	091179	2.44	48	4
2180	45	091279	1.92	48	14
2181	45	091379	1.85	68	4
2182	45	091479	1.98	.	28
2183	45	091579	2.40	.	32
2184	45	091679	2.44	82	40
2185	45	091779	2.37	44	10
2186	45	091879	2.39	26	4
2187	45	091979	1.86	24	6
2188	45	092079	3.04	74	2
2189	45	092179	2.91	.	12
2190	45	092279	3.06	.	14
2191	45	092379	2.73	220	10
2192	45	092479	2.52	58	12
2193	45	092579	2.85	72	14
2194	45	092679	2.77	70	4
2195	45	092779	2.52	44	10
2196	45	092879	2.45	.	24
2197	45	092979	2.60	.	14
2198	45	093079	2.49	36	22
2199	45	100179	2.32	54	14
2200	45	100279	2.24	92	28
2201	45	100379	2.27	62	8
2202	45	100479	2.66	12	6

D-67



## LISTING OF PMP DATA BY POLLUTANT

42

----- POLL=TSS -----

OBS	PLANT	DATE	FLOW(MGD)	INFLUENT (PPM)	EFFLUENT (PPM)
2203	45	100579	2.44	.	72
2204	45	100679	2.19	.	66
2205	45	100779	2.01	128	48
2206	45	100879	1.90	70	40
2207	45	100979	2.18	48	44
2208	45	101079	2.52	28	18
2209	45	101179	2.18	66	6
2210	45	101279	1.96	.	6
2211	45	101379	1.70	.	6
2212	45	101479	1.65	60	8
2213	45	101579	1.46	298	10
2214	45	101679	2.10	350	34
2215	45	101779	1.95	130	18
2216	45	101879	1.42	500	8
2217	45	101979	1.46	.	42
2218	45	102079	1.59	.	38
2219	45	102179	1.57	274	28
2220	45	102279	1.61	284	32
2221	45	102379	2.26	278	2
2222	45	102479	1.22	206	2
2223	45	102579	1.55	264	2
2224	45	102679	1.50	.	22
2225	45	102779	1.20	.	12
2226	45	102879	0.84	204	16
2227	45	102979	1.15	446	6
2228	45	103079	2.26	234	10
2229	45	103179	1.86	110	4
2230	45	110179	1.56	74	18
2231	45	110279	1.57	.	4
2232	45	110379	1.31	.	8
2233	45	110479	0.70	280	6
2234	45	110579	0.92	108	6
2235	45	110679	1.59	132	24
2236	45	110779	1.57	492	46
2237	45	110879	1.73	122	10
2238	45	110979	1.78	.	12
2239	45	111079	1.68	.	6
2240	45	111179	1.40	18	10
2241	45	111279	2.35	146	26
2242	45	111379	2.17	76	4
2243	45	111479	1.41	216	12
2244	45	111579	1.19	142	30
2245	45	111679	2.02	.	10
2246	45	111779	2.03	.	18
2247	45	111879	1.55	470	12
2248	45	111979	1.19	72	22
2249	45	112079	1.65	76	18
2250	45	112179	1.49	.	8
2251	45	112279	0.96	82	10
2252	45	112379	0.93	.	36
2253	45	112479	2.06	.	28
2254	45	112579	2.11	74	26
2255	45	112679	1.30	70	54
2256	45	112779	1.36	52	30

D-68

## LISTING OF PMP DATA BY POLLUTANT

43

----- POLLUTANT -----

OBS	PLANT	DATE	FLOW(MGD)	INFLUENT (PPM)	EFFLUENT (PPM)
2257	45	112879	1.48	64	14
2258	45	112979	2.01	76	10
2259	45	113079	1.93	.	14
2260	45	120179	1.77	.	10
2261	45	120279	1.63	6	6
2262	45	120379	1.56	322	6
2263	45	120479	1.36	318	20
2264	45	120579	1.93	304	36
2265	45	120679	1.54	190	6
2266	45	120779	1.80	.	28
2267	45	120879	1.65	.	18
2268	45	120979	1.37	214	10
2269	45	121079	2.14	138	2
2270	45	121179	2.12	180	4
2271	45	121279	2.03	534	6
2272	45	121379	2.21	208	16
2273	45	121479	2.23	.	34
2274	45	121579	1.73	.	22
2275	45	121679	1.80	312	26
2276	45	121779	1.78	436	14
2277	45	121879	2.09	198	22
2278	45	121979	2.20	226	4
2279	45	122079	2.22	22	14
2280	45	122179	1.95	.	16
2281	45	122279	1.52	.	12
2282	45	122379	1.55	214	8
2283	45	122479	0.99	.	14
2284	45	122579	1.04	50	34
2285	45	122679	1.65	266	24
2286	45	122779	2.09	238	2
2287	45	122879	1.93	.	46
2288	45	122979	1.70	.	46
2289	45	123079	1.24	318	42
2290	45	123179	0.95	.	4
2291	45	010180	0.74	604	4
2292	45	010280	2.06	166	18
2293	45	010380	1.93	300	4
2294	45	010480	1.57	.	2
2295	45	010580	1.43	.	2
2296	45	010680	1.62	88	4
2297	45	010780	1.70	52	2
2298	45	010880	1.61	554	4
2299	45	010980	1.74	132	4
2300	45	011080	1.60	432	2
2301	45	011180	1.72	.	6
2302	45	011280	1.82	.	2
2303	45	011380	1.80	24	4
2304	45	011480	1.60	22	2
2305	45	011580	1.59	2	4
2306	45	011680	1.55	458	2
2307	45	011780	1.53	128	6
2308	45	011880	1.87	.	32
2309	45	011980	1.39	.	28
2310	45	012080	1.35	718	18

D-69

LISTING OF PMP DATA BY POLLUTANT

D-70

----- POL = TSS -----

OBS	PLANT	DATE	FLOW(MGD)	INFLUENT (PPM)	EFFLUENT (PPM)
2311	45	012180	1.59	416	28
2312	45	012280	1.72	90	42
2313	45	012380	1.91	74	10
2314	45	012480	1.47	164	2
2315	45	012580	1.67	.	4
2316	45	012680	1.55	.	2
2317	45	012780	1.53	356	2
2318	45	012880	1.66	182	2
2319	45	012980	1.80	190	2
2320	45	013080	1.66	250	28
2321	45	013180	1.64	426	48
2322	45	020180	1.95	.	26
2323	45	020280	1.40	.	14
2324	45	020380	1.69	594	26
2325	45	020480	1.98	1336	2
2326	45	020580	1.64	472	46
2327	45	020680	1.48	482	2
2328	45	020780	1.98	504	2
2329	45	020880	1.90	.	6
2330	45	020980	2.02	.	2
2331	45	021080	1.80	260	2
2332	45	021180	1.68	380	2
2333	45	021280	2.02	206	4
2334	45	021380	2.15	20	4
2335	45	021480	1.92	50	6
2336	45	021580	1.70	.	6
2337	45	021680	2.36	.	4
2338	45	021780	2.25	456	4
2339	45	021880	1.36	422	10
2340	45	021980	1.93	74	18
2341	45	022080	2.13	256	8
2342	45	022180	1.66	294	8
2343	45	022280	1.28	.	28
2344	45	022380	1.88	.	14
2345	45	022480	1.57	262	2
2346	45	022580	2.02	392	8
2347	45	022680	1.40	398	50
2348	45	022780	1.70	422	74
2349	45	022880	1.00	256	28
2350	45	022980	1.51	.	36
2351	45	030180	1.80	.	62
2352	45	030280	1.61	404	24
2353	45	030380	2.23	432	6
2354	45	030480	1.57	420	14
2355	45	030580	1.72	346	32
2356	45	030680	1.55	326	42
2357	45	030780	2.49	.	20
2358	45	030880	2.21	.	4
2359	45	030980	1.60	28	6
2360	45	031080	1.80	300	56
2361	45	031180	2.58	2692	20
2362	45	031280	2.20	22	6
2363	45	031380	2.05	102	42
2364	45	031480	2.63	.	16

## LISTING OF FMP DATA BY POLLUTANT

45

----- POLL=TSS -----

OBS	PLANT	DATE	FLOW(MGD)	INFLUENT (PPM)	EFFLUENT (PPM)
2365	45	031580	2.48	.	8
2366	45	031680	2.18	256	8
2367	45	031780	1.53	320	2
2368	45	031880	2.03	62	18
2369	45	031980	2.23	232	14
2370	45	032080	2.40	60	26
2371	45	032180	2.51	.	2
2372	45	032280	2.08	.	4
2373	45	032380	2.23	358	2
2374	45	032480	1.55	372	2
2375	45	032580	1.55	296	58
2376	45	032680	1.68	72	2
2377	45	032780	1.67	516	32
2378	45	032880	2.18	.	22
2379	45	032980	2.52	.	22
2380	45	033080	2.17	10	14
2381	45	033180	2.00	200	10
2382	45	040180	2.07	16	4
2383	45	040280	1.54	134	48
2384	45	040380	1.53	60	36
2385	45	040480	0.41	.	40
2386	45	040580	0.60	.	38
2387	45	040680	2.33	162	30
2388	45	040790	1.76	272	2
2389	45	040880	1.85	124	36
2390	45	040980	1.86	46	8
2391	45	041090	1.83	152	18
2392	45	041180	1.77	.	24
2393	45	041280	1.77	.	30
2394	45	041380	2.04	122	14
2395	45	041480	2.08	90	12
2396	45	041580	1.67	152	94
2397	45	041680	2.80	80	8
2398	45	041780	2.51	152	18
2399	45	041880	1.82	.	24
2400	45	041980	1.50	.	34
2401	45	042080	1.70	70	44
2402	45	042180	1.99	62	42
2403	45	042280	2.01	666	4
2404	45	042380	1.53	12	2
2405	45	042480	1.44	70	6
2406	45	042580	1.43	.	24
2407	45	042680	1.42	.	18
2408	45	042780	1.48	254	20
2409	45	042880	1.45	550	2
2410	45	042980	1.76	100	20
2411	45	043080	2.05	102	48
2412	45	050180	1.72	480	4
2413	45	050280	1.41	.	2
2414	45	050380	1.89	.	2
2415	45	050480	2.29	346	4
2416	45	050580	1.60	46	14
2417	45	050680	1.91	40	2
2418	45	050780	2.30	32	2

D-71

## LISTING OF PMP DATA BY POLLUTANT

46

POL = TSS

OBS	PLANT	DATE	FLOW(MGD)	INFLUENT (PPM)	EFFLUENT (PPM)
2419	45	050880	2.14	94	18
2420	45	050980	1.42	.	4
2421	45	051080	1.32	.	2
2422	45	051180	1.25	56	2
2423	45	051280	1.66	120	2
2424	45	051380	1.88	452	72
2425	45	051480	1.93	76	38
2426	45	051580	1.53	748	48
2427	45	051680	1.66	.	6
2428	45	051780	1.79	.	2
2429	45	051880	1.60	988	4
2430	45	051980	1.22	282	56
2431	45	052080	1.23	700	54
2432	45	052180	1.17	336	2
2433	45	052280	0.87	558	20
2434	45	052380	1.26	.	18
2435	45	052480	1.61	.	10
2436	45	052580	1.13	.	18
2437	45	052680	0.85	688	112
2438	45	052780	1.30	2334	72
2439	45	052880	1.67	3758	36
2440	45	052980	0.99	930	4
2441	45	053080	1.05	.	2
2442	45	053180	1.15	.	6
2443	45	060180	1.32	590	12
2444	45	060280	1.11	278	8
2445	45	060380	1.01	378	22
2446	45	060480	0.93	1076	56
2447	45	060580	0.90	530	14
2448	45	060680	1.02	.	2
2449	45	060780	1.45	.	4
2450	45	060880	1.20	2692	6
2451	45	060980	1.24	898	72
2452	45	061080	1.45	1014	58
2453	45	061180	1.48	794	32
2454	45	061280	1.66	234	10
2455	45	061380	1.17	.	4
2456	45	061480	1.35	.	10
2457	45	061580	1.40	302	12
2458	45	061680	1.36	666	84
2459	45	061780	1.34	140	50
2460	45	061880	1.41	510	48
2461	45	061980	1.45	680	82
2462	45	062080	1.48	.	24
2463	45	062180	1.82	.	26
2464	45	062280	1.70	447	24
2465	45	062380	1.49	86	8
2466	45	062480	1.26	124	2
2467	45	062580	1.21	366	2
2468	45	062680	1.64	902	6
2469	45	062780	2.19	.	38
2470	45	062880	1.91	.	42
2471	45	062980	1.68	598	26
2472	45	063080	1.53	720	2

D-72

LISTING OF PMP DATA BY POLLUTANT

POL: TSS

OBS	PLANT	DATE	FLOW(MGD)	INFLUENT (PPM)	EFFLUENT (PPM)
2527	96	082776	2.70	.	16
2528	96	083076	2.60	.	3
2529	96	090176	2.60	.	10
2530	96	090276	2.60	.	8
2531	96	090776	1.60	.	14
2532	96	091376	2.20	.	18
2533	96	091476	2.30	.	21
2534	96	091676	2.60	.	16
2535	96	092076	2.50	.	19
2536	96	092276	2.30	.	17
2537	96	092876	2.60	.	11
2538	96	092976	2.40	.	19
2539	111	010177	1.01	.	10
2540	111	010277	0.90	.	3
2541	111	010377	1.05	.	7
2542	111	010477	0.83	70	30
2543	111	010577	0.96	90	20
2544	111	010677	0.93	100	6
2545	111	010777	0.93	.	7
2546	111	010877	0.93	.	3
2547	111	010977	0.99	.	19
2548	111	011077	0.90	.	5
2549	111	011177	0.91	80	5
2550	111	011477	1.16	.	2
2551	111	011577	0.93	.	17
2552	111	011677	1.10	.	14
2553	111	011777	1.11	.	3
2554	111	011877	0.78	40	3
2555	111	011977	0.93	70	45
2556	111	012077	0.65	80	7
2557	111	012177	1.08	.	16
2558	111	012277	1.06	.	17
2559	111	012377	1.12	.	24
2560	111	012577	0.84	60	8
2561	111	012677	0.99	50	11
2562	111	012777	0.98	70	9
2563	111	012877	1.08	.	6
2564	111	012977	0.96	.	10
2565	111	013077	0.97	.	12
2566	111	013177	0.97	.	3
2567	111	020177	0.69	65	3
2568	111	020277	0.61	75	7
2569	111	020377	0.73	70	9
2570	111	020477	0.59	.	3
2571	111	020577	1.09	.	9
2572	111	020677	1.14	.	9
2573	111	020777	1.13	.	15
2574	111	020977	0.99	52	16
2575	111	021077	0.96	55	7
2576	111	021177	0.77	.	20
2577	111	021277	0.73	.	35
2578	111	021377	0.82	.	25
2579	111	021477	0.78	.	38
2580	111	021577	0.92	40	6

D-73

LISTING OF PMP DATA BY POLLUTANT

----- POLI = TSS -----

OBS	PLANT	DATE	FLOW(MGD)	INFLUENT (PPM)	EFFLUENT (PPM)
2473	96	100875	3.2	.	28
2474	96	101375	3.2	.	46
2475	96	102775	3.2	.	43
2476	96	110375	3.3	.	18
2477	96	111075	3.3	.	15
2478	96	111475	3.1	.	3
2479	96	111875	3.4	.	4
2480	96	112575	3.4	.	2
2481	96	120275	3.4	.	18
2482	96	120475	3.3	.	12
2483	96	120775	3.4	.	7
2484	96	120875	3.4	.	9
2485	96	121275	3.0	.	17
2486	96	121575	3.0	.	33
2487	96	121675	3.0	.	16
2488	96	121875	3.1	.	9
2489	96	122275	3.3	.	9
2490	96	122975	3.5	.	19
2491	96	010776	3.4	.	8
2492	96	010976	3.4	.	12
2493	96	012076	3.4	.	10
2494	96	020576	3.3	.	15
2495	96	022476	3.4	.	8
2496	96	030276	3.5	.	13
2497	96	030976	3.2	.	4
2498	96	031176	3.1	.	10
2499	96	032676	3.2	.	6
2500	96	040576	3.4	.	5
2501	96	041276	3.0	.	3
2502	96	041976	3.5	.	11
2503	96	042376	3.1	.	20
2504	96	050476	3.1	.	11
2505	96	051376	3.0	.	8
2506	96	051976	3.1	.	5
2507	96	052576	3.1	.	12
2508	96	060376	3.0	.	6
2509	96	060776	3.0	.	14
2510	96	060976	3.1	.	5
2511	96	061576	3.1	.	7
2512	96	061876	3.0	.	10
2513	96	062476	2.9	.	9
2514	96	062976	3.1	.	11
2515	96	070876	3.0	.	4
2516	96	071276	3.0	.	10
2517	96	071576	3.0	.	20
2518	96	071976	3.0	.	14
2519	96	072276	2.8	.	7
2520	96	072676	2.9	.	6
2521	96	072876	2.8	.	6
2522	96	080476	2.8	.	11
2523	96	081276	3.1	.	6
2524	96	081676	3.1	.	3
2525	96	082376	2.7	.	6
2526	96	082676	2.8	.	11

D-74

## LISTING OF PMP DATA BY POLLUTANT

48

----- POLL=TSS -----

OBS	PLANT	DATE	FLOW(MGD)	INFLUENT(PPM)	EFFLUENT(PPM)
2527	96	082776	2.70	.	16
2528	96	083076	2.60	.	3
2529	96	090176	2.60	.	10
2530	96	090276	2.60	.	8
2531	96	090776	1.60	.	14
2532	96	091376	2.20	.	18
2533	96	091476	2.30	.	21
2534	96	091676	2.60	.	16
2535	96	092076	2.50	.	19
2536	96	092276	2.30	.	17
2537	96	092876	2.60	.	11
2538	96	092976	2.40	.	19
2539	111	010177	1.01	.	10
2540	111	010277	0.90	.	3
2541	111	010377	1.05	.	7
2542	111	010477	0.83	70	30
2543	111	010577	0.96	90	20
2544	111	010677	0.93	100	6
2545	111	010777	0.93	.	7
2546	111	010877	0.93	.	3
2547	111	010977	0.99	.	19
2548	111	011077	0.90	.	5
2549	111	011177	0.91	80	5
2550	111	011477	1.16	.	2
2551	111	011577	0.93	.	17
2552	111	011677	1.10	.	14
2553	111	011777	1.11	.	3
2554	111	011877	0.78	40	3
2555	111	011977	0.98	70	45
2556	111	012077	0.65	80	7
2557	111	012177	1.08	.	16
2558	111	012277	1.06	.	17
2559	111	012377	1.12	.	24
2560	111	012577	0.84	60	8
2561	111	012677	0.99	50	11
2562	111	012777	0.98	70	9
2563	111	012877	1.08	.	6
2564	111	012977	0.98	.	10
2565	111	013077	0.97	.	12
2566	111	013177	0.97	.	3
2567	111	020177	0.69	65	3
2568	111	020277	0.61	75	7
2569	111	020377	0.73	70	9
2570	111	020477	0.59	.	3
2571	111	020577	1.09	.	9
2572	111	020677	1.14	.	9
2573	111	020777	1.13	.	15
2574	111	020977	0.99	52	16
2575	111	021077	0.96	55	7
2576	111	021177	0.77	.	20
2577	111	021277	0.73	.	35
2578	111	021377	0.82	.	25
2579	111	021477	0.78	.	38
2580	111	021577	0.92	40	6

D-75



## LISTING OF PMP DATA BY POLLUTANT

49

----- POLL = TSS -----

OBS	PLANT	DATE	FLOW(MGD)	INFLUENT (PPM)	EFFLUENT (PPM)
2581	111	021677	0.69	45	8.0
2582	111	021777	1.00	38	12.0
2583	111	021877	0.83	.	20.0
2584	111	021977	1.09	.	50.0
2585	111	022077	0.87	.	3.0
2586	111	022177	0.90	.	7.0
2587	111	022277	0.74	45	16.0
2588	111	022377	1.14	42	16.0
2589	111	022477	1.09	50	6.0
2590	111	022577	1.19	.	4.0
2591	111	022677	1.06	.	5.0
2592	111	022777	0.90	.	5.0
2593	111	022877	0.82	.	5.0
2594	111	030177	0.74	40	0.5
2595	111	030277	0.68	43	5.0
2596	111	030377	0.43	40	13.0
2597	111	030577	0.99	.	16.0
2598	111	030677	0.88	.	6.0
2599	111	030777	0.85	.	5.0
2600	111	030877	0.73	45	5.0
2601	111	030977	0.57	40	12.0
2602	111	031077	1.15	30	4.0
2603	111	031177	1.33	.	14.0
2604	111	031277	1.31	.	4.0
2605	111	031377	1.29	.	16.0
2606	111	031477	1.01	.	4.0
2607	111	031577	1.37	20	10.0
2608	111	031677	1.01	33	71.0
2609	111	031777	1.18	35	19.0
2610	111	031877	1.07	.	6.0
2611	111	031977	1.25	.	19.0
2612	111	032077	1.21	.	11.0
2613	111	032177	1.19	.	14.0
2614	111	032277	1.11	20	1.0
2615	111	032377	1.05	18	13.0
2616	111	032477	0.96	22	7.0
2617	111	032577	0.95	.	7.0
2618	111	032777	1.07	.	6.0
2619	111	032877	1.15	.	5.0
2620	111	032977	0.98	20	15.0
2621	111	033077	0.80	30	2.0
2622	111	033177	0.95	33	2.0
2623	111	040177	0.93	.	8.0
2624	111	040277	1.04	.	8.0
2625	111	040377	1.13	.	9.0
2626	111	040477	0.93	45	5.0
2627	111	040577	1.15	35	9.0
2628	111	040677	0.74	37	5.0
2629	111	040777	1.34	.	8.0
2630	111	040877	1.22	.	9.0
2631	111	040977	1.28	.	17.0
2632	111	041077	1.17	.	13.0
2633	111	041177	1.23	.	5.0
2634	111	041277	0.92	35	2.0

D-76

LISTING OF PMP DATA BY POLLUTANT

D-77

----- POLI=TSS -----					
OBS	PLANT	DATE	FLOW(MGD)	INFLUENT (PPM)	EFFLUENT (PPM)
2635	111	041377	1.10	31	36
2636	111	041477	0.87	34	16
2637	111	041577	1.06	.	15
2638	111	041677	1.03	.	12
2639	111	041777	0.90	.	13
2640	111	041877	1.04	.	5
2641	111	041977	0.45	16	8
2642	111	042077	0.94	27	5
2643	111	042177	1.02	36	7
2644	111	042277	0.87	.	9
2645	111	042377	0.96	.	2
2646	111	042477	0.80	.	16
2647	111	042577	0.69	.	16
2648	111	042677	0.83	29	5
2649	111	042777	0.96	30	4
2650	111	042877	0.55	26	1
2651	111	043077	1.19	.	7
2652	111	050177	0.90	.	3
2653	111	050277	0.74	.	1
2654	111	050777	1.11	.	1
2655	111	050877	0.79	.	3
2656	111	050977	1.00	.	1
2657	111	051077	0.82	20	1
2658	111	051177	0.72	10	3
2659	111	051277	0.75	20	6
2660	111	051377	0.75	.	7
2661	111	051477	1.18	.	2
2662	111	051577	1.16	.	2
2663	111	051677	0.91	.	10
2664	111	051777	0.93	20	8
2665	111	051877	0.93	18	19
2666	111	051977	0.87	14	4
2667	111	052077	0.95	.	11
2668	111	052177	0.91	.	15
2669	111	052277	0.94	.	26
2670	111	052377	0.95	.	13
2671	111	052477	0.94	19	5
2672	111	052577	1.07	10	10
2673	111	052677	1.17	17	9
2674	111	052777	0.98	.	9
2675	111	052877	1.10	.	8
2676	111	052977	1.16	.	13
2677	111	053077	1.09	.	8
2678	111	053177	1.03	32	1
2679	111	060177	0.85	39	2
2680	111	060277	1.17	64	5
2681	111	060377	0.96	.	5
2682	111	060477	1.06	.	1
2683	111	060577	0.98	.	1
2684	111	060677	0.96	.	16
2685	111	060777	1.09	31	13
2686	111	060877	1.08	36	9
2687	111	060977	0.77	40	16
2688	111	061077	1.08	.	9

## LISTING OF PMP DATA BY POLLUTANT

51

----- POLL=TSS -----

OBS	PLANT	DATE	FLOW(MGD)	INFLUENT (PPM)	EFFLUENT (PPM)
2689	111	061177	0.99	.	11
2690	111	061277	0.89	.	22
2691	111	061377	1.10	.	13
2692	111	061477	0.85	15	5
2693	111	061577	0.82	21	16
2694	111	061677	0.84	19	14
2695	111	061777	0.86	.	5
2696	111	061877	0.76	.	9
2697	111	061977	0.76	.	11
2698	111	062077	0.68	.	8
2699	111	062177	0.42	35	7
2700	111	062277	0.92	40	7
2701	111	062377	1.01	45	9
2702	111	062477	0.98	.	17
2703	111	062577	0.84	.	12
2704	111	062677	1.13	.	25
2705	111	062777	1.05	.	7
2706	111	062877	1.01	37	6
2707	111	062977	0.62	42	6
2708	111	070177	1.08	.	4
2709	111	070277	0.80	.	3
2710	111	070377	0.83	.	13
2711	111	070477	0.80	.	13
2712	111	070577	0.66	58	6
2713	111	070677	0.74	45	11
2714	111	070777	0.67	29	16
2715	111	070877	0.58	.	12
2716	111	070977	0.76	.	6
2717	111	071077	0.93	.	9
2718	111	071177	0.83	.	10
2719	111	071277	0.82	60	9
2720	111	071377	0.99	40	3
2721	111	071477	1.01	54	2
2722	111	071577	0.86	.	1
2723	111	071677	0.94	.	2
2724	111	071777	0.89	.	8
2725	111	071877	0.86	.	5
2726	111	071977	0.88	43	7
2727	111	072077	0.85	50	4
2728	111	072177	0.87	44	4
2729	111	072277	0.87	.	8
2730	111	072377	1.17	.	10
2731	111	072477	1.12	.	6
2732	111	072577	1.00	.	13
2733	111	072677	0.74	27	37
2734	111	072777	0.96	26	10
2735	111	072877	0.93	37	48
2736	111	072977	0.61	.	7
2737	111	073077	1.11	.	2
2738	111	073177	1.01	.	15
2739	111	080177	0.79	.	10
2740	111	080277	1.08	34	4
2741	111	080377	1.09	43	5
2742	111	080477	1.09	50	5

D-78

LISTING OF PMP DATA BY POLLUTANT

POLLUTANT

DBS	PLANT	DATE	FLOW(MGD)	INFLUENT (PPM)	EFFLUENT (PPM)
2743	111	080577	1.20	.	9
2744	111	080677	1.15	.	5
2745	111	080777	1.27	.	16
2746	111	080877	1.11	.	5
2747	111	080977	1.03	42	5
2748	111	081077	0.93	38	25
2749	111	081177	0.92	40	9
2750	111	081277	0.97	.	2
2751	111	081377	1.07	.	5
2752	111	081477	0.90	.	5
2753	111	081577	0.88	.	2
2754	111	081677	0.99	42	1
2755	111	081777	0.87	48	7
2756	111	081877	1.16	40	32
2757	111	081977	1.02	.	5
2758	111	082077	0.96	.	26
2759	111	082177	0.91	.	4
2760	111	082277	0.83	.	1
2761	111	082377	0.75	38	2
2762	111	082477	0.74	51	6
2763	111	082677	1.11	.	18
2764	111	082777	0.85	.	6
2765	111	082877	0.97	.	2
2766	111	082977	0.81	.	6
2767	111	083077	0.85	47	2
2768	111	083177	0.80	48	10
2769	111	090177	0.76	40	7
2770	111	090277	0.95	.	8
2771	111	090377	1.06	.	6
2772	111	090477	1.06	.	2
2773	111	090577	0.88	.	5
2774	111	090677	1.00	37	6
2775	111	090777	1.01	32	1
2776	111	090877	0.84	33	3
2777	111	090977	1.23	.	9
2778	111	091077	1.03	.	3
2779	111	091177	0.85	.	1
2780	111	091277	0.88	.	14
2781	111	091377	1.15	22	1
2782	111	091477	0.97	64	5
2783	111	091577	0.67	32	1
2784	111	091677	0.80	.	2
2785	111	091777	0.91	.	3
2786	111	091877	0.78	.	6
2787	111	091977	0.84	.	7
2788	111	092077	1.10	38	6
2789	111	092177	1.12	33	6
2790	111	092277	1.30	30	3
2791	111	092377	1.05	.	7
2792	111	092477	1.31	.	4
2793	111	092577	1.10	.	5
2794	111	092677	0.74	.	10
2795	111	092777	0.67	35	3
2796	111	092877	0.95	40	14

D-79

## LISTING OF PMP DATA BY POLLUTANT

53

----- POLI=TSS -----

OBS	PLANT	DATE	FLOW(MGD)	INFLUENT (PPM)	EFFLUENT (PPM)
2797	111	092977	0.91	36	44
2798	111	093077	1.02	.	6
2799	111	100177	0.97	.	3
2800	111	100277	0.90	.	8
2801	111	100377	1.00	.	9
2802	111	100477	0.76	43	16
2803	111	100577	1.02	42	7
2804	111	100677	0.88	45	4
2805	111	100777	0.94	.	2
2806	111	100877	0.96	.	5
2807	111	100977	0.91	.	7
2808	111	101077	0.84	.	6
2809	111	101177	0.76	49	2
2810	111	101277	0.86	48	10
2811	111	101377	1.04	47	10
2812	111	101477	1.03	.	3
2813	111	101577	0.90	.	7
2814	111	101677	1.13	.	8
2815	111	101777	0.91	.	13
2816	111	101877	1.10	40	11
2817	111	101977	0.58	39	10
2818	111	102077	0.85	37	13
2819	111	102177	1.02	.	13
2820	111	102277	1.05	.	20
2821	111	102377	0.91	.	33
2822	111	102477	1.03	.	24
2823	111	102577	0.86	36	22
2824	111	102677	0.92	47	11
2825	111	102777	0.72	54	18
2826	111	102977	0.88	.	4
2827	111	103077	0.99	.	6
2828	111	103177	0.95	.	4
2829	111	110177	0.81	41	15
2830	111	110277	0.93	56	19
2831	111	110377	1.18	48	15
2832	111	110477	1.14	.	14
2833	111	110577	1.05	.	10
2834	111	110677	1.07	.	18
2835	111	110777	0.96	.	8
2836	111	110877	0.87	42	2
2837	111	110977	1.01	33	11
2838	111	111077	1.02	40	7
2839	111	111277	0.90	.	20
2840	111	111377	0.93	.	14
2841	111	111477	0.76	.	9
2842	111	111577	0.91	69	5
2843	111	111777	0.88	58	11
2844	111	111877	0.88	.	7
2845	111	112077	0.72	48	1
2846	111	112177	0.82	73	1
2847	111	112277	0.79	55	12
2848	111	112377	0.65	50	10
2849	111	112477	0.87	.	32
2850	111	112577	0.78	.	35

D-80

LISTING OF PMP DATA BY POLLUTANT

POLL=TSS

OBS	PLANT	DATE	FLOW(MGD)	INFLUENT (PPM)	EFFLUENT (PPM)
2851	111	112677	0.72	.	12
2852	111	112777	0.72	.	2
2853	111	112877	0.78	.	3
2854	111	112977	0.94	83	14
2855	111	113077	1.15	46	8
2856	111	120177	0.97	43	8
2857	111	120277	0.81	.	6
2858	111	120377	0.88	.	11
2859	111	120477	0.87	.	9
2860	111	120577	0.80	.	1
2861	111	120677	1.03	62	13
2862	111	120777	1.11	70	11
2863	111	120877	0.68	70	14
2864	111	120977	0.72	.	28
2865	111	121077	0.74	.	15
2866	111	121177	0.78	.	14
2867	111	121277	0.90	.	38
2868	111	121377	0.91	30	16
2869	111	121477	1.06	35	5
2870	111	121577	0.68	55	8
2871	111	121677	0.88	.	6
2872	111	121777	0.78	.	5
2873	111	121877	0.90	.	4
2874	111	121977	0.73	66	3
2875	111	122077	0.86	73	10
2876	111	122177	0.92	70	62
2877	111	122277	0.95	.	2
2878	111	122377	0.79	.	2
2879	111	122477	0.82	.	31
2880	111	122677	0.84	.	9
2881	111	122777	0.79	50	6
2882	111	122877	0.71	60	9
2883	111	122977	0.86	60	5
2884	111	123077	0.94	.	13
2885	111	123177	0.88	.	9
2886	126	100275	0.38	426	33
2887	126	100575	0.28	671	20
2888	126	100675	0.33	783	19
2889	126	100775	0.30	364	25
2890	126	100875	0.38	1180	38
2891	126	100975	0.34	2000	24
2892	126	101275	0.32	5988	14
2893	126	101375	0.36	7000	46
2894	126	101475	0.33	14600	23
2895	126	101575	0.43	422	30
2896	126	101675	0.49	333	26
2897	126	101975	0.38	600	23
2898	126	102075	0.32	544	29
2899	126	102175	0.33	683	10
2900	126	102275	0.31	1260	28
2901	126	102375	0.32	1220	20
2902	126	102675	0.30	453	30
2903	126	102775	0.44	443	33
2904	126	102875	0.53	447	31

D-81

## LISTING OF PMP DATA BY POLLUTANT

55

----- POLL = TSS -----

GBS	PLANT	DATE	FLOW (MGD)	INFLUENT (PPM)	EFFLUENT (PPM)
2905	126	102975	0.41	430	30
2906	126	103075	0.36	813	38
2907	126	110275	0.29	743	20
2908	126	110375	0.30	738	32
2909	126	110475	0.30	393	25
2910	126	110575	0.37	264	18
2911	126	110675	0.39	144	19
2912	126	110975	0.44	550	21
2913	126	111075	0.58	469	18
2914	126	111175	0.48	276	3
2915	126	111275	0.45	560	25
2916	126	111375	0.49	950	30
2917	126	111675	0.41	691	16
2918	126	111775	0.43	379	26
2919	126	111875	0.44	300	20
2920	126	111975	0.46	310	17
2921	126	112075	0.46	475	13
2922	126	112375	0.36	593	15
2923	126	112475	0.38	356	21
2924	126	112575	0.41	293	17
2925	126	112775	0.40	448	22
2926	126	113075	0.35	156	11
2927	126	120175	0.38	308	13
2928	126	120275	0.33	260	10
2929	126	120375	0.33	268	7
2930	126	120475	0.40	376	11
2931	126	120775	0.36	300	10
2932	126	120875	0.35	412	14
2933	126	120975	0.40	538	15
2934	126	121075	0.30	508	26
2935	126	121175	0.26	221	11
2936	126	121475	0.39	265	7
2937	126	121575	0.38	226	20
2938	126	121675	0.35	268	10
2939	126	121775	0.33	260	20
2940	126	121875	0.36	254	21
2941	126	122175	0.25	320	18
2942	126	122275	0.31	287	10
2943	126	122375	0.34	350	13
2944	126	122575	0.43	333	12
2945	126	122875	0.45	360	10
2946	126	122975	0.45	406	11
2947	126	123075	0.42	205	10
2948	126	010176	0.29	240	10
2949	126	010476	0.45	213	19
2950	126	010576	0.42	168	22
2951	126	010676	0.43	64	11
2952	126	010776	0.32	140	16
2953	126	010876	0.35	380	10
2954	126	011176	0.39	360	10
2955	126	011276	0.40	472	12
2956	126	011376	0.37	243	10
2957	126	011476	0.35	260	11
2958	126	011576	0.32	212	8

D-82

## LISTING OF PMP DATA BY POLLUTANT

56

----- POLL=TSS -----

OBS	PLANT	DATE	FLOW(MGD)	INFLUENT (PPM)	EFFLUENT (PPM)
2959	126	011876	0.30	392	11
2960	126	011976	0.34	311	14
2961	126	012076	0.35	306	11
2962	126	012176	0.36	300	10
2963	126	012276	0.33	304	10
2964	126	012576	0.39	367	6
2965	126	012676	0.35	429	10
2966	126	012776	0.35	256	11
2967	126	012876	0.36	343	34
2968	126	012976	0.44	435	29
2969	126	020176	0.45	245	12
2970	126	020276	0.34	310	38
2971	126	020376	0.37	392	15
2972	126	020476	0.38	245	13
2973	126	020576	0.41	239	10
2974	126	020876	0.46	246	11
2975	126	020976	0.42	324	15
2976	126	021076	0.35	246	3
2977	126	021176	0.37	444	17
2978	126	021276	0.34	269	4
2979	126	021676	0.35	248	20
2980	126	021776	0.34	104	3
2981	126	021876	0.36	160	10
2982	126	021976	0.41	120	11
2983	126	022276	0.27	154	17
2984	126	022376	0.31	160	10
2985	126	022476	0.33	324	11
2986	126	022576	0.21	168	10
2987	126	022676	0.30	143	12
2988	126	022976	0.29	322	10
2989	126	030176	0.25	123	5
2990	126	030276	0.31	367	12
2991	126	030376	0.33	139	10
2992	126	030476	0.29	161	8
2993	126	030776	0.23	300	21
2994	126	030876	0.38	236	14
2995	126	030976	0.45	216	10
2996	126	031076	0.37	224	11
2997	126	031176	0.39	144	11
2998	126	031476	0.24	256	25
2999	126	031576	0.33	416	11
3000	126	031676	0.40	197	24
3001	126	031776	0.35	126	15
3002	126	031876	0.29	233	14
3003	126	032176	0.26	186	21
3004	126	032276	0.25	148	39
3005	126	032376	0.26	160	29
3006	126	032476	0.27	2089	38
3007	126	032576	0.27	2370	51
3008	126	032876	0.26	400	30
3009	126	032976	0.32	393	50
3010	126	033076	0.39	328	24
3011	126	033176	0.51	268	39
3012	126	040176	0.44	1054	23

D - 83



## LISTING OF PMP DATA BY POLLUTANT

57

----- POLL=TSS -----

OBS	PLANT	DATE	FLOW(MGD)	INFLUENT (PPM)	EFFLUENT (PPM)
3013	126	040476	0.38	179	11
3014	126	040576	0.30	260	14
3015	126	040676	0.23	499	16
3016	126	040776	0.26	514	27
3017	126	040876	0.25	347	20
3018	126	041176	0.23	952	53
3019	126	041276	0.23	231	42
3020	126	041376	0.26	205	31
3021	126	041476	0.27	171	47
3022	126	041876	0.26	148	49
3023	126	041976	0.33	133	61
3024	126	042076	0.36	129	28
3025	126	042176	0.33	340	50
3026	126	042276	0.33	324	54
3027	126	042576	0.31	196	58
3028	126	042676	0.33	435	80
3029	126	042776	0.28	258	50
3030	126	042876	0.29	244	75
3031	126	042976	0.31	144	46
3032	126	050276	0.33	190	56
3033	126	050376	0.36	224	38
3034	126	050476	0.39	214	45
3035	126	050576	0.30	236	44
3036	126	050676	0.40	566	38
3037	126	050976	0.33	710	40
3038	126	051076	0.37	364	18
3039	126	051176	0.38	507	40
3040	126	051276	0.32	390	30
3041	126	051376	0.43	393	22
3042	126	051676	0.19	200	24
3043	126	051776	0.36	313	36
3044	126	051876	0.35	140	29
3045	126	051976	0.34	325	25
3046	126	052076	0.34	500	35
3047	126	052376	0.25	295	27
3048	126	052476	0.20	1325	26
3049	126	052576	0.22	1266	23
3050	126	052676	0.20	1692	25
3051	126	052776	0.26	430	37
3052	126	053176	0.20	1700	12
3053	126	060176	0.25	400	35
3054	126	060276	0.41	525	36
3055	126	060376	0.27	1270	80
3056	126	060676	0.23	1740	34
3057	126	060776	0.23	1400	32
3058	126	060876	0.23	2988	70
3059	126	060976	0.24	1614	38
3060	126	061076	0.27	350	31
3061	126	061376	0.27	230	25
3062	126	061476	0.41	103	11
3063	126	061576	0.28	400	40
3064	126	061676	0.38	213	13
3065	126	061776	0.45	163	14
3066	126	062076	0.37	225	29

D-84

LISTING OF PMF DATA BY POLLUTANT

POLL=TSS

OBS	PLANT	DATE	FLOW(MGD)	INFLUENT (PPM)	EFFLUENT (PPM)
3067	126	062176	0.42	480	11
3068	126	062276	0.50	922	28
3069	126	062376	0.43	5160	22
3070	126	062476	0.37	2456	47
3071	126	062776	0.33	520	20
3072	126	062876	0.37	480	11
3073	126	062976	0.39	341	24
3074	126	063076	0.35	292	19
3075	126	070176	0.27	307	20
3076	126	070576	0.28	400	22
3077	126	070676	0.30	200	30
3078	126	070776	0.42	1170	22
3079	126	070876	0.38	188	18
3080	126	071176	0.27	112	12
3081	126	071276	0.29	333	50
3082	126	071376	0.25	343	50
3083	126	071476	0.30	327	35
3084	126	071576	0.37	208	57
3085	126	071876	0.29	.	13
3086	126	071976	0.28	480	25
3087	126	072076	0.28	250	13
3088	126	072176	0.28	230	11
3089	126	072276	0.37	413	27
3090	126	072576	0.38	.	11
3091	126	072676	0.41	292	31
3092	126	072776	0.46	206	21
3093	126	072876	0.38	143	15
3094	126	072976	0.72	117	20
3095	126	080176	0.41	192	21
3096	126	080276	0.33	176	10
3097	126	080376	0.35	208	20
3098	126	080476	0.33	500	28
3099	126	080576	0.37	378	18
3100	126	080876	0.33	295	15
3101	126	080976	0.31	152	12
3102	126	081076	0.28	381	11
3103	126	081176	0.28	240	13
3104	126	081276	0.36	190	15
3105	126	081576	0.40	565	25
3106	126	081676	0.43	358	43
3107	126	081776	0.35	542	49
3108	126	081876	0.33	387	20
3109	126	081976	0.31	230	21
3110	126	082276	0.21	295	18
3111	126	082376	0.24	540	31
3112	126	082476	0.25	263	19
3113	126	082576	0.29	500	23
3114	126	082676	0.37	280	14
3115	126	082976	0.28	160	19
3116	126	083076	0.32	393	39
3117	126	083176	0.36	445	28
3118	126	090176	0.42	390	19
3119	126	090276	0.54	875	15
3120	126	090676	0.33	413	9

D-85

## LISTING OF PMP DATA BY POLLUTANT

59

----- POI L=TSS -----

OBS	PLANT	DATE	FLOW(MGD)	INFLUENT(PPM)	EFFLUENT(PPM)
3121	126	090776	0.46	226	16
3122	126	090876	0.38	313	9
3123	126	090976	0.30	299	17
3124	126	091276	0.43	400	15
3125	126	091376	0.52	430	13
3126	126	091476	0.55	347	17
3127	126	091576	0.63	313	40
3128	126	091676	0.45	1083	37
3129	126	091976	0.34	360	20
3130	126	092076	0.47	131	11
3131	126	092176	0.53	133	14
3132	126	092276	0.52	182	17
3133	126	092376	0.47	362	10
3134	126	092676	0.45	400	10
3135	126	092776	0.53	310	21
3136	126	092876	0.49	345	7
3137	126	092976	0.38	230	11
3138	126	093076	0.47	839	48

**APPENDIX II B**

**Summary Statistics for PMP Data**

SUMMARY STATISTICS ON TSP DATA BY POLLUTANT  
INFLUENT AND EFFLUENT CONCENTRATION (PPM)

1

----- POLL=BOD -----

PLANT	NINF	MEANINF	MEDINF	STDINF	MININF	MAXINF	NEFF	MEANEFF	MEDEFF	STDEFF	MINEFF	MAXEFF
9	23	84.74	59	61.779	9	226	24	5.70833	5.0	2.83578	1.0	14
44	45	754.00	710	259.794	225	1689	261	8.86590	8.0	5.04148	1.0	31
45	148	381.14	369	132.375	55	760	156	3.04487	3.0	1.90532	1.0	12
96	0	.	.	.	.	.	105	2.36190	2.0	1.87146	1.0	11
111	157	94.82	95	38.166	24	340	157	6.19108	5.0	3.43462	2.0	20
126	247	1087.47	1000	534.181	300	2600	249	5.96225	4.7	4.01444	0.6	20

----- POLL=OAG -----

PLANT	NINF	MEANINF	MEDINF	STDINF	MININF	MAXINF	NEFF	MEANEFF	MEDEFF	STDEFF	MINEFF	MAXEFF
3	157	41.1385	32.0	40.3825	2.3	312.0	46	13.0261	12.25	8.6642	0.4	31
61	234	17.3932	14.0	17.1321	2.0	230.0	348	14.5833	11.00	17.9715	1.0	266
124	59	22.9017	17.3	19.0899	0.4	103.2	100	5.1670	2.65	7.1238	0.1	36
170	203	79.2773	66.0	55.2835	12.0	409.0	163	10.7859	9.60	6.9133	0.6	39

----- POLL=TSS -----

PLANT	NINF	MEANINF	MEDINF	STDINF	MININF	MAXINF	NEFF	MEANEFF	MEDEFF	STDEFF	MINEFF	MAXEFF
9	24	27.25	23.5	16.43	4	57	24	29.0917	20.5	15.1753	6.0	59
44	249	3780.76	1040.0	7466.80	18	69600	260	14.4615	6.0	47.6527	1.0	680
45	257	304.32	202.0	410.49	2	3758	364	17.9945	10.0	17.9430	2.0	112
96	0	.	.	.	.	.	66	12.2273	10.5	8.3974	2.0	40
111	148	42.84	40.0	16.32	10	100	347	10.0735	8.0	9.2436	0.5	71
126	251	557.00	324.0	1155.43	64	14600	253	23.1344	20.0	14.1249	3.0	60

D-88

APPENDIX II C

Probit Plots for PMP Oil and Grease Data

PROBABILITY PLOT OF OIL & GREASE (PPM)  
PLANT=3

PLOT OF EFFLUENT\*PROBIT      LEGEND: A = 1 OBS, B = 2 OBS, ETC.

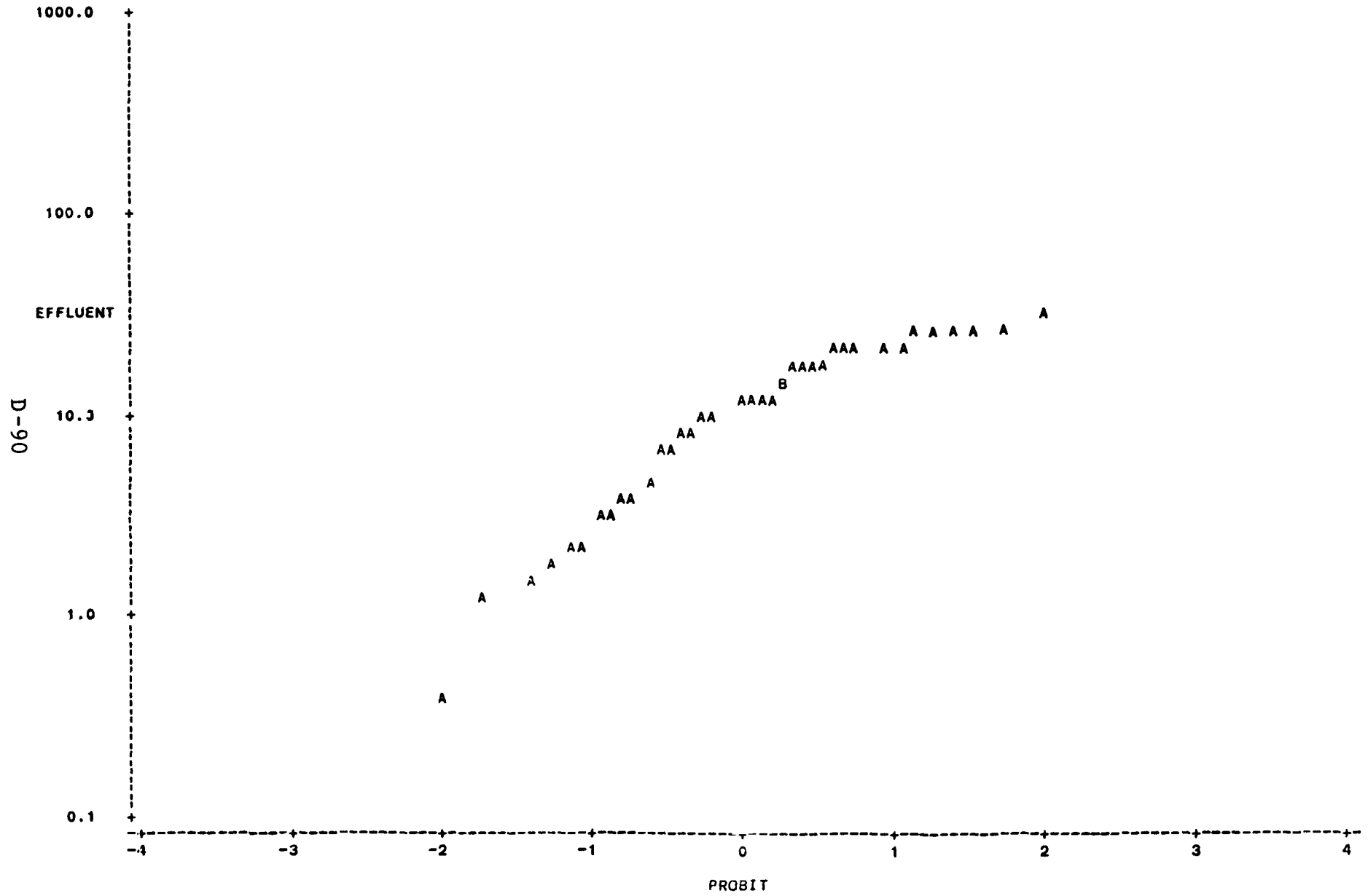

PROBABILITY PLOT OF OIL & GREASE (PPM)  
PLANT=61

PLOT OF EFFLUENT\*PROBIT      LEGEND: A = 1 OBS. B = 2 OBS. ETC.

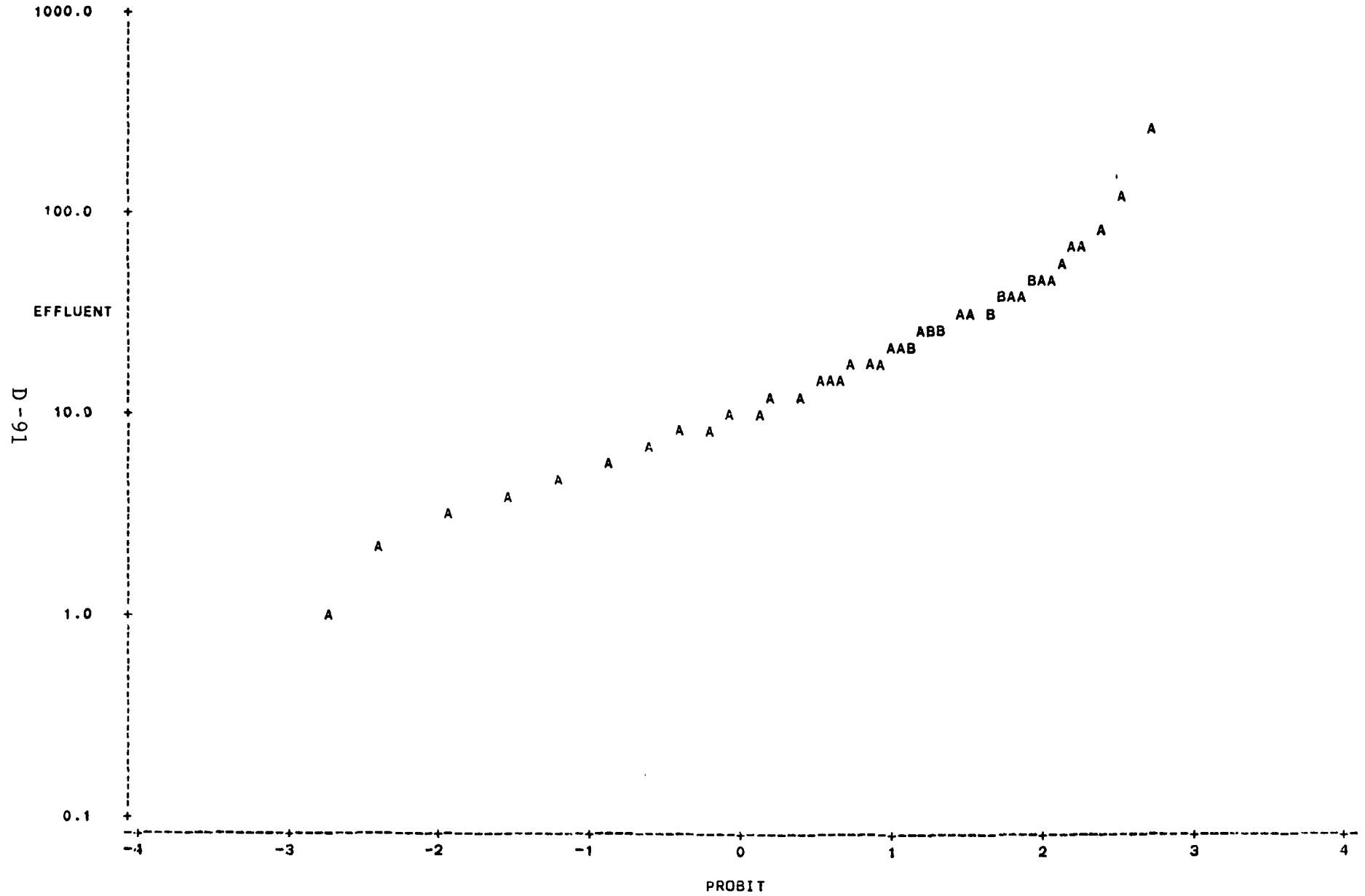



PROBABILITY PLOT OF OIL & GREASE (PPM)  
PLANT=124

PLOT OF EFFLUENT\*PROBIT      LEGEND: A = 1 OBS. B = 2 OBS. ETC.

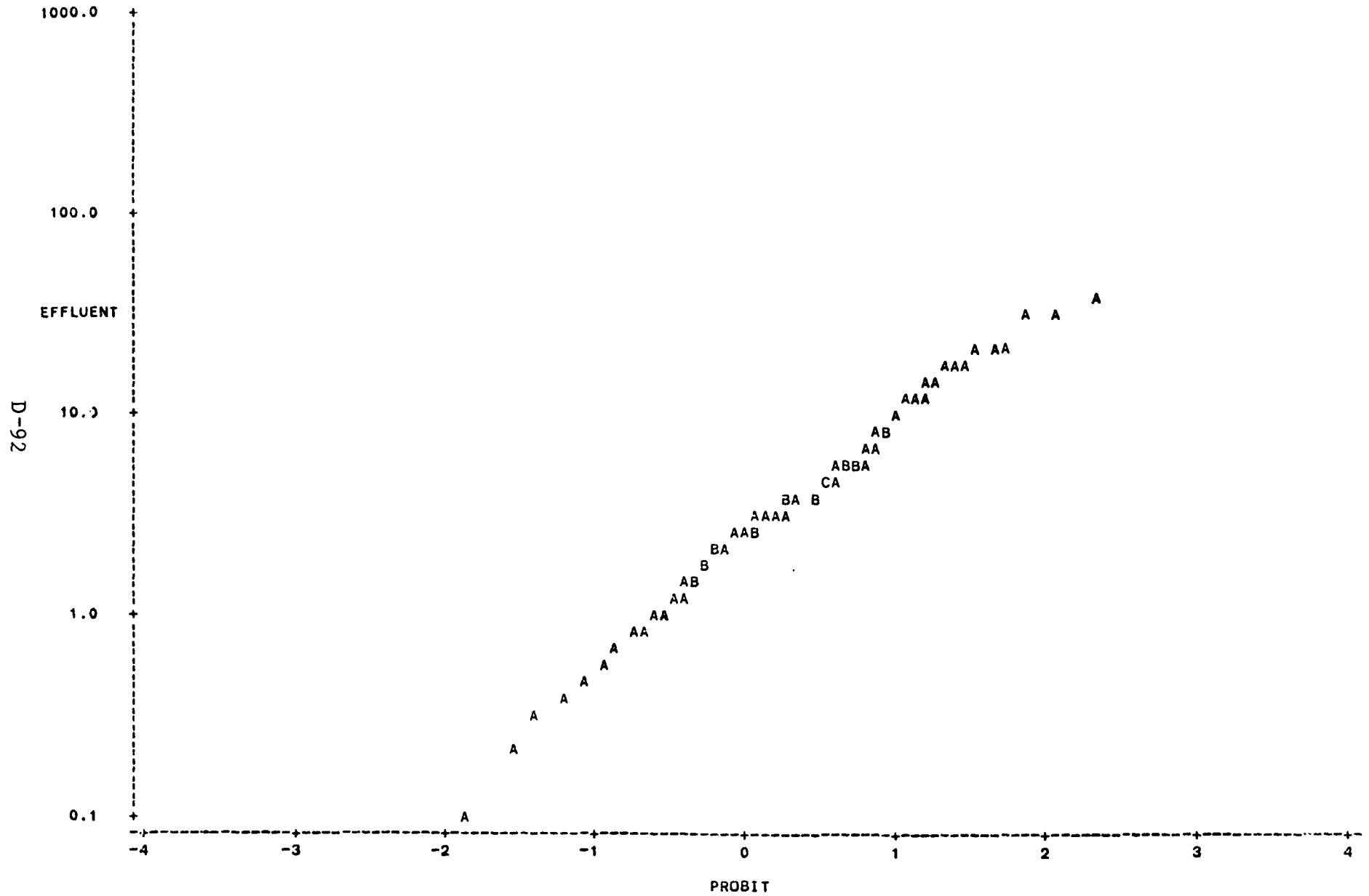

PROBABILITY PLOT OF OIL & GREASE (PPM)  
PLANT #170

PLOT OF EFFLUENT\*PRCBIT      LEGEND: A = 1 OBS. B = 2 OBS. ETC.

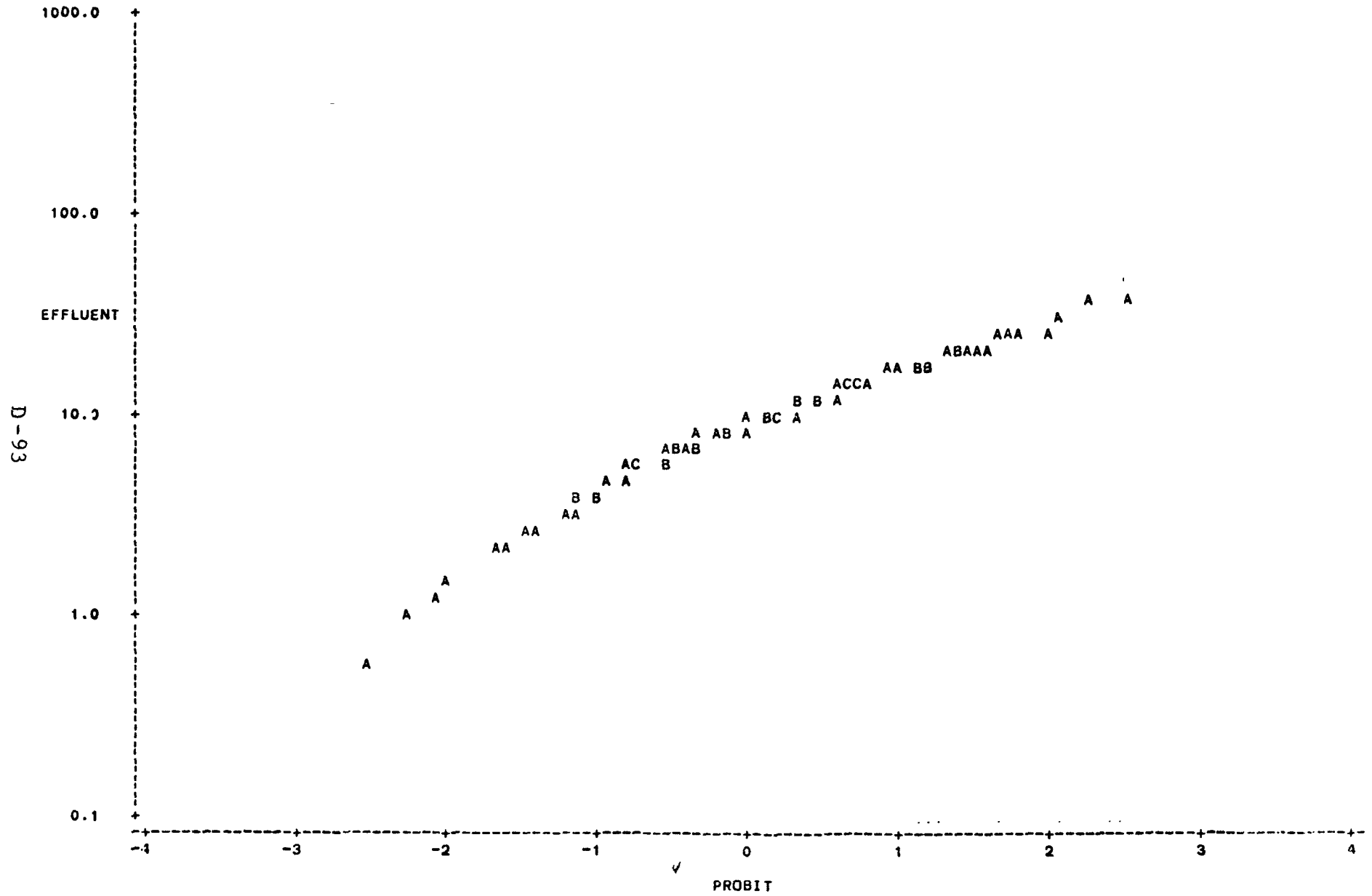

APPENDIX III

Statistical Procedures

Statistical ProceduresDescriptive Statistics

Some of the more commonly employed descriptive statistics are defined as follows:

- (1) N - number of valid observations used in a particular analysis (e.g., the total number of effluent samples at a particular plant for a particular pollutant)

(2) Mean - arithmetic average:  $\bar{X} = \sum_{i=1}^N X_i / N$

(3) Variance - standard unbiased estimate:  $s^2 = \frac{1}{N-1} \sum_{i=1}^N (X_i - \bar{X})^2$

Log-variance - variance with  $X_i = \log_e$  (observation)

Daily variability factors depend directly on the log-variance (see the section of this Appendix below on Variability Factors).

(The standard deviation is  $S = \sqrt{s^2}$ .)

- (4) Minimum - the smallest value in a set of N observations.
- (5) Maximum - the largest value in a set of N observations.
- (6) Range - the minimum subtracted from the maximum.
- (7) Median - the middle value in a set of N observations. If N is odd ( $N = 2k - 1$  for some integer k), the median is the kth order statistic, C(k). If N is even ( $N = 2k$ ), the median is

$$[C(k) + (C(k + 1))]/2$$

- (8) Stream Average - flow weighted average of sample concentrations

$$\bar{X} = \sum W_i X_i$$

where

$$W_i = f_i / \sum f_i$$

for sample concentration  $X_i$  and stream flow  $f_i$ .

- (9) Plant Average - flow weighted averages of stream concentrations

$$\bar{X} = \sum W_i X_i$$

where

$$W_i = f_i / \sum f_i$$

for sample average concentration  $x_i$  and stream average  $f_i$ .  
When flows are missing the plant average is the plant mean.

#### Goodness-of-Fit

The goodness-of-fit of the lognormal model for the O&G effluent data (PMP) was checked through a graphical procedure called a probability plot. Let  $X_1, \dots, X_n$  denote the  $n$  observation daily values for the parameter of interest (the BOD or measurements from a given plant). Denote the  $r$ th largest of the  $n$  values by  $X_{(r)}$ , and define a corresponding score called the "probit" by

$$\text{Probit } [X_{(r)}] = \Phi^{-1} [r/(n + 1)],$$

where  $\Phi^{-1}(\cdot)$  is the inverse of the standard normal cumulative distribution function. The probit score is the normal deviation ( $z$ -value) equivalent to the value  $X_{(r)}$ . Probit scores are useful because plots of  $X$  values versus corresponding probit scores tend to be straight lines when  $X$  is normally distributed; this fact is the basis for probability plots. If  $X$  has a lognormal distribution, a log-scale plot of  $X$  values versus probit scores tends to be a straight line. Daniel and Wood (1971) give simulated examples of probability plots to indicate the degree of random departure from a straight line to expect for different sample sizes when  $X$  is normally distributed. Probability plots for BOD and TSS are presented in Figures B-1 to B-28 of the BPT Development Document. Similar plots for O&G are presented in Appendix IIC of this memorandum.

Based on the probability plots, it was concluded that the lognormal distribution was a reasonable model for the PMP oil and grease effluent data.

#### Variability Factors for the Cleaning Subcategory

Assuming that the distribution of the concentration  $c$  is lognormal, then  $y = \log(c)$  is normally distributed with mean  $\mu$  and variance  $\sigma^2$  (Aitchison and Brown, pages 8-9). Thus, the 99th percentile on the natural log scale is

$$y_{0.99} = \mu + 2.326 \sigma,$$

and the 99th percentile on the concentration scale is

$$c_{0.99} = \exp(y_{0.99}) = e^{\mu + 2.326 \sigma}.$$

The mean and variance on the concentration scale are:

$$\mu_c = e^{\mu + 1/2 \sigma^2}$$

and

$$\sigma_c^2 = e^{2\mu} + \sigma^2 (e^{\sigma^2} - 1).$$

Hence, the daily maximum variability factor under the lognormal model is

$$VF(1) = \frac{c_{0.99}}{\bar{\mu}_c} = \exp(2.326 \sigma - 0.5 \sigma^2). \quad (2)$$

Estimates of any of the above quantities are calculated by substituting the mean and variance of natural logs of the observations for  $\mu$  and  $\sigma^2$ , respectively. Consequently, the daily maximum variability factors depends directly on the log-variance of the concentration.

Variability factors for 30-day average concentrations,  $VF(30)$ , are based on the distribution of an average of values drawn from the distribution of daily values and take day-to-day correlation into account. Positive autocorrelation between concentrations measured on consecutive days means that such concentrations tend to be similar. The following formulas incorporate the autocorrelation between concentrations values measured on adjacent days.

The correlation ( $\rho$ ) between adjacent days' measurements (i.e., the lag-1 autocorrelation) was estimated using the available data. Then using the first-order autoregressive model commonly found to be appropriate in water pollution modeling, the mean and variance of an average of  $n$  daily values, denoted by  $\bar{c}$ , were approximated by:

$$\bar{\mu}_c = \exp(\mu + \sigma^2/2) \quad (3)$$

and

$$\sigma_c^2 = \frac{\sigma^2}{n} f_n(\rho), \quad (4)$$

with

$$f_n(\rho) = 1 + (2/n) \sum_{k=1}^{n-1} (n-k)(\exp(\rho^k \sigma^2) - 1)/(\exp \sigma^2 - 1).$$

It can be seen in (4) that  $\sigma_c^2$  equals the variance of an average of  $n$  uncorrelated observations,  $\sigma^2/n$ , multiplied by a factor,  $f_n(\rho)$  that adjusts for the presence of autocorrelation. For oil and grease effluent data, the estimate for the lag-1 autocorrelation between logs of the concentration measurements was 0.5095 and the adjustment factor is 2.665.

Similar adjustments were made in the Organics BPT Development Document for BOD<sub>5</sub> and TSS concentration values.

Finally, since  $\bar{c}$  is approximately normally distributed by the Central Limit Theorem, the 95th percentile and variability factors of a 30-day average are approximately

$$\bar{c}_{0.99} = \mu_{\bar{c}} + 1.645 \sigma_{\bar{c}} \quad (5)$$

and

$$\begin{aligned} \text{VF}(30) &= \bar{c}_{0.95} / \mu_{\bar{c}} \\ &= 1 + 1.645 [e^{\sigma^2} - 1] f_{30}(\rho) / 30]^{1/2} \quad (6) \end{aligned}$$

with  $\mu_{\bar{c}}$  and  $\sigma_{\bar{c}}^2$  defined by equations (3) and (4). Estimates of  $\bar{c}_{0.95}$  or VF(30) are calculated by substituting estimates of  $\mu$ ,  $\sigma^2$ , and  $\rho$  into the formulas above.

References

Aitchison, J., and J.A.C. Brown (1957). The Lognormal Distribution, Cambridge University Press, London, 8-9.

Daniel, C., and F.S. Wood (1971). Fitting Equations to Data, Wiley, New York, 34-43.



#### APPENDIX IV

- A) Statistical Procedures for Calculation of a 99th Percentile Limitations for the PM&F Subcategory: Contact Cooling and Heating
- B) Statistical Procedure for Calculation of the TSS Effluent Concentration Limits for the PM&F Subcategory: Finishing Water

IV.A. Statistical Procedures for Calculation of a 99th Percentile Limitations for the PM&F Subcategory: Contact Cooling and Heating

For the PM&F contact cooling and heating water subcategory the 99th percentile limitations use the weights for process-type and the process flow within the process-type. To do this each process stream is assigned a weight that is the product of the weight for the process type and the flow weight normalized within the process-type. These weights (Table IV.A.1) are designated by  $w_i$  ( $i = 1, 2, \dots, k$ ) where  $k$  is the number of process streams. An example of computation of the weights is shown in the text of this memorandum. Within a stream, pollutant values were assumed to follow the lognormal distribution.

To use the log-normal with the PM&F process data, we estimate the log-normal parameters  $\mu_i$  and  $\sigma_i^2$  for each process stream. Generally, for  $n_i$  observations on the  $i$ th stream, the log mean is

$$\hat{\mu}_i = \sum_{j=1}^{n_i} \ln X_{ij} / n_i$$

and the log-variance  $\hat{\sigma}_i^2$  is the within process type pooled estimate of  $\sigma^2$ . This is obtained by computing the sum of squares  $SS_i$ , for each stream in a process type

$$SS_i = \sum_{j=1}^{n_i} (\ln X_{ij} - \hat{\mu}_i)^2$$

and the corresponding degrees of freedom,  $v_i = n_i - 1$ . To obtain the pooled estimate for  $\sigma^2$  for a process type, we sum the sum of squares and corresponding degrees of freedom for each process stream. Then,

$$\sigma^2_{\text{process-type}} = SS_{\text{process-type}} / \text{D.F.}_{\text{process-type}}$$

Pooled estimates for the log-variance of each process type were used because there were at most three data values for a process stream. By assuming processes of the same type have similar log-variances, a more reliable estimate is obtained for  $\sigma^2$ .

When the total degrees of freedom, D.F., for all streams within a process-type is zero, the ratio of the total sum of squares and the total degrees of freedom over all streams in the subcategory is used to estimate pooled variance for the subcategory. The pooled variance estimate for the subcategory is then used for process-types with zero degrees of freedom.

The 99th percentile estimate is the solution,  $x_{99}$ , of

$$0.99 = \int_0^{x_{99}} f(x) dx,$$

where

$$f(x) = \sum_{i=1}^k w_i f_i(x, \hat{\mu}_i, \hat{\sigma}_i^2)$$

and the component density functions denoted by  $f_i$  are log-normal with estimated parameters  $\hat{\mu}_i$  and  $\hat{\sigma}_i^2$ , respectively. The solution  $x_{99}$ , found iteratively, is the 99th percentile of the mixture distribution  $f(x)$ . A summary of the weights  $w_i$ , and parameters estimates  $\hat{\mu}_i$  and  $\hat{\sigma}_i^2$  is given in Table IV A.1.

The expected value,  $E$ , and the variance,  $V$ , for the log-normal component distributions,  $f_i$  are

$$E_i = \exp(\hat{\mu}_i + 0.5 \hat{\sigma}_i^2)$$

$$V_i = E_i^2 (\exp \hat{\sigma}_i^2 - 1).$$

TABLE IV.A.1

A SUMMARY OF THE WEIGHTS, AND LOGNORMAL PARAMETER ESTIMATES BY PROCESS STREAM USED TO CALCULATE THE 99TH PERCENTILES OF THE MIXTURE DISTRIBUTION FOR BOD<sub>5</sub>, O&G AND TSS IN THE CONTACT COOLING AND HEATING WATER SUBCATEGORY

PM&F LIMITATIONS COMPUTED  
AS ITERATED SUBCATEGORY 99TH PERCENTILE  
FOR CONTACT COOLING AND HEATING SUBCATEGORY  
STREAMS M-1 AND M-2 DELETED

POLLUTANT = BOD5

POOLED SIGMA = 0.5224

PROCESS	STREAM	WEIGHT	MU	D.F.	SIGMA
CALEND	B-2	0.0009	1.6094	0	0.3406
CALEND	E-2	0.0072	1.9459	2	0.3406
CALEND	F-1	0.0012	2.2282	2	0.3406
CAST	P-1	0.0140	0.8329	0	0.5224
EXTRUDE	B-1	0.0027	1.6094	0	0.6794
EXTRUDE	D-3	0.0003	1.6823	0	0.6794
EXTRUDE	E-3	0.1182	0.8987	2	0.6794
EXTRUDE	F-6	0.0067	1.3540	1	0.6794
EXTRUDE	G-1	0.0046	1.6823	0	0.6794
EXTRUDE	K-2	0.0133	1.6094	2	0.6794
EXTRUDE	K-3	0.0067	1.6094	2	0.6794
EXTRUDE	K-4	0.4874	1.6094	2	0.6794
EXTRUDE	N-2	0.0001	2.3026	0	0.6794
EXTRUDE	N-3	0.0031	1.7918	0	0.6794
EXTRUDE	O-1	0.0082	1.6823	0	0.6794
EXTRUDE	O-2	0.0061	1.6823	0	0.6794
EXTRUDE	R-1	0.0130	1.7918	0	0.6794
EXTRUDE	R-2	0.1823	1.3863	0	0.6794
MOLD	B-4	0.0000	1.6094	0	0.0667
MOLD	C-1	0.0002	4.5079	2	0.0667
MOLD	J-1	0.0673	1.6094	0	0.0667
MOLD	J-2	0.0050	3.9890	0	0.0667
THERM	F-2	0.0211	1.9904	2	0.0771
OTHERS		0.0304	2.0475	0	0.5224

THE 99TH PERCENTILE IS 26.1148

TABLE IV.A.1

A SUMMARY OF THE WEIGHTS, AND LOGNORMAL PARAMETER ESTIMATES BY  
 PROCESS STREAM USED TO CALCULATE THE 99TH PERCENTILES OF THE  
 MIXTURE DISTRIBUTION FOR BOD<sub>5</sub>, O&G AND TSS IN THE  
 CONTACT COOLING AND HEATING WATER SUBCATEGORY

PM&F LIMITATIONS COMPUTED  
 AS ITERATED SUBCATEGORY 99TH PERCENTILE  
 FOR CONTACT COOLING AND HEATING SUBCATEGORY  
 STREAMS M-1 AND M-2 DELETED

POLLUTANT = O&G

POOLED SIGMA = 0.4078

PROCESS	STREAM	WEIGHT	MU	D.F.	SIGMA
CALEND	B-2	0.0009	1.3863	0	0.6179
CALEND	E-2	0.0072	2.8197	2	0.6179
CALEND	F-1	0.0012	0.4621	2	0.6179
CAST	P-1	0.0140	0.5493	1	0.7768
EXTRUDE	B-1	0.0027	1.3863	0	0.1022
EXTRUDE	D-3	0.0003	1.3863	0	0.1022
EXTRUDE	E-3	0.1182	3.0953	2	0.1022
EXTRUDE	F-6	0.0067	1.4979	1	0.1022
EXTRUDE	G-1	0.0046	1.3863	1	0.1022
EXTRUDE	K-2	0.0133	1.3863	2	0.1022
EXTRUDE	K-3	0.0067	1.3863	2	0.1022
EXTRUDE	K-4	0.4874	1.3863	2	0.1022
EXTRUDE	N-2	0.0001	1.6094	0	0.1022
EXTRUDE	N-3	0.0031	1.0986	0	0.1022
EXTRUDE	O-1	0.0082	1.6094	0	0.1022
EXTRUDE	O-2	0.0061	1.0986	0	0.1022
EXTRUDE	R-1	0.0130	1.7918	0	0.1022
EXTRUDE	R-2	0.1823	2.0794	0	0.1022
MOLD	B-4	0.0000	1.9459	0	0.5600
MOLD	C-1	0.0002	3.7432	2	0.5600
MOLD	J-1	0.0673	2.3979	0	0.5600
MOLD	J-2	0.0050	4.1109	0	0.5600
THERM	F-2	0.0211	1.3540	1	0.3612
OTHERS		0.0304	2.4068	0	0.4078

-----  
 THE 99TH PERCENTILE IS 28.6541

TABLE IV.A.1

A SUMMARY OF THE WEIGHTS, AND LOGNORMAL PARAMETER ESTIMATES BY PROCESS STREAM USED TO CALCULATE THE 99TH PERCENTILES OF THE MIXTURE DISTRIBUTION FOR BOD<sub>5</sub>, O&G AND TSS IN THE CONTACT COOLING AND HEATING WATER SUBCATEGORY

PM&F LIMITATIONS COMPUTED  
AS ITERATED SUBCATEGORY 99TH PERCENTILE  
FOR CONTACT COOLING AND HEATING SUBCATEGORY  
STREAMS M-1 AND M-2 DELETED

POLLUTANT = TSS

POOLED SIGMA = 0.4936

PROCESS	STREAM	WEIGHT	MU	D.F.	SIGMA
CALEND	B-2	0.0009	1.3863	0	0.3538
CALEND	E-2	0.0072	1.0594	2	0.3538
CALEND	F-1	0.0012	1.4999	2	0.3538
CAST	P-1	0.0140	0.6931	0	0.4936
EXTRUDE	B-1	0.0027	1.3863	0	0.4249
EXTRUDE	D-3	0.0003	1.3863	0	0.4249
EXTRUDE	E-3	0.1182	1.0594	2	0.4249
EXTRUDE	F-6	0.0067	1.9636	1	0.4249
EXTRUDE	G-1	0.0046	2.2387	1	0.4249
EXTRUDE	K-2	0.0133	1.5214	2	0.4249
EXTRUDE	K-3	0.0067	1.3863	2	0.4249
EXTRUDE	K-4	0.4874	1.3863	2	0.4249
EXTRUDE	N-2	0.0001	1.9636	0	0.4249
EXTRUDE	N-3	0.0031	1.9636	0	0.4249
EXTRUDE	O-1	0.0082	1.9636	0	0.4249
EXTRUDE	O-2	0.0061	1.9636	0	0.4249
EXTRUDE	R-1	0.0130	1.9636	0	0.4249
EXTRUDE	R-2	0.1823	1.9636	0	0.4249
MOLD	B-4	0.0000	1.3863	0	0.9380
MOLD	C-1	0.0002	3.9595	2	0.9380
MOLD	J-1	0.0673	1.3863	0	0.9380
MOLD	J-2	0.0050	3.5835	0	0.9380
THERM	F-2	0.0211	0.2310	2	0.4002
OTHERS		0.0304	1.8037	0	0.4936

-----  
THE 99TH PERCENTILE IS 19.1426

IV. B. Statistical Procedure for Calculating the TSS Effluent Concentration Limits for the PM&F Subcategory: Finishing Water

The lognormal 99th percentile for the i-th stream in the finishing water PM&F subcategory is

$$L_i = \exp(\hat{\mu}_i + 2.326 \hat{\sigma}_i)$$

where  $\hat{\mu}_i$  and  $\hat{\sigma}_i$  are the estimated log-mean and the log-variance for the i-th stream in the finishing water subcategory. A pooled log-variance was used for the finishing subcategory because of the small number of degrees of freedom for each stream.

The lognormal expectation for the i-th stream is

$$E_i = \exp(\hat{\mu}_i + 0.5 \hat{\sigma}_i^2)$$

and the lognormal variance for the i-th stream is

$$V_i = E_i^2 (\exp \hat{\sigma}_i^2 - 1).$$

The daily variability factor is

$$VF(1) = (\sum w_i L_i) / (\sum w_i E_i)$$

where  $w_i$  is the flow weight for the i-th stream normalized so that

$$\sum w_i = 1.$$

That is

$$w_i = f_i / \sum f_i$$

where  $f_i$  is the average flow for the i-th stream. In this case, the daily variability factor is

$$\begin{aligned} VF(1) &= \exp(2.326 \hat{\sigma} - 0.5 \hat{\sigma}^2) \\ &= 8.1 \end{aligned}$$

because the pooled estimate,  $\hat{\sigma} = 1.216$ , is used.

The 30-day variability factors based on the central limit theorem approximation for an average of 30 samples is

$$\begin{aligned} VF(30) &= 1 + 1.6449(v/30)^{.5}/E \\ &= 2.3 \end{aligned}$$

where

$$E = \sum w_i E_i = 102.4 \text{ mg/l,}$$