

Proklima International

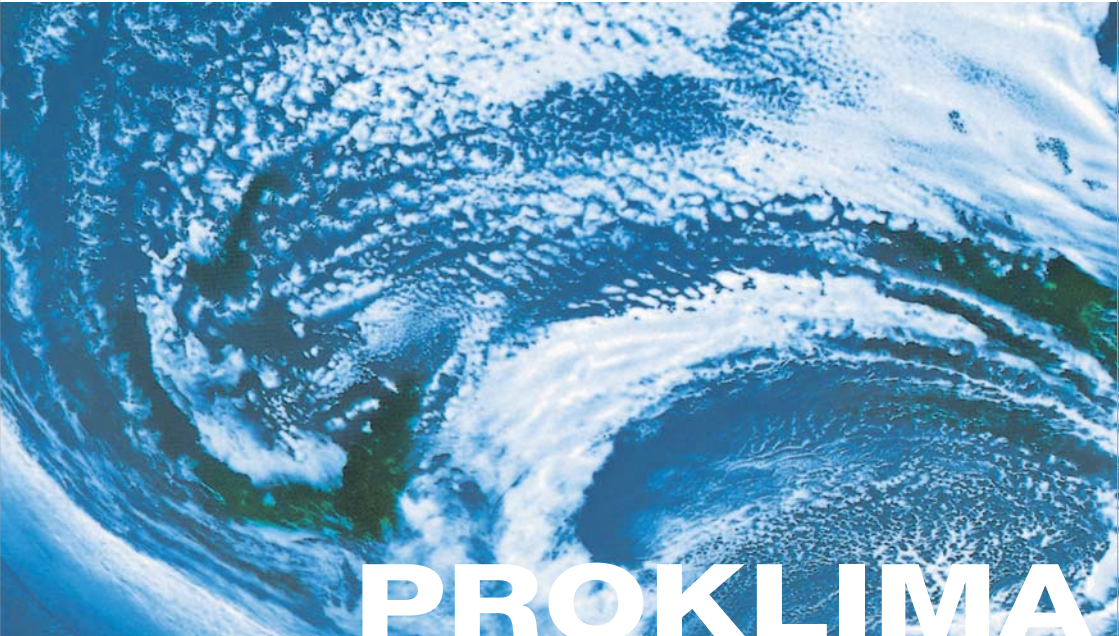

# PROKLIMA

## Natural Refrigerants

Sustainable Ozone- and Climate-Friendly Alternatives to HCFCs



Proklima International

# Natural Refrigerants

Sustainable Ozone- and Climate-Friendly Alternatives to HCFCs

**Published by:**

Deutsche Gesellschaft für  
Technische Zusammenarbeit (GTZ) GmbH  
– German Technical Cooperation –  
Programme Proklima  
Dag-Hammarskjöld-Weg 1-5  
65760 Eschborn, Germany

**Internet:**

www.gtz.de

**Name of sector project:**

GTZ Proklima – a programme to save the ozone layer

**Contact person at the Federal Ministry for  
Economic Cooperation and Development (BMZ):**

Georg vom Kolke  
German Federal Ministry for Economic Cooperation  
and Development (BMZ)  
Environment and Sustainable Use  
of Natural Resources Division  
Bonn, Germany  
Georg.vom-Kolke@bmz.bund.de

**Editors:**

Dr. Volkmar Hasse (Programme Manager)  
GTZ Proklima  
Private Bag 18004  
Klein Windhoek, Namibia  
Phone: +264 61 273 501  
Volkmar.Hasse@gtz.de

Linda Ederberg (Contact Person)  
GTZ Proklima c/o HEAT GmbH  
Zum Talblick 2  
61479 Glashütten, Germany  
Phone: +49 6174 964575  
Linda.Ederberg@proklima.net

Dr. Daniel Colbourne (Technical Advice)  
Re-phridge  
PO Box 4745, Stratford-upon-Avon  
Warwickshire CV37 1FE, UK  
Phone: +44 (0)1789 268285  
d.colbourne@re-phridge.co.uk

**Design:**

pukka design, Frankfurt

**Print:**

Druckerei Hassmüller, Frankfurt  
Eschborn, July 2008

PROKLIMA is a programme of the Deutsche Gesellschaft für Technische Zusammenarbeit GmbH (GTZ). Commissioned by the Federal Ministry for Economic Cooperation and Development (BMZ) PROKLIMA has been providing technical and financial support for developing countries since 1996 to implement the provisions of the Montreal Protocol on Substances that Deplete the Ozone Layer.

# Natural Refrigerants

## Sustainable Ozone- and Climate-Friendly Alternatives to HCFCs

<b>Preface</b>	<b>1</b>
Volkmar Hasse, GTZ Proklima	

---

### I. Policy/Legislation on F-Gases and Alternatives

---

<b>Two environmental frameworks – One goal</b>	<b>7</b>
– The Montreal Protocol and the Kyoto Protocol	

Michael Müller, Parliamentary State Secretary, Federal Ministry for Environment, Nature Conversation and Nuclear Safety, Germany

<b>Success and future challenges of the Montreal Protocol</b>	<b>11</b>
Jason Anderson, Institute for European Environmental Policy (IEEP), Belgium	

<b>Aspects involved in the replacement of fluorocarbon to low GWP refrigerants</b>	<b>25</b>
--	-----------

Jürgen Usinger, GTZ Proklima, Germany

Lambert Kuijpers, UNEP Technology and Economic Assessment Panel Co-Chair

<b>Modernising refrigeration equipment with the Kyoto Protocol's Clean Development Mechanism</b>	<b>37</b>
--	-----------

Thomas Grammig, GTZ Proklima, Germany

<b>Protecting the ozone layer and the climate from halogenated substances – Measures in the European Union</b>	<b>43</b>
--	-----------

Katja Becken, Federal Environment Agency, Germany

---

### II. Safety of Natural Refrigerants

---

<b>Safety rules for the application of hydrocarbon refrigerants</b>	<b>55</b>
---	-----------

Daniel Colbourne, Re-phridge, UK

Jóse M. Corberán, Universidad Politécnica de Valencia, Instituto de Ingeniería Energética, Spain

<b>Ammonia and its reputation as refrigerant</b>	<b>69</b>
--	-----------

Anders Lindborg, Ammonia Partnership AB, Sweden

<b>Safety of CO<sub>2</sub> in large refrigeration systems</b>	<b>81</b>
--	-----------

Samer Sawalha, Royal Institute of Technology, Sweden

<b>Safety of appliances using hydrocarbon refrigerants</b>	<b>95</b>
--	-----------

Daniel Colbourne, Re-phridge, UK

<b>Safe plantrooms for large hydrocarbon chillers</b>	<b>111</b>
---	------------

Amir Tadros, Connell Wagner Pty Ltd, Australia

Ian Maclaine-cross and Eddie Leonardi, School of Mechanical and Manufacturing Engineering, UNSW, Australia

---

### III. Assessment of Natural Refrigerants in Different Applications

---

<b>Opportunities for the application of natural refrigerants</b>	<b>127</b>
--	------------

Daniel Colbourne, Re-phridge, UK

<b>Application of ammonia heat pump systems for heating and cooling in non-residential buildings</b>	<b>137</b>
--	------------

Jørn Stene, SINTEF Energy Research, Norway

<b>Overview and outlook for the application of CO<sub>2</sub> in heat pumps</b>	<b>145</b>
---	------------

René Rieberer, Graz University of Technology, Institute of Thermal Engineering, Austria

Jørn Stene and Petter Neksa, SINTEF Energy Research, Norway

<b>Trends and perspectives in supermarket refrigeration</b>	<b>161</b>
---	------------

Michael Kauffeld, Karlsruhe University of Applied Sciences, Institute of Refrigeration, Air Conditioning and Environmental Engineering, Germany

<b>Assessment of re-fitting supermarkets with indirect systems for Article 5 Countries</b>	<b>173</b>
--	------------

Daniel Colbourne, Re-phridge, UK

<b>Use of hydrocarbons as working fluids in heat pumps and refrigeration equipment</b>	<b>187</b>
José M. Corberán, Universidad Politécnica de Valencia, Instituto de Ingeniería Energética, Spain	
<b>Conversion of various HCFC-22 systems to hydrocarbon</b>	<b>203</b>
Aryadi Suwono, Bandung Institute of Technology, Indonesia	
<b>Experimental assessment of HC-290 as a substitute to HCFC-22 in a window air conditioner</b>	<b>209</b>
Atul S. Padalkar, Sinhgad College of Engineering, India Sukumar Devotta, National Environmental Engineering Research Institute, India	
<hr/>	
<b>IV. Market Developments and Case Studies</b>	<b>223</b>
<hr/>	
<b>The quality of natural refrigerants – The importance of specifying high purity products</b>	<b>225</b>
Veronica Shiels and Barry Lyons, BOC, UK	
<b>Phase out of R22 and then what?</b>	<b>237</b>
Alexander Cohr Pachai, Johnson Controls, Denmark	
<b>Capacity control of refrigeration systems with screw compressors and economizer</b>	<b>245</b>
Dieter Mosemann and Dmytro Zaystev, Grasso GmbH Refrigeration Technology, Germany	
<b>Propane as an alternative to R22 for small refrigeration systems at high ambient temperatures</b>	<b>261</b>
Heinz Jürgensen, Danfoss Compressors GmbH, Germany	
<b>Design criteria for CO<sub>2</sub> evaporators</b>	<b>273</b>
Roland Handschuh, Güntner AG, Germany	
<b>Environmentally friendly refrigeration in the retail trade – Refrigerant R22 soon to be a thing of the past – future ecological alternative can be CO<sub>2</sub></b>	<b>283</b>
Reiner Tillner-Roth, Epta Group, Germany	

<b>Refrigeration systems for warm climates using only CO<sub>2</sub> as a working fluid</b>	<b>287</b>
Sergio Girotto, Enex S.r.l., Italy Silvia Minetto, Università degli Studi di Padova, Italy	
<b>The first CO<sub>2</sub> supermarket plant in New Zealand</b>	<b>303</b>
Alexander Cohr Pachai, Johnson Controls, Denmark	
<b>Natural refrigerants in dairy processing, supermarket refrigeration and air conditioning</b>	<b>313</b>
Karin Jahn, Eurammon, Germany	
<b>Water chillers with ammonia for building services</b>	<b>319</b>
Andy Pearson, Star Refrigeration Ltd., UK	
<b>Green ice cream cabinets – Unilever’s move from HCFCs to HCs</b>	<b>331</b>
Alan Gerrard, Unilever Ltd., UK	
<b>Application of hydrocarbon refrigerants in existing large systems</b>	<b>343</b>
Ladas Taylor, Energy Resources Group, Australia Jackson Ong, Nat-Energy Resources, Singapore	
<b>Developing a product range for climate- and ozone-friendly technologies</b>	<b>355</b>
Nick Cox, Earthcare Products Ltd., UK	
<hr/>	
<b>Annex</b>	<b>365</b>
<hr/>	
List of contributors	<b>367</b>
Further help section	<b>387</b>
Index	<b>393</b>
Acronyms and Abbreviations	<b>401</b>

# Preface

DR. VOLKMAR HASSE, GTZ Proklima

---

## Acknowledgements

---

Foremost, we thank all the authors for contributing with articles and case studies to our publication on natural refrigerants as alternatives to HCFCs.

Furthermore, we would like to thank the following experts who helped to compile the publication and who provided valuable information and amendments to the draft version: Winfried Schwarz, Öko-Recherche and Rolf Hühren, independent consultant.

Volkmar Hasse, Linda Ederberg and Daniel Colbourne

It is now common knowledge that the Montreal Protocol in its effort to phase out the use of ozone depleting substances, especially CFCs, also alleviated the growing climate problem significantly. Some say the world was given a grace period of 10 years in which to react to the potentially cataclysmic effects of climate change. It could have been done even better – if a big chance presenting itself in the mid 1990s would have been taken instead of being missed. At that time there was for example an opportunity to convert the household refrigeration technology directly from CFCs to hydrocarbons, which have no adverse effects on the ozone layer and the climate, and which were already well known and available at that time. German hydrocarbon based “Greenfreeze” technology (the name given by Greenpeace) using hydrocarbons as refrigerant and also to produce the insulation foam was transferred first to the Chinese refrigerator manufacturer Haier in a partnership between the US-Environmental Protection Agency, the German Ministry for Economic Cooperation and Development through GTZ-Proklima and Greenpeace. Soon afterwards the Swiss-Indo-German ECOFRIG project introduced this technology to the Indian refrigerator company Godrej. Unfortunately, these conversions never became a trend outside Europe, mainly due to misinformation about the alleged dangers of natural refrigerants. This continues to this day and at this juncture, just after the adjustment of the Montreal Protocol to achieve an early phase out of HCFCs, the last major group of ozone depleting substances with high global warming potential, we might miss another opportunity unless we are watchful.

Haier and Godrej continued and increased their production of hydrocarbon based refrigerators which have a superior performance. Several other companies followed suit. Fortunately, some manufacturers, while mainly producing equipment based on HCFC and HFC refrigerants with high Global Warming Potential, still persisted to use and improve natural refrigerant technology. Carefully avoiding the noise of deliberate and unjustified bad publicity, a small but significant number of local and international companies decided quietly to adopt the concept of natural refrigerants anyway. They convinced themselves that the technology is not only better, from a physical and environmental point of view, but that the issue of “safety”, by all reasonable interpretations

of this term, need not be compromised. Most importantly for cost conscientious businesses, using natural refrigerants actually helps to save money through improved energy efficiency and reduced servicing costs. Today Haier is the largest refrigerator manufacturer in China and already 80% of Chinese domestic refrigerator production is based on hydrocarbon technology.

The big challenge for the coming years is to establish natural refrigerant technology to substitute HCFCs in air conditioning and commercial refrigeration applications. In recent years, some of the largest companies in the retailing, food and beverage sectors in Europe and Australia started to convert their commercial refrigeration systems to natural refrigerants. They now actually advertise their use of natural refrigerants to signal corporate responsibility to their customers.

In September 2007 the Parties to the Montreal Protocol reached consensus on the early phase out of HCFCs. Because of economic growth and increasing wealth the sharply growing volume of these substances threatens to off-set the successes reached so far through the implementation of the Montreal Protocol. This is not only the case with regard to their detrimental effect on the ozone layer. Equally important, their high global warming potential rapidly offsets the climate benefits achieved through the phase-out of CFCs. The decision of the Parties to the Montreal Protocol, while primarily focusing on the ozone depleting potential of HCFCs, recognized the necessity to take into consideration the climate effects of the replacement technologies. In the refrigerant sector two mature technologies, fluorinated refrigerants (HFCs) with their high global warming potential as well as environmentally friendly natural refrigerants (hydrocarbons, ammonia and CO<sub>2</sub>) are available. However, HFCs still dominate the market outright and natural refrigerants, despite their superior properties, still remain in the shadows, largely because exaggerated safety concerns have not been addressed properly. But if HFCs will replace HCFCs in any substantial manner, the climate benefits of the Montreal Protocol will be lost within a short period of time.

The adjusted Montreal Protocol clearly calls for environmentally superior replacements of HCFCs in order not to squander already attained and further achievable climate benefits. Because of this, this book became possible. And because of the rapidly deteriorating global climate this book became a necessity. The world simply cannot afford to lose this opportunity a second time.

This publication attempts to provide information and guidance to decision makers in developing countries, both in government and the private sector. It demonstrates which ozone- and climate friendly alternatives to fluorinated refrigerants are available in the market and why and how they should be applied. We are aware of the wide audience with varying interests and information needs and hope to provide thorough opinions from authoritative experts and convincing examples of operational refrigeration systems with natural refrigerants. Everyone concerned with the replacement of HCFCs through sustainable technologies will find a wealth of knowledge on many aspects

relevant to their current work, which will enable them to take an informed decision. The publication covers the main areas to be considered when planning for an early HCFC phase out and conversion to natural refrigerants: policies and legislation regarding fluorinated refrigerant gases and appropriate alternatives, safety issues associated with flammable or toxic refrigerants, assessment of the performance of natural refrigerants in different applications and environments, actual examples, case studies and market developments. The information was provided by professionals whose integrity and authority is immaculate. In our quest to contribute to the welfare of future generations we are very grateful to them.

---

## I. Policy/Legislation on F-Gases and Alternatives

---



# Two Environmental Frameworks – One Goal

## The Montreal Protocol and the Kyoto Protocol

MICHAEL MÜLLER, Parliamentary State Secretary, Federal Ministry for the Environment, Nature Conservation and Nuclear Safety, Germany

The Montreal Protocol and the Kyoto Protocol are two global environmental agreements with a common objective: to protect Earth's atmosphere from the adverse effects of human actions. Although the Montreal Protocol has already largely secured its status as a success story, we still have to cope with the challenges resulting from climate change. We are only in round one of a long fight.

Climate change is an alarming, global environmental problem. Melting polar icecaps and glaciers, rising sea levels and entire coastlines under threat are just a few of the issues that we are facing. Other consequences include an increase in global weather extremes, droughts and floods, environmental migration, food shortages and species extinction. The atmosphere is responding unmistakably to human-induced global warming, with disastrous damage to the economy and society as a result.

The Kyoto Protocol is the first internationally binding agreement to cut greenhouse gas emissions – albeit just in parts of the industrialised world. The main focus is carbon dioxide (CO<sub>2</sub>) emissions from the burning of fossil fuels such as oil, gas and coal. However we need far more ambitious commitments in order to avert the disasters that are threatening people and the environment. Catastrophic economic and ecological consequences are foreseeable if warming exceeds 2 °C. We must take immediate action and halve global greenhouse gas emissions by 2050 if we are to limit global warming to 2 °C. To do so, we must not only focus on preventing carbon dioxide emissions but also keep an eye on other Kyoto Protocol gases, including fluorinated gases. We pay a high price for our often ineffective approach to handling scientific findings. This is exemplified by the failure to take resolute action to protect Earth's climate over the last 20 years. For instance, we had real indications as early as 1987 of a strong likelihood that Earth's atmosphere would warm by 3 °C, as the IPCC has now confirmed. In the case of the Montreal Protocol, it took 13 years for Cruizen, Rowland and Molina's 1974 scientific findings to be translated into political action.

In September 2007, the community of states celebrated the 20th anniversary of the Montreal Protocol on Substances That Deplete the Ozone Layer. The Montreal Protocol sparked unparalleled innovative progress, via intermediate steps, away from substances with high ozone depletion potential towards alternative substances and pro-

cesses without a negative impact on the ozone layer. The next stage will focus on reducing the climate impact of these alternatives. Solutions addressing both concerns have not yet been implemented in all areas. One positive example is the use of hydrocarbons in household and commercial refrigeration appliances. It has been almost 15 years since Germany pioneered the environmentally-friendly hydrocarbon fridge around the world. We must now expand the use of these substances to other refrigerant applications, too. Alternative technologies have also been developed for foam blowing, aerosols, solvents and fire fighting agents that have a much lower impact on our climate. Germany's experience of phasing out ozone-depleting substances demonstrated that industry needs plenty of warning in order to stimulate the necessary innovation. The ban on HCFC R22 from 2000, which was adopted in 1991 at a time when widespread alternatives were not yet available, stimulated the necessary development work at a national and also European level.

The decisions made by the parties to the Montreal Protocol in September 2007 not only bring the ozone protection process forward but also facilitate a clear contribution towards protecting our climate. It is now our shared duty to avoid any perverse incentives for other environmental agreements when fulfilling obligations. The use of fluorinated greenhouse gases covered by the Kyoto Protocol must not increase as a result of the 2007 Montreal commitments – even though these substances' current contribution towards overall warming is “only” comparable with that of air traffic.

By way of illustration, here is one small example: The accelerated phase-out of HCFCs agreed in Montreal in 2007 not only helps to protect the ozone layer but also mitigates climate change. 7.7m tonnes less HCFC will be manufactured compared with the previous rules (HCFC phase-out in developing countries by 2040 without interim steps). These 7.7m tonnes have a global warming potential of 26 gigatonnes of CO<sub>2</sub> equivalent. By way of comparison, greenhouse gas emissions from industrialised countries totalled 18 gigatonnes of CO<sub>2</sub> equivalent in 2004. Even just replacing some 25% of HCFCs with substances that have zero global warming potential will have a reduction in the global warming contribution that is equivalent to the reduction achieved by the Kyoto Protocol during its first commitment period from 2008 to 2012. Let us now return to the Montreal Protocol, its innovation and contribution towards global environmental protection. The international community has made significant funds available to developing countries to ensure that they do not suffer any financial drawbacks from CFC phase-out and are also able to benefit from the new technologies. These funds not only helped to protect the ozone layer but also made a significant contribution towards climate protection because the banned CFCs have substantial direct global warming potential. Major innovation was and is needed to phase out CFCs and HCFCs. We still need additional innovation to help climate-friendly solutions to achieve a worldwide breakthrough. The European Union wants to agree an effective and fair international climate regime for the future. Last year the foundations

were laid for finding a follow-up to Kyoto by 2009. These rules would cover the period after 2012 and aim to limit Earth's warming to a maximum of 2 °C. For this to happen, on the one hand, industrialised countries – the main contributors to global warming – must be required to take the radical reduction measures needed. These measures are within reach with today's technologies. On the other hand, effective climate protection necessitates involving newly industrialising countries in an appropriate manner. Therefore we must also develop sustainable technologies and make them available to all countries so that they can contribute towards climate protection.

At the end of a three-day visit to China at the start of 2008, Germany's Environment Minister Sigmar Gabriel said: “Like Germany, China is investing heavily in energy efficiency and the expansion of renewable energies. We should support these policies not only with regard to global climate protection but also because of the opportunities this entails for export.” This applies to newly industrialising and developing countries alike. Germany will thus provide further financial support in addition to its contribution to the Montreal Protocol's Multilateral Fund.

Germany is prepared to make a disproportionately large contribution towards climate protection and lead the way for the rest of the world. This role will involve close cooperation with newly industrialising and developing countries and their support to attain climate protection goals. This process will include replenishing the Multilateral Fund to a level that will allow the Montreal Protocol's Article 5 countries to implement the Montreal decisions with regard to the climate change aspect, as well. The German Government's resolution on an “Integrated Energy and Climate Programme” sent a clear signal about the path that we should follow. This programme comprises 29 points and should become a model for industrialised countries. In this way, we are sending out an important message for the international negotiations: climate protection pays. One point in this programme addresses the reduction of fluorinated greenhouse gas emissions.

Promoting energy efficiency and eliminating fluorinated greenhouse gases are two of the challenges that we must face together. The German Government is planning to earmark the proceeds from the sale of emissions certificates, an estimated € 400 million in 2008, for programmes to promote climate protection as part of these efforts. This programme will also have a strong international orientation. The measures needed to limit climate change represent significant challenges for the world's population, yet also offer major opportunities for particularly innovative and climate-friendly technologies and products. That is the way forward. Innovation necessitates dialogue between business, society and politicians, together with dialogue between industrialised and developing countries.

# Success and Future Challenges of the Montreal Protocol

JASON ANDERSON, Institute for European Environmental Policy (IEEP), Belgium

---

## Introduction

---

The 'Dialogue on Key Future Challenges Facing the Montreal Protocol' (2-3 June 2007, in Nairobi) celebrated 20 years of the Protocol and examined its future. The first aspect of the agenda was to celebrate the success of the Protocol, which was demonstrated by highlighted several key messages:

- Overall, the Montreal Protocol has achieved 90 per cent of what it set out to do;
- By 2005 developed countries had reduced production and consumption by over 99 per cent from baseline levels and developing countries by 80 per cent;
- Further reductions are anticipated from multiyear phase-out agreements under the Multilateral Fund, and total closure of CFC and halon production in China in July 2007;
- Non-Article 5<sup>1</sup> Parties are well ahead of their reduction targets for HCFC production and consumption: by 2005 they had already reduced by over 72 per cent against a mandated reduction of 35 per cent;
- There is a 'culture of compliance' showing that achievable goals could be met.

The age and success of the Protocol have their downsides, however, which Parties also have to address now. Specifically, age and success means there is simply less remaining to do – the result is that attention and willingness to remain engaged could wane. However, the remaining work is becoming more challenging and costly in its detail and specificity – it is a kind of paradox that presents problems to the system as it has functioned in the past.

The ultimate success of the Protocol in phasing out Ozone Depleting Substances (ODS) also would represent an end to the financial responsibilities of donor countries, which tends to lead to a particular emphasis on certainty about remaining plans

---

<sup>1</sup> 'Article 5' countries are those with delayed phaseout schedules and which receive financial assistance – developing countries, also referred to here as 'A5' countries. Non-Article 5 countries are the opposite: countries which have earlier phaseouts and fund the Multilateral Fund.

and responsibilities among donors. Through national and sectoral phaseout plans, and close attention to their implementation, it is hoped that eliminating the final amounts of Ozone Depleting Potential (ODP) tonnes will not be a never-ending commitment. However, the desire to achieve finality has to be balanced with making sure developing country needs are met and the sufficient resources and expertise are made available.

There are instances of waning interest, noted at the 'Future Challenges' meeting, of which just two details are that the WMO has dismantled some ozone monitoring devices, and voluntary contributions to the Scientific and Environmental Effects assessment panels have totalled only \$58,000: indicative perhaps of a larger issue. Counteracting the tendency to lose focus, while at the same time recognizing that ODS phaseout has to shift into a final phase is a complex balancing act.

### Upcoming challenges in the Montreal Protocol

Overall, there are a number of recognised **challenges**, of which probably the most significant are:

1. **Management of banks:** the nature of the Montreal Protocol is the phaseout of production and import and with it consumption of ODS – however, there are still significant amounts banked in equipment, particularly refrigeration, air conditioning, foams and fire protection, which are large sources of leakage. Trying to destroy banks, whether at end of life or beforehand, would require a new approach.
2. **Dealing with currently exempted uses and critical use needs:** in particular methyl bromide exemptions negotiated in 2005 were large (though falling year-on-year), and Quarantine and Pre-Shipment (QPS) sustains significant levels; CFC Metered Dose Inhaler (MDI) use is reducing but not fast enough according to phaseout goals;
3. **Reversing the increase in HCFCs use and achieving the accelerated phaseout:** the accelerated phaseout puts more pressure on seeing progress on HCFCs, which risked being almost ignored in A5 countries particularly due to the emphasis on CFC phaseout and the extremely long HCFC phaseout timeframe previously set (2040, now put at 2030, and 2020 for non-A5 countries). A challenge here will be both to find alternatives and to consider the implication of a 'double phase out', where HCFCs were funded by the MLF to replace CFCs.
4. **Reforming the institutional structure:** The institutions were designed to accommodate many decisions and many projects, while these are in fact diminishing in number and hence reform to save effort and cost may be possible.
5. **Maintaining expertise and momentum, countering illegal trade and ensuring successful implementation and compliance:** even as statistics show the success of

the Protocol, there is clear evidence of ongoing illegal trade that needs attention, and final success will only be achieved if phaseout plans are implemented and complied with. There is still the need for adequate monitoring, assessments, and national capacity for ozone issues. All require continued attention at a time when many see the Protocol winding down.

6. **Assessing the cost, effectiveness and funding needs for outstanding issues:** national and sectoral phaseout plans, which envision the final success of the Protocol and hence the end of donor requirements for the MLF, need to be adequately resourced; additionally there are exemptions continuing, as well as the accelerated HCFC phaseout: wanting to pin down the final financial requirements will be complex while considering the financial implications of making certain full phaseout occurs. Donors would like to see A5 countries take more responsibility, while A5 countries do not want to be left stuck with remaining ODS, facing non-compliance and the financial responsibility to phase it out.
7. **Interaction with other environmental agreements and issues:** there is a notable link with climate change and the UNFCCC/Kyoto Protocol due to the Global Warming Potential (GWP) of ODS as well as the energy-using character (or energy saving in the case of insulation) of much of the relevant equipment. Also important, though, are other chemicals conventions and agreements (Rotterdam, Basel, Stockholm, SAICM) and the International Plant Protection Convention (IPPC).

In many respects the positions of donor countries like the United States, Japan and the EU are quite similar in their desire to see such issues tackled, while Article 5 countries emphasize the need to see they receive enough support, and institutions remain strong enough, to guarantee phaseout is achievable without overburdening their economies. Important differences among non-A5 do exist, however, notably the continued use of methyl bromide in the US (though they are not alone), as well as their greater reliance on HCFCs, their use and promotion of HFCs as an alternative and their greater resistance to natural refrigerants.

Following, we explore some of the most complex issues in the future discussions.

---

### Banks, recovery and destruction

---

The IPCC/TEAP Special Report on Ozone and Climate (SROC)<sup>2</sup> found that for CFCs and HCFCs, a significant contribution (now and in coming decades) comes from their respective banks. There are no regulatory obligations to restrict these emissions

<sup>2</sup> The report is officially known as 'Safeguarding the Ozone Layer and the Global Climate System: Issues related to hydrofluorocarbons and perfluorocarbons', drafted by the Intergovernmental Panel on Climate Change and the Technical and Economic Assessment Panel, found at <http://www.ipcc.ch/ipccreports/special-reports.htm>

either under the Montreal Protocol or the UNFCCC and the Kyoto Protocol, although some countries have effective national policies<sup>3</sup>. The bank turnover varies significantly from application to application: from months (e.g. solvents) to several years (refrigeration applications) to over half a century (foam insulation). Of the bank-related emissions that can be prevented in the period until 2015, the bulk is in refrigerant-based applications where business-as-usual emission rates are much higher than for foams during the same period. With containment during use, and active recovery and destruction at end of life, more of the emissions from CFC banks can be captured.

According to the report, of the CFCs banked in refrigeration and air conditioning equipment, 280,000 tonnes could be cost-effectively collected and destroyed. Costs are on the order of \$5,000 per ODP-weighted tonne, which compares favourably to CFC production and consumption phaseout costs<sup>4</sup>. ODS in foams are significant but more expensive to collect, as discussed in detail below. Some of the potential approaches to recovery include:

**Regulations:** End-of-life management measures, such as mandatory recycling and bans on venting

**Financial incentives and market mechanisms:** Tax rebates for delivery of used fluorocarbons to destruction facilities provide incentives to minimize emissions. Subsidy (50%) on the cost of collection and destruction of halons and CFCs was provided in the Netherlands to discourage venting, just before stocks of these substances became illegal in 2004.

**Voluntary Agreements:** 'responsible use' principles include good practice guidelines regarding the selection and maintenance of equipment, including improved containment of substances and recovery during servicing and at the end-of-life.

A 2006 meeting<sup>5</sup> noted the following quantitative results on CFC, halon and CTC regarding banks and annual flow:

**CFCs:** total non-reusable CFCs from refrigeration is about 3,500 metric tonnes. However, CFC blown insulation will be in use after the year 2015. Recovery and recycling from refrigeration would require a well coordinated effort in policy and subsequent infrastructure, since the recovery and recycling of them are viable applications, although more expensive for foams.

**Halons:** Recovery and recycling rather than destruction of halons are expected to function well since halons are used for decades and have residual value due to high demand.

<sup>3</sup> The report does not go on to mention which countries these are.

<sup>4</sup> National and sectoral phaseout plans evaluated in 2007 (UNEP, 2007a) showed cost effectiveness figures of \$4000 to \$9000 per ODP tonne.

<sup>5</sup> March 2006, under Decision XVII/18, and decision 47/52 of the Executive Committee of the Multilateral Fund.

**CTC:** There is likely to be an excess of CTC production in the near future, and the excess will need to be destroyed. While destruction of stored ODS is possible with various technologies, there is an important question of how to ensure it takes place, rather than seeing excess simply enter the market and depress prices, increasing demand. There are many recovery and recycling (R&R) projects, but they are not especially effective. A 2006 report on compliance found that 59.4 per cent of countries employing R&R machines reported that they had been functioning 'satisfactorily' or 'very well' – in other words 40 per cent found they were not working well, which is a high figure, and the machines are only part of the success of R&R (or destruction).

### Foam end-of-life options

The TEAP established the Task Force on Foam End-of-Life Issues in response to MOP Decision XVII/10. The final report (TEAP, 2005) focused on the description of the technical and economic aspects of blowing agent recovery and destruction from appliance and building insulation foams. There were several conclusions:

- A new parameter, recovery & destruction efficiency (RDE), would help describe the whole recovery and destruction chain, and that currently practiced recovery and destruction process have the potential to reach an RDE of greater than 85%-90%;
- Anaerobic degradation of ODS in case of **landfilling** (managed attenuation) shows potential;
- Thirdly, the economics of recovery and destruction are greatly affected by segregation of foams from other components, infrastructure of transport, and so on. Mechanical separation followed by re-concentration, and direct destruction of the foam including its blowing agent both work well. It estimated that blowing agents can currently be recovered from appliances at a net cost of **\$25-40/kg**;
- Finally, existing banks of CFCs and HCFCs are estimated to be **1.5 million and 0.75 million tonnes**, respectively.

The IPCC/TEAP SROC found that for foam from refrigerators, all refrigerator foams could be managed at end-of-life by 2015 at costs of \$10-50/kg, if the investment in plants to do so were appropriately dispersed geographically. This would, however, involve investment in developing as well as developed countries. For buildings, however, the general consensus is that recovery will be considerably more expensive than from appliances because of the lower yield (caused by losses in the use and recovery phases) and the additional costs of demolition waste separation. It should be noted that this discussion of options is in the context of actual experience where recovery and destruction are not meeting the potential – implying that there needs to be significantly more effort. Recovery costs as noted are nearly an order of magnitude greater than refrigerant recovery costs, meaning that tackling foams will be quite hard. However, as the graphic below shows, foams are the major banks: a conundrum.

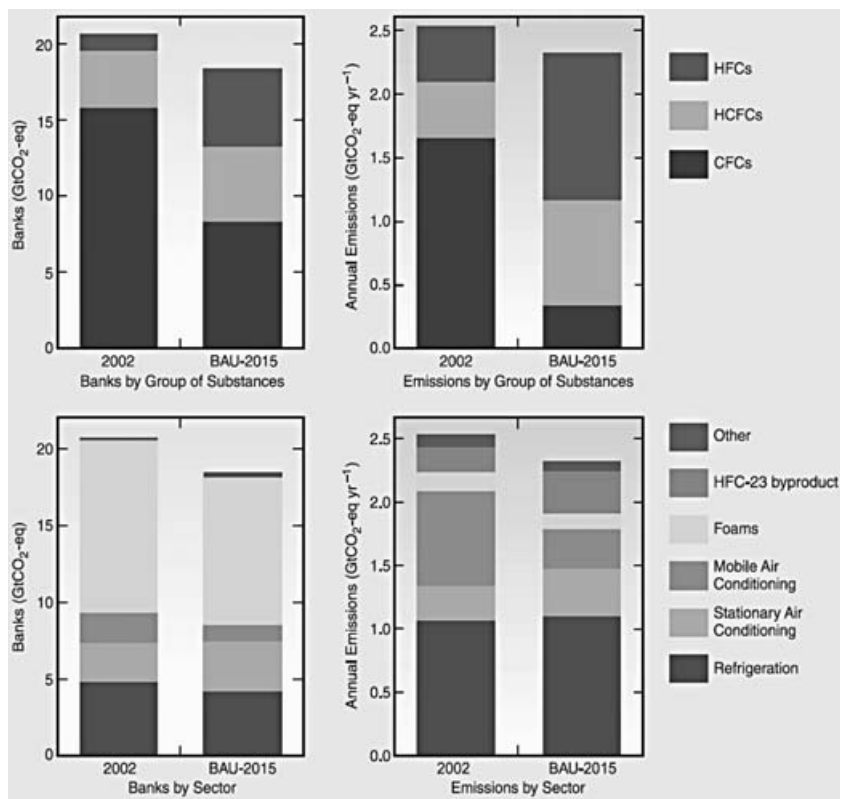

Figure 1: Banks and emissions by substance and sector, (IPCC/TEAP, 2005; Figure SPM-4, page 10)

A **key conclusion** of these assessments is that, in many cases, ODS recovery and destruction will not be achievable without any additional stimulation which may arise from other environmental agreements and economic imperatives.

## Phaseout of ODS in the context of exemptions, critical uses, and compliance issues

### Non-Article 5 Countries and methyl bromide

Non-Article 5 countries are occasionally cited for non-compliance issues, often having to do with failure to properly report production for export, or lack of clarity on exemptions. With other ODS targets largely met or on target, the major (non-HCFC) challenge has to do with methyl bromide. As leaders of the Montreal Protocol, countries like the United States, Canada and several EU Member States did not appear at

their best as the 2005 methyl bromide phaseout date approached but there continued to be high levels of use. The extraordinary MOPs in 2004 and 2005 agreed an approach to critical use exemptions with annual review (an EU proposal – the US wanted multi-year exemptions). Accordingly, 2005 saw around 14,000 tonnes of critical use allowed, of which around 9,000 for the US – which although a third of use levels prior to the Protocol, was an increase on the previous year. Subsequently there has been progress: CUEs permitted by MOP-18 for 2008 totalled around 7,500 tonnes, but CUEs granted by MOP-19 for 2009 totalled only 4,400 tonnes – a drop of approximately 42%. Nevertheless, Parties have raised concerns about slow adoption of alternatives and disputed large CUE nominations, noting that up to 40% of stocks were not being used for critical uses. A 2005 study stated: ‘There is an evident reluctance of MB users to change to alternatives which is noted in all sectors. The fact that MB cannot be replaced by one sole and equally effective alternative implies that growers and other stakeholders have to change their approach to production and process management’ (UNEP, 2005).

Because of the uncertain amount and use of stocks, the presence of the option to grant critical uses, increasing QPS use, and information from the field showing that methyl bromide options are not always being implemented, there is concern for the future. The whole issue raises to the fore problems with the notion of ‘critical needs,’ when considering that the applications granted such exemptions in particular countries, most notably the long list in the United States, are ones not requiring methyl bromide in other places where the same crops are grown (e.g. strawberries, tomatoes and others).

### Phaseout and compliance issues in Article 5 Countries

A recent assessment (UNEP, 2007b) discussed future phase out goals, compliance and anticipated compliance, in Article 5 countries. They summarise that:

- For **CFCs**, 6 countries were in non-compliance with 2005’s 55 per cent reductions, while 93 countries (or 82 if accounting for national plans) were at risk of non-compliance with the future 85 per cent reduction based on current use.
- For **Halons**, 2 countries exceed the baseline freeze and the same two are at risk of failing to meet the 50 per cent reduction (Libya and Somalia).
- For **Methyl bromide**, 4 countries exceed the freeze level, while 6 countries are at risk of not meeting the 20 per cent reduction level.
- For **Carbon tetrachloride**, 8 countries may have missed the 2005 control levels.
- For **Methyl chloroform**, 0 countries exceed the baseline freeze, while only the DR Congo is at risk of not achieving the 30 per cent reduction.

The same survey further summarised the total sectoral use and phaseout perspectives, based only on the projects planned and under implementation. About half of the 47,466.7 ODP tonnes consumed in the latest statistics are subject to approved project phaseouts.

Sector	Total latest consumption	Percentage of total latest consumption	Total phase-out approved but not completed	Balance to be phased out	Percentage of balance to total latest consumption
Aerosol	937.3	2.0%	1,011.1	*	N/A
Foam	8,488.9	17.9%	1,396.2	7,092.7	83.6%
Fumigant	4,624.4	9.7%	2,293.0	2,331.4	50.4%
Halon	5,468.3	11.5%	12,335.1	*	N/A
Lab Use	622.9	1.3%	0.0	622.9	100.00%
MDI	1,658.8	3.5%	0.0	1,658.8	100.00%
Process Agent	1,299.9	2.7%	432.4	867.5	66.7%
Refrigeration	21,575.5	45.5%	8,074.0	13,501.5	62.6%
Solvent	2,662.7	5.6%	326.1	2,336.6	87.8%
Sterilant	0.0	0.0%	0.0	0.0	N/A
Tobacco	128.0	0.3%	150.0	*	N/A
<b>Total</b>	<b>47,466.7</b>	<b>100.0%</b>	<b>26,017.9</b>	<b>28,411.4</b>	<b>59.9%</b>

\* More phase-out approved than latest consumption.

Table 1: Balances of remaining phaseout by substance, excluding certain agreements (UNEP, 2007b).

The data in the previous table do not account for multiyear agreements, refrigerant management plans and halon banking – adding these to the projects planned, the total residual ODS consumption is estimated to be around 7,000 ODP tonnes, of which mainly CFCs and Methyl Bromide (next table). Here is where the significance of exemptions can be seen.

Chemical	Remaining ODS consumption (ODP tonnes)
CFC	3,522.8
CTC	8.6
Halons	19.1
MB	3,283.9
TCA	4.3
<b>Total</b>	<b>6,838.7</b>

Table 2: Residual ODS consumption after accounting for all projects, programmes, agreements and plans (UNEP, 2007b).

The preceding study shows the following:

- There is grounds for optimism about future phaseout if looking at projects and programmes in the pipeline;
- Exemptions and critical uses will continue at a rate of around 20 per cent of current consumption;
- Compliance to date has been relatively successful, with future CFC reduction levels the most at risk of being missed (which are also the most important by tonnage).

While there is often concern about project implementation delays, the review found that delays are generally not an indication of ultimate project failure. Those countries having to implement action plans to make for or avert compliance problems have

been found largely successful – except in the area of implementing required regulatory changes (note that this is not encouraging when considering the option of promoting national regulatory approaches to address the task of reducing banks).

## Institutional reform

ODS phaseout has been 9/10ths achieved, and the remaining amounts are often different in nature to address than what came before, so it seems logical that the set of institutions dealing with ODS may need to be reformed. They might be downsized while given a strategic redesign to increase effectiveness. Parties have shown willingness to make changes, such as the merging of the two MLF subcommittees; both donors who are concerned about ongoing funding and implementers who are concerned about effective projects and programmes are willing to consider options.

Among the options to make the size, responsibilities and budget of the institutions better match future circumstances are decreasing the number of MOPs, having the MP and MLF secretariats increase cooperation to avoid task duplication, cooperating with other Conventions, increasing the role of the national ozone units as implementing agencies diminish their roles (probably with the exception of the UNEP compliance action programme, which will continue to be important), and several others, which are further mentioned in the methodology.

A major aspect of this is debate over the institutional arrangements for the ‘endgame’ of ODS control, particularly with respect to developing countries (DCs) and the MLF. The MLF is not meant to be a perpetual institution: it has a specific goal to assist phaseouts in DCs, and a sign of its success would be that its role diminishes. At the same time, donor countries want to see a ‘light at the end of the tunnel’ for their financial commitments. This was the idea behind the multiyear national phaseout plans first introduced in 1997 and taken up thereafter.

MOP 19 decisions in September 2007 have somewhat diluted the emphasis on the institutional arrangements at least until more detail on HCFC phaseout arrangements are hammered out. The sped-up HCFC phaseout will require further deliberations on the means of achieving it, whether through current or revised institutions. Earlier phaseout is an important achievement but brings with it challenges such as the cost of alternatives to HCFCs, and reconversion of plants recently converted to HCFCs. Parties have stated that the MLF is sufficient to handle the earlier phaseout without specific additional funding, though A5 countries will want to be certain of that.

As it will take 50-60 years for the ozone layer to recover, monitoring will continue to be essential, and scientific updates will be needed both to verify expected improvement and remind Parties of the ongoing risks posed by ozone depletion and hence the importance of achieving complete phaseout.

When the first extraordinary MOP discussed the possibility of critical use exemptions for methyl bromide, the methyl bromide technical options committee (MBTOC) stated they were not well enough resourced to perform a fully independent assessment of critical use exemption (CUE) need, and had to rely in part on Party submissions, which led to questions about the likely accuracy and impartiality of the CUE recommendations. This is one example of how quite difficult answers are demanded of the Assessment Panels, which they may not always be in a position to deliver if not adequately resourced.

It is perhaps worthwhile to note that assessment panel members are unpaid, and only receive assistance if from Article 5 countries, or in some cases from their own governments. While they deliver quality work, it has always been the case that the people most able to participate are funded by organisations that have a direct interest in the outcomes.

Whilst there is an open question about the need for continuing such frequent meetings and reports of the panels (the United States has suggested cutting their assessment reports to once every three years), and cost savings are being sought, it could be argued that the approach to the panels all along has been one that has not fully addressed the impartiality of the advice given to Parties, and that renewed attention is necessary to their resourcing and composition, particularly with regard to the TEAP and the technologies it assesses.

### The needs of Article 5 Countries

It is important to consider future scenarios in light of the needs of Article 5 countries, as they are where the bulk of the challenge lies. UNEP recently surveyed A5 Parties and determined the following were the key priorities for them in the post-2010 period:

**Political will:** maintaining a high level will be important due to the long-term nature of the commitment to phaseout.

**Institutional capabilities:** there is need to maintain functioning national ozone units; there is a need for guidance on phaseout approaches in the post-MLF/GEF period; and there should be peer support through networking among NOUs.

**Information and awareness:** NOUs need access to international expertise; stakeholder groups need to have continued high levels of awareness; and there is a need for information on longer term issues like MDIs, destruction, banks and essential uses.

**Non-compliance:** these issues will need to be addressed in the current and longer term.

**Data reporting:** to meet obligations post-2010.

**Consumption and production phaseout:** addressing residual sub-sectors, and methyl bromide, especially considering the possibility that alternatives for QPS may not be available until 2015.

**Policies and enforcement:** assistance for legislative and policy control development; combating illegal trade; strengthening national enforcement structures and actions; improve import/export systems; developing national essential use and standards panels for all ODS.

**Servicing and Banks:** meeting all servicing needs for CFC equipment until end of life, possibly by establishing banks; ensuring adequate ODS for critical uses; finding ways to avoid needing essential uses; developing ODS bank guidelines, controls and tracking.

**New ODS:** avoiding the spread of new ODS.

The great majority of these issues are ones that are important to all Parties, with the difference among A5 Parties being the fact of longer phaseout timing and hence the need for a longer-term view on maintaining effective action. It is also important to note the emphasis these countries pay to maintaining sufficient banks and stockpiles to ensure equipment is serviceable until end of life, at a time when there is increasing concern about ODS banks and the need to see if it is possible to reduce them.

---

## The political landscape of the ozone and climate interaction

---

Among the more important future issues will be the interaction (both in the climatology and political senses) of ozone and climate. Policy is just now rising to the challenge of climate, while the ODS phaseout is in the final planning phase. As important greenhouse gases (GHGs), ODS are of interest from a climate protection point of view, recognition of which may help overcome difficulties in phasing them out – in terms of attention and financing. However, whilst the reduction in climate impact due to the phaseout of ODS is important, the recent emphasis on this fact by the United States in particular is probably a way of reducing the importance of the Kyoto Protocol – as one of the leaders in the Montreal Protocol and a non-ratifier of Kyoto, the US prefers to put itself in a good light on this issue. In terms of political messaging, then, the climate impact of ODS cuts two ways – it is a real issue, but can be misused.

The special report on ozone depletion and climate change is itself instructive in this regard. The primary motivation for the report was a concern raised in the UNFCCC process about the introduction of HFCs to replace ODS and the obvious collision course this represented for Montreal and Kyoto. As it happened, largely under pressure from parties like the United States wary of putting pressure on HFCs, the mandate of the report represented something of a shift in focus away from HFCs per se toward a broader set of ozone/climate issues. The position of these and other Parties, and of much industry, has been that the phaseout of CFCs would be hindered by too aggressive limitation of HCFCs, while the phaseout of HCFCs would be hindered by too aggressive limitation of HFCs: a cascade of reasons not to move too quickly.



The special report was quite obviously important in establishing the link between climate and ozone, and among the results is the clear fact that ongoing releases and the long-term banking of high-GWP ODS still outweighs non-ODS in greenhouse gas terms (not to mention in ODS terms). But what has really raised the Montreal – Kyoto link to the fore is the clash over HCFC-22 production and the resulting HFC-23 emissions that have formed the backbone of Clean Development Mechanism crediting (much to the chagrin of those who expected the CDM to support solar energy). At MOP-19, Article 5 countries appeared to be most concerned with the possible negative impacts of future alternatives, and asked for studies on the matter. They are likely concerned about the long-term responsibility they may face for adopting high-GWP HFCs as replacements for ODS, on the one hand, and the higher technical assistance needs and safety costs of entering into non-fluorocarbon alternatives, particularly ones that are still at the cutting edge of technology even in non-Article 5 countries.

---

## Conclusion

---

Success in the large proportion of ODS phaseout lays bare the remaining challenges – dealing with intermediate alternatives like HCFCs and HFCs; essential uses; compliance; banks; and so forth. As in many endeavours, the last bit takes far more effort than addressing the same amount among the low hanging fruit earlier on.

The success to date owes much to the ability to adjust the international regime – Vienna was followed by Montreal, London, and Copenhagen, to begin with. There have been myriad decisions since, including new approaches to financing and host country responsibility and the recent acceleration of HCFC phaseout. However, there has been reluctance to allow those adjustments to go ‘outside the box’ to consider other environmental issues, of which climate is the most prominent. HCFCs and HFCs as CFC replacements has created an explicit linkage for which there is an atomized policy approach, with potential detrimental results. There should be a willingness to consider where these issues are best addressed and how – for which the confluence of reconsiderations under Montreal and a follow-up of Kyoto provides an excellent opportunity.

Other problems, meanwhile, are diffuse and touch on a range of different policy and economic realms – from methyl bromide in strawberries, to CFCs in asthma inhalers, to ongoing problems with illegal trade. Tackling them will require harnessing other agreements and fields of expertise. Though in some cases expensive given the smaller scales involved, phaseouts are important, particularly those where non-ODS alternatives can be fully implemented. Without doing so, there is not only a risk of ongoing low-level emissions but of backsliding and a continuing inducement to illegal activity.

As much of the remaining focus is in developing countries, a major challenge will be retaining the interest, including financial, of non-Article 5 countries, while Article 5 countries maintain steady progress toward complying with their commitments. Among other things, successful cooperation at this difficult and detailed level provides a healthy model for the long-term success of other international environmental protection efforts.

---

## References

---

Ashford, R., Mizuno, K., Quintero, M. 2005, “May 2005 Report of the Task Force on Foam End – of – Life Issues” TEAP (Technical and Economic Assessment Panel of the Montreal Protocol) Volume 3. Nairobi Kenya

Metz, B., L. Kuijpers, S. Solomon, S.O. Andersen, O. Davidson., J. Pons, D. de Jager, T. Kestin, M. Manning and L.A. Meyer eds, 2005: “IPCC/TEAP Special Report on Safeguarding the Ozone Layer and the Global Climate System: Issues Related to Hydrofluorocarbons and Perfluorocarbons”. Prepared by WG I and III of the Intergovernmental Panel on Climate Change and Technology and Economic Assessment Panel Cambridge University Press, Cambridge, UK and New York, NY, USA, 488pp.

UNEP Dialogue on key future challenges faced by the Montreal Protocol on Substances that Deplete the Ozone Layer. 2007. “Summary of issues for discussion at the dialogue on key future challenges to be faced by the Montreal protocol”. UNEP/OzL.OPro/DKFC/1/2/Add.1. Eighteenth Meeting of the Parties to the Montreal Protocol on Substances that Deplete the Ozone Layer

UNEP Executive Committee of the Multilateral Fund for the Implementation of the Montreal Protocol. 2007a “Desk study of the evaluation of Management and Monitoring of national phase-out plans”. UNEP/OzL.Pro/ExCOM/51/13. 19-23 March 2007 Fifty-first Meeting Montreal, Canada

UNEP Executive Committee Of The Multilateral Fund For The Implementation Of Montreal Protocol. 2007b, “Status/projects of the article 5 countries in achieving compliance with the initial and intermediate control measure of the Montreal protocol”. UNEP/OzL.Pro/ExCom/52/7/Rev.1. 23-27 July 2007 Fifty-second Meeting Montreal Canada

# Aspects Involved in the Replacement of Fluorocarbon to Low GWP Refrigerants

JUERGEN USINGER, GTZ Proklima, Germany

DR. LAMBERT KUIJPERS, UNEP Technology and Economic Assessment Panel Co-Chair

---

## Introduction

---

Climate change is one of the biggest environmental challenges at present. The resolution of the challenge is complex and requires a thorough understanding of all the issues involved. An overview of the technological issues involved as well as mitigation options can be found in the Intergovernmental Panel on Climate Change (IPCC) Assessment Reports of Working Group III /1/. Even when the phenomenon is thought to be understood, it needs an international major environmental agreement, such as the Kyoto Protocol, to deal with it, and this relates to e.g. emission reductions, the sources and sinks of greenhouse gases, the compliance regime, etc.

The most important element to be addressed in the climate change issue consists of the emissions (and the control) of global warming gases. The compilation per country of credible greenhouse gas emission data is therefore important. Where it concerns refrigeration and air conditioning, it is related to the fluorocarbon gases, which comprise the chlorofluorocarbons (CFCs), the hydrochlorofluorocarbons (HCFCs), the hydrofluorocarbons (HFCs), and, to a much smaller extent, the perfluorocarbons (PFCs). Although CFCs and HCFCs contribute significantly to climate forcing emissions, they are not controlled under the Kyoto Protocol, since they are already controlled under the Montreal Protocol. This then leads to the observation that emissions of HFCs etc. are controlled, however, that emissions of CFCs and HCFCs are not controlled, although these chemicals are controlled under the Montreal Protocol for production and consumption. The emissions are not addressed since the Montreal Protocol is a phase-out protocol and not an emissions addressing regime.

In the second section, this paper deals with the Montreal and the Kyoto Protocol requirements. It then summarises in the third section the outcome of the IPCC Technology and Economic Assessment Panel (TEAP) Special Report on the inter-linkages between ozone layer depletion and climate change as published in 2005, and summarises reporting actions undertaken thereafter. The section also considers a number of instruments which can reduce climate forcing (or global warming) emissions, which

relate to fluorocarbons, and more specifically, to low Global Warming Potential (GWP) replacements for fluorocarbons. These instruments are looked at separately in the subsequent sections, such as regulatory frameworks, taxes, voluntary agreements and industry commitments. The paper finally gives some concluding remarks on the way forward.

---

## The political framework – the Montreal and the Kyoto Protocol

---

### Montreal Protocol

The Montreal Protocol was signed in 1987 (and its 20th anniversary was celebrated last year) and entered into force on 1st January, 1989. Shortly after the 1987 Protocol was negotiated, new scientific evidence conclusively linked CFCs to the depletion of the ozone layer and indicated that depletion had already occurred. Consequently, many countries called for further actions to protect the ozone layer by expanding and strengthening the original control provisions of the Montreal Protocol. The basis for strengthening the protocol was laid with Assessment Panels that should regularly report to the Parties, who then could decide to take further actions on the basis of scientific and technologically assessed background material. For technology and economics under the Montreal Protocol, the TEAP and its six Technical Options Committees is responsible. Where it concerns reporting requirements under Article 7 of the Montreal Protocol, Parties are required to report annually on production and consumption, on imports and exports and on destruction of all the specific ozone depleting chemicals as defined in the annexes to the Protocol. However, generally, there is no requirement to report on the emissions of the Montreal Protocol gases, and Parties are not required to report how and in which sectors the above-mentioned chemicals are used. Emissions reporting of ODS is only required for allowing certain process agents uses under the Montreal Protocol.

In September 2007, at the 20th anniversary of the Montreal Protocol, the 19th Meeting of the Parties decided to phase out the production and use of partially halogenated chlorofluorocarbons (HCFCs) in advance of the schedule envisaged by the Montreal Protocol until then. HCFCs not only deplete the ozone layer, but also harm the global climate as they have a high global warming potential – up to 2000 times greater than that of CO<sub>2</sub>. Moreover, the production of HCFC-22 generates the by-product HFC 23, a fluorinated hydrocarbon with a yet higher global warming potential (approx. 12,000 times higher than CO<sub>2</sub>). HCFCs have long served as substitutes for CFCs (chlorofluorocarbons) and production volumes of HCFCs are rising sharply, as demand for refrigeration and air-conditioning is growing steadily in the developing world. Under the new provisions, developing countries will freeze the production and use of HCFCs at the levels of 2009/2010 in 2013 and phase them out completely (2015:

10%, 2020: 35%, 2025: 67.5%) by the year 2030. A small proportion of 2.5% can continue to be used to service old equipment until 2040. In the industrialised countries, HCFCs will be phased out fully by 2020. The industrialised countries have pledged to support developing states in the phase-out process. The developing countries will gain financial assistance through the Multilateral Fund in order to switch to non-HCFC technologies, which are supposed to be more environmentally sound.

### United Nations Framework Convention on Climate Change (UNFCCC) and Kyoto Protocol

Under the UN FCCC /2/, countries are obliged to annually report the emissions of the greenhouse gases of interest. Although, many chlorine and bromine containing compounds with a certain Ozone Depletion Potential (CFCs, HCFCs etc.) are (possibly strong) greenhouse gases, their production and consumption quantities have to be reported under the Montreal Protocol, and not under the UNFCCC.

In Article 4, the Framework Convention /2/ mentions in paragraph 1(a):

1. All Parties, taking into account their common but differentiated responsibilities and their specific national and regional development priorities, objectives and circumstances, shall:
  - Develop, periodically update, publish and make available to the Conference of the Parties, in accordance with Article 12, national inventories of anthropogenic emissions by sources and removals by sinks of all greenhouse gases not controlled by the Montreal Protocol, using comparable methodologies to be agreed upon by the Conference of the Parties;
  - Formulate, implement, publish and regularly update national and, where appropriate, regional programmes containing measures to mitigate climate change by addressing anthropogenic emissions by sources and removals by sinks of all gases not controlled by the Montreal Protocol, and measures to facilitate adequate adaptation to climate change.

The Kyoto Protocol was signed in Kyoto, Japan, in December 1997. The aim of the Protocol is a reduction of the emissions of a basket of six gases in total (carbon dioxide, nitrous oxide and methane, as well as three fluorinated gases) by 2010 in the developed countries, compared to the baseline for a country, which was defined as its GWP weighted emissions in the year 1990. In order to be implemented, the Kyoto Protocol had to be ratified by at least 55 parties to the UNFCCC and the ratifying countries had to account for more than 55% of 1990 greenhouse gas emissions in order for the Protocol to become international law. Since the United States and Russia were responsible for 36% and 17%, respectively, of 1990 greenhouse gas emissions, these two countries were seen as key players, with the ratification of at least one of the two countries essential for implementation of the Protocol. The US Administration claimed

that the science was unsound and argued that adherence to the provisions of the Protocol would be harmful to the US economy. Russia used similar arguments to forestall ratification, but eventually was persuaded by the possibility of advantageous emissions trading coupled with pressure from the European Union in return for the EU's support of Russia's admission to the World Trade Organization (WTO). The Kyoto Protocol entered into force on 16 February 2005, ninety days after ratification by the Russian Duma (lower house of parliament). As of 12 December 2007, 176 nations had ratified the Protocol, accounting for 63.7% of the Annex-I-countries emissions 1990 greenhouse gas emission

The 13th Conference Of the Parties (COP) in Bali (December 2007) has agreed to launch negotiations for a post-Kyoto agreement, which shall be finalised by 2009. Independent from the Bali negotiations for a new international agreement, several countries have already announced their own GHG emission reductions targets. For example, the EU has recently announced to reduce its GHG emissions by 20% from 1990 levels by 2020. Germany has issued a 40% greenhouse gas emissions reduction by 2020 in December 2007. Further details on EU and national regulations are elaborated below in section 4.

The percentage emissions of HFCs in the total "Kyoto" basket is often discussed, and also how this percentage would increase between 2000 and 2100. Dependent on the country and how carbon intensive its economy is, the percentage of HFCs (GWP weighted) in the total emission is generally between 1 and 4% and may be somewhat larger by the year 2010. For the year 2100, estimates for fluorinated gas emissions vary widely, up to tens of percents of the total.

The HFC phase out can be fundamental to realise the Kyoto goals. Unlike to most of the other Kyoto gases, growing use of HFCs could be halted and possibly reverted as there are sufficient alternatives to eliminate to a substantial degree the need for those substances. Overall HFC emissions may therefore be reduced at short term, with less efforts and costs to the global community than for example similar reductions of CO<sub>2</sub> in the transportation sector.

### Interlinkages between the Montreal and the Kyoto Protocol

It has long been understood that stratospheric ozone depletion and climate change have inter-linkages, because both Ozone Depleting Substances (ODSs) and their alternatives contribute to climate change. In recognition of this fact, the 8th COP to the UNFCCC took a decision inviting the Intergovernmental Panel on Climate Change (IPCC) and the TEAP under the Montreal Protocol to develop a balanced, scientific technical and policy relevant Special Report. This report was finalised and approved by governments in 2005 /3/.

In the figure below, the institutional frameworks for the two protocols are given (both Montreal and Kyoto), as well as the institutions that provide assessment reports, and in particular here the IPCC and the TEAP. The IPCC/TEAP Special Report concludes that the reductions in ODS being implemented under the Montreal Protocol have and will continue to have a substantial benefit on climate change.

Although HFCs and HCFCs generally have lower global warming potentials than the CFCs for which they are generally used as replacements, the anticipated growth in the use of these fluorinated gases will further contribute significantly to global warming. By utilizing low GWP natural refrigerants in the replacement for HCFCs one can avoid the development of unconstrained growth of HFC use and its associated global warming potential.

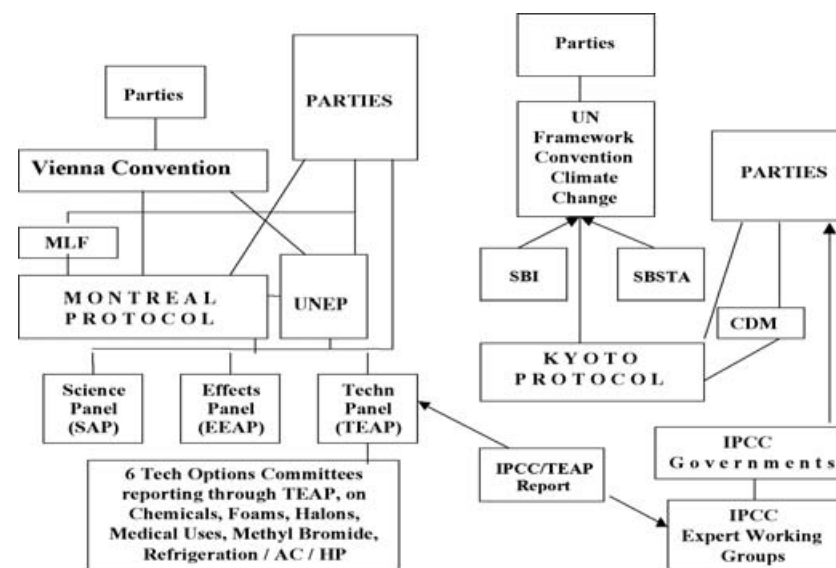

Figure 1: Framework of institutions and linkages between them, for both the Vienna Convention-Montreal Protocol, as well as the UNFCCC Convention and the Kyoto Protocol (UNEP stands for United Nations Environment Programme, MLF for Multilateral Fund, and CDM for Clean Development Mechanism)

The primary opportunity suggested in the Special Report as it relates to ODS and protection of the ozone layer is to address emissions from banks of ODS through improved containment of substances, reduced charge of substances in equipment, end-of-life recovery and recycling or destruction, and, increased use of alternatives with a low or negligible GWP or by the use of not-in-kind technologies.

Banked material is defined in the report to include substances that have been produced but not yet released to the atmosphere, including CFCs stored in existing equipment as a pure chemical, and distributed within the cells of foams. The Special Report notes that a substantial fraction of emissions of ODS are and will continue to come from ODS being emitted from banked sources, but that there are currently no requirements under the Montreal Protocol for Parties to apply best practices when it comes to bank management or end of life treatment.

Greenhouse gas emissions can significantly be avoided or reduced through accelerated replacement of HCFC with low-GWP alternatives. Collection and destruction of surplus ODS contained in banks or in products also has important ozone, climate, and air quality benefits. While in the past none of above potential measures related to ozone layer protection have been required or rewarded by the Montreal Protocol, a number of them have already been implemented by some Parties.

There is a wide range of policies, measures and instruments that can reduce related emissions. These include:

- Regulations (e.g.: mandatory technology and standards; production restrictions);
- Financial incentives (e.g.: taxes on emissions, production import or consumption; subsidies and direct government spending and investment; deposit refund systems and tradable and non tradable permits); and,
- Voluntary agreements.

These policies and regulations, measures and other instruments will be elaborated upon in the following section.

---

## Policies, regulations, measures and other instruments

---

### Regulatory measures

The Montreal and Kyoto Protocol represent regulatory frameworks for the control of globally hazardous substances. This fact has been dealt with above. This section elaborates on regulatory measures by the European Union (EU) or by individual countries. In 2000, the EC adopted regulation 2037/2000, which mandates an accelerated phase-out of HCFCs in the production of new equipment by the year 2001-2004. The consequence of such a regulation is that one perceives that there is a driver to non-ODP solutions, whether HFCs or other substances. In 2003, the EC proposed a

regulation on fluorinated gases (“F-gas”) under the ECCP (European Climate Change Programme). This regulation 842/2006 was adopted in the course of 2006 and covers all F-gas applications except domestic refrigerators and mobile air conditioning. It makes it mandatory to contain via the control of systems via leakage detection systems that are regularly checked, to recover and recycle, to monitor and archive, to label, to train and certificate servicing personnel, to restrict marketing of F-gases for emissive uses, etc. However, the effectiveness of the F-gas directive is consequently determined by the national implementation, because the F-gas regulation tries to limit HFC emissions and does not implicitly aim at a reduction of the consumption or use.

Netherlands, for example, introduced already a far more strict (STEK) regulation years ago, it requires independent audit and the experience is that global warming emissions from refrigeration and AC equipment can be reduced substantially by this type of regulation. Also in 2006, the EC adopted the directive 2006/42 on emissions from mobile air conditioning (MAC) systems, which is likely to have significant consequences. The MAC directive proposes to halt the application of HFC-134a in new model vehicles by 2011, and in all new cars by 2017; only alternatives with a GWP lower than 150 would be allowed after these dates. In fact, this would only allow the current alternatives hydrocarbons, carbon dioxide, or HFC-152a (or ammonia) or other low GWP HFCs in mobile air conditioning systems. Although flammable refrigerants such as hydrocarbons have been discussed for a long time, a breakthrough has not taken place during the last decade. Therefore, German car manufacturers focused their research on chemical blends and CO<sub>2</sub> as a refrigerant for MAC. Finally, they found CO<sub>2</sub> the only suitable option and became the first movers in Europe.

Countries such as Austria and Denmark and Switzerland have banned HFC refrigerants in a variety of equipment. However, it is not clear how much their ban of HFCs could stimulate certain developments in future and what the influence of these countries will be on the EU level. Luxembourg has also banned HFCs in many applications and here ammonia is applied in all types of equipment with a capacity larger than 150 kW.

### Financial incentives and market mechanisms

The relative costs of HFCs and other alternatives to ODSs will impact the choices of both the users and the producers of these substances. Since HFCs are more expensive than the ODSs they replace, they will further encourage the substitution to not in kind or low GWP substitutes. Financial incentives can further shape this cost differential between substances and technologies.

Deposits or taxes on HFC import and production are collected by several countries. Deposits and taxes raise the cost of HFCs, encouraging containment and making recycling more attractive. Tax rebates for the delivery of used HFCs to destruction facilities provide incentives to minimise emissions in particular at end-of-life. For example, in Norway there are rebates of about 20 Euro per tonne CO<sub>2</sub> equivalent. These rebates

can or will often be combined with taxes on import or production. Under the new decision (XIX/6) of the 19th MOP on the HCFC accelerated phase out, conversion projects of HCFCs to natural refrigerants (such as hydrocarbons in the insulation of domestic refrigeration) can be funded by the Multilateral Fund under the Montreal Protocol. These projects may experience a priority vs. HFCs because of the superior climate benefits if such solutions maintain an acceptable cost effectiveness.

Emission reductions of gases controlled under the Kyoto Protocol (e.g. conversion of HFC emitting uses) have a chance to be additionally financially supported through the Clean Development Mechanism of the Kyoto Protocol. However, in some cases because of the formal requirements for monitoring or baseline assessments or the varying market price for Certificates of emission reduction (CER), the income might be too marginal to serve as an incentive.

### **Voluntary agreements and industry commitments**

A number of other agreements and commitments by the industry has caused larger changes in the use profile of fluorinated gases versus low GWP alternatives.

**Domestic refrigeration:** With the introduction of the “Greenfreeze” concept in 1992, a major breakthrough was realised by Greenpeace, which led German manufacturers to consider the application of hydrocarbons in both the circuit and the insulation of domestic refrigerators. Although in a first instance considered as a valid option for certain appliances only, competition arguments and the drive for green consumer products has caused a total market shift to hydrocarbons in virtually entire Western Europe. More than 50% of the appliances currently manufactured in the world uses hydrocarbons and this has had major impacts on the acceptance of hydrocarbons.

**Commercial refrigeration – small units:** With the emphasis on a change of refrigerants (HFC-134a) in vending machines for the Olympics in 2004, a major breakthrough was again realised by Greenpeace, which led to the consideration of natural refrigerants by global refrigeration equipment manufacturers. Several companies from the food and drink industry have since then implemented and tested HFC free cooling technologies and have committed themselves to develop timelines and convert their point of sale applications step-by-step to natural refrigerants. The fact that all the manufacturers that committed themselves to what they see as the only possible change to sustainable solutions, are united in the “Refrigerants Naturally” makes this initiative a powerful tool to keep stimulating a fragmented industry in this sub-sector.

**Commercial refrigeration – supermarkets:** In 2007, several supermarket chains in Europe have announced their move to natural refrigerants, in most cases to CO<sub>2</sub> technologies. Even though in many cases, commercial refrigeration (supermarkets) still use HCFC-22 and HFC blends as alternatives, the equipment producing industry are not

the driver, but the supermarkets, wanting to declare their refrigerated or frozen products to be green. Therefore, it may be more difficult than in the domestic refrigeration industry, still a tendency has started which has led to the increased application of hydrocarbons and ammonia in supermarket systems with secondary circuits and in smaller distributed systems, and to the use of carbon dioxide in heat transfer processes.

**Large size refrigeration:** Ammonia is already used as a refrigerant in all fields of industrial refrigeration and about 15% of the total refrigerant market. Ammonia is identified as the most cost effective and also efficient option for all types of industrial equipment, while users accepting the disadvantages of ammonia with some reluctance, because it implies strict regulatory compliance. More applications of ammonia are also expected in chillers and in commercial refrigeration, as long as there are no major cost disadvantages and regulatory compliance is acceptable. Carbon dioxide is now also applied in vapour compression cycles in large size or in industrial refrigeration, combined with an ammonia vapour compression cycle to cool the condenser. These systems can be combined with a pumped carbon dioxide system (secondary circuit), so that several temperatures can be maintained in different compartments. In all of this applications ammonia use is going to grow further due to its technical and cost advantages.

**Mobile Air Conditioning:** Mobile air conditioning is – or has been – the largest driver for the production of HFC-134a. Since the mid-nineties the development to use other refrigerants than HFC-134a was taken up. If all MAC systems would switch to a non-HFC-134a, non-fluorocarbon solution, the manufacturing and marketing conditions for HFC-134a and its blends for the use in other refrigeration and air conditioning sub sectors would drastically change. This could well accelerate developments of low GWP substances in many parts of the world. In 2007 already, several German car manufacturers finished their research on chemical blends and announced to use CO<sub>2</sub> as refrigerant for MAC in their new generation of air conditioning systems.

**Stationary Air Conditioning:** Stationary (and particularly) unitary air conditioning has used HCFC-22 for a long time. Conversion is taking place to HFC blends and to low GWP alternatives. In the case of HCFC-22, propane is implemented by several Air Conditioner manufacturers and it has proven to be highly energy efficient and requires little technical changes in the conversion, except for safety reasons. Where many thousands of small units have been charged with propane, this tendency has yet not been observed with larger systems, where more and more the split systems have become common. Nevertheless, some large manufacturers in developing countries investigate also this option. If one looks at it world-wide, including all developing country manufacturers, it is questionable whether a one way route that will be chosen for alternatives where large numbers of small equipment are manufactured in a number of developing countries and then exported, it could be expected that a general conversion to low GWP alternatives will take a similar time frame as in the refrigerator sector before.

---

## Concluding remarks and the way forward

---

The transition or conversion from ozone depleting chemicals (such as CFCs) has occurred in all developed countries via the use of HCFCs or HFCs in many types of refrigeration/AC equipment. In case of domestic refrigeration there has been a direct change from CFCs to isobutane in the refrigeration circuit. This applies to developed countries, but also to a number of industries in the developing countries.

Guidelines for a change from HCFCs to alternatives are under development. But the recent developments in terms of regulatory incentives, innovative technology solutions and cost implications, voluntary agreements and industry commitments are directing towards a change to low GWP alternatives, with natural refrigerants being the most prominent ones. In these sub sectors the greening of the consumer or the emphasis on sustainability via green products has often been an important driver, almost independently on the cost implications of the change to low GWP alternatives. In the case of mobile air conditioning, the regulatory driver has become the main one. The CO<sub>2</sub> choice by carmakers in Germany will also have consequences for the refrigerant choices that will be made for other types of refrigeration and AC equipment in the future.

In other industries, where the timelines are not as important, choices will be made against a different background. It is important to state that these industries will make a choice or will commit themselves to a development that has a low risk of being challenged again in future, which implies that it is very likely that one will make a choice to go to low GWP refrigerants, which in most cases will be natural refrigerants.

In the total refrigeration and AC market, the share of low GWP and natural refrigerants in specific is expected to grow, with relatively large differences regionally in the very near future. However, this may well change drastically in the longer term. Consideration of the impacts of climate change and the necessary mitigation measures are expected to have a further large impact on the future choices made by industry and therefore on all technical developments.

---

## References

---

/1/ Climate Change 2001, Mitigation, Contribution of Working Group III to the Third Assessment Report of the Intergovernmental Panel on Climate Change, Cambridge University Press, 2001, ISBN 0 521 01502 2.

/2/ The United Nations Framework Convention on Climate Change, Full Text of the Convention (see under <http://unfccc.int>).

/3/ Intergovernmental Panel on Climate Change (IPCC) and the Technology and Economic Assessment Panel (TEAP), Safeguarding the Ozone Layer and the Global Climate System: Issues Related to Hydrofluorocarbons and Perfluorocarbons, World Meteorological Organization (WMO), Geneva, Switzerland, and the United Nations.

/4/ UNEP, 2006 Assessment Report of the Refrigeration, AC and Heat Pumps Technical Options Committee, UNEP Nairobi, February 2007.

# Modernizing Refrigeration Equipment with the Kyoto Protocol's Clean Development Mechanism

DR. THOMAS GRAMMIG, GTZ Proklima, Germany

---

## Introduction

---

During 2007, 12 billion Euros were invested worldwide in reducing climate changing emissions via the Clean Development Mechanism (CDM). This is a four-fold increase over 2006 and this trend in expanding CDM continues in 2008. Around one-fifth of these CDM projects concerned energy efficiency improvements and among these, just a few comprised the modernisation of refrigeration equipment. The most prominent example is a CDM project to replace 531 chillers in India.

The following article proceeds in three steps. First, the basic aspects of energy efficiency CDM for refrigeration are presented. To illustrate such CDM projects, the chiller CDM is then described, outlining the major operational and financial features which influence the multiplication of such CDM. In the third part, a broad outlook on the near future for refrigeration CDM is attempted.

---

## Energy efficiency CDM for refrigeration

---

CDM is a creation of the Kyoto Protocol and the U.N. Framework Convention for Climate Change. It is thus a set of rules produced by a multilateral organisation defining how private entities can engage in emission reduction efforts in developing countries (non-Annex 1-countries) and trade the emission reduction achieved on the global market. All CDM rules, information, decisions and negotiations are public and subject to intense scrutiny. The U.N.-FCCC website is the only official source, [www.unfccc.int](http://www.unfccc.int) and it contains all relevant documents in standardised and rigid formats.

Any company, Non-Governmental-Organisation (NGO) or other organisation can elaborate a CDM project and submit it to the U.N.-FCCC. After validation, verification and monitoring the CDM, the U.N.-FCCC issues emission reduction credits called Certified Emission Reductions (CER) to the CDM project owner. Each CER corresponds to one tonne of CO<sub>2</sub>. In 2007, 350 mio. CERs were sold into the global



market. This market for CERs is rapidly expanding and diversifying, however its dependence on the U.N.-FCCC as its regulator, gives this market a unique type of uncertainty. As any emerging market, the CDM market proceeds in the order of specific costs, i.e. investment volume per CER. Specialised companies are active in each country, analysing CDM opportunities and mass-producing CDM project documents for submission to the U.N.-FCCC. Some of these companies are publicly listed and their competition is intense.

The investments in emission reductions with the lowest specific cost have been in the production of the refrigerant HCFC-22. All of these opportunities are already realised. At present, the highest number of CDM projects coming to the market are hydropower, windpower and N<sub>2</sub>O in nitrogen fertilizer plants. As the CDM market expands, the type of CDM projects change in the order of their rising specific costs. Once all nitrogen fertilizer plants are submitted for example, other CDM projects with higher costs per CER will appear in order to satisfy the demand. Currently, the largest part of the demand for CERs are the purchases from European utility companies such as Endesa, Enel, RWE, E-ON, Vattenfall and so on.

Energy efficiency CDM projects on the demand-side have lower investment costs than windpower or hydropower, however at present, their return on investment is also lower because of the energy efficiency improvement level and transaction costs. Correspondingly most CERs traded currently are from windpower and hydropower, see figure below.

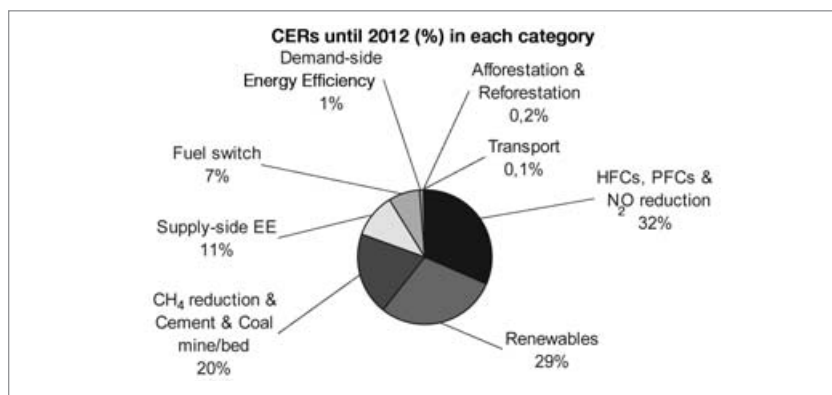

Figure 1: Types of CDM Projects developed so far, by volume of CER  
Source: UNEP Risø Centre, <http://cdmpipeline.org> accessed 1 February 2008

The World Bank's chiller CDM project in India is the first large energy efficiency CDM in refrigeration with 2.4 mio CERs over its 7 year lifetime. It will demonstrate the specific costs of such refrigeration CDM. The principle reason why energy efficiency CDM have not been undertaken faster is that energy efficiency gains (kWh

saved) are distributed over many small sites. For a single refrigeration unit, the administration costs to realise a CDM are relatively high and therefore other CDM in larger units (such as windpower) are cheaper. The overall specific cost of refrigeration CDM reflects the cost of aggregating many refrigeration units in one CDM project.

Overall, refrigeration CDM has not been pursued because the expanding CDM market still has cheaper emission reductions in the pipeline. CDM projects comprising several hundred small refrigeration units are likely to become competitive in 2008. The point in time when this happens depends on the demand for the emission reductions, the CERs. For example, when the governments of the USA and Australia join the EU in obliging industry to purchase CERs (legislating cap-and-trade emission reductions), the demand for CERs will increase and with disappearing hydropower and windpower opportunities, energy efficiency CDM projects will expand.

## India – Accelerated Chiller Replacement Programme

On 30 November 2007, the U.N.-FCCC approved a Chiller CDM in India. This CDM is a cooperation between one of the largest banks in India, ICICI, and the World Bank. In setting this precedent, a special CDM methodology for chillers was created, called AM0060, which is now available for anybody to use. The CDM project will replace 531 chillers across India. The CDM project owner is the Indian bank and as a financial service company it is a suitable project owner allowing the aggregation of a number of refrigeration units. Besides the financial results, this CDM will illustrate that this aggregation role of the project owner is important.

ICICI decided to exclude the choice of chiller technology from the conditions it offers to the chiller owners, posing only one condition. Any chiller can be part of this CDM project, as long as the Global Warming Potential (GWP) of the refrigerant in the new chiller is lower than the GWP of the old one. This implies that a CFC-11 chiller or a CFC-12 chiller can be replaced with a HCFC-123, a HFC-134a, an Ammonia or a Hydrocarbon chiller. The chiller owner chooses the technology. ICICI anticipates that most chillers replaced in this CDM project will be CFC-11 and CFC-12 ones, but a smaller number of HCFC-123 and HFC-134a will be replaced as well.

The total financing volume of the CDM project is 91.3 mio US\$. Approximately 90% of the cost is provided by the chiller owners. The remaining 9.1 mio US\$ is the contribution by ICICI. The CER revenues are estimated at 14 mio US\$. These figures are given in the official CDM documents submitted to the U.N.-FCCC.

ICICI offers a credit to the chiller owner, who is responsible for the chiller purchase, installation and operation. ICICI's credit offer comprises financing the total chiller investment, or only the part of the investment financed with the expected CER income. A chiller owner can choose a different source of financing for the part not covered by

the CDM. In other words, ICICI administers the CDM project giving the chiller owners maximum freedom to proceed as they wish, while ICICI assumes the risk for the CDM registration and the CER trading.

The CERs achieved in the implementation of the CDM project become tradable when they are issued by the U.N.-FCCC and a secondary market for CERs not yet issued is also well established. Every year, an independent auditor has to control whether the power savings in kWh correspond to the expected savings (340,000 CERs p.a. over 7 years). The auditor submits a "CDM Monitoring Report" to the U.N.-FCCC for approval. ICICI estimates that the new chillers financed in this CDM project are 40 – 50 % more energy efficient than the old ones. ICICI can receive more CERs than projected and these CERs can bring a higher income when the prices for CERs in the global markets are higher than projected. ICICI assumes the financial risk of this CDM project comprising the monitoring accuracy and the CER trading conditions. At 14 mio US\$ CER income from 2.4 mio CERs, ICICI uses 5.8 US\$/CER in its financial planning. During 2007, the price actually fluctuated around 20 US\$/CER and so ICICI used an average price estimate at a quarter of the current level. The future price of a CER depends mainly on the political will of OECD countries to allow its industry to invest in emission reductions in developing countries. Some OECD countries require most emission reductions to be achieved domestically rather than in developing countries.

Many international banks have recently established their capacity to provide such CDM financing services, ABN Amro, Barclays, BNP, Morgan Stanley, UBS, to name only the most prominent ones. As a prominent Indian bank, ICICI is well suited to implement the CDM project in India, but there are no restrictions on who assumes ownership of a CDM project. In place of ICICI it could also be a financial service provider from any other country. Evidently a refrigeration equipment manufacturer could also assume this CDM project owner role. At present, large manufacturers such as Trane and Carrier are changing their financing services to integrate CDM finance. The CDM methodology AM0060 contains the rules for the calculation of the emission reduction. It stipulates that each old chiller must be tested at different load conditions prior to dismantling. Such a test can be realised within one day and allows establishing a numerical power consumption function for the old chiller. The new chillers are fitted with continuous data loggers, recording the actual load. This data logger transmits the load data to a computer every day. The power consumption function of the old chiller allows calculating the electricity the old chiller would have used. The difference to the new chiller is the energy saving in kWh. Finally, the old chiller's compressor unit must be cut with a blow-torch when it is dismantled to avoid that it could be re-used elsewhere (thereby eliminating the emission reduction). Specialised auditing companies, so-called Designated Operational Entities (DOE) have to be used to verify that the data for the methodology and the calculations are correct.

These rules in AM0060 might seem rather stringent, but the Kyoto Protocol regulations for CDM require that the emission reduction must be measured with accuracy and a certain level of conservativeness in the calculations has to be assured. The environmental integrity of the CDM projects relies on this accuracy. While the U.N.-FCCC is sometimes criticised for being bureaucratic and for imposing unnecessary costs to CDM projects it must be stressed that the accuracy of the emission reduction results is also required to ensure that all technologies and all sectors are treated equally. Creating extra CERs by manipulating measurements in a CDM project is equivalent to printing money. The U.N.-FCCC acts like a central bank protecting its currency. Careful engineering of the monitoring technology in a CDM project, demonstrated transparently to the public, has often lead to quick CDM approval and implementation. On the contrary, stubborn insistence on partial data such as in the refrigeration CDM project by Pao de Acucar (submitted three times in a row over two years), the largest Brazilian supermarket chain, only creates unnecessary precedents.

---

## Outlook for refrigeration CDM

---

Five major factors will determine when CDM projects will be realised on a large scale to finance refrigeration investments.

### **New methodologies for large-scale demand-side energy efficiency projects**

Aggregating many appliance units poses a number of specific conditions for their approval by the U.N.-FCCC. The cost of monitoring the electricity savings is reduced when only a sample of the appliances has to be monitored. For each type of appliance this sampling is different. For lightbulbs, the sample must comprise representative lighting use behaviour and such a sample can be only 50 – 100 households out of a CDM project for millions of lightbulbs (methodology AM0046). There, the distribution of the new energy efficient lightbulbs (CFL) is the major cost item. For refrigerators and for Air Conditioners, the user behaviour is different and suitable sampling procedures must be developed. For industrial refrigeration, solutions akin to the power consumption function for chillers (methodology AM0060) can be used. Three new methodologies for refrigeration have been submitted and await approval.

### **Besides finance institutions, utilities, ESCOs and manufacturers are potential CDM project owners**

Because monitoring costs are a significant part of CDM project costs, utilities, Energy Service Companies (ESCOs) and manufacturers can reduce these costs and function as CDM project owners. Utility companies produce a monthly electricity bill to their customers and can offer customers rebates when they purchase more efficient refriger-

ation equipment. The utility can monitor a sample of appliance users with little extra costs. Likewise, equipment manufacturers can offer their clients to participate in a CDM project and target this offer to those clients using particularly inefficient old refrigeration equipment. The lower the efficiency of the equipment replaced, the higher the additional income from CDM. Manufacturers can prepare different CDM projects for different client types, reflecting their client's financial situation and possibly also the manufacturer's technological capacity.

#### **Refrigeration with HFC-134a and HFC-404a offer a particular incentive**

Among the six gases in the Annex 1 of the Kyoto Protocol, HFC gases are the only refrigerants eligible as contributing to global warming and thus as CDM emission reductions. All refrigeration equipment with HFC-134a that is replaced with non-HFC refrigerants effectively eliminates emissions of HFC-134a. With its GWP of 1,300 (in other words 1 ton of HFC-134a emissions avoided yields 1,300 CERs), such CDM projects should be very profitable. The first HFC-134a replacing CDM projects are currently implemented for car air-conditioners and refrigerators. Once their profitability is demonstrated a wave of such CDM projects will appear. Other HFC-134a uses such as in the manufacture of insulation foam are a special case and respective methodologies and pilot CDM projects have been elaborated.

#### **New regulations for Programme of Activities are well suited for refrigeration**

Taking into account the aggregation problem for demand-side energy efficiency projects, the U.N.-FCCC has recently created a new type of CDM with conditions that allow for starting a small CDM project and expanding it over time. For the above described Chiller CDM in India, this would have allowed starting it with only a smaller number of chillers, for example only CFC-12 chillers of a certain size, and later on expand it with different conditions for other sizes and refrigerants. Thereby the CDM project owner can offer more advantageous conditions to each equipment owner. Programme of Activities (PoA) CDM are currently being prepared for household refrigerators and Air Conditioners.

#### **Energy prices can reach a level where the additional income from CDM is sufficient to cover the higher investments of more efficient refrigeration equipment**

The most important parts of refrigeration equipment, the compressors, are not price-sensitive for higher efficiency. Higher efficiency refrigerator compressors for example cost only 10 – 20 % more than standard compressors. When energy prices translate into typical payback periods of 3 or 5 years for investments in higher efficiency refrigeration equipment, the additional income from CDM above the benefit of lower energy bills can shorten the typical payback by 1 to 2 years.

# Protecting the Ozone Layer and the Climate from Halogenated Substances

## Measures in the European Union

KATJA BECKEN, Federal Environment Agency, Germany

---

### Introduction

---

The chemical industry developed fully halogenated chlorofluorocarbons (CFCs) in the 1930s. Their non-combustibility and technical properties made these substances welcome in many industrial applications. They soon were used on a large scale. For example, as so-called safety refrigerants, they replaced a number of refrigerants previously used, some of which are harmful to health such as SO<sub>2</sub>.

After the ozone depletion potential of these substances had been discovered (ozone depleting substances, ODSs), they became the subject of international discussions. These discussions resulted in the Montreal Protocol. At the same time, the search for possible alternatives began. Research first focussed on substances chemically very similar to CFCs. Soon in this process, hydrochlorofluorocarbons (HCFCs) – which were already known as refrigerants - were increasingly placed on the market. Since HCFCs have a considerably lower ODP than CFCs, they were not initially covered by the Montreal Protocol.

Despite this fact, many scientists and environmental authorities did not consider HCFCs to be a sound long-term alternative, either [UBA 1989]. The chemical industry in industrialised countries soon saw itself confronted with a possible ban on these substances. Therefore, in further developing alternative substances, the chemical industry focused on chlorine-free alternatives, mainly perfluorocarbons and hydrofluorocarbons (PFCs and HFCs). It was especially the HFCs that contributed to a fast ODS phase-out in some areas, in developed countries. In parallel, industrial users were working on the use of non-halogenated substances, developing new technologies and improving existing ones. As a result, halogen-free ODS substitutes established themselves right from the beginning in many areas of application, for example as solvents or cleaning agents, as refrigerants, as fire extinguishing agents and in many areas of foam production.

In the late 1990s, the knowledge that PFCs and HFCs are harmful to the climate sparked discussions about measures to reduce emissions of fluorinated gases on the

basis of halogen-free technologies. Some Member States of the European Union (EU) were quick to implement rigorous measures such as use prohibitions or taxes. For many users, the fast succession of developments and measures meant having to switch technologies several times in a relatively short time span. On the other hand, clear policies enabled users and developers to pursue long-term technologies early on, and costly double conversions could be avoided in some sectors.

Some processes and products based on the use of non-halogenated substances have only in recent years reached a technical level that makes their use ecologically and economically viable. This is true, for example, for the use of CO<sub>2</sub> as refrigerant. Today, these techniques can fully replace processes and products that were based on fluorinated gases and were indispensable at the time. This presents an opportunity for countries which have not yet converted to these substances and may thus directly switch to halogen-free alternatives.

---

## Measures for protection of the ozone layer

---

In September 1987, 25 governments and the Commission of the European Communities signed the “Montreal Protocol on substances that deplete the ozone layer”. The timetable initially agreed in 1987 was tightened several times and additional measures were added as stipulated at the follow-up conferences in London (June 1990), Copenhagen (November 1992), Vienna (December 1995), Montreal (September 1997) and Beijing (1999) <http://ozone.unep.org/>. It soon became evident that the emission reduction initially envisaged by the international community was insufficient. As a consequence, the agreements soon laid down continual reductions in production and consumption with the objective of a complete phase-out.

### Measures in the EU for protection of the ozone layer

At European level, the Montreal Protocol has been transposed by Regulations, most recently in 2000 by Regulation (EC) No 2037/2000 [EC Regulation 2000]. The provisions laid down in these Regulations are directly applicable in all Member States. Initially, only the internationally mandated production and consumption reductions were legally binding for the EU. The latest Regulation now also includes gradual use prohibitions for various applications.

The most important provisions of the Regulation include a prohibition on the production and use of CFCs as well as the reduction of permitted levels of HCFC production and use. The latter provisions are currently being adapted to reflect the most recent decisions, adopted in Montreal in 2007. As control instruments, quota, licensing and reporting systems have been introduced. To steer scarcer HCFC resources, the Regulation lays down the above-mentioned gradual use prohibitions for various appli-

cations, depending on the availability of alternatives and the costs associated with their use. Today, products containing ODSs may no longer be placed on the European market. The use and placing on the market of CFCs have been generally prohibited in the EU since 2001, for all applications (including hermetically sealed systems). Continued use of HCFCs is allowed only for the servicing and operation of existing refrigeration and air conditioning systems. Up until the end of 2009, virgin HCFCs may be used for this purpose; thereafter, only recycled HCFCs (up until 31 December 2014). The continual reduction of the quantity placed on the market may reduce refrigerant availability even before the use prohibition becomes effective.

In keeping with the Montreal Protocol, exemptions apply in principle for feedstock and processing agent uses as well as for essential and critical uses, which are insignificant in quantitative terms.

As well as prohibitions, the EU Regulation also defines requirements for the servicing and leak-checking of refrigeration and air conditioning equipment. For instance, it requires all practicable precautionary measures to be taken to prevent and minimise leakages of CFCs and HCFCs. It also requires that fixed equipment with a refrigerant charge of more than 3 kg be checked for leakages annually by qualified personnel.

CFCs and HCFCs contained in refrigeration and air conditioning equipment, heat pumps, and domestic refrigerators and freezers must be recovered and disposed of or recycled.

To inform the public and especially the users, the EU and Member States have published brochures providing general information. They also publish “frequently asked questions” about specific legal provisions. The relevant sectors of industry, and especially the users and developers of innovative halogen-free technologies, are involved in the development of use-related regulations.

### Measures in Germany and other EU Member States for protection of the ozone layer

The EU Member States have implemented their international commitments in different ways at national level. Germany took the lead in the EU as regards ODS legislation by adopting a CFC/Halon Prohibition Ordinance as early as 1991. This Ordinance of 1991 already included extensive bans on the use of CFCs and HCFC-22, which gradually became effective up to the year 2000. The current Ordinance on substances that deplete the ozone layer (ChemOzonSchichtV), which has been applicable since 2006, implements the requirements of EC Regulation 2037/2000 with regard to the recovery and take-back of ozone-depleting substances such as R 22 as well as provisions relating to checking the leak tightness of certain equipment. It also adopted national provisions which had already been applicable over and beyond those of EC Regulation 2037/2000.

Other Member States have also enacted prohibition legislation, most of them at a later date. Some have additionally introduced taxes on ODS to make their use less economically viable and recycling more attractive. Denmark was one of these countries. Other Member States have mainly opted for technical emission control regulations. The feature all of these national regulations have in common is that they apply in addition to those of the EU.

---

## Measures to protect the climate from fluorinated greenhouse gases

---

Climate protection has been gaining in importance since the Rio Conference in 1992 and the Framework Convention on Climate Change that was signed there. The Convention aims to stabilise anthropogenic greenhouse gas emissions in order to prevent global climate change <http://unfccc.int/>. In December 1997, by signing the Kyoto Protocol, industrialised countries for the first time made a binding commitment to reduce their greenhouse gas emissions. The European Union ratified the Kyoto Protocol in 2002, and it entered into force on 16th February 2005. Whilst industrialised countries as a whole committed to achieve an average reduction of 5.2%, the European Union set itself the internationally binding target of reducing its greenhouse gas emissions by a total of 8% by 2008-2012 compared to 1990. In the framework of burden-sharing within the European Union, Member States took on different reductions, Germany committing itself to a reduction of 21%. Due to their high and in part extremely high GWP, the fluorinated greenhouse gases HFCs, PFCs and SF<sub>6</sub> are covered by the Kyoto Protocol and included in the reduction commitments. CFCs and HCFCs, which are already subject to a phase-out under the Montreal Protocol (see above), are not.

### Measures in the EU to protect the climate from fluorinated greenhouse gases

To achieve the objectives defined in the Kyoto Protocol, the EU has launched a number of climate change programmes <http://ec.europa.eu/environment/climat/eccp.htm> comprising extensive sets of measures. One was the reduction of emissions of fluorinated greenhouse gases, which are used predominantly as substitutes for banned ODS. Following many years of discussions with Member States and industry, Regulation (EC) No 842/2006 on certain fluorinated greenhouse gases entered into force in 2006 [EC Regulation 2006]. The Regulation sets use-related requirements (for example, regular checks for leakage), prohibits individual high-emission uses, and requires recovery of fluorinated greenhouse gases and labelling of products and equipment containing them.

In particular, operators of stationary equipment are required to prevent leakage of the refrigerants concerned and to ensure that their equipment is checked regularly for leakage by certified personnel, the frequency increasing with the size of the equipment. In addition, operators of equipment containing 300 kg or more must install a leakage detection system. To monitor compliance with the requirements, the Regulation requires certain data to be reported such as the quantity and type of fluorinated greenhouse gases installed, any quantities added and the quantity recovered during servicing, maintenance and final disposal. Recovery is mandatory. Labelling requirements ensure user information and enable selective recycling.

For air conditioning systems in motor vehicles, Directive 2006/40/EC relating to emissions from air conditioning systems in motor vehicles was adopted at the same time [EC Directive 2006]. This Directive defines maximum rates of emission of fluorinated greenhouse gases from air conditioning systems and prohibits the use of gases with a GWP higher than 150 in new vehicle types from the year 2011. A general ban for new vehicles will be effective from 2017.

### Measures in Germany and other EU Member States to protect the climate from fluorinated greenhouse gases

Some EU Member States had already adopted measures prior to issue of the EU Regulation in order to combat uncurbed growth in emissions of fluorinated greenhouse gases. For example, in addition to economically relevant taxes on fluorinated greenhouse gases, Denmark introduced extensive use prohibitions. Other Member States defined ambitious technical requirements for the use of these substances in order to minimise emissions as far as possible.

All other Member States will adopt national measures to transpose the EU provisions into national law. Some will introduce stricter measures. Germany, for instance, plans to set very strict requirements for the leak tightness of refrigeration and air conditioning equipment, in the form of maximum permissible leakage rates. Furthermore, it plans to financially support innovative technologies without fluorinated greenhouse gases in order to increase their market penetration.

---

## Impact of the measures described

---

At the time of the Montreal Protocol, the foremost goal of the EU and its Member States was to implement the ODS phase-out as quickly as possible. Due to high interest in a fast phase-out, Member States provided financial support, to a varying extent, for the development of halogen-free products and processes, including conversions to halogen-free processes in small companies.

The public was well-informed and the demand for such products was high. Therefore, while the chemical industry was still developing halogenated alternatives, products with hydrocarbons or other non-halogenated substances such as ammonia were launched on the market. As a result, ODS-free products often dominated the market even before corresponding bans would take effect or be issued. In addition to the characteristic “ODS-free”, these products also featured good product characteristics and often an at least equivalent energy efficiency. Many companies used the resulting advertising opportunity to improve the marketing of their products.

Some examples of areas in which products and processes without HCFCs or, later on, without HFCs have established themselves are given below:

- ODS replacement as solvent: a nearly complete switch to non-halogenated substances
- ODS replacement in aerosols: a nearly complete switch to non-halogenated substances
- ODS replacement in foams: an extensive switch to non-halogenated substances

Since HCFCs do have an ODP, albeit a low one, scientists and policymakers in many Member States considered HCFCs to be an unsuitable alternative. Therefore, except for refrigeration, for which HCFC-22 had already been in use, HCFCs were used in Germany in only a few applications, e.g. in foam production. In these applications, they were only used for a short interim period and were soon replaced by non-halogenated substances and, in speciality applications only, by HFCs.

The situation was different in the refrigeration and air conditioning sector. Although hydrocarbons or ammonia were successfully introduced or relaunched in some few use sectors, e.g. domestic refrigerators and industrial refrigeration, technically mature alternatives were lacking for many applications. In these, CFCs were still used in existing equipment up until 1999, and in isolated cases HCFCs (mostly R 22) were still used in new equipment up until 2004. Today, refrigeration and air conditioning systems are predominantly produced with a variety of HFCs which have meanwhile been developed by the chemical industry. These substances, which are more expensive than natural refrigerants, are very similar to CFCs and therefore do not require any major change to systems, components, or the way of their handling. Since demand for them is high, they are available in sufficient quantities in Europe.

HFCs were therefore able to establish themselves widely in the refrigeration and air conditioning technology market. With some exceptions, there were no EU regulations barring the use of these substances. Because of their GWP, some scientists and environment authorities also took a critical view of HFCs from the very beginning and in part regarded them as only an interim solution [UBA 1889]. However, this was largely ignored. A public debate over these substances did not really take place.

A relevant discussion about this group of substances only started around the new millennium, when it was realised that the sharp increase in emissions of these substances

may frustrate climate protection efforts made elsewhere. In all those use sectors in which HFCs had already established themselves, the discussion on alternative substances was made more difficult by the fact that industry had already completed a “switch”. Many companies felt that another costly conversion to non-halogenated alternatives would be unreasonable. Nevertheless, the discussion, and the real possibility of the EU taking action on HFCs, brought conversions to non-halogenated alternatives in further applications as well as stepped-up efforts by industry to develop halogen-free products and technologies. This development was boosted by rigorous national prohibitions, e.g. in Denmark.

The Regulation on fluorinated greenhouse gases and the Directive on air conditioning systems in motor vehicles, adopted in the EU in 2006, contain only few prohibitions (e.g. on the use of HFCs in motor vehicle air conditioning systems, in certain aerosols, in one-component foams). Nevertheless, this EU legislation sent out a signal. Since it already provides for a review and extension of measures, producers and users are increasingly banking on non-halogenated substances.

One outcome of the discussion and of the various measures on HFCs is that the offered range of innovative products and processes without synthetic substances is much more diverse and advanced today than it was just a few years ago. This holds especially for refrigeration and air conditioning technology. One example are CO<sub>2</sub>-based heat pump water heaters, which have experienced an unprecedented rise. Also, in recent years, many renowned companies such as Coca-Cola, Marks & Spencer, Sainsbury's and Tesco have committed to abstain from using fluorinated greenhouse gases and are using this “green image” as competitive advantage. They are thus adding to pressure on equipment producers to develop and market halogen-free technologies.

However, overall it is clear that there is a distinct difference between ODS phase-out and the measures to control fluorinated greenhouse gases. Whilst specific prohibitions on ODS led to a fast phase-out of these substances, the mostly technical, more economically relevant measures on fluorinated greenhouse gases have brought about a rethink only very slowly. Users appear to be more reserved even where alternative products are available on the market. In many cases, the phase-in of HFC-based technology presents another obstacle to the introduction of halogen-free technologies today. This is expected to change as soon as sufficient political pressure is applied.

Overall, ODS phase-out in the EU has been successful. The measures implemented have led to a nearly complete phase-out of ODS. In all those cases where the phase-out occurred before fluorinated greenhouse gases were developed as possible alternatives or where their use was already prohibited, ODS phase-out was possible without phase-in of HCFCs or fluorinated greenhouse gases. Only in applications for which non-halogenated alternatives were not available low-ODP or zero-ODP substances were used as soon as they were launched on the market. Whilst HCFCs were only an interim solution right from the beginning, the EU today is confronted with a phase-

out of fluorinated greenhouse gases that in many cases will be politically difficult and long-term although halogen-free solutions exist [UBA 2004, IPCC 2005]. Because of the developments in recent years, countries which are only now embarking on final ODS phase-out have the big opportunity to avoid introducing other halogenated substances at the same time.

---

## References

---

**EC Directive (2006)** Directive 2006/40/EC of the European Parliament and of the Council of 17 May 2006 relating to emissions from air-conditioning systems in motor vehicles and amending Council Directive 70/156/EEC; <http://eur-lex.europa.eu/LexUriServ/LexUriServ.do?uri=OJ:L:2006:161:0012:0018:EN:PDF>

**EC Regulation (2000)** Regulation (EC) No 2037/2000 of the European Parliament and of the Council of 29 June 2000 on substances that deplete the ozone layer; <http://ec.europa.eu/environment/ozone/legislation.htm>

**EC Regulation (2006)** Regulation (EC) No 842/2006 of the European Parliament and of the Council of 17 May 2006 on certain fluorinated greenhouse gases; <http://eurlex.europa.eu/LexUriServ/LexUriServ.do?uri=OJ:L:2006:161:0001:0011:EN:PDF>

**IPCC (2005)** IPCC/TEAP Special Report: Safeguarding the Ozone Layer and the Global Climate System: Issues related to hydrofluorocarbons and perfluorocarbons; <http://www.ipcc.ch/ipccreports/sroc.htm>

**UBA (1989)** Federal Environment Agency: Responsibility means doing without – How to rescue the ozone layer, Berlin: Erich Schmidt

**UBA (2004)** Federal Environment Agency: Fluorinated Greenhouse Gases in Products and Processes – Technical Climate Protection Measures, Berlin; <http://www.umwelt-daten.de/publikationen/fpdf-l/2791.pdf>

---

## II. Safety of Natural Refrigerants

---



# Safety Rules for the Application of Hydrocarbon Refrigerants

DR. DANIEL COLBOURNE, Re-phridge, UK

PROF. DR. JOSÉ M. CORBERÁN, Universidad Politécnica de Valencia,  
Instituto de Ingeniería Energética, Spain

---

## Introduction

---

Historically, hydrocarbons (HCs) were among the first refrigerant fluids to be used, but due to their flammability, their use was abandoned in favour of inert fluids such as chlorofluorocarbons (CFCs) and hydrochlorofluorocarbons (HCFCs). Compared with CFCs, HCFCs and hydrofluorocarbons (HFCs), HCs offer zero Ozone Depletion Potential (ODP) and extremely low Global Warming Potential (GWP) and, in regard to their performance, they offer in general: high efficiency, reduced charge sizes, and a range of other benefits such as mineral oil compatibility.

The only real factor against the application of HC refrigerants in refrigeration and air conditioning equipment (hereinafter referred to as RACE) is the safety concern in handling relatively large HC charge quantities; special installation practices and handling procedures are certainly required. The evolution of such practices is necessary to ensure their safe use prior to their possible implementation on a much larger scale.

In regard to the adoption of HCs within safety standards, the Technical Committees responsible for standards development have been active in recent years trying to include the additional safety measures required for the design, installation, repair and service of RACE using these refrigerants. This present paper aims to provide an overview of the current situation and evolution of the available international and European standards that cover the use of natural refrigerants. It should be noted here that some of the standards covered (e.g., EN 378) also relate to environmental requirements for systems. However, this article will not discuss this aspect specifically.

---

## Standards and directives

---

First of all, it should be pointed out that a standard is a reference of achieving a certain level of quality, and in general, standards are not mandatory in the legal sense. Further, they often include informative annexes that contain recommended practices

but which are not required to satisfy conformity to the standard. Standards are only mandatory when they are so specified in national laws, directives or regulations.

National regulations and community directives (e.g. European directives) are mandatory. For instance, the European directives applicable to the possible use of flammable refrigerants in refrigeration equipment include:

- PED (Pressure Equipment Directive)
- LVD (Low Voltage Directive)
- MSD (Machinery Safety Directive)
- ATEX (equipment and protective systems intended for use in potentially explosive atmospheres directive; named after the French: ATmosphere EXplosible)

There are two types of standards: harmonised and non-harmonised. A harmonised standard is written so that it is consistent with particular directive/regulations. Harmonised standards are extremely useful because they provide a “presumption of conformity” to the relevant directive/regulations; conformity to the relevant directives being necessary for CE marking of equipment. Manufacturers tend to follow these in order to demonstrate the quality of their products as well as to satisfy the corresponding directive/regulations. This approach is prescribed within the EU’s “Blue Book” Guide to the implementation of directives based on the New Approach and the Global Approach.

A major advantage, for instance, of the EN 60335-2 series of standards (more specifically -24, -40, -89) is that they have harmonised status with certain directives, for example, the LVD. Thus, conformity to EN 60335-2-24, -40 and -89 means that domestic refrigerators, heat pumps, air conditioners and commercial refrigeration units can be built without the producer having to provide a detailed demonstration of conformity to that directive. (However, the manufacturer does have to document how the product does conform to the directive or equivalent national legislation.) Conversely, non-harmonised standards do not specifically provide an interpretation of directives, so producers are under obligation to develop methodologies and interpretations for achieving conformity independently.

Global standards applicable to RACE and their installation come mainly from two organisations: the International Standardisation Organisation (ISO) and the International Electrotechnical Commission (IEC). Similarly, within the European Union (EU) the corresponding organisations are the Comité Européen de Normalisation (CEN; European Committee for Standardisation) and the Comité Européen de Normalisation Electrotechnique (CENELEC; European Committee for Electrotechnical Standardisation), respectively. There is an agreement between IEC and CENELEC (the “Dresden Agreement”) and ISO and CEN (the “Vienna Agreement”) which set out the formalised process for transferring – as far as possible – the content of international standards to European ones, or in some cases, vice-versa.

To provide an insight into standards development, there are formalised procedures that are carried out within each standards organisation, and these often overlap with other organisations. A standard is initiated by a National Committee (NC; being the authorised committee of a member country that is to manage national standardisation activities on behalf of a given standardisation organisation), by putting a proposal to the relevant Technical Committee (TC). If the TC (which will be made up of representatives from all NCs) agrees to the proposal, it will usually set up a Working Group (WG), which is normally comprised of industry representatives, to produce a draft standard. The WG will submit a draft to the TC which should eventually approve it, and submit it to the NCs for vote. If the sufficient number of positive votes is received then the standard will be published.

In the case of a standard developed at international level, it will also be considered by the relevant CEN committee for adoption as a European standard. In the case of acceptance of a new European standard, it will automatically be adopted by national standardisation bodies. Occasionally, there is upward transfer of a standard from European level to international level, and in some circumstances this can also occur with national standards being passed upwards for adoption as a European standard (albeit with at least some changes).

Standard	Harmonisation with EU directives	Restrictions for HCs
ISO 5149: 1993	Not harmonised	Completely prohibits use except in laboratory or industrial (petrochemical) applications
DIS ISO 5149: 2007	Not harmonised	Permits varying quantities depending on equipment type and location
IEC 60335-2-24: 2007	Not harmonised	Permits a limited quantity anywhere
IEC 60335-2-40: 2006	Not harmonised	Permits varying quantities depending on equipment type and location
IEC 60335-2-89: 2007	Not harmonised	Permits a limited quantity anywhere
EN 378: 2000	Selected clauses are harmonised with MSD and PED	Permits varying quantities depending on equipment type and location, and
EN 378: 2007	Relevant clauses are harmonised with MSD and PED and under certain circumstances avoidance of ATEX	Permits varying quantities depending on equipment type and location
EN 60335-2-24: 2007	Harmonised with relevant directives	Permits a limited quantity anywhere
EN 60335-2-40: 2006	Harmonised with relevant directives	Permits varying quantities depending on equipment type and location
EN 60335-2-89: 2007	Harmonised with relevant directives	Permits a limited quantity anywhere

Table 1: Summary of various standards in relation to natural refrigerants

Standards can also be classified as “horizontal” and “vertical” standards. Horizontal standards are generic and in principle they should be applicable to all RACE and installations (typically ISO and CEN standards such as EN 378 or ISO 5149). Vertical standards, by contrast, are specific to a family of appliances and describe the specific safety issues and requirements for their use. The vertical standards also refer to the horizontal standards for additional or general requirements. The current RACE safety standards all contain some requirements that relate to the application of HCs, ammonia and carbon dioxide to some extent (Table 1).

Useful complementary information and interpretation of requirements can also be found in industry guidelines or codes of practice, for instance, British Institute of Refrigeration Safety Code of Practice for A2 and A3 Refrigerants.

An overview of the hierarchy and interlinks between the various international standards, European standards and national standards are shown in Figure 1. The international standards make use of each other, and – in theory – they feed downwards to European level, where the relevant legislation is integrated. These are then automatically adopted by CEN members (generally the EU/EEA member states) as national standards, and the “competing” national standards are withdrawn. For example, with the acceptance of EN 378 in 2000, the national standards NPR 7600 in the Netherlands, DIN 7003 in Germany and BS 4434 in the United Kingdom, were withdrawn.

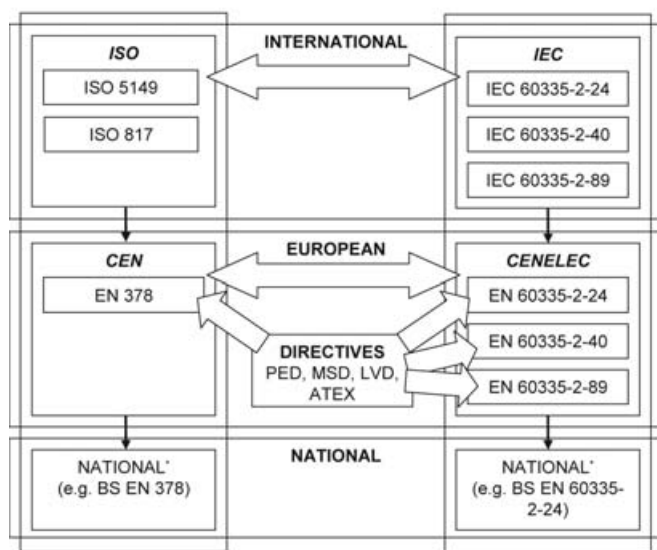

Figure 1: Interlink between various standards and European directives

Whilst many of these standards evolved separately, the increased use of standards – largely due to wider trading across the globe – has resulted in synchronisation amongst most of these in terms of many of the technical requirements. With regards to these requirements, most standards comprise the following series of topics:

- Classification of refrigerant type, related to toxicity and flammability classes
- System locations/occupancy types and corresponding permissible refrigerant quantities and room sizes
- Construction requirements for the system such as safety devices and test pressures
- External features associated with installation such as ventilation and detection)
- Marking and instructions for users and operators
- Practices for servicing, maintenance and refrigerant handling

It is noted that many of the requirements within all of the standards are closely linked to the risk posed by the refrigerant, or whatever classification – be it related to flammability, toxicity or asphyxiation, or in most aspects, the hazards associated with elevated pressures within the refrigerant-containing parts.

The following sections will provide a general overview of the requirements specified within most of the standards listed in Table 1. Due to the work of the standardisation bodies, there is fairly close correspondence between most of them. However, due to its outdated content ISO 5149: 1993 will be ignored in favour of the forthcoming DIS ISO 5149: 2007, and the outgoing EN 378: 2000 will also be neglected in favour of the new EN 378: 2007.

## Refrigerant charge limits

Limiting the amount of refrigerant charge within a single refrigerant circuit is one approach to achieving an “approximate” level of safety. The current versions of EN 378, IEC/EN 60335-2-40 and DIS ISO 5149 all incorporate this methodology. IEC / EN 60335-2-24 and IEC / EN 60335-2-89 use this approach to some extent. The charge size limit of any refrigerant is linked closely to its intrinsic characteristics in terms of toxicity and flammability.

The standard ISO 817: 2005 specifies the criteria by which a refrigerant can achieve a particular safety classification. The classification is an alpha-numeric designation, the former relating to its toxicity (A- for low-toxicity and B- for higher-toxicity), and the latter referring to its flammability (-1 for non-flammable, -2 for lower flammability and -3 for high flammability). Thus the HCs typically achieve an “A3” classification. The maximum charge for any refrigerant depends on the occupancy category and on the location of the refrigerant-containing parts. Both EN 378 and DIS ISO 5149 (currently) adopt the same categories of occupancy, as follows:

- Category A: general occupancy not restricted at all. Dwellings and public places, for example, hospitals, prisons, theatres, supermarkets, transport termini, hotels, restaurants, etc.
- Category B: supervised occupancy restricted to a certain number of people, some of whom are aware that the system is charged with a HC. Offices, laboratories, places of work, etc.
- Category C: occupancy with authorised access only. Non public areas in supermarkets, cold stores, manufacturing facilities, refineries, etc. Furthermore, systems are also defined according to the general positioning of the components in relation to the occupancies:
  - Entire system within human occupied space which is not a machinery room
  - Compressor and liquid receiver in an unoccupied machinery room or in the open air
  - All refrigerant containing parts in an unoccupied machinery room or in the open air

Lastly, an additional division based on system design – being direct expansion or indirect expansion – are also employed, although this is essentially predetermined in the positioning of the system. In the case of the appliance standards, IEC / EN 60335-2-24, -40 and -89, occupancy categories are not considered, and their requirements are assumed to apply to equipment installed anywhere.

In terms of refrigerant charge sizes, there are two basic criteria. The first is “allowable” charge size. This refers to the maximum mass of refrigerant for a given occupied room size. The second is the “maximum” charge size, and this refers to the upper limit that the allowable charge size can reach. In other words, if the room is particularly large, it is still not permissible to exceed the maximum charge size. The background for the determination of the allowable charge is that it is an approximation of the quantity of refrigerant that can be instantaneously released into a room without resulting in a flammable concentration for anything more than a momentary length of time. Conversely, the maximum charge is a largely arbitrary quantity. It is important to note that both allowable charge and maximum charge apply per independent refrigerant circuit, since it is taken that the probability of two separate circuits developing an instantaneous catastrophic leak simultaneously is minute.

Figure 2 provides a flow chart as a means of determining both the allowable and maximum refrigerant charges permitted, depending on occupancy category and location of the refrigerating system, and corresponds to all of the standards. (Alternatively, the minimum allowable room size can be determined for a given refrigerant charge size.) Some of the limits are referred to the practical limit of the refrigerant (PL). This is a value stated in the standards for each refrigerant, and represents the practical limit to avoid dangerous concentrations (typically: 20% of LFL).

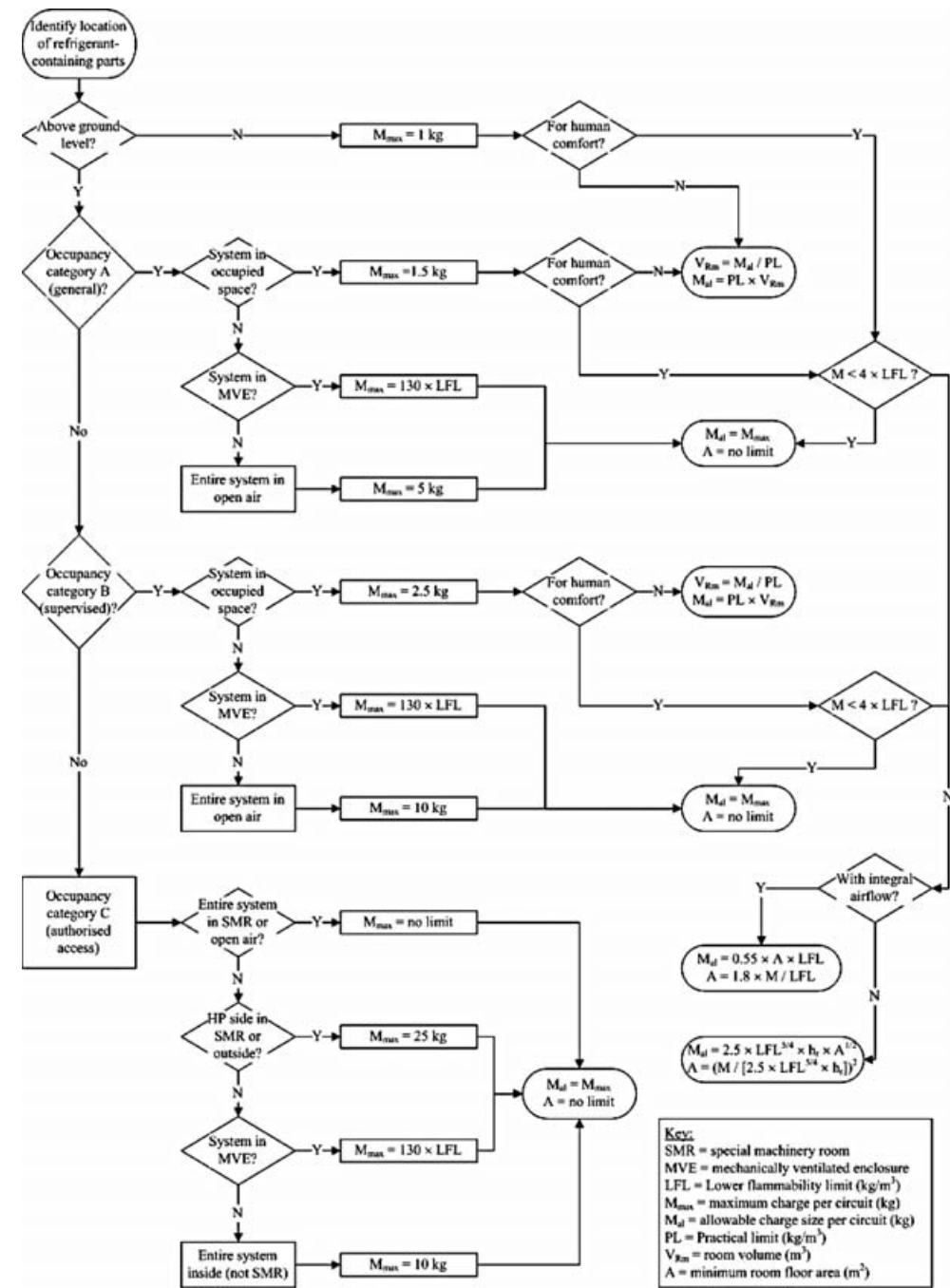

Figure 2: Determination of allowable and maximum charge amount (or room size) for HC refrigerants (from Institute of Refrigeration Safety Code of Practice for A2 and A3 Refrigerants, 2008)

In addition to these limits, sealed systems that contain up to approximately 150 g of HC (depending upon the standard), are permitted to be located anywhere, regardless of the room size or occupancy. Indeed, both the appliance standards, IEC / EN 60335-2-24 and -89 limit the quantity of HCs to 150 g throughout. For charge sizes above 150 g, they refer to the relevant national or international standards, i.e., EN 378 or ISO 5149.

In Figure 2, the formula used for charge or room size determination for systems for human comfort requires special attention. Here, the formula includes a term,  $h_r$ , which is related to the installed height of the unit, and nominal values for this are provided within the standards:

- $h_r = 0.6$  m for floor mounted units
- $h_r = 1.0$  m for window mounted units
- $h_r = 1.8$  m for wall mounted units
- $h_r = 2.2$  m for ceiling mounted units

There are a number of additional conditions associated with the design of the refrigerating system that must be adhered to if the charge sizes specified are to be permitted. As mentioned, these values are based on the current draft of the revised DIS ISO 5149: 2007, which is largely based on EN 378: 2007; this has the objective of achieving international synchronicity for the design and construction criteria of RACE. However, as DIS ISO 5149 evolves, it is likely to deviate somewhat from EN 378, as existing requirements are rejected by some stakeholders, and new ones are developed. One example is the addition of requirements for multi-split air-conditioning systems, which are allowed to use larger charge sizes of certain flammable refrigerants.

---

## Ventilation

---

Mechanical ventilation is a necessary requirement for all refrigerants. Where flammability is a concern, it is necessary to ensure that there is sufficient ventilation to ensure that the refrigerant is dispersed rapidly in the event of a leak.

The appliance standards IEC / EN 60335-2-24 and -89, do not specify a ventilation rate, mainly because they are dealing with relatively small quantities of refrigerant. The only prerequisite is that there is nowhere on the appliance where a leak of refrigerant could accumulate. Typically, this does not require mechanical or forced ventilation.

Where mechanical ventilation is normally mandatory is within a machinery room, where larger quantities of refrigerant are held. For this situation, EN 378 and DIS ISO 5149 specify certain ventilation rates. If the concentration of refrigerant within a machinery room (or any other Category C occupancy) can exceed the Practical Limit in the event of a catastrophic leak, then mechanical ventilation must be provided:

- Background ventilation must be provided at a rate of at least 4 air changes per hour (or greater if national regulations prescribe) whenever an occupant is present.
- Emergency ventilation is required in the event of a release of refrigerant, and the flow rate is a function of refrigerant charge ( $\dot{V}_{min} = 0.014 \times M_r^{2/3}$ , where  $\dot{V}_{min}$  is in  $m^3/s$  and the refrigerant charge  $M_r^{2/3}$  is in kg).

In the case of emergency ventilation, this is normally initiated with activation of a refrigerant sensor located at floor level in the machinery room. For HCs, the ventilation should be initiated at a concentration of no more than 25% of the LFL.

It is noted that if a room has at least one of the longest walls open to the outside air by means of louvers with 75 % free area and covering at least 80 % of the wall area (or the equivalent if more than one wall is to outside), it is considered as being in the open air, and therefore no mechanical ventilation is required. If the equipment is located within a Category A or B occupied space, but built into a mechanically ventilated enclosure (MVE), then special ventilation requirements are applied, as detailed within EN 378, DIS ISO 5149 and IEC/EN 60335-2-40. The special requirements for fixed systems that are contained within mechanically ventilated enclosures state that the refrigerating circuit is provided with a separate enclosure that is not connected to the room. The system enclosure shall have a ventilation system that produces airflow from inside the system to the outside through a ventilation shaft, at a rate of  $\dot{V}_{min} = 60 \times M_r / \rho_r$  (where  $\rho_r$  is the density of the refrigerant at atmospheric pressure and 25°C, in  $kg/m^3$ ), but at no less than 0.03  $m^3/s$ . In addition, the pressure difference between the interior of the enclosure and the external ambient shall be at least 20 Pa.

---

## Safe design and construction

---

In addition to the described limitations on the refrigerant charge depending on the size of the room and type of occupancy, the standards impose requirements on any aspect of the RACE that could become a risk due to the refrigerant flammability. In the following, a selection of requirements for the safe design and construction of RACE employing flammable refrigerants is outlined.

### Compressors

There is little reference in the standards to special compressor requirements for the use of flammable refrigerants. Of course, general pressure equipment and other machinery regulations and directives do apply. EN / IEC 60335-2-34 safety standards for motor compressors were extended to flammable refrigerants in 1996, deeming as unnecessary any change in the use of hydrocarbon refrigerants since requirements are already specified in the standards for the appliances or end products that include motor compres-

sors. The more recent EN 12693 standard that applies to larger size compressors also makes no reference to different classes of refrigerant. However, although not related directly to safety standards, a consequence of the requirements of the PED means that the supply of certain compressors for HCs is hindered within Europe. Presently, open and semi-hermetic compressors for flammable refrigerants with considerable capacity range are available in the market. There is no problem in obtaining small hermetic compressors with low internal volumes, but this is not the case for medium-sized hermetic compressors, of the type typically used for with small heat pumps and air conditioners, or small-size commercial refrigeration equipment. Requirements of the PED – in terms of material quality, production procedures and external approvals – are a function of pressure  $\times$  internal volume ( $P \times V$ ) of the component. These requirements are subject to a step change with increasing  $P \times V$ , but if the fluid is flammable (i.e., it belongs to “fluid Group 1”), then the step-up to tighter requirements occurs at a lower  $P \times V$ , than for a non-flammable refrigerant (“fluid Group 2”). Thus the additional demand put upon manufacturers has deterred them from large-scale output of such compressors.

### Materials

Materials must be selected to support foreseeable mechanical, thermal and chemical tensions.

### Piping

Non-permanent joints are not allowed inside occupied spaces except for site-made joints directly connecting the indoor unit to piping. The use of non-permanent joints in this case is considered to reduce the risk of ignition by such means as brazing torches, when service technicians need to break into the system. In all cases, refrigerant tubing shall be protected or enclosed to avoid mechanical damage and shall not be used during handling or transport.

### Secondary cooling and heating systems

When the system contains a secondary heat exchanger, the heat exchanger shall not allow, due to a break of the evaporator or the condenser wall, the release of the refrigerant into the areas served by the secondary heat transfer fluid. Among the measures to avoid this type of problem, the following comply with this requirement: an automatic air/refrigerant separator discharging into the vented unit housing or outside, or a double-wall heat exchanger.

### Protection devices and indicating instruments

Any refrigeration system above a particular size must be provided with one or more protection devices; the greater the charge size and the pressure and volume of the sys-

tem, the more comprehensive the levels of protection. One or two pressure relief valves may be required depending upon the operating characteristics of the compressor and whether parts of the system can be shut off by valves. For flammable refrigerants, fusible plugs cannot be used as a means of pressure relief. In terms of indicating devices, for systems with refrigerant charges above 1 kg there must be connections for the pressure indicators, and for more than 2.5 kg of refrigerant, each side of the refrigerant system must be provided with pressure indicators. Refrigerant accumulators in systems with charges above 2.5 kg that can be isolated from the system must be installed with a level indicator which visibly indicates at least the maximum admissible level.

### Electrical components and other sources of ignition

Any system that contains a flammable refrigerant must not possess potential sources of ignition that could ignite refrigerant in the event of a leak. Typically, this means that surfaces temperatures shall not exceed the auto-ignition temperature of the refrigerant reduced by 100 K, and that any source of electrical sparks must be removed or protected. Three options exist to address this:

- The component is constructed according to EN 60079-15 (sections 3 and 4 for group IIA gases or the refrigerant used), which means that the component is sealed so that will not allow the ingress of any leaked refrigerant.
- The component is located in an enclosure which complies with the requirements of EN 60079-15 for enclosures suitable for use with group IIA gases or the refrigerant used.
- The component is not located in an area where a potentially flammable mixture of refrigerant and air could accumulate – this is demonstrated by the leak simulation test. This leak simulation test is described in each of the standards (EN 378, DIS ISO 5149, EN/IEC 60035-2-24, -40, and -89), and requires a number of leaks to be simulated from different parts of the equipment, whilst the concentration of refrigerant is measured at the potential sources of ignition. If the concentration of refrigerant never exceeds a prescribed value for a given period, then it is considered to not pose a hazard.

Out of the above, the use of the leak simulation test is preferred by large-scale manufacturers for reliability and cost-effectiveness.

---

### Marking and instructions

---

Together with the safety measures for the design and construction of RACE, the standards also include an entire set of requirements concerning the marking of the equipment and the instructions that must be supplied, clearly specifying how to handle this kind of equipment safely.

## Marking

A key aspect related to safety is to ensure that those who are about to work on the equipment are fully aware of the nature of the refrigerant used. Therefore, amongst other indication marks, the flame symbol on the nameplate of the unit must be always visible when accessing parts for maintenance. Further, a symbol for reading the user manual, the repair manual and the installation manual should be well visible. There must also be visible warnings such as the standard symbol for “caution, risk of fire,” and statements that the appliance shall be installed and operated in a location corresponding to the minimum room size (where applicable). In the case of equipment installed in a special machinery room, the appropriate marking must also be made visible prior to entry. This type of requirement is specified within all the relevant standards (EN 378, DIS ISO 5149, EN/IEC 60035-2-24, -40, and -89).

## Manuals and instructions

Specific to the standards that permit equipment to contain larger refrigerant charge sizes (i.e., EN 378, DIS ISO 5149 and EN/IEC 60035-2-40), there is a requirement for detailed information to be provided in manuals for the installation, service and operation (be they separate or combined manuals). The manuals will include all the relevant information about the equipment, such as the maximum refrigerant charge, the minimum rated airflow if required, the minimum floor area of the room or any other special requirements, as well as all the corresponding warnings. Importantly, they must all provide the necessary information and instructions for the correct handling of flammable refrigerants and associated equipment, refrigerant detection, charging, equipment decommissioning, removal, recovery and storage of the refrigerant, and aspects related to ensuring the integrity of the protection for electrical components. A crucial aspect is that they also include special requirements for personnel dealing with this kind of equipment. Only competent professionals trained in the use of flammable refrigerants are permitted to open equipment housing or to break into the refrigerant circuit, and the maintenance and repair requiring the assistance of another skilled person should be carried out under the supervision of the competent individual.

## Final comments and conclusions

Certain HCs have excellent characteristics as refrigerants from a thermodynamic point of view. They are natural fluids with excellent environmental characteristics: no ODP and negligible GWP. They also offer good miscibility with mineral oils (synthetic lubricants are not required) and good compatibility with common materials employed in refrigeration equipment. The only real argument against the application of HC refrigerants in RACE is the safety concern in handling relatively large HC charges as

well as the specific need for adequate installation practices and qualified personnel for service and maintenance. Although the future substitution of synthetic refrigerants by natural refrigerants is largely dependent on the possibly more restrictive regulations (or even banning) of HFCs in the coming years, the evolution of the standards for their safe use is indispensable prior to their possible massive implementation. Fortunately, as described in this paper, a series of European and international standards concerning the use of HC refrigerants in RACE are available, providing for the necessary additional safety measures for the design, repair and servicing of RACE using flammable refrigerants. This will provide a framework to develop future refrigeration technology employing HCs. The review of the different existing and drafts standards highlights the maximum charge and room size limits as well as the specific requirements of RACE employing HCs, as well as other design features. However, it is also worth noting that whilst these standards provide guidance on safe design, other options exist, and provide that the design, construction and installation of the equipment conform to the relevant regulations and directives, other options are viable.

---

## Annex 1: List of standards and guidelines

---

### Relevant European Directives

PED. Pressure Equipment Directive. Directive of the European Community 97/23/EC  
LVD. Low Voltage Directive. Directive of the European Community 73/23/EEC  
MSD. Machinery Safety Directive. Directive of the European Community 98/37/EC  
ATEX. ATmosphere EXplosible. Directive of the European Community 94/9/EC

### International Standards

ISO 817: 2005 Refrigerants – Designation system  
IEC 60335-2-24 Safety of household and similar electrical appliances – Particular requirements for refrigerators, food-freezers and ice-makers  
IEC 60335-2-34 Safety of household and similar electrical appliances – Particular requirements for motor compressors  
IEC 60335-2-40 Safety of household and similar electrical appliances – Particular requirements for electrical heat pumps, air conditioners and dehumidifiers  
IEC 60335-2-89 Safety of household and similar electrical appliances – Particular requirements for commercial refrigerating appliances with an incorporated or remote refrigerant condensing unit or compressor  
IEC 60079: 2001 Electrical apparatus for explosive gas atmospheres  
ISO 5149: 1993 Mechanical refrigerating systems used for cooling and heating – Safety requirements  
ISO DIS 5149: 2007 Mechanical refrigerating systems used for cooling and heating – Safety requirements

## European Standards

EN 60335-2-24 Safety of household and similar electrical appliances – Particular requirements for refrigerators, food-freezers and ice-makers

EN 60335-2-34 Safety of household and similar electrical appliances – Particular requirements for motor compressors

EN 60335-2-40 Safety of household and similar electrical appliances – Particular requirements for electrical heat pumps, air conditioners and dehumidifiers

EN 60335-2-89 Safety of household and similar electrical appliances – Particular requirements for commercial refrigerating appliances with an incorporated or remote refrigerant condensing unit or compressor

EN 378: 2000 Refrigerating systems and heat pumps – Safety and environmental requirements

EN 378: 2007 Refrigerating systems and heat pumps – Safety and environmental requirements

EN 12693: 2008 Refrigerating systems and heat pumps – Safety and environmental requirements – Positive displacement refrigerant compressors

## National Standards and Codes

DIN 7003 Refrigeration Systems and Heat Pumps with Flammable Refrigerants of Group L3 – Safety Requirements (now withdrawn)

NPR 7600 Toepassing van natuurlijke koudemiddelen in koelinstallaties en warmtepompen (now withdrawn)

BS 4434 1995 Specification for Safety and Environmental Aspects in the Design, Construction and Installation of Refrigerating Appliances and Systems (now withdrawn)

IOR Safety Code of Practice for A2 and A3 Refrigerants. 2008, Institute of Refrigeration, United Kingdom.

# Ammonia and its Reputation as Refrigerant

ANDERS LINDBORG, Ammonia Partnership AB, Sweden

---

## Introduction

---

Among designers and users of ammonia in refrigeration and heat pumps, ammonia is with respect for all safety codes, standards and legal regulations the safe and profitable refrigerant. The number of accidents and lethal accidents are extraordinarily rare compared to other risks in society. This is not known among society in general which pronounce ammonia as very dangerous and frightening as ammonia has a heavy pungent smell. This paper explains that ammonia is far better than its reputation.

As a refrigerant, ammonia is unsurpassed, and it has excellent thermodynamic qualities that also have environmental advantages. All life is dependent on the recirculation of nitrogen, in which the breaking down of natural substances to ammonia is an essential part. Ammonia will continue to be used as a refrigerant in the future since society cannot afford not to use it. Ammonia discussed here is anhydrous ammonia (NH<sub>3</sub>) as refrigerant only and not in other applications like fertilizer, farming or chemical industry.

There is a belief that ammonia is both poisonous and explosive, which is not fully true if one examines the definition of “poisonous” and of “explosive”. This belief has often been a hindrance to profitability in the refrigeration industry. Most people have experienced, to a greater or lesser extent, the smell of ammonia, while only a few people have actually been injured by it. Furthermore, although flammable, ammonia does not explode, it “flash burns” like confined smoke does in a building fire. Information on risk = probability x consequence for Nordic Countries, Germany, UK and USA is presented, as these are familiar to the author and can be verified. Other societies may have other means of comparison.



---

## Ammonia

---

This presentation does not describe ammonia's thermodynamic properties or how a refrigeration system that uses ammonia is designed, constructed and operated, but instead addresses the general issue of safety. Ammonia systems designed during the past 20-30 years in accordance with pressure vessel legislation are very high quality, with excellent standards of safety. Older systems can be unsafe and should be analysed for risks by experts (not least in connection with corrosion). Service staff and personnel with operational responsibility can cause spillage, so the provision of training and information are worthwhile, low-cost preventive measures.

### Ammonia production

The volume of ammonia that naturally circulates on Earth annually amounts to at least 3 billion tonnes. Every human being produces approximately 17 g per 24 hours and a cow 1 tonne/year. On an industrial basis, about 150 million tonnes of ammonia are produced, with approximately half a million tonnes being used as a refrigerant. It is estimated that in the USA, 5% of all ammonia exists in refrigeration systems but that only 0.5% of all manufactured ammonia is used in refrigeration systems. Large, traditional-style refrigeration systems using ammonia have a natural loss of 5-10% of their charge per annum, while modern, prefabricated systems have a much smaller loss, some less than 1%.

### The refrigerant ammonia

Ammonia was used for the first time in the compression process by David Boyle in 1872 in the USA. Carl von Linde started his first compressor for a brewery in Trieste in 1876 /1/, which he selected after he had tried using ether which exploded in the laboratory; his second choice was safer. Since then, ammonia has been the dominating refrigerant for industrial applications. This is due to its unique, thermodynamic qualities and to the fact that refrigerating systems that use ammonia are efficient as well as profitable.

### The smell – an important advantage

Ammonia is the only refrigerant that has a strong characteristic smell. When ammonia is mentioned, there is often a negative reaction with the opinion being expressed that it is dangerous, toxic and explosive and has a terrible smell. The smell is in fact an advantage since the smallest leakages are discovered immediately and then corrected.

### Comparison with some other modern refrigerants

The vaporization heat of ammonia is high and the liquid fluid flow rate is low, which

is why the technology used differs from that used with other refrigerants (see Table 1 "Comparison with other refrigerants"). This low liquid flow has limited the use of ammonia for smaller refrigerating capacity, although with advancing technology in the future it can also become an alternative for small systems.

Refrigerant	Composition Formula	Boiling point °C	Vaporisation heat kJ/kg 1 bar abs.	Liquid flow dm <sup>3</sup> /s	Compr. gas flow dm <sup>3</sup> /s	COP	ODP	GWP
134a	CH <sub>2</sub> FCF <sub>3</sub>	-26.2	217	0.0056	0.814	4.60	0	1300
407C	32/125/134a	-43.8 -36.7	248	0.0055	0.492	4.51	0	1525
410A	32/125	-51.6 -51.5	271	0.0058	0.318	4.41	0	1725
507A	125/143a	-47.0	196	0.0089	0.461	4.18	0	3800
Ammonia	R 717, NH <sub>3</sub>	-33.3	1369	0.0015	0.463	4.84	0	0
Propane	R 290, C <sub>3</sub> H <sub>8</sub>	-42.1	426	0.0074	0.551	4.74	0	3
Carbon dioxide	R 744, CO <sub>2</sub>	-56.6	350	0.0123	0.065	2.96	1	1

Table 1. Comparison with refrigerants per kW refrigerating capacity at -15/+30°C /2/. The vaporization heat of carbon dioxide is specified at the triple point of -56.6°C. 407C and 410A have "temperature glide"

### Refrigerant properties

All the properties of a refrigerant listed before the Montreal Protocol have since then been added with arguments related to the environment (ODP and GWP), zeotropic and azeotropic blends and the supercritical process. All these properties have to be taken into consideration in order to get a correct picture of a refrigerant. For example, HFC refrigerants are not preferred for industrial systems because leaks are more difficult to prevent and the price of replacing the charge is too high, a double penalty. Furthermore there is no such thing as an ideal refrigerant and it is not likely that, within the foreseeable future, there will be a new refrigerant with properties that match or are better than those we have today /3/, /4/.

---

## Ammonia accidents, information and statistics

---

There is literature on ammonia refrigeration systems that dates back more than 100 years, but there is much ground that has not yet been covered. Just a small number of people with long experience of ammonia systems are experts in this field. There is a clear need for extensive documentation on the subject of ammonia as a refrigerant in order to increase understanding and to improve accessibility and confidence in the operation of ammonia refrigeration systems. Incidents involving ammonia leakage are

few in relation to the large number of systems that exist. Lethal accidents in the USA /5/ (last 11 years), UK (1975-2007), Sweden (since 1940), Denmark, Norway and Finland (since 1945) and Germany last 20 years are documented. This data gives an Annual Death Rate (ADR) of < 2 per 1 000 000 000 population per year. As a benchmark the ADR of lightning strike in the USA is 32 per billion per year, traffic in Sweden is 5 in 100 000 per year and working life in Sweden 5 in 1 000 000 per year. To put these values into context, this and other data is provided in Figure 1, where an indication of social attitudes to such risks is also included.

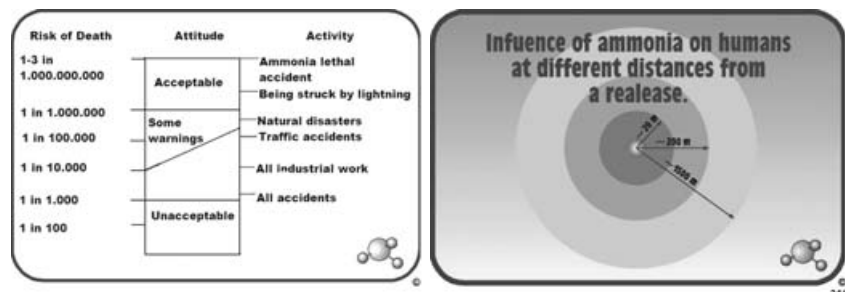

Figure 1: Probability of deaths in society, Prof. Jan Berghmans, Leuven, Belgium

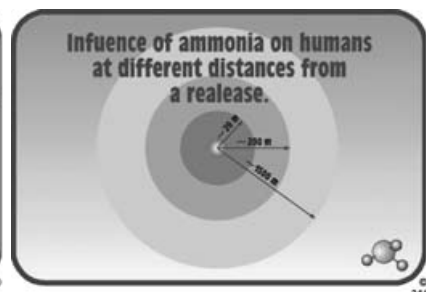

Figure 2: Influence at accidents: Lethal accidents are close to the release

### Which persons are injured or killed by ammonia?

Accidents with ammonia have occurred, and when these are studied, it is apparent that no-body beyond the vicinity of the system has been injured. People who have been injured or killed were located at the point of the leakage, Figure 2, and were usually actually working on the system. The operational and service staff are the ones who are in the danger zone of just a few metres. Injuries can be avoided by using personal protection such as overalls (no bare arms or legs in summer), gloves and protective full face filter masks.

Figure 2 illustrates that lethal accidents and accidents requiring medical treatment have occurred within a few metres of the release. At distance of 200 metres the characteristic smell is obvious. The distance 1500 metres is the safety distance for large industrial releases of many tons e.g. storage tanks, railway wagons. The influences of releases are strongly depending on weather conditions such as temperature, wind speed and climate inversion.

### Categories of reaction and injury to human beings

A study by Bird and Germain (1996) identified a ratio hierarchy that relate the different levels of impact to individuals following a release, Figure 3. The levels of impact are identified as follows:

- **Unaffected** persons are not aware of an accident or release and no smell.

- **Awareness** the smell is obvious and can be identified as ammonia, may call for help but not go to hospital.
- **Inconvenience** and depending of how experienced persons are of ammonia. Experienced will walk away while others may even panic. Some may ask for medical control or even treatment, no damage or injury.
- **Medical treatment** is needed and the injured can recover.
- **Acute medical treatment** of more severe conditions and repair is not possible e.g. total eye damage.
- **Lethal** and in most accidents for last decades it is one single person.

According to ratios 1:10:30:600 it is estimated that Sweden may have 3 to 5 releases per year and none cause damage to persons and some may not be recognised.



Figure 3: Accident Ratio Study, Bird and Germain, 1996

### Releases in hot climates

One important parameter concerning a release and its influence on persons within 100-300 m radius are the climate conditions. Wind speed, temperature gradient and inversion characteristics will influence the gas concentrations. Firstly, ammonia vapour is one of few gases lighter than air and it will therefore disperse upwards. A liquid release tends to create an aerosol which picks up moisture from the air, and the characteristic white cloud is formed. After a short distance from the release point, the liquid droplets have evaporated and the cloud is in-visible in vapour phase. The spread is better in warm than in cold climates, and a leak will have less influence on the neighbourhood. Also the height above the ground of the release is important; the higher the position, the lower the concentration of gas.

### Ignorance

Ignorance results in a negative attitude towards ammonia, but more than 95% of the people in the refrigeration industry work with other refrigerants and technical solutions,

not with ammonia. It is all too easy to question situations one does not master, not least situations that can be interpreted as being a threat to a company's operations. Many authorities and planners have not acquainted themselves with the regulations for ammonia and still consider it to be an impossible alternative. It is natural and not at all inconsistent to respect and comply with the Pressure Equipment Directive, Machinery Directive and modern Standards, all of which, when interpreted correctly, result in safe ammonia systems.

### Small or minimum charge

The refrigeration industry is striving to design and build systems with the smallest possible charge. This is the case for fluorocarbons such as HFCs, where leakage is unacceptable for cost and environmental reasons. For ammonia, sectioning and other methods are used to reduce amounts in the case of possible leakages. Ammonia's large latent heat and special partial pressure are properties that make it difficult, or even impossible, to empty part of a system, apart from leakage in the liquid phase. This means that substantial quantities cannot leak out of ammonia systems, but the strong, typical smell leads people to believe that leakages are of a more major size. Modern detectors and sectioning reduce the problems that leakages cause. For ammonia there is no minimum charge but there is a correct charge as small charges make the system difficult to design and operate, charge variations in the system have to be respected.

### Toxicity

Ammonia is always described as being poisonous but what is a poison? Philippus Theophrastus Bombastus von Hohenheim or Paracelsus, Swiss doctor, chemist and philosopher (1493-1541) is quoted as having said "the dose makes the poison". The amount of a substance a person is exposed to is as important as the nature of the substance. A modern definition is that a poison is a substance that, even in very small quantities, has a dangerous or deadly effect on living organisms. It is not possible to conceal ammonia, which is the only refrigerant that gives a warning long before the concentration can be considered dangerous. The level of concentration that a trained individual cannot put up with is not dangerous, (Table 2 "The Physiological Effect of Ammonia on Man").

### Flammability

The word "explosive" is used in relation to rapid fire behaviour, with a flame propagation of many m/s and detonation in km/s. Since ammonia burns with low energy – about half that of LPG – the flame propagation is low: about 8 cm/s according to ISO 817 /6/. Ammonia can selfignite if the temperature is above 651°C and, as a refrigerant, is classified in group B2 (low flammability) in accordance with ISO 817 and ASH-RAE 34. Ammonia's flammability range is from 15% to 28% or 33%, depending on

Gas ppm	Effect on unprotected person	Human reaction	Exposure time and regulated Exposure Limits
5 <sup>2</sup>	Threshold value for discovering ammonia, temperature dependent, easier in a low temperature and dry atmosphere		
20	Most people notice the smell	Not dangerous. Characteristic smell = warning!	Unlimited, in most countries.
25	Characteristic smell	Not dangerous. Warning!	MAC in most countries. TLV-TWA in US. (Threshold Limit Value-Time Weighted Average) OEL (Occup. Exp. Limit)
35	Characteristic smell	Not dangerous. Warning!	TLV-STEL in US. (Time Weighted Average-Short Term Average)
50	The smell is obvious. Unaccustomed person want to leave the area.	Not dangerous. Warning!	ATEL, 8 hour working day permitted in many countries. MAC=50 ppm in some countries
100	No harmful effect on healthy individuals. Unpleasant, can cause panic for people who are unaccustomed.	Not dangerous.	Do not wait longer than necessary.
200	Strong smell	Not dangerous	Toxic end point defined by US EPA RMP (Risk Management Program)
300	People with experience of ammonia will leave the area.	Not dangerous, not accepted by experienced person.	IDLH (US, Immediate Dangerous to Life and Health), filter masks are not accepted beyond this limit in US. <sup>3</sup>
400-700	Immediate irritation in eyes and respiratory system. Even an accustomed person cannot remain.		In normal conditions, there will be no injury even if exposure time is up to 30 minutes.
1 700	Coughing, cramp of vocal cords, serious irritation in nose, eyes and respiratory system.		30 minutes' exposure results in injury and need for acute medical care.
2 000-5 000	Coughing, cramp of vocal cords, serious irritation in nose, eyes and respiratory system.		30 minutes or less can result in death.
7 000	Unconsciousness, respiratory distress		Fatal within minutes.

Table 2: Physiological effect<sup>1</sup> of ammonia on man

<sup>1</sup> In case of exposure, it is rare that a person has measuring equipment. Experience is based on reconstruction after the event. The concentration is not quantified.

<sup>2</sup> 2-5 ppm is possible to detect by smell and depends on the individual, air temperature and humidity. The advantage of a low sensory threshold for detecting ammonia is that the gas gives an early warning, so that the hazardous area can be evacuated. Even people without a sense of smell are warned of an ammonia presence since the gas affects mucous membranes and damp skin with pain.

<sup>3</sup> Practical use of filter masks and fresh K-filter has shown that they can be used in concentrations 10 000 to 15 000 ppm. Ammonia Partnership AB, Sweden.

the test method and reference. Ammonia can only burn in enclosed spaces, not outdoors in open space without a supporting flame, and is therefore not classified as flammable with regard to outdoor use. In order to ignite ammonia, an ignition source with minimum energy is needed and this energy, compared to other flammable substances, is considerable. The ignition source in an electric spark gap must be substantial, for example ordinary sparks in 3-phase 440 volt systems do not have sufficient energy to ignite ammonia and this is the reason for there being no requirements regarding explosion-proof electric equipment when this is enclosed for refrigerating systems. Ammonia requires minimum ignition energy of 14 mJ, while methane, ethane and propene require 0.26 mJ and hydrogen gas requires 0.02 mJ.

---

## Fire classification and safety standards

---

With regard to the European ATEX Directive on hazardous atmospheres, no classification is necessary for refrigeration systems that use ammonia as refrigerant. Nothing can happen inside the system. It is in the case of irregular operating situations such as when the system is opened or during servicing that the environment can be brought into question. Personnel working with flammable substances should have competence and good knowledge of what they are dealing with.

The latest proposal of prEN 378:2008 /7/ Part 3 Section 8.1 states ...“in case of refrigerants with a characteristic odour at concentrations below the ATEL/ODL e.g. ammonia, detectors are not required for toxicity”. In section 8.7 it then gives the limits of 500 ppm and 30000 ppm ... “in order to warn against danger and of fire”. These levels are mandatory maximum levels. The person with operational responsibility must be able to be on site within 60 minutes. In case of the higher level, all electrical equipment that could ignite a gas mixture in air must be disconnected. 20% of LFL (Lower Flammability Level) for ammonia, which is 15% in air, gives 3% as the highest alarm level. Ventilation and detectors may be used if the equipment is explosion proof. These instructions are also included in DIN 8975-11 /8/.

Ammonia's range for flammability in air and enclosed spaces is 15-28%. This is a very high concentration and only people with complete chemical protection would be capable of remaining in the premises. Open flames are not allowed according to the safety standards. Similarly, naked electric bulbs are a possible ignition source, so lighting must have a spray-proof cover such as a plastic hood. Fluorescent lighting shall also be covered though such light fittings are not hot during use.

Fire progress is short-lived and is dependent on the volume of the room. After just a few seconds of fire, a certain amount of the oxygen in the room has been used up and the ammonia/atmospheric oxygen balance is no longer flammable. The fire dies if other material is not ignited.

## Ammonia systems in fire

When there is a fire in a building with ammonia equipment, the ammonia is not a particular threat. Energy and flame propagation are low, meaning that damage from ammonia can be prevented, although there is always a chance that secondary ignition can occur. The building can incur damage and systems with ammonia can cause leakage, but the leaked refrigerant will follow the fire gases upwards and will only affect the surrounding area with an unpleasant smell to a very limited extent, if at all. It should be noted that the products of combustion of ammonia – nitrogen and water – are completely harmless even to global environment. This is in marked contrast to the fluorocarbons which may form hydrofluoric acid, hydrochloric acid, carbonyl chloride (phosgene), carbon monoxide, etc. when burnt, which are highly corrosive and extremely toxic, even in small quantities.

## Safety codes and standards

Present day refrigeration systems using ammonia are very safe, with ammonia having been used for more than 150 years. Accidents have occurred, and they cannot be concealed since ammonia has such a characteristic smell. Media interest regarding the cause of an emission or its consequences is relatively minor, but they often focus on descriptions of a strong, terrible, “poisonous” smell.

As early as 1918, the first safety directives were drawn up in the USA for refrigeration systems. These were followed by VBG 20 in Germany in 1933, and the predecessor of the Swedish Refrigeration Code in 1942; there are now standards in most European countries. Europe has EN 378:2000 Parts 1-4 /8/, the USA has ASHRAE 15 and ANSI/IIAR 2. Europe has legislation in the Machinery Directive the Pressure Equipment Directive and the ATEX Directive when applicable that shall be obeyed and, in addition, technology, material and design have all improved. The systems of today have come a long way over the years, and are now extremely safe.

## Ventilation of machinery rooms

Refrigeration standards direct how premises that house equipment for ammonia shall be ventilated. In general, the ventilation required for cooling surplus heat in summer is greater than the standard requires. Since the ventilation requirements are related to the system's charge, the demands regarding volume flow rate of air when small amounts of charge are used. But beware! In some cases, it has been necessary afterwards to install a cooler in the machinery room to reduce the excess heat. Ventilation should prevent the concentration in the room getting to the level at which ignition is possible. Correctly operated ventilation means that fires involving ammonia are rare occurrences in an international perspective. More often rescue services prohibit ventilation of a machinery room to protect neighbours from the pungent smell. This creates a conflict with work place safety.

## Positive future and the refrigeration industry

The refrigeration industry has not in the past been effective in arguing the safety case for ammonia, and has failed to deliver the message that this refrigerant is not difficult to handle and is safe in operation provided existing safety codes and legislation are followed. The latter are crystal clear and do not require extra interpretation.

The greatest cost arising from an emission of ammonia is in connection with cleaning up, handling relations with the community, and regaining and continuing production. Put a stop to all minor incidents! The smell of an ammonia leakage cannot be concealed – the media cause it to spread much further than any neighbours would notice. The distance for sensing the smell during worst special weather conditions is some hundreds metres for a major emission. And media will spread the smell worldwide in a few hours. Hydrocarbons are also natural alternatives for smaller capacities and in large chemical applications.

---

## Future of ammonia

Ammonia's future is positive since it has superior properties as a refrigerant and will therefore survive. Ammonia has always been the refrigerant used in large, industrial contexts. Carbon dioxide is a good or in some applications better alternative and motivating its use can be less complicated than for ammonia with regard to safety. Carbon dioxide is an efficient and interesting alternative for temperatures below  $-40^{\circ}\text{C}$ . For air conditioning applications water will be an obvious refrigerant if not ammonia is used.

With improved quality in systems with adapted amounts of filling, many new ammonia applications will be constructed. The political pressure on HFCs will increase and this will result in new technical solutions with natural refrigerants, of which ammonia is one. Used correctly, ammonia not only has a good level of safety but it also means excellent profitability for its owner/user.

**Ammonia is far better than its reputation. Use ammonia with respect as it is environmentally friendly and offers best efficiency of most refrigerants.**

---

## References

- /1/ Roger Thévenot, A History of Refrigeration throughout the World, IIR, Paris 1979.
- /2/ Ashrae Handbook 2001, Fundamentals.
- /3/ James M. Calm, Refrigerant Safety, ASHRAE Journal July 1994, page 17-26.
- /4/ James M. Calm, The Four R's, Responsible Responses to Refrigerant Regulation, Engineered Systems, October 2003.
- /5/ Chemical accident risks in U.S. industry – A preliminary analysis of accident risk from U.S. hazardous chemical facilities. James C. Belke, U.S. EPA, September 2000.
- /6/ T. Jabbour and D. Clodic, ISO 817, TC86/SC8/WG5, Arlington, VA, September 2003.
- /7/ EN 378:2000. This standard is not harmonised with regard to MD and PED. Work is in progress on a new version is expected to be available during 2008.
- /8/ DIN 8975-11 Kälteanlagen und Wärmepumpen mit dem Kältemittel Ammoniak.

# Safety of CO<sub>2</sub> in Large Refrigeration Systems

SAMER SAWALHA, Royal Institute of Technology, Sweden

---

## Introduction

---

Safety is a major concern in any refrigeration application and it is the main reason why the synthetic refrigerants dominated in the refrigeration industry for several decades. When synthetic refrigerants were found to be harmful to the environment, several regulations were enforced on their usage. Natural refrigerants are seen as a potential permanent solution, among which CO<sub>2</sub> is the only non-flammable and non-toxic (to a certain degree that will be discussed in this study) that can operate in vapour compression cycle at evaporation temperature below 0°C so it can be directly used in public areas. When ammonia or propane are used in installations that serve public areas, indirect systems are usually applied where the public areas are served with secondary refrigerant, could be brine or CO<sub>2</sub>, and the primary refrigerant, ammonia or propane, is kept in the machine room. In this case refrigerant leakage will be limited to the machine room area where the proper safety devices must be installed. Compared to direct expansion systems, indirect systems will have lower evaporation temperature due to the additional temperature difference in the heat exchanger in the indirect circuit. This will result in an additional temperature lift in the primary refrigeration circuit leading to an increase in the compressor power for the same refrigeration capacity. Moreover, the power needed to operate the secondary refrigerant circulation pump will add to the running cost of the indirect system.

CO<sub>2</sub> is relatively inexpensive and unique among the natural refrigerants in its good safety characteristics. In relation to the environment, as a natural substance CO<sub>2</sub> has no Ozone Depletion Potential (ODP), a Global Warming Potential (GWP) of 1 and no unforeseen threat to the environment. All these factors combined make it almost an ideal fluid (from safety and environment points of view) for applications where relatively large refrigerant quantities are needed. Supermarket refrigeration and other large sized refrigeration systems are applications where CO<sub>2</sub> is seen as a strong candidate to replace conventional options. It has been first used as secondary refrigerant in indirect systems. The knowledge learned from the early research work on CO<sub>2</sub> and

the experiences gained from the early installations of CO<sub>2</sub> in commercial applications promoted its wider application in supermarkets with different system concepts. Cascade systems with CO<sub>2</sub> in the low stage and trans-critical systems where CO<sub>2</sub> is the only working fluid have been applied in recent years. Nowadays, for instance in Sweden, there are more than 100 installations of CO<sub>2</sub> in indirect systems, few cascade installations and at least 20 plants with trans-critical circuit.

In the specific application of supermarket refrigeration, safety is more carefully considered because of the large number of people that might be affected in case of leakage. Although considerable research has been devoted to the development and the performance analysis of CO<sub>2</sub> refrigeration systems in commercial applications, rather less attention has been paid to the detailed analysis of the safety aspects in this context. Some research work has been done through the RACE project for mobile air conditioning application (Amin, Dienhart et al. 1999). Investigations focused on the concentration levels in the passengers' compartment in case of leakage and on the level of the explosive energy in case of component failure.

This study analyses some safety aspects related to the usage of CO<sub>2</sub> in large systems, the case of supermarket application is chosen as a practical example. The concentration levels in the supermarket's shopping area and machine room that result from different accident scenarios are calculated for a selected practical example. The ventilation requirements in the supermarket under normal conditions and during a leakage accident are taken into consideration. The case study is chosen in Sweden due to the large number of CO<sub>2</sub> installations in Sweden, especially in supermarket application.

For the selected case, the analysis of the calculations' results showed that CO<sub>2</sub> does not pose exceptional health risks for the customers and the workers in the shopping area, whereas safety requirements expressed by efficient ventilation and proper alarm system must be installed in the machine room.

## Safety characteristics of CO<sub>2</sub>

A common issue for CO<sub>2</sub> systems in supermarkets is the high pressure at standstill. If the plant would be stopped for maintenance, component failure, power cut or any other reason, then the refrigerant inside the plant will start to gain heat from the ambient and the pressure inside the plant will consequently increase. Components of the indirect system and the low temperature level of the cascade and trans-critical systems will not stand the high pressure as they are usually designed for a maximum pressure of 40 bars.

The most common and easiest protective technique is to release some of the CO<sub>2</sub> charge from the plant when the pressure reaches a certain preset value, consequently, the pressure and temperature of CO<sub>2</sub> in the plant will be reduced. If the plant remains

at standstill, then the process will be repeated and subsequently the plant must be charged again to compensate for the lost CO<sub>2</sub> charge. The fact that CO<sub>2</sub> is inexpensive favours this solution over other more expensive ones such as auxiliary cooling unit or thermal storage vessel. The position of the relief valve must be carefully selected so liquid CO<sub>2</sub> would not pass through it, otherwise solid CO<sub>2</sub> (dry ice) will be formed which might block the valve. Dry ice will be formed when the pressure is reduced below the triple point pressure, 5.2 bars, as clarified in Figure 1. Guidance for selection and positioning of the pressure relief valves can be found in EN 378: 2007 part 2.

On the other hand, the formation of the dry ice can be considered advantageous when leakage occurs in other parts of the system except the relief valves. The concentration rate increase in the space of the leak will be lower than the case of vapour leak owing to the fact that the formed dry ice will delay the mixing between CO<sub>2</sub> and air by the time that it will take the dry ice to sublime. Moreover, the formation of dry ice on the leakage point might block or limit the flow.

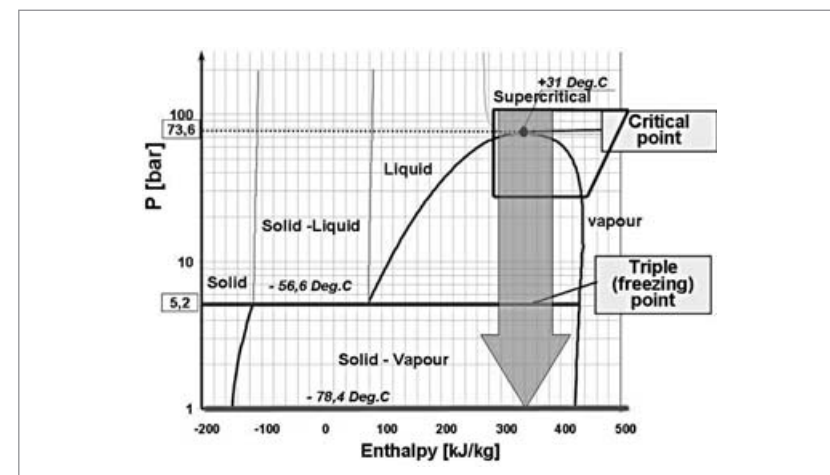

Figure 1: CO<sub>2</sub> Log P-h diagram

Supermarket refrigeration is a relatively large-scale application that requires long distribution lines and an accumulation tank for the solutions where the pump is used. This results in large system volume and consequently a considerable refrigerant charge. In case of a sudden leakage the concentration levels of the refrigerant might be high and the number of people in the shopping area who could be exposed to it is large. Therefore, safety concern is a major factor in the choice of the type of system and refrigerant to be used. CO<sub>2</sub> is a relatively safe refrigerant compared to natural and artificial working fluids. It is classified in group A1, according to ASHRAE Handbook-Fundamentals (ASHRAE 2005). This is the group that contains the refrigerants that are least hazardous and without an identified toxicity at concentrations below 400

PPM. Naturally, CO<sub>2</sub> exists in the atmosphere at concentrations around 350 PPM and for concentrations between 300 and 600 PPM people do not usually notice the difference. CO<sub>2</sub> has similar classification according to ISO 817: 2005, which is the international standard for refrigerant safety classification; it is classified in group A1 which are the refrigerants with low toxicity and non-flammable.

According to ASHRAE (ASHRAE 1989), a CO<sub>2</sub> concentration of 1000 PPM is the recommended limit to satisfy comfort for the occupants, where in a CO<sub>2</sub> controlled ventilation system fresh air should be supplied so that the CO<sub>2</sub> concentration level will not exceed this value. This is the case of an application when a small CO<sub>2</sub> generation rate is expected due to different human activities. However, in the case of high leakage rate that might occur in supermarket space or in the machine room, the consequences of serious health hazards, such as suffocation, must be taken into account.

The following table is a list of selected concentration levels of CO<sub>2</sub> and expected effects on the human health.

PPM	Effects on health	Reference
350	Normal value in the atmosphere	(Bearg 1993)
1,000	Recommended not to be exceeded for human comfort	(ASHRAE 1989)
5,000 <sup>(1)</sup>	TLV-TWA <sup>(2)</sup>	(Rieberer 1998)
20,000	Can affect the respiration function and cause excitation followed by depression of the central nervous system. 50% increase in breathing rate	(Berghmans and Duprez 1999)
30,000 <sup>(3)</sup>	100% increase in breathing rate after short time exposure	(Amin, Dienhart et al. 1999)
50,000 (40,000) <sup>(4)</sup>	IDLH <sup>(5)</sup> value	(Rieberer 1998)
100,000	Lowest lethal concentration	(Berghmans and Duprez 1999)
	Few minutes of exposure produces unconsciousness	(Hunter 1975)
200,000	Death accidents have been reported	(Berghmans and Duprez 1999)
300,000	Quickly results in an unconsciousness and convulsions	(Berghmans and Duprez 1999)

Table 1: Different concentrations of CO<sub>2</sub> and the expected health consequences

- (1) The Occupational Safety and Health Administration (OSHA) revised Permissible Exposure Limit (PEL): Time-Weighted Average (TWA) concentration that must not be exceeded during any 8 hour per day 40 hour per week.
- (2) Threshold Limit Value (TLV): TWA concentration to which one may be repeatedly exposed for 8 hours per day 40 hours per week without adverse effect.
- (3) Short Term Exposure Limit (STEL): a 15-minute TWA exposure that should not be exceeded at any time during a workday.
- (4) National Institute for Occupational Safety and Health (NIOSH) revised Immediately Dangerous to Life or Health (IDLH) value
- (5) IDLH: maximum level for which one could escape within 30 minutes without any escape-impairing symptoms or any irreversible health effects.

CO<sub>2</sub> has a main drawback of not being self-alarming by lacking a distinctive odour or colour. This implies that facilities where CO<sub>2</sub> may leak must be equipped with sensors that trigger alarm when the concentration level exceeds 5000 PPM, above which CO<sub>2</sub> concentration may have effect on health. CO<sub>2</sub> is heavier than air and therefore will collect close to the floor when it leaks; thus, the sensors and the ventilators in the space where CO<sub>2</sub> might leak should be located close to the floor. Being inexpensive and relatively safe allows the usage of large charges of the refrigerant and provides flexibility in the design of the system. Hence, flooded evaporators which require large refrigerant charges can be used for the intermediate and low temperature levels. Nevertheless, the CO<sub>2</sub> charge is expected not to be very high compared to other refrigerants due to the fact that the compact size of the CO<sub>2</sub> components and delivery lines will contribute to minimizing the charge. Based on experiences from several installations, an estimation of how much charge of CO<sub>2</sub> will be needed in a supermarket can be found in Heinbok (Heinbokel 2001); about 5.25 and 1.7kg/kW for secondary and cascade systems respectively. Of course this should be considered a rough estimate because it will be different from one system solution and installation to another.

In case of component rupture, the fact that CO<sub>2</sub> has relatively high operating pressure compared to other refrigerants raises questions concerning the hazards of blast effects, shocks and flying fragments. As described and studied by Pettersen et al. (Pettersen, Armin et al. 2004), the extent of a potential damage can be characterized by first; the explosive energy which can be estimated as the energy released by expansion of the refrigerant contained in a component or system. Second; is the possible occurrence of a Boiling Liquid Expanding Vapour Explosion (BLEVE) which may create a more severe blast effect than by an ordinary refrigerant expansion. BLEVE may occur when a vessel containing pressurised saturated liquid is rapidly depressurised, e.g. due to a crack or initial rupture. The sudden depressurisation leads to explosive vaporisation and a transient overpressure peak that may burst the vessel. As Pettersen et al. (Pettersen, Armin et al. 2004) reported, the explosive energy per kg for CO<sub>2</sub> is high compared to R22. However, when the comparison is made for ductless residential air conditioning system with equal cooling or heating capacities and similar efficiencies then owing to the smaller volume and refrigerant charge of the CO<sub>2</sub> system the actual explosive energies are in the same range.

In the supermarket system the expected explosive energy may be higher than the cases with conventional systems. This is due to the presence of the accumulation tank in most of the CO<sub>2</sub> system solutions which increases the system's charge and volume. However, the explosive energy is more of a concern with systems where the occupants are close to the system's components; such as mobile air conditioning and residential air conditioning. In supermarket systems the high pressure components are in the machine room and the distribution lines are usually kept in a distance from the consumers.



Regarding the possible occurrence of BLEVE in CO<sub>2</sub> vessels, Pettersen (Pettersen 2004) reports that the maximum observed pressure spikes in the tests were only a few bars above the initial pressure. Therefore, it was concluded that there was no reason to expect BLEVE in CO<sub>2</sub> system accumulators or receivers.

In order to evaluate the risks attached to a leakage accident in a supermarket the possible concentration levels in the supermarket's shopping area and machine room that result from different accident scenarios has been calculated for a selected practical example. The theoretical analysis will show the limits for the highest concentration levels that could be reached in the supermarket.

## The case study

The case of a supermarket in the small to medium size category (relative to the CO<sub>2</sub> installations in Sweden) was selected as the base for the calculations. The dimensions of the shopping area are around 40x30x5 m and the machine room's dimensions are 10x10x3 m. The capacity of the plant is around 30 kW at the low temperature level and 75 kW at the medium temperature level. CO<sub>2</sub> is used as secondary refrigerant at the low temperature level in an indirect system, the CO<sub>2</sub> charge in this installation is assumed to be 100 kg. These parameters are almost identical to a supermarket in Hedemora area, about 200 km North West of Stockholm. The concentration of CO<sub>2</sub> is calculated in different accident scenarios, which differ depending on two main parameters: The leakage position and the flow rate of the leaking CO<sub>2</sub>.

The main two places in the supermarket where leakage could take place are the machine room and the shopping area. The risk analysis is performed for these two places. The refrigerant is assumed to leak with different flow rates which start with the hypothetical case that the refrigerant escapes instantaneously and completely from the plant resulting in the highest concentration possible. The lowest flow rate used in the calculations was based on two hours of leakage time. It is assumed in the calculations that good mixing occurs and that the refrigerant leaks with constant flow rate until all the charge escapes from the plant. The value of 365 PPM was used for the CO<sub>2</sub> concentration in the fresh air supply and as the initial value in the room.

## Risk analysis in the shopping area

Based on the dimensions of the selected supermarket, if the CO<sub>2</sub> is assumed to escape completely within the shopping area in a very short time, then the maximum concentration of CO<sub>2</sub> will be around 9,270 PPM. This concentration level far exceeds the accepted levels for occupants in non-industrial facilities, the value of 1000 PPM in

Table 1. Until 1989 the Occupational Safety and Health Administration (OSHA) set the concentration value of 10,000 PPM to be the Permissible Exposure Limit (PEL). Most of the agencies, National Institute for Occupational Safety and Health (NIOSH), American Conference of Governmental Industrial Hygienists (ACGIH), and MAK-commission in Germany, that set the occupational safety standards used the TLV-TWA of 5000. The value of TLV-TWA is usually combined with the Short Term Exposure Limit (STEL) value of 30,000 PPM which is much higher than the highest concentration possible in the shopping area (9,270 PPM). Accordingly, leakage accident within the shopping area is not expected to result in any health hazard to the occupants. When the fresh air supply is taken into account, the CO<sub>2</sub> concentration in the space will drop after one hour of ventilation according to the equation below (Peterson 1986), which is represented by the curve in Figure 2.  $C_{1h}$  is the concentration after one hour (PPM),  $C_{max}$  is the maximum initial concentration (PPM) and  $N$  is the air change rate (1/h).

$$\frac{C_{1h}}{C_{max}} = \exp(-N) \quad (1)$$

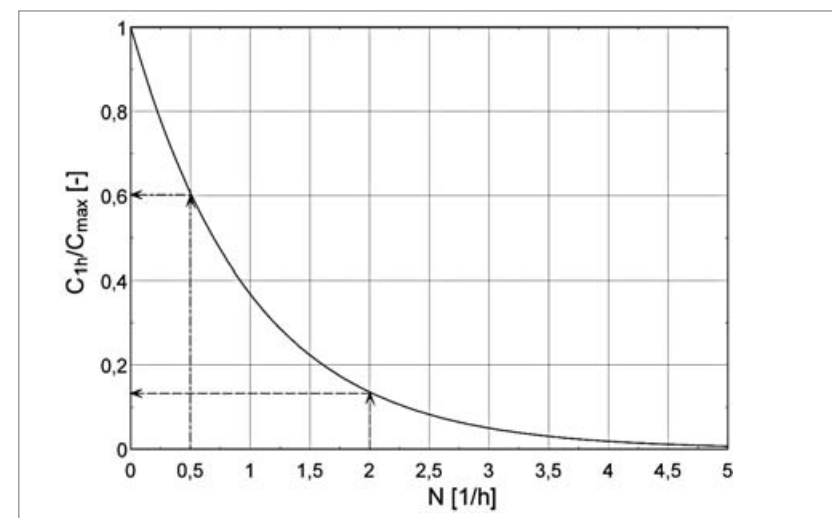

Figure 2: The influence of the ventilation rate on the concentration

For the shopping area, ASHRAE Standard 62 (1989) recommends about 0.5 air changes per hour (ACH), which results in approximately 40% reduction in the initial CO<sub>2</sub> concentration after one hour of ventilation, which can be seen in the figure above. If the CO<sub>2</sub> charge is assumed to escape with a constant flow rate then the concentration, in kg/m<sup>3</sup>, is calculated as a function of time according to the equation below (Peterson 1986) and the results, in PPM, are plotted in Figure 3 for the shopping area. It was assumed that the CO<sub>2</sub> charge escapes with constant flow rate during different durations of 15 minutes, 30 minutes, 1 hour, and 2 hours. CO<sub>2</sub> generation from the occupants was ignored in the calculations.

$$C_{(kg/m^3)} = \frac{\dot{m}_{CO_2}}{N \times V} + C_{air} - \left\{ \frac{\dot{m}_{CO_2}}{N \times V} + C_{air} - C_0 \right\} \cdot \exp^{-N.t} \quad (2)$$

Where  $\dot{m}_{CO_2}$  is the CO<sub>2</sub> mass flow rate (kg/h),  $V$  is the space volume (m<sup>3</sup>),  $C_{air}$  is the CO<sub>2</sub> concentration in fresh air (kg/m<sup>3</sup>),  $C_0$  is the initial concentration (kg/m<sup>3</sup>) and  $t$  is the time in hours.

In a CO<sub>2</sub> controlled ventilation, the ventilation rate in the shopping area must be increased when the concentration reaches a value close to 1000 PPM in order to bring the CO<sub>2</sub> concentration down to normal level. In these calculations the ventilation system was assumed to have constant value of 0.5 ACH regardless of the CO<sub>2</sub> concentration level.

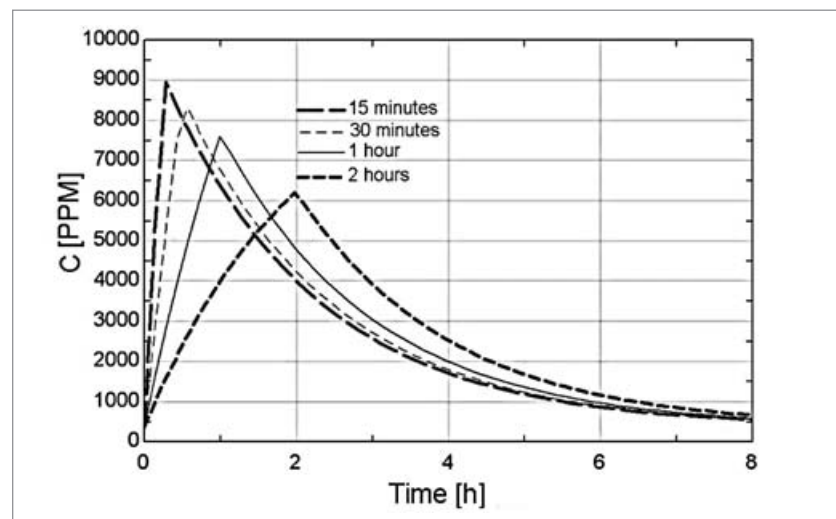

Figure 3: CO<sub>2</sub> concentration versus time in the shopping area for 15 minutes, 30 minutes, 1 hour, and 2 hours of leakage durations

The results in Figure 3 show that the CO<sub>2</sub> concentration sharply increases during the assumed leakage times. This is due to the fact that the CO<sub>2</sub> leakage rate is much higher than the rate of replacement of CO<sub>2</sub> contaminated air by fresh air supply via the ventilation. At the end of the leakage period (after 15, 30, 60, and 120 minutes) the CO<sub>2</sub> concentration reaches the peak because at that point the CO<sub>2</sub> charge escaped completely from the plant into the shopping area. Afterward, the CO<sub>2</sub> concentration decreases in an exponential manner due to the effect of the ventilation which replaces the CO<sub>2</sub> contaminated air by fresh air supply.

Looking at the accident scenario with the highest peak concentration, almost 9000 PPM at 15 minutes leakage duration, it is evident that the CO<sub>2</sub> concentration level in the shopping area does not enclose health risk to the customers and the workers in the supermarket. However, an alarm is necessary to warn of a leakage problem so proper procedures can be followed for occupants' safety and proper maintenance can be performed.

### Risk analysis in the machine room

If the same scenario, that the charge escapes completely and instantaneously, is applied in the machine room then the concentration will be around 185,300 PPM. It is very high if compared to the value of 200,000 PPM, listed in Table 1 at which death accidents have been reported. Therefore, protective measures of a proper alarm system based on CO<sub>2</sub> detectors and efficient CO<sub>2</sub>-controlled ventilation system must be implemented. According to the Swedish design codes (Svensk Kylnorm 2000), a minimum ventilation rate of 2 ACH is recommended in the machine room. This value results in 86% drop in the initial CO<sub>2</sub> concentration after one hour of fresh air supply, clarified in Figure 2. According to EN 378, if the machine room is occupied for significant periods, e.g. used as building maintenance workplace, then the ventilation rate must be at least 4 ACH. The ventilation system in the machine room must be a CO<sub>2</sub> controlled one; and, according to the Swedish safety codes when the concentration level in the machine room reaches the TLV, 5000 PPM, the fresh air supply flow rate (m<sup>3</sup>/h) must be increased according to the formula:

$$\dot{V} = 50 \sqrt[3]{M^2} \quad (3)$$

Where  $M$  is the refrigerant charge (kg). The increase in the ventilation rate is accompanied with a low-alert alarm system, visual and acoustic, in the machine room and in a visible place from outside the room. When the concentration level reaches 50,000 PPM (the IDLH value) high-alert alarm system is triggered and the workers must leave the machine room immediately (SvenskKylnorm 2000).

This is also in good accordance with the European Standard EN 378, which states that refrigerant detection systems shall be fitted in machinery rooms if the system charge is greater than 25 kg. Refrigerant detection systems shall be fitted to raise alarms and initiate ventilation if the levels rise to 50% of the acute toxicity exposure limit (ATEL), which is about 20000 PPM (2 % by volume). The emergency ventilation system shall not to produce more than 15 ACH.

Figure 4 indicates that for the leakage duration of 2 hours there are no health consequences for the workers, since the IDLH value is not reached (the maximum value is approximately 26,150 PPM). The concentration curve levels off close to the value of 25,000 PPM due to the fact that the extraction rate of CO<sub>2</sub> is almost equal to the leakage rate. In the case of 1 hour leakage time, the highest value reached is approximately 50,500 PPM and the high-alert alarm will be triggered for only 4 minutes, when the IDLH value is exceeded.

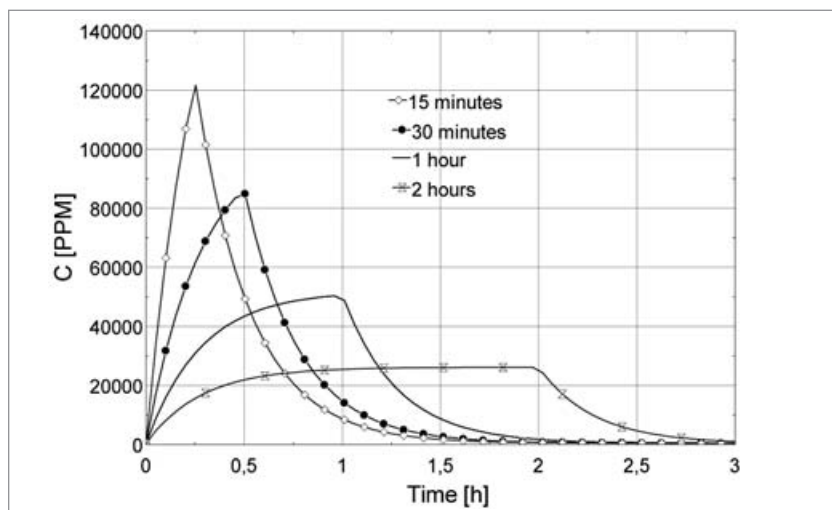

Figure 4: CO<sub>2</sub> concentration versus time in the machine room for 15 minutes, 30 minutes, 1 hour, and 2 hours of leakage durations

The concern is high in the case of short leakage time of the whole CO<sub>2</sub> charge, for 30 minutes of leakage time the value of 86,000 PPM is reached. According to the settings of the alarm system installed in the machine room, the low-alert alarm will be triggered after less than one minute from the moment that the leakage starts, and it will last for almost 12 minutes until the high-alert alarm is triggered. Which means that the workers have at least 12 minutes to leave the place before the critical CO<sub>2</sub> concentration levels are reached. In case of 15 minutes of leakage time, the low-alert alarm will be activated for at least 5 minutes before the high-alert alarm will start. This makes the time to escape from the machine room shorter, but it should be also noticed

that the period where the IDLH value is exceeded is 25 minutes, which means that the exposure time for the high concentration levels of CO<sub>2</sub> is also short. The high concentrations reached in the machine room imply that specific safety procedures must be implemented. The fact that CO<sub>2</sub> is a colourless odourless gas means that proper detection system must be placed to determine the increase in gas concentration. Figure 5 clarifies the safety equipment that should be placed in the machine room, it is shown in the figure that acoustic and flashing light alarm devices must be provided in a visible place from inside and outside the room. The figure also shows that detectors and the exhaust fan are placed at low level close to the floor.

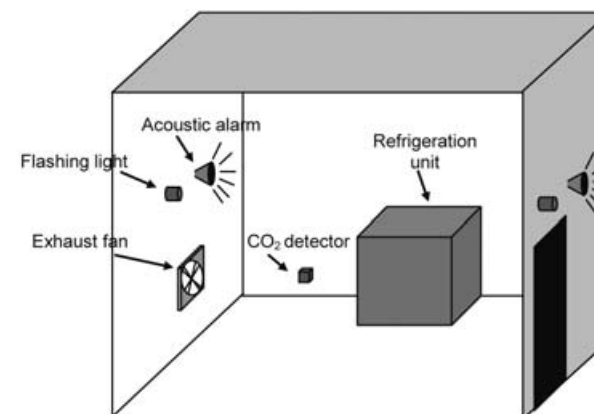

Figure 5: Simplified drawing of the machine room and the required safety equipment/devices

## Discussion of the assumptions and results

The results presented in this chapter are based on simplified assumptions and aimed to give an indication of the situation in a practical case. It was assumed that the refrigerant leaks with constant flow rate, which is not the case in practice, where the flow rate is expected to be higher in the first stages of the leakage and then it will decay due to the reduction of the pressure in the system.

The refrigerant was assumed to escape completely from the system, it should be taken into account that when the pressure in the system drops to 5.2 bars then dry ice will be formed inside the system and will slowly sublimate. The same will occur to liquid CO<sub>2</sub> leaking from the system to the surroundings. Furthermore, the formation of dry ice at the leakage point may reduce the leakage flow rate and could block the leakage point. When the pressure inside the system drops to the ambient pressure, part of the refrigerant will be left in the volume of the system's components and distribution

lines. The longest leakage time of two hours that is used in the calculations is considered to be very short. In practice complete leakage is rare to occur and if it happens then it would take place over several hours. Therefore, this will contribute to slower increase of concentration.

Due to the fact that CO<sub>2</sub> is 1.5 times heavier than air it will tend to pool; thus, CO<sub>2</sub> concentration distribution in air will not be homogenous as assumed in these calculations. The concentration values presented in this study does not necessarily present what a human would be subject to because the concentration at an average height of human body might be higher or lower than the calculated value using the good mixing assumption. The fact that the sensor must be installed on a level close to the floor means that it will measure higher concentration than at an average height of human body. This will give earlier warning and longer escape time than the resulting values from the homogenous concentration assumption. Based on the above discussion, it can be concluded that this model over predicts the average CO<sub>2</sub> concentration in the machine room and the shopping area. It also over predicts the rate of concentration increase and the escape time would be much longer than used in the calculations.

Moreover, the analysis in this chapter does not take into account specific cases of direct and close contact with leaking CO<sub>2</sub> stream which could happen for technicians in the machine room. This means that the person will be exposed to very high concentration for very short time which may result in losing consciousness. Skin burns probably will not occur due to the fact that CO<sub>2</sub> does not evaporate at atmospheric pressure (Pettersen, Armin et al. 2004). Safety requirements in the machine room in large refrigeration systems will be similar to the discussed case in this study. However, concentration levels in the machine room and the public areas will depend on the given parameters of each individual case. Still, the analysis in this study can be used as guidelines for evaluation and can give an indication of possible risks.

---

## Conclusions

---

From the analysis of the calculations' results, it is clear that using CO<sub>2</sub> in supermarkets refrigeration does not enclose exceptional health risks for the customers and the workers in the shopping area. Yet, CO<sub>2</sub> detectors are recommended to be installed in the shopping area, especially in places where leakage is possible and high local concentrations is expected in case of a leak. It must be pointed out that even if the CO<sub>2</sub> charge and the size of the supermarket's shopping area and machine room are identical to the modelled example, the case of every supermarket must be considered individually taking into consideration the geometrical variations and the locations of the distribution lines. Evidently, safety requirements such as proper ventilation and alarm system are a must in the machine room.

---

## References

---

- Amin, J., B. Dienhart, et al. (1999). Safety aspects of an A/C system with carbon dioxide as refrigerant. SAE Automotive Alternate Refrigerant Systems Symposium, Scottsdale, Arizona, USA.
- ASHRAE (1989). ASHRAE Standard 62, Ventilation for Acceptable Indoor Quality.
- ASHRAE (2005). ASHRAE Handbook, Fundamentals. Atlanta, USA, American Society of Heating, Refrigeration, and Air-Conditioning Engineering, Inc.
- Bearg, D. W. (1993). Indoor Air Quality and HVAC systems, Lewis Publisher.
- Berghmans, J. and H. Duprez (1999). Safety Aspects of CO<sub>2</sub> heat pumps. 6th IEA International Energy Agency Heat Pump Conference, Berlin, Germany.
- EN 378: 2007 Refrigerating systems and heat pumps – Safety and environmental requirements.
- Heinbokel, B. (2001). "CO<sub>2</sub> Used As Secondary And Primary Refrigerant In Supermarket LT Refrigeration." Kl Luft-und Kältetechnik (Ventilation and refrigeration)(10).
- Hunter, D. (1975). The diseases of occupants. London, England, Hodder and Stoughton.
- ISO 817: 2005 Refrigerants – Designation system.
- Peterson, F. (1986). Ventilation Requirements. Stockholm, Department of Heating and Ventilation, Royal Institute of Technology.
- Pettersen, J. (2004). Experimental Study on Boiling Liquid Expansion in a CO<sub>2</sub> Vessel. Annex 27: Selected Issues on CO<sub>2</sub> in Compression Systems, Final Report, IEA Heat Pump Centre.
- Pettersen, J., H. Armin, et al. (2004). Some Safety Aspects of CO<sub>2</sub> Vapour Compression Systems. Annex 27: Selected Issues on CO<sub>2</sub> in Compression Systems, Final Report, IEA Heat Pump Centre.
- Rieberer, R. (1998). CO<sub>2</sub> as working fluid for heat pumps. Graz, Austria, Graz University of Technology.
- Svensk Kylnorm (2000). Kylbranschens Samarbetsstiftelse, Svensk Kylnorm. Stockholm, Sweden.

# Safety of Appliances Using Hydrocarbon Refrigerants

DR. DANIEL COLBOURNE, Re-phridge, UK

---

## Introduction

---

Safety is of concern when applying any refrigerant, with respect to hazards arising from toxicity, asphyxiation, pressure explosions, mechanical injury, and so on. The use of hydrocarbon (HC) refrigerants introduces an additional risk, which is flammability. The primary means of handling this risk is through conformity to the relevant legal requirements (such as national or regional regulations), safety standards such as EN 378, and industry codes of practice (such as the IOR Code for A2/A3 Refrigerants).

These standards prescribe design and construction features, for example, covering:

- maximum and allowable refrigerant charge sizes and room size limits
- use of non-sparking or sealed electrical components
- application of safety valves and pressure controls
- use of refrigerant detectors and mechanical ventilation

However, conformity to these requirements does not guarantee a low risk, and in fact significant reductions in the hazards associated with the use of flammable refrigerants, over and above those achievable solely by applying the relevant standards, can be achieved by conducting thoughtful and detailed analysis of the equipment according to its anticipated usage throughout its lifetime. This article therefore provides a breakdown of the factors that contribute to the risk associated with the use of flammable refrigerants, once it is placed on the market. (This includes operation, servicing and decommissioning, but not manufacturing and factory precautions.)

Figure 1 is a schematic illustration of the sequence of events that leads to undesirable consequences. Initially, two conditions must be fulfilled: a leak of refrigerant and the presence of a potential source of ignition. Subsequent to the leak, the refrigerant must mix with the surrounding air in the proportions that render it flammable, and this must be present in the same position in space and time as the potential source of ignition being active; this may lead to ignition of the mixture. The ignition event can result in one or more “primary” consequences, which depend upon the local conditions: a jet fire, a flash fire, and/or an explosion (which is characterised by the development of

sufficient overpressure from the expansion of the gases). The interaction of these primary consequences with the surroundings, lead to possible “secondary” consequences: thermal damage from radiated heat, a secondary fire perhaps due to flame impingement or sufficient overpressure to cause damage to property or people.

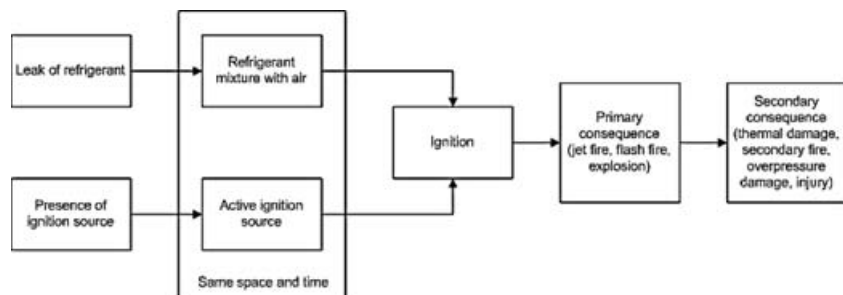

Figure 1: Basic sequence of events causing a hazard from flammable refrigerants

A sensible approach is to address each of the stages and the link between them, as indicated in Figure 1, so that design features and working practices can be put into place to minimise the hazard. Such a strategy is of course inherent within the relevant safety standards, but the reasons for why certain requirements are specified are rarely obvious, so a more fundamental understanding of the subject permits those within manufacturing, installation, servicing and other organisations to carefully adapt such requirements to suit the characteristics of their specific equipment.

## Analysis of failure scenarios

With respect to the sequence of events in Figure 1, it is obvious that avoidance of the ignition event is the preferred focus, rather than overly investing in minimizing the severity of the consequences. Therefore, first it is important to gain an appreciation of the components that lead to ignition and this is addressed with respect to the probability of certain events occurring. The probability of ignition ( $P_{ign}$ ) is a function of a three main factors:

- the probability of leakage,  $P_{leak}$
- the probability of refrigerant accumulating to form a flammable concentration,  $P_{flam}$
- the probability of active ignition sources being present,  $P_{soi}$

Thus, the probability of ignition can be equated to the product of these three factors (equation 1).

$$P_{ign} \cong P_{leak} \times P_{flam} \times P_{soi}$$

Although it should be recognised that it is not possible to completely eliminate the risk (i.e.,  $P_{ign} = 0$ ) since there will always be a probability of a leak, and if there is a leak there must be at least an infinitesimally small flammable region, and there is always a chance of a source of ignition somehow being introduced to the area. Nevertheless, it is relatively straight forwards to deduce from the contributing factors, the general principles for minimizing the flammability risk:

- reduce the likelihood of leakage
- reduce the possibility of leaked refrigerant accumulating
- reduce the occurrence of sources of ignition

These may be achieved in different ways depending upon the situation under consideration, and the sections henceforth provide an overview of how these can be achieved. However, in doing this it is appropriate to analyse the risk by discretising the problem according to physical location and the type of activity being carried out, since the causes of failure and ignition and the means of mitigation tend to differ accordingly.

An example of this approach is provided in Figure 2, where the situations to be analysed are broken down by considering the presence of gas and potential sources of ignition, under the following:

- within the room, during normal operation
- associated with the equipment, during normal operation
- within the room, during servicing or maintenance work
- associated with the equipment, during servicing or maintenance work

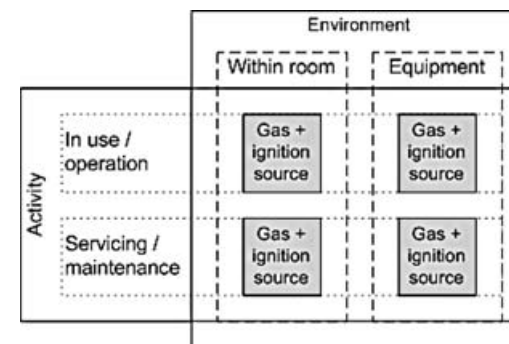

Figure 2: Identification of situations to be considered

To illustrate, service and maintenance activities tend to use equipment that may possess sources of ignition that are not normally present during normal operation (such as recovery machines and brazing torches) and/or electrical devices on the equipment may be exposed during servicing. Also the accumulation of leaked refrigerant within the equipment should be treated and controlled in a different way, compared to it flowing towards, or being released into the surrounding area.

## Refrigerant leakage

Leakage of refrigerant may occur from any refrigerant-containing part of the system, and from service equipment that is also temporarily used to transfer refrigerant. A release may occur during normal operation or during servicing, and may be a result of one or more causes. If these causes can be identified and techniques are adopted to mitigate them, then – with reference to equation (1) – the risk of ignition can be reduced. Table 1 lists a number of mechanisms that may lead to leakage, and some examples of mitigation approaches are also provided. In general, the design stage should adopt a combination of historical information (feedback from previous and existing installed equipment), guidance from standards, product testing and technician training (so that the physical construction is done according to the intended design). Similarly, during servicing or maintenance, if the circuit has to be broken into, it is essential that the connection is remade with at least equal quality.

Activity	Mechanism	Mitigation examples
In use/ operation	External mechanical impact	Follow materials standards Follow jointing standards Laboratory testing Field trials/historical data Correct circuit design Worker training
	Fatigue/work hardening	
	Mechanical wear	
	Corrosion	
	Stress corrosion cracking	
	Shearing from circuit harmonics	
	Joints from poor construction	
Poor components		
Servicing/ maintenance	External mechanical impact	Robust housing design Suitable marking and notices Technician training
	Mechanical impact during servicing	
	Intentional breaking into circuit by technician	
	Accidental breaking into circuit by technician	
	Dis- and re-connecting charging hoses	

Table 1: Examples of release mechanisms and mitigation

In evaluating the risk presented by a refrigerant release, it is useful to get an appreciation of the nature of typical leaks. Figure 3 is some example data for a leak that occurred from a coldroom evaporator, where a locally positioned sensor monitors the refrigerant concentration at given time intervals. It is seen that the leak is initiated at the same time as a defrost cycle, and although from that point on intermittent leakage continues, it is always aggravated by the defrost cycle. This will be due to the higher temperature imposed by the defrost heaters causing expansion of the construction materials, thereby forcing open any leak holes. Figure 4 shows another situation, where a leak evolves from a relatively minor pin-hole, to a catastrophic leak over the period of about 15 days. The cause of this is unclear but is likely to be a combination of vibration along the pipe, and temperature and pressure fluctuations.

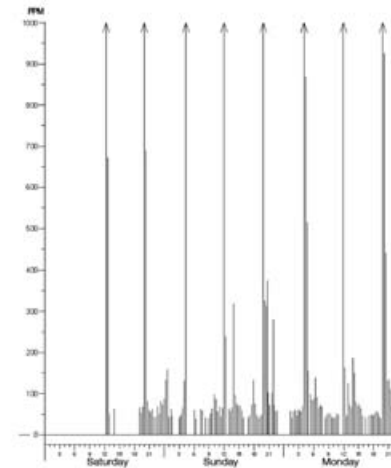

Figure 3: Typical leak from evaporator which is aggravated by defrost cycle (3 per day) (Ayers, 2000)

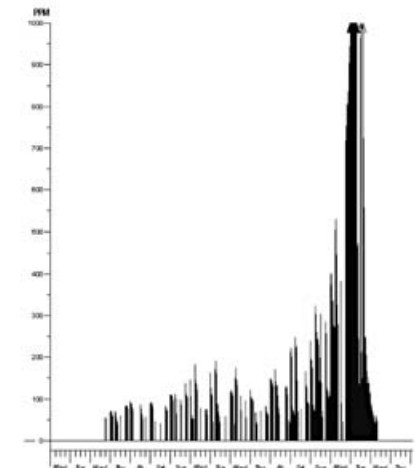

Figure 4: Evolution of a "catastrophic" leak from pipework joint over a 15 day period (Ayers, 2000)

The examples above are typical of most leaks, with the exception of external mechanical impact or intentional breaking in. Thus, it is useful to recognise that an instantaneous release of the entire refrigerant charge is unlikely to happen, but instead a gradual evolution of the leak, which may culminate in a major release of the remaining charge. Such characteristics of refrigerant leakage can similarly be presented in terms of likelihood of leak of a particular size. Figure 5 presents the probability of leaks of different

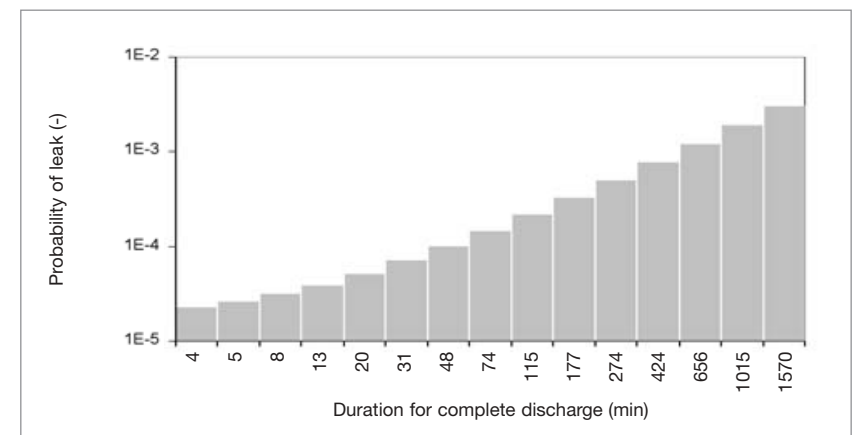

Figure 5: Probability distribution for different sizes of complete refrigerant leaks from medium-sized systems

sizes, for example, the leak on the far-left is a “catastrophic” leak, where the entire charge may be released within four minutes, whereas at the far-right is a pin-hole leak, which may take more than one day for the system charge to escape.

## Dispersion of refrigerant

Once a leak has occurred, the risk becomes a function of the behaviour of the gas with respect to the local environment. In particular, the release may originate from a refrigerant containing part located external to the confines of the refrigerating equipment, or from a part located within the housing. If the release occurs within the housing, then it may be rapidly transferred out of the equipment, or it may accumulate within. For example, if the conditions are such that the refrigerant exiting the leak hole is immediately mixed with the surrounding air within a very large space, then the amount of flammable material will be small, and unlikely to come into contact with a source of ignition, thus a small  $P_{flam}$ . Conversely, if the refrigerant leak enters a relatively small space with minimal air movement, then due to its density being greater than that of air, it may accumulate and exist for a longer period of time within its flammable limits. The larger this “cloud” and the longer it exists for, then the greater the likelihood that it may come into contact with an active source of ignition, resulting in a large  $P_{flam}$ .

Figure 6 illustrates this concept of the formation of a flammable region; that is the volume of the gas/air mixture that is in a concentration between the lower flammability

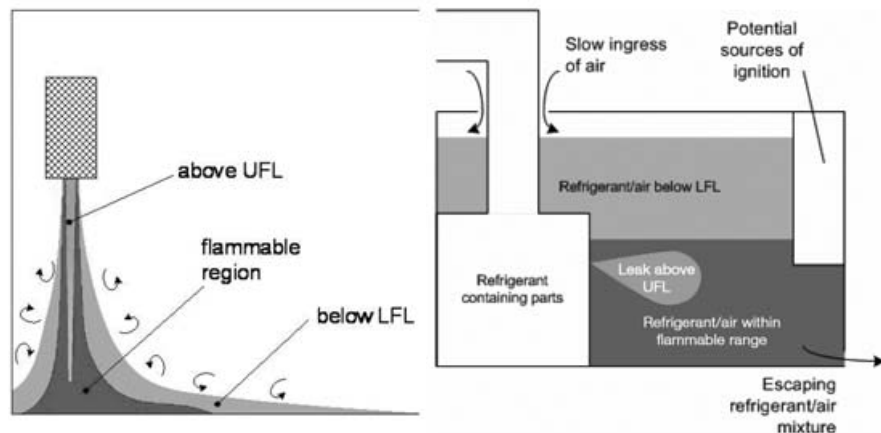

Figure 6: Illustration of the flammable region following a refrigerant leak from an evaporator into a room

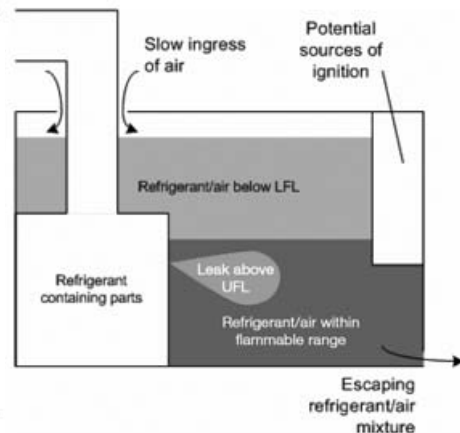

Figure 7: Illustration of the flammable region following a refrigerant leak within equipment housing and gradual escape of mixture

limit (LFL) and upper flammability limit (UFL). For hydrocarbons, the LFL and UFL are approximately 2% – 10% by volume in air. The duration that this flammable region exists for may be termed the flammable time. Thus, the product of flammable volume  $\times$  flammable time can be considered proportional to the risk; using techniques to reduce this results in a lowering of the risk.

Typically, the size and duration of the flammable region is related to the concentrations that evolve following a release of refrigerant. These concentrations vary according to a large number of variables, some of which can be controlled and some of which are uncontrolled. As implied above, a release into an environment with high amounts of air movement will result in low concentrations, whereas high concentrations will occur in an environment under quiescent conditions.

A slightly different situation is that illustrated in Figure 7, where a leak occurs within the housing of the refrigerating equipment. Due to the level of confinement, only a relatively small quantity of refrigerant can escape from the enclosure and a flammable concentration rapidly develops, and thereon remains for a long duration. The small volume of the enclosure encourages homogenous mixing of the refrigerant and air mixture into a high concentration, thus with the continual ingress of air, it is possible that a flammable concentration could always be present. With this type of situation it is important to ensure that there is as free a flow of air through the enclosure as possible, which may of course require mechanical ventilation.

Table 2 lists a number of parameters that affect the concentration – and therefore flammable volume – of a release of refrigerant. Those in the left column are parameters that may be addressed within the design of equipment, whereas those in the right column cannot be controlled when designing equipment. For example, where it is intended to minimise the likelihood of high concentrations occurring following a leak, the equipment can be designed with minimized refrigerant charge, design the evaporator (or condenser) airflow to discharge with a higher velocity, and maybe position as much refrigerant-containing parts as high as possible.

CAN BE CONTROLLED BY DESIGN	CANNOT BE CONTROLLED BY DESIGN
Smaller refrigerant charge	Smaller room size per unit mass of refrigerant
High air speed within room	High room infiltration rate or poor room tightness
Air discharge at low level	Greater thermal output from heat sources to increase internal convection
Air discharge in downward direction	Liquid (instead of vapour) release phase
Longer duration of ventilation time	High refrigerant release velocity
Refrigerant release at high level	Refrigerant release in upward direction
Refrigerant release close to ventilation discharge or return	Longer duration refrigerant release time

Table 2: Parameters that result in a lower concentration and smaller flammable regions



An illustration of how certain parameters affect the maximum floor concentration within a room following a release of R-290 is shown in Figure 8 (Colbourne and Suen, 2003). The situation under consideration is for a complete “catastrophic” release of 0.5 kg charge within 3½, 7 and 14 minutes, under a range of airflow rates. (The airflow duct size is fixed, so a higher airflow rate results in a higher average air speed within the room.) The equipment (refrigerant containing parts and airflow duct outlet) is positioned at about 1 m above floor level. In this situation, it can be seen that the floor concentration is much higher at low airflows, but as the airspeed increases, so does the mixing of the leak, and therefore with the higher airflows stratification within the room is almost eliminated. Similarly, as the leak time increases (equating to a lower mass flow rate) the mixing of the release also improves, and if extrapolated, it can be seen that any leak occurring over a much longer duration will also completely avoid stratification.

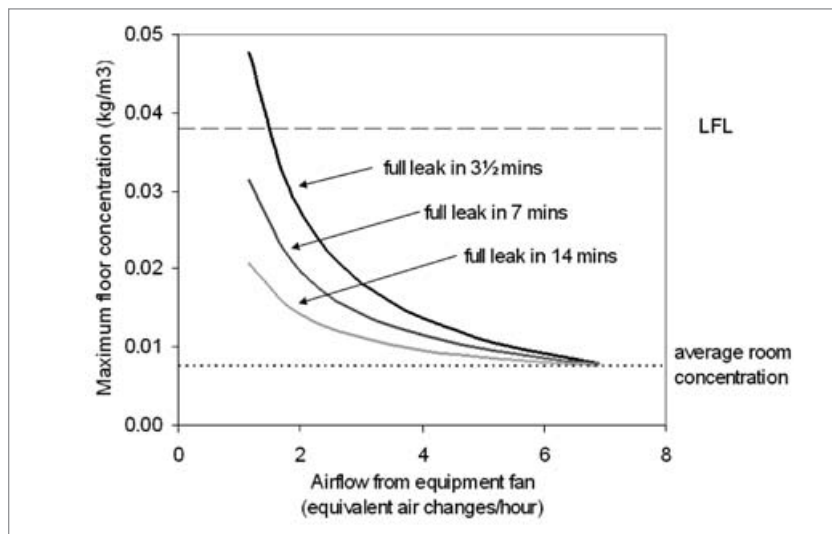

Figure 8: Examples of maximum floor concentration with changes in room airflow and leak duration

Based on similar conditions to the above example, Figure 9 and Figure 10 show how the size and duration of the flammable region is affected by these parameters (Colbourne and Suen, 2004). With the example in Figure 9, it is seen that there is an exponential reduction in the flammable volume-time as the duration for the entire refrigerant charge to leak extends. Even more dramatic is the reduction in flammable volume-time simply by slightly increasing the airspeed within the room (Figure 10).

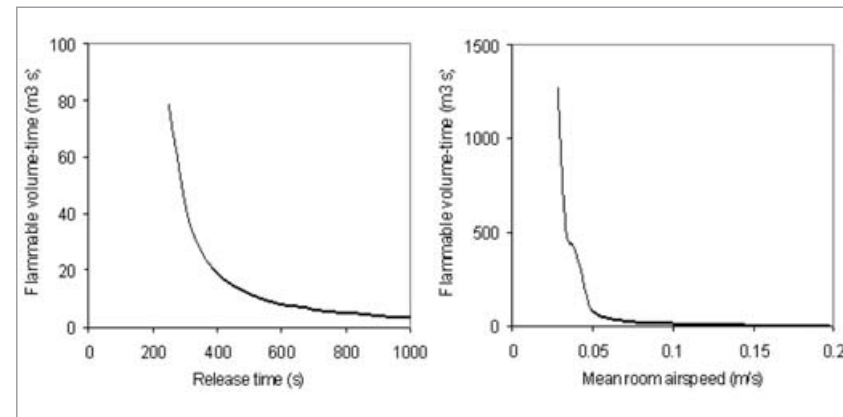

Figure 9: Effect of refrigerant leak time on flammable region

Figure 10: Effect of room airspeed on flammable region

A useful approach for investigating and subsequently minimizing  $P_{flam}$  is through modelling the flammable volume-time and experimental determination of concentrations, arising from leaks from different locations and under differing circumstances. Features such as the use of mechanical airflow within equipment and the room can be introduced or modified to help disperse a potential release of refrigerant to safe concentrations.

## Sources of ignition

Potential sources of ignition primarily include switches (manual, pressure, thermostatic, timed, relays, contactors, overloads, etc). These should be addressed by using components which are sealed, enclosed, solid state or specially positioned (according to leak simulation testing), as prescribed within the relevant safety standards such as EN 378. However, depending upon the approach used for avoiding sources of ignition, its integrity over the lifetime of the equipment must be considered. In particular:

- Sealed or enclosed components. A damaged component could be replaced by one of insufficient tightness, or after repairing a component in-place, the method of sealing may accidentally be spoiled. In addition, general wearing of a component, such as through weathering or corrosion may also render it unsafe according to the requirements of safety standards.
- Solid state components. Whilst such devices do not normally produce sparks, in the event of overloading or manufacturing defects, they may occur excessive temperature, arcing or even a naked flame.

– Specially positioned components. Employing the approach that uses testing to identify the positioning of potential sources of ignition in locations that will not experience flammable concentrations in the event of leakage are advisable since it avoids the potential complications highlighted above. However, it is important, firstly to ensure that the tests are conducted and analysed thoroughly since it is easy to make errors whilst carrying out this approach (Gigiel, 2004), and secondly that it is not possible for the same or similar component to be repositioned.

In addition to the above, it is also worth evaluating the potential for parts that are not normally considered, to be sources of ignition under failure scenarios. This may include electrical connections and terminals that may work loose, or fuses that may blow.

## Consequences

Although mitigating possible consequences of an ignition is more difficult to handle in terms of design, it is useful to understand them and to consider available options.

As mentioned previously, there are three basic forms of primary consequence:

- A jet fire, which would typically arise from instantaneous ignition of a refrigerant leak
- A flash fire, which would result from ignition of an unconfined pool of refrigerant and air mixture
- Overpressure, which is expected to occur when a volume of mixed refrigerant and air is ignited within a confined space, and is a result of the expansion of the heated gases

Jet fires are less likely, since the velocity of the leaking refrigerant and the surrounding gas/air boundary are generally too high for a flame to be sustained. Indeed, special conditions, or the presence of an external fire, are necessary for a jet flame to exist.

Flash fires are likely if a leak of refrigerant is allowed to collect in a location that a potential source of ignition is present, or in the case of a cloud of flammable material passing along the floor. A flash fire is generally instantaneous, and certainly with the quantities of flammable material used as refrigerant, the intensity of thermal radiation emitted is unlikely to be sufficient to produce a secondary fire. However, people within the immediate vicinity could receive burns.

Overpressure of a sufficiently high value is termed an explosion, and it is largely a function of the degree of confinement within which the ignition occurs. Generally, a very large flash-fire within a room will approach an explosion if the quantity of the flammable material is sufficiently high and if the room is well sealed and contains no windows so that the pressure cannot be easily relieved. However, the situation of most concern is that of ignition occurring within equipment housing, where a high degree of confinement blows out the casing walls and causes a shockwave that could result in injury to people or damage to property.

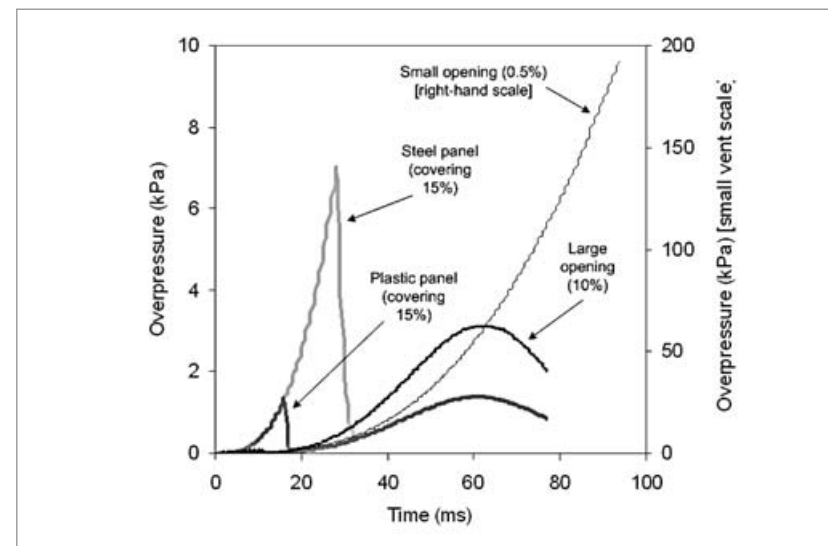

Figure 11: Overpressure evolution with time, arising from ignition within an enclosure and different types of vent-openings and panels

To provide an example of such a situation, the overpressure evolving from different design features of equipment housing is shown in Figure 11. It is assumed that refrigerant has leaked into a rigid metal enclosure that is half filled with a stoichiometric gas/air mixture. Simulations for four situations are presented:

- housing with 0.5% of the enclosure wall area open
- housing with 10% of the enclosure wall area open
- housing with a steel panel covering 15% of the wall area
- housing with a plastic panel covering 15% of the wall area

It can be seen that with a very small opening, the effects of ignition could result in a significant overpressure (nearly 200 kPa), with the possibility of the resulting shock-wave causing notable damage to property. However, if the opening is significantly larger (say 10% of the enclosure surface area, in this case) then the rising pressure is rapidly vented, and the resulting overpressure is some 100 times lower than in the previous case. The use of detachable panels has a similar effect, although there tends to be an initial peak that represents the blowing-off from its fixings. Nevertheless, the resulting overpressure is massively reduced compared to the small vent opening, and it would be highly unlikely to result in secondary damage. This example emphasises the importance of appropriate design of equipment housing.

---

## Service/maintenance and technician training

---

The use of competent and qualified technicians, as well as concise working procedures are essential for ensuring that safety of equipment is maintained once a product has been installed.

Human behaviour is known to have greatest influence on risk of ignition (Colbourne and Suen, 2004). With reference to equation (1), the potential for a leak whilst working on a system is known to be up to 10 times higher than during normal operation (for example, because of breaking into circuits), and the likelihood of 'active' ignition sources being present is also higher (for example, presence of extra machinery, brazing, connecting electrics, etc). Thus the risk of ignition is one or more orders of magnitude greater during servicing and maintenance activities. In order to offset these factors, consideration must be given to area and equipment pre-checks, proper working practices, use of suitable equipment and ensuring the good condition of the equipment prior to leaving the site.

Training in accordance to an agreed curriculum and to a suitable level of expertise is essential, but also regular updates and reminder sessions are also important to help avoid nonchalant behaviour developing in case technicians become comfortable with working on flammable refrigerants. Safety-related training should cover at least the following topics:

- flammability properties
- illustration of the consequences of ignition
- appropriate design requirements for equipment
- marking of equipment, general warning signage
- checks to the local area, to service equipment, and to the refrigeration equipment
- proper techniques for breaking into system, recovery, evacuation, charging, etc
- suitable service equipment and tools
- refrigerant detection and ventilation methods
- cylinder handling and storage
- final checks and ensuring equipment is left proper condition

Both written and practical assessments are desirable.

Ideally, it is always preferable to remove the appliance for servicing to a workshop where the facilities are dedicated to such activities, rather than servicing it in-place. This could apply specifically to activities that require the breaking into the refrigerant circuit.

From the time at which a technician arrives at the equipment, a series of procedures should be followed to ensure that the risk of ignition is minimised:

- **Proper tools.** Evaluation of servicing equipment and refrigerant handling is important since several of the tools and equipment used for non-flammable refrigerants may be unsuitable. Examples include refrigerant recovery machines, vacuum pumps and hand-held refrigerant detectors.
- **Familiarisation.** As with any equipment, the technicians should familiarise themselves with the construction and operation of the equipment, and specifically for systems using flammable refrigerants, the special safety features. Such information ought to be made available in the manuals. In addition, the technician should read the service and maintenance logs from previous visits.
- **Checking the area.** Prior to starting work on equipment, it is important to be aware of the condition of the locality, for example, presence of other people, potential sources of ignition, availability of natural or mechanical ventilation, and so on. If concerns are identified, they should be addressed prior to handling refrigerant, for example, establish the working area with signage (“keep out – flammable gas”), use of refrigerant detectors, and ensuring the availability of a fire extinguisher.
- **Preparing the equipment.** Regardless of the type of work (i.e., refrigerant handling or otherwise), the equipment must be safe to work on. This includes isolating the electrical supply whenever appropriate, carrying out routine inspection of electrical components to make sure the sealing or enclosure is safe, and that any faults are already identified.
- **Brazing.** In the case of connecting pipes and components, options such as mechanical joining methods exist, instead of brazing. However, these alternatives typically result in a higher occurrence of leakage, so brazing is often employed and therefore it is important to ensure procedures such as prior checking for the presence of refrigerant and flushing the system with nitrogen are always carried out.
- **Completion of work.** After working on the equipment, it is essential to ensure its continuing integrity to the level required by the relevant safety standards. Specifically, this necessitates checking that the refrigerant charge has not been exceeded, that it is leak-tight, ensuring ventilation is operating correctly and not obstructed, and that all marking and warning signs are in place and visible. Of particular importance is the updating of log books to ensure that any work carried out is clearly recorded.

A review of the known incidents associated with the use of flammable refrigerants is important to avoid mistakes in future. Information has been collated to provide some basic details of incidents worldwide with HC equipment (Colbourne et al, 2003). In total eight incidents were found, six of which caused minor damage, and two resulted in jet flames only. The important observation is that most were due to poor servicing, and all were avoidable with good training. Three identical incidents were due to poor design which caused leakage into an apparently sealed enclosure that contained a source of ignition. Also, none were related to the refrigerant charge size or stratification of leak within a room.

## Concluding remarks

Due to their flammability, the use of HC refrigerants introduces an additional safety concern to the design and use of refrigeration equipment. In general terms, this is handled through conformity to safety standards and regulations. However, further improvements in the level of safety may be achieved through consideration and analysis of the causes of an ignition event and the potential consequences. The findings from carrying out an exercise of this type can be used to improve the design, construction and service and maintenance practices associated with the equipment under consideration. In general, the principles to follow for minimising the flammability risk are:

- reduce the likelihood of leakage
- reduce the possibility of leaked refrigerant accumulating
- reduce the occurrence of sources of ignition

To date, over 200 million domestic refrigeration appliances have been in use, some for over 10 years. A large number of other types of refrigeration, air conditioning and refrigeration equipment have also been placed on the market during this time. The fact that there have been a negligible number of incidents attributable to flammability demonstrates that this property can be handled well.

In order to gauge the significance of the risk posed by equipment using HC refrigerants, it is noteworthy to compare them against the fire risk experienced by other types of appliances. Figure 12 provides data in terms of the number of fires caused by different appliances, based on UK fire statistics over several years. Typically, between 1 in 10,000 to 1 in 100,000 appliances per year cause a fire, usually because of electrical faults and escape of (fuel) gas. (It should be noted that the figures for domestic refrigerators have not risen since the introduction of R-600a.) Values for “intolerable” and “negligible” risk of fatality for members of the public are also indicated, as specified by the UK Health and Safety Executive (HSE) (Colbourne and Suen, 2004).

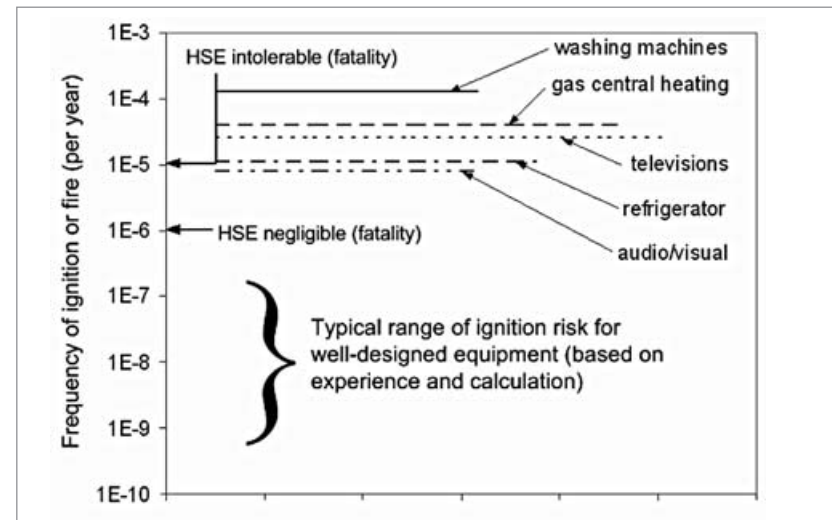

Figure 12: Comparison of the risk from ignition of refrigeration equipment using flammable refrigerants with government tolerances and domestic appliances

By comparison, the risk of ignition only for equipment using flammable refrigerants – based both on estimated statistical data (assuming 10% of incidents have been reported) and risk modelling – is significantly lower than the other values presented. Nevertheless, manufacturers, suppliers and service and maintenance companies should take the issue of flammability seriously, and give consideration to identifying and overcoming failures and errors envisaged throughout the life of equipment, from the manufacturing process to technicians’ procedures to end of life disposal. Adequate systems should be put in place to include the following:

- training and re-training of factory staff
- use quality control systems (ISO 9001)
- monitoring and feedback of equipment placed into use
- monitor reliability of suppliers/components
- approval procedure for contractors and manufacturers
- develop type-test regime for components and assemblies
- third party inspections

Adopting such systems can provide ongoing improvements in the safety of equipment.

---

## References

---

Ayers, J. Parasense study on refrigerant leaks. Parasense Environmental Products Ltd, Gloucester, UK. November 2000.

Colbourne, D, Suen, KO. Appraising the Flammability Hazards of Hydrocarbon Refrigerants using Quantitative Risk Assessment Model. Part II: Model evaluation and analysis. *Int. J. Refrig.*, pp. 784 – 793, Vol. 27. 2004.

Colbourne, D, Suen, KO. Equipment Design and Installation Features to Disperse Refrigerant Releases in Rooms. Part II: Determination of procedures. *Int. J. Refrig.*, No. 6, Vol. 26. 2003.

Colbourne, D, Suen, KO, Ritter, TJ. A Risk Assessment Model for Hydrocarbon Refrigerants. *Proc. Inst. Refrig.*, London, 2003.

EN 378: 2007 Refrigerating systems and heat pumps – Safety and environmental requirements.

Gigiel, A. Safety testing of domestic refrigerators using flammable refrigerants. *Int. J. Refrig.*, Vol. 27, Issue 6, pp. 621-628, 2004.

Institute of Refrigeration (IOR). Code of Practice for the design of refrigeration systems using A2 and A3 refrigerants. Institute of Refrigeration, UK, 2008.

# Safe Plantrooms for Large Hydrocarbon Chillers

AMIR TADROS, Connell Wagner Pty Ltd, Australia

DR. IAN MACLAINE-CROSS and EDDIE LEONARDI, School of Mechanical and Manufacturing Engineering, UNSW, Australia

---

## Introduction

---

The need to convert existing and newly manufactured chillers to hydrocarbon refrigerants arose from the environmental impacts of fluorocarbon refrigerants on global warming and ozone depletion. The environmental impacts and legislation in many jurisdictions require water chillers to cease using fluorocarbon refrigerants. Hydrocarbons, ammonia, carbon dioxide, air and water are natural working fluids with minimal environmental impact.

Hydrocarbons and hydrocarbon mixtures are now widely used with better performance in several applications including heat pumps, air conditioners, refrigerators, freezers and mobile air conditioning systems. The hydrocarbon refrigerants propane, butane, isobutane, pentane, isopentane, hexane and propylene, and their mixtures are possible replacements in chillers. Hydrocarbons have low cost, low environmental impact and are predicted to be more energy efficient in chillers for both spray and flooded evaporators. However, hydrocarbon refrigerants are not yet used in centrifugal chillers with flooded evaporators for air conditioning applications.

This paper provides valuable insight into safety precautions and emergency procedures for refrigeration and air conditioning plantrooms. This can make injury or damage from hydrocarbon leaking, mixing with air and igniting improbable. Explosion venting theory and Australian standards were reviewed, errors corrected and omissions identified. The major new recommendations follow. A fire and vapour proof wall should separate the chiller from all other plantroom components. This compartment should be vented to atmosphere through floor-to-ceiling louvres with projected area typically greater than 62% of the area of a side wall. Computational fluid dynamics (CFD) studies were undertaken to prove the accuracy of the new proposed analytical expression of calculating the required vent size. If the minimum design ambient temperature is less than 5 K above the refrigerant boiling point the compartment floor should form a basin to hold twice the refrigerant liquid volume.

## Environmental impacts

Large chillers have been used with flooded tube-in-shell evaporators and may have refrigerant charges over 1000 kg. Table 1 lists the three most popular chiller refrigerants and some replacements in order of ozone depletion potential and global warming potential. Most countries are reducing emissions from electricity generation and so reducing the impact of indirect energy production related emissions.

Chemical name	Refrigerant	ODP	GWP	m.mass	NBP	$v_r$
		R11	100yr	g/mol	°C	m/s
trichlorofluoromethane	CFC-11	1.00	4600	137.4	23.8	0
chlorodifluoromethane	HCFC-22	0.055	1700	86.5	-40.7	0
1,1-dichloro-2,2,2-trifluoroethane	HCFC-123	0.02	93	152.9	27.8	0
1,1,1,2-tetrafluoroethane	HFC-134a	0.00	1300	102.0	-26.2	0
1,1,2,2,3-pentafluoropropane	HFC-245ca	0.00	640	134.1	25.2	> 0
2-difluoromethoxy-1, 1,1-trifluoroethane	HFE-245fa2	0.00	570	150.1	29.2	> 0
difluoromethane	HFC-32	0.00	550	52.0	-51.8	0.067
1,1-difluoroethane	HFC-152a	0.00	140	66.0	-25.0	0.23
propylene	HC-1270	0.00	6.1	42.1	-47.7	0.512
ethane	HC-170	0.00	4.3	30.1	-88.8	0.476
isopentane	HC-601a	0.00	3.0	72.2	27.8	0.399
normal pentane	HC-601	0.00	3.0	72.2	36.1	0.43
isobutane	HC-600a	0.00	2.7	58.1	-11.7	0.37
normal butane	HC-600	0.00	2.7	58.1	-0.5	0.449
propane	HC-290	0.00	1.1	44.1	-42.1	0.464
ammonia	R-717	0.00	0.0	17.0	-33.3	0.077
carbon dioxide	R-744	0.00	1.0	44.0	-78.4	0
water	R-718	0.00	0.0	18.0	100	0

Table 1: Environmental impacts, molecular mass, normal boiling point and maximum laminar burning velocities in air of some refrigerants for air conditioning with large water chillers

The Global Warming Potentials in Table 1 come from or are consistent with IPCC (2001) and Johnson and Derwent (1996). Table 1 also includes molecular mass because low molecular mass improves heat transfer. Refrigerants with similar boiling points and molecular mass may be substituted for each other in existing equipment sometimes without modification. Hydrocarbons range in boiling point from -88.8 to 36.1°C so they or their mixtures are capable of replacing any of the fluorocarbons. Use of mixtures as replacements gives better matching. Replacement of fluorocarbons by hydrocarbons in some large centrifugal chillers has been predicted to reduce electricity consumption by 5% mainly due to improved heat transfer (Maclaine-cross 2002, Tadros et al. 2006a, Tadros et al. 2006b).

## Flammability

Maclaine-cross (2004) shows the usage and risk of hydrocarbon refrigerants in motor cars. Despite hydrocarbon refrigerants' flammability and even without engineering supervision and, in some cases, without adherence to any rational code of practice, there were no incidents before 2004 of the refrigerant leaking and catching fire (Maclaine-cross 2004). The quantity of refrigerant likely to be used in a chiller could range from a few kilograms to 1000 kg compared to 200 g in the case of car air conditioning. This comparison provides a sound reason not to ignore the flammability risk with chillers. In spite of hydrocarbon flammability, it has been used in plantrooms as fuels for over a century and there are accepted standards for their use in large quantities in plantroom boilers. In addition it has been used successfully for decades in the chemical process industry. If using hydrocarbon as a refrigerant adds to the site risks, the chemical process industry would have rejected it, which is not the case.

The handling of the refrigerant, either flammable or nonflammable, by the chillers takes place at the central plant (plantroom). Centrifugal chillers incorporate a secondary cooling circuit (water or brine). Plantroom location is independent of the conditioned space; for example, the plantroom can be located outside the building. In addition, much less maintenance work is needed at the conditioned spaces.

ANSI/ASHRAE standard-34 (2001), ISO standard-817 (2007), EN-378 (2007) and the Australian standards AS-1677.1 (1998) classified refrigerants according to their flammability and toxicity. Although most refrigerants are flammable given the right conditions, some are more flammable than others (Table 1). In addition, toxicity does not give a clear judgment on which substance is lethal. For example, ammonia is classified as a toxic refrigerant, however its distinctive smell will give an early warning so it will not be lethal. On the other hand although R-22 is considered a safe refrigerant, many have been suffocated from it due to its lack of smell. Another example is that the products of combustion from a non toxic refrigerant can be highly toxic. Burning velocities  $v_r$  in Table 1 are maxima for air mixtures at 25°C and 101.2 kPa (Glassman 1987, Jabbour 2004).

For a building with general occupancy AS/NZS hydrocarbon charge provided the primary refrigeration system is totally in the open air or a machinery room complying with its Section 4. Clause 4.7.2(c) requires there should be no atmospheric communication between this machinery room and the space with general occupancy. The authors believe that such standards do not contain sufficient measures to limit the consequences of ignition of a leak from a hydrocarbon refrigerant charge over 5 kg. The purpose of this paper is to describe additional measures to limit the consequences of hydrocarbon refrigerant ignition. The measures in Sections 4 and 5 limit atmospheric releases. Section 6 measures ensure leaks are rapidly diluted below the lower

explosive limit and Section 7 minimises the possibility of ignition. If ignition does occur Section 8 ensures overpressure does not damage building or equipment or injure people. Section 10 recommends emergency procedures which are often neglected.

## Refrigerant handling

The handling equipment must be designed for the refrigerant containers used. Under no circumstances should the chiller plantroom be used as a storage room. Refrigerant storage on site outside the chiller plantroom should comply with AS 1596:2002 or AS 1940:1993 as appropriate. The natural ventilation ensures the plantroom will be close to ambient. When the minimum design ambient temperature is less than 5 K above the refrigerant boiling point (Table 1) a major release might occur and some refrigerant remain as liquid for a substantial period of time. Refrigerant liquid must not leak out of the plantroom and down stormwater drains.

For refrigerants with such boiling points the chiller plantroom floor should be designed as a catch basin capable of holding more than twice the refrigerant charge as liquid (Figure 1). A typical depth is 100mm. The floor should slope towards an extraction point where an explosion proof pump can remove first any water and then any refrigerant liquid to containers outside the plantroom.

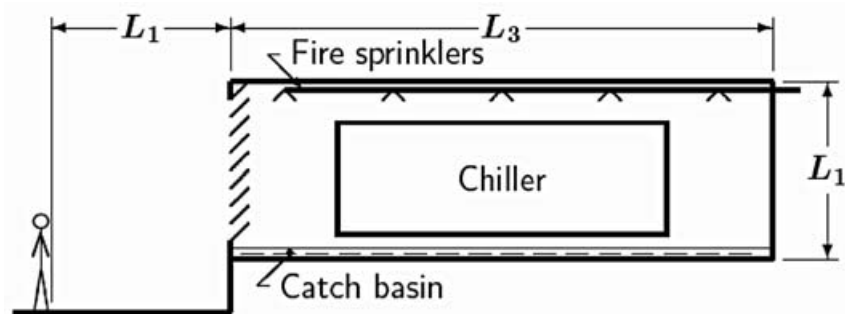

Figure 1: Schematic elevation of plantroom with catch basin

## Leak minimization

Refrigerant charging or recovery is the most likely time for a major release. The charging technician should monitor mass of refrigerant added, evaporator and condenser pressure with his hand on the charging shutoff valve. All the hydrocarbon refrigerants in Table 1 are from their molecular masses heavier than air (except ethane). At least two flammable gas detectors (AS 61779.1:2000, AS 61779.4:2000) should be used per plantroom and should be far from the vent and each other (AS 61779.6:2000) and trigger at 20% of the lower flammability limit. They will normally be fixed to a wall more than 300 mm above the floor to protect from accidental damage and less than 600 mm to ensure detection of refrigerant vapour. When a chiller is operating the compressor can greatly increase the leakage rate and water pumps might transfer refrigerant outside the chiller plantroom. Either flammable gas detector should shut-down the chiller then electrically isolate all compartment equipment except emergency lighting. The access fire door to the chiller plantroom should be to a space clear of flammable materials with access restricted to qualified persons. The door should freely open outwards but its catch should be designed for overpressure above 2 kPa.

## Mixture dilution

For above ground plantrooms, natural ventilation is available even if a refrigerant release coincides with an electric power failure. The screened louvres in Section 8 should be split between the top and bottom of the outside wall or extend from floor to ceiling to allow maximum height difference for natural convection. For below ground plantrooms, we recommend charge be limited to less than 1 kg because of the absence of failsafe mixture dilution.

In the event of a major refrigerant release the plume from the bottom of the louvers will be flammable. Mixing of the plume with air outside the plantroom should not be obstructed. Outside traffic and ignition sources should not approach the louvers closer than the plantroom floor to ceiling height. Refrigerant pressure relief valves on the chiller should connect to steel pipes which discharge outside the building upwards and 3 m clear of ignition sources, persons or property.

## Ignition prevention

The electrical system of the chiller plantroom should be suitable for the explosive atmosphere created by a refrigerant release (AS 2381:1999). In particular utility sockets

should permit plug removal only if the socket is isolated. All emergency procedure signs should include “No Smoking”.

## Overpressure and venting

Combustion waves may be either deflagrations (flames) or detonations. Detonations are destructive but for a plantroom filled with flammable gas mixture require special ignition such as high explosives (Bjerketvedt et al. 1997). “Gas explosion” is a general word that does not have a specific scientific meaning. Delbridge et al. (2003) in the Macquarie Dictionary defined the word explosion as “a violent expansion or bursting with noise, as of gunpowder or a boiler”. For gas release and combustion with air it is more accurate and clearer to use gas deflagrations, since the resultant velocities will be subsonic. “Gas detonation” can only be used if a supersonic wave exists (shock wave). A detonation wave should not be confused with a detonation inside an internal combustion engine. In brief, for an accidental hydrocarbon air mixture combustion the possibilities are flash fire or deflagration which will result in an overpressure.

The analytical expression to calculate the optimum vent area inside enclosed plantrooms in its final form can be written as follows:

$$\frac{A_v}{A_{fm}} = (v_p/v_r - 1)v_r \sqrt{\frac{K_{tot}\rho_r}{2\Delta P_m}} \quad (1)$$

The analytical expression can predict the maximum overpressure if the vent area is known. By rearranging Equation 1, the maximum over pressure can be calculated as follows:

$$\Delta P_m = \frac{K_{tot}\rho_r}{2} \left[ \frac{A_{fm}}{A_v} (v_p/v_r - 1)v_r \right]^2 \quad (2)$$

For empty plantrooms with vents which are screened louvers  $K_{tot}=5$  is possible with a good design (Tadros et al. 2004). The vent area expression will be tested in Section 9 against the more accurate and more sophisticated CFD studies.

$A_{fm}$  depends on obstructions, room shape and the position of jets, vents and ignition sources. A partition with opening can create a flame jet increasing  $A_{fm}$  but the obstruction from typical chillers and pipes has only a small effect on  $A_{fm}$ . Consider a rectangular  $L_1 \times L_2 \times L_3$  plantroom with no fans, registers or partitions  $L_1 < L_2$  and vents along just the  $L_1 \times L_2$  wall (Figure 1). An ignition source on the axis perpendicular to the vent close to the opposite wall will give the largest  $A_f$  and

$$A_{fm} \approx \pi L_1 L_3 \quad (3)$$

Runes (1972) assumes uniform radial flame velocity from the ignition point giving  $A_{fm}$  equal or lower than Equation 3. Swift and Epstein (1987) and NFPA 68 (2002) use the internal surface area which is always greater than Equation 3.

## Damage to buildings

The main hazard from overpressure inside a building is flying glass from the windows and broken chunks of the building cladding which may also fall onto the street. Harris (1983) detailed some typical failure pressures of structural building elements due to overpressure from gas deflagrations; these values are outlined in Table 2. He also listed a range of failure pressures for a number of structural elements used in normal buildings, or industrial structures, subject to accidental gas combustion.

STRUCTURAL ELEMENT	FAILURE PRESSURE (Pa)
Glass windows	2000 – 7000
Room doors	2000 – 3000
Light partition walls	2000 – 5000
50 mm thick breeze block walls	4000 – 5000
Unrestrained brick walls	7000 – 15000

Table 2: Failure pressure of structural building elements (Harris 1983)

## Example vent area calculation

Consider a chiller containing 1 Mg of R1270 and occupying a 3.3 m by 8 m by 10 m plantroom. The overpressure safety factor is 2 and the weakest wall element have a maximum overpressure rating of 2 kPa and the screened louvers to atmosphere have a pressure drop coefficient  $K_{tot}=5$ .

AS/NZS 1677.2:1998 Clause 4.7.2(b) recommends a projected open vent area of 4.4 m<sup>2</sup>. For reactant density  $\rho_r=1.2$  kg/m<sup>3</sup> and for burning velocity  $v_r=0.512$  m/s (Table 1) Equation 1 gives:

$$\frac{A_v}{A_{fm}} = \left( \frac{v_p}{v_r} - 1 \right) v_r \sqrt{\frac{K_{tot}\rho_r}{2\Delta P_m}} = (8 - 1) \times 0.512 \times \sqrt{\frac{5 \times 1.2}{2 \times 2000/2}} = 0.1963$$

From Equation 3 the projected open vent area:

$$A_v = \pi L_1 L_3 \frac{A_v}{A_{fm}} = \pi \times 3.3 \times 10 \times 0.1963 = 20.3 \text{ m}^2$$

This is 62% of the area of a side wall.



For an enclosure capable of resisting 2 kPa overpressure NFPA 68 (2002) recommends a closed vent area  $A_v$  of 88.7 m<sup>2</sup>. The outside wall area is only  $3.3 \times 8 = 26.4$  m<sup>2</sup> so satisfying NFPA 68 (2002) would require at least three walls be vented.

### The effect of obstacles on the maximum overpressure

To understand the effect of obstacles on overpressure resulting from a deflagration wave, there are two factors involved here; the flame velocity and the flame frontal area. The magnitude of acceleration effect resulting from turbulence depends on the intensity and scale of turbulence. Also, while the flame front passes across the obstacles, it deforms and its total area increases. In addition a jet effect caused by flame velocity increased due to reduced flow area. In summary, the maximum overpressure increases through increasing the blockage ratio and also depends on the blockage's geometry. (Note: for a detailed literature review and sensitivity studies for this effect, please refer to the first author PhD thesis (Tadros 2008)).

### Comparison with the existing standards and CFD studies

Table 3 outlines a comparison of the vent area required to safely vent hot gases. The results were calculated using the recommended formula from NFPA-68 (2002) and the Australian Standard (AS-1677.2 1998) against results from the simplest form of Equation 1. The comparison in Table 3 illustrates the contradiction which exists in the current standards with regard to estimating the minimum vent area. It also shows the ability of the simple analytical vent area expression to predict the minimum vent area.

SOURCE	AS-1677.2 (1998)	EQUATION 1	NFPA-68
	Clause 4.7.2 (b)		(2002)
Vent Area	4.4 m <sup>2</sup>	20.3 m <sup>2</sup>	88.7 m <sup>2</sup>

Table 3: Vent area comparison

Comparisons between CFD modelling and the vent area expression were in good agreement. The model used inside FLUENT was shown to be an accurate technique for the prediction of a complex premixed combustion. The maximum overpressure calculated from the CFD study was within 14% of the calculated value from the analytical vent area expression. Figure 2 shows comparisons between the predicted analytical and CFD results for the maximum overpressure inside a plantroom. This agreement is particularly significant because correction factors were not used. The results discussed in this section showed that the overpressure can be small and unlikely to cause significant damage to the plantroom or a building.

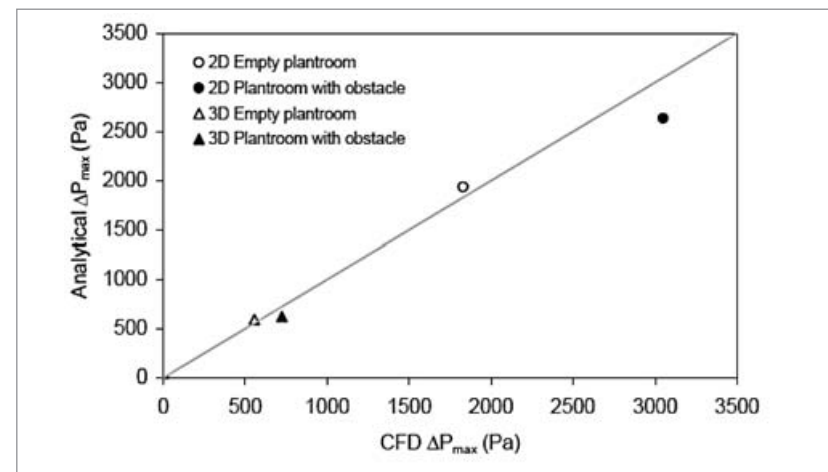

Figure 2: Comparison between the computed maximum overpressure from the analytical model against CFD results

### Emergency procedures

People panic in an emergency. Clear emergency procedure signs inside the chiller plantroom and outside the access door are necessary. If a major release occurs during charging the technician should shut all charging valves and leave the plantroom. If ignition follows the technician should just leave the plantroom immediately. Water sprinklers for fire protection should be installed in the chiller plantroom.

### Concluding remarks

This paper shows that plantrooms for chillers with large hydrocarbon charges can be designed and used safely through proper refrigerant handling, leak minimization, mixture dilution, ignition prevention and overpressure venting. This minimizes the consequences of any release or ignition. Major new recommendations were given, such as: a fire and vapour proof wall to separate the chiller or chillers and boilers from other plantroom components, and, if the minimum design ambient temperature is less than 5 K above the refrigerant boiling point, the compartment floor should form a basin to hold twice the volume of refrigerant liquid (Section 5).

Overpressure venting theories and various standards (AS-1677.2 1998, NFPA-68 2002) were reviewed, inconsistency resolved and disagreements and limitations were identified. The vent area expression is also an effective method for predicting the

maximum overpressure as is proved in Table 3. The maximum overpressure calculated from the CFD study was within 14% of the calculated value from the vent area expression (Figure 2). All of the above mentioned measures, combined with emergency procedures, will ensure a safe hydrocarbon refrigerant plantroom.

---

## Acknowledgements

---

The first author would like to acknowledge with many thanks the help of the following individuals: Dr Rodney Boyd for reviewing this paper and Mrs. Carol Tadros for proofreading it.

---

## Nomenclature

---

$A_f$  flame front area ( $m^2$ )  
 $A_v$  projected vent area ( $m^2$ )  
 $K_{tot}$  vent static pressure drop coefficient (dim.)  
 $L$  chiller plantroom dimension  $L_1 < L_2$  (m)  
 $v$  gas velocities relative to flame front (m/s)  
 $\rho$  gas density ( $kg/m^3$ )  
 $\Delta P$  peak overpressure (Pa)

## Subscripts

m maximum  
p products  
r reactants

---

## References

---

- ANSI/ASHRAE standard-34, 2001, Designation and Safety Classification of Refrigerants, American Society of Heating, Refrigerating and Air-Conditioning Engineers, Inc., Atlanta.
- ANSI/ASHRAE standard-15, 2001, Safety Standard for Refrigeration Systems, American Society of Heating, Refrigerating and Air-Conditioning Engineers, Inc., Atlanta.
- AS 1596:2002, The storage and handling of LP Gas, Standards Australia, Sydney, 150 p.
- AS 1677.2:1998, Refrigerating systems, Part2: Safety requirements for fixed applications, Standards Australia, Sydney, 60 p.
- AS 1940:1993, The storage and handling of flammable and combustible liquids, Standards Australia, Sydney, 109 p.
- AS 2381:1999, Electrical equipment for explosive atmospheres-selection, installation and maintenance, Standards Australia, Sydney, 89 p.
- AS 61779:2000, Electrical apparatus for the detection and measurement of flammable gases, Parts 1,4 and 6, Standards Australia, Sydney, 50 p.
- Bjerketvedt, D., Bakke, J.R. and van Wingerden, K. 1997, Gas explosion handbook, Journal of Hazardous Materials, vol. 52, p. 1-150.
- Glassman, I., 1987, Combustion, 2nd ed., Academic Press, Orlando, 501 p.
- Harris, R.J., 1983, The Investigation and Control of Gas Explosions in Buildings and Heating Plant, British Gas Corporation, E & FN Spon, London, 194 p.
- IPCC, 2001, Climate Change 2001: The Scientific Basis, ed. Houghton, J. T. et al. , Cambridge University Press, 944 p.
- ISO 817:2005, Refrigerants – Designation and safety classification, ANSI, New York.
- Jabbour, T., 2004, Flammability refrigerant classification based on the burning velocity, Executive Summary PhD Thesis, Ecoles de Mines de Paris, 30 p.
- Johnson, C. E. and Derwent, R. G., 1996, Relative Radiative Forcing Consequences of Global Emissions of Hydrocarbons, Carbon Monoxide and NOx from Human Activities Estimated with a Zonally-Averaged Two-Dimensional Model, Climatic Change, vol. 34, pp. 439-462.
- Maclaine-cross, I. L. 2002, Replacement Refrigerants for Centrifugal Chillers, AIRAH Natural Refrigerants Conference, Melbourne, Australia, 18th April, 8 p.

Maclaine-cross, I.L., 2004, Usage and risk of hydrocarbon refrigerants in motor cars for Australia and the United States, *International Journal of Refrigeration*, vol. 27, pp. 339-345.

NFPA 68, 2002, Guide for Venting of Deflagrations, National Fire Protection Association, Quincy MA, 63 p.

Runes, E., 1972, Explosion Venting, *Journal of Loss Prevention*, Vol. 6, pp. 63-67.

Swift, I. and Epstein, M., 1987, Performance of Low Pressure Explosion Vents, *Plant/Operations Progress*, vol. 6, no.2, April, pp. 98-105.

Tadros, A., Clark, J.W., Leonardi, E. and Maclaine-cross, I.L., 2004, Precautions and Procedures for Hydrocarbon Chiller Plantrooms, *IIR Refrigeration Science and Technology Proceedings*, 6th IIR – Gustav Lorentzen Conference, Glasgow UK, 29th August-1st September, 7 p.

Tadros, A., Clark, J.W., Maclaine-cross, I.L. and Leonardi, E., 2006a, Replacing Fluorocarbons with Hydrocarbon Mixtures in Centrifugal Water Chillers, *IIR Refrigeration Science and Technology Proceedings*, 7th IIR Gustav Lorentzen Conference on Natural Working Fluids, Trondheim, Norway, May 28-31, 8 p.

Tadros, A., Leonardi, E., Maclaine-cross, I.L. and Clark, J.W., 2006b, Hydrocarbon Refrigerant Heat Transfer Coefficients in Centrifugal Water Chillers, *13th International Heat Transfer Conference*, Sydney - Australia, 13-18 August.

Tadros, A., 2008, Performance and Safety of Centrifugal Chillers Using Hydrocarbons, PhD thesis draft, School of Mechanical and Manufacturing Engineering, The University of New South Wales, Sydney.

---

### III. Assessment of Natural Refrigerants in Different Applications

---

# Opportunities for the Application of Natural Refrigerants

DR. DANIEL COLBOURNE, Re-phridge, UK

---

## Introduction

---

The terms “natural refrigerants” may be considered as slightly emotive by some, but nevertheless, it is a term that is commonly used. For example, it is used within the title of one of the most successful ongoing scientific conferences of the International Institute of Refrigeration, “the Gustav Lorentzen Conference on Natural Working Fluids”. Further, the term “natural” also implies the origin of the fluids, themselves, i.e., they occur in nature as a result of geological and/or biological processes, unlike fluorinated refrigerants which are synthesised chemicals. The environmentalist’s favouring of these naturally occurring fluids largely due to their well known and typically neutral interaction with the environment, as opposed to new synthetic molecules whose impact on the environment is typically undesirable, or indeed unknown. Due to their occurrence, natural refrigerants were adopted at the advent of vapour-compression and sorption refrigeration in the mid-1800s, and as a result, there is extensive accumulated knowledge and experience with them.

This article will provide an indication of the types of situations where certain natural refrigerant can be employed. The refrigerants that are addressed are limited to the following:

- Ammonia ( $\text{NH}_3$ , R-717)
- Carbon dioxide ( $\text{CO}_2$ , R-744)
- Hydrocarbons; e.g., iso-butane ( $\text{C}_4\text{H}_{12}$ , R-600a), propane ( $\text{C}_3\text{H}_8$ , R-290), propylene ( $\text{C}_3\text{H}_6$ , R-1270), and mixtures thereof

Whilst there are a number of other viable natural refrigerants, such as water, air, helium, nitrogen, et cetera, and a variety of types of system that they can be used in (sorption, gas cycles, Stirling machines, and so on), only the three main refrigerant types and their use in compression systems will be addressed here. These refrigerants may be used in single- or multi-stage vapour compression cycles, within cascade cycles (where two or more separate systems are linked through exchanging heat between ones evap-

erator and the others condenser), or within a secondary or indirect system, which employs a pumped heat transferring medium.

---

## Implications of refrigerant choice

---

Refrigerant choice is normally a function of several factors, some of which are property-based and some of which are influenced by market issues.

The property-based factors include:

- Global warming potential
- Ozone depleting potential
- Flammability
- Toxicity
- Chemical reactivity and material compatibility
- Potential efficiency (thermo-physical properties)

The market issues are:

- Refrigerant cost (per kg or per system charge)
- Cost of components
- Access to refrigerant
- Availability of suitable components, oils, service equipment
- Adequate expertise and training

The basic characteristics of a number of refrigerants are qualitatively compared against fluorocarbons in Table 1. The implications of the various characteristics are briefly discussed below.

### GWP

The Global Warming Potential is the radiative forcing of the fluid under consideration, relative to that of carbon dioxide, and in this case, taken over a 100-year time horizon. The values are taken from that published in the Fourth Assessment Report of the Intergovernmental Panel on Climate Change (IPCC AR4), published in 2007. For the mixture refrigerants, the GWP was calculated according to their mass composition. From an environmental perspective, it is preferable to use a refrigerant with as low a GWP as possible.

### Flammability

The flammability is stated according to the refrigerant safety classification within ISO 817: 2005<sup>1</sup>. If a flammable refrigerant is employed, special safety requirements must be adhered to ensure that fire and explosions do not occur.

---

<sup>1</sup> ISO 817: 2005 Refrigerants – Designation system

### Toxicity

The toxicity is stated according to the refrigerant safety classification within ISO 817: 2005. If a refrigerant with higher toxicity is employed, additional safety features are normally required, as are specified in the relevant safety standards.

### Normal boiling point

The normal boiling point is the temperature at which the refrigerant boils under standard atmospheric pressure (1.01 bar). For most systems it is preferable to select a refrigerant that will evaporate at a temperature above its normal boiling point so that the system will be operating under a positive pressure. Refrigerants that have two numbers listed are refrigerant mixtures, where a temperature glide occurs during isobaric steady flow evaporation and condensation. Generally, a larger temperature glide implies more complicated refrigerant handling and lower efficiency.

### Critical temperature

The temperature at the critical point is the state at which the fluid can no longer be distinguished between liquid and vapour. It is normally preferable to operate a system so that its condensing temperature is at least 10 – 20 K below the critical temperature. Thus, for hotter climates, a higher critical temperature is preferred. An exception is the use of R-744, which has a low critical temperature, but to overcome this, alternative circuit designs have been developed to help maintain good efficiency.

### Potential efficiency

Approximate ranges of the “potential efficiency” relative to that expected with R-22 have been provided. The relative efficiency of different refrigerants is a complex matter and is subject to a large number of influencing parameters. The values presented represent an anticipated range based on the thermophysical of the different refrigerants, modelling exercises assuming similar system designs and experimental results reported in the literature.

### System cost

Approximate ranges of the system cost relative to that expected with R-22 have been provided. As with system efficiency, this is also a variable quantity and is a function of many different factors. In particular, if a refrigerant necessitates an indirect system, for example, the additional cost is likely to be significant. More common factors may include more expansive refrigerant, special circuit components and safety features.

Type	Refrigerant	GWP	Flammability	Toxicity	Normal boiling point	Critical temperature	Potential Efficiency (rel. to R-22)	System cost (rel. to R-22)
HCFC	R-22*	1810	None	Low	-41°C	96°C	100%	100%
	R-407C	1770	None	Low	-44/-37°C	86°C	75 – 90%	100 – 110%
HFC	R-404A	3920	None	Low	-44°C	72°C	85 – 100%	100 – 105%
	R-410A	2140	None	Low	-52°C	71°C	90 – 105%	100 – 110%
	R-417A	2350	None	Low	-38/-33°C	87°C	90 – 105%	100 – 105%
HFC-based "drop-in"	R-427A	2140	None	Low	-43/-36°C	85°C	85 – 105%	100 – 105%
	R-434A	3280	None	Low	-45/-42°C	76°C	90 – 105%	100 – 105%
Natural refrigerant	R-717 (ammonia)	0	Low	High	-33°C	132°C	100 – 125%	110 – 140%
	R-744 (carbon dioxide)	1	None	Low	-78°C	31°C	85 – 110%	100 – 130%
	R-290 (propane)	< 3	High	Low	-42°C	97°C	95 – 115%	100 – 115%
	R-290/R-600a mix	< 3	High	Low	~ -30°C	~ 115°C	90 – 105%	100 – 110%
	R-1270 (propene)	< 3	High	Low	-48°C	91°C	95 – 120%	100 – 115%

Table 1: General characteristics of selected refrigerants

\* R-22 is the only refrigerant with an Ozone Depletion Potential (ODP)

## Hindrances to the application of natural refrigerants

There are three main factors affecting the application of any refrigerant: these are cost, safety and technological status. In principle, virtually any refrigerant can be used for any application; the key is to ensure that it can be applied using an acceptable budget and that it will not pose significant hazards to workers or to members of the public. Typically, the difficulties in adopting R-717 and HCs are related to safety issues, whilst with R-744 they are pressure-related matters. Generally, such considerations are handled through the use of safety standards, such as the European Standard on environmental and safety requirements for refrigeration systems (EN 378<sup>2</sup>) or equivalent national or international standards.

In terms of economic factors associated with adopting alternative technologies, it is important to recognise that the cost of systems using technology that deviates from the standard mass-produced products, generally attract higher initial costs. This is often due to the scale of economies, for example, the “purchasing power” of the organisations involved. It is also observed that many companies that develop more environmentally-friendly products attach a “green” premium, thereby artificially inflating the selling price of their goods. Other real costs include in-house development of new system designs (although this is normally an accepted cost regardless of refrigerant type), and training for both production staff and field or service and maintenance technicians. Nevertheless, a useful example is the case of domestic refrigerators transition from R-12 and R-134a to a HC; R-600a (iso-butane). There are now over 200 million domestic refrigerators on the market with no premium attached to them, when compared to R-134a units, despite initial concerns of increased production expenditure.

### R-717 (Ammonia, NH<sub>3</sub>)

The main consideration with using R-717 is its safety, since it is “higher toxicity” and “lower flammability” corresponding to ISO 817 Group B2 classification. The B2 classification for R-717 means that it is effectively prohibited from use inside occupied spaces (except for small sorption machines), but it can be accommodated in unoccupied spaces or outside. Thus R-717 can be used where indirect (or secondary) systems can be economically employed. In addition, consideration needs to be given to ventilation requirements and the consequences of a release, where it may come into contact with members of the public. In addition, due to its chemistry, the use of copper pipework and system components is not recommended with R-717, and therefore steel must be used which can often present a cost detriment for smaller capacity systems.

<sup>2</sup> EN 378: 2000 Refrigerating systems and heat pumps – Safety and environmental requirements

## Hydrocarbons (HC)

R-600a (iso-butane), R-290 (propane), R-1270 (propylene), and mixtures thereof, have “lower toxicity” and “higher flammability”, giving them a Group A3 classification in ISO 817. This introduces stricter safety requirements, in terms of the quantities permitted in certain locations – specifically safety standards such as EN 378 tend to limit quantities to up to 1 – 2,5 kg within occupied spaces. Because of these charge size limitations for systems in occupied spaces, it is beneficial to design the system to maintain a small refrigerant charge (for a specific capacity), i.e., low specific charge in terms of kg/kW. However, it may not be practical to use certain systems in particular circumstances where the refrigerant charge is above the permitted limits, and in these cases indirect or secondary systems can be employed, which, for smaller capacities can escalate capital costs. Regarding the refrigerating system, using HCs is essentially identical to using R-22. For example, the same compressor displacement, pipe sizes, heat exchanger dimensions and oil selection may be used (although as with any fluids whose thermophysical properties differ, opportunities for optimisation should be exploited). The only significant difference in the design of equipment is the avoidance of potential sources of ignition on the equipment, for example, switches, thermostats, etc., that are capable of producing a spark.

### R-744 (Carbon dioxide, CO<sub>2</sub>)

In terms of its fundamental safety properties, R-744 has “lower toxicity” and “no flammability”, giving it a Group A1 classification in ISO 817. This means that its use is permitted in almost any situation, without restriction of refrigerant charge sizes. However, the fact that R-744 has a very high working pressure does introduce some technical problems. Specifically, there is an increase in the pressure rating of components and assemblies by a factor of 5 – 10 times above that of conventional refrigerants. As a result, the choice of materials, component thickness, jointing methods and mechanical operation of certain components (such as compressors) are affected. Current developments have managed to overcome most of these issues for a wide variety of equipment sectors, although the cost implications of handling these high-pressure aspects mean that in some cases, the costs of adopting R-744 are presently prohibitive. In particular, this relates to equipment that has a large internal volume. Another feature of R-744 that introduces technological challenges is the low critical point, which requires a variant of the conventional vapour compression cycle to be incorporated into the RAC equipment.

---

## Guidance on applications

---

Due to the characteristics of these natural refrigerants, it is not always ideal to marry one or all of them with particular equipment or applications. However, it is useful to identify the most viable equipment and applications for which the different natural refrigerants can be employed. Thus, Table 2 and Table 3 provide a general indication as to which natural refrigerants may be applied according to the existing situation. The information is categorised as follows.

### Application

The most common types of applications that hitherto have employed HCFCs have been identified. A number of other categories exist, such as industrial refrigeration, industrial heat pumps, and mobile air conditioning systems, and so on, which are either bespoke systems and therefore vary considerably, or simply do not employ HCFCs as the main refrigerants. For these systems, they should be addressed on a case-by-case basis.

### Equipment type

The equipment type identifies the particular type of machine that may be used for a given application.

### System type

The types of system relate to the location of the refrigerant, which largely dictates when certain refrigerants can be used. The types are defined as follows:

- Integral – where the entire system is integrated into a single unit; suited to HCs and R-744
- Remote – where part of the system, normally the condenser and compressor, is located external to the unit; suited to R-744 and small-charge of HCs
- Distributed – where a central system pumps refrigerant to several different evaporators; suited mainly to R-744, or use of HCs or R-717 within an indirect system
- Indirect – where a water/secondary coolant is pumped to one or many units from a central chiller; suited to R-744, HCs or R717

### Typical fluorocarbon

This indicates the most common HCFC or HFC used in this type of equipment.

### Viable natural refrigerants

The most suitable natural refrigerant options are listed. The viability is judged according to the discussion in the previous sections, i.e., mainly according to safety and cost



implications. The choice of natural refrigerant is further broken down into sub-categories, depending upon the situation:

- New refrigerant (retrofit/retrofill); only where the existing refrigerant is removed and replaced with a new one, incurring limited changes to the equipment
- New system (circuit and components); where the old refrigerating circuit and components are removed, and a new one with a new refrigerant put in its place; for example, changing a chiller over
- New installation (circuit, components and layout); where the old system and all associated equipment, such as water pipes, ducts, and so on, is removed; for example, changing from a direct expansion supermarket system to an indirect system

Refrigerants that could be used for the application, but require a change of system, are listed in square parentheses, for example, where the use of HCs or R-717 require the direct expansion system to be replaced with an indirect (secondary) system.

Application	Equipment type	System type	Typical Fluorocarbon	Viable natural refrigerants		
				New refrigerant (retrofit/retrofill)	New system (circuit and components)	New installation (circuit, components and layout)
Retail refrigeration	Water coolers	Integral	R134a, R12	HC mix	R600a, R290	R600a, R290
	Chiller cabinets	Integral	R134a, R404A, R502	HC mix, R290	R600a, R290, R744	R600a, R290, R744
	Chiller cabinets	Remote	R22, R404A, R502		R290, R744	R290, R744
	Chiller cabinets	Distributed	R22, R404A, R502			R744, [R290, R1270, R717]*
	Chiller cabinets	Indirect	R22, R404A	R290, R1270	R290, R1270, R717	R290, R1270, R744, R717
	Freezer cabinets	Integral	R22, R404A, R502	R290, R1270	R290, R1270	R290, R1270
	Freezer cabinets	Remote	R22, R404A, R502		R290, R744	R290, R744
	Freezer cabinets	Distributed	R22, R404A, R502			R744, [R290, R1270, R717]*
	Freezer cabinets	Indirect	R22, R404A	R290, R1270	R290, R1270, R717	R290, R1270, R744, R717
	Freezer cabinets	Integral	R22, R404A, R502	R290, R1270	R290, R1270, R744	R290, R1270, R744
Cold storage and food processing	Storage cabinets	Integral	R22, R404A, R502		R290, R1270, R744	R290, R1270, R744
	Coldstores	Remote	R22, R404A, R502			R744, [R290, R1270, R717]*
	Coldstores	Distributed	R22, R404A, R502			R290, R1270, R744, R717
	Coldstores	Indirect	R22, R404A	R290, R1270	R290, R1270	R290, R1270, R744, R717
	Process cooling/freezing	Remote	R22, R404A, R502			R290, R1270, R744
	Process cooling/freezing	Distributed	R22, R404A, R502			R290, R1270, R744
	Process cooling/freezing	Indirect	R22, R404A	R290, R1270	R290, R1270	R744, [R290, R1270, R717]*
Transport refrigeration	Process cooling/freezing	Indirect	R22, R404A, R502			R290, R1270, R744, R717
	Road transport trucks	Integral	R22, R404A, R502	R290, R1270	R290, R1270	R290, R1270, R744, R717
	Refrigerated railcars	Integral	R22, R404A, R502	R290, R1270	R290, R1270, R744	R290, R1270, R744
	Refrigerated railcars	Integral	R22, R404A, R502		R744	R744
	Marine refrigeration	Integral	R22, R404A, R502		R744	R744

\* Use of HCs and R-717 require the direct expansion system to be replaced with an indirect (secondary) system

Table 2: Application areas for natural refrigerants – Refrigeration

# Application of Ammonia Heat Pump Systems for Heating and Cooling in Non-Residential Buildings

PROF. DR. JØRN STENE, SINTEF Energy Research, Norway

## Introduction

Utilization of naturally occurring and ecologically safe substances as working fluids in heat pumps represent an environmental friendly and long-term solution to the HCFCs and HFCs. The most important natural working fluids include ammonia, hydrocarbons and carbon dioxide. This article discusses the main characteristics of ammonia heat pumps, and describes the market development for this energy efficient technology in Norway.

Ammonia (NH<sub>3</sub>, R717) is the most well proven alternative among the natural working fluids since it has been extensively used in industrial refrigerating plants for more than a century. However, ammonia is a toxic fluid, and the strict standards and regulations for the construction and operation of ammonia refrigerating and heat pump systems have hampered its use in many countries. In Norway, ammonia has become a commonly used working fluid for medium- and large-scale heat pump systems (>200 kW) due to the favourable environmental and thermophysical properties of the fluid.

## Characteristics of ammonia heat pump systems

Since hydrous ammonia corrodes copper and zinc, structural steel and aluminium are the most commonly used materials in ammonia heat pump systems. Ammonia has very high specific enthalpy of evaporation [kJ/kg] compared to R407C and R134a, which are the most commonly used working fluids in Norwegian non-residential heat pump systems. This results in a low mass flow rate, which reduces the required dimensions of pipelines and valves by typically 30 to 50% when assuming the same drop in saturation temperature. Another advantage is, despite the low vapour density of ammonia, that the volumetric heating capacity [kJ/m<sup>3</sup>] is relatively high. At -5°C/50°C evaporation/condensing temperature, the required compressor volume for R407C and R134a heat pump systems will be roughly 30% and 90% higher than that of an

Category	Application	System type	Typical Fluorocarbon	Viable natural refrigerants		
				New refrigerant (retrofit/retrofill)	New system (circuit and components)	New installation (circuit and components and layout)
Domestic air conditioners, dehumidifiers and heat pumps	Portable units	Integral	R22, R407C, R410A	R290, R1270	R290, R1270	R290, R1270
	Window units	Integral	R22, R407C, R410A	R290, R1270	R290, R1270	R290, R1270
	Through-wall units	Integral	R22, R407C, R410A	R290, R1270	R290, R1270	R290, R1270
	Split units	Remote	R22, R407C, R410A	R290, R1270	R290, R1270, R744	R290, R1270, R744
	Hot water heating	Integral	R22, R407C, R410A	R290, R1270	R290, R1270, R744	R290, R1270, R744
Commercial air conditioning and heat pumps	Central heating	Integral/indirect	R22, R407C, R410A	R290, R1270	R290, R1270, R744	R290, R1270, R744
	Split units	Remote	R22, R407C, R410A	R290, R1270	R290, R1270, R744	R290, R1270, R744
	Multi-split/VRV	Distributed	R22, R407C, R410A			R744, [R290, R1270, R717]*
	Packaged ducted	Remote	R22, R407C, R410A			R744
	Central packaged	Remote	R22, R407C, R410A			R744
	Positive displ't chillers	Integral/indirect	R134a, R22, R407C	R290, R1270	R290, R1270, R717	R290, R1270, R717
	Centrifugal chillers	Integral/indirect	R123, R134a			[R290, R1270, R717]*
	Hot water heating	Integral	R22, R407C, R410A	R290, R1270	R290, R1270, R744	R290, R1270, R744
	Central heating	Integral/indirect	R22, R407C, R410A	R290, R1270	R290, R1270, R744	R290, R1270, R744
	* Use of HCs and R-717 require the direct expansion system to be replaced with an indirect (secondary) system					

Table 3: Application areas for natural refrigerants – Air conditioning and heat pumps

ammonia system, respectively. Ammonia heat pumps achieve higher energy efficiency than R407C and R134a systems at identical operating conditions. For a theoretical single-stage heat pump cycle operating with  $-5^{\circ}\text{C}/50^{\circ}\text{C}$  evaporation/condensing temperature, isentropic/adiabatic compression and no suction superheat or sub-cooling, the heating COP (that is the ratio of heat output to compressor power) of the ammonia cycle is about 7% and 11% higher than that of the R134a and R407C cycles. The difference will be even larger in real systems due to the favourable thermophysical properties of ammonia. This includes steeper saturation temperature curve, superior heat transfer properties and high compressor efficiencies. At low pressure ratios, ammonia compressors are considerably better than HFC compressors, whereas relatively similar compressor efficiencies are attained at high pressure ratios [1/].

The discharge gas temperature of ammonia is considerably higher than that of the HFCs. In order to ensure reliable and energy efficient operation of the compressor, different measures are of current interest including low-temperature heat distribution system, high-temperature heat source, larger surfaces for the evaporator and condenser, flooded evaporator operation, short and well insulated suction lines, water-cooled cylinder heads for reciprocating compressors, two-stage plant design at compression ratios above 5 to 6, and desuperheater for hot water production.

Another disadvantage with ammonia heat pumps is the limited supply water temperature of approx.  $48^{\circ}\text{C}$  from the condenser when using standard 25 bar equipment [3/]. If the heat pump is supplying heat to a high-temperature heat distribution hydronic system (e.g.  $80/60^{\circ}\text{C}$  or  $70/50^{\circ}\text{C}$  at design outdoor temperature, DOT), the return temperature during longer periods may be even higher than the maximum supply temperature from the condenser. This will reduce the annual heat supply from the heat pump and with that the Seasonal Performance Factor (SPF) of the system. If 25 bar ammonia heat pumps are to be used for heating and cooling of buildings, it is of crucial importance that the hydronic heat distribution is designed for a relatively low return temperature. This can be achieved by serial connection of radiators and heating batteries in the ventilation system combined with volume flow control of the primary water circuit.

By using two-stage system design with 40 bar compressor and condenser in the second stage, the maximum supply water temperature is increased to about  $68^{\circ}\text{C}$ . Two-stage operation will boost the COP by as much as 20 to 40%, but the costs are 80 to 100% higher than that of single-stage systems. The additional costs for a single-stage 40 bar system are about 15 to 25% [3/].

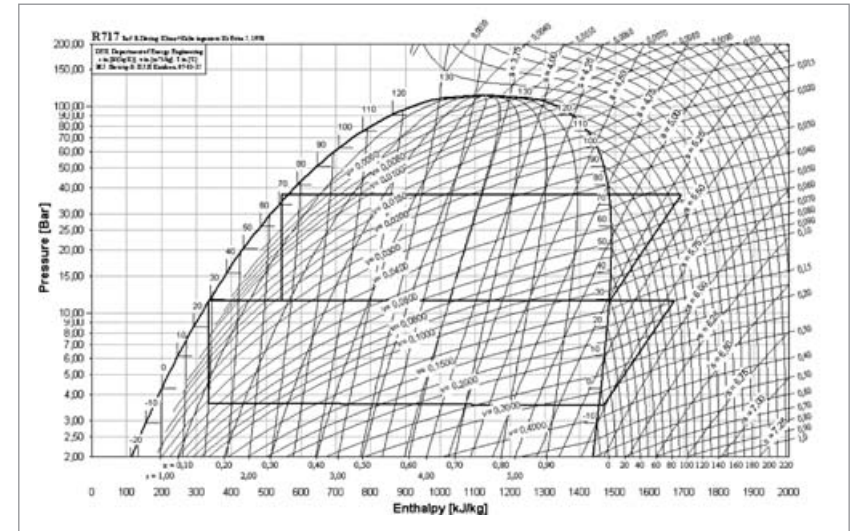

Figure 1: Example of an energy efficiency two-stage ammonia heat pump cycle at  $-5^{\circ}\text{C}$  and  $75^{\circ}\text{C}$  evaporation and condensing temperature, respectively. The isentropic compressor efficiency is 0.75 /5/

Due to the considerable variations in the heating/cooling loads and the temperature requirements in the heat distribution system in buildings, ammonia heat pump systems should be designed for high energy efficiency at part load operation and varying condensing temperatures. This implies the application of several heat pump units equipped with reciprocating compressors or inverter controlled screw-compressors with variable volume ratio. Conventional screw compressors are unsuitable due to low energy efficiency at part load operation and varying temperature lift. Centrifugal compressors are neither of current interest in ammonia systems, since the low molar mass ( $17.03 \text{ kg/kmol}$ ) would require multiple-stage compression, about 6 times as many as for R134a.



Figure 2: Examples of open reciprocating and screw compressors for ammonia

## Toxic fluid – Safety measures

The main arguments against the installation of ammonia heat pumps in densely populated areas are related to the consequences of possible uncontrolled ammonia emissions. Ammonia is a toxic fluid with a pungent odour. The pungent odour may cause panic, but it also eases the detection of leakages. The Immediate Danger for Life and Health (IDLH) value for ammonia is 500 ppm, and the lowest fatal concentration reported is 5,000 ppm /1/. Since the Lower Explosion Limit and auto-ignition temperature are as high as 15% by volume and 651°C, respectively, ammonia is classified as toxic but moderately flammable in most refrigeration standards. In order to ensure maximum safety in ammonia heat pump plants, a number of mandatory/optional safety measures must/may be implemented:

- Low-charge ammonia units
- Gas-tight and fire-proof machinery room with self-closing doors room located inside the building or in a container on the roof of the building
- Leak detectors activating visual/audible alarms etc.
- Fail-safe emergency ventilation system – constant under-pressure around the ammonia units
- Ammonia scrubber for efficient absorption of ammonia vapour in the exhaust ventilation air

## Market – Installation examples

Several hundred ammonia heat pumps have been installed in Norway since the early 1990s. Most installations are in larger buildings (200 kW to 2 MW) and in district heating and cooling systems (700 kW to 8 MW). There are also a considerable number of ammonia heat pumps in ice rink systems, industry (supercharge units, drying units) and fish farming plants. About 25 of the ammonia heat pump installations are two-stage 40 bar systems. The Directorate for Public Construction and Property in Norway (Statsbygg) prefers to install ammonia heat pumps, since ammonia is an environmentally friendly working fluid with excellent thermophysical properties.

### Ammonia heat pump in a research centre (1994)

A 900 kW ammonia heat pump system for space heating, space cooling and hot water heating was installed in 1994 at the Statoil Research Centre in Trondheim. The heating and cooling demands at design conditions for the 28,000 m<sup>2</sup> building are 1.5 and 1.35 MW, respectively. Sea water from 60 meters depth is used as heat source.

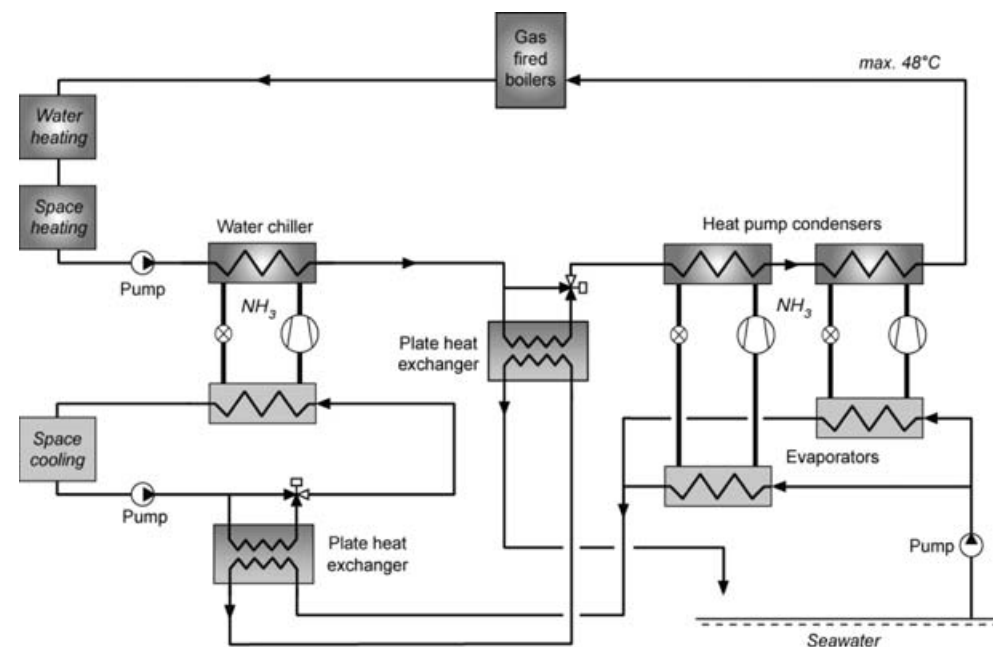

Figure 3: Principle scheme of the 900 kW ammonia heat pump system at the Statoil Research Centre

The heat pump comprises two identical single-stage heat pump units equipped with two 25 bar six cylinder reciprocating compressors, a titanium plate heat exchanger as evaporator and a two-pass shell-and-tube condenser. The ammonia charge is about 0.2 kg per kW heating capacity. Auxiliary heating and back-up is provided by gas-fired boilers. Since the machinery room is located inside the building on the ground floor, the room is gas-tight with self-closing doors and a two-stage ventilation system maintains constant under-pressure around the units. Other safety measures include leak detectors, an alarm system and a tailor-made ammonia scrubber. The scrubber is installed in the ventilation duct, and reduces the ammonia concentration in the exhaust air to maximum 50 ppm in case of a major leakage.

Although the COP of the heat pump units is about 4.5 at design conditions, the SPF of the bivalent heating system is less than 2.5. The main reason for the poor performance is that the gas-fired boilers covers the entire heating load at low ambient temperatures, since the return temperature in the heat distribution system at these operating conditions is higher than the maximum supply temperature of 48°C from heat pump units. As a consequence, the heat pump system covers less than 80% of the total annual heating demand of the building. This problem could have been resolved by using a two-stage 40 bar heat pump system – or even better, designing the hydronic heating system for a lower return temperature.

### Ammonia heat pump in a district heating and cooling system (1998)

Norway's largest ammonia chiller and heat pump system (CHPS) was installed at Oslo Airport Gardermoen in 1998 [2]. The maximum heating and cooling capacity of the CHPS is 7.5 MW and 6.0 MW, respectively, and the system utilizes the vast groundwater aquifer in the area as a thermal energy storage (ATES). The ATES system consists of 9 cold wells and 9 warm wells. During winter mode, groundwater from the warm wells are used as heat source for the CHPS, and the return water is supplied to the cold wells. During summer mode, the ground water from the cold wells is used for pre-cooling before it is returned to the warm wells.

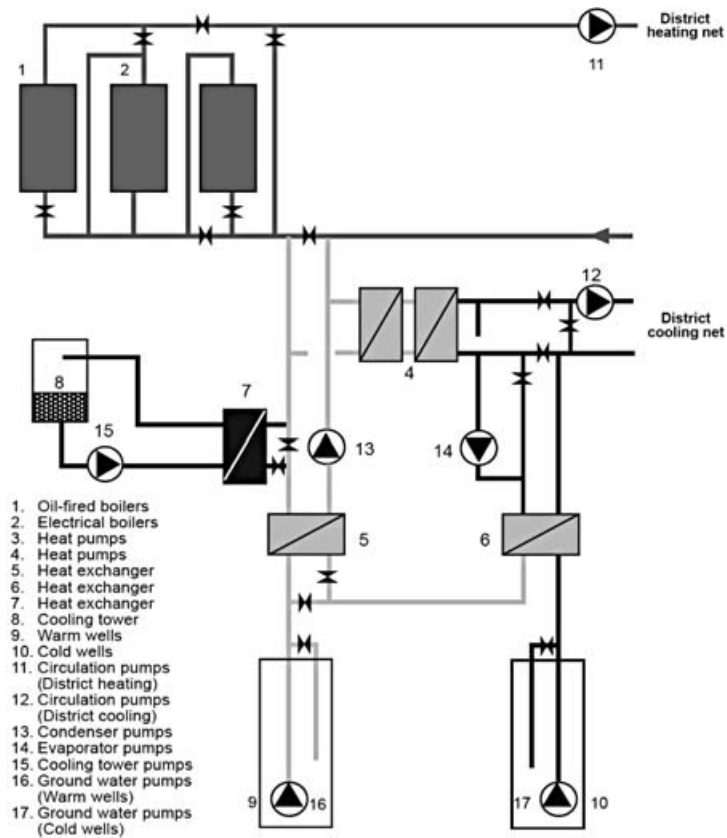

Figure 4: Principle scheme of the 7.5 MW ammonia heat pump system at Oslo Airport, Gardermoen

The two single-stage ammonia heat pump units are equipped with a shell-and-tube evaporator and condenser, although plate heat exchangers could have substantially reduced the ammonia charge. Seven 8- and 16-cylinder reciprocating compressors are used in order to achieve high efficiency at part load operation. The measured overall SPF for the CHPS in heating and cooling mode is about 5.5. The total ammonia charge of the heat pump system is 2,500 kg. Due to the toxicity of the fluid and the considerable charge, the gas-tight energy central is located about 1 km from the terminal building and equipped with leak detectors, a fail-safe emergency ventilation system and a sprinkler system.

### Ammonia heat pump system in a hospital (2008)

The new district general hospital in Akershus (SiA) is currently under construction. The buildings will have a total floor area of about 160.000 m<sup>2</sup>, and the hospital will be fully operative from October 2008. A combined ammonia chiller and heat pump system (CHPS) will supply heating and cooling to the buildings, and the system will be connected to the largest underground thermal energy storage (UTES) in Europe, comprising 350 two hundred metres deep boreholes in bedrock [4]. The CHPS from York Refrigeration will comprise three single-stage screw-compressor units with slide valve control and variable volume ratio, and one single-stage unit with two large reciprocating compressors. Each unit has a maximum cooling capacity of roughly 2 MW. The CHPS is designed according to a maximum cooling load of about 7.7 MW. The heating capacity of the CHPS at design outdoor temperature (DOT) is about 5 MW. The units will be supplying condenser heat to a low-temperature circuit at a maximum supply temperature of 52°C (space heating, heating of swimming pools etc.), and desuperheat to a high-temperature circuit at a maximum supply temperature of 75°C (hot water heating). The heat pump will cover about 80% of the total annual heating demand of the hospital, and oil-fired boilers will be used as peak load.

---

## References

---

/1/ Stene, J., 1998: IEA Annex 22: Final Report – Guidelines for Design and Operation of Com-pression Heat Pump, Air Conditioning and Refrigerating Systems with Natural Working Fluids. IEA HPP Report No. HPP-AN22-4. ISBN 90-73741-31-9.

/2/ Eggen, G., Vangsnes, G., 2005 Heat pump for district cooling and heating at Oslo, Airport Gardermoen. Proc. from the 8th IEA Heat Pump Conference, May 2005. Las Vegas, USA.

/3/ Information from York Refrigeration, Norway.

/4/ Information from Sweco Grøner AS, Norway.

/5/ CoolPack, 2000. Simulation programme for heat pumps and refrigerating plants developed at the Technical University of Denmark (freeware).

<http://www.et.web.mek.dtu.dk/Coolpack/UK/>

# Overview and Outlook for the Application of CO<sub>2</sub> in Heat Pumps

PROF. DR. RENÉ RIEBERER, Graz University of Technology,  
Institute of Thermal Engineering, Austria

PROF. DR. JØRN STENE and PETTER NEKSÅ, SINTEF Energy Research, Norway

---

## Introduction

---

Until recently, R-22 had been the standard refrigerant for use in heat pumps. This was because of its desirable thermodynamic properties that offered high efficiency in heating mode, whilst maintaining compactness of equipment. The phasing-out of HCFCs forced investigations into alternative refrigerants for heat pumps. Candidates are the HFCs (R407C, R410A, etc.) with a high Global Warming Potential (GWP) and the “natural” working fluids ammonia (R717), propane (R290) and CO<sub>2</sub> (R744). CO<sub>2</sub> has the advantage that it is a safety refrigerant with negligible (no) GWP.

Owing to the low critical temperature of CO<sub>2</sub> (31.1°C), heat rejection in a CO<sub>2</sub> heat pump normally takes place at a supercritical pressure. Sub-critical operation, as known from conventional heat pump systems, is only possible if the temperature level of the heat sink is rather low (about 25°C or lower). Higher heat sink temperatures lead to trans-critical operation, where the CO<sub>2</sub> is cooled down during heat rejection in a “gas” cooler. The trans-critical CO<sub>2</sub> heat pump process is well suited for applications with a large temperature glide on the heat sink side, due to the good temperature fit between the high-pressure CO<sub>2</sub> and the heat sink.

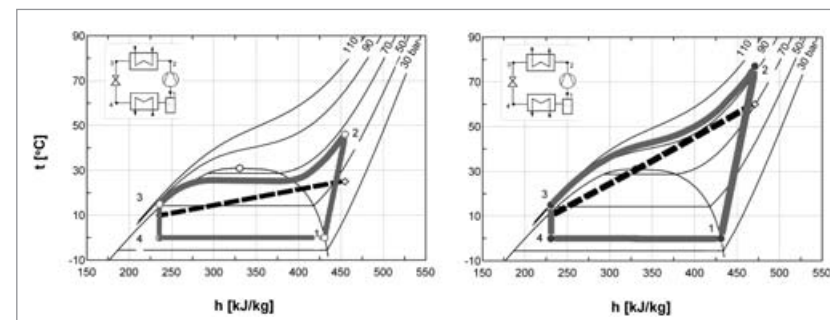

Figure 1: Examples of a sub-critical (left) and a trans-critical CO<sub>2</sub> heat pump cycle (right)

Figure 1 shows simplified sub-critical and trans-critical CO<sub>2</sub> heat pump cycles in temperature/-enthalpy-diagrams. The heat sinks are in counter-flow to the refrigerant (CO<sub>2</sub>); the temperature profiles are indicated by the broken lines.

The coefficient of performance (COP) of a CO<sub>2</sub> heat pump depends strongly on the supercritical (high-side) pressure and the CO<sub>2</sub> temperature after heat rejection. The COP of a heat pump is defined as the ratio of the energy output, in principle represented by the enthalpy difference during heat rejection, to the power input of the compressor, in principle represented by the enthalpy difference during compression. For a certain heating capacity, the highest COP is – evidently – obtained at the lowest possible power consumption. The power consumption of the compressor increases more or less linearly with the high-side pressure. If the heat sink has a large temperature glide, the obtainable enthalpy difference during heat rejection drops at low high-side pressures due to a temperature pinch ( $\Delta T_{\min}$ ) inside the gas cooler (Figure 2, left). This results in a reduced COP compared to operation at the optimum high-side pressure (Figure 2, right). However, at a higher pressure than the optimum, the COP drops again, because the CO<sub>2</sub> temperature after heat rejection and the enthalpy difference during heat rejection, respectively, are limited by the heat sink inlet temperature, while an increasing high-side pressure leads in any case to an increased power consumption of the compressor. By utilizing an internal heat exchanger, the influence of the high-side pressure on the performance can be significantly reduced (compare Rieberer, 1998). In general, the COP of a CO<sub>2</sub> heat pump is determined by the CO<sub>2</sub> outlet temperature after heat rejection, and the COP is therefore decreasing with increasing heat sink inlet temperature. This circumstance is new for heat pumps because in conventional – sub-critically operating – heat pumps, the COP is in principle limited by the outlet temperature of the heat sink.

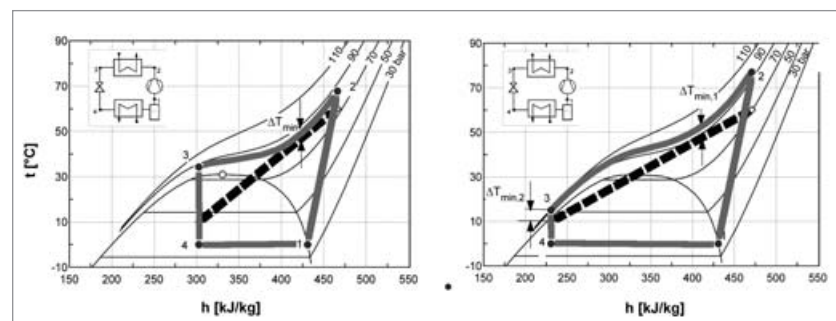

Figure 2: Influence of the high-side pressure on the obtainable enthalpy difference during heat rejection in a trans-critical CO<sub>2</sub> cycle (left: sub-optimum pressure, right: optimum pressure)

## Applications

In this chapter following heat pump applications are discussed:

- Water heating
- Space heating - hydronic heat distribution systems
- Combined space heating and hot water heating
- Drying
- Residential air conditioning

Finally, future potential and applications of CO<sub>2</sub> heat pumps are discussed.

### Water heating

One of the most promising applications of CO<sub>2</sub> are heat pump water heaters (HPWH). This is due to the good adaptation of the process to the application, caused by a large temperature glide on the heat sink side in combination with a low heat sink inlet temperature in case of a once-through hot water system. Neksa et al. (1999) presented measured COP values for a 50 kW prototype CO<sub>2</sub> system. Figure 3 shows the COP as a function of the evaporation temperature. The set-point temperature for the hot water was 60 and 70°C, and the inlet temperature of the city water was 8°C. The COP figures at 60°C hot water temperature are very favourable, varying from approximately 3.0 at an evaporation temperature of -20°C to 5.0 at +10°C. At 70°C hot water temperature, the COP varied between approximately 2.8 to 4.4.

Further experiments have shown that the COP dropped from approximately 4.3 to 3.9 when the inlet water temperature increases from 8 to 20°C, considering a hot water temperature of 60°C and an evaporation temperature of 0°C. As a general rule,

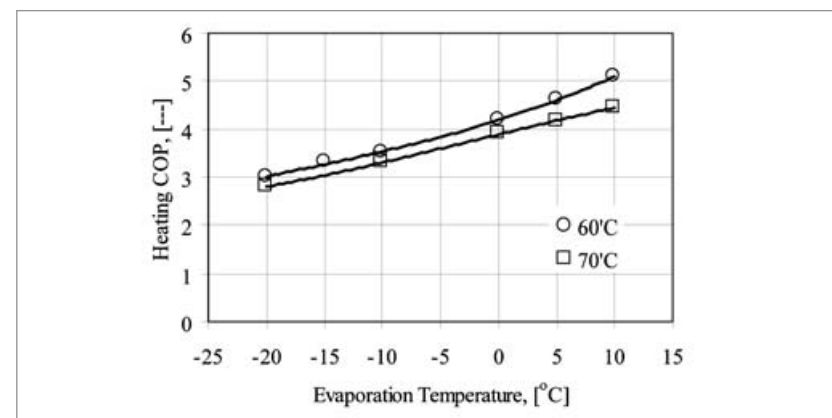

Figure 3: CO<sub>2</sub>-HPWH – COP at varying evaporation temperature for outlet temperatures 60 and 70°C (water inlet temperature: 8°C; mechanical efficiency of the compressor 0.9) (Neksa et al., 1999)

the COP of CO<sub>2</sub> heat pump water heaters drops by roughly 1 to 1.5% for each °C increase in the inlet water temperature (Stene, 2004). In order to achieve a low inlet water temperature to the gas cooler and with that a high COP for a CO<sub>2</sub> heat pump, it is of crucial importance to apply tailor-made hot water tank systems where the mixing of hot and cold water as well as conductive heat transfer inside the tank during the tapping and charging periods are reduced to a very low level (Stene, 2004). The high system COP reflects that there is a good adaptation of the process to the application, favourable heat transfer characteristics for the CO<sub>2</sub> and efficient compression. The isentropic and volumetric efficiencies at design conditions (high-side pressure 90 bar and low-side pressure 35 bar) were approximately 0.84 and 0.86, respectively. Figure 4 shows measured COPs as a function of the hot water temperature. The water inlet temperature was about 10°C and the evaporation temperature was held constant at 0°C and -10°C. Even at high hot water temperatures the system COP was relatively high, about 3.7 at 80°C and 0°C evaporation temperature and 3.0 at -10°C evaporation temperature.

The market potential for heat pump water heaters is large. Roughly 20% of the energy use in residential and commercial buildings is spent for water heating (IEA-HPC, 1993). Additionally, a CO<sub>2</sub> heat pump water heater may produce hot water with temperatures up to 90°C without operational problems and with only a small loss in efficiency. Consequently, the area of application is much larger than for conventional heat pump systems, often restricted to hot water temperatures lower than 55°C. In addition, there is a substantial need for water heating in industry, where often the tap water heating may be combined with refrigeration and/or freezing by utilizing the cold side of the system. In Japan the first CO<sub>2</sub> heat pump water heater system was sold in 2001. So far this system has not been introduced to the European market on

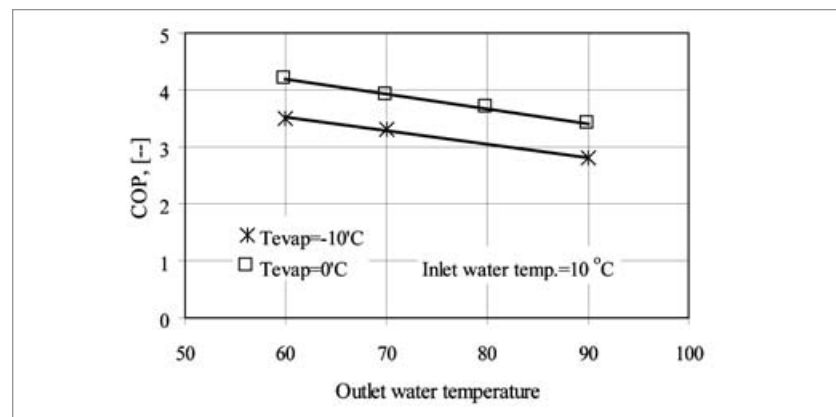

Figure 4: CO<sub>2</sub>-HPWH – COP for varying hot water outlet temperatures (Nekså et al, 1999)

a broad basis, but one can find some single installations e.g. in Norway and Sweden (compare IEA Heat Pump Newsletter No.2/2005 and [www.kcc.se](http://www.kcc.se)). Since all electric power companies in Japan were allowed to use “EcoCute” (Kansai Electric’s registered trademark) as a pet name for their heat pump water heaters using the natural refrigerant CO<sub>2</sub>, it has been made widely known by the general public, coupled with the electric power companies’ publicity backup and government’s subsidy system. On the Homepage of JARN (“Japan Air Conditioning, Heating & Refrigeration News”, <http://www.jarn.co.jp>) one can find information about the market for “Eco Cute” in Japan. Hashimoto (2006) has also presented numbers of shipment in Japan (Figure 5), and he mentioned a target value of 5.2 million “EcoCute” installations by the year 2010.

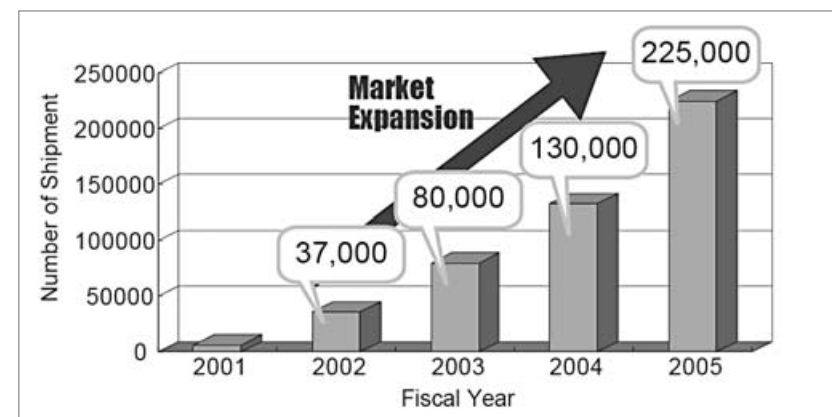

Figure 5: Japanese market situation for CO<sub>2</sub> heat pump water heaters (Hashimoto, 2006)

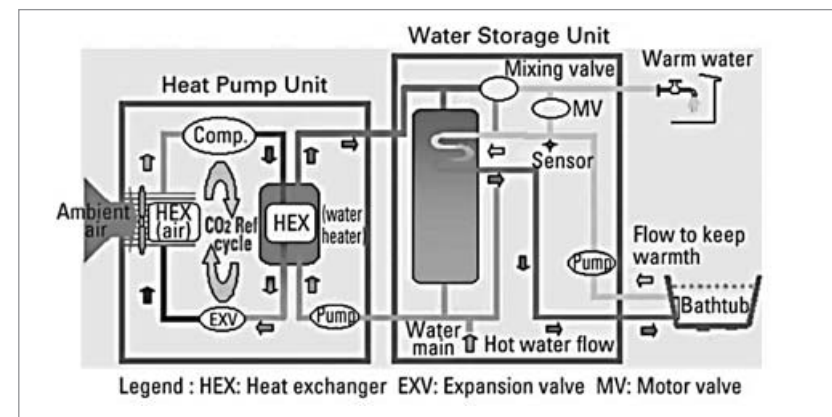

Figure 6: Typical CO<sub>2</sub> heat pump water heater system in Japan ([http://www.jarn.co.jp/News/2004\\_Q2/40629\\_Growing\\_CO2.htm](http://www.jarn.co.jp/News/2004_Q2/40629_Growing_CO2.htm))



Hirsohi (2003) describes the basic functions of the CO<sub>2</sub> heat pump water heater sold in Japan (compare Figure 6). The systems use ambient air as the heat source and they are equipped with a storage tank, and the hot water is produced and stored in the tank during nighttime when the electricity is cheap. The temperature of the water stored in the tank is 85°C during winter when the city water temperature is low (5 - 9°C), 65°C during summer when it is relatively high (17 - 24 °C), and 75°C for the intermediate period.

The Japanese units usually supplies both hot tap water as well as warm water for the bathtub. Full Auto' types can be operated by a remote control to fill a bathtub with hot water, and stop at the preset water level. They automatically raise the temperature when the water in the bathtub cools, and add water when the water level drops. Remote controllers installed in the kitchen and bathroom display information such as the tank level, tank temperature, water temperature, and bath temperature. Recent technological developments in CO<sub>2</sub> heat pump water heaters allow them to reliably provide adequate heat in cold climates at ambient temperatures as low as -20°C. It is now possible for air-source heat pumps to be used in frigid climates that were previously unsuitable for the use of conventional heat pumps. Hiroshi (2003) believes that air-to-water CO<sub>2</sub> water heaters will become more widely used because the running costs are competitive – even in cold climates – compared to kerosene powered water heaters that run on cheap fuel. In Europe the development of CO<sub>2</sub> heat pump water heaters based on exhaust air as the heat source is going on. This system may offer an interesting solution for hot water production in buildings with controlled ventilation systems. However, the system has not yet entered the market.

### Space heating – hydronic heat distribution systems

This section shows results of a theoretical investigation of CO<sub>2</sub> heat pumps used for hydronic heating systems with supply/return temperatures of 90/70°C, 55/45°C and

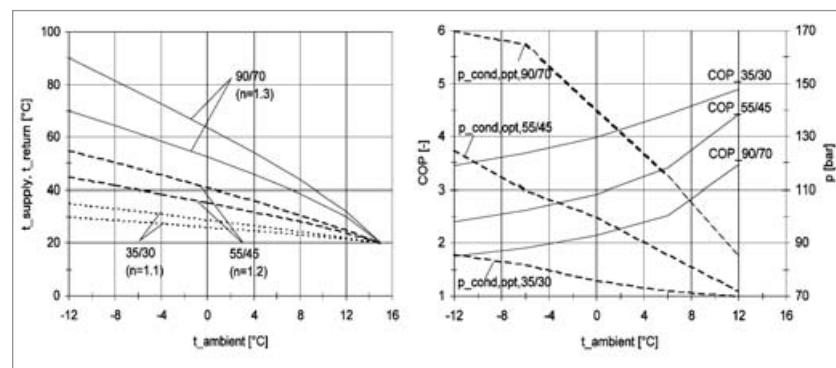

Figure 7: Supply and return temperature of the hydronic systems (Rieberer, 1998)  
 Figure 8: Simulated COP and optimum high-side pressure ( $p_{cond,opt}$ ) (Rieberer, 1998)

35/30°C at a design temperature of -12°C (Rieberer, 1998). The calculated supply/return temperatures of the different heating systems depending on the ambient temperature are shown in Figure 7. This figure is based on internal heat sources corresponding to a temperature gain of 5 K, i.e. the heat demand becomes zero at an ambient temperature of 15°C. For the determination of the COP of the CO<sub>2</sub> heat pump the following assumptions have been made: evaporation temperature 0°C (i.e. ground water or earth as heat source), no superheat, compressor efficiencies  $\eta_{is} = 0.8$  and  $\eta_{mech} = 0.9$ , internal heat exchanger, and counter flow gas cooler and condenser, respectively. The results of the cycle calculations are shown in Figure 8.

As can be seen from Figure 8, the corresponding optimum high-side pressure depends strongly on the ambient temperature, but the influence of the pressure on the COP becomes rather small at high heat-sink inlet temperatures. Thus, the influence of deviations from the optimum is small for these systems. However, the COPs are not as high as for a CO<sub>2</sub> heat pump water heater with a low city water temperature allowing a low CO<sub>2</sub> outlet temperature from the gas cooler. Brandes (1999) proposed a high temperature CO<sub>2</sub> heat pump with ambient air as the heat source operating at supply/return temperatures of 93/40°C (instead of 70/50°C) at a design temperature of -15°C (compare Figure 9). This temperature level, realized by means of a reduced water flow rate in the heating system, might have a big market potential as a heating system for retrofitting fossil-fired boilers in combination with hydronic heat distribution systems.

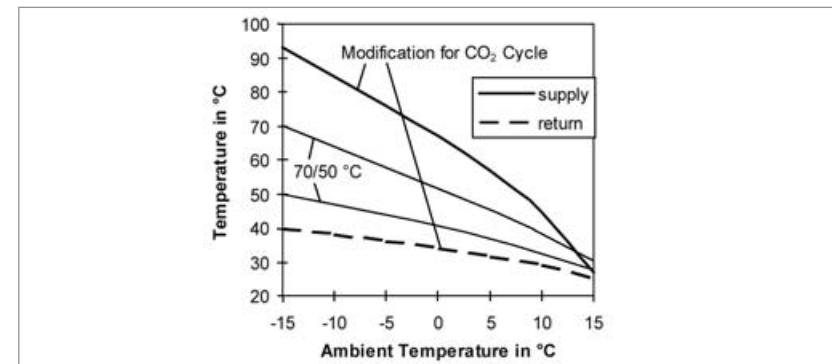

Figure 9: Supply and return temperatures for different hydronic heat distribution systems including a 93/40°C systems applicable together with CO<sub>2</sub> heat pumps (Brandes, 1999)

### Combined space heating and hot water heating

In Stene (2004) a detailed theoretical and experimental study for a residential CO<sub>2</sub> heat pump system for combined space heating and domestic hot water heating (DHW) is presented. Figure 10 shows the principle layout of the system. The counter-flow tripartite CO<sub>2</sub> gas cooler provides:

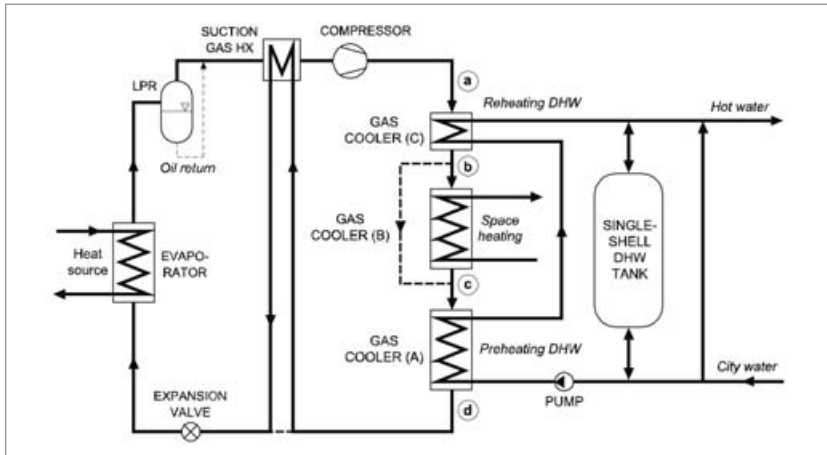

Figure 10: Principle of an integrated residential CO<sub>2</sub> heat pump system (Stene, 2004)

- Preheating of DHW (A)
- Low-temperature space heating (B)
- Reheating of DHW (C)

The integrated CO<sub>2</sub> heat pump system has three operating modes: Space heating only (SH mode), DHW heating only (DHW mode), and simultaneous space heating and DHW heating (Combined mode). In Figure 11 the heat rejection process during operation in the Combined mode is illustrated in a temperature/enthalpy-diagram.

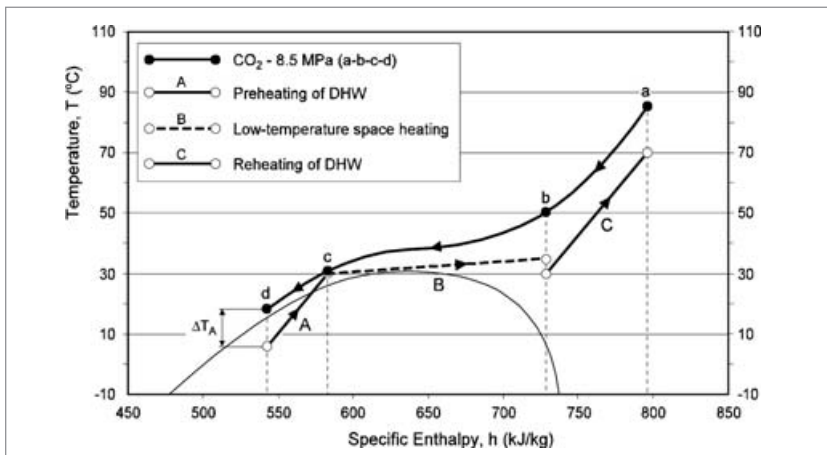

Figure 11: Illustration of the heat rejection process in the Combined mode (Stene, 2004)

The COP in the Combined mode is higher than that of the DHW mode due to the lower high-side pressure and a similar temperature approach ( $\Delta T_A$ ). The COP in the SH mode is considerably lower than that of the Combined mode and the DHW mode because of the bad temperature fit between the CO<sub>2</sub> and the water in the gas cooler, and the fact that the CO<sub>2</sub> outlet temperature from the tripartite gas cooler is limited by the return temperature in the space heating system.

A 6.5 kW brine-to-water CO<sub>2</sub> heat pump prototype was tested at the NTNU-SINTEF laboratory (Norway). The evaporation temperature ranged from -10 to 0°C, the supply/return temperatures in the space heating system were 33/28, 35/30 or 40/35°C, and the DHW temperature was 60, 70 or 80°C. The test results demonstrated that the integrated CO<sub>2</sub> heat pump system may achieve the same or higher seasonal performance factor (SPF) than that of a highly energy efficient brine-to-water heat pump system available on the market. However, this presupposes that the ratio of the annual heat delivered for DHW production and the total annual heat delivered from the heat pump unit is minimum 25 to 30%, the return temperature in the space heating system is low (approx. < 30°C), the city water temperature is relatively low (approx. < 10°C) and the thermo-dynamic losses in the DHW tank are small. The latter requires a special tank design in order to minimize mixing and conductive heat transfer between the hot and cold water during the tapping and charging periods.

In Japan, the EcoCute residential CO<sub>2</sub> heat pump is now available as a multifunctional heat pump system for hot water heating, space heating (floor heating), bathroom heating/drying (fan-coil), and reheating of bath tub water. Figure 12 shows a principle sketch of the multi-functional CO<sub>2</sub> heat pump system (Hihara, 2004).

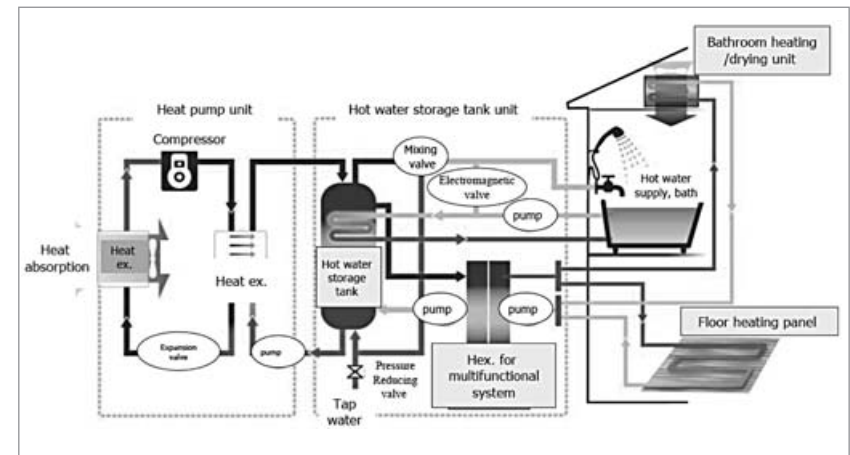

Figure 12: Principle layout of the EcoCute air-to-water multifunctional CO<sub>2</sub> heat pump for hot water heating, space heating and bathroom heating/drying (Hihara, 2004)

## Heat pump dryer

### Laundry dryer

At the University of Essen a laundry dryer based on a CO<sub>2</sub> heat pump has been investigated in detail (compare Figure 13). Klöcker et al. (2001) concluded that the use of CO<sub>2</sub> as working fluid has the advantage of enhanced performance and safe operation. Because of the environmentally benign properties and the favourable thermodynamic behaviour of CO<sub>2</sub> its use as a working fluid in drying heat pump processes can be regarded as advantageous. Semi-hermetic compressors – meanwhile available – enable the application of this technique for commercial size laundry dryers, while the development of small hermetic compressors is promising for household laundry dryers presently still operated with the HFC R134a as working fluid.

### Food dryer (T. Eikevik, NTNU, Trondheim)

Food dryers based on a heat pump may reduce the energy consumption by 70 to 80% compared with conventional dryers, give the manufacturers of dried products greater possibilities to optimize product qualities to fit the market demand, and more or less eliminate emissions from the dryer due to the closed drying loop. The drying conditions, i.e. the temperature and relative humidity, in the drying chamber can easily be controlled by changing the air cooler and air heater capacities (compare Figure 14). This enables drying at conditions both below and above the freezing point of the product. At temperatures below the freezing point of the product, the drying process will give product qualities similar to vacuum freeze-dried products.

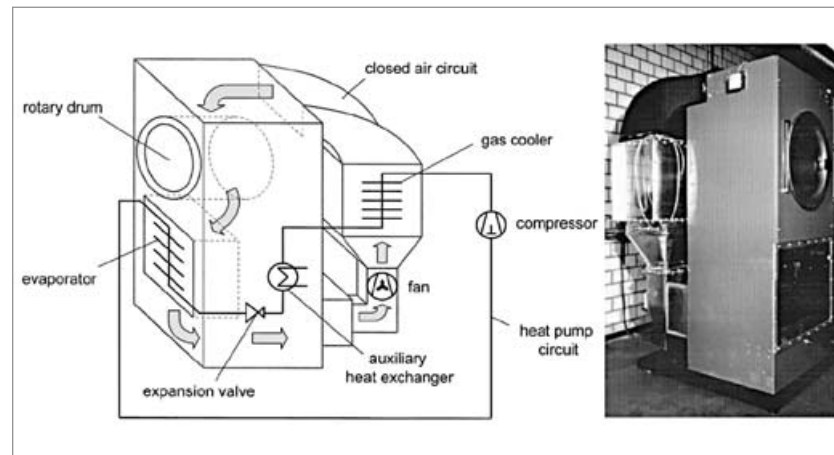

Figure 13: Laundry heat pump dryer (Klöcker et al., 2001)

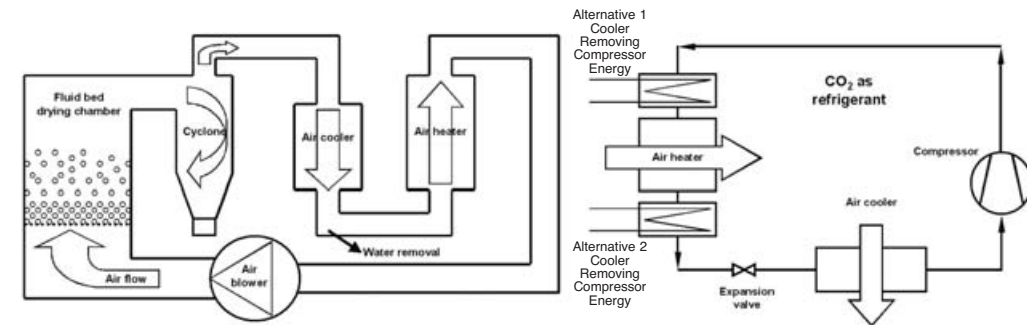

Figure 14: Layout of the fluidized bed dryer (left) and the CO<sub>2</sub> heat pump (right)

In the Dewatering R&D Laboratory at NTNU-SINTEF (Norway), a prototype CO<sub>2</sub> fluidized bed heat pump dryer has been constructed (Figure 15). The heat pump is designed to operate at -20°C to +100°C inlet air temperature for the drying chamber. At inlet air temperatures below +15°C, the CO<sub>2</sub> heat pump will achieve slightly better SMER values (Specific Moisture Extraction Rate, kg<sub>water</sub>/kWh<sub>el</sub>) than that of conventional heat pump dryers using R134a, propane, R407C, R410A or ammonia as working fluids. In the temperature range between +30°C and +50°C, the SMER for the CO<sub>2</sub> heat pump dryer will be 30 to 40% higher than that of conventional heat pump dryers. Further information can be found in Eikevik et al. (2003).



Figure 15: The fluid bed CO<sub>2</sub> heat pump dryer at the NTNU-SINTEF laboratory

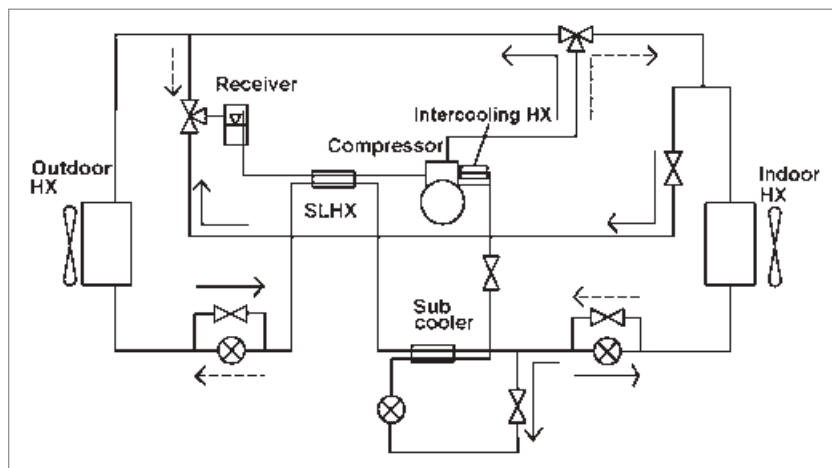

Figure 16: Principle of the prototype CO<sub>2</sub> RAC unit (Solid line: AC operation, Dashed line: HP operation, Dotted line: Two stage operation) (Jakobsen et al., 2004)

### Residential air conditioning (A. Jakobsen, SINTEF Energy Research, Trondheim)

The annual world market for residential air conditioning units (RAC split-type) is about 40 million units (Nowacki, 2002), and further market growth is expected. HFCs are the dominant working fluids in RAC units today. The CO<sub>2</sub> technology has in recent years become commercially available in heat pump water heaters, and is expected to be introduced in several other applications in the near future. If CO<sub>2</sub> RAC systems are going to be commercialized, equal or better seasonal performance factors (SPFs) compared to the baseline HFC systems have to be documented.

A prototype CO<sub>2</sub> RAC unit has been installed in two calorimetric test chambers at the NTNU-SINTEF laboratory in Norway, and initial experiments have been performed (Jakobsen et al., 2004). Realistic simulations have also been carried out with the advanced in-house simulation program CSIM, using input data for the components of the prototype. The simulations and experimental results have been compared with the measured performance of a state-of-the-art R410A RAC split-unit having a heating capacity of 4 kW at 5°C ambient air temperature. Figure 16 shows the principle of the unit. In heat pump mode, the prototype unit can operate either as a conventional single-stage circuit or as a two-stage system with a sub-cooler. In AC mode, an inter-cooler can be used between the first and second stage.

The simulation results for the CO<sub>2</sub> RAC unit show that it has a potential of significantly better performance in heat pump mode compared to the baseline R410A technology, whereas the performance is more or less equal in cooling mode. Initial experimental results in cooling mode show slightly lower COPs than simulated, both with

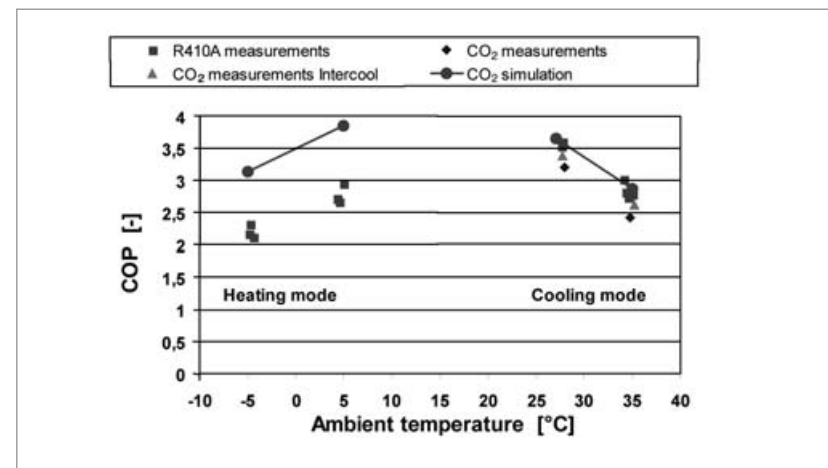

Figure 17: Simulation and initial experimental results for a prototype CO<sub>2</sub> RAC unit compared to the measured performance of a baseline R410A RAC unit (Jakobsen et al., 2004)

and without inter-cooling (Figure 17). The conclusion at this stage is that the initial test results look promising, and that CO<sub>2</sub> RAC systems are likely to compete with baseline HFC systems regarding the seasonal performance (SPF).

### Further applications

The late professor Gustav Lorentzen has published several papers describing the possibilities of using CO<sub>2</sub> as working fluid in heat pumps and refrigeration systems. In Lorentzen (1994) he describes system designs of large heat pumps for district heating. This is a high-capacity application where turbo expanders may possibly be applied in a cost efficient manner. Described is also the possibility to combine refrigeration/freezing and tap water heating, which will give a very high overall system efficiency.

A further potential application is dehumidification of air, for instance in indoor swimming pools. Here, the air is cooled down below the dew-point in the evaporator (= dehumidification) and is reheated in the heat pump condenser before it is blown into the building again. Due to the large temperature glide of the air during heat rejection in the gas cooler, CO<sub>2</sub> is well suited for this application. Additionally, the safety aspect of CO<sub>2</sub> is a great advantage. A CO<sub>2</sub> heat pump could also be applied in an 'air-heater', which lifts the air temperature from about 20°C to 25...50°C.

Space conditioning of both existing and new commercial buildings is also regarded an interesting application for CO<sub>2</sub> heat pump systems (Andresen and Stene, 2004). By making a serial connection of heat loads with different temperature requirements, e.g. radiators for space heating and heater batteries for reheating of ventilation air, the CO<sub>2</sub> outlet temperature from the gas cooler can become relatively low. The heating

demand for reheating of ventilation air versus the space heating demand as well as the operating time of the ventilation system are crucial parameters regarding the obtainable seasonal performance factor (SPF) for the CO<sub>2</sub> system.

Finally, earth probes based on the thermosyphon principle using CO<sub>2</sub> as the working fluid should be mentioned. This naturally circulating system can be used as heat source system for ground-coupled heat pumps. Further information on this topic can be found in Rieberer et al. (2004).

---

## Conclusion and outlook

---

Several applications for CO<sub>2</sub> heat pumps exist. Heat pump water heaters are of special interest, because of the optimum adaptation of the CO<sub>2</sub> process to the water heating process. This results in a high efficiency and allows hot water production up to 90°C without any operational problems.

In Japan CO<sub>2</sub> heat pump water heaters have been on the market since 2001 – in contrast to Europe where only a few installations have been realized until today. However, some companies have already announced a broad market introduction.

Most of the other applications mentioned here are on a post-scientific but pre-commercial status, mainly due to missing components on the European market. A thermodynamic drawback of CO<sub>2</sub> is that the efficiency of heat pumps drops if the inlet temperature of the heat sink increases. This fact must be reflected when designing the overall system, including the heat storage and distribution system.

The development of cost efficient expansion machines may help to keep the heat pump efficiency on a superior level – compared to HFC heat pumps – even at high inlet temperatures. Worldwide research institutes investigate such machines. A cost-efficient and robust alternative is to replace the throttling valve by an ejector. The new multi-functional EcoCute CO<sub>2</sub> heat pump from Japan is equipped with such an ejector, which increases the COP by 10 to 20% (Ozaki et al., 2004).

---

## References

---

Andresen T., Stene J. (2004). “CO<sub>2</sub> Heat Pumps for Heating and Cooling of Office Buildings”, SINTEF Report TR A5952, SINTEF Energy Research, Norway. ISBN 82-594-2639-0.

Brandes H. (1999): “Energy Efficient and Environmentally Friendly Heat Pumping System Using CO<sub>2</sub> as Working Fluid in Existing Buildings”, IEA/IZWe.V./IIR Workshop: “CO<sub>2</sub> Technology in Refrigeration, Heat Pump and Air Conditioning Systems”, Mainz, Germany.

Eikevik T.M., Alves-Filho O., Strømmen I. (2003): “Carbon-Dioxide Heat Pump Dryer and Measurements on Coefficient of Performance and Specific Moisture Extraction Ratio”, 2nd Nordic Drying Conference, Copenhagen Denmark, ISBN 82-594-2550-5.

Hashimoto K. (2006): „Technology and Market Development of CO<sub>2</sub> Heat Pump Water Heaters (ECO CUTE) in Japan”, IEA Heat pump newsletter, Vol. 24, No. 3/2006, pp. 12-16.

Hihara, E. (2004): “Simulation of Annual Performance of Carbon Dioxide Heat Pump with Floor Heating and Hot Water Supply”. University of Tokyo. Presentation at the Annex 28 working meeting in Yokohama, Japan, June 2nd-3rd, 2004.

Hiroshi M. (2003): “Development and performance evaluation of CO<sub>2</sub> heat pump water heater for cold climates”, IEA Heat Pump Centre Newsletter Volume 21 - No. 4/2003.

IEA-HPC (1993): “Domestic Hot Water Heat Pumps in Residential and Commercial Buildings”, IEA Heat Pump Centre Analysis Report HPC-AR2.

Jakobsen A., Skaugen G., Skiple T., Nekså P., Andresen T. (2004): Development and Evaluation of a Residential Air Conditioning System Compared to a State-of-the-Art R410A Unit, 6th IIR/IIF Gustav Lorentzen Conference on Natural Working Fluids, Glasgow.

Klöcker K., Schmidt E.L., Steimle F. (2001): “Carbon dioxide as a Working Fluid in Drying Heat Pumps”, International Journal of Refrigeration 24 (2001), pp. 100-107.

Lorentzen G. (1994): ‘Revival of Carbon Dioxide as a Refrigerant’, International Journal of Refrigeration, Vol. 17, No.5, p. 292-301.

Nekså P., Rekstad H., Zakeri G., Schiefloe P.A., Svensson M. (1999): "Heat Pump Water Heaters with CO<sub>2</sub> as Working Fluid", 6th International Energy Agency Heat Pump Conference, "Heat Pumps – a Benefit for the Environment". Berlin, Germany, May 31 - June 2, 1999.

Nowacki, J.E., 2002: Single Room Heat Pumps for Cold Climates. Analysis Report HPC AR14, IEA Heat Pump Programme. ISBN 90-73741-46-7.

Ozaki Y., Takeuchi H., Hirata T. (2004): "Regeneration of Expansion Energy by Ejector in CO<sub>2</sub> Cycle", 6th IIR-Gustav Lorentzen Conference on Natural Working Fluids, Glasgow, GB.

Rieberer R. (1998): "CO<sub>2</sub> as Working Fluid for Heat Pumps", Ph.D. thesis, Institute of Thermal Engineering, Graz University of Technology, Austria.

Rieberer R., Mittermayr K., Halozan H. (2004): „CO<sub>2</sub>-Erdsonde als Wärmeträgersystem für Wärmepumpen“, Deutsche Kälte-Klima-Tagung, 17. – 19. November 2004, Bremen, Deutschland.

Stene J. (2004): "Residential CO<sub>2</sub> Heat Pump System for Combined Space Heating and Hot Water Heating", Doctoral thesis at the Norwegian University of Technology and Science (NTNU), ISBN 82-471-6316-0 (printed ver.), ISBN 82-471-6315-2 (electronic ver.).

Stene, J. (2005): "Residential CO<sub>2</sub> Heat Pumps for Combined Space Heating and Hot Water Heating – System Design, Test Procedures and Calculation of SPF". SINTEF Report TR A 6102. SINTEF Energy Research, Norway. ISBN 82-594-2806-7.

# Trends and Perspectives in Supermarket Refrigeration

PROF. DR. MICHAEL KAUFFELD, Karlsruhe University of Applied Sciences,  
Institute of Refrigeration, Air Conditioning and Environmental Engineering, Germany

---

## Introduction

---

Refrigeration used to be very straightforward: Our forefathers simply used natural ice to cool their foodstuff. Starting in the mid 19th century, mechanical equipment was used to produce the ice needed for cooling food. Soon the cooling was performed directly on the food without the intermediate matter ice. Until the 1930s all refrigerants used in refrigeration systems were naturally occurring substances such as ammonia, carbon dioxide, propane and sulphur dioxide. Due to the safety concerns related to these fluids, refrigeration was mainly limited to large refrigeration plants. It was thanks to the benefits of the so called "safety refrigerants" CFCs introduced in the 1930s that refrigeration systems became very popular. Supermarket refrigeration was very simple with these fluids. Most central systems operated on R22 or for medium temperature also R12. Plug-in units and many condensing units were running on R12. Due to their ozone depleting potential, these refrigerants are now being replaced by a new class of synthetic fluids: the HFCs. For commercial refrigeration systems R134a and R404A are the most popular HFC fluids. Although safe to the local environment (nonflammable and nontoxic) they do have one big drawback: They have global warming potentials (GWP) up to several thousand times higher than carbon dioxide and are therefore included in the Kyoto Protocol, i.e. their emissions are to be reduced as far as possible. Man made global warming is the big challenge for our society today. Refrigeration systems usually contribute by two ways:

- direct emissions of potent greenhouse gases such as CFCs, HCFCs and HFCs
- indirect emissions due to energy consumption

The contribution of commercial refrigeration to global warming can therefore be reduced by:

- reducing direct emissions of greenhouse gases; this can be achieved by
  - extremely tight refrigeration systems
  - reduced refrigerant charge
  - refrigerants without or with very low GWP

- reducing energy consumption
- using renewable energy

This paper will describe different ways of implementing these measures.

## Reducing direct emissions of greenhouse gases

### Extremely tight refrigeration systems

Typical German supermarket refrigeration systems have leakage rates between 5 and 10 %, i.e. 5 to 10 % of the total system charge is emitted to the atmosphere every year. Over 30 % of all leaks stem from mechanical joints. One attempt to reduce leakage rates is therefore to avoid mechanical joints as far as possible and use welding or brazing instead especially in hidden or inaccessible pipes. Another major leak source is failures of pipes due to vibration. Decoupling of compressors from the rest of the plant is therefore very important.

Many larger leaks start as very small leaks which grow over time. Regular maintenance with leak testing is therefore of key importance for tight systems. The European Regulation (EC) No. 842/2006 on certain F-Gases (e. g. HFCs) requires stationary refrigeration and air conditioning systems to be checked regularly depending on the systems amount of refrigerant:

- At least annually for applications with 3 kg or more of F-gases (unless the equipment is hermetically sealed, in which case this goes up to 6kg)
- At least once every six months for applications with 30 kg or more of F-gases
- Leakage detection systems must be installed on applications with 300 kg or more of F-gases, and when these are in place, checking requirements are halved
- If a leak is detected and repaired, a further check must be carried out within one month to ensure that the repair has been effective

Time will show whether this F-Gas Regulation will have an impact on leakage of stationary refrigeration systems.

Another approach is used by the Danish and Norwegian Governments: They impose a high greenhouse gas tax on all refrigerants. This tax is for R404A in Denmark approximately 50 €/kg and in Norway approximately 80 €/kg! Consequently these high prices encourage every user to keep his system tight, especially if the charge is in the order of several hundred kg as for multiplex systems in a larger supermarket.

### Reduced refrigerant charge

In many refrigeration systems, most of the refrigerant is contained in the heat exchangers, especially in the condenser. Most central multiplex supermarket refrigeration systems use round tube and fin heat exchangers as evaporators and condensers. The typical tube diameter is 15 mm. The refrigerant charge inside the heat exchangers can

be reduced by up to 80 % using minichannel heat exchangers well known within the automotive air conditioning industry. The automotive air conditioning industry has developed from large round tube condensers ( $\varnothing$  12 mm) in the 1970s over small round tubes ( $\varnothing$  7 mm) to Multi-Port-Extruded (MPE) all aluminum brazed heat exchangers with a fourfold increase in heat transfer coefficient on the refrigerant side together with a tremendous decrease in refrigerant charge. This development is yet to take place in stationary refrigeration and air conditioning equipment. One major American air conditioning manufacturer already offers its chillers with minichannel condensers with noticeably reduced refrigerant charge. It is just a matter of time until the commercial refrigeration market will follow.

Another possibility to reduce refrigerant charge is the application of indirect refrigeration systems, which is very common in Sweden where refrigerant charge per system has been limited to some 30 or 40 kg for many years. Typically, propylene glycol is used as liquid secondary refrigerant in the medium temperature (MT) loop. Glycol becomes too viscous for the low temperature (LT) loop. Attempts have been made using different potassium formate and Potassium acetate solutions for LT applications. Where MT secondary loop systems can achieve energy efficiencies quite similar to direct expansion systems, using a liquid secondary fluid in a low temperature application usually increases the energy consumption. Therefore systems were developed using carbon dioxide as a volatile secondary refrigerant. These systems show good energetic performance. Lately attempts have been made to establish the carbon dioxide loop as a fully integrated refrigeration system, i.e. build it as a cascade underneath the MT system, see figure 1. Although the MT primary refrigeration system is confined to the machinery room the LT system uses conventional direct expansion technology. Due

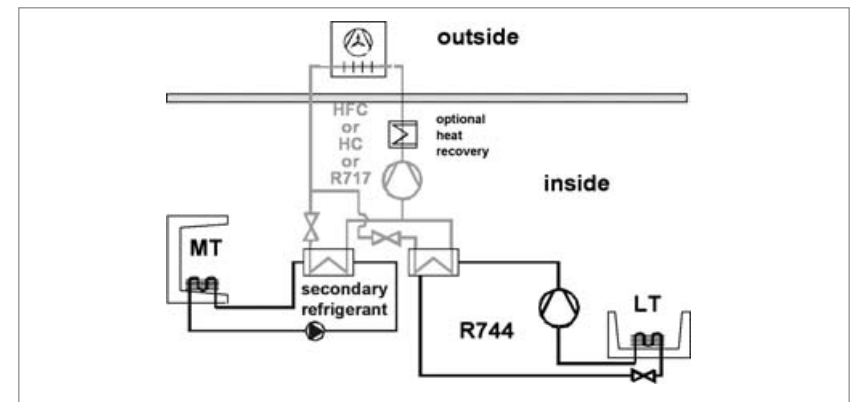

Figure 1: Secondary loop MT refrigeration system also called indirect refrigeration system. The low temperature loop is build as a cascade system to the MT system

to the potentially high system pressure of the carbon dioxide loop during stand still, special precautions have to be taken to avoid excessive pressures. In a typical supermarket system which operates 24 hours a day, seven days a week CO<sub>2</sub> is simply blown off to the atmosphere if pressures exceed the maximum allowable pressure during stand still.

Employing a propylene glycol system for the MT cooling has a few advantages as compared to direct expansion systems:

- First of all reduced primary refrigerant charge; reductions up to 80 to 90 % are possible.
- Factory assembly of the primary refrigeration system with higher quality and lower risk for leaks.
- Reduction in oil charge of the much smaller internal volume primary refrigeration system.
- Possibility for using flammable or toxic refrigerants as primary refrigerant well confined to the machinery room. Air cooled roof top condensers are legally feasible in some countries, e.g. Denmark even with flammable or toxic refrigerants.
- Easy utilization of heat recovery when using a water cooling loop for the condenser, as is often the case in Denmark or Sweden in order to reduce the primary refrigerant charge as much as possible.
- More stable air temperature and air humidity in display cases due to lower temperature fluctuations of the glycol loop and higher surface temperatures of the heat exchangers inside the cabinets. Higher air humidity results in less shrinkage of the food stuff.

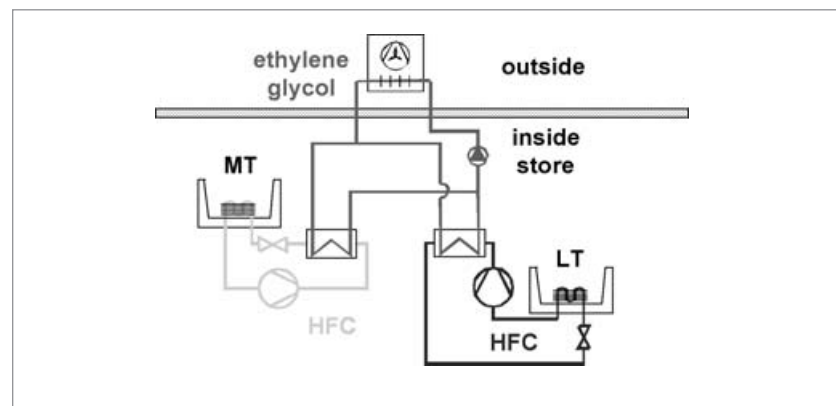

Figure 2: Distributed System – compact multiple compressor arrangements are housed in noise reducing boxes and placed close to the refrigerated cabinet inside the store. Condenser heat is rejected to a water loop which again rejects its heat via a cooler to the outside air unless used for heating the building

- Possibility of constructing the secondary loop in plastic piping and fittings which can be cheaper than copper piping traditionally used with direct expansion systems.

Especially in the USA the use of distributed systems is gaining a considerable market share, see figure 2. In 2006 15 % of all new supermarket refrigeration systems in the USA were of the distributed type (Garry2007). Losses in suction pipes can be greatly reduced due to the compact design of the individual compressor racks which are encased in noise reducing boxes and placed inside the store. Experience from American supermarkets therefore shows 5 to 8 % lower energy consumption (Walker1999) and about 30 to 50 % lower refrigerant charge (Baxter2007) than for comparable R404A direct expansion systems.

Some countries try to force charge reduction in refrigeration systems. In Denmark, it is prohibited to use HFC in quantities larger than 10 kg in a single system since 1. January 2007. Sweden even has a longer record of prohibiting HFC in large quantities. As a result most Swedish supermarket refrigeration systems tend to be indirect systems.

### Refrigerants without or with very low GWP

Another possibility to reduce direct emissions of greenhouse gases is to use refrigerants with negligible GWP. But GWP is not the only criterion when selecting a suitable refrigerant. Among others the following items are of interest:

- Zero ODP
- Good thermodynamic properties, among others
- Good heat transfer
- Low pressure ratio
- High volumetric refrigeration capacity
- Non-corrosive
- Oil compatibility
- Stable
- Non-toxic
- Non-flammable
- Available
- Cheap

Table 1 shows the properties of several refrigerant candidates suitable for commercial refrigeration systems.

	GWP	Flam- mability	Toxicity	Price of Refrigerant	Price of System	Theoretical system efficiency
HFCs	high	No	no	moderate	low	good
Hydrocarbons	low	Yes	no	low	low to medium	good
Carbon Dioxide	low	No	only at high concentr.	low	medium	medium
Ammonia	low	can be ignited	yes	low	medium to high	good

Table 1: Properties of various refrigerants for commercial refrigeration systems



From a technical point of view the vapour pressure curve is a rather important characteristic. Figure 3 shows the vapour pressure curves for several refrigerants for commercial refrigeration systems. It can easily be seen that one refrigerant is quite different from all the others: R744 – carbon dioxide. System pressures are much higher with R744 than with any other refrigerant shown. In addition, the critical temperature of R744 is only 31 °C. An air cooled R744 system will therefore during hot summer days not be able to condense the refrigerant in the condenser. The system COP of such a system without system modifications will be lower than that of a conventional system with condensation at all times.

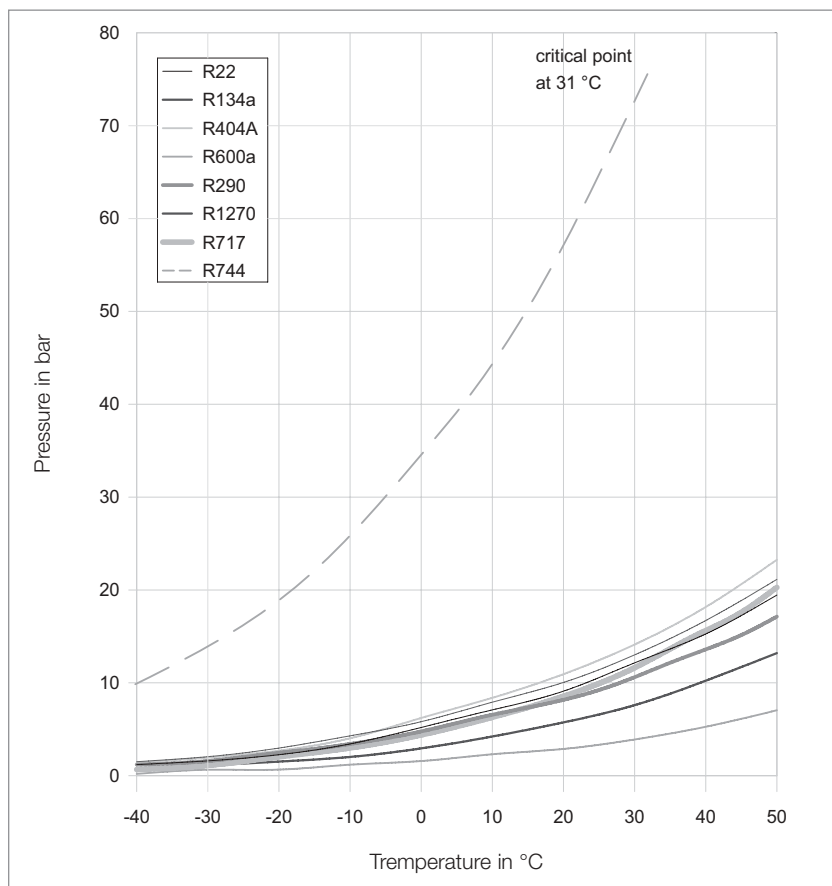

Figure 3: Vapour pressure curve of some common commercial refrigerants. The graph shows the corresponding vapour pressure for any given temperature, e.g. R744 (carbon dioxide) boils (evaporates) at -20 °C at a pressure of 20 bar or condenses at a pressure of 60 bar at a temperature of 22 °C

A possibility for using carbon dioxide whilst ensuring it always operates well below its critical temperature is its application within a cascade system, as described above. The maximum operating pressure of such systems is typically limited to 40 bar. Throughout the last couple of years many components have been developed suitable for that pressure range e.g. expansion valves, control valves, filter/driers, heat exchangers and compressors. Such R744 cascade systems are now seen as state of the art by many European supermarket refrigeration equipment manufacturers (Sienel2007).

But also systems condensing CO<sub>2</sub> at ambient air temperatures are gaining popularity in Europe and slowly in the rest of the world. The typical direct expansion system for MT and LT applications uses a two stage compression for the LT side as shown in figure 4. Pressure inside the store is usually limited to 40 bar and the higher pressures (up to 120 bar during summer time) are kept in the machinery room and the outside heat exchanger. Up to now over 70 such stores have been built in Europe by several companies. Energy efficiency is usually better than for a comparable R404A system during outdoor temperatures below approximately 12 °C, equal to R404A between 12 and 26 °C and slightly lower at higher ambient temperatures (Sienel2007).

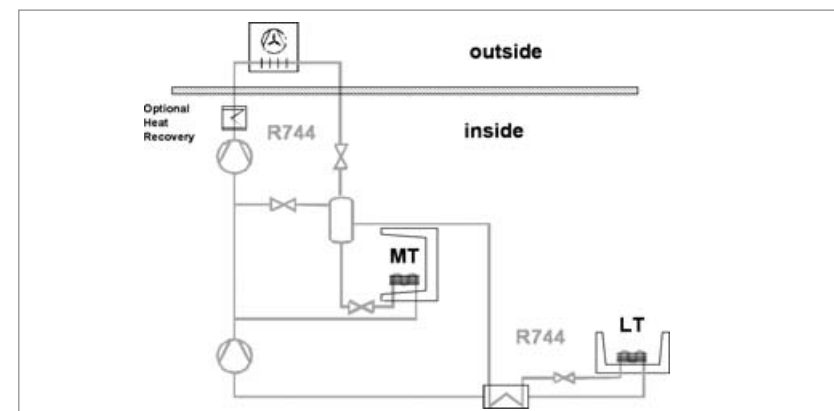

Figure 4: Central multiplex system with carbon dioxide as refrigerant

Flammable (hydrocarbons) and toxic (ammonia) refrigerants can be used as primary refrigerant in indirect systems – see above. But hydrocarbons can also be applied direct in the store if certain safety precautions are taken. The usual standard considered is IEC 60335-2-89 which calls for a maximum charge of a flammable refrigerant of 150 g. Taking the systems internal volume and the volume-pressure product for the hermetic compressor into account, hermetic refrigeration systems up to about 1 kW refrigeration capacity are being build using propane (R290). Such systems have approximately 10 to 15 % lower energy consumption as comparable HFC-products (Jürgensen2004). New developments also include variable speed compressors for these plug-in units which save an additional 10 to 15 % (Jürgensen2004).

## Reducing energy consumption

Between 40 and 60 % of the electricity consumption of a typical supermarket is related to the refrigeration equipment.

The following can be done during the design and construction phase of a supermarket refrigeration system in order to reduce energy consumption:

- Glass door or lid instead of open cabinets
- Improved insulation by increased thickness or higher heat resistance
- Fan motor outside cabinet in order to avoid the heat of the motor as cooling load
- Improved evaporator fan and/or fan motor, e.g. higher efficiency fan blades or high efficiency electric motor
- Improved air flow in open multidecks such that air loss to the sales room is minimized and air infiltration from the sales room is minimized
- Infrared reflecting shades or baldachins in order to prevent heat load from shop lights and/or sun light
- Improved antisweat heaters / dew point control in order to run at lowest possible temperature
- Siphon in defrost drain rather than straight lines prone to air infiltration
- Hot gas defrost instead of electric defrost
- Speed control of compressors, pumps, fans instead of on/off operation
- Improved expansion valve, e.g. electronic expansion valves
- Expansion machine, e.g. a turbine which recovers expansion work and supplies it to the compressor
- Improved evaporator, e.g. enhanced air side or enhanced refrigerant side or mini-channels – every degree centigrade higher evaporation temperature reduces energy consumption by approximately 3 %
- Flooded evaporator instead of using between 20 and 30 % of the refrigerant side surface for superheat
- Defrost on demand by for example monitoring the fan current and starting to defrost when fan current increases
- Improved lights, e.g. LEDs or high efficiency neon tubes in combination with sensors which turn off the light whenever there are no costumers
- Reduced condensation temperature – every degree centigrade reduction in condensation temperature saves approximately 3 % energy
  - Outside air temperature adjusted condensing temperature rather than constant high condensation temperature year round
  - Evaporative cooling of condenser
  - Condenser heat to ground

- Free cooling – outdoor temperatures are lower than the medium temperature in a supermarket, i.e. +5 °C, during certain times of the year and/or day in many countries
- Heat recovery and utilisation of this “waste” heat for heating purposes
- Cold storage, i.e. cooling a reservoir during night hours while the outdoor temperature is low and the condensing temperature can therefore be low too and energy consumption is reduced; the cold storage medium can be a separate tank with chilled water, an ice storage tank or simply the frozen food in the supermarket

The following can be done during operation of a supermarket refrigeration system:

- Correct loading of products in order not to disturb the air flow in the cabinet
- Air humidity in shop area should be at the lower end of the comfort range, i.e. approximately 40 % relative humidity
- Regular evaporator and condenser cleaning

Figure 5 shows the potential of some of these measures. Many of them can be combined in order to improve energy efficiency well above 50 % as compared to current design.

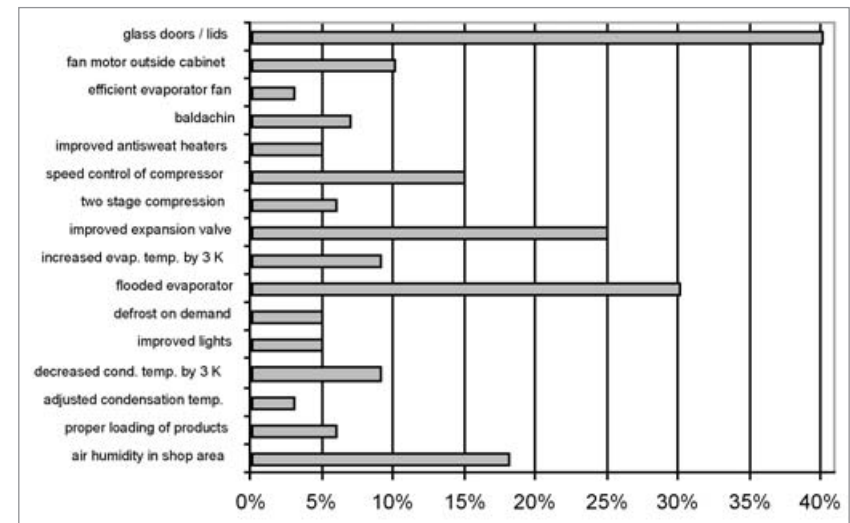

Figure 5: Energy savings by applying different measures. Many of the measures can be combined. The resulting energy savings can be estimated by multiplying individual values – NOT adding them! E.g. if speed control of compressors gives 15 % and fan motor outside cabinet gives 10 %, the resulting total would be 0.9 times 0.85 equal to 0.765 or 23.5 % total energy reduction

Reduction of energy consumption is important because it:

- **reduces the contribution to global warming** through indirect emissions depending on refrigerant, leakage rate and refrigeration system, energy related global warming

contribution varies from 50 % for a R404A multiplex system with 300 kg refrigerant charge, 10 % leakage rate and almost 100 % for a R290 plug-in freezer or a R744 central system.

- reduces the running cost and thereby **increases the profit**  
refrigeration accounts for 40 to 60 % of a supermarket's energy consumption; energy costs are some times in the same order of magnitude as the profit (1 to 2 % of turnover).

---

## Using renewable energy

---

Supermarkets have rather large roof areas. It is therefore quite easy to establish photo voltaic systems on the roof top of a supermarket. This is done by several supermarket chains. Some install in some experimental stores also wind turbines and/or utilize ground source heat. Another possibility for the supermarket chain is to switch to a supplier of renewable energy as a few supermarket chains in Germany and the UK have done. The use of daylight by north facing windows is a simple way of reducing the need for electric lights.

---

## Discussion

---

It is technically and economically feasible to build and operate supermarket refrigeration systems with reduced climate impact. This can be done in several ways as described above. Which way is selected depends on personal preferences, the availability of components and skills as well as on the willingness to maybe pay a slightly higher system price to begin with. In many cases the higher investment can be recovered by lower operating and/or maintenance costs of improved systems.

---

## Conclusion

---

- HFC can be replaced or their charge greatly reduced at acceptable cost in all applications
- Energy efficiency of such alternative supermarket refrigeration systems is at least as good as the state of the art HFC technology
- Supermarket refrigeration systems have an energy savings potential up to 50 % and more at moderate costs
- In countries with adequate laws, e.g. Denmark, Norway and Sweden, many HFC-

free or HFC-reduced systems are built with good energy efficiency

- Some supermarket chains have environmental protection as their strategy and build low carbon emission supermarkets
- HFC-free plug-in units with better energy efficiency using hydrocarbon refrigerants are available up to approximately 1 kW capacity

---

## Acknowledgement

---

The work presented is a result of a project funded by the German Federal Environment Agency, FKZ 206 44 300. The author greatly appreciates this funding.

---

## Nomenclature

---

CO<sub>2</sub> Carbon Dioxide – as refrigerant also called R744

COP Coefficient of Performance

GWP Global Warming Potential

HC Hydrocarbon

HFC Hydro Fluoro Carbon

LED Light Emitting Diode

LT Low Temperature, i.e. cooling of frozen food usually at product temperatures around – 18 °C

MT Medium Temperature, i.e. cooling of milk, meat and vegetables usually at product temperatures around +5 °C

NH<sub>3</sub> Ammonia – as refrigerant also called R717

ODP Ozone Depleting Potential

---

## References

---

Baxter, V.D.: Advances in Supermarket Refrigeration Systems. IEA Annex 26 Summary. ORNL 2006.

Garry, M.: Split Refrigeration. Supermarket News, July 2007, S. 43 – 48.

Jürgensen, H., Nielsen, O.K., Tiedemann, T.: Application Related Design of Hermetic Propane Compressors for Small Refrigeration Systems. Proc. IIR Compressors Conference 2004, Castá Papiernicka, 29.9. – 1.10.2004.

Sienel, T.; Finckh, O.: CO<sub>2</sub>-DX Systems for medium- and low-temperature refrigeration in supermarket applications. IIR 22nd International Congress of Refrigeration, 21<sup>st</sup> – 26<sup>th</sup> August 2007, Beijing, China.

Walker, D.: Development and demonstration of an advanced supermarket refrigeration/HVAC system. Oak Ridge National Laboratory, ORL-SX363C-FM-97 163-1231, March 1999.

# Assessment of Re-fitting Supermarkets with Indirect Systems for Article 5 Countries

DR. DANIEL COLBOURNE, Re-phridge, UK

---

## Introduction

---

Most supermarkets in Article 5 countries adopt one of, or a combination of two of the following refrigeration concepts:

- Integral (stand-alone, plug-in) chilled food and frozen food cabinets
- Remote condensing units individually linked or coupled to chilled and frozen food cabinets and coldstores
- Direct expansion central “pack” type systems feeding refrigerant to chilled and frozen food cabinets and coldstores

Within integral cabinets, there is a variety of refrigerants; typically R-12 in older systems, and a mixture of R-22, R-134a, R-404A and various HCFC and HFC blends in the newer ones. In remote and central direct expansion systems, the dominant refrigerant is R-22. The refrigerant bank for R-22 in all commercial systems is in the order of some 200 ktonnes – this figure is expected to triple by the year 2015 (UNEP, 2007). The average leakage rate is around 35% of the system charge per year, although it will be less for integral systems and higher for the remote or central systems (UNEP, 2006). However, the use of R404A (or R507A) is being employed in some systems in certain countries, but their cost is significantly higher than R-22. However, other types of systems can be considered for supermarket systems, such as indirect secondary systems. The objective of this study is primarily to identify the potential greenhouse gas (GHG) emissions reduction from adopting alternative system concepts for supermarket refrigeration, instead of systems using remote condensing units or direct expansion central systems. Also of relevance is the impact of costs associated with construction and operation of an alternative system.

The work in this study was carried out in the following stages:

- Identification of the most appropriate alternative system
- Data-gathering and methodology for energy consumption and emissions estimation
- Data-gathering and methodology for cost estimation

- Calculation of emissions and costs for a number of countries
- Concluding the countries with best emissions cost effectiveness and recommendations

Calculated values are provided in figures that indicate the quantities of interest: absolute emissions reduction, equipment/installation costs and annual operational costs.

## System concepts

There are a number of different forms of both direct expansion and indirect systems. The concepts that are in use – or have at least been trialled – are described below.

### Direct expansion condensing units

A number of discreet single-compressor/condenser racks located outside or in a machinery room that feed refrigerant to one or two display cabinets or coldstores. This type of system is normally used in convenience stores and small food retailers.

### Centralised direct expansion

Normally two or more independent multi-compressor packs (each for medium-temperature and for low-temperature levels) feeding refrigerant to all cabinets and cold stores from a common header. This is the conventional system design for most large supermarkets in developed countries.

### Distributed direct expansion

A number of small multi-compressor packs distributed around the sales area feeding refrigerant to adjacent cabinets and coldstores, but rejecting heat through common condensers located outside. This concept has been adopted by one large contractor and is used occasionally by a number of supermarkets.

### Indirect distributed condensing units

Cabinets and coldstores employ integral or localised water-cooled condensing unit, rejecting heat to a common water circuit, which may then reject heat to the ambient via a dry cooler, or may be cooled by a chiller located outside or in a machinery room. A number of trial systems have been installed and evaluated.

### Indirect (single-phase)

Normally two independent chillers (one for medium-temperature, one for low-temperature levels) feeding a single-phase heat transfer fluid (HTF) to all cabinets and cold stores from a common circuit.

### Indirect (phase-change)

As indirect (single-phase), but it employs a phase-change HTF such as CO<sub>2</sub> (and sometimes ice slurry). A large number of systems have been installed.

### Partial indirect (single-phase)

A chiller feeds a single-phase HTF to medium-temperature cabinets and coldstores, and to water-cooled condensing units, which in turn feed refrigerant to low-temperature direct expansion cabinets and coldstores. This scheme has been the common choice in Scandinavia, particularly prior to the development of HTFs suitable for low temperature application.

### Partial indirect (phase-change)

As partial indirect (single-phase), but it employs a phase-change HTF such as CO<sub>2</sub> (and sometimes ice slurry). A large number of systems have been installed which generally use CO<sub>2</sub> also as the refrigerant in the low temperature condensing units.

Each of these systems has different implications in terms of cost, efficiency, reliability, leakage, and acceptance, summarised in Table 1.

Name	Implications				
	Efficiency	Leakage	Capital cost	Use freq.	Ease
Condensing units	Medium	High	Low	High	High
Centralised direct expansion	Medium-high	High	Medium	High	Low
Distributed direct expansion	Medium-high	Medium-high	Medium	Low	Low
Indirect distributed cond. units	Medium	Medium	Medium-high	Low	Medium
Indirect (single-phase)	Medium-high	Low	Medium-high	Medium	High
Indirect (phase-change)	High	Low	High	Medium	Medium-low
Partial indirect (single-phase)	Medium-high	Medium-low	Medium	Medium	Medium
Partial indirect (phase-change)	High	Medium-low	High	Low	Medium-low

Table 1: Overview of different supermarket systems

The implications to efficiency and leakage are self-explanatory. The capital cost is a reflection of the complexity of the system and the scale of availability of suitable components. Frequency of use is an indication of the relative number of installations, for example, within Europe, and also indicates the combined experience that contractors have with a particular system concept. The ease of system design and installation is a measure of the potential difficulty associated with designing, installing and operating such a system. In terms of achieving low emissions, the preferred system will have high efficiency and low leakage. Further – particularly for developing countries – it is considered important to have low capital costs and being simple to design and install, whilst there being a good bank of experience to call upon. Balancing these various implications, the indirect (single-phase) concept is considered to be the most suitable for adoption in developing countries. It is known to offer good efficiency (provided it is suitably designed) and have very low leakage rates. Typical equipment costs are normally a little higher than conventional direct expansion systems, it is in relatively common use in northern Europe, and overall it is probably the simplest concept which uses readily available equipment and components.

The Indirect distributed condensing unit concept would also be a favoured option were its existing installations not limited to a small number of trial sites. Similarly, indirect (phase-change) and partial indirect (phase-change) systems (when using CO<sub>2</sub> as the HTF or low-stage primary refrigerant) are also potentially attractive options. However, the designs are considered relatively complex and experience is limited to a few specialist companies; correspondingly the costs may be prohibitively high for some countries.

---

## Evaluations

---

Evaluating the alternative system on the basis of it being installed in a number of different countries was carried out using numerical models, based on system simulations and measurements, and country data such as climate and economic measures. The energy consumption, emissions and cost models were run for four different system options based in a number of different countries. The results help provide an indication of the potential emissions reduction and cost saving associated with substituting conventional direct expansion systems.

For the analysis, a basic direct expansion system was compared against three different indirect systems: one of identical efficiency to the direct system, one of improved design with 7.5% efficiency improvement, and another that employs a hydrocarbon (HC) refrigerant or ammonia (R-717) which allows the efficiency improvement to increase to 15%. An increase in equipment capital cost of 10% is recognised for all indirect systems and an additional 5 – 10% for the equipment using the HC or R-717 to account for extra safety features. (It is likely that the cost associated with implementing R-717 will be slightly higher than using HCs, but this is likely to result in an additional improvement in efficiency.) Also it is assumed that all indirect systems employ a warm-liquid defrost method which is essentially energy-neutral, and the pipework is ABS (Acrylonitrile Butadiene Styrene) type. The analysis also used a number of other fixed conditions:

- Design heat load of 100 kW for medium-temperature and 30 kW for low-temperature level
- System life of 8 years
- Half-hour electric defrost, four times per day for low temperature, and twice per day for high temperature (where used) for the direct expansion systems

An approach was used to estimate the energy consumption of each system type, which was based on variation of system cooling capacity and power consumption with monthly mean ambient temperature – each for medium-temperature and low-temperature levels. The COP of the system was assumed to account for evaporator and condenser

fans, and HTF pumps in the case of the indirect system. Also, the use of electric defrost was added to the direct expansion system only. Electricity consumption from other components such as equipment lighting and controls was not included since they are not directly related to the cooling capacity of the system and are assumed to be identical for each regardless of the type of system.

There are a number of differences in the behaviour of direct and indirect systems – particularly in terms of transient operation – that can result in marked deviations in energy consumption. Because these differences are many and complex in nature, modelling at this stage is considered inappropriate. Instead, incremental assumptions were made on the overall variation in energy consumption between the two systems based on studies in the literature. Although comprehensive studies are scarce and few detailed reports exist within the literature, three of suitable quality were found.

- You (2001) made energy and temperature measurements of a conventional direct system and indirect system that used warm liquid defrost; both installations had similar cooling demands and display cabinet models, and used the same primary refrigerant (R404A). An assessment of the overall annual energy use – after normalising the cooling capacities – found that the indirect system offered 17% lower energy consumption, although this neglects the “fixed” usage such as from cabinet lighting and trim heaters.
- A similar approach was used for a study in the USA by Faramarzi and Walker (2004), where two similar supermarkets were installed each with a conventional state-of-the-art direct system and an indirect system. The basic comparison showed 5% reduction in annual energy consumption for the indirect system when evaporative condensers were used in both. With both systems using conventional (dry) condensers the indirect system offered 15% lower energy consumption. Further analysis was carried out, and it was expected that by employing a number of parallel pumps in the secondary circuit, a further 13% energy saving could be made, and an additional 7% were warm brine defrost used. Overall, the measurements showed that the average coefficient of performance (COP) was 7% higher for the indirect low temperature circuit and between 2% lower and 5% higher for the medium temperature circuit. In fact the improvement in COP of the low temperature system doubled at lower ambient temperatures of about 10°C compared to 25°C.
- Another study was conducted using measurements on an R22 direct system, and then further measurements after it had been retrofitted to an indirect system which used R717 (ammonia) as the primary refrigerant in the chillers (Jesper and Soren, 1996). After normalising the cooling capacity for variations in ambient temperature and cabinet heat loads it was found that the indirect system provided a 14% reduction in energy consumption.

There are many factors that determine the difference in efficiency between the two systems, but by dissecting the total energy consumption into contributing elements the sources of these benefits can be identified.

### Emissions comparison

An emissions model was used to estimate the quantities of emitted CO<sub>2</sub>-equivalent, so that a conventional direct expansion and indirect system can be compared. Such systems are responsible for emissions of both CO<sub>2</sub> (from power stations) and leakage of refrigerant so the global warming effects of each source is added together to evaluate the overall impact of an entire system. This type of environmental assessment technique has developed into a method commonly termed “Total Equivalent Warming Impact” (TEWI), although slight modifications to the method have resulted in other phrases including “Life Cycle Warming Impact” (LCWI) and “Life Cycle Climate Performance” (LCCP). Essentially all of these methods are the same, and the basic form of the calculation can be expressed as equation (1).

$$M_{CO2eq} = \sum_i (M_{r,i} GWP_i) + M_{CO2} \quad (1)$$

where  $M$  represents the mass of substance emitted;  $M_{CO2eq}$  is the total emissions in terms of CO<sub>2</sub> equivalent,  $M_r$  is the amount of refrigerant leaked, GWP is the global warming potential of the refrigerant, and  $M_{CO2}$  the total mass of CO<sub>2</sub> emitted, typically due to energy consumption of the system according to the conditions relevant to the selected country; that is using the national emissions factor (in kgCO<sub>2</sub>/ kWh) (IPCC/TEAP, 2005).

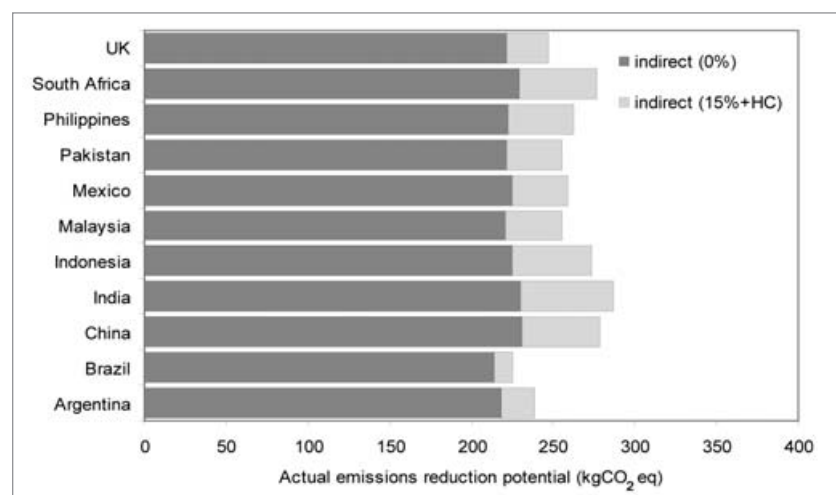

Figure 1: Actual emissions reduction potential with indirect system compared to direct system using R-404A

Figure 1 provides an indication of the potential emissions reduction when an indirect system using R-404A is used, and the additional reduction associated with using a more efficient HC or R-717 refrigerant is also shown – compared to a direct system using R-404A. The total emissions reduction is similar regardless of country and this is due to the fact that around 90% of the contribution is associated with refrigerant leakage, which is assumed to be about the same regardless of location. Brazil and Argentina produced the smallest reduction, whilst India, China and South Africa showed marginal benefits over the others, and also gained most from adopting the HC or R-717 system. (Note that the reduction potential for the UK is an overestimation since the average leak rate in northern Europe is closer to 15% than the 30% used in the model.) The additional reduction seen for the HC or R-717 system is a combination of higher efficiency and lower refrigerant GWP.

Figure 2 presents the same data, but as a percentage of the total emissions of the direct system. Here, considerable variation in relative emissions reduction is observed between the countries; for those with the greatest benefit (Brazil and Argentina), this is due to the low national emissions factor for electricity generation thereby amplifying the contribution of less refrigerant leakage. Compared to the direct system the least gain was in India, Indonesia and South Africa. Similarly, the additional benefit of using an HC or R-717 system in these countries is damped down because the more efficient system carries little weight.

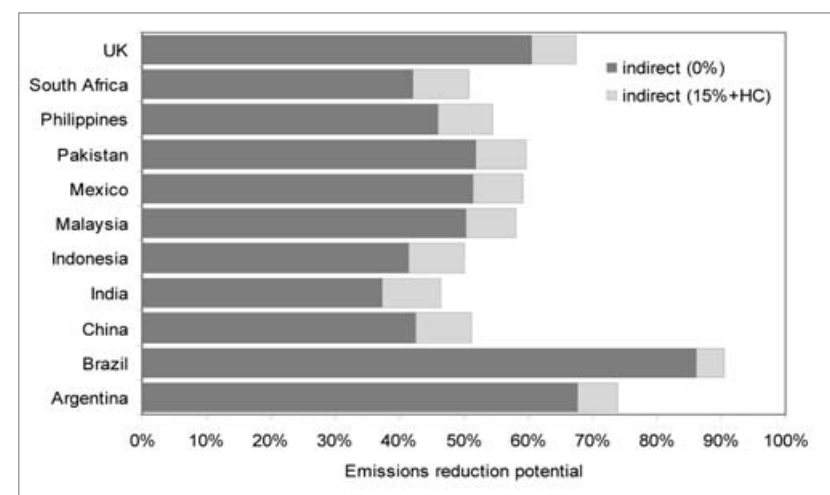

Figure 2: Emissions reduction potential of indirect systems as a proportion of direct system using R-404A

## Cost comparison

The various costs of the fixed and in-use stages for each system type were calculated for the selected countries. For this, it was necessary to establish a methodology for estimating relevant lifetime costs associated with the systems. Five main components that make up the supply of equipment and the on-going operating costs were identified and are listed in Table 2. Also indicated are the main parameters used to quantify each cost and whether they are affected by regional location of the supermarket. An example of the typical distribution of costs throughout the system lifetime is also provided, based on the UK situation.

Cost component	Quantification	Regional impact	Typical distribution (UK)
Refrigerating equipment	Capacity, type of system	Fixed	15 – 20%
Labour for installation	Capacity of system, materials	Variable	5 – 10%
Operating electricity	System power consumption	Variable	40 – 50%
Maintenance	Capacity of system	Variable	20 – 25%
Service and repairs	Capacity of system, materials	Variable	5%

Table 2: Characteristics of lifetime cost

Characterisation of the various costs was based on discussions and data provided by a number of different companies based in the UK, Scandinavia and USA. It is noted that values provided for equipment, installation, maintenance and service varied considerably – this includes as a ratio of cost per unit of cooling capacity, or in total for identical application. For example, quotations from different companies for the supply, installation and commissioning of a given supermarket refrigeration system vary in the order of up to  $\pm 20\%$ . This is a result of several factors including internal business costs, equipment purchase agreements with suppliers and profit margin confidence. As such precise cost estimation is not possible so an approximate range of values has been provided.

A summary of the determination of various cost parameters is given below. It is noted that these values apply to the refrigerating system and associated materials including electricians and do not include costs for actual display cabinets and coldstores since they are not considered to be impacted upon by the type of system.

– **Refrigerating equipment.** Based on quotations for a range of different direct expansion supermarket systems a cost of approximately €500 – 700 per kW for medium-temperature and €800 – 1000 per kW for low-temperature level was determined. In terms of indirect systems, there is a general consensus amongst these companies that there is an increased cost. In the UK and other countries this is partly a result of their inexperience with such systems, which invokes a “safety factor” in the quotation to provide cushioning in the event of unforeseen problems. Also because of the smaller number of installations, economies of scale play a part due to supply of

atypical equipment. For an indirect system the equivalent prices are €550 – 750 and €850 – 1100 for medium and low temperature levels, respectively. Given that the supply of refrigeration equipment is global, it is assumed that the equipment costs in any developing country are the same as in the UK.

- **Installation labour.** Using the data as above, an average cost of €300 – 400 per kW was determined for both direct and indirect type systems, and this applies regardless of the temperature level. Whilst the same value applies to indirect systems, it is only true for those that use conventional copper pipework; many systems now employ ABS piping that is pre-insulated and only requires glued connections in which case the installation of pipework is faster and so the labour cost can be reduced to €200 – 300 per kW. In developing countries where labour is cheaper than in northern Europe, the installation costs will be less.
- **Operating electricity.** Electricity costs are estimated as the product of the calculated operating energy requirements of a system located in a given country, and an indicative national electricity price. The price of electricity varies widely by country; for example, within Europe electricity prices range from €25 per MWh in Norway to over €100 per MWh in Austria. Prices also vary considerably amongst different companies due to variations in purchase contracts. Charges are also applied according to the maximum instantaneous power demands, but this is assumed to be the same for both direct and indirect systems.
- **Maintenance.** Supermarkets generally adopt maintenance contracts where technicians attend the site on a regular basis to carry out routine activities such as condenser cleaning, leak checking, compressor oil changes, etc. In general, a maintenance schedule would be similar for both direct and indirect systems since the same activities are applicable to both. Refrigeration contractors generally estimate maintenance contracts according to the compressor power, and for a typical supermarket this equates to around €100 – 150 per kW of cooling capacity. Given that maintenance is largely human activity, the cost estimation was adjusted for each country’s economy.
- **Service and repairs.** Servicing costs are typically one-off charges resulting from a failure of a system or component, and can involve a simple component change-over, repair of a leak and subsequent topping-up of refrigerant, or a cessation of system operation and some re-engineering in the event of an intrinsic design fault. The service costs for any supermarket system vary considerably since system reliability is a function of quality of its design and installation, as well as the quality of the system components, frequency of the routine maintenance and environmental conditions. A good indication of the annual service cost is the value of the warranty that the refrigeration contractor applies to their quotation for a given installation since it is based on their prior experience. Values vary around 1 – 3% of the original total equip-



ment cost (including cabinets and coldstores, etc). Given that this normally applies to new systems, it is probably underestimates costs for older systems that have been subject to ageing, which leads to a higher frequency of failures. Assuming that this offsets the original omission of cabinets and coldstores, an annual cost of approximately €25 – 30 per kW was obtained. Assuming that half of this is fixed as hardware costs, the remaining half attributed to labour is adjusted according to the country. Discussion with contracting companies involved with both direct and indirect systems revealed that the amount of servicing associated with indirect systems was significantly less than for conventional direct systems. This was largely due to the reduction in the amount of refrigerant piping leading to fewer leaks and subsequent minimisation of problems arising from leakage, absence of thermostatic expansion valves and less complicated control systems. The resulting service costs were estimated to be €10 – 20 per kW.

The various costs listed above were based on data for systems ranging from around 200 kW to 600 kW, and it is expected that for smaller capacities the cost per kW of cooling capacity increases. To account for the variation of costs based on UK labour, values for other countries were adjusted in proportion to the ratio of a given countries' GDP per capita to that of the UK. Finally, no discount rate has been applied to the annual operational costs.

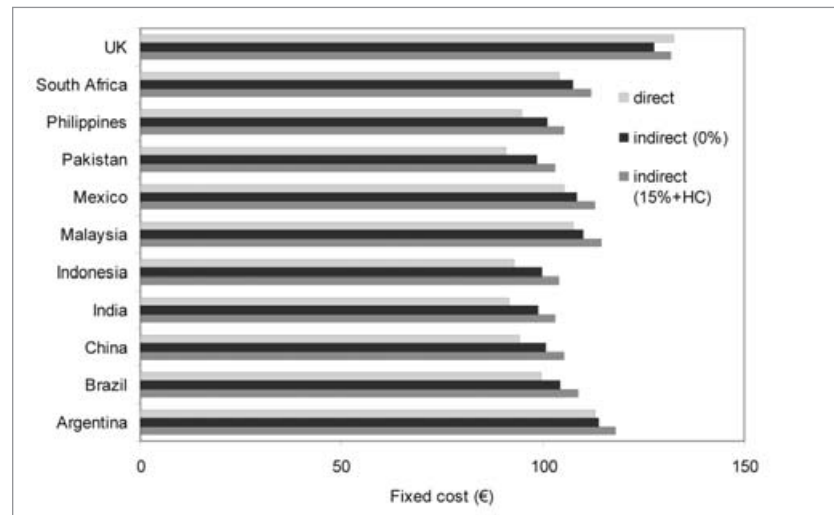

Figure 3: Fixed costs for direct, indirect and indirect (with HC or R-717) systems

Initially, the fixed – or equipment and installation – costs are presented in Figure 3. Indonesia, India and China result in the lowest costs, with Argentina, Malaysia and South Africa being the highest. In any case, they are relatively similar amongst the countries (excluding the UK), within  $\pm 20\%$  of the average. This is largely due to the costs of the equipment being the same regardless of location, when they account for the majority of the contribution. In terms of the different system types, the direct system is the cheapest in most cases but only by around 5%. The indirect system with an HC or R-717 tends to be the most expensive, but again only in the order of 10% more than the direct system. In countries where labour is costly, the difference between the systems is reduced; this is on account of the use of rapid installation time with the ABS piping.

A considerably wider variation is seen with the annual operating costs, which include electricity consumption, maintenance and servicing. Countries with lowest annual costs are Pakistan, India and China, with Malaysia and Argentina being the highest. The differences between countries is attributed to the local climate that influences energy use, but mainly because of electricity prices and labour costs – as dictated by the GDP per capita. Operational costs amongst countries vary by up to  $\pm 50\%$  of the average. In terms of the impact of system type, the direct system always suffers the highest operational costs and the HC or R-717 indirect system the lowest. This is due to the savings in electricity consumption since it makes the greatest contribution to the total. Commensurate with this, is the basic indirect system being 7% lower on average than the direct system, and 85 – 90% lower costs associated with the indirect HC or R-717 system.

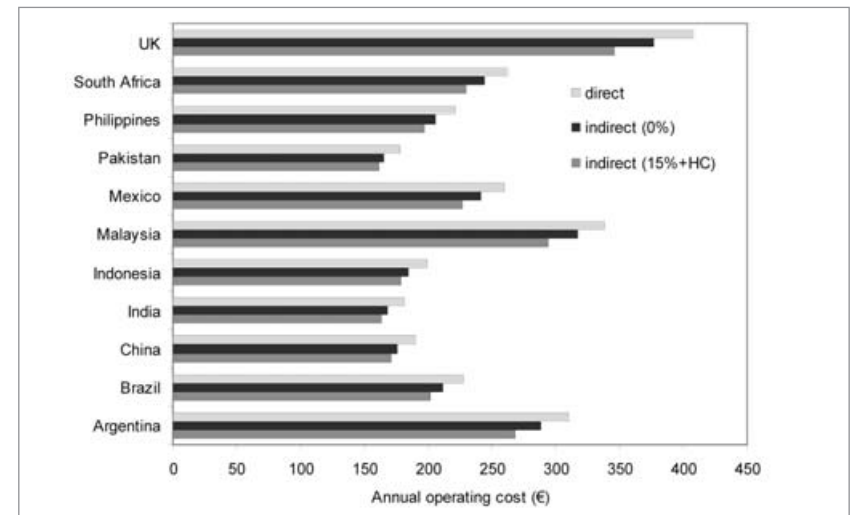

Figure 4: Annual operating costs for direct, indirect and indirect (with HC or R-717) systems

Finally, total lifetime costs for the different types of system show that the direct system tends to be slightly greater than the others, on average by about 5%. Each of the three indirect systems has very similar lifetime costs, and only in countries where electricity prices are high does the indirect HC or R-717 system offer notable reductions. Overall, total lifetime costs are highest for Argentina and Malaysia, and lowest for India, Indonesia, Pakistan and China.

---

## Concluding remarks

---

Estimation methods were used to calculate energy consumption, GHG emissions and costs associated with direct and indirect supermarket refrigerating systems for a number of different developing countries, and using the UK as a baseline. In general, the overall findings indicate that the total GHG emissions for direct systems are significantly lower than for indirect systems. This is indicated by emissions from the refrigerant ( $M_r \times GWP$ ) and emissions from electricity production ( $M_{CO_2}$ ) being much lower for the proposed indirect system. These observations are consistent with the studies of You (2001), Faramarzi and Walker (2004), and Jesper and Soren (1996), all of which showed a significant reduction in TEWI for the indirect systems. The discussion on the operation of indirect systems identified some key reasons for why indirect systems lead to lower emissions:

- Smaller refrigerant charge means less potential leaked refrigerant
- Factor sealed and tested compact system has lower leak rate
- Use of HC refrigerant or R-717 with low GWP means less impact from refrigerant emissions
- Lower leak rate means less degradation in compression system COP
- Avoidance of electric defrost requires less electricity usage
- Large thermal inertia of secondary fluid reduces cycling losses and less electricity usage

Based on a single set of generic application characteristics, the calculation results revealed a number of observations:

- Absolute emissions reduction was similar for all countries, and this was due to the dominant aspect being the decreased contribution from refrigerant leakage. Brazil and Argentina produced the smallest reduction and the additional benefit of using a more efficient HC or R-717 system was minor. India, China and South Africa showed marginal benefits over the others, and also gained most from adopting the HC or R-717 system.
- Costs of supplying a system varied little between countries and type of system. However, the operational costs including electricity use, maintenance and service

differed widely due to local electricity prices and labour costs. Overall, total lifetime costs are highest for Argentina and Malaysia, and lowest for India, Indonesia, Pakistan and China.

Some important conditions must be applied to these findings. Equipment, labour and electricity prices are subject to wide variations within any single country, meaning that further consideration should be given to what the actual costs could be. Also, the efficiency of indirect systems is known to differ amongst particular design characteristics, so it is important to ensure that any application is subject to the appropriate design assessments to ensure efficiency is optimised. In any case, many of the assumptions used in the calculations were conservative, i.e. that favour direct systems.

---

## References

---

- Arias, J. Energy usage in supermarkets – modelling and field measurements. Royal Institute of Technology (KTH), Stockholm, Sweden. 2005.
- Faramarzi, R. T., Walker, D. H. Investigation of secondary loop supermarket refrigeration systems. Foster-Millier Inc./California Energy Commission, USA. March 2004.
- IPCC (Intergovernmental Panel on Climate Change)/TEAP (Technology and Economic Assessment Panel). Special Report on Safeguarding the Ozone Layer and the Global Climate System: Issues related to Hydrofluorocarbons and Perfluorocarbons. Cambridge University Press, Cambridge, UK. 2005.
- Jesper, N., Soren, L. Indirect Cooling with Ammonia in Supermarkets. Proc. IIF/IIR Conf., Aarhus, Denmark. 1996.
- UNEP. Report of the refrigeration, air conditioning and heat pumps committee. United Nations Environment Programme, Ozone Secretariat, Nairobi, Kenya, 2006.
- UNEP Report of the Task Force on HCFC Issues. Response to Decision XVIII/12 (with Particular Focus on the Impact of the Clean Development Mechanism) and Emissions Reduction Benefits Arising From Earlier HCFC Phase-Out and Other Practical Measures. UNEP TEAP. Nairobi, 2007.
- You, Y. Investigation of deep-freeze refrigeration systems in supermarket application. Royal Institute of Technology (KTH), Stockholm, Sweden. March 2001.

# Use of Hydrocarbons as Working Fluids in Heat Pumps and Refrigeration Equipment

PROF. DR. JOSÉ M. CORBERÁN, Universidad Politécnica de Valencia,  
Instituto de Ingeniería Energética, Spain

---

## Introduction

---

Historically, hydrocarbons (HCs) were among the first fluids to be employed as refrigerant, but due to their flammability their use was abandoned in favour of inert fluids such as chlorofluorocarbons (CFCs). Propane (R290) and several other HCs have been recently commercialised and clearly demonstrated as alternative refrigerants for refrigeration and heat pump and A/C applications. Compared with CFCs, HCFCs, and HFCs, HC refrigerants offer zero ODP and extremely low GWP and, in regard to their performance, they offer in general: high efficiency, reduced charge levels, and lower compressor discharge temperatures thus they are excellent for heat pump applications. Additionally, from the technological point of view, they offer good miscibility with mineral oils (synthetic lubricants are not required) and compatibility with the materials: metals and elastomers, which are traditionally employed in refrigeration equipment. The only real factor against application of HC refrigerants in refrigeration and air conditioning equipment is the safety concern in handling relatively large amounts of flammable fluids. Fortunately, a series of amendments to the international standards concerning refrigeration and heat pump equipment is almost ready, providing for the necessary additional safety measures for the design, repair and servicing of equipment using flammable refrigerants.

---

## Compatibility with materials

---

HCs are compatible with most of the materials traditionally employed in refrigeration and heat pump equipment.

### Compatibility with plastics

Virtually all common elastomer and plastic refrigeration materials used as 'O' rings, seats of valves, elastic seals, gaskets, etc, are compatible with HC refrigerants. Neo-

prenes<sup>1</sup>, Vitons, Nitriles, Nylon, HNBR and PTFE are included. Materials that are not compatible with HCs are PMMAs, EPDM, natural rubbers and silicone rubbers. The effect of refrigerants on a plastic should be deeply examined under the intended use conditions. The compatibility of the selected refrigerants for this study can be seen in Table 1.

Material		R600	R600a	R290	R1270	R22
Akrylnitrile butadiene styrene	ABS	A	A	S	S	NR
Cellulose acetate	CAB	*	*	A	S	*
Butyrate	EP	E	E	E	S	S
Epoxy	ETFE	*	*	S	*	A
Ethyltetrafluoroethylene	PA	*	*	S	S	S
Polyamide	PC	NR	NR	A	S	S
Polycarbonate	PE	S	S	S	A	A
Polyethylene	PETP	S	S	S	*	S
Polyethylene terephthalate	POM	S	S	S	S	A
Polyoxymethylene/ Acetal	PP	S	S	S	S	A
Polypropylene	PPO	A	A	NR	*	*
Polyphenyloxide	PPS	S	S	S	A	A
Polyphenylsulphide	PS	S	S	S	S	NR
Polystyrene	PUR	S	S	A	S	*
Polyurethane	PVC	A	A	S	A	A
Polyvinyl chloride	PVDF	S	S	S	S	A
Polyvinylfluoride	SUF	S	S	S	S	NR
Polysulfone	UP	*	*	S	*	S
Unsaturated Polyester	PTFE	S	S	S	S	A
Polytetrafluoroethylene	PCTFE	S	S	S	S	A,sw
Polychlorotrifluoroethylene	NBR	S	S	NR	S	NR
Nitrile Rubber	IIR	NR	S	NR	NR	A,sw
Buthyl (isobutene-soprene) rubber	CR	S	NR	NR	NR	A,sw
Chloroprene	Q	NR	NR	NR	NR	NR
Silicon	ABS	A	A	S	S	NR

Table 1: Refrigerants compatibility: plastics

S: satisfactory; NR: not recommended; A: acceptable; sw: strong swelling; \*: no data available

### Compatibility with lubricating oils

In order to assure reliable operation of compressors, identification of the optimum lubricant is needed. For heat pump and refrigeration equipment it is desirable to have good solubility of the refrigerant in the lubricant so as to assure efficient oil return rate and to avoid heat transfer degradation. Furthermore, it is important that the viscosity of the mixture is adequate for the hydrodynamic lubrication of compressor bearings. Dissolved lubricant in liquid refrigerant affects the thermodynamic properties of the working fluid. The vapour pressures of refrigerant-lubricant solutions at a given temperature are always lower than the vapour pressure of pure refrigerants at that temperature. Therefore, dissolved lubricant in an evaporator leads to slightly lower suction pressures.

HCs are non-polar substances of the same structure as mineral oils (MO). Therefore, HCs have a very high solubility in mineral oils. This property is of course desirable

<sup>1</sup> However, neoprene/chloroprene is not at all compatible with propylene (R1270).

for the oil return rate. However, this can lead to a decrease of the lubricant viscosity in the compressor, especially at low oil temperatures and high pressures. This is the reason why it is generally recommended to employ oil with a bit higher viscosity for HCs. New generation refrigerants, in some instances, are more dependent on the correct application and type of refrigerant oil. Particular care should therefore be taken to ensure that the replacement refrigerant and compressor manufacturers' requirements are satisfied and conversion procedures (if necessary) are adopted, especially for drop-in applications. Lubricants now in use and being considered for new refrigerants include mineral oils (MO), alkyl benzene (AB), poly-alpha-olefin (PAO), polyolester (POE), poly vinyl-ether (PVE), poly alkylene-glycol (PAG) and hydro-treated mineral oils. Lubricants containing silicone and silicate (additives used as anti-foaming agents) may not be compatible with new generation refrigerants. Compatibility of lubricants with new generation refrigerants is as in Table 2.

Traditional lubricants	Hydrocarbons	Ammonia, CO <sub>2</sub> & Propene	HFCs	R22
Mineral oil (MO)	Good suitability <sup>1</sup>	Good suitability	Limited application	Good suitability
Alkyl benzene (AB)	Good suitability <sup>1</sup>	Limited application	Good suitability	?
Mineral oil (MO)+ Alkyl benzene (AB)	Good suitability <sup>1</sup>	Limited application	Limited application	?
Poly alpha olefin (PAO)	Good suitability <sup>1</sup>	Limited application <sup>3</sup>		?
New lubricants				
Polyol ester (POE)	Good suitability <sup>1</sup>	Not suitable	Good suitability	?
Poly vinyl ether	Not suitable	Not suitable	Good suitability	?
Poly alkylene glycol (PAG)	Limited application <sup>2</sup>	Limited application <sup>2</sup>	Good suitability	?
Hydro treated mineral oil	Not suitable	Good suitability <sup>1</sup>		?

Table 2: Compatibility with refrigerant

<sup>1</sup> denote lubricant possibly requiring basic viscosity correction.

<sup>2</sup> denote lubricant that is especially critical with moisture.

<sup>3</sup> PAO lubricants are not miscible with ammonia, but ammonia systems use flooded type evaporators where the immiscible lubricants can be readily returned back to the compressor, by draining from the bottom of the evaporator.

In summary, HCs are compatible with almost all existing lubricants and construction materials used in heat pumps. They do not form acids when in contact with moisture present in the refrigeration system. Therefore propane is a very suitable drop-in substitute of R22 since it also can operate with a mineral oil. However, given that the solubility of propane in oils is in general higher than that of R22, the use of a higher viscosity oil is recommended with propane in order to ensure adequate compressor lubrication. Additionally, the fact that propane can work with the same kind of oil than R22 makes unnecessary any kind of cleaning procedure to eliminate the old oil traces, which in contrast, it is necessary when the type of oil is changed when a R22 system is retrofitted into a HFC substitute.

## Thermodynamic properties

This section presents a comparison of thermodynamic properties between R22 with HC refrigerants. Propane (R290), Butane (R600), Isobutane (R600a) and Propene (R1270) have been selected for the comparison since they are the ones with better properties as refrigerants. Table 3 shows the normal boiling, critical points and vapour density of the considered fluids.

Refrigerant	R290 Propane	R1270 Propene	R600 Butane	R600a Isobutane	R22
Normal boiling point (°C)	-42.1	-32.09	-0.90	-11.7	-40.8
Latent heat of vaporisation (kJ/kg)	425.6	475.2	385.24	366.2	233.95
Critical Temperature (°C)	96.8	124.8	152.0	135.0	96.2
Critical Pressure (bar)	42.5	55.4	38.0	36.5	49.9
Vapour density at return temperature 10 °C with 8K superheat (kg/m <sup>3</sup> )	10.57	12.55	2.87	4.40	21.74

Table 3: Normal boiling and critical points

### Normal boiling point

This refers to the boiling temperature at atmospheric pressure, and indicates a high pressure at high temperatures if the fluid has a low normal boiling point and vice versa. On the other hand, a fluid with a high normal boiling point could consequently cause pressures within the system below the atmospheric at evaporator temperatures below the normal boiling point<sup>2</sup>, being prone to air input into the system, which is always an undesired situation since the incoming air and especially accompanying humidity will lead to operation problems. The normal boiling point of R290, R1270 and R22 are very similar, thus both, R290 and R1270 are good replacements for R22.

### Critical point

The critical point parameters: temperature and pressure, determine the maximum bound to operate a refrigeration cycle with condensation. Temperature and pressure above the critical point require a transcritical cycle. As can be observed in Table 3, both R22 and propane have a very similar critical point, again indicating that their operating thermodynamic cycles are quite similar.

### Saturation pressure

Figure 1 shows the saturation pressure – temperature curves for the studied HCs and R22. Butane has the lowest pressure due to its higher normal boiling point, being followed by Isobutane, propane and R22. As can be observed in the figure, R22 and pro-

pane are very similar except at high pressures where they slightly diverge. Propane would require lower working pressures than R22 for the same source temperatures. This difference can be significant at high condensation temperatures, meaning that R290 is more suitable for high temperatures than R22. Higher operation pressures lead to higher mechanical requirements and higher leak rates.

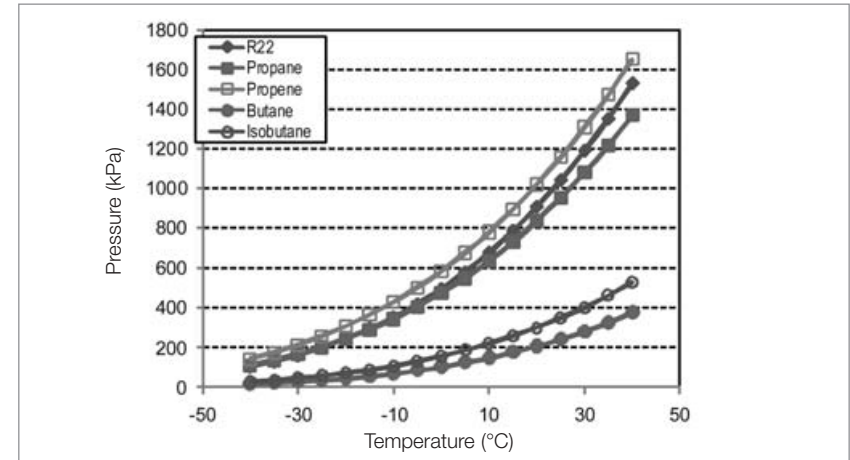

Figure 1: Saturation vapour pressures for R22 and hydrocarbons

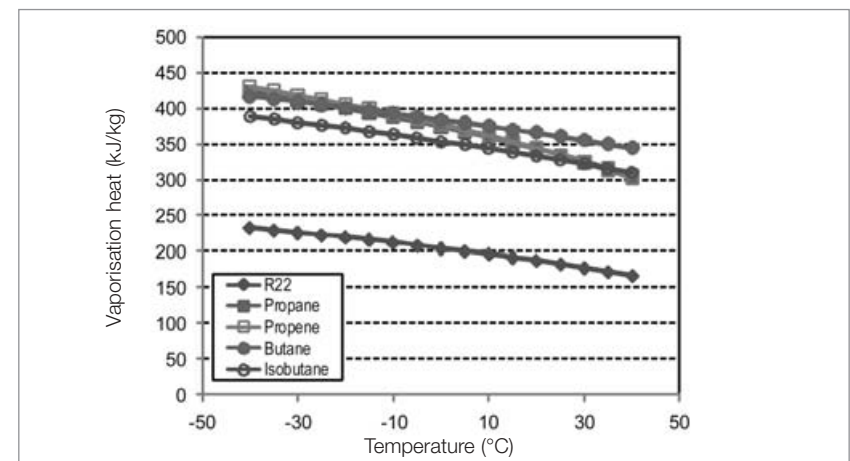

Figure 2: Vaporisation heat of R22 and hydrocarbons

<sup>2</sup> This could be the case for butane or even isobutane when used in low temperature applications.

## Latent heat of vaporisation

The latent heat of vaporisation is the difference in enthalpy between the saturated vapour and saturated liquid at a given pressure. This value determines the available heat of condensation or vaporisation per kg of fluid. This can be used to estimate the refrigerant mass flow rate which is required to produce a given refrigeration (or heating) capacity.

Figure 2 shows the Heat of vaporisation of the considered fluids. As can be observed in the figure, HCs have around two times the latent heat of R22. This indicates that the mass flow rate circulating through the refrigeration system with a HC refrigerant, required to provide a given heating/cooling capacity, will be always around half of the one required for a system working with R22.

## Density

Figure 3 shows the liquid density of R22 and the considered HCs. As can be observed in this figure, the liquid density of HCs is roughly about half of that of R22 (propane has 41% lower density than R22). This means that the required charge of HC for a system will be round about half of the one required with R22 since most of the charge is in liquid form in the equipment. The ratio between the liquid densities of the HC and R22, can be used as a rule of thumb to estimate the reduction in charge when a R22 system is retrofitted to a HC refrigerant.

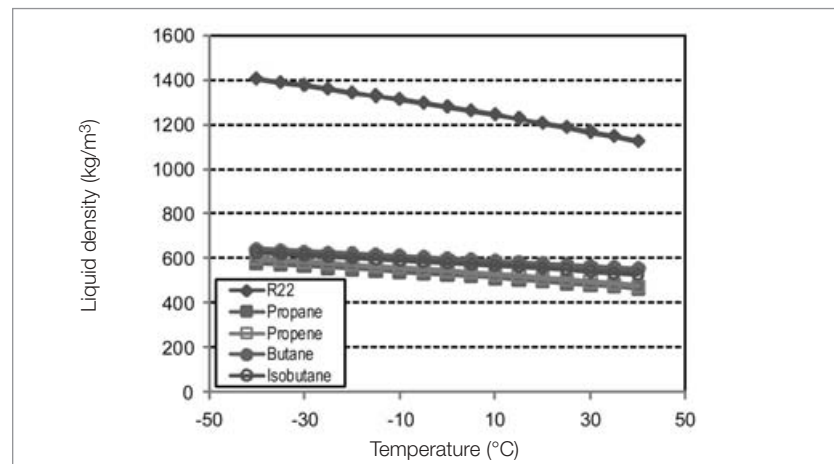

Figure 3: Liquid density of R22 and hydrocarbons

On the other hand, Table 3 shows the value of the density of the vapour at the inlet of the compressor at 10 °C return (suction) temperature (this temperature is typical for instance of a chiller producing 7 °C water for A/C) for the involved fluids. The mass flow rate of refrigerant pumped by a compressor is the product of the compressor speed, the volumetric displacement, the volumetric efficiency and the density of the vapour at the inlet of the compressor. Assuming that the volumetric efficiency of a compressor is quite independent of the refrigerant, then the mass flow rate pumped by a R22 compressor when it is retrofitted to a HC becomes proportional to the vapour density ratio. For instance, for the case of propane the mass flow rate pumped by a given compressor tends to be a fraction (around 1/2) of the one corresponding to R22, due to its much lower density, although this is in some way compensated by the almost double value of the vaporization enthalpy characteristic of HCs when compared with R22. In the end, that makes the refrigeration capacity reduction only around 15% when a R22 system is retrofitted to a HC.

The lower density of HCs is also important on other aspects of the refrigeration unit, for instance, pressure drop through heat exchangers, pipes, and valves will be in general proportionally lower. It is also relevant when dealing with two-phase heat transfer phenomena. A low density is in general advantageous.

## Cycle and component performance

This section presents a comparison of the refrigeration cycle and the performance between R22 with HC refrigerants.

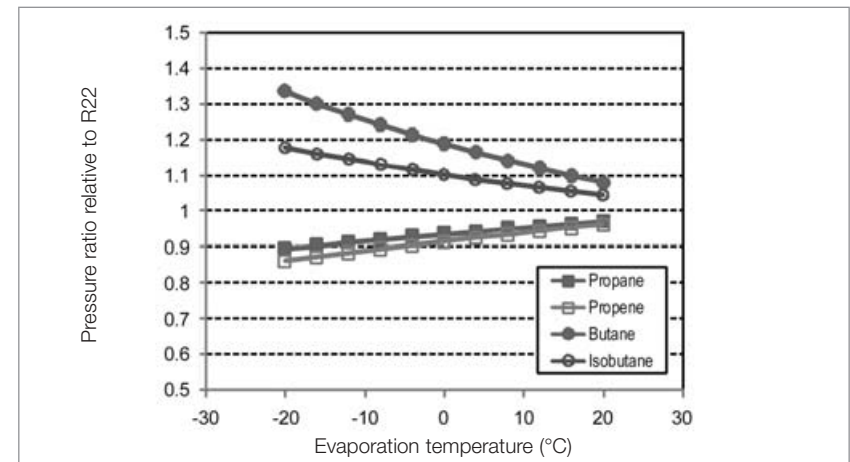

Figure 4: Pressure ratio relative to R22 vs. evaporation temperature at 40°C condensation temperature vs. evaporation temperature

## Pressure ratio

Another important property is the ratio between condensing and evaporating pressures. The pressure ratio strongly influences the compressor efficiency (energy demand) and its volumetric efficiency. The lower is the pressure ratio the better are the efficiencies. Figure 4 shows the pressure ratios of HCs relative to the pressure ratio of R22, based on a  $40^{\circ}\Delta C$  condensing temperature cycle. As can be observed in the figure, pressure ratios for R290 are lower for propane than for R22, being for the others higher than that for R22.

Additionally, as commented above, the working pressures for propane are lower than the ones for R22. That means that propane is advantageous to substitute R22 in drop-in applications for refrigeration, A/C and especially for Heat Pumps since R290 will work at lower condensation pressures and lower pressure ratios. A system originally designed for R22 could be used with Propane and reach condensation temperatures for which R22 is no longer valid (above  $60^{\circ}C$ ). This is a very positive feature for space heating and also for A/C at high ambient temperatures applications.

## Volumetric cooling capacity

This parameter is a measure of the cooling capacity per unit volume of refrigerant passing through the compressor. It governs the expected cooling capacity with a certain compressor displacement and clearance volume. The volumetric cooling capacity is a property of the refrigerant and of the operation point and can be evaluated by the product of the suction density and the specific enthalpy difference across the evaporator. This property may be defined as the available heat absorbed per unit of refrigerant volume. Figure 5 shows the variation of the volumetric cooling capacity with the evap-

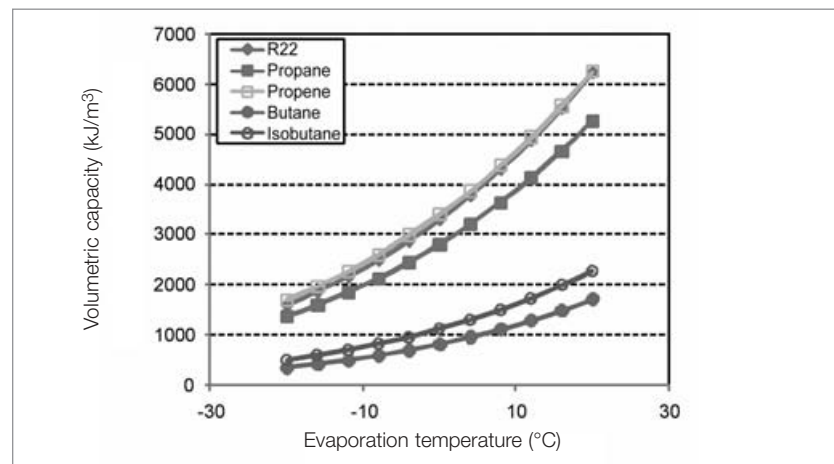

Figure 5: Volumetric cooling capacity vs. evaporation temperature, at  $40^{\circ}C$  condensation temperature, 0 K sub-cooling and 5 K superheat

oration temperature, at given condensation conditions and 5K superheat at the compressor inlet. As can be seen, the volumetric cooling capacity rapidly decreases when the evaporation temperature goes down, mainly due to the decrease in density of saturated vapour at the lowest temperatures. This refrigerant feature imposes the necessary size of compressors. From figure 5, it is easily understood why the size of compressors for low temperature applications must be much larger than the required for high temperature.

As can be observed, the compressors required for HCs will always be larger than the required for R22 except propane; propane is quite similar to R22, having just a slightly lower volumetric capacity. Therefore, R22 systems directly retrofitted to propane will always have slightly lower refrigeration or heating capacity.

## Volumetric energy consumption

It is also of great interest to compare the (isentropic) power required by the compressor per unit of suction volume flow into the compressor. Thus, the volumetric energy consumption is the product of the suction vapour density and the change in specific enthalpy for the compression process. Figure 6 shows the values of this parameter for the investigated HCs relative to R22. Propene requires slightly higher compression work per flow rate unit, but all the other HCs present lower volumetric energy consumption. Propane requires among 10 to 20% lower energy consumption than R22 per unit of refrigerant flow rate. This fact also implies that when a R22 system is directly retrofitted to propane the electric motor would work at a slightly lower load, and therefore the motor could become slightly oversized.

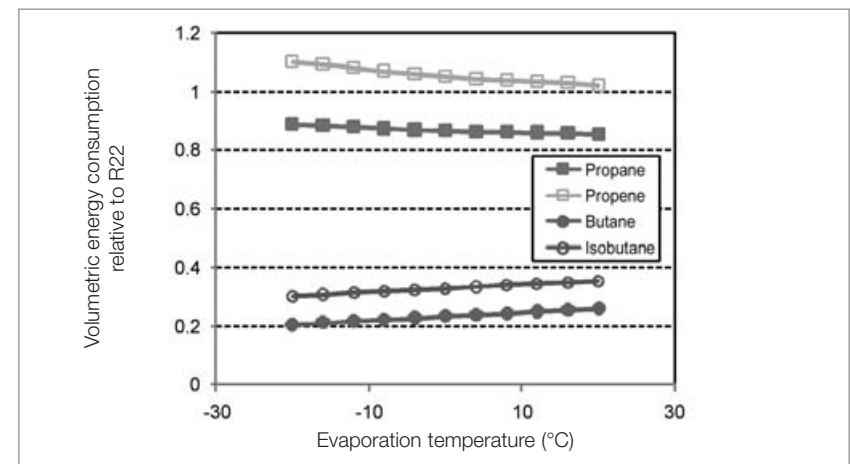

Figure 6: Volumetric energy consumption relative to R22 vs. evaporation temperature, at  $40^{\circ}C$  condensation temperature, 0 K sub-cooling and 5 K superheat

## Volumetric and compressor efficiency

Experimental results indicate slightly higher volumetric efficiency, maximum 5 %, for propane than for R22. The main reason for this difference is probably the lower pressure drop, characteristic of propane in regard to R22, reducing pressure losses through the compressor valves. This trend can also be true for other HCs. The compressor efficiency, which includes all compressor irreversibilities, also offers slightly higher values for propane than for R22 at the same pressure ratio, around 2%. Again, the lower pressure loss through the valves could be the main explanation for the improvement. Additionally, HCs normally work at lower pressure ratios than R22 at the same operating condition so that the compressor efficiency advantage is in practice higher than mentioned.

## Subcooling

A certain fraction of the refrigerant mass turns into vapour phase in the expansion device. This portion is given by the quality ( $x$ ) of the mixture, being the vapour unable to contribute with any refrigerating effect. The remaining liquid ( $1-x$ ) is used to produce the refrigerating capacity in the evaporator. An improvement of the cycle can be always achieved by sub-cooling the liquid prior to the inlet of the expansion valve. The volumetric refrigerating effect clearly increases with sub-cooling since the enthalpy at the inlet of the evaporator decreases. On the other hand, the volumetric energy consumption is not influenced. Therefore, if the sub-cooling is increased the COP will always increase. Figure 7 shows the influence of the sub-cooling on the COP. As has been said the influence is always positive. The slope of the increase of COP with sub-

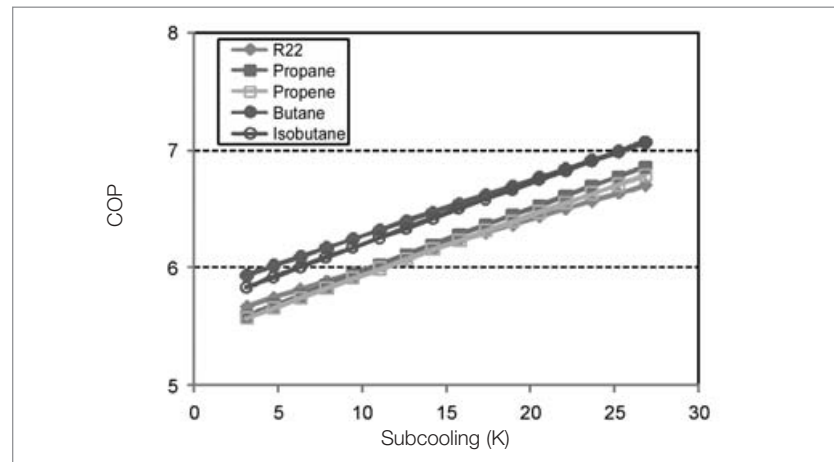

Figure 7: Influence of sub-cooling on COP, at 40°C condensation temperature, 0 °C evaporation temperature and 5 K superheat

cooling is a property of the refrigerant. As can be observed in figure 7, HCs have a slope higher than R22, especially propane. This means that propane will benefit more from an increase in sub-cooling than R22.

## Superheat

In an actual cycle it is required that vapour reaches the compressor with a certain superheat so that refrigerant liquid can never reach the compressor cylinder. On the other hand if a thermostatic or electronic expansion valve is employed, a minimum superheat is also required as to be able to sense changes in the temperature and adequately metering the refrigerant mass flow rate. Superheat can either occur inside the evaporator (internal superheat) or outside the evaporator, on the way of the refrigerant from the outlet of the evaporator to the inlet of the compressor (external superheat). Internal superheat implies a certain increase in refrigerant effect, but also an increase on the specific volume at the inlet of the compressor so that the volumetric capacity and volumetric energy consumption are affected. Figure 8 shows the influence of internal superheat on the  $COP_{\text{refrigeration}}$  for the studied refrigerant fluids. As can be observed in figure 8, HCs have a positive slope while R22 has a negative slope, meaning that HCs benefit from the increase of the internal superheat in strong contrast with R22. In practice the increase of the internal superheat inside the evaporator requires a decrease in the evaporation temperature (since increasing the internal superheat requires more area and therefore the area available for the evaporation decreases) so that in the end the increase of the internal superheat could not lead to an increase in COP. In any case figure 8 shows that R22 is more negatively affected from

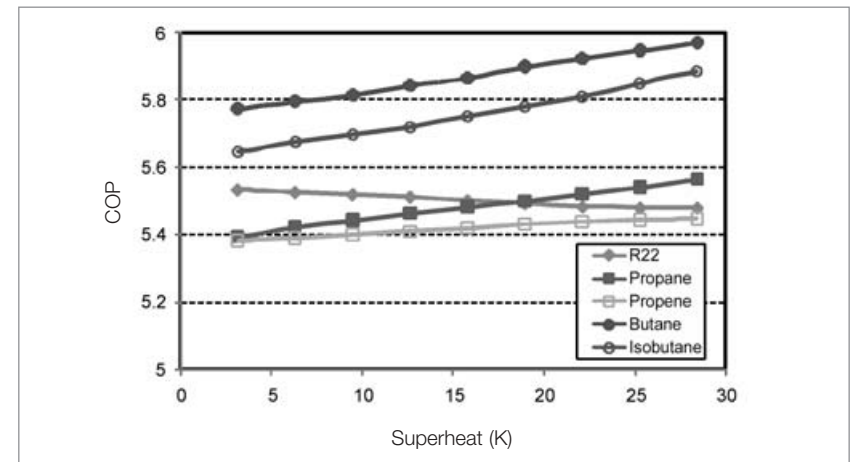

Figure 8: Influence of the internal super-heat on the COP, at 40°C condensation temperature, 0 °C evaporation temperature and 0 K sub-cooling



superheat than HCs. On the other hand, external vapour superheat is always negative and detrimental to the volumetric refrigerating effect and to the coefficient of performance.

Given the feature of HCs of paying a lower penalty from an increase of superheat, the use of an internal heat exchanger between the suction and the liquid lines is recommended leading to both an increase on capacity and an increase on COP. In any case the use of this kind of device produces for all refrigerants some secondary negative additional effects, as for instance their pressure drop, which, in practice makes the COP improvement advantage low, in comparison with the required cost increase. Anyhow, the main conclusion remains valid and in those applications, in which the use of a liquid to suction heat exchanger is beneficial, the benefit will be greater with HCs.

### Discharge temperature

The discharge temperature is a limiting factor, since the pressure ratio that can be achieved in a single compression stage cycle depends on it. It might be critical due to its influence on the refrigerant stability as well as oil and other materials. This fact also affects to the compressor mean life, since it could significantly reduce the possible failure of the lubrication leading to the deterioration of compressor performance and even to its failure.

Figure 9 shows the discharge temperature versus the evaporation temperature. As it can be observed in the figure, propane has considerably lower discharge temperatures than R22, thus, allowing working at higher condensation temperatures as well as higher temperature lifts in one-stage systems. Due to the favourable temperature behaviour

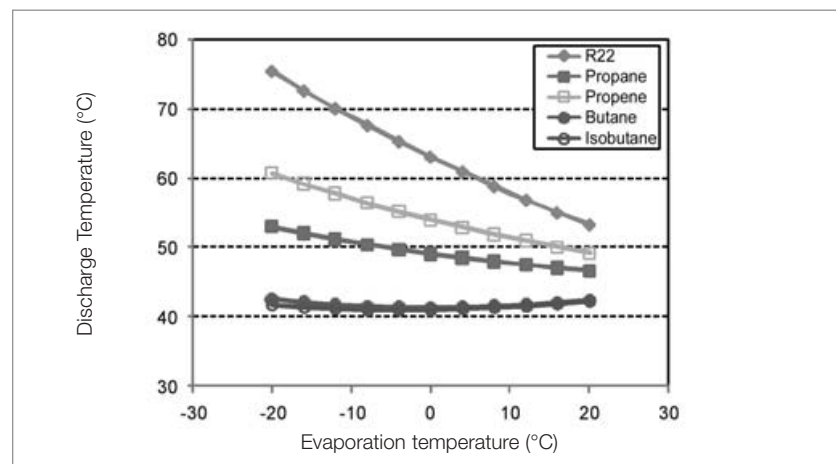

Figure 9: Discharge temperature vs. evaporation temperature, at 40°C condensation temperature, 0 K sub-cooling and 5 K superheat

of HCs, single stage compressors can also be used down to quite low temperatures as -40 °C evaporation temperature. R290 could be directly employed also as substitute for R502 and some HFC blends as R404A.

### Heat transfer coefficient

There is common agreement in that the heat transfer coefficient of propane at the evaporator is higher than the R22 one. Values from 5 to 10% (even 20%) are frequently found. Besides, in regard to the condenser, the heat transfer coefficients seem to be quite similar. Both trends, slightly lower or little higher, have been reported.

One must take into account that those conclusions are strongly dependent on the heat exchanger geometry and also on the conditions in which the comparison is established. Most of the studies (drop-in cases) use the same compressor, so the mass flow rate, saturation temperature, and temperature difference with the secondary fluid, and therefore the heat flux, are not the same. Other studies perform the comparison at the same mass velocity and saturation temperature, but then these conditions are not going to happen in practice when one compare similar equipment using propane and R22. Oil influence makes the comparison more difficult.

### Pressure drop

As regards to the pressure drop, propane, and in general HCs, produce lower pressure drop along both the evaporator and condenser. This difference is of course more significant at the evaporator due to its characteristic higher pressure drop.

In terms of piping, R22 pipe dimensions seem perfectly adequate for propane. In principle a bit smaller diameters and therefore smaller auxiliary components could be employed without any deterioration of performance. Butane and isobutane may require larger tubing diameter due to their required higher flow rates.

### Coefficient of performance, COP

In a refrigeration cycle, work is consumed in order to accomplish a refrigerating, or heating, effect. The ratio of the desired refrigerating (cooling), or heating effect, to the required compressor work is called the coefficient of performance COP:

$$COP_{\text{refrigeration}} = \frac{Q_{\text{evaporator}}}{W} \quad \text{for the refrigerating cycle, and}$$

$$COP_{\text{heat pump}} = \frac{Q_{\text{condenser}}}{W} \quad \text{for the heat pump cycle.}$$

Neglecting the heat transferred between the compressor and the environment, which typically is very small in amount, it can be easily demonstrated that  $COP_{\text{heat pump}} = COP_{\text{refrigeration}} + 1$ . Also there is a relationship between the  $COP_{\text{refrigeration}}$  and the two previously introduced parameters: that is the ratio of volumetric capacity and volumetric energy consumption.

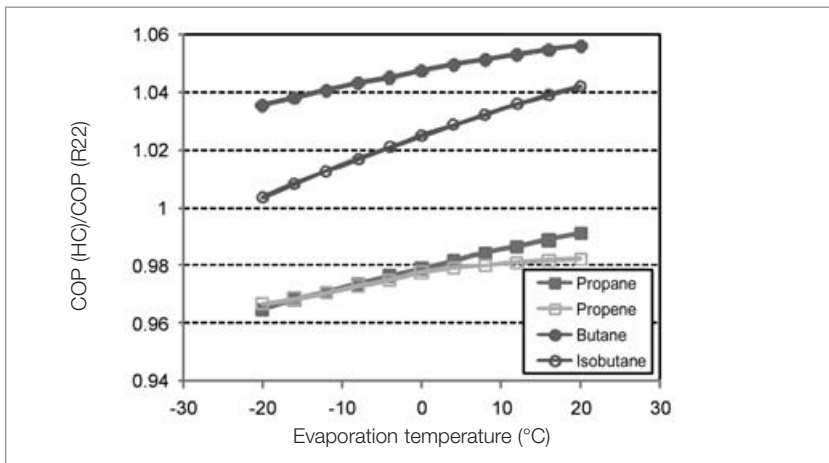

Figure 10: Coefficient of performance relative to R22 vs. evaporation temperature, at 40°C condensation temperature, 0 K sub-cooling and 5 K superheat

As can be observed in figure 10, Butane and Iso-Butane show slightly higher COP values than R22, whereas Propane and Propene show slightly lower values, ranging from -2.5 % at low evaporation temperatures to -1 % at higher ones. In any case, the differences are small. However, in practical terms, there is general agreement in that R290 can provide around 5% higher efficiency than the R22 baseline systems on drop-in transformations.

The main reasons for this improvement are the higher compressor efficiency mainly due to the lower working pressure ratio and the higher heat transfer coefficients, mainly at the evaporator. Higher efficiencies can be found if the design is optimised for the use of propane (values of around 10% and higher have been reported). This conclusion is similar for propylene.

### Cooling/heating capacity

The much lower density of hydrocarbons compared with R22 makes that the refrigerant mass flow rate tended to be much lower with hydrocarbons. Propane and propylene tend to have a mass flow rate of the order of half of the R22 one. At the same time they almost offer double heat of vaporisation per kg of refrigerant. That makes that the capacity of hydrocarbon units employing the same compressor as the one employed with HCFCs or HFCs tend to reach similar capacities, maybe a bit lower for propane (10%). Butane and isobutane have much lower densities while the heat of vaporisation is not so high, thus they require a considerably higher compressor displacement to reach a similar capacity.

### Expansion device

Non variable expansion devices must be redesigned for HCs since the fluid properties, and also the pressure ratio between the high side pressure and the low side pressure, change when a system is used with propane. Therefore the metering role that the expansion device has to play makes necessary its redesign. This applies to short orifices or capillary tubes. Variable expansion devices as thermostatic or electronic valves are able to adjust the superheat at the outlet of the evaporator. The saturation pressure curve of propane is not very different from the one for R22. This makes that equipment including a R22 thermostatic or electronic expansion valve is able to operate with propane without any major change, just requiring an adjustment of the setting of the valve. In any case, a better metering can be of course found by using specific components. Electronic valves can load any saturation curve and nowadays the manufacturers of such devices are able to implement the correct curve for HCs so they are perfectly suited for their use with HCs.

# Conversion of Various HCFC-22 Systems to Hydrocarbon

PROF. DR. ARYADI SUWONO, Bandung Institute of Technology, Indonesia

---

## Introduction

---

The use of hydrochlorofluorocarbon (HCFC) refrigerant for future application is limited other than by its Ozone Depleting Potential also by relatively high Global Warming Potential. Hydrocarbon refrigerant such as propane may be used as the alternative substitutes because of the similarity of their saturation pressures. Based on studies in our laboratory /1-4/ and experience of other investigators /5-7/, that its saturation pressure is very close to that of HCFC 22, and due its compatibility to most materials used in the refrigeration system, propane can be a direct substitute for the refrigerant conversion with only a minor change in the components of refrigeration systems. These minor changes are needed to comply with safety standards with regard to the flammable nature of HC refrigerants /8/. In this paper several evaluation results of conversion the existing HCFC-22 systems with propane refrigerant (R-290) were reported. The converted systems consists of window type air conditioners (AC), milk cooling units, split type AC, and a central chiller AC system.

The objectives of the evaluation are mainly:

- to find out the performance of the refrigeration system formerly running with HCFC 22 after converted to R-290,
- to find out long term characteristics of the refrigeration systems after they have been converted to R-290,
- to demonstrate the application of hydrocarbon refrigerants in Indonesia.



Figure 1: Milk cooling unit

## Conversion of refrigeration systems of milk cooling units

Milk is collected from small farmers twice daily by the Cooperative. Milk needs to be cooled to about 4°C before it's further transported to processing factory. Figure 1 shows a typical cooling system used in the Cooperative. It consists of a milk tank cooled by the vapour compression system of refrigeration as shown schematically in Figure 2. Following the successful conversion of CFC 12 done previously, some other milk cooling units which mostly used HCFC 22 were converted to HC.

Table 1 shows the performance data of two milks coolers which were converted. Both systems use semi hermetic compressor chillers, located at Cooperative in Tanjungsari and Cikajang West Java. It can be seen that the electric current of the compressor is lower after the system retrofitted with R-290, and that cooling capacities improve, indicated by the shorter operating time.

Establishment	TANJUNG SARI		CIKAJANG	
	Retrofitting Date	30 <sup>th</sup> October, 1997		20 <sup>th</sup> November, 1997
Refrigeration System	2°C Water Chillers		2°C Water Chillers	
Electric Voltage	3 phase, 380 V, 50 Hz		3 phase, 380 V, 50 Hz	
Refrigerant	R-22 (HCFC)	R-290 (HC)	R-22 (HCFC)	R-290 (HC)
Electric Current	2 × 18 A	2 × 15 A	2 × 25 A	2 × 18 A
Operating Time	13 hr	10 hr	14 hr	12 hr
Discharge Pressure	15.5 bar (g)	12.4 bar (g)	15.5 bar (g)	12.8 bar (g)
Suction Pressure	1.7 bar (g)	1.7 bar (g)	1.4 bar (g)	1.4 bar (g)
Daily Energy consumption	440 kWh/day	287 kWh/day	N/A	N/A
Daily Milk Capacity	12 tonnes/day	12 tonnes/day	19 tonnes/day	19 tonnes/day

Table 1: Performance comparison of milk cooling units before and after conversion to propane

With a similar suction pressure (which indicates a similar cooling temperature) the discharge pressure is lower. The power consumption of R-290 is significantly lower than the HCFC 22 system. After this successful conversion to HC, many other milk cooling units have also been converted to HC. Table 3 shows the results of monitoring of three other selective units.

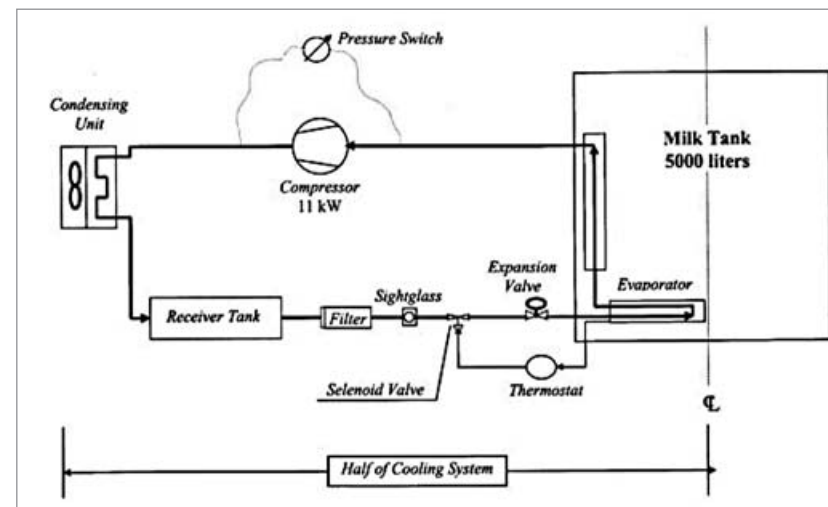

Figure 2: Refrigeration system of MCU

Features	Co-operative	Puspo	Cijanggal	Sukabumi
	Nominal Electric Power		1 × 9 kW	1 × 1.5 kW
Refrigerant Used	Before	R22	R22	R12
	After	R290	R290	PNB
Refrigerant Charge, kg	Before	15.1	5	50
	After	8.6	2	15
High pressure in bar	Before	15.6	15.9	11.6
	After	13.7	13.3	11.7
Energy used in kWh	Before	33.7	-	-
	After	28.9	-	-
Electric current in A	Before	16	3.5	15
	After	13	2.2	13
COP	Before	2.98	-	-
	After	3.47	-	-

Table 2: Observed results from field tests

## Conversion of small and medium AC systems

All of the AC units at the Bandung Institute of Technology (BIT) administration building were filled with HC (R-290, propane) since they started the operation in 1999. At that time the management of BIT wanted that the AC supplier used the HC for the new building. The AC system consists of around fifty split AC units and multi-split AC units and several packaged systems. No measurement was done, however the units performed well. Similar tendency to the milk cooling units was shown by the performance data of the retrofitted AC system in PT Mulia Industrindo (Table 3). The 25 hp hermetic reciprocating compressor system performed better after it was

retrofitted with R-290. The compressor electric current is lower, but the cooling capacity is higher as indicated by lower cooled air temperature. The discharge and suction pressure are slightly lower.

Institution	PT Mulia Industrindo, Cibitung	
Retrofitting Date	22 <sup>nd</sup> May, 2002	
Refrigeration System	25 hp, AC system	
Electric Voltage	3 phase, 380 V, 50 Hz	
Refrigerant	R-22 (HCFC)	R-290 (HC)
Electric Current	15 A	11 A
Operating Time	24 hr	24 hr
Discharge Pressure	17.2 bar (g)	14.5 bar (g)
Suction Pressure	5.0 bar (g)	4.3 bar (g)
Condenser Temperature	41°C	40°C
Evaporator Temperature	N/A	N/A
Outdoor Temperature	33°C	34°C
Outlet Air Temperature	20°C	16°C
Indoor Temperature	24°C	24°C

Table 3: Operating condition of AC unit in PT Mulia Industrindo, Cibitung

## Conversion of large AC systems

Retrofitting of R-22 refrigerant system with R-290 was also done in large capacity chillers. Table 4 shows the performance comparison of two identical chillers with different refrigerants. The chillers are utilized as the cooling unit for the AC system in Grand Melia Hotel Jakarta. One chiller remains with R-22 refrigerant, and the other was retrofitted with R-290. Each of the chillers uses seven reciprocating compressor and has cooling capacity of 420 kW. Each chiller was equipped with a wattmeter and run-hour meter. The table shows that during the observation time (34 days), the R-290 chiller operated with higher running hours (5313.3 hours) compared to R-22 chiller (4610.9 hours). However, the rate of electric energy consumption of R-290 chiller (161.82 kW) is less than that of R-22 chiller (194.40 kW). The monthly saving in electric energy consumption is quite significant, that is 25182.33 kWh or equivalent to Rp. 11052489.3 (US\$ 1200) per month per chiller. The hotel utilized 6 similar chillers, at least 3 chillers operating continuously. Now, all five out of six chillers have been retrofitted with R-290. One remaining R-22 chiller is used for comparison purposes. The power saving observation for four consecutive months to these chillers is shown in Table 5. It can be seen that the saving power consumption system is consistent. A conversion of an AC system was also done at several hotels and office buildings in Jakarta and Bandung, such as the BPPT building (the Minister of Research and Technology), the Deutsche Bank building, the Permata Hotel etc. As was expected, they all performed well until now.

Chiller	R-22	R-290
Date of Observation	25/12/2002 to 27/1/2003	
Days	34 days	
kWh meter	859.0	781.8
hour meter		
Compressor 1	707.0	773.0
Compressor 2	694.8	772.5
Compressor 3	645.4	753.8
Compressor 4	702.9	769.8
Compressor 5	690.2	768.8
Compressor 6	651.9	751.4
Compressor 7	518.7	724.5
Σ running hour	4610.9	5313.8
Average operating hour	19.37	22.32
Operating time of lead comp, h/day	20.79	22.73
Electric Consumption, kW	194.40	161.82
Electric rate difference, kW	32.58	
Power saving, kWh	25182.33	
Δ kWh × Rp./kWh	11052489.3	
Saving in Energy on Januari, Rp	11052489.3	

Table 4: Performance comparison of two identical chillers with different refrigerant

Data	Month, 2003					
		Jan	Feb	March	April	May
kWh	Ch. R-22	801.6	1073.2	1518.0	2251.8	2879.1
	Ch. R-290	875.6	1296.1	2213.6	2800.7	3530.6
Avg. Run Time/day	Ch. R-22	20.8	21.4	10.4	20.4	19.7
	Ch. R-290	22.7	18.8	17.4	12.4	18.5
Saving, kW		32.58	46.25	38.07	52.94	41.18
Saving, Rupiah		11,051,359	14,572,367	7,888,448	16,253,032	10,415,894

Table 5: Power consumption difference between R-22 and R-290 systems

## Conclusions

HCFCs have been scheduled to be banned in the near future and its candidates for replacements so far also have high GWP. It has been demonstrated on the other hand that the HC refrigerant (propane) can substitute HCFC22 very well, and in all cases so far, performed even better. The HC refrigerant can be “a drop-in” substitute for the existing system, although it needs minor modifications because of the flammability of R290, but this can be overcome by the strict application of safety standards. In several cases, the lubricant oil needs also to be changed to a higher viscosity grade especially when the compressor has the low temperature trip system.

---

## References

---

- Suwono, A., Samudro, H.M., Tandian, N., and Ardiansyah, W., 1995, Theoretical and Experimental Study of the Application of Propane/n-Butane Mixture as Refrigerant Replacing R-12, 19th International Congress of Refrigeration Proceedings, vol. IVa, p. 552
- Suwono, A., Pasek, A.D., and Tandian, N.P., 1996, Development of the Application of Propane/n-Butane Mixture as CFC-Refrigerant Substitute, Seminar on Alternative Refrigerants, Bandung, (Indonesian)
- Suwono, A., Tandian, N.P., Pasek, A.D., Hardianto, T., Soelaiman, T.A.F., Damitri, N., Atmadi, P., Soekardi, C., 1999, Retrofit and Conversion of R22 Chiller to R290 and Its Performance Comparison, Journal Mechanical Engineering, 14, 1, pp. 1-6, (Indonesian)
- Pasek, A.D., Tandian, N.P., Suwono, A., Hardianto, T., Soelaiman, T.A.F., 1999, Indonesian Experience in Retrofitting of Some Milk Cooler Systems, Journal Mechanical Engineering, 14, 2, pp. 24-27, (Indonesian).
- Bodio, E., Chorowski, M., and Wilczek, M., 1995, Propane-Butane a Promising Alternative, Proc. of IIR 19th International Congress of Refrigeration Vol. IVa.
- Richardson, R.N, and Ritter, T.J., The Performance of Hydrocarbon Alternatives of R12 and R22, J. AIRAH, August, 1996.
- Halozen, H., Ebner, H.T., Lawatsch, H., 1994, Propane: A Realistic Alternative, Proc. Int. Conf. On New Application of Natural Working Fluids in Refrigeration and Air Conditioning, IIR Commission B2, Hanover, Germany.
- Standar Nasional Indonesia, SNI 06-6500-2000, Refrigeran: Pemakaian pada Instalasi Tetap, BSN, 2000
- A.D. Pasek, R. Ufie, R. Adrian, and A. Suwono, 2006, Flammability and Performance Test of R290/R134a Mixtures for HCFC 22 Replacements. Proc. of Natural Refrigerant Conference, Gustav-Lorenzen IIR, May 28-31,
- A. D. Pasek, N. P. Tandian, and A. Suwono, 2003. Less Flammable HC Refrigerant as an Alternative Refrigerant for energy conservation in Refrigeration System, Proc. Int. Conference on Fluid and Thermal Energy Conversions, Bali, Dec 7 – 11.

# Experimental Assessment of HC-290 as a Substitute to HCFC-22 in a Window Air Conditioner

DR. ATUL S. PADALKAR, Sinhgad College of Engineering, India

DR. SUKUMAR DEVOTTA, National Environmental Engineering Research Institute, India

---

## Introduction

---

Due to the environmental concerns [Ozone Depletion Potential (ODP) and Global Warming Potential (GWP)] of the existing refrigerants, the industry and researchers in this field are in search of long-term solutions. With extensive work on alternatives to chlorofluorocarbons (CFCs) and hydrochlorofluorocarbons (HCFCs), initially hydrofluorocarbons (HFCs) were considered to be long-term solutions. The global warming of HFCs has become a hurdle to accept them as long-term solutions. Now the focus is on the use of natural refrigerants. The natural refrigerants considered are hydrocarbons (HCs), ammonia, carbon dioxide, and water. The natural substances have the dual advantage of very low global warming nearly zero and zero ozone depletion. HCFC-22 is one of the important refrigerants used in air-conditioning all over the world. HCFC-22 is controlled substance under the Montreal Protocol. It has to be phased out by 2030 in developed nations and 2040 in developing nations. In Europe, HCFCs have already been phased out in new equipment (below 100 kW capacity) in 2002 and the total phase out of HCFCs is scheduled for 2015. In the Western and Northern Europe, HC-290, is being used in small capacity units. HC-290 has zero ODP, virtually zero GWP and it is a natural fluid. It has no other effect on climate, although it is considered as volatile organic compound. It is cheap and available in plenty. HC-290 is a pure hydrocarbon compound and it does not give out any toxic decomposing agents on combustion. It is compatible with the materials and lubricants used in refrigeration and air conditioning industry. Due to better miscibility with oil, the oil return to the compressor is not an issue. According to ASHRAE 34 and EN 378, HC-290 is classified as highly flammable (Class 3) refrigerant. Underwriters Laboratories (UL) and International Electrochemical Commission (IEC) are very restrictive in allowing the use of flammable refrigerants. US EPA has not approved yet the use of HC refrigerants in any applications other than industrial processes. EN 378 and some European national standards prescribe general guidelines on the safe use of flammable and toxic refrigerants. The flammable

refrigerant charge limits are normally established at 20% (for BS 4434) or 25% (for DIN 7003) of the refrigerant quantity required to lower flammability limit when leaked into a prescribed volume /9/. Significant changes in product design could avoid the risks associated with the use of flammable refrigerants /5/. Colbourne and Ritter /3/ presented a methodology for assessing the risks associated with the use of flammable refrigerants in room air conditioners. Most influencing parameters that contribute to the overall risk are higher concentration of refrigerant at floor level and failure of critical safety components.

The Air-conditioning and Refrigeration Institute /1/, considering the need for the replacement of HCFC-22, established the Alternative Refrigerant Evaluation Program (AREP) in February 1992. Through AREP many refrigerants were assessed. The most potential alternative refrigerants identified were R-410A, R-407C, HFC-134a and HC-290. Treadwell /16/ tested HC-290 in an HCFC-22 single packaged unitary air conditioning system, first, with original compressor and second, replacing 18% larger displacement compressor. Lorentzen /14/ recommended HC-290 as alternative to HCFC-22, as HC-290 has excellent thermodynamic and transport properties. Keller et al. /12/ reported a theoretical study on assessment of HC-290 in the residential air conditioner by comparing the seasonal energy efficiency ratio and total equivalent warming impact. Purkayastha and Bansal /15/ tested HC-290 in a laboratory heat pump/refrigeration test apparatus and reported that COP of heat pump with HC-290 was higher than HCFC-22 with small loss in condenser capacity. Hammand and Tarawnah /6/ presented the experimental results for mixtures of propane (HC-290) and butane (HC-600) by varying their composition in a residential split air conditioning unit. Granryd /4/ reviewed the hydrocarbon refrigerants for different applications. The author compared propane (HC-290) and HCFC-22 and found that propane gave lower capacity by 3 to 15% than HCFC-22. Hwang et al. /8/ reported performance comparison of HC-290 with HCFC-22 in residential split heat pump system as drop-in and soft-optimized tests. Recently Ki-Jung et al. /10, and 11/ tested HC-290 and mixtures of HC-290 with propylene (R-1270) in breadboard type air-conditioner and reported that COP of HC-190 and mixtures was higher than HCFC-22. However, capacity was lower than that of HCFC-22. Most of these studies indicate that HC-290 has higher coefficient of performance with loss in capacity up to 15% than HCFC-22.

Most of these studies indicate that HC-290 is a potential drop-in refrigerant for existing HCFC-22 systems.

---

## Window air conditioner

---

Window air conditioner unit consisted of a compressor, a condenser coil, an evaporator coil, a capillary tube, and outer connecting copper tubing. Apart from these basic components, fan, fan motor, blower, and controls were also provided.

### Compressor

The compressor was of hermetic reciprocating type. Its calculated displacement was of 39.6 cm<sup>3</sup> (2.416 in<sup>3</sup>). The rated cooling capacity of the compressor was 5.42 kW (19000 Btu/hr).

### Evaporator

The direct expansion (DX) type evaporator was used in the air conditioner unit. It consisted of 48 tubes configured in 3 rows. It consisted of two refrigerant circuits i.e. the refrigerant flow is channelled through separate two lines rather than through a long tube. The plain tubes were 422 mm long with 10 mm outside diameter and 9.44 mm inside diameter. The distance between two consecutive tubes was 25.4 mm (1"). Tube rows were separated by distance of 22 mm (0.866"). Wavy 13 fins per 25.4 mm (1") were bonded on evaporator tubes with the thickness of 0.12 mm (0.0047"). The room air was blown on the evaporator using the blower.

### Condenser

Condenser had 50 tubes placed in 3 rows with a continuous coil with a single refrigerant circuit. The length of each tube in the condenser was 575 mm. The plain tube had 9.44 mm inside diameter and 10 mm outside diameter. The distance between two conjugative tubes was 25.4 mm (1"). Tube rows were separated by distance of 22 mm (0.866"). Wavy 13 fins per 25.4 mm (1") were bonded on evaporator tubes with the thickness of 0.12 mm (0.0047"). A fan was used to blow the air on to the condenser.

### Other parts and controls

Two capillary tubes of 1.4 mm (0.055") inside diameter and 762 mm (30") in length were used in the refrigeration cycle of window air conditioner. Upstream ends of both capillary tubes were connected to a single header with liquid line and down stream ends were connected with two evaporator circuits separately.

The blower used was of the centrifugal type with 72 leaves, and made of plastic material. It was surrounded by acoustical insulating material to reduce the noise. The condenser fan was propeller type with 5 leaves. The fan, made of plastic material, was located immediately in front of the condenser coil. The condenser fan and the blower were mounted on a common motor shaft. An electric motor of 124 W and 930 rpm

was used. The fan cooled the condenser coil. Master control was used to start and stop the compressor as well as the fan motor. Thermostat control was used to adjust the temperature to cooler or warmer conditions as required. The thermostat was located in the return air stream near the filter on the evaporator side.

## Test conditions

The performance evaluation of a window air conditioner is prescribed in Indian Standards IS 1391 Part I /2/. There are many tests to assess the performance of window air conditioners. The important tests for energy efficiency are capacity rating test and power consumption test. There is one capacity rating test for Indian domestic market and another two tests are for the export market. The purpose of capacity rating test is to determine the magnitude of the net total cooling effect, net dehumidifying effect, net sensible cooling effect and net total air capacity for cooling. The test conditions for energy consumption test are the same as the capacity rating test. The conditions of air in the form of dry bulb temperature (DBT) and wet bulb temperature (WBT), on both sides of window air conditioner, for capacity rating tests are presented in Table 1.

Test	Indoor room conditions		Outdoor room conditions	
	DBT (°C)	WBT (°C)	DBT (°C)	WBT (°C)
Domestic Test (DT)	27	19	35	30
Export Test A (ETA)	27	19	35	24
Export Test B (ETB)	29	19	46	24

Table 1: Rated capacity test conditions

## Experimentation

A 5.13 kW window air conditioner designed for HCFC-22 was selected for performance evaluation of HC-290. It was tested as per the Indian Standard 1391 (1992) Part I, for unitary air conditioners. The performance of the air conditioner with HC-290 is compared with the baseline performance with HCFC-22.

### Experimental test facility

As per IS 1391, the air conditioner was tested in a psychrometric chamber, as shown in Figure 1. The chamber consists of two rooms of equal size, one on evaporator side and the other on condenser side. The ambient conditions of both the rooms were maintained as prescribed in Table 2. The conditioning of the air in both the rooms was done using the dehumidifiers (air conditioner), air heaters, and humidifiers. In

this method, measurements of dry-bulb and wet-bulb temperatures of entering and leaving air and the associated flow rates were used to calculate the cooling capacity. Nozzle type airflow rate measuring device was used to measure the volume flow rate of air. Temperatures were recorded with the help of precision thermometers with an accuracy of  $\pm 0.1^\circ\text{C}$ . An electronic panel recorded the power consumed by the air conditioner with an accuracy of  $\pm 10$  W. Refrigerant pressures were measured by using precision Bourdon's tube pressure gauges with an accuracy of  $\pm 13.7$  kPa. Air pressure difference across the nozzle was measured using inclined manometer.

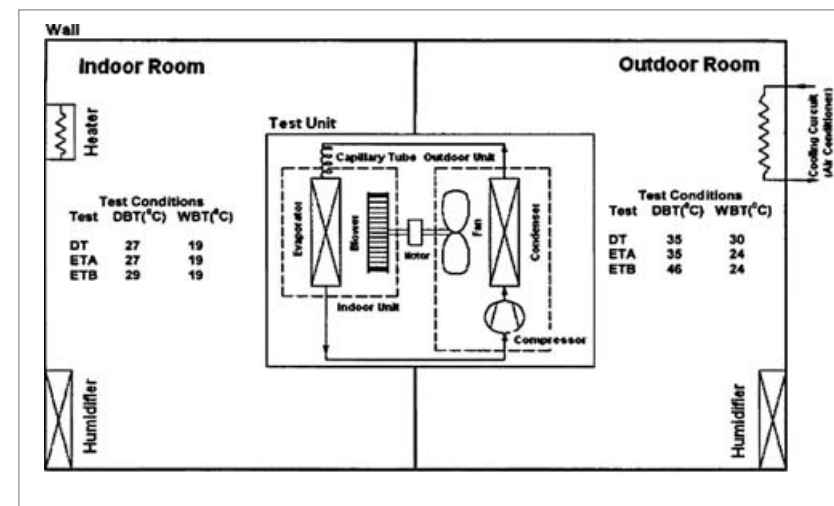

Figure 1: Schematic diagram of the test facility

After confirming the steady state for one hour, temperatures of air (dry bulb and wet bulb) at condenser and evaporator inlet/exit were recorded for one hour at an interval of 10 minutes. The performance data of HCFC-22/mineral oil (ISO VG 32) were used as the base line data. After the completion of all tests with HCFC-22, HCFC-22 was recovered from the air conditioner. Following the conventional charging procedure, the air conditioner was charged with HC-290 without changing oil in the compressor. The charge of HC-290 was about 48 – 50 percent of the original HCFC-22 charge /12, 20/, which was decided on the basis of past experience of researchers and thermodynamic calculations.

### Measurement uncertainty

The testing of window air conditioner with HCFC-22 and HC-290 included the measurement of temperatures, pressures, power consumption, and air pressure difference. Measured quantities with their uncertainties are listed in Table 2.



Quantity	Range	Uncertainty
Pressure	a) 0-2170 kPa (0-300 Psig)	±13.78 kPa
	b) 0-3549 kPa (0-300 Psig)	±13.78 kPa
Temperature	0°C to 50°C	±0.1°C
Power	0-5000 W	±10 W
Air Pressure Difference	0-500 mm H <sub>2</sub> O	±1 mm H <sub>2</sub> O

Table 2: Measured quantities and their uncertainty

Air-water mixture properties were obtained from EES 5.201 /13/. The uncertainties in cooling capacity and COP were in the range 3.72% to 3.76% and 4.15% to 4.31% respectively.

### Safety considerations in using HC-290 in a window air conditioner

For a perfectly hermetic system, the flame cannot propagate in the interior of the system, as there will be no air inside the system. However, a leak of refrigerant from the system, formation of appropriate proportion of HC-290/air, and presence of an ignition source can lead to combustion. Therefore, following precautions were taken to ensure the safety of the air conditioner with HC-290.

1. All tubing joints were brazed.
2. The charge of HC-290 was about 500 g. Even if the total HC-290 leaked in the test chamber, the concentration (11.6 g/m<sup>3</sup>) would have been well below the explosive density of HC-290 (43.6 to 175 g/m<sup>3</sup>) /7/.
3. The electrical components like capacitor, thermostat switch, on/off switch etc. were sealed using some means.
4. Special precautions were taken to protect the tubes from damage.
5. Every time before starting the system, the room was ventilated well.
6. Electronic HC detectors were placed in the room.

## Results and discussion

The cooling capacity was computed as the product of the air enthalpy difference, associated volumetric flow rate of air and outlet air density, using Equation 1.

$$Q_c = (h_1 - h_2) \cdot V_m \cdot \rho_2 \quad (1)$$

Where,

$Q_c$  = Cooling capacity (W)

$h_1$  = Inlet air enthalpy at indoor side (J/kg)

$h_2$  = Outlet air enthalpy at indoor side (J/kg)

$V_m$  = Volume flow rate of air (m<sup>3</sup>/s)

$\rho_2$  = Density of outlet air at indoor side (kg/m<sup>3</sup>)

Air-water mixture enthalpies at the inlet and outlet of the evaporator and outlet air density were obtained from EES 5.201 for the corresponding conditions. The coefficient of performance was evaluated as the ratio of the cooling capacity to the power consumption, using Equation 2, where W is the compressor power.

$$\text{COP} = \frac{Q_c}{W} \quad (2)$$

### Cooling capacity ( $Q_c$ )

Figure 2 shows the variation of cooling capacity for both HCFC-22 and HC-290 for a range of operating conditions. HCFC-22 gave a cooling capacity of 5.085 kW for the lower temperature operating conditions and 4.111 kW for the higher temperature operating conditions. Test results show that HC-290 had 6.6% lower cooling capacity for the lower operating conditions and 9.8% lower for the higher operating conditions with respect to HCFC-22. The decrease in cooling capacity is in agreement with the results of an HCFC-22 split heat pump (9 kW) tested as per ASHRAE conditions under drop-in conditions using HC-290 /8/. Capacities of both the refrigerants were obviously lower for the higher operating conditions with similar variations. The lower cooling capacity for HC-290 was due to its lower volumetric capacity than HCFC-22. There may be some potential to improve the performance with HC-290 with some refrigerant charge or capillary length optimization.

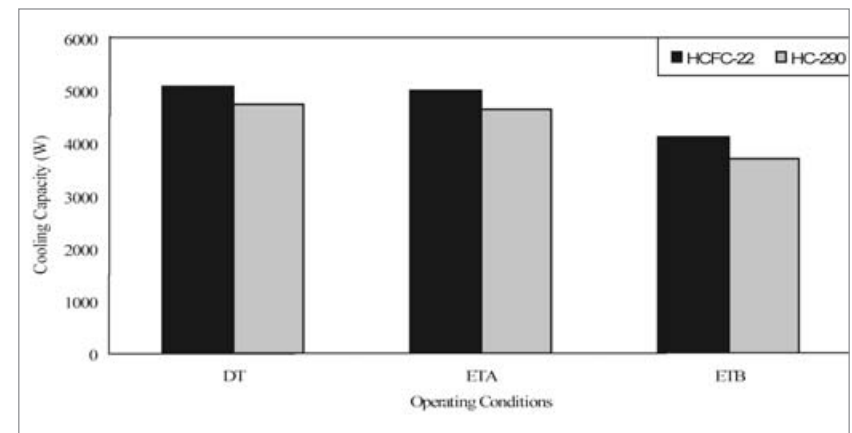

Figure 2: Cooling capacities of HCFC-22 and HC-290 for various operating conditions

### Power consumption (W)

Figure 3 shows that the power consumed by the system with HC-290 was lower, for all the operating conditions, than HCFC-22. The power consumed by the system with HCFC-22 was in the range 2111 to 2338 W. The power consumed with HC-290 was lower by 12.4% to 13.5%. As per IS 1391(1992), the power consumption should be below 2.2 kW at the rated capacity conditions for the domestic test. The power consumed by the system with HC-290 was much lower by 371 W than the prescribed limit. Because of lower pressure ratios for HC-290 than HCFC-22, the compressor with HC-290 required lower power.

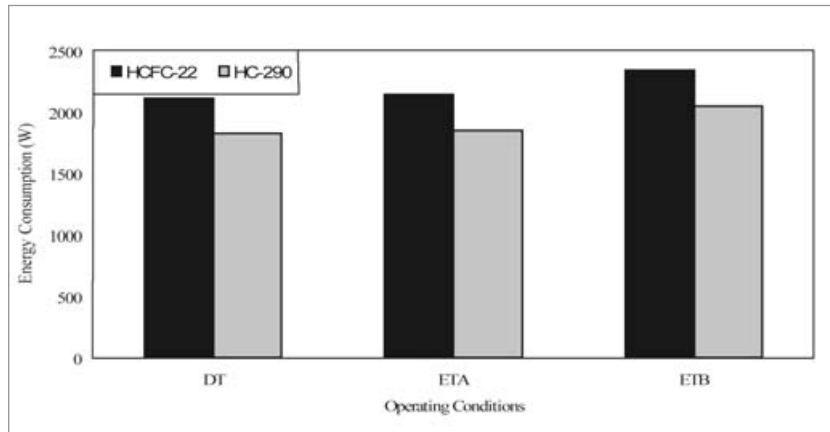

Figure 3: Power consumption for HCFC-22 and HC-290 for various operating conditions

### Coefficient of performance (COP)

Figure 4 shows the variation of COP for both HCFC-22 and HC-290 for a range of operating conditions. COP of HCFC-22 was 2.41 for the lower operating conditions and 1.76 for the higher operating conditions. For HC-290, COP was 7.9% higher for the lower operating conditions and 2.8% higher for the higher operating conditions. COP of HC-290 was higher for all the tests because of the lower power consumption by the compressor. The decrease in COP at higher operating conditions is due to decrease in heat transfer rates in the condenser and the compressor performances. Hwang et al. /8/ reported that cooling COP of a split heat pump with HC-290, tested as per ASHRAE conditions was higher by 4 to 6% than HCFC-22. The present study is in agreement with their results.

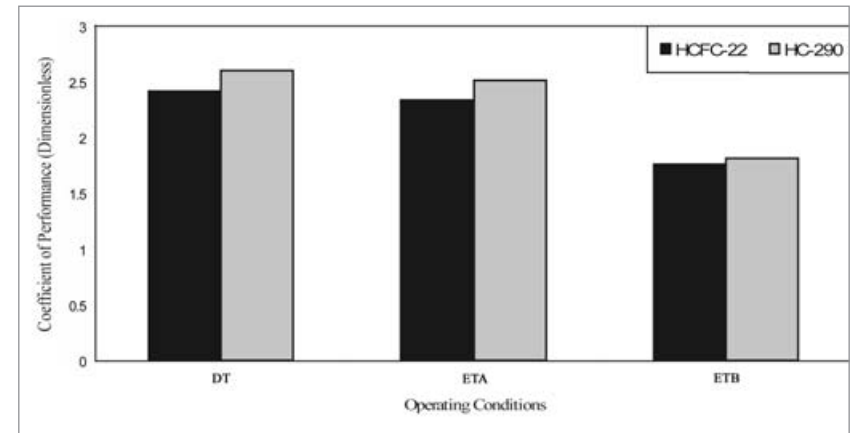

Figure 4: COPs of HCFC-22 and HC-290 for various operating conditions

### Discharge pressure ( $P_d$ )

Figure 5 shows the discharge pressure of HC-290 and HCFC-22 for a range of operating conditions. The discharge pressure of HCFC-22 was 2514.45 kPa for the lower operating conditions and 3072.92 kPa for the higher operating conditions. HC-290 had lower discharge pressures than HCFC-22. The discharge pressure of HC-290 for all operating conditions varied in the range 13.7% to 18.2 % lower than that of HCFC-22.

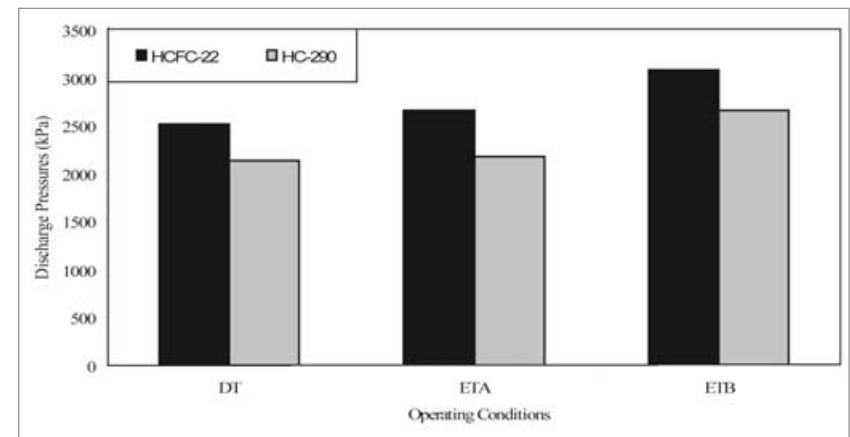

Figure 5: Discharge pressures of HCFC-22 and HC-290 for various operating conditions

## Discharge temperature ( $T_d$ )

Figure 6 shows the discharge temperature of HC-290 and HCFC-22 for a range of operating conditions. The discharge temperature of HCFC-22 was 61.7°C for the lower operating conditions and 77.4°C for the higher operating conditions. The discharge temperature of HC-290 for all operating conditions varied in the range 10.8°C to 14.5°C lower than that of HCFC-22.

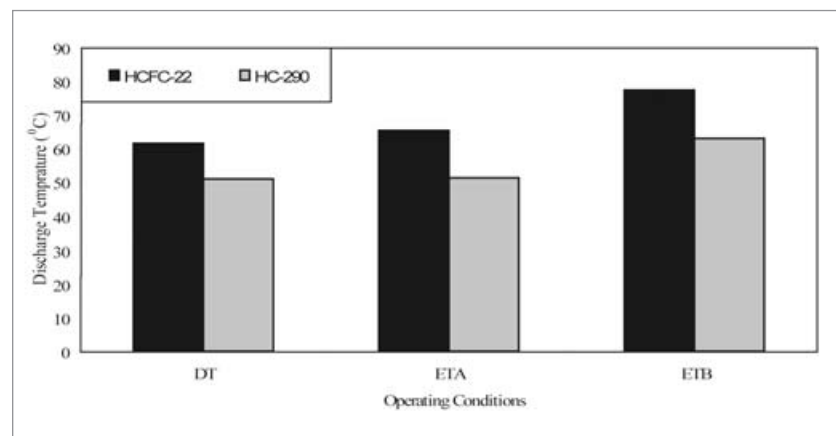

Figure 6: Discharge temperatures of HCFC-22 and HC-290 for various operating conditions

## Pressure drop in the heat exchangers ( $\Delta P$ )

As given in Table 3, the pressure drop for HC-290 was lower than HCFC-22 for all the tests in both heat exchangers. For HCFC-22 and HC-290, the pressure drop increased with higher operating conditions in the evaporator while it decreased with operating conditions in the condenser. For HC-290, the pressure drop was lower in the range 32% to 50% in the evaporator. In the condenser, the pressure drop for HC-290 was lower in the range 6.3% to 16.7% than that of HCFC-22.

Refrigerant	Test	Pressure Drop (kPa)	
		Evaporator	Condenser
HCFC-22	DT	83	103
	ETA	83	83
	ETB	101	77
HC-290	DT	41	97
	ETA	55	69
	ETB	69	69

Table 3: Pressure drop in heat exchangers for HCFC-22 and HC-290

## Conclusions

Based on the experimental investigation on the performance of HC-290, as a drop-in substitute to HCFC-22, in a window air conditioner, the following conclusions could be drawn.

- Cooling capacity of HC-290 was lower in the range 6.6% to 9.8%
- Power consumption of air conditioner with HC-290 was lower in the range 12.4% to 13.5%.
- COP of HC-290 was higher in the range 2.8% to 7.9%.
- Discharge pressures of HC-290 were lower in the range 13.7% to 18.2%.
- Discharge temperatures of HC-290 were lower in the range 10.8°C to 14.5°C.
- Pressure drops of HC-290 were lower than HCFC-22 for all tests.

HC-290 was successfully used as a drop-in replacement for an HCFC-22 window air conditioner with due precautions towards the flammability issue. Due to its excellent thermodynamic and environmental properties, it is a good long term alternative to HCFC-22 in residential air conditioners.

## Acknowledgement

The authors would like to thank the Godrej Appliances Ltd., Mumbai, for providing the test facility and assistance with technical support. Special thanks are also due to Mr. Vikram Bhopatkar, Mr. Dilip Rajadhyaksha, and Mr. Nitin Desai (Godrej Appliances Ltd.) for their kind cooperation and assistance during experimental work.

## References

- /1/ Air Conditioning and Refrigeration Institute, Soft-optimized system tests conducted with several possible R-22 and R-502 alternatives, 1997, Arlington, VA, USA.
- /2/ Bureau of Indian Standards, Room air conditioners specification, part I: unitary air conditioners, IS-1391, 1992, New Delhi, India.
- /3/ Colbourne D, and Ritter TJ, Quantitative risk assessment of flammable refrigerants in room air conditioners, Proceedings of Sixteenth International Compressor Engineering Conference and Ninth International Refrigeration and Air Conditioning Conference, 2002, Purdue University, West Lafayette, Indiana, USA.
- /4/ Granryd E, Hydrocarbons as Refrigerants – an overview, Int. J. Refrigeration, 2001, 24(1), 15-24.

- /5/ Grob DP, Status of safety requirements for refrigerants and safety requirements for products with flammable refrigerants, Informatory paper, 1998, Underwriters Laboratories Inc., Northbrook, IL, USA.
- /6/ Hammand M, and Tarawnah R, Hydrocarbon refrigerants performance in an air conditioning units, Proceedings of 4<sup>th</sup> IIR-Gustav Lorentzen Conference on Natural Working Fluids, 2000, Purdue University, West Lafayette, Indiana, USA, 167-176.
- /7/ Hang HD, and Zheng QR, Researches on the replacement for R12 and R22 used in marine refrigerating units for coming 21<sup>st</sup> century, Proceedings of 20<sup>th</sup> International Congress of Refrigeration, 1999, Sydney.
- /8/ Hwang Y, Gado A, and Radermacher R, Performance comparison of hydrocarbon R-290 with R-22 in residential heat pump system, Proceedings of 5<sup>th</sup> IIR-Gustav Lorentzen Conference on Natural Working Fluids, 2002, Guangzhou, China, 603-610.
- /9/ International Institute of Refrigeration, Standards for flammable refrigerants, 13<sup>th</sup> Informatory Note on Refrigerants, 1997, Paris, France.
- /10/ Ki-Jung P, Yun-Bo S, and Dongsoo J, Performance of alternative refrigerants for residential air conditioners and heat pumps, Applied Energy, 2007, 84(10), 985-991.
- /11/ Ki-Jung P, Yun-Bo S, and Dongsoo J, Performance of R433 for replacing HCFC-22 used in residential air conditioners and heat pumps, Applied Energy, 2008, (In press).
- /12/ Keller FJ, Sullivan L, and Liang H, Assessment of propane in North American residential air conditioning, Proceedings of 1996 International Refrigeration Conference at Purdue, 1996, Purdue University, West Lafayette, Indiana, USA, 39-44.
- /13/ Klein SA, and Alvarado FL, Engineering equation solver, version: 5.201, F-chart software, 2000, Middleton, Wisconsin, USA.
- /14/ Lorentzen G, The use of natural refrigerants: a complete solution to the CFC/HCFC predicament, Int. J. Refrigeration, 1995, 18(3), 190-197.
- /15/ Purkayastha B, and Bansal PK, An experimental study on HC-290 and a commercial Liquefied Petroleum Gas (LPG) mixture as suitable replacements for HCFC-22, Int. J. Refrigeration, 1998, 21(1), 3-17.
- /16/ Treadwell DW, Application of propane (R290) to a single packaged unitary air conditioning product, Proceedings of International CFC and Halon Alternatives Conference, 1991, Baltimore Convention Center Baltimore, Maryland, USA, 348-351.

---

## IV. Market Developments and Case Studies

---

# The Quality of Natural Refrigerants

## The Importance of Specifying High Purity Products

VERONICA SHIELS and BARRY LYONS, BOC, UK

---

### Introduction

---

Although not a recent development, the use of natural refrigerants, ammonia (R-717/ $\text{NH}_3$ ), hydrocarbons (R-600a/iso-butane, R-290/propane, R-1270/propylene, etc) and carbon dioxide (R-744/ $\text{CO}_2$ ) is becoming increasingly common as legislation and environmental awareness shifts end-users away from fluorocarbon-based refrigerants. However, unlike most fluorocarbon refrigerants, these substances are already widely used within a variety of different applications. For example, ammonia is used for fertiliser and explosives feedstock, pharmaceutical production, and so on; hydrocarbons are typically used for fuels, but also for aerosols, foam-blowing and solvents; carbon dioxide is used extensively, from food and drink production, chemicals and pharmaceuticals production to fire extinguishers, etc. The quality requirements of a given substance vary widely depending upon the application, with some being more purity-sensitive than others. Thus, suppliers may provide products that cover an extensive range of purity specifications that are tailored to particular purposes. Many of these products are unsuitable for use as refrigerants.

Thus, it is important to ensure that the ammonia, HC or  $\text{CO}_2$  is fit for purpose, and confirms to the specifications appropriate for use as refrigerants. For fluorinated refrigerants, the commonly adopted standards are ARI 700 (which is inappropriate for natural refrigerants) and DIN 8960. DIN 8960 also covers HCs and ammonia, and the IIR Specification O-A-445B for ammonia. In addition, a number of compressor manufacturers specify certain requirements for the refrigerants that are to be used in their machines. However, due to the absence of an international standard on the quality of natural refrigerants and widespread retailing of products sold as ammonia, HCs and carbon dioxide refrigerants, there is a major disparity in their quality.

As a result, the purchaser or end user must rely on the refrigerant supplier to provide an adequate material, and unless the purchaser specifies the application to the vendor, the most common, which is also generally the lowest purity product, will be sold. In some cases vendors may openly offer lower grade material in order to be more com-

petitive. Similarly, if the technicians are unaware of the importance of refrigerant purity, they may quite easily purchase sub-standards products, such as LPG instead of R-290. Using low grade natural refrigerants can ruin the performance and reliability of a refrigeration system and cause serious damage to equipment. Whilst some reports have demonstrated that low quality ammonia, CO<sub>2</sub> and HCs have been successfully used in refrigeration systems, there are also many instances of equipment failure and poor performance occurring under the same situations. Therefore, this article details the potential implications of using low quality fluids as refrigerants, and emphasises the importance of using the correct specifications.

## Implications of refrigerant contamination

There are four main impacts associated with the use of impure refrigerants with a system:

- Changes to the thermophysical properties of the working fluid.
- Chemical changes affecting the internal stability of the system.
- Physical changes that affects the structure of components and behaviour of materials.
- Toxicity implications if released from the system.

Many of the changes are interrelated and all ultimately compromise the performance, operation, longevity and safety of the system. If the refrigerant is contaminated with a gas which has good mutual solubility, a mixture is created and if the proportions are high enough, the properties, and in particular, the saturated pressure-temperature relationship can be altered. Conversely, if a gas readily separates from the refrigerant, it may accumulate within certain high-side components and therefore inhibit heat transfer, thereby degrading system performance.

Changes to the thermodynamic and transport properties of the fluid will occur if the refrigerant is contaminated with substances with which it is mutually soluble, in sufficiently high proportions. Examples of the consequences to the system arising from changes in properties include:

- Variation in suction and discharge pressures for a given evaporating and condensing temperature compared to standard data.
- Creation of a temperature glide, or a deviation from the standard temperature glide data, within the evaporator or condenser.
- Increased or decreased solubility with the lubricating oil, possibly resulting in poorer lubricity or starving of oil from the compressor.
- Fluid separation within the circuit, where higher pressure components accumulate within the high-side of the system and lower pressure components accumulate within the low-side.

- Changes in refrigerant enthalpy and interference with heat transfer and pressure losses with heat exchangers and other components resulting in a moving of the system balance points.

Introduction of certain substances changes the internal chemistry of the system making it less stable. Examples of the consequences to the system arising from chemical changes include:

- Reactions that produce sludge, thereby blocking components and affecting heat transfer, as shown in Figure 1.
- Reactions the result in acids that attack the construction materials, such as metals, plastics and elastomers.
- Formation of new gases that are a product of reactions that can again affect the thermophysical properties of the refrigerant.

The physical impacts to the internal operation of the system include:

- Increasing levels of moisture become insoluble with the refrigerant at certain temperatures and pressures, resulting in the formation of ice, typically within the expansion device.
- Adsorption of substances into plastics and elastomers, thereby changing their physical properties and reducing their ability to seal properly.
- Reduction in lubricating properties leading to erosion and subsequent formation of metallic debris which leads to further wearing of moving parts.

The implications on safety include:

- Increase in operating pressures, which may exceed the design working pressures of the components or assembly.
- Higher system pressures, corrosion and poorer sealing properties of elastomeric materials lead to a higher possibility of leakage and rupture of components.
- The release of toxic, flammable and/or corrosive fluids that were not previously anticipated.

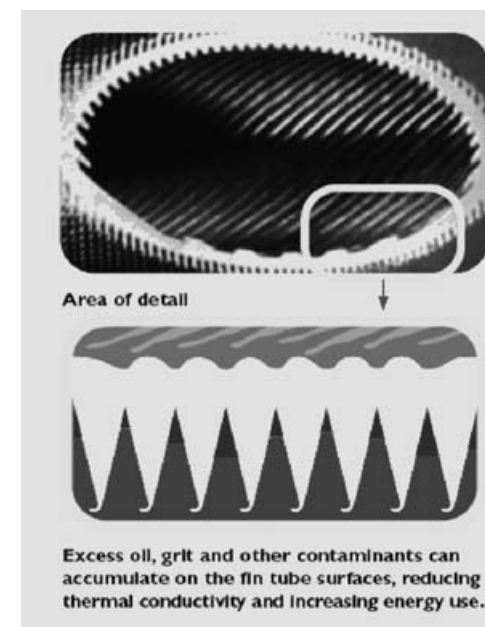

Figure 1: Particles and sludge clogging coils which reduces heat transfer

All of the above consequences of the introduction of undesirable substances into the refrigerating system will lead to a combination of reduced cooling capacity, increased power consumption, a drop in efficiency, increased likelihood of leakage, failure of moving parts and a general mechanical degradation of the system components. In order to determine the suitable specifications for natural refrigerants, it is necessary to analyse the effects that each are likely to comprise.

## Carbon dioxide

Carbon dioxide is already used in a massive range of applications, from food and drink production, drinks dispensing, chemicals and pharmaceuticals production, fire extinguishers, and so on, and therefore the range of specifications is similarly extensive. Carbon dioxide is also sources from a large number of production methods, which include being a by-product from ammonia and hydrogen plants, from the combustion of wood and fossil fuels, as a by-product of fermentation in breweries, and from thermal decomposition of limestone for production of lime. Thus, the most common substances found in carbon dioxide include water, air, carbon monoxide, hydrogen and hydrocarbons.

### Water

Water easily reacts with carbon dioxide to form carbonic acid, which in contact with metal causes corrosion. In Sweden the national research institute, EUC laboratory, carried out extensive tests using various grades of CO<sub>2</sub> and found severe problems including compressor failure caused by high moisture levels. An example of the corrosion to a pipe from carbon acid is shown in Figure 2. Following their recommendation the Swedish refrigeration industry standard for R744 has agreed a moisture content



of no more than 10 ppm. This standard has become the norm in many other Northern European countries. In addition, water has a low solubility in carbon dioxide and as such, it easily separates out as free water or ice and the pressure and temperature decrease.

Figure 2: Pipe corrosion caused by carbonic acid

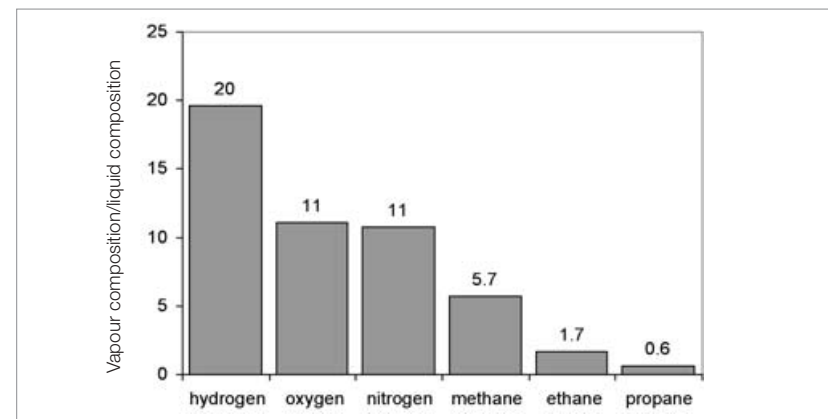

Figure 3: Vapour/liquid composition ratio of various gases in CO<sub>2</sub> at 0°C

### Air; oxygen, nitrogen

Whilst oxygen and nitrogen are unreactive with carbon dioxide, oxygen will promote reactions with any other substance likely to be present in the system, especially on the high pressure side where it is likely to collect. Otherwise, the high vapour pressure of these gases means that they will have a negative impact on the performance of the refrigerating system, and therefore their composition must be limited. Figure 3 shows the ratio of vapour composition of various gases in CO<sub>2</sub> to their composition in liquid CO<sub>2</sub>, which provides an indication of the detriment that the presence of a particular gas will have on the cycle performance. This shows that a significant amount of oxygen and nitrogen will separate out, typically in the condenser and receiver, which will degrade system performance, although this effect becomes less important during supercritical operation.

### Hydrocarbons

The hydrocarbons are relatively unreactive with carbon dioxide, they are soluble with the oils typically used with CO<sub>2</sub> and the saturated HCs are relatively benign when in contact with elastomers. In terms of their effect on vapour pressure, methane, ethane and propane introduce only minor differences to the vapour pressure even in relatively high concentrations, such as 1% change in pressure per 1% of introduced hydrocarbon. Further, as seen in Figure 3, the vapour/liquid composition ratio of the hydrocarbons in CO<sub>2</sub> is relatively low indicating that fractionation within the circuit is likely to be small and therefore will have minimal degradation of performance.



## Hydrocarbons

The most commonly used hydrocarbon is LPG for industrial, commercial, agricultural and domestic fuel where purity is not a significant factor. Other applications requiring higher purity hydrocarbons include aerosol propellants and calibration mixtures. It is important to recognise that LPG has a very random composition, for example, a cylinder of “propane” may only contain 50% propane with the remainder being made up of a variable mixture of other hydrocarbons plus high levels of sulphur, water and air. The commonly used hydrocarbons originate from natural gas or oil, and when first extracted tend to come in a mixture with many other components. Generally, these include sulphur compounds, oil and air.

### Sulphur

Sulphur may be present naturally, or added in the form of mercaptans (thiols). Whilst the concentrations will be sufficiently low to not affect the vapour pressure of the refrigerant, they can promote reactions within the system, leading to creation of acids and copper plating on the compressor parts, especially if water or oxygen is present. Another implication of having mercaptans present in the refrigerant is the possible confusion arising from the association of its smell to that of a fuel gas release. Hydrogen sulphide is somewhat reactive, but also highly toxic and it is therefore desirable to ensure that it is absent from the product.

### Water

The presence of moisture encourages reactions, such as creation of acids and subsequently corrosion, which is undesirable for good reliability of the system components. Water will also react with other substances to form weak organic acids, which eventually react with oil to form soapy sludge that can deposit throughout the system causing blocking and operational problems. In addition, hydrocarbons are largely insoluble with water, as seen in Figure 4. At lower temperatures less water will be held in the refrigerant, so that as the refrigerant reduces in temperature excess water may form ice, which is undesirable for the operation of the refrigerating system. Considering that HCs may be used in systems that have evaporating temperatures down to  $-40^{\circ}\text{C}$ , the data in Figure 3 suggests very low moisture content is desirable.

### Benzene, butadiene, propadiene (allene)

Benzene, butadiene and propadiene are all highly carcinogenic and toxic and are controlled substances in most countries. These are the main reasons for eliminating them from the refrigerants. Also, whilst benzene is relatively unreactive with other system materials, butadiene and propadiene readily polymerise when oxygen and acid are present.

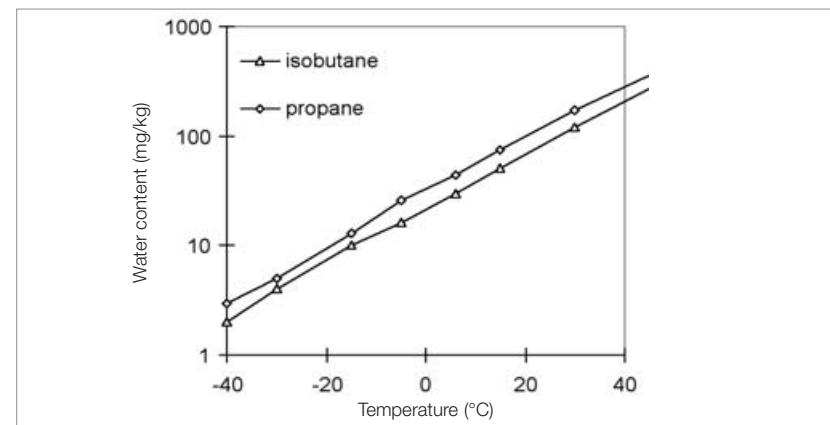

Figure 4: Solubility of moisture in hydrocarbons

### Air, Nitrogen, oxygen and carbon dioxide

Whilst nitrogen and carbon dioxide are relatively unreactive with hydrocarbons under the likely operating conditions, oxygen does of course promote reactions with almost any other substance likely to be present in the refrigerant, especially on the high pressure side, where it is likely to collect. Also, for all of these gases, their high vapour pressure of means that they will have a negative impact on the performance of the refrigerating system, and therefore their composition must be limited. Specifically for oxygen and nitrogen, it is seen in Figure 5 that a high degree of separation between the liquid and vapour compositions occurs, implying that significantly high amounts of these gases will collect in the high side of the system even if only low levels are present in the liquid refrigerant. Notwithstanding, the presence of carbon dioxide is a lot less severe.

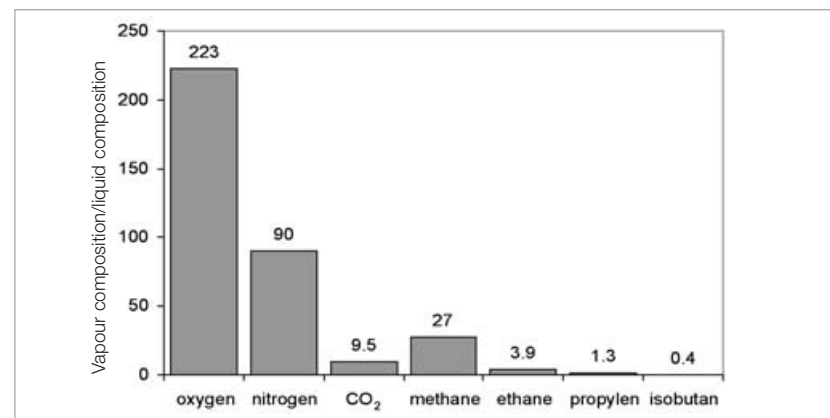

Figure 5: Vapour/liquid composition ratio of various gases in propane at  $0^{\circ}\text{C}$

## Other hydrocarbons

Mixtures containing other hydrocarbons will affect the vapour pressure, especially with the introduction of gases with a significantly different partial pressure from the main refrigerant; typically these include high normal boiling point (NBP) HCs such as pentane and hexane, and low NBP HCs such as ethane and methane (Figure 5). These will collect in the low and high pressure sides of the system, respectively, thereby increasing discharge pressures and reducing suction pressures, introducing high temperature glides and ultimately compromising the system performance. Therefore it is important to ensure that the permissible mixture of the other HCs is kept within a certain limit, and that the presence of high NBP components is offset by the presence of low NBP components to minimise their individual effects. In terms of other impacts, having unsaturated HCs (such as propylene or ethylene) present in a saturated HC refrigerant can lead to problems with certain elastomers (e.g. neoprene) unless they have been selected to handle all such components.

## Ammonia

Ammonia can be obtained from a variety of sources. Traditionally, it was produced from the distillation of vegetable and animal waste products, but large-scale modern production is typically by obtaining hydrogen from natural gas or oil, and reacting it with atmospheric nitrogen. Accordingly, the production process largely influences the types of contaminants found in ammonia, which typically include, amongst others: oxygen, carbon dioxide, hydrogen sulphide, methane and other volatile hydrocarbons,

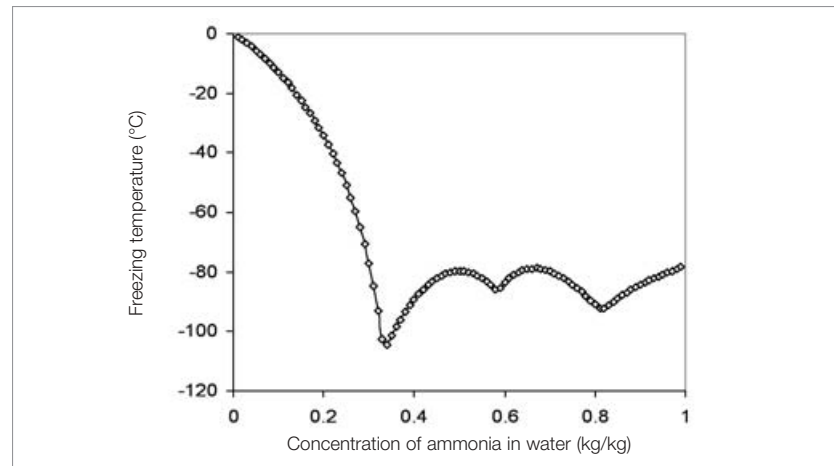

Figure 6: Eutectic curve for ammonia/water mixtures

methanol, nitrogen, oil and heavy hydrocarbons, sulphur dioxide and water. The implications of these are discussed below.

## Water

The presence of moisture encourages reactions, creating acids and subsequent corrosion, which is undesirable for good reliability of the system components. In the presence of moisture, ammonia can react with and corrode steel, copper, zinc, and many alloys although oil produces a film over internal surfaces which can effectively insulate metal surfaces against corrosion. Water will also react with other substances to form weak organic acids, which eventually react with oil to form a soapy sludge that can deposit throughout the system causing blocking and operational problems. Therefore an absence of moisture is preferred. Conversely, it is also reported that a small quantity of moisture is necessary to deter stress corrosion cracking (SCC) in steel particularly if oxygen is present. In addition to chemical reactions, there are other thermodynamic and physical effects caused by water, such as icing, loss of performance and erosion. In terms of icing, ammonia is very different from CO<sub>2</sub> and hydrocarbons because of its good solubility with water, and a low eutectic temperature of the mixture. Figure 6 shows the (rather unusual) eutectic curve of ammonia and water, which demonstrates that a very high concentration of water (above 80%) is required to produce ice under normal operating conditions; although of course at such concentrations, the saturation pressure would be extremely low. However, if the change in vapour pressure of an ammonia-water mixture is considered (Figure 7) the effect on system performance can be significant, and notable deterioration can occur at concentrations above 1%. Anecdotal reports suggest that water content causes erosion to valves and

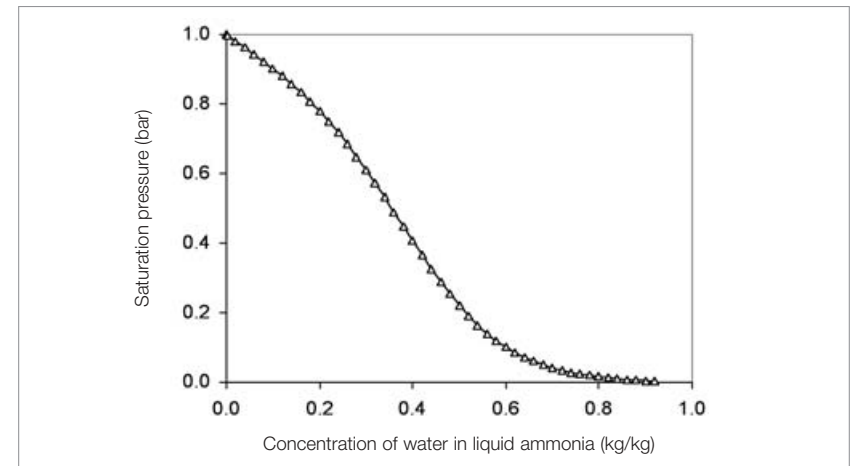

Figure 7: Vapour pressure of ammonia and water mixture at -36°C

other components, through increased cavitation when passing through orifices, and the effect of particulates such as rust (initially caused by the water).

### **Air; oxygen, carbon dioxide, nitrogen**

This will promote reactions with almost any other substance likely to be present in the ammonia, especially on the high side of the system (where it is likely to collect) given the high pressure/ temperature conditions. Additionally, oxygen of more than a few ppm in liquid ammonia or a few hundred ppm in gaseous ammonia can promote stress corrosion cracking (SCC) in carbon and low-alloy steels, and this is amplified at high pressures and high temperatures. CO<sub>2</sub> can react with ammonia to produce ammonium carbonate, and this is highly corrosive to steel. It is also reported that carbon dioxide in ammonia increases the chance of SCC. Nitrogen, along with oil and water cause nitriding, or the creation of weak acids, which lead to formation of sludge and corrosion. Therefore it is desirable to minimise concentrations of nitrogen. Also, the high pressure of nitrogen means that it will have a negative impact on the performance of the refrigerating system.

### **Methane and the other hydrocarbons**

These gases are likely to be present but are relatively benign and will not react under normal system operating conditions. However, the higher partial pressure of methane and ethane means that in sufficient proportions, they could impact on the performance of the refrigerating system. In particular, they have unusual characteristics when mixed with ammonia, and under certain compositions form metastable azeotropes which mean that the effect on system performance is difficult to anticipate.

### **Methanol**

Methanol is relatively stable in the presence of ammonia, so it will not decompose or create any undesirable substances. However, it has a NBP much higher than ammonia and therefore its presence has a similar effect to water, although the performance of a refrigerating system will be tolerant of methanol up to relatively high concentrations.

### **Sulphur**

Sulphur dioxide and hydrogen sulphide react with water and ammonia to form acids, which can lead to severe corrosion.

---

## **Final remarks**

---

The purity of natural refrigerants is as yet largely uncontrolled in terms of availability of international standards, yet it is evident that ensuring the use of high-specification product is essential to maintain system integrity. This is important for all the natural refrigerants, but is more so for hydrocarbons and carbon dioxide; using low quality gases can compromise both the reliability of the system and its performance on terms of cooling capacity and efficiency. Random analyses of various suppliers' natural refrigerant products have revealed a wide range of qualities, varying from very high purity, to products that contain a large number of gaseous contaminants, oil and water.

The presence of contaminants in a system can result in a variety of negative effects, including:

- Changes to the thermophysical properties of the working fluid.
- Chemical changes affecting the internal stability of the system.
- Physical changes that affects the structure of components and behaviour of materials.
- Toxicity implications if released from the system.

Therefore, when purchasing any natural refrigerant, it is of utmost importance to ensure that it is of a high specification and supplied in a cylinder used exclusively for that service. Similarly, end-users and system owners should be made aware that refrigeration-grade natural refrigerants exist, and that if not specified they could be risking degradation to system performance and operation, compromising reliability and introducing unnecessary safety risks.

---

## **References**

---

ISO/NP 12810, Fluorocarbon refrigerants – Specifications and test methods.

ARI 700, Specifications for Fluorocarbon Refrigerants, Air-Conditioning and Refrigeration Institute, USA, Jan, 2004.

DIN 8960 Kältemittel – Anforderungen und Kurzzeichen, Deutsches Institut für Normung E.V., Nov, 1998.

IIAR Specification for Ammonia Specification O-A-445B, International Institute for Ammonia refrigeration, 1110 North Glebe Road, Arlington, VA 22201, USA.

Lemmon, EW, Huber, ML, McLinden, MO. NIST Reference Fluid Thermodynamic and Transport Properties – REFPROP. Version 8.0. National Institute of Standards and Technology, Boulder, USA. April 2007.

# Phase out of R22 and then what?

ALEXANDER COHR PACHAI, Johnson Controls, Denmark

---

## Introduction

---

It is high time to do something about the R22 issue, but not many have realized that yet amongst the end users. There are a number of factors that indicate the route to go and the natural refrigerants are a good solution. Indicators like environment benefits and technical key points suggest that the most efficient solution can be a refrigeration plant based on natural refrigerants.

The natural refrigerants show good opportunities to solve the R22 phase-out dilemma but they are mainly for new installations only. The decision maker has to consider many factors before making the final choice.

---

## Background

---

As a consequence of the Montreal Protocol and of the following EU regulation implementing the amendment made to the protocol in 1992 in Copenhagen, one of the most popular refrigerants has been phased out in new installations. Now the time has come to phase-out virgin R22 as a service refrigerant for existing plants, as from 31st December 2009. After December 2014, it will be illegal to charge recycled R22 into a system; that is, if you can get any refrigerant at all.

Different figures are mentioned when discussing how much R22 is being recycled. Some refrigerant manufacturers estimate it to be between 2% and 5% of the actual consumption. If we assume that the recycled amount doubles between now and 2010, this will still not cover more than 10% of the actual amount needed.

Converting a refrigeration plant is not always as easy as us claimed by some stakeholders and a number of factors have to be taken in to consideration. Detailed calculations show that different refrigerants have benefits in different temperature regimes, and this is only the case provided some modifications are made to the plant. This raises the next question: who is going to carry out these modifications? It is difficult to get

qualified technicians in most countries that can do such a job. The closer we come to 2010 the worse the problem will become. Are the drop-in refrigerants proposed from different suppliers the only and best option?

In the Article 5 countries it should be possible to avoid making the same mistakes as we did in Europe. After the production has stopped, the supplies of recycled R22 will rapidly dry out as the charges leak in to the atmosphere. The fact is that almost all of the gases produced end in the atmosphere sooner or later, and that applied to all countries, regardless. It is in the interest of all parties to start the phase-out now rather than waiting for what will happen in some years.

### First the difficult question

Will there be enough qualified technicians to carry out the phase out? Many have tried to answer this tricky question. Most estimates say no; but the politicians saw that when the CFC's were phased-out, there was no problem, and so they believe we can do it again. We can do it but time is running out. There is one loser in this game if they wait too long, and that is the users of the R22 systems.

To make a good and successful conversion of a plant it has to be taken seriously and it has to be well planned. You have to go through the whole plant and have a look at all aspects. You also need to estimate the flow rates and the characteristics of the refrigerant you want to put in to the plant. Motors may have to be changed, bearing in mind that large motors can have a long delivery time. Liquid lines might have to be changed to avoid flashing in the liquid due to increased pressure losses. Even suction lines might need to be changed. Ultimately the whole plant might not be suited for retro fit.

The most straight forward projects are chillers. Many chillers are on the other hand already out dated and perhaps even changed. The expected lifetime of many popular chillers is not much more than 10 to 15 years so the last installed chillers are already more than half done. This means that the best solution will be simply to exchange it with a new unit with a similar capacity.

### The refrigerant

The whole issue is an environmental issue. It started with the debate about the ozone depletion which led to the well known Montreal Protocol signed in 1987. All along the way it was also known that global warming was taking place but it was not politically possible to include this question in the Montreal Protocol. As soon as the protocol was signed the discussions about global warming started, resulting in the Kyoto

meeting in 1997. The US administration suggested including the HFC, PFC and SF6 to the basket at a very late stage of the debate. The ironic bit was then that the US administration changed and George Walker Bush did not want to sign the Kyoto Protocol. It has later been signed by allies like Australia and also Russia. The only dominating nation staying out is the US.

The CFCs and HCFCs – including R22 and R123 – contain chlorine which has a damaging effect on the ozone layer that protects life on earth against dangerous ultra-violet waves from sunlight. This debate has long been forgotten because most people think this problem was solved long ago. The US managed to keep R22 on the market for many more years and the developing world is still allowed to use it for some years. Lately a meeting in Montreal resulted in a moving forward of the date of the final year of production of R22 from 2050 to 2040. China wants to signal more environmental awareness and has closed three production sites lately, and more were supposed to follow. This is all about the ozone layer.

Global warming is a totally different issue. Of course the CFC and HCFC gases also had an impact on global warming and therefore it would not have been irrelevant to include the debate in the Montreal Protocol, but that was how it was managed. The awkward situation is that some of the candidates to be used instead of HCFCs have an even higher global warming potential (GWP) than the gases they are replacing, see Figures 1 and 2.

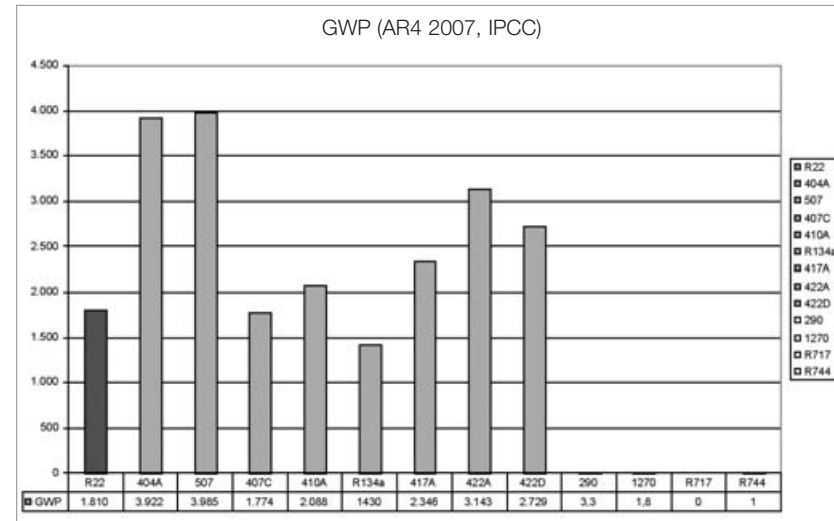

Figure 1 The GWP for R22 is here shown with some of the leading alternatives. (CO<sub>2</sub> is used as reference). The whites are natural refrigerants and are not subject to regulation

Discussions about emissions often include reference to both direct and indirect emissions. The direct contribution is the impact that the release of the refrigerant has on the environment transformed to CO<sub>2</sub> equivalents. The indirect effect is the CO<sub>2</sub> produced for making the energy available for the user to operate the system. These two values are used in the calculating the Total Equivalent Warming Impact (TEWI).

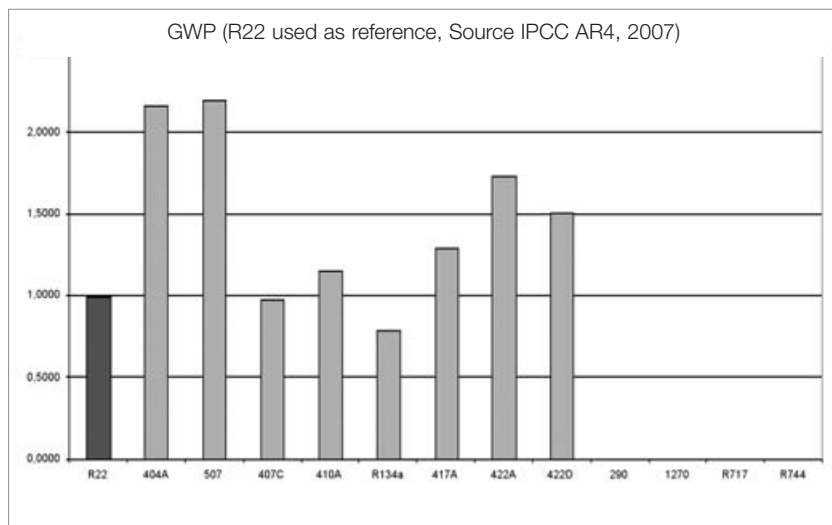

Figure 2: Here R22 is used as the reference and shows that most leading alternatives have a higher GWP than R22

The environmental issue is of course important but the technical issues should also be taken in to account. For this purpose you can dig in to a lot of details but in the following lets stick to simple models and ways of comparing. Figure 2 shows the environmental impact of some refrigerants. R407C and R134a are the only ones with a lower GWP than R22, whilst the natural refrigerants are the best in this comparison.

The mass flow has to be considered. In case of conversion of the plant it can cause greater pressure drops in the plant if the mass flow is increased in all parts of the system. This fact is sometimes ignored when comparing the efficiency of different refrigerants. In the case retrofit where the pipes are pre-existing ones, it is therefore a limiting factor when selecting the new refrigerant. In Figure 3, R407C seems to be a good fit. So does R410A but as we will see later there are other issues to this refrigerant. The mass flow in R717 is without comparison the lowest of all refrigerants. It must however be noted that ammonia is not compatible with copper, brass or any metals containing these metals. The plant has to be designed from the beginning to be suitable for both R22 and R717 if it is to be converted to ammonia after a very careful cleaning process.

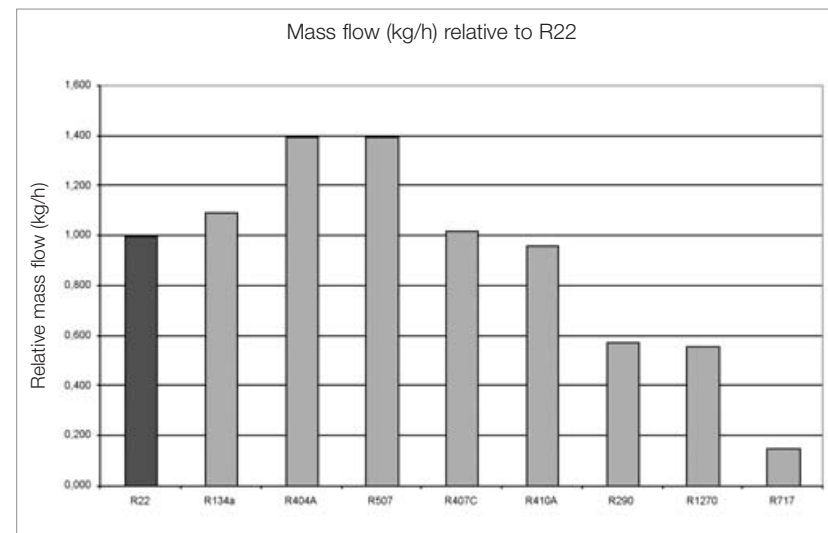

Figure 3: The mass flow has to be considered when selecting the dimensions of the pipe work, and it is also important when retrofitting a system. Too small pipes in the liquid line will have the result that the liquid can start flashing especially if it is not sub-cooled enough. (500 kW, T<sub>C</sub>=35°C/SUB=5 K/T<sub>E</sub>=-10°C/SUP=5 K)

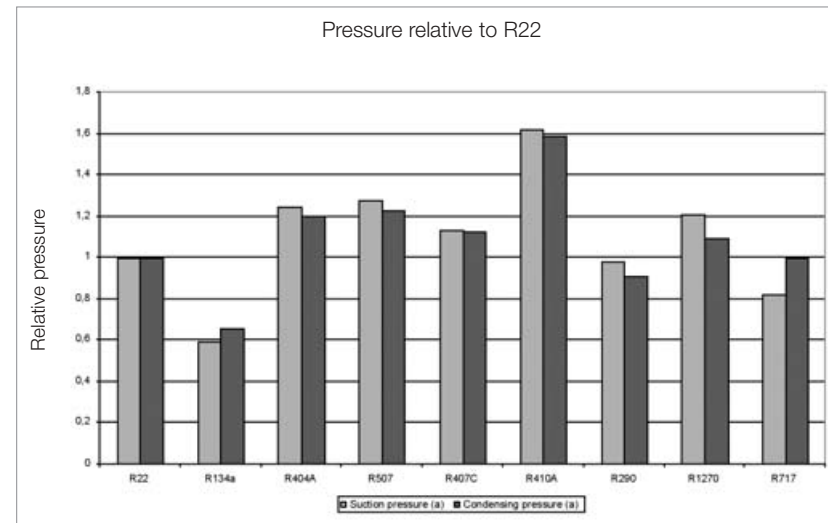

Figure 4: The most used alternatives have a higher pressure level than the baseline. This can be a challenge when retrofitting a plant if the system is taken to the limits. (T<sub>E</sub>=-10°C, T<sub>C</sub>=35°C)

Pressure codes can be a limiting factor when retrofitting from R22 to a new refrigerant. The strict rules laid down in the European Pressure Equipment Directive (PED) effectively prohibit the use of R410A for retrofit purposes. Also the higher pressures in the HFC alternatives have to be investigated before actions are made to retrofit the existing R22 plant. In the above example R134a is the refrigerant with least problems with the pressure and ammonia and propane come in as second and third here.

Coefficient of Performance (COP) is found by the cooling effect (in kW) divided by the power drawn (in kW) for achieving that cooling. This measure is getting increasingly important as the price on energy surges upwards. The data used is taken out of verified data found in freely available brochures. As there may be a little difference from brand to brand this may be discussed a little but the trend is the same.

Figure 5 shows that the natural refrigerants are the winners here with ammonia with highest value. In some cases propane is able to give better efficiency than ammonia, especially in warmer climates where the discharge temperature is a very limiting factor for the ammonia system. In heat pumps propane can also give warmer water than the synthetic refrigerants because it does not decompose to strong acids at elevated temperatures. However the material compatibility issue with ammonia is a limiting issue when it comes to converting a R22 system, since ammonia is not compatible with copper, brass and other alloys. As many R22 systems use semihermetic compressors, these cannot be converted in to ammonia systems.

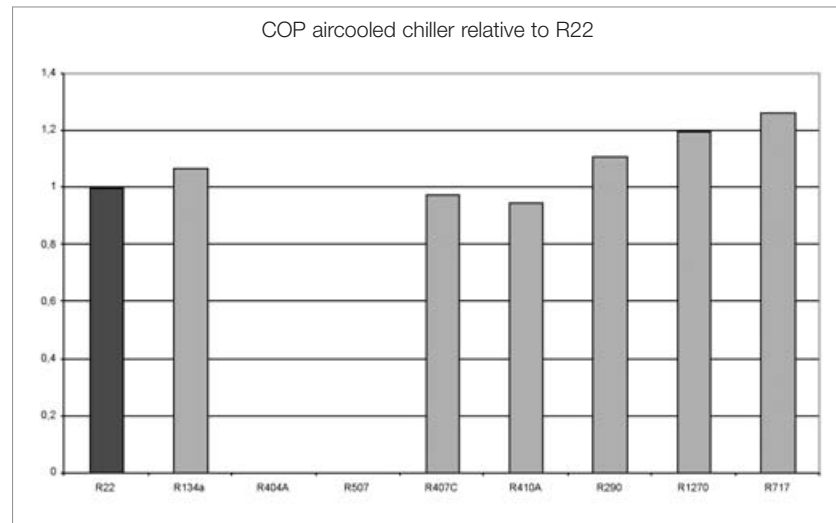

Figure 5: COP is of increasing importance as energy prices are going upwards. In this comparison R404A and R507 are not included since they are rarely used for the purpose. ( $T_W = 12^\circ\text{C}/7^\circ\text{C}$ ,  $T_A = 28^\circ\text{C}$ )

## What types of plants are there left?

Before looking at how to retrofit, it might be worthwhile looking at what types of systems you will find in the market. R22 has been used a lot in domestic air conditioning (AC) equipment. This type of equipment is relatively easy to retrofit to any other refrigerant. The expected service life of this type of equipment is about 7 to 12 years. With a last date of installation of this type of equipment will ensure that no major difficulties will be encountered in this market. Alternative products are already available in the market and are produced in millions every year. Most new equipment in the market today is using HFC.

Commercial compressors and equipment for supermarket systems have an average life of 10 to 15 years. It is therefore also possible to prohibit the use of R22 in due time before the final import and production deadline is reached. Still a lot of equipment is sold in this market both as factory made and as site-built systems. If we learn from what we have seen in Europe, the end users will use R22 until the last day and if possible also after the last day.

Light industrial chillers and equipment can have a quite long service life and they are designed for it. It is this kind of equipment that can stay in the market long after the final date of import and production of R22. This is the type of equipment that typically will have to be converted one way or the other. The majority of chillers in the market sales place are now produced with HFC.

Turbo chillers have a service life of more than 50 years. Now this is not the main market for R22 but for another HCFC, namely R123, which is also to be phased-out with R22. Some R22 turbo chillers have been converted in to R290/propane with good results and with minimum loss of capacity. The main suppliers have changed their production to HFC 134a. Only one of the major players has stayed behind with R123, but they will probably have to change their position as the political world has shown that the phase-out dates will not be prolonged.

## What is a preferred way to go?

This is a very political question but seen from a strategic point of view and analysing the situation as things developed and what Europe learned is another story. The last installations of R22 equipment in Europe was done in the late 1990s and in the beginning of 2000. Not much R22 equipment went out later than 1998 to the European industrial markets. There is however still some equipment out there that will need to be converted somehow.

Industrial equipment can many times be converted to either an HFC, alternatively to an HC or to ammonia. The use of ammonia requires skilled engineers, and for equipment based on semi-hermetic compressors and copper piping it is definitely not easy. Using HCs will in many cases require a major change of the whole plant if it open drive equipment. The choice of HFCs is therefore the most straight forward answer. If HC refrigerants are to be used the plant has to be designed for it and the site must be suitable as well. Outdoor installations are very straight forward to work with. They normally only require proper labelling at the entrance and a fence that will keep out unauthorised persons. Chillers will be the safest and most reliable solution, and products are readily available on the market. The price level for this equipment is a bit higher than the mainstream products, but there is no real reason for this except for the smaller volumes produced make them more expensive. Once the higher production volumes are there, there will be no reason why this equipment should be more expensive than the HFC systems.

---

## Conclusions

---

The political world needs to set the rules in due time to avoid that the industry violating them deliberately. An early announcement and ending of installation of R22 systems long before the service life of the equipment is reached is an advantage. Only few owners will then be affected by the phase out.

The comparisons from different data show that the natural refrigerants are an obvious alternative to R22. However if you have to comply with current regulations these options are mostly for new installations. When selecting to retrofit your plant it is very important to consider many different views in your decision process. Otherwise you will be penalised one way or the other. There are so many aspects to consider when converting a system that in many cases it is not possible for the contractor or manufacturer to give a firm price and warranty on the conversion.

The phase-out of R22 must happen and the challenges derived from it have to be overcome. Propane is a good alternative if this is the refrigerant you want to use. It will be necessary to go over the plant to evaluate whether it is a good idea or not. Also the plantroom or site must be evaluated. Technically there are no problems with it.

In many countries the biggest blockage for the use of HC refrigerants is education and proper training. Technically propane is very similar to R22 except for the fact that it is flammable. Once this is understood how you prevent accidents, these refrigerants are very nice to work with.

# Capacity Control of Refrigeration Systems with Screw Compressors and Economizer

DR. DIETER MOSEMANN and DR. DMYTRO ZAYTSEV, Grasso GmbH Refrigeration Technology, Germany

---

## Introduction

---

Global warming due to the greenhouse effect and actions for reducing the CO<sub>2</sub> emission are issues attracting more and more public interest. The German Federal Government aims at reducing the CO<sub>2</sub> emission by 20 to 30% by 2020. In order to reach this goal, the development and introduction of renewable energy sources must be supported by actions to be taken by the energy consumers. The refrigeration technology is concerned in a special way as the CO<sub>2</sub> equivalent of some refrigerants must be taken into consideration as direct greenhouse potential in addition to the total primary energy supply for operating the refrigeration system. Both CO<sub>2</sub> portions can be influenced, on one hand by selection of the refrigerant, on the other hand by the system circuitry for cold generation. The refrigeration technology has a share of approx. 6% in the total primary energy consumption in Germany. Thus, special importance is attached to the reduction of the primary-energy consumption. This issue has been dealt with several times for full-load operation also in comparison to the CO<sub>2</sub>-NH<sub>3</sub>-cascade refrigeration system /1/, /2/, /3/.

This paper refers to applications of industrial refrigeration using ammonia as the refrigerant; however, the statements are not intended to be limited to that. The paper is intended to appeal to plant manufacturers to contribute to the reduction of the greenhouse effect by increasing the efficiency choosing the correct technical solution.

---

## Outline of research setting

---

In refrigeration systems for industrial applications ammonia is used mostly. It has the CO<sub>2</sub> equivalent of nil – a positive environmental aspect. Thus, measures for reduction of the greenhouse effect can concentrate exclusively on the energy consumption of the refrigeration system. Large refrigeration systems with evaporation temperatures below -35°C are investigated which are designed either single-stage with economizer



(Variant (1)) or two-stage (Variant (2)), and can be found in cold stores, in food product industry or in process cooling. Both variants are investigated in full-load and part-load operation and rated ecologically. Evaluation criterion is the COP – the ratio of refrigerating capacity to required power input – representing the useful effect of the power input applied. In this paper, both the reduction in energy consumption and of environmental load are expressed by the COP value. All data contained in the paper apply to an operating point of evaporation temperature ( $t_0$ ) = -40°C and condensing temperature ( $t_c$ ) = +35°C, and with ammonia as the refrigerant.

The numbers of packages (a package consists of screw compressor, electrical motor, oil separator, oil cooler, pipes and control system, assembled as a unit) made by Grasso GmbH in 2006 show that out of the ammonia screw compressor packages delivered only 23% were designed in Variant (2), but 77% in Variant (1). Both variants are investigated here in full-load and part-load operation.

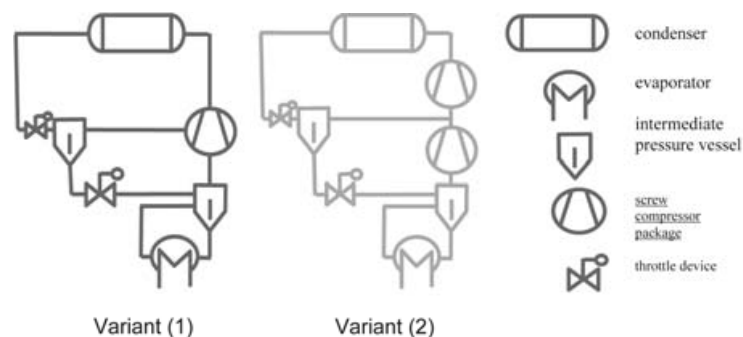

Figure 1: Schematic representation of refrigerant circuits. Variant (1): Single-stage compression combined with economizer coupling. Variant (2): Two-stage compression combined with intermediate-pressure vessel

### Variant (1), single-stage compression combined with economizer coupling

#### Full-load operation

Variant (1) is characterized by single-stage compression and two-stage expansion at first from condensing pressure into an intermediate-pressure vessel, and then from the intermediate-pressure vessel to evaporation pressure. In full-load operation, the flash vapour generated first is forced at intermediate pressure into interlobe spaces of the rotors already disconnected from the suction. That is the economizer coupling. In an abstraction, the “single-stage compression” can be divided into two sections, a first LP section ahead of the economizer connection where the fluid taken in from the evapo-

erator of the refrigeration system is pre-compressed, and a second HP section after flash vapour feeding where the fluid compressed and the flash vapour are compressed together to condensing pressure (see also Figure 15). The flash vapour volume decreases with increasing intermediate pressure, the swallowing capacity at the economizer port on the compressor increases with increasing intermediate pressure.

The maximum refrigerating capacity is obtained when the swallowing capacity and the flash vapour volume coincide at the “balance intermediate pressure”  $p_a = p_z = f(t_a = t_z)$ , where  $p_a$  is the pressure at the economiser port of the screw compressor,  $p_z$  is the pressure at the intermediate pressure vessel,  $t_a$  is the saturated temperature of refrigerant at  $p_a$ ; and  $t_z$  is the saturated temperature of refrigerant at  $p_z$  (Figure 2).

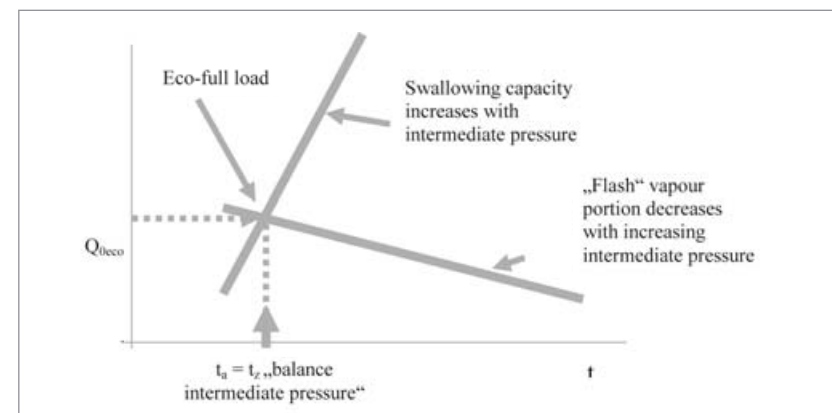

Figure 2: Economizer – full-load operation (where  $Q_0$  refers to the refrigerating capacity)

At the balance intermediate pressure, there exists equilibrium between the swallowing capacity of the compressor and the flash-vapour volume (intersection). The swallowing capacity at the economizer port depends on the compressor. Two principal variants of arranging the economizer port on the compressor are considered (see Figure 3):

- Arrangement in housing (fixed), case A
- Arrangement in control slide (movable), case B.

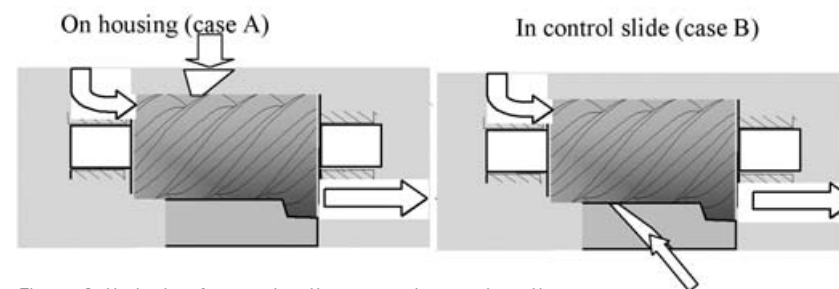

Figure 3: Variants of arranging the economizer port on the compressor

In case A, the process of superfeeding starts at the beginning of compression with maximum interlobe volume. The compressor has the maximum swallowing capacity at the economizer port (Figure 4). At first sight, the arrangement according to case B seems to be useful as this arrangement permits an economizer coupling also in part-load operation. As the economizer port is arranged in the control slide, it is displaced together with the control slide. However, the process of superfeeding can start only after the following lobe profile of an interlobe space considered into which the flash vapour is intended to enter has passed the suction-side edge of the control slide so that this interlobe space is closed again with relation to the economizer port (see Figure 5). Thus, the compressor has a smaller swallowing capacity in this case, and hence a higher balance intermediate pressure (see Figure 6).

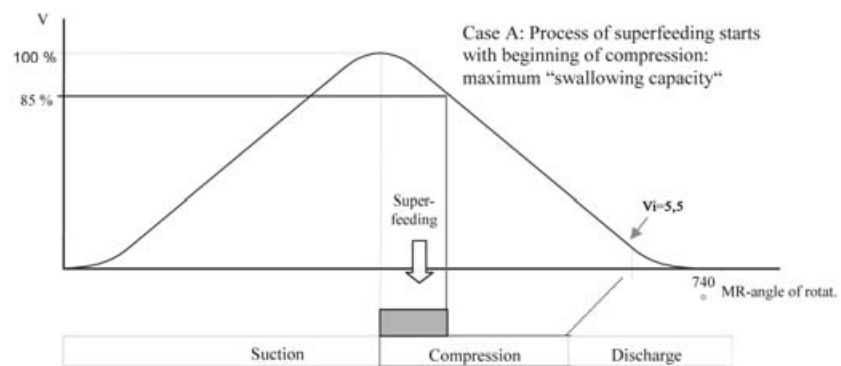

Figure 4: Case A, Volume diagram as function of angle of rotation of male rotor and operating phases

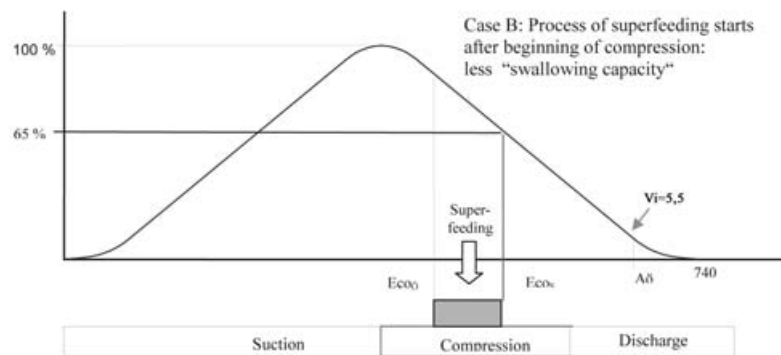

Figure 5: Case B, Volume diagram as function of angle of rotation of male rotor and operating phases

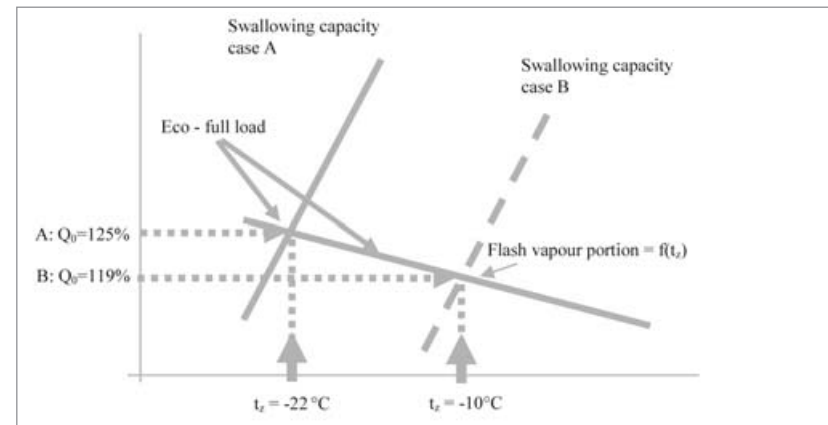

Figure 6: Balance intermediate pressures for case A (corresponds to  $t_z = -22^\circ\text{C}$ ) and B (corresponds to  $t_z = -10^\circ\text{C}$ ), and a resulting gain in refrigerating capacity at full-load operation, case A: 125%, case B: 119%, both for refrigeration system Variant (1)

### Part-load operation

For part-load operation, the slide control, speed control and the economizer intermediate-pressure control were examined.

#### Slide control

The principle of slide control is shown in Figure 7. The flow rate can be changed stepless. Due to the axial displacement of the control slide, a part of the housing wall is opened enclosing the rotors. The entrapped working fluid can escape from the decreasing geometric volume till the following lobe profile of an interlobe space considered has passed the uncovered interlobe space.

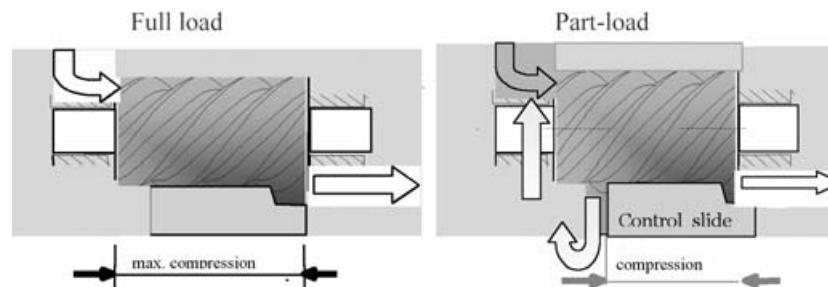

Figure 7: Change of effective rotor length by displacement of control slide

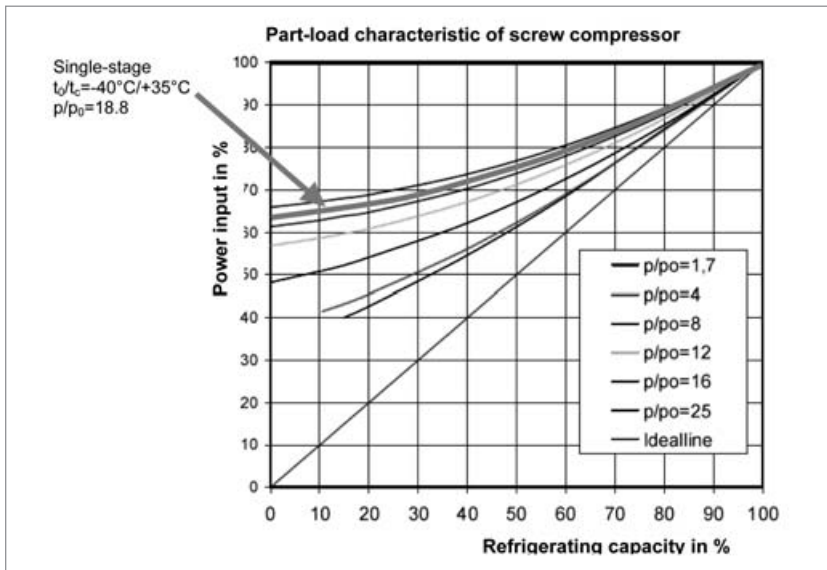

Figure 8: Part-load characteristics of the screw compressor unfavourable for high pressure ratio with single-stage compression

The screw compressor efficiency decreases with increasing pressure ratio as can be seen in Figure 8. At 50% refrigerating capacity and  $t_0/t_c = -40^\circ\text{C}/+35^\circ\text{C}$  (corresponds to a compression ratio, being the discharge pressure over suction pressure,  $p/p_0 = 18.8$ ) approximately 75% of power input are required. In part-load operation, this rather unfavourable operating characteristic is superposed by the economizer effect, if the economizer port is arranged in the control slide (Case B).

At part load, the arrangement of the economizer port according to case A yields no economizer effect at all as the flash vapour is expanded to suction pressure. Due to the position of the economizer port in the control slide, the arrangement of the economizer port according to B is only in a small part-load segment between 75% and 100% of the refrigerating capacity more favourable than case A. At even smaller refrigerating capacities the economizer effect (at the same slide position higher refrigerating capacity) causes the control slide to be displaced even more into the part-load region than without economizer coupling so that the part-load curve of the control slide will dominate (Figure 8). Due to superposing of the unfavourable part-load characteristic at a pressure ratio of 18.8, the advantage of the economizer coupling with arrangement of the economizer port according to case B cannot be compensated (see Figure 11).

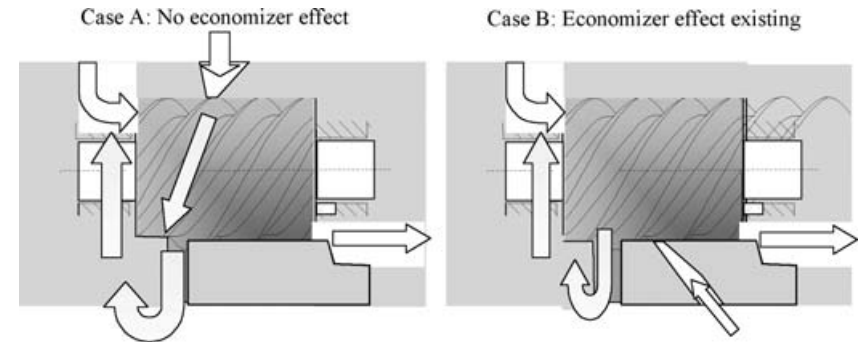

Figure 9: Case A and B at part load

In the lower part-load region, the possibility of economizer coupling is limited by the simultaneous opening of the economizer port and the discharge (see Figure 10). For this reason, Case B is not used in large screw compressors. It has been examined here only for the sake of completeness.

#### Speed control

Speed control is an alternative to slide control. It is often combined with slide control, for instance speed control from 1500- 3600  $1/\text{min}$ , and below 1500  $1/\text{min}$  – slide control (see Figure 11, curve: single-stage, economizer, frequency converter FC). Speed control requires a frequency converter (FC). Associated loss due to frequency conversion is not taken into consideration here. The deterioration of the electric efficiency by approx. 1% in full-load operation remains also unconsidered so that the statements made refer solely to the compressor.

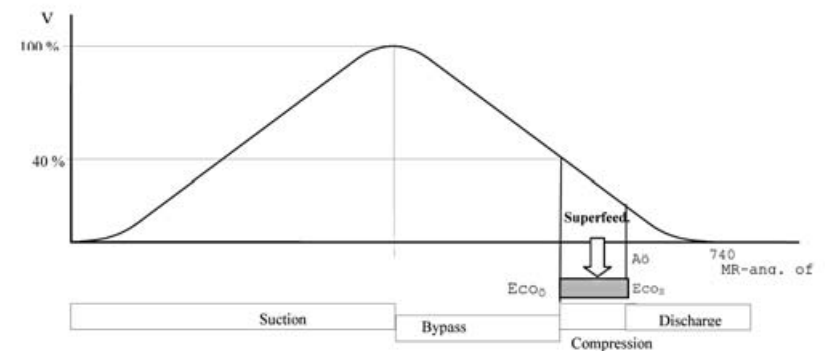

Figure 10: Case B at part load < 40%: Economizer port connected to an interlobe space open towards the discharge: No economizer effect

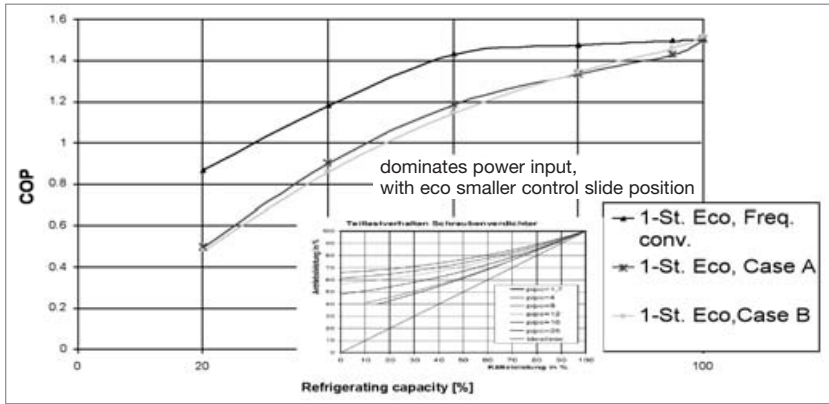

Figure 11: Variant (1) COP at full load and part load for speed control with arrangement of economizer port, case A (single-stage, economised, FC), and slide control with arrangement of economizer connection port on housing (single-stage, economised, case A), and in control slide (single-stage, economised, case B)

In part-load operation, speed control represents the best solution for Variant (1) from a viewpoint of energy efficiency. Even though the economizer effect is maintained with speed control, the COP will decrease at lower speed as the gap losses will dominate with relation to the smaller suction volume flow.

#### Intermediate-pressure control

With intermediate-pressure control, the pressure in the intermediate-pressure vessel is increased starting from the “balance intermediate pressure” for the purpose of decreasing the refrigerating capacity. To this end, the regulating valve  $V_z$  between the outlet of the intermediate-pressure vessel and the economizer port of the compressor is throttled. The control slide remains in full-load position. The refrigerating capacity is changed by more or less throttling as can be seen from Figures 12 and 13.

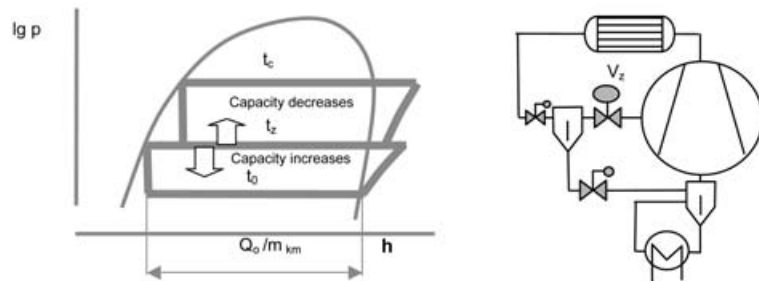

Figure 12: Principle of intermediate-pressure control in p-h diagram and simplified system schematic with regulating valve  $V_z$  between outlet of intermediate-pressure vessel and economizer port of the compressor

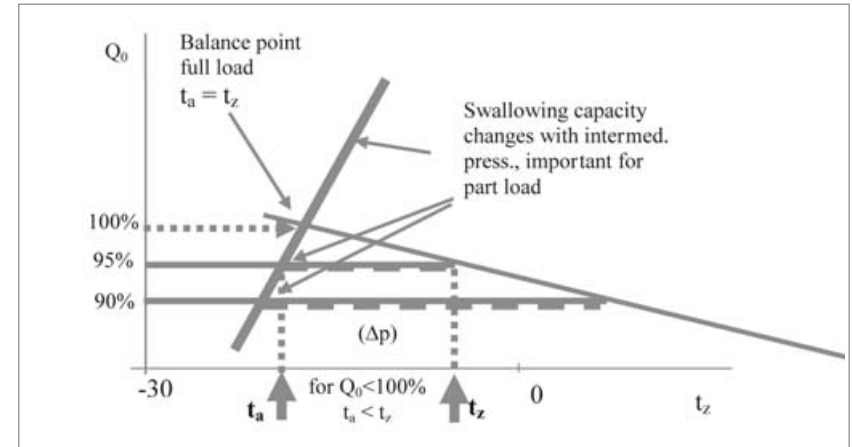

Figure 13: Intermediate-pressure control

The intermediate-pressure control was carried out for a screw compressor with economizer port (arrangement, case A). Due to the excessively high heat of evaporation of ammonia (Figure 14), with this mode of regulation, the refrigerating capacity can be changed only in a very small range of refrigerating capacities between approx. 85% and 100% (see Figure 15). For fluorinated hydrocarbons, e.g. R507, the control range is considerably wider.

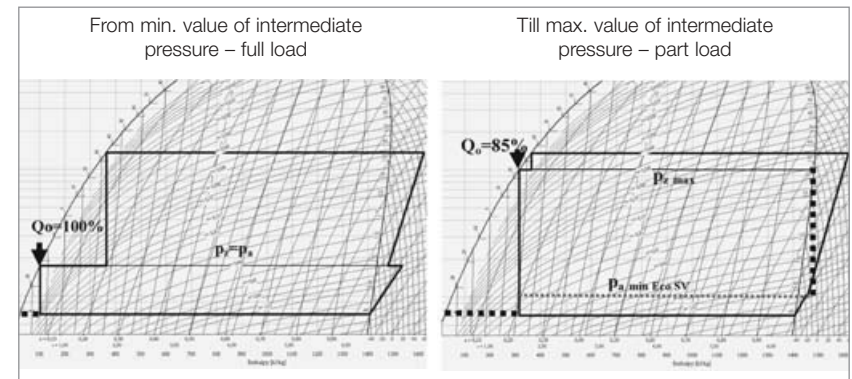

Figure 14: Intermediate-pressure control in Ph diagram, refrigerant  $\text{NH}_3$

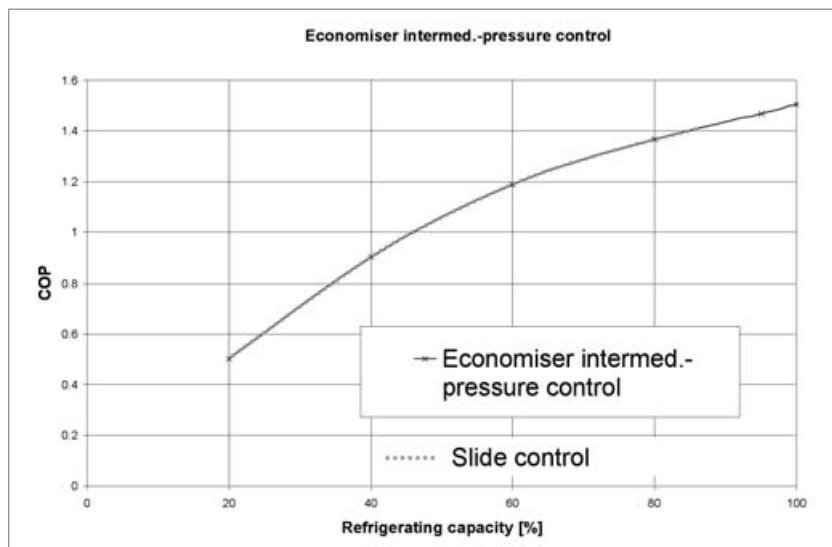

Figure 15: COP part load: Intermediate-pressure control in upper capacity range; Slide control from < 85% refrigerating capacity

### Variant (2), two-stage compression with intermediate-pressure vessel

The condensate is expanded in two stages as in Variant (1), in a first stage from condensing pressure into an intermediate-pressure vessel, and in a second stage from the intermediate-pressure vessel to evaporation pressure. “Flash” vapour of the first stage of expansion is fed to the compression at intermediate pressure. In Variant (2), the partial sections of compression of Variant (1) will be replaced by two separate compressors, one low-pressure compressor (LP) and one high-pressure compressor (HP) arranged one after the other without intermediate cooling (Figure 16). The HP compressor is operated with suction superheat of approximately 50 K. Due to the intensive cooling of the compression process by oil injection into the working space, the oil-flooded screw compressor permits this mode of operation of the HP compressor with high suction superheat without exceeding the permissible discharge temperature of 90°C on the discharge side. The refrigeration processes of both Variants (1) and (2) shown in the Ph diagram (Figure 16) do not differ from one another. However, both variants considerably differ from one another by the efficiency. The COP of Variant (2) is in full-load operation by approx. 20% higher than with single-stage compression and economizer coupling ( $t_0/t_c=-40^\circ\text{C}/35^\circ\text{C}$ ). A comparison of Variant (2) with a classical two-stage refrigeration system in which the discharge gas after the LP compressor is recooled to the

condition of saturated vapour shows that Variant (2) attains the same COP. This shall not be treated any further in this connection as the classical two-stage system would require two complete screw compressor packages, which would entail remarkably higher investment costs.

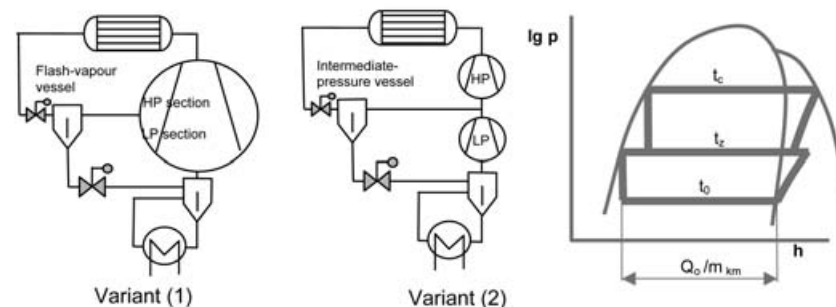

Figure 16: P&I and p-h diagram for single-stage refrigeration circuit with economizer and two-stage refrigeration circuit with intermediate-pressure vessel

### Variant (2) in full-load operation

Differently from Variant (1), the balance intermediate pressure is a consequence of the HP-compressor choice. A larger HP will decrease the balance intermediate pressure, while a smaller one will increase it. The HP-compressor choice aims at the maximum COP at full load.

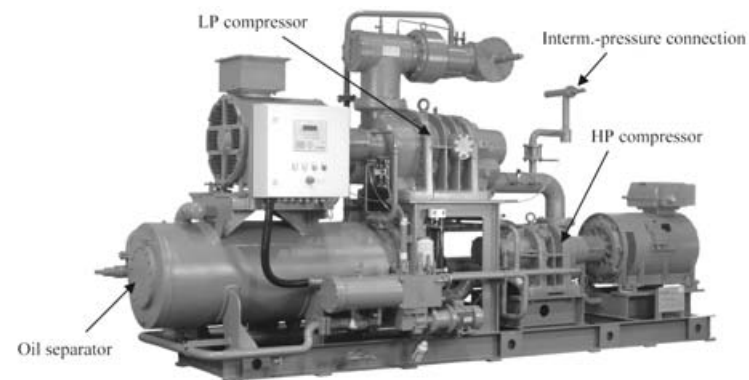

Figure 17: Two-stage screw compressor package, Grasso GmbH, Low-pressure compressor LP and high-pressure compressor HP „in series” with intermediate-pressure connection, both compressors with slide control

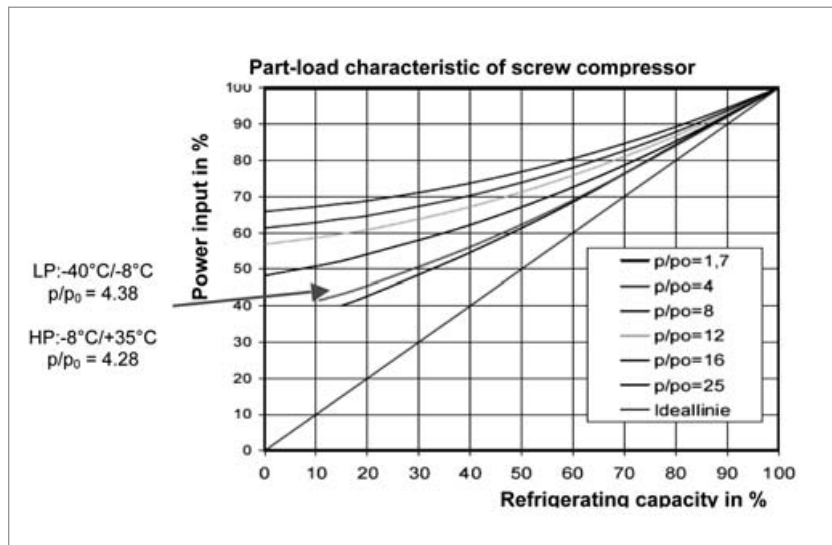

Figure 18: Part-load characteristic of LP and HP in refrigeration operation

### Variant (2) in part-load operation

In part-load operation, the evaporation pressure and the balance intermediate pressure are separately controlled by change of the swept volume of both compressors.

#### Slide control

Both compressors, LP and HP, feature slide control. Due to the smaller pressure ratios of approx. 4.4 on both LP and HP compressor, the required power input differs considerably from that of single-stage compression (see Figure 8). At 40% refrigerating capacity, 55% each of the required power input are necessary for LP and HP so that the two-stage refrigeration system offers advantages in efficiency also over a wide part-load range compared to single-stage compression with economizer coupling.

#### Speed control

In this instance, both compressors, LP and HP, feature speed control over the range 1500 to 3000 1/min. In the lower refrigerating capacity range, it is slide-controlled at a constant speed of 1500 1/min. By the way, this combination permits also unloaded start-up of the screw compressors. For this purpose, the control slide is moved into its minimum position prior to start-up of the compressor. At the part-load operation with the speed control, the required power input is lower (see Figure 19) than with the slide control at the constant speed of 2940 1/min. The COP characteristics for both part-load control modes are given in Figure 20. The decision as to one or the other control

mode should be made depending on the part-load requirements. A combination of speed control for LP and slide control for HP is also possible. These variants have not been studied in detail here.

### Comparison of Variants (1) and (2) in full-load and part-load operation

The comparison of variants refers to industrial refrigeration systems on ammonia for an evaporation temperature of -40°C and a condensing temperature of +35°C. The comparison of Variants (1) and (2) reveals an environment saving potential both in full-load and part-load operation, if the single-stage compression with economizer coupling is replaced by two-stage compression with two-stage expansion of the refrigerant (see Figure 21).

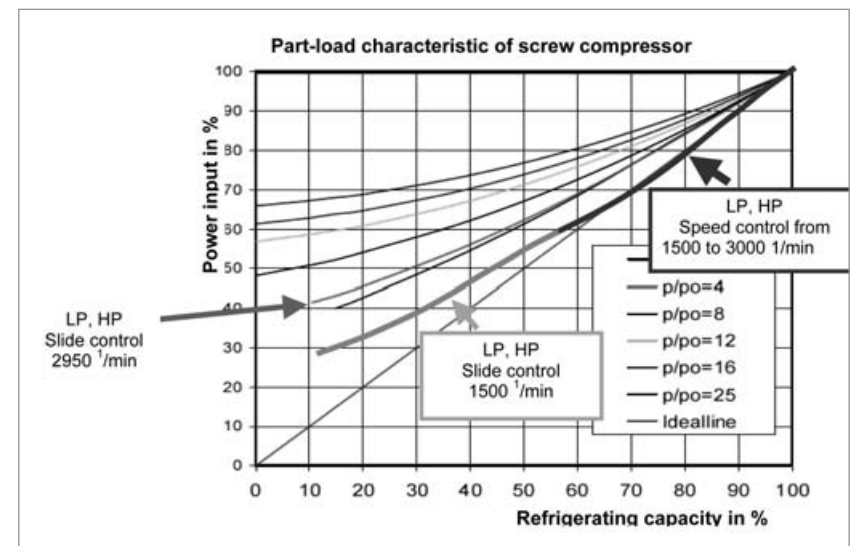

Figure 19: Comparison of slide control/speed control for HP and LP

The efficiency expressed by the COP, differs for Variant (1) only slightly in the part-load region, except for the speed control realizing the positive effect of the economizer coupling. Both the intermediate-pressure control and the slide control do not differ from one another neither in full-load nor in part-load operation in relation to the COP for Variant (1). The two-stage refrigeration system Variant (2) offers a potential of reducing environmental load on up to 50% compared to the single-stage refrigeration system with economizer. Despite the slide control, between 30% refrigerating capacity and full load, the part-load efficiency of two-stage screw compressor packages is higher than that of a single-stage screw compressor package with economizer coupling and speed control.

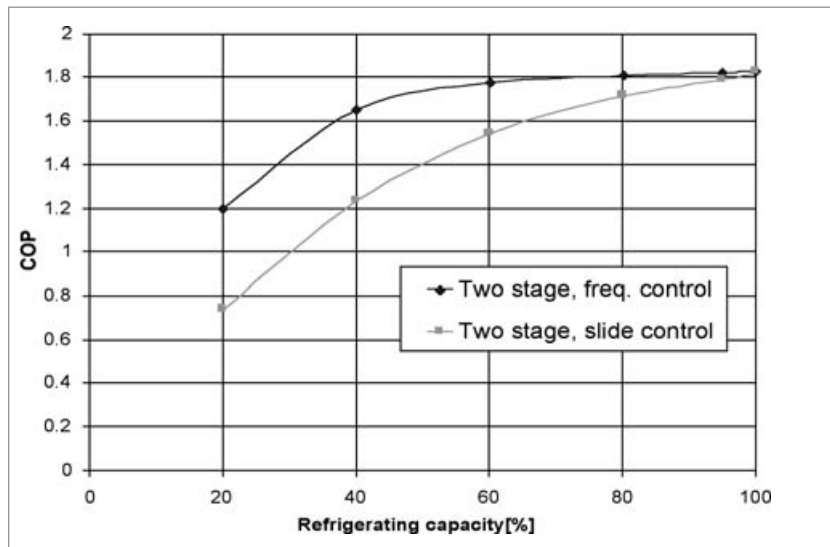

Figure 20: Part-load COP for slide control and use of frequency converter (speed control) for HP and LP

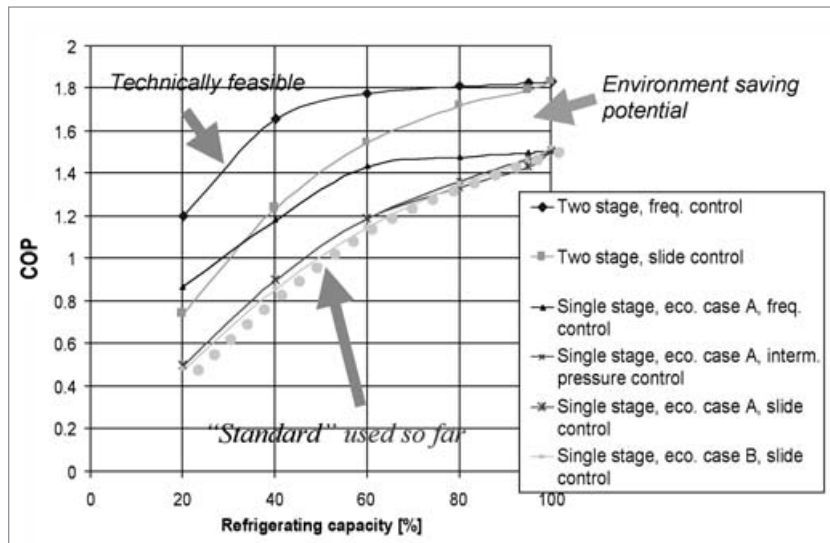

Figure 21: Part-load and full-load COP for Variants (1) and (2)

## Practical application and environmental consequences

Grasso is manufacturer of screw compressor packages of both variants and delivers one or the other variant upon customers' request. In 2006, 23% of the screw compressor packages were delivered for evaporation temperatures below  $-35^{\circ}\text{C}$  according to Variant (2) for industrial applications competing with Variant (1). For instance, 4 large low-temperature stores having a total refrigerating capacity of 14 000 kW and operated at an evaporation temperature of  $-40^{\circ}\text{C}$  against a condensing temperature of  $+35^{\circ}\text{C}$  require screw compressors having a total swept volume of 73 000  $\text{m}^3/\text{h}$ . In this case, the calculated total required power input is approx. 7.8 MW. Would these low-temperature stores have been designed with a system configuration according to Variant (1), a required power input of 9.6 MW would be necessary. The table shows the influence on running-cost savings and on environment saving by the use of two-stage packages for these 4 cold stores. However, they represent only part of the screw compressor packages delivered for similar applications featuring an evaporation temperature below  $-35^{\circ}\text{C}$ .

If once in a year all customers of Grasso GmbH for this range of application would decide on Variant (2), the  $\text{CO}_2$  emission into the atmosphere could be reduced by 20 000 t (full-load operation) per year. With a combined part-load and full-load mode of operation being running-time evaluated, the potential of reducing environmental load can be even higher.

	Variant (1)	Variant (2)
<b>Required power input:</b>	<b>9.600 kW</b>	<b>7.780 kW</b>
<b>Conclusion:</b>		$\Delta = 1820 \text{ kW}$ less power input required
<b>With 4500 operat. hrs/p.a.:</b>		
✓ Less electrical energy		- 8.2 Mio kWh/p.a.
✓ Less running costs:		- 1 116 800,-€/p.a.
✓ Saving of environment:		
✓ reduced $\text{CO}_2$ emission:		- 4 670 t/p.a. )*
<b>And: 8.2 Mio kWh/p.a. less heat emission to the environment</b>		
* Conversion factor $0.57 \text{ kg CO}_2/\text{kWh}$ , source: eurammon		

Table 1: Potential of reducing environmental load of 4 low-temperature stores designed in Variant (2) compared to Variant (1)

---

## Conclusion

---

Refrigeration systems for industrial applications ( $t_o < -35^\circ\text{C}$ ) are designed single-stage with economizer coupling or two-stage. The economic efficiency of both variants remarkably differs from one another. With single-stage compression and economizer coupling, the full-load COP is 20% below the COP of two-stage compression. The gain in efficiency by economizer coupling completely diminishes in part-load operation below 85% refrigerating capacity, if screw compressors with slide control are used. Despite the slide control, between 30% refrigerating capacity and full load, the part-load efficiency of two-stage screw compressor packages is higher than that of a single-stage screw compressor package with economizer coupling and speed control. An enhancement of the part-load COP by speed control is also feasible for two-stage screw compressor packages.

As seen from a viewpoint of the environment saving, there should be no "business as usual" in the years to come. The technology for reducing  $\text{CO}_2$  emission is available. Two-stage screw compressor packages offer the prerequisite for reducing  $\text{CO}_2$  emission. The environmentally friendly variant is also the variant with the lowest running costs.

---

## References

---

- /1/ P. Kolberg:  $\text{NH}_3$ -Chiller für die Erzeugung von Kaltsole ( $\text{NH}_3$  chiller for generation of chilled brine); DKV-Tagung 1994, Bonn
- /2/ P. Kolberg:  $\text{NH}_3$ -Chiller für die Erzeugung von Kaltsole ( $\text{NH}_3$  chiller for generation of chilled brine); KI 02/1995
- /3/ F. Müller u.a.: Anwendung natürlicher Kältemittel im Verdampfungstemperaturbereich  $-54^\circ\text{C}$  bis  $-35^\circ\text{C}$  (Use of natural refrigerants over an evaporation temperature range from  $-54^\circ\text{C}$  to  $-35^\circ\text{C}$ ); DKV-Tagung 2006, Dresden.

# Propane as an Alternative to R22 for Small Refrigeration Systems at High Ambient Temperatures

DR. HEINZ JÜRGENSEN, Danfoss Compressors GmbH, Germany

---

---

## Introduction

---

Propane (R290) has been discussed as replacement for CFCs and HCFCs since the late 1980s. It has a long history in refrigeration and is thus an interesting candidate. The flammability, however, has limited its use. While isobutane (R600a) has been introduced in household appliances in Western Europe from the start of the CFC phase out, R290 had been introduced later, thus replacing R134a, R22 or R404A in some appliances. In Europe, the first countries phased out R22 in 1998 and 2000. For the whole European Union the phase-out date was 1st January 2004 for new applications. Some commercial refrigerated appliances were converted to R290 and have now been in production for several years. In many parts of the world R22 is the most commonly used refrigerant in refrigeration and stationary air conditioning. The planned phase-out of this refrigerant, which still has some ozone depletion potential, is thus a major task. This paper deals with the replacement of R22 in small hermetic systems, typically found in commercial refrigerated appliances. This use of R22 is growing rapidly in evolving markets.

---

## Refrigerant propane in comparison

---

From a thermodynamic point of view propane is nearly an ideal replacement for R22. Comparing these two, also with other candidates for small commercial appliances, R290 performs quite well. The thermodynamic and physical properties are well suited for design of small hermetic compressors and systems.

For countries with high ambient temperatures or high humidity such conditions adds to the thermal load of a system, and therefore some important points should be compared. The comparison is done for a medium back pressure (MBP) application, such as a bottle cooler or commercial refrigerator with  $-10^\circ\text{C}$  evaporating temperature, and a low back pressure (LBP) application, such as a commercial or ice cream freezer with



-35 °C evaporating temperature. For household and similar appliances, the design ambient temperature for tropical application is 43 °C, which is taken as reference here. This results in condensing temperatures of above 50 °C, and on MBP somewhat above 55 °C. Refrigerants taken into the comparison are R22, R290, R134a, R404A and R600a. Refrigerants with large temperature glide are not discussed.

Limit	R22	R290	R134a	R404A	R600a
condensing MBP max (°C)	50 to 55	55	55 to 60	50 to 55	55 to 60
condensing LBP max (°C)	50	55	55 to 60	50	55 to 60
evaporating LBP min (°C)	-30 to -40	-40	-30 to -35	-40 to -45	-30 to -35

Table 1: Application limits typical for small hermetic compressors with different refrigerants

From table 1 it is seen, that R134a and R600a are more compatible to higher ambient temperature, as they allow higher condensing temperatures. This is amongst others due to lower pressures, which unfortunately also lead to lower volumetric capacity. This means, the necessary compressor swept volume increases. With higher ambient temperature, however, the required capacity typically increases because of a higher heat load. This could be covered with R22 or R404A. But these two have often, at least for LBP applications, limitations in condensing temperature to 50 °C, which is difficult or impossible to keep at 43 °C ambient. Propane seems to be a very good matching compromise here, reaching down to -40 °C evaporating and up to 55 °C condensing for LBP applications.

## Background of limits

The basis for the application limits specified for small hermetic compressors is found in the design. The compressors are designed with respect to

- Maximum discharge pressure
- Maximum pressure difference
- Maximum discharge temperature
- Maximum pressure ratio
- Limitations in heat rejection and some more details. Going into the thermodynamic data of the refrigerants, it can be shown, which refrigerants are possibly more suited for a selected application.

The compressors to be used with R290 have to be designed and released for R290 to avoid reliability problems. Compressors designed for R22 or R404A should not be used without the manufacturer's permission.

For the comparison two conditions were chosen, which represent operation of a commercial freezer display case and a bottle cooler at high ambient temperature.

- LBP - Freezer evaporating/condensing/return (suction) gas at -35/50/20 °C
  - MBP - Bottle cooler evaporating/condensing/return (suction) gas at -10/55/20 °C
- For some comparisons the condensing temperature or return (suction) gas temperature are varied.

## Pressure

Figure 1 shows the vapour pressure curves of the named refrigerants over temperature. The pressure axis is limited to 25 bar, which is a typical value for maximum discharge pressure. With the discharge pressure also the pressure difference at the piston and forces on the mechanical parts grow.

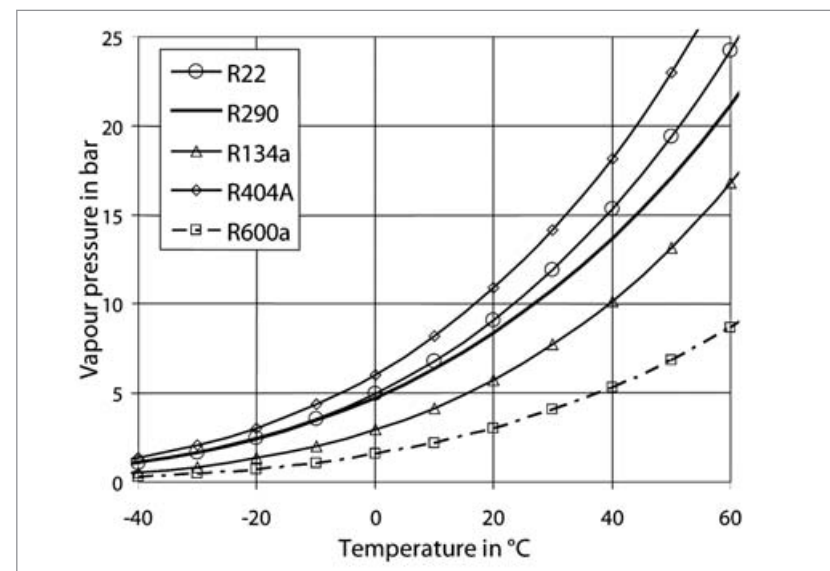

Figure 1: Vapour pressure curves of refrigerants

R404A does exceed the 25 bar slightly above 50 °C. The other four refrigerants stay below 25 bar at 60 °C. Thus the limit on condensing temperature might be based on discharge temperature or pressure ratio. The volumetric refrigerating capacity is a value that is strongly depending on the evaporating pressure. This value describes the refrigeration capacity delivered at given conditions by pumping e.g. 1 m<sup>3</sup>/s of refrigerant vapour. This means, that lower pressure refrigerants need more pumping volume and larger tubes for same refrigeration capacity need. For commercial refrigerated appliances R600a thus is limited to small units. R134a can serve for larger units, but the major use is R22 and R404A.

## Pressure ratio

Figure 2 shows the pressure ratio of the named refrigerants with  $-35\text{ }^{\circ}\text{C}$  evaporation fixed, with increasing condensing temperature. The two refrigerants with lower pressure levels, R134a and R600a, show higher pressure ratios than the others. This results in higher impact of dead volume in the compression chamber and is a reason for the limitation in evaporating temperature downwards and the condensing temperature upwards.

R404A shows slightly lower ratios than R22, but R290 shows the lowest pressure ratio level of all the 5 chosen refrigerants. This means, that the pressure curve of R290 is lower in slope than that of R22, having almost same level at around  $-40\text{ }^{\circ}\text{C}$ . This means, that a R290 compressor has a good chance to perform well at LBP conditions.

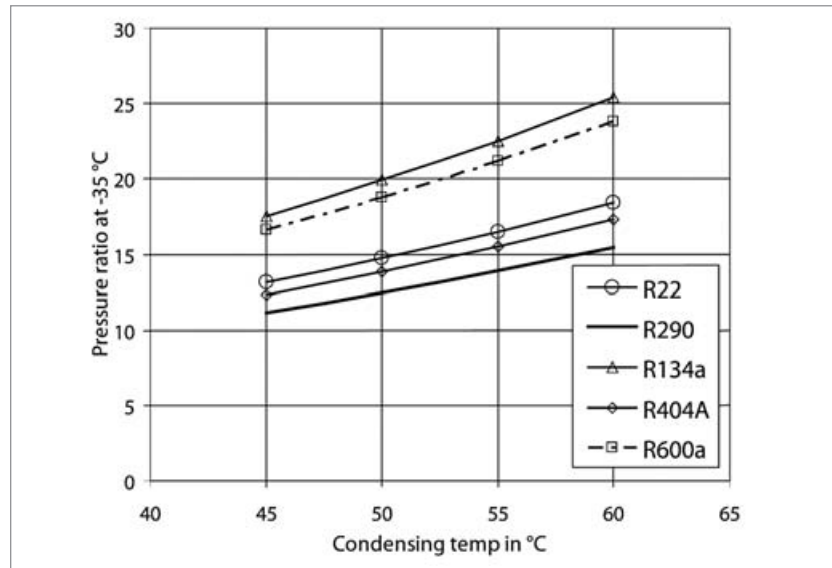

Figure 2: Pressure ratio of refrigerants over condensing temperature, at  $-35\text{ }^{\circ}\text{C}$  evaporating temperature

## Discharge temperature

This value increases with the pressure ratio and is differing with the refrigerants. A very high discharge temperature can degrade the lubrication oil, which in small amounts is pumped with the refrigerant. The figure 3 shows the theoretical value for the discharge temperature at the chosen LBP operating point, with varying return gas temperature. The return gas temperature is influenced by the suction line heat exchanger, which is included in most capillary expansion systems. High return gas temperatures avoid humidity condensation on the suction line. With low temperatures

the suction line has to be insulated properly. In systems running HCs or HFCs it also is included due to the Coefficient of Performance (COP) improvement.

The figure 3 shows discharge temperatures for R22 approximately 40 K higher than for R290, R134a and R404A, which are very close. R600a is even placed approximately 10 K lower. Real discharge temperatures, appearing at the discharge valve, have to be considered higher, as the compression is not ideal and the return gas is additionally heated up by the compressor motor before compression.

The high discharge temperature using R22 in LBP application at high ambient temperature seems critical. This is a reason for limiting the condensing temperature of R22 LBP compressors more than for MBP.

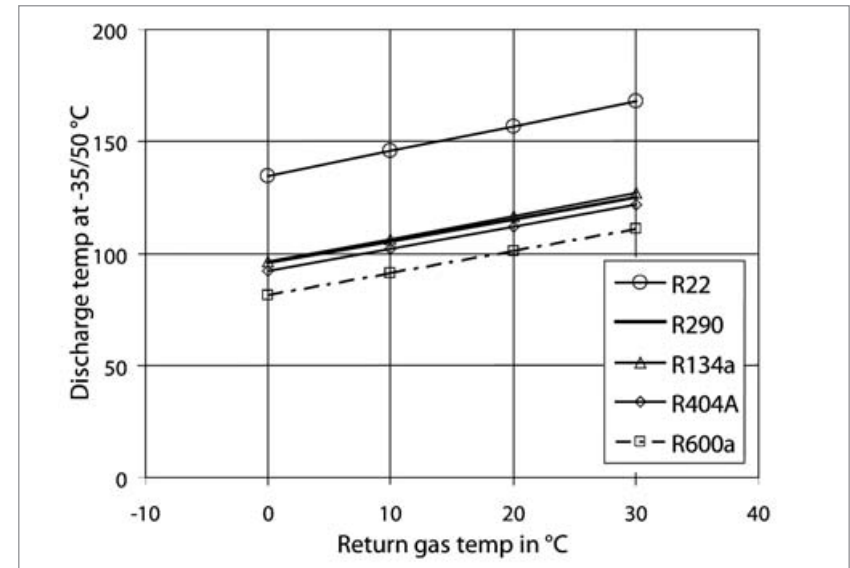

Figure 3: Discharge temperature of refrigerants over return gas temperature

## Impact of high condensing temperature

High ambient temperature leads to high condensing temperature where the refrigeration systems are designed to reject heat to ambient. This is typical for factory made plug in appliances. As the high ambient temperature also increases the heat flow into the appliance, the impact of the condensing temperature on refrigeration capacity and COP is compared here.

Figure 4 shows the impact of increased condensing temperature on the volumetric refrigeration capacity of the named refrigerants. Starting from  $45\text{ }^{\circ}\text{C}$  condensing, the increase does have similar impact on R22, R290, R134a and R600a, losing 12 to 14% capacity at same volume flow at  $60\text{ }^{\circ}\text{C}$ .

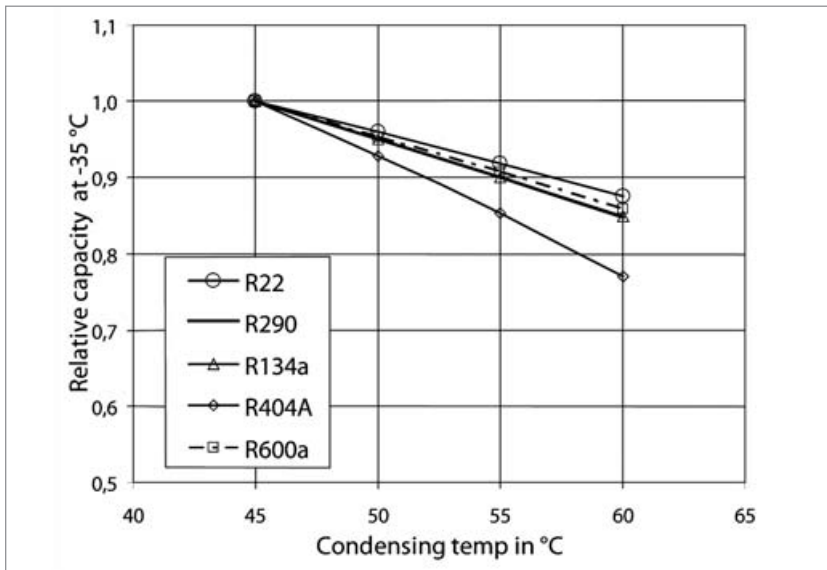

Figure 4: Capacity decrease of refrigerants with increased condensing temperature

For R404A the loss is ca. 23 % for same conditions. This is mostly due to a low critical temperature of ca. 70 °C for R404A. This makes R404A a dubious candidate for high ambient temperatures.

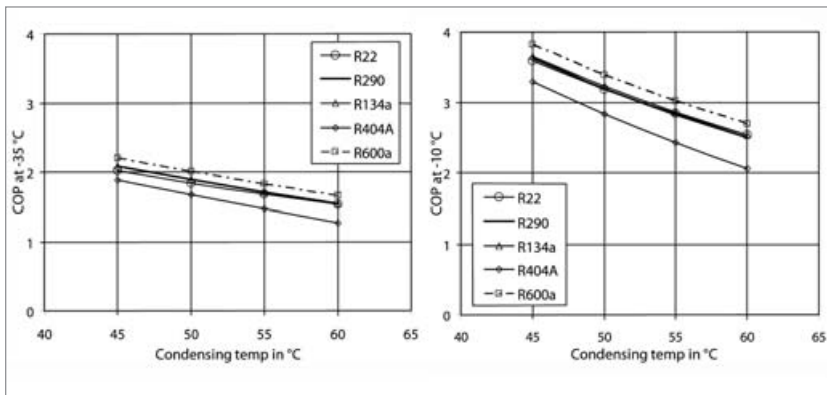

Figure 5: Theoretical COP of refrigerants at LBP and MBP conditions with varying condensing temperature

The theoretical COP values shown in figure 5 do not take compressor losses into account, which are influenced by other already discussed conditions. It does only compare the refrigerants without system losses. The relative position of the refrigerants does not differ much with condensing temperature or evaporating temperature – LBP or MBP.

The theoretical values for R600a are slightly higher than those of R22, R290 and R134a, which are very close together. The benefit of ca. 5 % is, however, mostly theoretical, as R600a has a low volumetric efficiency, that only quite small commercial appliances or household appliances can be properly realized. The values for R404A are also below those of the other candidates.

### Summary of thermodynamics

Item	R22	R290	R134a	R404A	R600a
Pressure	o	o	+	-	+
Pressure ratio LBP	o	+	-	o	-
Discharge temperature	-	+	+	+	+
Volumetric capacity	+	+	-	+	-
Capacity loss	o	o	o	-	o
COP	o	o	o	-	+

Table 2: Performance of refrigerants at discussed conditions ( o acceptable, + good, - problematic )

Summing up the different thermodynamic aspects, R290 could be used as replacement for R22 in many commercial refrigerated MBP and LBP appliances. It is the only candidate, which does come so close to R22, in some aspects even outperforming it. The lower pressure ratio and lower discharge temperature do even allow for applications, where R22 is problematic. This also compensates a little of the capacity lack of less than 10 % at MBP application.

## Applications with propane

The commercial applications listed in table 3, are sorted roughly in order of number of sold units. The large market of unitary air conditioners is not listed, as Danfoss is not serving it with compressors.

Bottle cooler	MBP
Ice cream freezer / commercial freezer	LBP
Commercial refrigerator	MBP
Beer cooler	MBP
Beverage dispenser	MBP
Dehumidifier	HBP
Electronics cooling	HBP
Heat pump	HBP

Table 3: Applications with small hermetic systems

Thus the major application will be MBP plus commercial and ice cream freezers with LBP. Unfortunately, increased capacity typically also needs increased refrigerant charge. Due to the limitations in safety standards, the cooling capacity is practically limited, as long as standard system components are used. The design is by that also limited to capillary expansion systems. Danfoss Compressors has in year 2000 introduced a combined LBP/MBP compressor range for propane ranging from 5 to 21 cm<sup>3</sup>. This range has been extended down to 3 cm<sup>3</sup>, and by 12 to 21 cm<sup>3</sup> pure LBP compressors with optimized valve systems, increasing capacity. Since compressors for propane are available, Danfoss Compressors together with customers has tested this refrigerant in several applications of different sizes

- Bottle cooler
- Beer cooler
- Commercial freezer
- Beverage dispenser
- Small ice-cream freezer
- Display island freezer and cooler

The comparisons have been done to R134a and R404A mainly, but also to R600a and CO<sub>2</sub> in some cases. The general findings are, that R290 did not perform worse than R134a or R404A, mostly better than R404A. Efficiency improvements were thus in the range of 0 to 10 %. In some cases modifications were necessary to come down to R290 charges below 150 g. This could be different evaporator tube sizes and change to capillary expansion. The capacity lack of R290 versus R404A at LBP applications was less than predicted, probably because the lower pressure ratio of R290 compensates partly.

## Propane in safety standards

Danfoss considers working according to these standards for use of R290 essential and strongly recommends taking a third party approval also in countries where approvals are not mandatory. In some countries additional rules or laws might apply for use of flammable refrigerant. This has to be investigated by the appliance manufacturer.

### Electrical safety standards for factory made Plug-in Appliances

A set of international standards on electrical safety does contain rules for design and testing of appliances operating with flammable refrigerants. These standards are valid in many countries, in several of them following these standards is mandatory.

- IEC 60335-2-24 Household refrigerators and freezers
- IEC 60335-2-34 Motor compressors
- IEC 60335-2-89 Commercial refrigerators and freezers
- IEC 60335-2-40 Heat pumps, air conditioners and dehumidifiers

The parts -2-24 and -2-89 are having rules limited to maximum 150 g of flammable refrigerant per circuit. The part -2-40 is now valid up to approx 5 kg of propane per appliance. Up to 150 g of charge, the standards consider the safety being covered properly by specifying and testing the appliance. Above 150 g rules for the installation, placing, service, documentation and maintenance are included in -2-40, for the appliance types covered in that part.

The existence of this set of IEC standards does support to use R290 in appliances in many places of the world in a safe way. But other applications, like some vending machines, might be too complex to build with flammable refrigerant.

Proposals for extension of -2-89 for commercial appliances to 0.4 or 0.5 kg have not been successfully implemented yet. This would demand for manufacturers of these appliances to be working with the standardization committees.

### Pressure Equipment Directive

The European directive 97/23/EC, Pressure Equipment Directive PED, is an example for a regional regulation, also covering refrigeration equipment and its components. Regarding flammable refrigerants in appliances, the PED comes into the picture from a certain size of components, e.g. from ca. 3.6 litres of low pressure housing volume for R290.

---

## Production and service with propane

---

While the safety of appliances and their users is covered by a set of international standards, the safety of the workers and working places in factories is a matter of national laws and standards mostly. In Europe the installations for manufacturing, testing and charging the appliances are usually approved by local working safety authorities, partly together with third parties like TÜV. Most countries will have rules on safe handling of flammable liquids and liquefied petrol gas. The safety concept of the installations is a major part of the safe handling of propane. To complete the safety concept, the after sales service personnel has to be taken into the picture. Safe work during servicing of appliances with flammable refrigerant requires well trained and educated people. Depending on the country, the service technicians will have very different background and education. In terms of handling flammable refrigerants, this education has to be brought to a safe level.

---

## Conclusion

---

R290 propane is a very promising candidate thermodynamically, for phase out of R22. It seems to be the best matching replacement especially for areas with high ambient temperature, where high condensing temperatures and high thermal load come together in commercial appliances. The theoretical investigations correlate well with the experience from tests.

R290 has been used in commercial refrigerated appliances in certain volumes since several years. The refrigerant has, however, not been a bestseller in the market for small hermetic compressors until now. A number of applications are brought to market and show good efficiency and no special problems have appeared. Most appliance manufacturers introduce R290 only on their customer's demand, which seems to be increasing gradually, at least in Europe.

Still there is some uncertainty in many countries, especially regarding the safety standards and liability issues. The experience with isobutane shows, that safe handling is possible. The need for an internationally valid safety standard, at least for small hermetic commercial appliances with charges higher than 150g, is also clear. Danfoss is developing compressors for R 290 and supporting its customers in the application. In parallel Danfoss is participating in the standardization work to establish safe and technically feasible appliance standards also for extended use.

As it is quite clear, that R290 is not the only solution for the whole world, developments for other refrigerants are ongoing. For some light commercial applications CO<sub>2</sub> compressors and controls are under development.

---

## References

---

Jürgensen, Heinz; Tiedemann, Thomas: Propan in hermetischen Kältegeräten und Wärmepumpen – Einfluss und Entwicklungsstand der Normung. DKV-Tagungsbericht 2002, Magdeburg, 20.-22. November 2002, Arbeitsabteilung II.2, II.2 (2002), p. 295-304.

Jürgensen, Heinz; Nielsen, O. K.; Tiedemann, Thomas: Application Related Design of Hermetic Propane Compressors for Small Refrigeration Systems. IIR/IIF Conference Proceedings "Compressors and Coolants", Papiernicka, Slovakia, 2004.

IEC 60335-2-24 "Safety of household and similar appliances. Part 2-24: Particular requirements for refrigerating appliances, ice-cream appliances and ice-makers", 2000.

IEC 60335-2-89 "Safety of household and similar appliances . Part 2-89: Particular requirements for commercial refrigerating appliances with an incorporated or remote refrigerant condensing unit or compressor", 2003.

IEC 60335-2-34 "Safety of household and similar appliances. Part 2-34: Particular requirements for motor-compressors".

IEC 60335-2-40 "Safety of household and similar appliances. Part 2-40: Particular requirements for electrical heat pumps, air conditioners and dehumidifiers" .

TS 95006 "refrigerators, food freezers and ice-makers using flammable refrigerants" Amendment to EN 60335-2-24, CENELEC July 1995.

PED – Directive of the European Community 97/23/EC (Pressure Equipment Directive) Practical Application of Refrigerant R 290 Propane in Small Hermetic Systems. Technical Information, Danfoss Compressors, November 2000.

# Design Criteria for CO<sub>2</sub> Evaporators

ROLAND HANDSCHUH, Güntner AG, Germany

---

## Introduction

---

Following the replacement of CFCs and HCFCs by chlorine-free refrigerants because of their damaging effect on the ozone layer, concerns began to be raised at an early stage about the high risks posed by the new HFC refrigerants and their effect on exacerbating the greenhouse effect. In recent years attention has therefore increasingly been focused on natural refrigerants. The past few years have witnessed a significant increase in the use of CO<sub>2</sub> and particularly since the Deutsche Kälte- und Klimatechnik Verein (DKV; German Association of Refrigeration and Air Conditioning Technology) conference 2001 in Ulm, if not earlier, it was recognised that CO<sub>2</sub> has applications, principally in NH<sub>3</sub> cascade operations that are now economically viable. Plants of this type generally operate at evaporating temperatures of between -40 and -50 °C. In designing CO<sub>2</sub> evaporators there are some special features which must be borne in mind and these will be examined in greater detail in this article.

---

## Classification of CO<sub>2</sub> evaporators

---

Essentially the main difference between different types of CO<sub>2</sub> evaporators lies in their mode of operation, i.e. direct expansion evaporators, pump-operated evaporators and evaporators for generating process gas. From a thermodynamic viewpoint they may be classified between the two variants: pump operation and direct expansion (Figure 1). A further distinguishing feature is the required operating pressure. Provided it has been confirmed at the planning stage that the operating pressure of 32 bar (the current nominal pressure for Güntner evaporators) will not be exceeded, any standard materials can in principle be used. This is of particular importance in cases where the direct expansion system is being used because in that case internally grooved tubes can be used. This variant is the most economical in all cases.

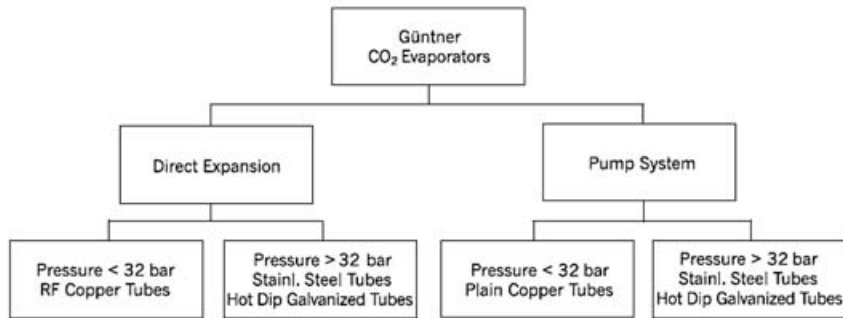

Figure 1: Overview of CO<sub>2</sub> evaporator types

Where hot gas defrosting using CO<sub>2</sub> is being carried out, the permitted pressure is generally between 45 to 50 bar. This is difficult to achieve with copper tubes. Thicker heat exchanger tubes would have to be used in all cases and in any event these are not available with internal grooves. In addition, the joining tubes (header outlets, connecting tubes) would also need thicker walls and would need to be purpose-built. Heat exchangers made of hot dip galvanised or stainless steel where pressures of 50 bar are relatively easy to achieve would be suitable here.

## Design of CO<sub>2</sub> evaporators

The CO<sub>2</sub> evaporator designs are carried out in accordance with strict thermodynamic rules. Firstly, the material data are determined which are stored in the form of temperature-dependent functions, and secondly mass flow rates, heat transfer coefficients, pressure losses, dehumidification and finally refrigerating capacity are determined, whilst taking into account information relating to tube and fin structures.

However, when CO<sub>2</sub> is being used, an additional factor comes into play: The internal heat transfer with CO<sub>2</sub> is so high that its effect on the evaporating capacity is practically negligible. For example, a increase in heat transfer at the refrigerant side from 2000 W/m<sup>2</sup> K to 3000 W/m<sup>2</sup> K in a typical industrial air cooler increases the overall heat transfer coefficient by only about 6%. The effect on refrigerating capacity is even less because a greater heat transfer value leads to increased air cooling and thus to a lower driving temperature difference. Some of the internal heat transfer coefficients occurring when CO<sub>2</sub> is being used are still considerably greater than 3000 W/m<sup>2</sup> K so that any uncertainty about the calculations in this respect may be ignored.

## Special properties of CO<sub>2</sub> in comparison with R22 and NH<sub>3</sub>

As is widely known, the special property of CO<sub>2</sub> as a refrigerant is its high saturation pressure. On the one hand this property may engender considerable reluctance to use CO<sub>2</sub> as a refrigerant because it makes it rather difficult to handle, especially at higher temperatures. At low temperatures, however, this property is a decisive advantage. For example, a comparison of the properties of CO<sub>2</sub> with those of R22 and NH<sub>3</sub> at a temperature of -40°C (Table 1) shows that the volumetric refrigerating capacity of CO<sub>2</sub> is about 7 times greater than that of R22 or 8 times greater than that of NH<sub>3</sub>. To put this another way the tube cross-sections required in a CO<sub>2</sub> plant are only about an eighth of those in a comparable NH<sub>3</sub> plant. This leads to smaller tube cross-sections, smaller compressors and, of course, to less refrigerant charge sizes and ultimately to more economical plants. However, the high pressure and the associated high gas density also lead to the above-mentioned high temperature heat transfer during evaporation.

Refrigerant	CO <sub>2</sub>	R22	NH <sub>3</sub>
Vapour pressure [bar]	10	1	0.7
Enthalpy of evap. [kJ/kg]	322	243	1387
Density of gas [kg/m <sup>3</sup> ]	26.24	4.85	0.64
Gas volume flow for 10 kW [m <sup>3</sup> /h]	6	41	47
dp/dT [bar/K]	0.37	0.05	0.04
Required distributions (ca. 8 m/s)	2	12	12

Table 1: Material properties of CO<sub>2</sub>, R22 and NH<sub>3</sub> at -40°C

A further consequence of the high pressure level is the weak temperature/pressure dependency. For example, a pressure change of about 0.37 bar is required to change the vapour pressure by 1 K at -40°C. When using R22 this could be achieved with a pressure change of as little as 0.05 bar and with just 0.04 bar using NH<sub>3</sub>. Because of this beneficial side effect, pressure losses have only a negligible effect on the evaporating temperature. However, this property is ultimately the only thing that makes it possible to use CO<sub>2</sub> with normal evaporator geometries. In order to explain this more clearly it is necessary to illustrate the relationships by means of a specific example. For example, an evaporator with 6 rows of tubes in the air flow direction, 12 rows of vertical tubes and a tube diameter of 15 mm would give the following theoretically possible circuiting variants (pass numbers): assuming a fixed refrigerating capacity of 15 kW, a refrigerant speed of over 7 m/s can be achieved with R22 at -40°C with a 6-pass circuiting (12 distributions). However, it is only possible to achieve a speed barely exceeding 6 m/s with a 36-pass circuiting (2 distributions) when using CO<sub>2</sub>. This

means that, when CO<sub>2</sub> is being used, the distribution length must be 6 times longer. Assuming on an initial estimate that the pressure loss per metre of tube is the same for all refrigerants at the same speed, there would be 6 times more pressure loss with CO<sub>2</sub>. In fact the actual pressure loss using CO<sub>2</sub> is even a little greater because of the properties of the materials (Figure 2).

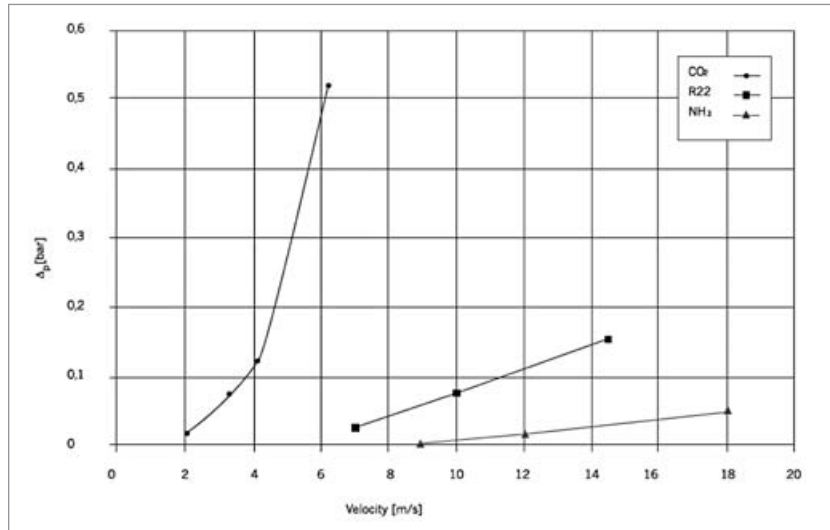

Figure 2: Pressure loss in relation to refrigerant velocity

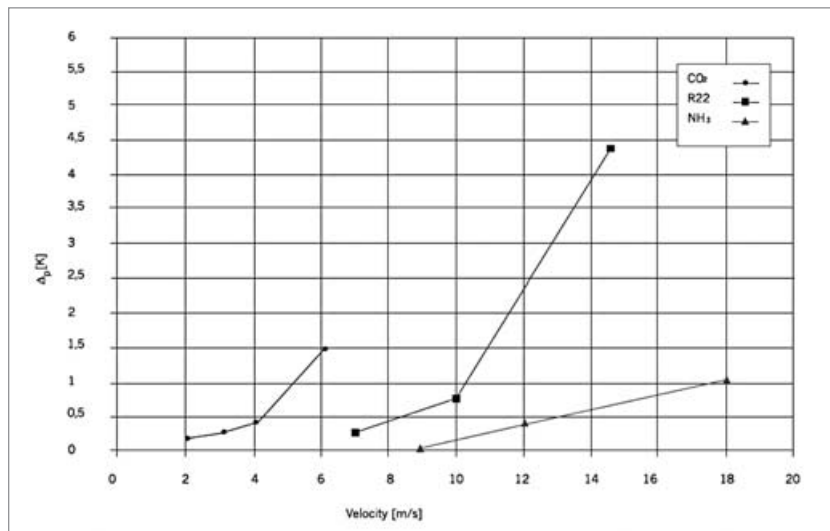

Figure 3: "Temperature loss" in relation to refrigerant velocity

However, from a thermodynamic viewpoint, it is only the temperature drop caused by the pressure loss that is important since this lowers the driving temperature difference at the evaporator and, as a result, the refrigerating capacity. This is however only slightly greater than with R22 and NH<sub>3</sub> because of the weak temperature pressure/dependency (figure 3). If this were not the case, other heat exchanger geometries would have to be used for CO<sub>2</sub>, i.e. tubes with a considerably smaller diameter would have to be used without increasing the number of tubes.

## Results of design calculations

By way of an example let us assume that a comparison of the three refrigerants, CO<sub>2</sub>, R22 and NH<sub>3</sub> was to be carried out using the evaporator described above. The conditions chosen would be  $t_o = -40^\circ\text{C}$  (evaporation end temperature),  $t_1 = -30^\circ\text{C}$  (air intake), RH = 95% (relative humidity of air). In order to exclude other influences the same quantity of air was used in all cases. Similarly, the calculations were based on the use of copper tube throughout, even though this was purely a theoretical assumption for NH<sub>3</sub>. The capacity was set at a constant value. Circuitry appropriate to the respective refrigerant was used.

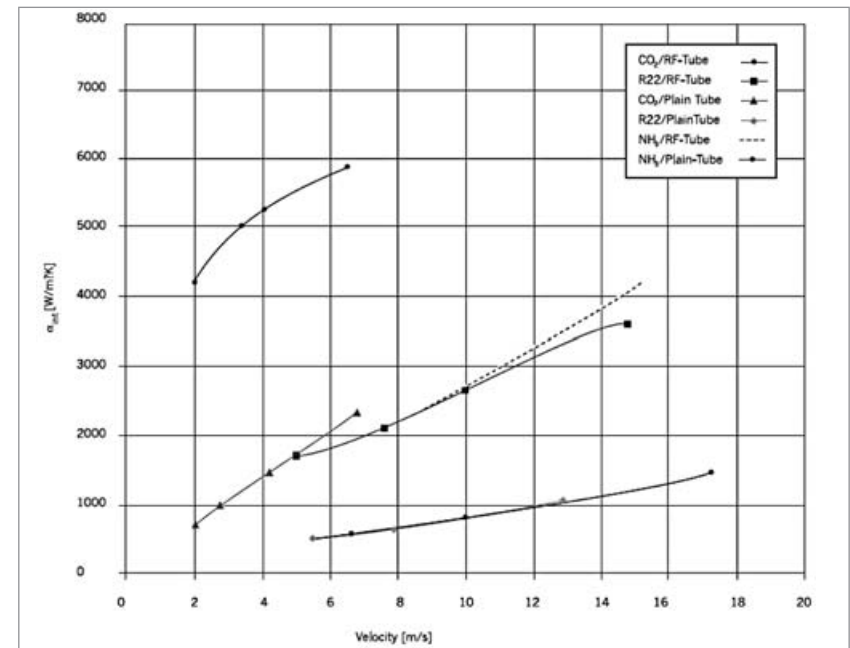

Figure 4: Heat transfer of different refrigerants in relation to velocity



Figure 4 shows the internal heat transfer coefficients in relation to the refrigerant speed using direct expansion. As can be seen, values can be achieved with CO<sub>2</sub> with plain tube that can only be achieved with internally grooved tube when using R22. In this comparison it should be noted that the values for NH<sub>3</sub> are purely theoretical since, as previously mentioned, the calculations were based on the one hand on the use of copper tube and on the other hand on superheating of 5 K which is difficult to achieve with NH<sub>3</sub>. However, the fact that the temperature drop caused by pressure loss is more important than the refrigerant speed makes Figure 5 more meaningful, showing as it does the internal heat transfer coefficient in relation to the “temperature drop” caused by pressure loss.

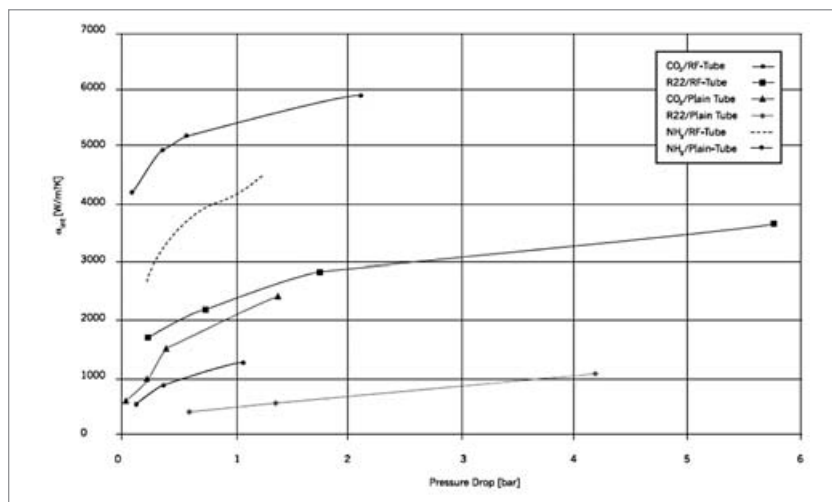

Figure 5: Heat exchange of different refrigerants in relation to pressure loss

However, this diagram does not provide much help in creating an optimum design for an evaporator either. What ultimately matters is the product of the total heat transfer coefficient (U) and the average logarithmic temperature difference ( $\Delta T$ ) which is often also expressed as the thermal load. Figure 6 shows this again for the three refrigerants, CO<sub>2</sub>, R22 and NH<sub>3</sub> for evaporators with plain tubes and internally grooved tubes. This clearly shows that the optimum speed for CO<sub>2</sub> is markedly less than the speed achievable with R22 and substantially less than the speed achievable with NH<sub>3</sub>. This is due on the one hand to the greater pressure loss of CO<sub>2</sub> because of the circuitry and on the other hand to the greater heat transfer. Both result in a situation where, when using CO<sub>2</sub> even at relatively low speeds and on increasing the speed, the negative effect of the pressure loss has a greater effect on capacity than the positive effect caused by the increasing heat transfer. Exactly the opposite situation applies when

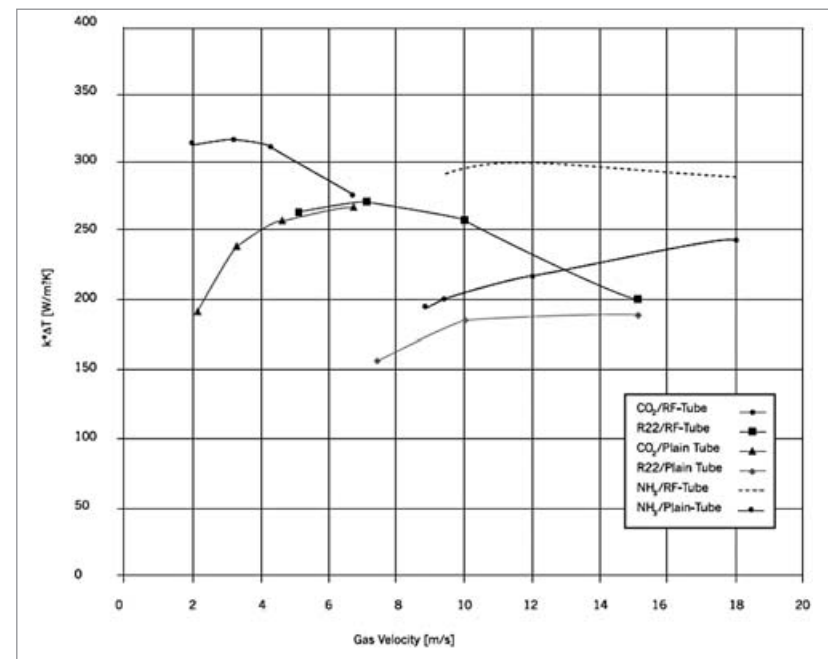

Figure 6: Thermal load in relation to refrigerant speed

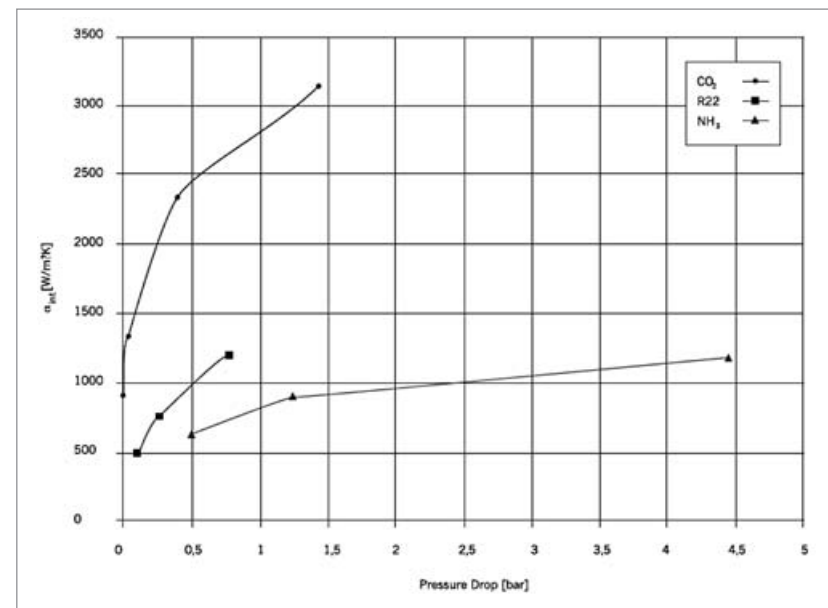

Figure 7: Internal heat transfer with pump operation

using  $\text{NH}_3$  where good heat transfers can be achieved only at very high speeds. However, to make up for that, the pressure losses at these speeds remain relatively low because of the circuitry. At this point it must be stressed again that the values for  $\text{NH}_3$  shown in figure 6 are practically unachievable. The advantages of using  $\text{CO}_2$  in pump-operated evaporators are even more evident.

Figure 7 shows a comparison of the internal heat transfer coefficient at a pumping rate of 2.5. The internally grooved tube has been dispensed with here since it produces no significant advantages when pump operation is being used. In this case calculations for  $\text{NH}_3$  were also based on an assumption that copper tube was used. The difference between the other refrigerants and  $\text{CO}_2$  would therefore be even greater in a real heat exchanger.

Figure 8 again shows the thermal load of the different variants. The values for direct expansion are shown again for comparison purposes. It can be seen that  $\text{CO}_2$  excels in pump operation. Again this is because when  $\text{CO}_2$  is being used, the driving temperature difference plays a more important role than the heat transfer coefficient which is in any event high. Because of the absence of superheating the average logarithmic temperature difference using pump operation is generally greater than when using direct expansion. The total thermal load during pump operation is therefore greater than when using direct expansion although there is somewhat less heat transfer. When using  $\text{NH}_3$  the same effects again result in the opposite outcome: the greater heat transfer with direct expansion outweighs the disadvantage caused by the smaller temperature difference so that direct expansion has an advantage, at least in this theoretical case.

## Summary

By using  $\text{CO}_2$ , greater heat transfer coefficients can be achieved both in pump operation and in direct expansion than with all other current refrigerants. Because of the high pressure level and the resulting weak pressure/temperature dependency, all standard heat exchangers can be used just by altering the circuiting to an increased number of passes or smaller distributions. Should operating pressures of 32 bar be insufficient, either thicker walls or other materials (steel, stainless steel) must be used. In that case the cost advantage achieved by the greater heat transfers is again offset or even reversed. It would therefore be sensible in the long term to introduce a specific fin geometry which has a smaller tube diameter with the same tube spacing. In this way the long distribution lengths could on the one hand be dispensed with and on the other hand there would be the advantage that tubes of smaller diameters have greater stability under pressure and that the required wall thicknesses would thus be kept within reasonable bounds. However, it is only worth investing in such a tool if greater quantities of  $\text{CO}_2$  evaporators are required.

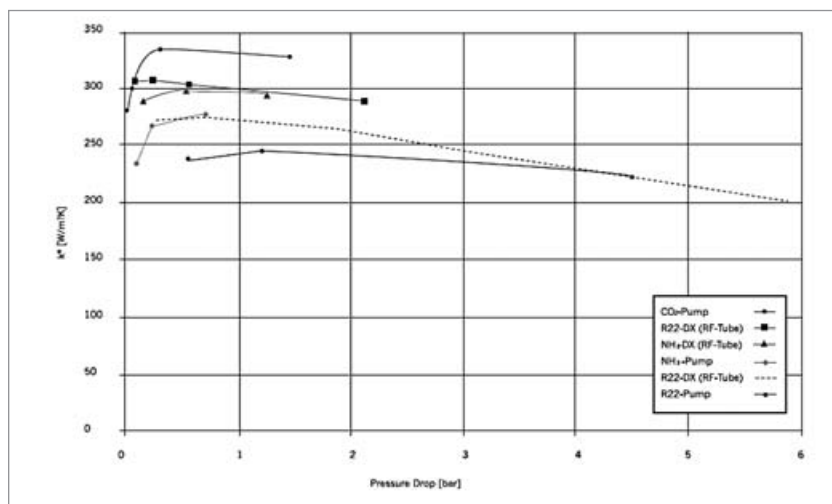

Figure 8: Heat load of various refrigerants in different modes of operation

# Environmentally Friendly Refrigeration in the Retail Trade

## Refrigerant R22 soon to Be a Thing of the Past – Future Ecological Alternative Can Be CO<sub>2</sub>

PROF. DR. REINER TILLNER-ROTH, Epta Group, Germany

---

### Introduction

---

The refrigerant R22 (difluorochloromethane) is widely used in the retail trade for cooling foodstuffs – but it has one serious drawback: As a halogenated chlorofluorocarbon (HCFC) it is harmful to the ozone layer and the environment. The environmentally friendly alternative to this, and all other HCFC and HFC refrigerants, is carbon dioxide (CO<sub>2</sub>), which is increasingly being used as a refrigerant. Cascade systems using CO<sub>2</sub> for the deep freezing cycle and transcritical refrigeration systems, which allow both deep freezing as well as ordinary refrigeration with CO<sub>2</sub>, have now reached technological maturity and are set to have an increasing impact on the market in the years ahead.

---

### HCFC refrigerants soon to be a thing of the past in Europe

---

Alternatives to HCFC refrigerants such as R22 that can be implemented fast are needed to comply with legal requirements, at least in the European Union. EC Regulation 2037/2000 was introduced by the EU to implement the Montreal Protocol on Substances That Deplete the Ozone Layer. This regulation bans the sale or filling of refrigeration and air-conditioning equipment with virgin hydrochlorofluorocarbons throughout Europe from 1 January 2010. As of that date it will only be possible to use recycled R22 for maintenance and servicing of existing refrigeration equipment for another five years, until it becomes completely prohibited from 2015. This alternative will almost certainly not be available in the required quantities to meet the needs of the retail trade, meaning that the continued use of R22 in the industry after 1 January 2010 is almost out of the question.

---

## R22 prices set to rise

---

The European retail trade is therefore called upon to make the switch from R22 to an ozone friendly refrigerant within the next two years. According to the refrigerant manufacturer DuPont, the situation is even more urgent because the manufacturers are likely to start reducing the production and distribution of R22 in the course of 2009, which means that prices for this refrigerant are likely to start rising within the foreseeable future. The entire European retail industry will therefore face a steep overall increase in the price of R22, and thus the cost of maintenance and servicing of systems using R22 too. In addition to this, there is also the risk that if a system breaks down it may not be possible to obtain enough R22 to refill it at short notice. In extreme cases, this could even lead to the affected shop having to shut temporarily.

Naturally, anything that is likely to have an impact on the European retail industry in the very near future will also have an impact on the global market. Other regions are not yet subject to any legal constraints such as those that have been introduced in the European Union, but the cut in production of R22 is bound to have an effect on the price worldwide too. It is likely that the price of R22 will rise significantly on the global market and than other refrigerants will become more cost-effective.

---

## CO<sub>2</sub> as the refrigerant of the future

---

There are a number of options available to the retail trade to replace HCFC refrigerants. The most promising solution is the use of carbon dioxide (CO<sub>2</sub>) as a refrigerant. It is not harmful to the ozone layer and has a very low global warming potential (GWP=1). However, the switch to using CO<sub>2</sub> demands a switch in technologies, as it cannot be used in existing refrigeration systems that rely on other refrigerants. This means that anyone wanting to use CO<sub>2</sub> as a refrigerant needs to invest in new refrigeration equipment. Basically, there are two options: Cascade systems – where the deep freezing cycle operates with CO<sub>2</sub> and ordinary refrigeration is provided by a conventional HFC refrigerant – or transcritical CO<sub>2</sub> systems, which use CO<sub>2</sub> to provide both deep freezing and ordinary refrigeration. Whichever one a company opts for, both alternatives are an investment in a technology of the future, which is especially attractive for new shops that are opening, although equally possible when refitting existing shops.

---

## Transcritical CO<sub>2</sub> refrigeration systems reach technological maturity

---

At present, the main focus of developments is on transcritical CO<sub>2</sub> refrigeration systems. The special feature of these systems is that they operate in a supercritical cycle at high ambient temperatures, for instance in the summer and in particular in warmer regions of the globe. At high ambient temperatures the temperature of the heat rejected from the cycle may exceed the critical point of CO<sub>2</sub>, which is 31°C. In this case, the heat rejection to the environment takes place without the gas changing state from a gas to a liquid, but instead has to take place by cooling the heated, gaseous CO<sub>2</sub>. When the system is operating in this supercritical mode, a special controller in the system ensures that the critical point is exceeded significantly, in order to enable the system to continue operating stably. This is accompanied by an increase in refrigerant pressure to 80-100 bar. In contrast, an operating pressure of below 50 bar is sufficient to liquefy the gas below the critical point. In order to be able to operate at such high pressure, the system components such as the pipes, air coolers, external condensers, valves, and the pressure and control switches need to meet very demanding specifications. Epta has been developing transcritical CO<sub>2</sub> systems since 1998 and its systems have now reached technological maturity and are ready for market.

---

## Readiness for series production just a few years off

---

The current state of development of transcritical CO<sub>2</sub> refrigeration systems is very promising. For instance, there are already a significant number of systems installed and operating successfully in shops throughout Europe. For example, in Germany the low-cost retailer Aldi Süd has been using transcritical CO<sub>2</sub> refrigeration technology since 2006 – the first retail chain to do so in the country. Since then, many more systems have been installed, both in Germany and in other countries. Sweden is one of the clear leaders in installing this environmentally friendly technology.

At the current stage of development, transcritical CO<sub>2</sub> refrigeration systems could become established as the standard for the food retail market in about two to three years. Due to an increase in production volume during this period, the price of specialized system components is predicted to drop, too. At present the cost of investing in a transcritical CO<sub>2</sub> system is about 50% higher than that of a conventional system that uses HFC refrigerants, for example. In three to five years this difference may have dropped to around 20-25%.

Investing in CO<sub>2</sub> systems can prove worthwhile for retailers. For one thing, the procurement cost of CO<sub>2</sub> is low, in comparison with HFC refrigerants, and the switch can also result in lower operating costs. In addition to this, the need for regular leak testing, which is mandatory in Europe for refrigeration systems that use HFCs due to the requirements of the F-Gas regulation 842/2006, will fall away.

The power consumption is more or less the same as conventional HFC systems, although it does increase if the system needs to operate in the supercritical mode frequently – in other words, when the ambient temperature is high. At low operating temperatures, however, transcritical systems use less energy than HFC systems.

## Refrigeration Systems for Warm Climates Using Only CO<sub>2</sub> as a Working Fluid

SERGIO GIROTTI, Enex S.r.l., Italy

DR. SILVIA MINETTO, Università degli Studi di Padova, Italy

---

### Introduction

---

Carbon dioxide is presently regarded as a real alternative to HFCs in commercial refrigeration. In the last ten years an increasing number of plants have been installed, mainly in central and northern Europe. Due to its very low critical temperature (31°C), carbon dioxide vapour compression cycle efficiency and cooling capacity suffer from a rapid deterioration at high ambient temperatures, as in the majority of refrigeration plants heat is directly rejected to the external ambient.

The need to improve efficiency has led to a great research effort in evaluating staged expansion and compression cycles, that can reduce the penalisation of the transcritical cycle. These cycles, mainly developed to achieve high energy efficiency levels in temperate climates, also offer the opportunity of using CO<sub>2</sub> in those regions where the basic single-stage compression cycle would not have any chance of being applied due to the extremely high external temperature.

At the same time, whenever possible, it becomes of the greatest importance to take full advantage of those methods which give the possibility of reducing the temperature of air entering the gas cooler. Adiabatic saturation decreases the air temperature very close to its wet bulb temperature, with a certain water consumption.

The integrated design of the refrigeration and the air conditioning system can offer the possibility of using exhaust cold air for further cooling CO<sub>2</sub> at the gas cooler exit, as well as every situation in which a cooling medium at temperature lower than the ambient (for example water) is available.

## Theoretical analysis of different CO<sub>2</sub> transcritical cycles for warm climates

Staged expansion and compression are traditional methods to reduce the throttling and compression losses of refrigeration cycles. The adoption of these processes becomes of the greatest importance when carbon dioxide runs a transcritical cycle, mainly at high ambient temperature (Cavallini et al. 2006).

Some different improved CO<sub>2</sub> cycles are presented and analysed in terms of energy efficiency:

- A) Single-stage throttling, single-stage compression cycle (CYCLE A);
- B) single-stage throttling, two-stage compression, inter-stage cooling (CYCLE B);
- C) two-stage throttling, two-stage compression, inter-stage cooling, open flash tank cycle (CYCLE C);
- D) two-stage throttling, parallel compression (CYCLE D);
- E) two-stage throttling, two-stage compression, inter-stage cooling, split cycle (CYCLE E).

Cycles B, C and E have been equipped with internal heat exchanger between the vapour out of the evaporator and the liquid to the evaporator, in order to enhance the benefit of inter-stage cooling, as it was demonstrated by Cecchinato et al., 2005.

Figure 1 summarizes the basic cycles which have been considered.

The cycles were simulated with an original FORTRAN code, developed at the Dipartimento di Fisica Tecnica of the University of Padova.

The following general assumptions were made for the medium temperature MT and low temperature LT applications:

- 1) evaporation temperature: -8°C for MT and -33°C for LT;
- 2) vapour superheating at the evaporator outlet: 5K;
- 3) superheating in the suction line: 5K;
- 4) temperature approach between air entering the gas cooler and carbon dioxide at its exit: 2K;
- 5) temperature approach between air entering the inter-stage cooler and carbon dioxide at its exit: 2K;
- 6) minimum temperature approach at the internal heat exchanger: 2K;
- 7) overall compressor isentropic efficiency, including the electrical motor: 0.65 [-]  
This value is kept constant, regardless of compression pressure ratio and it is assumed to be valid for each stage of compression;

Some additional assumptions were needed :

- 8) for two-stage compression cycles, ratio between first stage and second stage compressor displacement  $R_v = 2.3$  [-]. This value is typical of two-stage internal com-

pound semi-hermetic reciprocating compressors (Dorin, 2007), which are often used in commercial refrigeration;

- 9) intermediate pressure for cycle D was assumed to be 38 bar, for technological reasons, as it will be explained in section 3;
- 10) limit on the temperature at the end of the compression process: 170°C. It is worth underlying that the actual discharge temperature is lower due to heat dissipation. The discharge temperature and its limit depend very much on the specific compressor and on its cooling method.

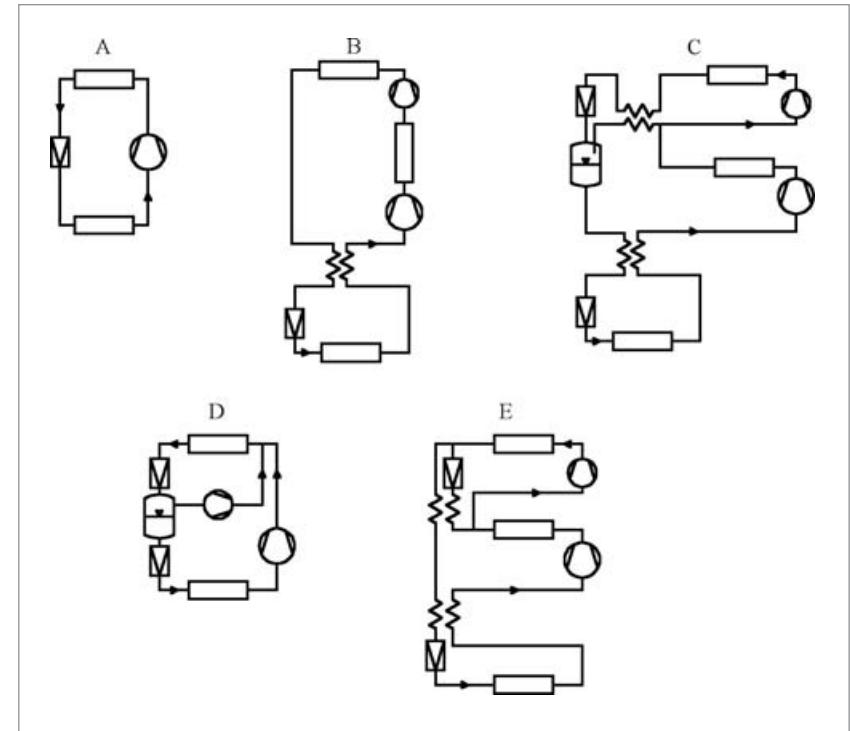

Figure 1: CO<sub>2</sub> cycles

Due to assumptions 8 and 9, intermediate pressure of two-stage compression cycles is no longer a variable to be optimised, but depends on the ratio between first stage and second stage compressor displacement or on the intermediate pressure which has been chosen, in the case of cycle D.

The limitation on the discharge temperature automatically leads to the exclusion of some cycles, especially at high ambient temperature or low evaporation temperature. The cycles which are summarised in table 1 were considered. For each of them the high pressure was optimised to get the best COP.

Ambient temperature	20°C		30°C		35°C		40°C		45°C		50°C	
Application	MT	LT	MT	LT	MT	LT	MT	LT	MT	LT	MT	LT
Cycle A	x		x		x		x		x		x	
Cycle B	x	x	x	x	x	x	x		x		x	
Cycle C		x		x		x		x		x		x
Cycle D	x		x		x		x		x		x	
Cycle E		x		x		x		x		x		x

Table 1: Simulated cycles at specific ambient conditions

For medium temperature applications the choice has been limited to cycles A, B and D, as represented in figure 2. Cycle A, which is normally adopted in mild climate applications, acts as the reference one, as it is regarded to be competitive in terms of energy efficiency with traditional HFC cycles when ambient temperature is lower than 20°C (Giroto et al. 2004). The application of cycle A at high ambient temperature results in very high end of compression temperatures.

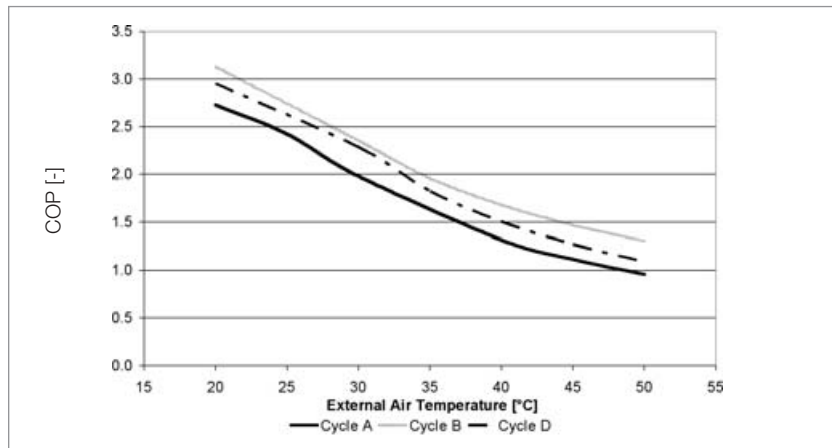

Figure 2: COP of different MT cycles as a function of external air temperature

Cycle B allows to improve the cooling effect thanks to the internal heat exchanger and to reduce the compression work, due to inter-stage cooling, which also partly neutralises the penalisation in compression work brought by the internal heat exchanger (Cecchinato et al., 2005). However, the physical constraints of using a fixed displacement ratio between the two stages of compression prevents from the optimisation of the inter-stage pressure, thus limiting the benefits of two-stage compression. Beside that, it must be stressed that at the moment there are no reciprocating two-stage internal compound compressors for MT applications on the market.

Cycle D reduces the compression work, beside increasing the cooling effect. The benefit of this cycle for MT applications could be improved if the optimisation of the intermediate pressure were allowed.

Figure 3 shows the simulation results for low temperature applications. Cycle B can be assumed as the reference one, as it is normally used in mild climates. The high end of compression temperature for the second stage limits its application to 35°C ambient temperature. The use of a two-stage internal compound compressor, as well as two independent compressors, with a lower displacement ratio between the low pressure and the high pressure stage would help in extending the application of this cycle at higher ambient temperatures, but it is clear that, in any case, this solution is not the best choice, especially at extreme ambient temperatures. Cycle C allows a significant improvement in energy efficiency, thanks to the reduction of throttling losses. Cycle E gives performances very similar to those of Cycle C, as it brings about the same benefits in terms of compression and expansion losses reduction.

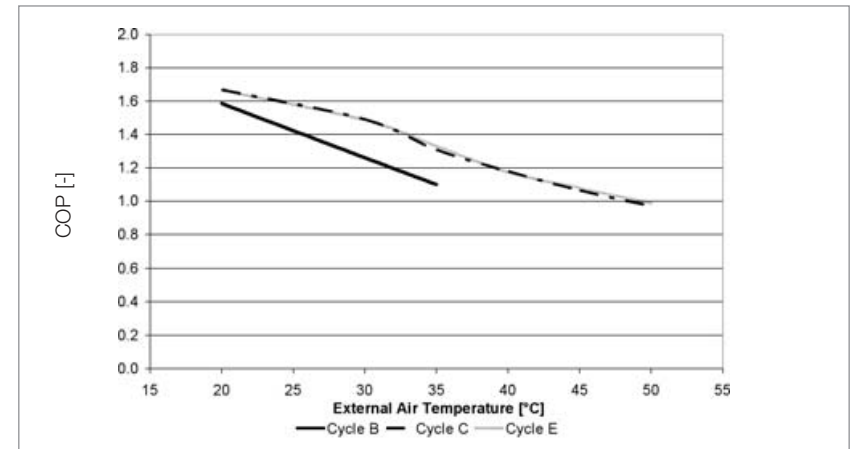

Figure 3: COP of different LT cycles as a function of external air temperature

As it can be easily seen in Figures 2 and 3, the COP strongly depends on the external temperature. For this reason it is of the greatest importance to keep the temperature of the air entering the gas cooler as low as possible. The adoption of the evaporative cooling can lower significantly the air temperature, thus introducing COP improvements with limited water consumption, as it will be demonstrated in section 2.

## Evaporative cooling

Spraying water on the condenser is a well known solution in refrigeration for facing peak temperatures: it offers very good performances, but it requires water anti-scale treatment, large availability of water, as it is extremely difficult to limit the amount of water to the exact needed quantity. Some commercially available systems spray water against the air stream, so that water droplets are ideally evaporated before they achieve the coil surface. However, the contact of water with fins leads to scaling and corrosion problems, unless a proper surface treatment is applied.

To avoid the drawbacks of water spray, evaporative cooling is nowadays more and more often proposed as a solution for hot climates or for facing peak temperatures. A near adiabatic saturation is achieved by forcing air through a wet pack. The saturation efficiency of commercially available packs for air velocity typical of gas coolers (1.0-2.5 m/s) is very high, and pressure losses are quite limited (Temotecnica Pericoli, 2008). The efficiency  $\mathcal{E}_s$  [-] represents the actual temperature decrease which is achieved through the pack in comparison with the maximum achievable one, i.e. the difference between the dry and wet air temperature

$$\mathcal{E}_s = \frac{t_{dry} - t_{air\ out}}{t_{dry} - t_{wet}}$$

being  $t_{dry}$  the dry bulb temperature of the air stream entering the pack,  $t_{wet}$  its wet bulb temperature and  $t_{air\ out}$  the temperature of the air out of the pack, which corresponds to the temperature of the air which will impact the gas cooler.

The actual benefit which can be achieved with evaporative cooling depends on the difference between the dry and wet temperature, i.e. on the air humidity content. The humidity ratio, together with the dry bulb temperature, is normally used to describe the thermo hygrometric status of the air.

Figure 4 represents the temperature at the evaporative cooler outlet  $t_{air\ out}$  as a function of the dry temperature, for different relative humidity R.H. [%] levels, with a constant saturation efficiency  $\mathcal{E}_s$  of 80%. The major benefit can be obtained in dry climates, but it is worth using this method also in humid countries: for examples, from figure 4 we can see that at with 40°C and 70% R.H. the air temperature out of the pack is 35.5 °C.

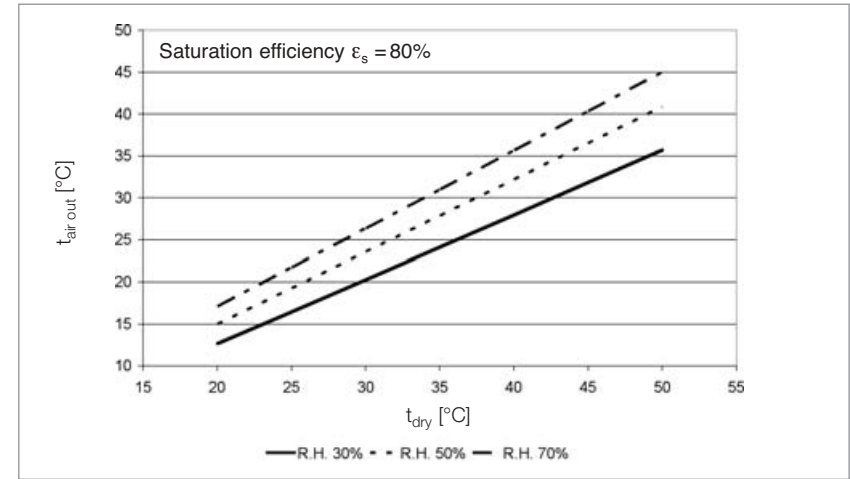

Figure 4: Calculated air temperature out of the evaporative cooling pack  $t_{air\ out}$  as a function of the air dry bulb temperature  $t_{dry}$  and for different relative humidity R.H. values

In Figure 5 a picture of an air precooler is presented. Such a device has been recently installed in an area with temperatures as high as 42°C and R.H. up to 40%.

In the following sub-section the theoretical water consumption of an evaporative cooling system for a CO<sub>2</sub> gas cooler will be evaluated for a dry climate location (Tripoli-Libia) and for a humid one (Bangkok-Thailand), in the two conditions of total cooling of the entire air entering the gas cooler or in the case that only 30% of the air stream is cooled down.

Carbon dioxide heat rejection at the gas cooler is ideally an isobaric and not isothermal process. Unlike traditional subcritical applications, where it is necessary to apply the evaporative cooling to the total air flow which impacts the condenser, being the heat rejection an isothermal process, CO<sub>2</sub> offers the opportunity of using evaporative



Figure 5: Evaporative cooling module



cooling only for part of the total air stream. As a matter of fact, if the gas cooler is properly arranged, it might be sufficient to cool down only the air stream which flows through the very last part of the gas cooler. As a result, with a limited penalisation in COP, a relevant amount of water can be saved, as it will be shown in the next subsection. This solution requires a proper design of the gas cooler and arrangement of the evaporative cooling system.

### Water consumption estimation for evaporative cooling

The evaluation of the water consumption for evaporative cooling has been referred to two locations, which are representative respectively of humid and dry climates. Bangkok (Thailand) and Tripoli (Libia) have been chosen. Weather data for the reference year have been taken from the US Department of Energy weather database (EERE, 2008). The purpose of this analysis is to show how evaporative cooling can lower the temperature of air entering the gas cooler, especially in dry climates, and to estimate the water consumption.

For Bangkok and Tripoli respectively, Figures 6 and 7 illustrate on the left axis the dry bulb temperature distribution, i.e. the number of hours per year in which the dry bulb temperature is within a certain temperature interval. The chosen temperature step interval is 5°C: for example for 3163 hours per year the temperature stays in the 25°C range, i.e. it stays between 22.5°C and 27.5°C.

For the greatest part of the year the temperature in Bangkok stays between 25°C and 35°C. The temperature range is actually quite limited, being irrelevant the number of hours in which the temperature exceeds 37.5°C or is lower than 17.5°C. On the other hand, Tripoli has a much wider range of temperatures, reaching also near-zero temperatures during the winter and exceeding 45°C in the summertime. For 60% of the year the temperature stays between 12.5°C and 27.5°C.

If evaporative cooling becomes active when the dry bulb temperature is higher than 29°C, it will run for 41% of the year in Thailand and only 15% in Libia.

On the right axis of Figures 6 and 7, the average wet bulb temperature for each dry bulb temperature interval can be read. It helps in getting an idea of how effective the evaporative cooling can be, being the wet bulb temperature the temperature that can be achieved with an ideal matrix having 100% saturation efficiency.

Bangkok has a very humid climate, which means that the benefit that can be gained with evaporative cooling is limited, as the humidity content in air is already close to its maximum value. When the external temperature is 30°C, the average wet temperature is 23°C; if 80% saturation efficiency is assumed, the average air temperature out of the evaporative cooler  $t_{air\ out}$ , when it is active, is 26°C. The derived benefit for COP depends very much on the specific cycle and operating conditions, as can be derived from Figures 2 and 3.

In Tripoli, evaporative cooling is much more effective, being the humidity very low. When the external temperature is 30°C, the average wet temperature is 16.9°C; if 80% saturation efficiency is assumed, the average air temperature out of the evaporative cooler  $t_{air\ out}$ , when it is active, is 22°C. It is clear that the COP improvement can be much higher than it is in Bangkok. The water consumption per kW of rejected heat has been hourly calculated, under the following assumptions:

- evaporative cooling is active when dry bulb temperature is higher than 29°C;
- the air flowing through the gas cooler increases its temperature by 15K (for air mass flow evaluation);
- 100% saturation is achieved (conservative assumption);
- there is no water waste.

In order to consider two different options, with consequent different benefits in terms of COP which depend on the specific gas cooler design, calculation has been made considering the saturation of the total air mass flow which impacts the gas cooler or only of 30% of it. Results are summarised in Table 2.

Although evaporative cooling is active for a large amount of hours in Bangkok (41.1% of the total hours in the year), the water consumption per kW of rejected heat is not that high, if compared to Tripoli, as the humidity level is already high. It is clear that

Town	Bangkok		Tripoli	
	100%	30%	100%	30%
Precooled air flow to gas cooler				
Evaporative cooling active [hours/year]	3603 (41.1%)		1288 (14.7%)	
Water consumption [m <sup>3</sup> /(kW year)]	3.12	0.94	2.13	0.64

Table 2: Water consumption per kW rejected heat due to evaporative cooling in Bangkok and Tripoli

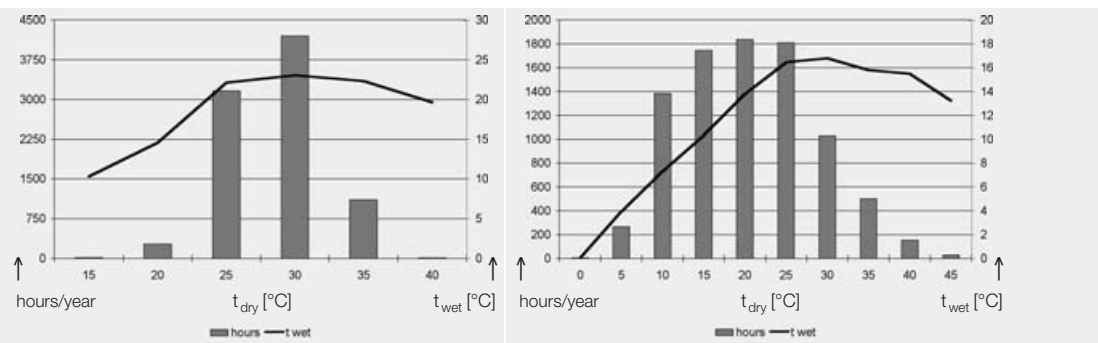

Figure 6: Bangkok temperature distribution

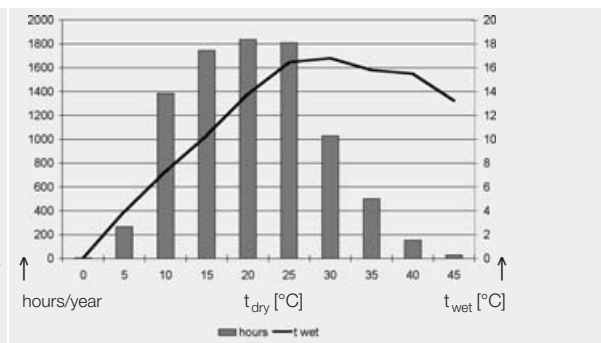

Figure 7: Tripoli temperature distribution

the decrease in temperature in Bangkok is not as relevant as it is in Tripoli. In any case, as it was demonstrated in Figure 6, it allows a significant air temperature decrease when most needed, i.e. when the air temperature exceeds 35°C.

In order to evaluate the benefit that can be derived from pre-cooling the total air stream flowing to the gas cooler, instead of only the flow which cools down the final part of the gas cooler, a specific gas cooler has been chosen, and it has been analysed under the following conditions:

- v. the air investing the gas cooler has uniform temperature, corresponding to the temperature of air out of the evaporative cooler
- vi. the gas cooler is divided into two parts; the first part (just after the compressor) is cooled by ambient air, while the second part is invested by air out of the evaporative cooler.

The gas cooler is arranged in counterflow. Air temperature is 40°C and its relative humidity is 40%. The gas cooler characteristics are listed in Table 3. Gas cooler simulations have been performed with the software RefBox (Ever-est, 2008).

External tube diameter OD	[mm]	10
Tube spacing	[mm]	25
Row spacing	[mm]	22
Fin spacing	[mm]	3.2
Number of rows	[-]	4
Tube length	[mm]	3200
Front air velocity	[m s <sup>-1</sup> ]	1.2
Conventional external heat transfer coefficient	[W m <sup>-2</sup> K <sup>-1</sup> ]	50.3
Compressor displacement	[m <sup>3</sup> h <sup>-1</sup> ]	30

Table 3: Gas cooler characteristics

Under the same assumptions that were made for medium temperature applications and Cycle D (section 1), the simulation of the two different arrangements leads to results which are summarised in Table 4.

In the case that only part of the air stream is cooled down, the water saving is relevant (30%). However, in the specific situation, the COP deterioration is about 11%. The additional energy consumption due to gas cooler ventilation, which is not considered here, can reduce the difference between the two solutions.

		Air temperature after evaporative cooling [°C]	CO <sub>2</sub> temperature out of the gas cooler [°C]	Optimal high pressure [bar]	COP [-]	Water consumption [m <sup>3</sup> /kW/hour]
1)100% precooling	Cycle D	30.2	33.0	81	2.18	0.001566
2)30% precooling	Cycle D	30.2	35.8	89	1.93	0.000487

Table 4: COP and water consumption of two different gas cooler configurations

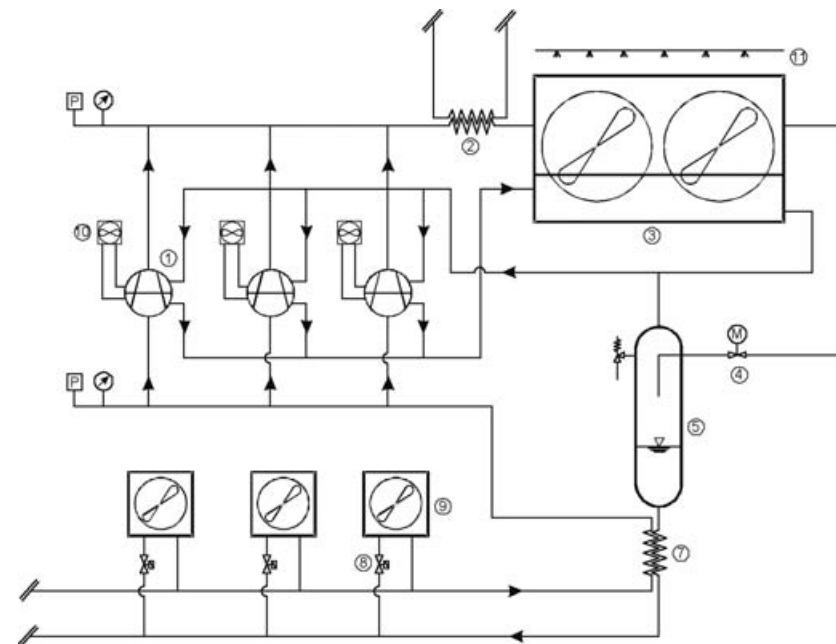

Figure 8: Low temperature unit

## Description of some recent installations

In this section two installed systems using CO<sub>2</sub> as the only refrigerant will be described; they adopt staged expansion and throttling as methods to improve efficiency. Though in the specific case they were not installed in particularly hot climates, the purpose of this section is to illustrate the state-of-the-art technology and to show that there is a real possibility of using CO<sub>2</sub> also were the external temperature is very high.

### Two-stage throttling, two-stage compression, open flash tank cycle for low temperature applications

The low temperature unit which is analysed belongs to a plant which serves a wholesale centre located in central Europe. The low temperature plant is represented in Figure 8. The cycle is basically a two stage compression, two stage throttling cycle, with inter-stage cooling, removal of the flash vapour from the flash tank and regenerative heat exchange (Cycle C). There are three two-stage stage internal compound semi-hermetic compressors (1); the volume ratio between the low pressure and the high pressure stage R<sub>v</sub> is 2.3. A heat recovery heat exchanger (2) is installed just after the compressors, in the machinery room. It is a coaxial type heat exchanger.

The gas cooler (3) is located on the building roof. The gas cooler has been designed for an external temperature of 33°C. Moreover, the gas cooler has been equipped with a device (11), directly spraying water on the heat exchanger; this device, as explained in Zoggia et al., 2006, is turned on when required by high temperature at gas cooler outlet (exceeding 30°C). In the area where the plant is operating the water spray is estimated to be active for 60 hours/year, with a very limited water consumption.

The first throttling device (4) is a step motor valve controlled by a dedicated algorithm. The intermediate pressure vessel (5) is connected via vapour lines directly to the suction line of the high pressure stage. The flash vapour is therefore removed by the high stage of the compressors.

In the area where the plant is located the climate is quite mild and the external temperature is higher than 15°C for around 30% of the time. As a consequence, the CO<sub>2</sub> unit is able to run a subcritical cycle during most part of the year (Chiarello et al. 2007). A picture of the refrigerating unit is presented in Figure 9.



Figure 9: Picture of the LT unit with two-stage compression and two-stage throttling

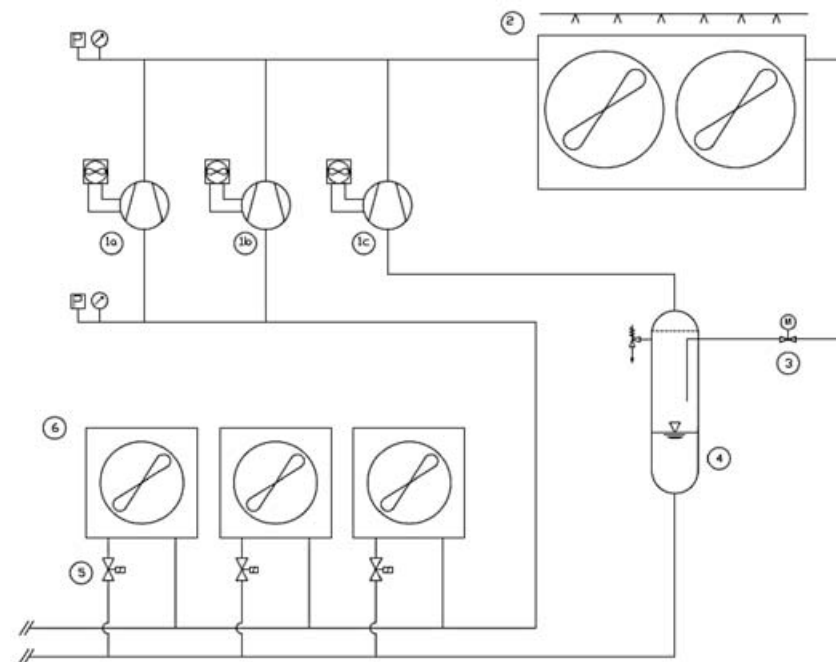

Figure 10: MT plant with parallel compression

### Two-stage throttling, parallel compression cycle for medium temperature applications

This plant was designed for an industrial application. The required evaporation temperature is -5°C. Figure 10 represents in a simplified way the refrigeration plant. The reciprocating single-stage compressors (1a and 1b) suck the superheated vapour coming from the evaporators (6); the gas cooler (2) works also as a condenser during winter time. A water spray system is included for the gas cooler, whenever the external air temperature exceeds 30°C. The gas cooler pressure is controlled by the electronic expansion valve (3), which feeds the intermediate pressure vessel (4). The second expansion takes place at each evaporator (6) by means of electronic thermostatic valves (5). The auxiliary compressor (1c) removes the saturated vapour from the intermediate pressure vessel (4). The pressure inside the vessel is maintained constantly below 45 bar, regardless of the working conditions of the plant; as a matter of fact the compressor 1c is inverter driver, so that it can vary its displacement and keep the pressure at the desired value. In section 1 simulations for this type of cycle (Cycle D) were run at constant intermediate pressure value, though lower (38 bar). This choice is mainly driven by technological issues, although the resulting COP of the cycle is slightly lower than the best one, which can be achieved if the intermediate pressure is optimised at

each working condition. The first benefit lies in the fact that thermostatic expansion valves (5) for cascade applications can be used. In addition they are fed with constant enthalpy liquid, therefore the mass flow only depends on cooling capacity, which is almost constant through the year, thus resulting in very stable operating conditions. This solution, which is particularly interesting for large plants, requires a specific lubricant management system, as the oil must be distributed from the low pressure separator to the compressor 1c, whose crankcase is at an higher pressure (Minetto et al., 2005).

---

## Conclusions

---

Carbon dioxide is nowadays a well-recognised alternative to synthetic refrigerants in mild climates. Complex cycles that involve staged expansion and compression, as well as the use of evaporative cooling to reduce the temperature of external air, have already been explored for improving efficiency. These methods offer the opportunity of using CO<sub>2</sub> as the refrigerant in very warm climates; they limit the energy efficiency penalisation and they help in avoiding technological issues, like high compressor discharge temperature. In the present paper some cycles have been evaluated for medium temperature and low temperature refrigeration applications. At the specific simulation conditions, for medium temperature applications two-stage compression, two-stage throttling with inter-stage cooling and internal heat exchanger cycle offer the best efficiency over the other investigated cycles, while for low temperature two-stage throttling, two-stage compression, inter-stage cooling, split cycle or open flash tank cycle can cope with external temperature up to 50°C.

Evaporative cooling is regarded as a simple and effective method to reduce the gas cooler air temperature with a reasonable water consumption. As a matter of fact this method is particularly effective in dry climates, though it is worth considering its use also in humid climates, when the external temperature exceeds 35°C.

---

## References

---

- Cavallini A, Zilio C, 2006, Carbon Dioxide as a Natural Refrigerant, 5th Int. Conf. Sustainable Energy Technologies, Vicenza-Italy.
- Cecchinato L, Corradi M, Fornasieri E, Zilio C, 2005, Thermodynamic analysis of different two-stage transcritical carbon dioxide cycles, IIR International Congress-Commercial Refrigeration, Vicenza-Italy.
- Chiarello M, Fornasieri E, Minetto S, Zilio C (2007), Recent developments in commercial refrigeration systems using CO<sub>2</sub> as the refrigerant, 22<sup>o</sup> IIR Int. Cong. Of Refrigeration, Beijing, China.
- Ever-est S.r.l., 2008, RefBox, [www.ever-est.net](http://www.ever-est.net)
- Giroto S, Minetto S, Nekså P, 2004, Commercial refrigeration system using CO<sub>2</sub> as the refrigerant, Int. J. Refrigeration, 27(7): 717-723.
- Giroto S, Minetto S, 2007, Recenti applicazioni di compressori alternativi negli impianti per la refrigerazione commerciale secondo cicli mono e bistadio operanti con anidride carbonica. Seminario CTR. Fluidi refrigeranti naturali: sarà l'anidride carbonica la soluzione definitiva?. Padova -Italy. (in Italian).
- Lorentzen G, 1994, Revival of carbon dioxide as a refrigerant, Int. J. Refrigeration, 17(5): 292-301.
- Minetto S, Cecchinato L, Corradi M, Fornasieri E, Zilio C, Schiavon A., 2005, Theoretical and experimental analysis of a CO<sub>2</sub> refrigerating cycle with two-stage throttling and suction of the flash vapour by an auxiliary compressor. International Conference Thermophysical Properties and Transfer Processes of Refrigerants, Vicenza-Italy.
- Officine Mario Dorin S.p.A, 2007, CO<sub>2</sub> Range, Dorin Innovation, Firenze (Italy), 28 p. Termotecnica Pericoli S.r.l., 2008, Pericool® evaporative panels, [www.pericoli.com](http://www.pericoli.com).
- US Department of Energy, Energy Efficiency and Renewable Energy (EERE),2008, Weather Data. [www.eere.energy.gov/buildings/energyplus/cfm/weather\\_data.cfm](http://www.eere.energy.gov/buildings/energyplus/cfm/weather_data.cfm).
- Zoggia F, Filippini S, Perfetti C, Lozza G, 2006, Environmental Friendly Heat Exchangers, 7th IIR Gustav Lorentzen Conference on Natural Working Fluids, Preprints: 366-369.

# The first CO<sub>2</sub> Supermarket Plant in New Zealand

ALEXANDER COHR PACHAI, Johnson Controls, Denmark

---

## Introduction

---

The increasing awareness about the impact that some refrigerants have on the environment and the increasing awareness of the energy prices made the owners of “The Warehouse” supermarket in Sylvia Park, Auckland, invest in a sustainable and energy efficient refrigeration plant which was commissioned in May 2006. The refrigerants used were propylene (R1270) and carbon dioxide (R744). This document explains the thinking behind the introduction of CO<sub>2</sub> technology, particularly concerning global warming and energy consumption.

A state of the art system was offered and held as base line for all comparison during the sales phase, which was based on direct expansion system using large charges of R404A. A system of the size installed in The Warehouse would hold about 800 kg R404A which has a global warming potential (GWP) of more than 3800. TEWI (Total Equivalent Warming Impact, which sums the carbon dioxide equivalent emissions from energy consumption and refrigerant emissions) calculations showed a

remarkable reduction both because of the direct emissions but as HC refrigerants are more efficient than the base line also the energy absorbed was reduced by at least 7%.



Figure 1: The propylene chiller on the roof and the CO<sub>2</sub> unit in the room under during commissioning

## Commissioning

On the 7<sup>th</sup> and 8<sup>th</sup> May 2006 the first propylene/carbon dioxide systems were commissioned for The Warehouse at the new Sylvia Park site in Mt. Wellington, Auckland. The one-stop supermarket has a floor area of 12.000m<sup>2</sup> and has a large food section. The system is at the same time the first system to use CO<sub>2</sub> for cooling the display cabinets and cold rooms for both the low temperatures and for the medium temperatures using propylene on the high temperature stage. This is a major step forward in several respects. The choice of refrigerants reduces the carbon footprint due to less leakage from the system. Also the impact from the energy usage will be reduced. The whole system is compact and has a very limited requirement for space compared to the more traditional installation which uses R404A (or previously, R22).

The design of the system is focused on energy efficiency. One of the high-side circuits is equipped with a heat recovery coil enabling hot water production, which enables savings on hot water production. The hot water can be produced up to about 75°C which is enough for most cleaning activities in a supermarket. Also normal tap water can be produced in reasonable amounts at lower temperatures without affecting the refrigeration plant efficiency.

The site provided a good comparison between the more traditional systems and the new approach. Just few metres from the new system, competing supermarket had installed a traditional R404A plant with just about the same capacity.

Prior to charging any refrigerant the systems were properly evacuated and dried out. This procedure is easier with the relatively high ambient temperatures that are seen in Auckland, compared to northern Europe. The R1270 was of refrigerant quality meaning that the impurities are in the same order of magnitude as found in other refrigerants.



Figure 2: The CO<sub>2</sub> part of the plant and some of the CO<sub>2</sub> cylinders in the background

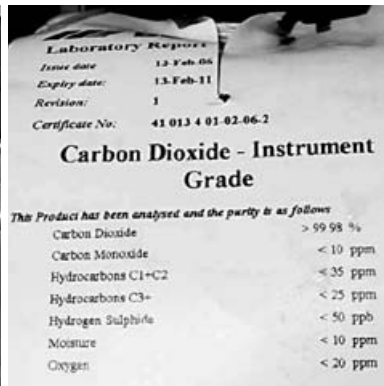

Figure 3: The CO<sub>2</sub> grade used on the system is 3.8 or 99.98% with a very low water content and other impurities

(Incidentally, the refrigerant was actually flown in from Denmark, despite a manufacturer being present in Auckland due to a major price difference.) The total charge in the two systems is about 40 kg, meaning 20 kg in each of the two circuits. The CO<sub>2</sub> was sourced locally in a commonly used purity grade which normally tends to be the cheapest available. CO<sub>2</sub> is produced in several ways and the source often tends to be waste from other activities. CO<sub>2</sub> is therefore a by product which would otherwise have been released to the atmosphere if not bottled and sold as refrigerant. Therefore it has a positive impact on the environment by using CO<sub>2</sub> as a refrigerant. The amount used in the Sylvia Park installation is about 330 kg. The capacity of the plant is:

- For the low-stage R744 circuit, a cooling capacity of 89,6 kW based on -35°C evaporating and -7°C condensing, and
- For the medium stage R744 circuit, a cooling capacity of 190 kW based on -7°C evaporating and condensing, and
- For the high stage HC system, a cooling capacity of 307 kW (divided in two identical circuits) based on -12°C evaporating and +42°C condensing.

Job Reference: .....		Sylvia Park, New Zealand		Date: .....	
<b>INPUT DATA</b>					
Application Sector:	Supermarket				1
Refrigerant Fluid :	R404				2
Refrigerant Charge:	800 kg				3
Annual Energy Consumption (kWh)					
Compressors:	1.127.885				4
Ancillary:	694.236				5
<b>SECTORAL FACTORS</b>					
System Operational Lifetime	10 yr				6
Refrigerant GWP:	3784				7
L1:	10	8	S1:	2	10
L2:	0	9	S2:	2	11
Recovery Efficiency	0.78				12
CO <sub>2</sub> Emission Factor, B (kg CO <sub>2</sub> /kWh)	0.59				13
<b>TEWI CALCULATION</b>					
a) Direct Effect					
Refrigerant Release (Operational) = (3)x(6)x(8+9+10+11)/100	1120				14
Refrigerant Release (End of Life) = (3)x(1.00-(12))	200				15
Total Lifetime Refrigerant Release (kg) = (14) + (15)	1320				16
CO <sub>2</sub> Equivalent (kg) = (16)x(7)	4994880				17
b) Indirect Effect					
Indirect Effect (kg CO <sub>2</sub> ) = ((4)+(5))x(13)x(6)	10750478,45				18
c) TEWI					
TEWI = (17)+(18)	15.745.358 kg CO <sub>2</sub>				CO <sub>2</sub> charge
= (17)+(18)/1000	15.745				0 kg

Figure 4: A TEWI calculation for a R404A system

## A TEWI calculation

Performing a TEWI calculation according to the BRA (British Refrigeration Association) method, shows the difference between the conventional system based on R404A and the new system using natural refrigerants as installed at Sylvia Park. No matter how accurately you try to calculate and simulate the efficiency of a supermarket system, it tends to be very difficult to compare two systems, even if the plants are identical. There are many other factors that disturb the picture, for example, display cabinet overloading, air circulation around the cabinets, customer habits, employee habits, just to mention a few. TEWI is just a best guess and a tool for comparing in the same way the impact two systems have on the global warming. The output of a TEWI calculation is given as CO<sub>2</sub> equivalent to show how much a system impacts the atmosphere in terms of CO<sub>2</sub> released.

Job Reference: Sylvia Park, New Zealand		Date:
<b>INPUT DATA</b>		
Application Sector:	Supermarket	1
Refrigerant Fluid:	R1270	2
Refrigerant Charge:	40 kg	3
Annual Energy Consumption (kWh)		
Compressors:	958.702	4
Ancillary:	711.751	5
<b>SECTORAL FACTORS</b>		
System Operational Lifetime	10 yr	6
Refrigerant GWP:	3	7
L1	10	8
L2	0	9
Recovery Efficiency	0.78	10
		11
		12
CO <sub>2</sub> Emission Factor, B (kg CO <sub>2</sub> /kWh)	0.58	13
<b>TEWI CALCULATION</b>		
<b>a) Direct Effect</b>		
Refrigerant Release (Operational) = (3)x(6)x(8+9+10+11)/100	56	14
Refrigerant Release (End of Life) = (3)x(1.00-(12))	10	15
Total Lifetime Refrigerant Release (kg) = (14) + (15)	66	16
CO <sub>2</sub> Equivalent (kg) = (16)x(7)	462	17
<b>b) Indirect Effect</b>		
Indirect Effect (kg CO <sub>2</sub> ) = ((4)+(5))x(13)x(6)	985668.23	18
<b>c) TEWI</b>		
TEWI = (17)+(18)	9857.348 kg CO <sub>2</sub>	19
= (17)+(18)/1000	9.857 Tonne CO <sub>2</sub>	20
		CO <sub>2</sub> charge 1.812 kg

Figure 5: A TEWI calculation for the installed system. The contribution of the CO<sub>2</sub> charge is calculated separately

From many studies it is a known fact that the R1270 will improve system performance just by changing the refrigerant. However, a study of the first installations in Denmark using this type of system showed that unless variable-speed pumps were employed, the energy consumption was too high. In the Sylvia Park system the pumps are controlled with an inverter in order to optimise the performance. This enables the system to perform better than the standard R404A DX-system.

The TEWI calculation shows that instead of an emission close to 16000 tonnes of CO<sub>2</sub>-equivalent as with a comparable R404A installation, the new system is not likely to contribute more than about 10.000 tonnes of CO<sub>2</sub>-equivalent. That is when the power is generated with a typical European mix. If only renewable energy like hydro power is used, the impact on the environment is negligible. The reduction is mainly due to the change of refrigerant but also to the fact that the natural refrigerants are more efficient than R404A.

## The system

The system design is based on experience done over 7 years with CO<sub>2</sub> as a secondary volatile refrigerant. These systems are based on closed loop where the refrigerant is partly evaporated at a low temperature. Using this technology the pressures in the low temperature circuits do not give any problems in terms of excessive pressure. The R744 leaves the vessel and is condensed in the heat exchanger by using a refrigeration system on the primary side (in this case, the R1270 chillers), although the refrigerant on the primary side can be of any type many installations in Sweden have used different hydrocarbon refrigerants. The condensed CO<sub>2</sub> is returned to the vessel from where it is circulated to the coils in the display cabinets. The system is based on a overfeed system (also called flooded system). In this case it is normal to use a circulation rate of two, which means that at the outlet of the cabinet coil you have condensed 50% of the liquid. The return from coil to the tank is therefore a mixture of liquid and gas. The liquid and the gas are then separated in the vessel and the process starts again. The plant at Sylvia Park is equipped with three Bitzer compressors (type 4F-7.2K) on the R744 side, and four Bitzer compressors (type 6F-40.2P) on the HC circuit. The HC evaporator/CO<sub>2</sub> condenser is placed in the compressor housing on the roof, so there is no HC in the machinery room, which avoids designing the machinery room with the additional safety measures.

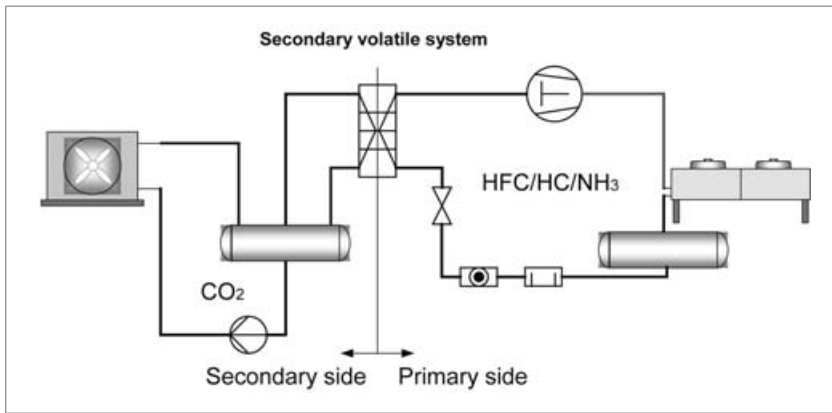

Figure 6: A system using CO<sub>2</sub> as a secondary volatile refrigerant. There is no compressor in the CO<sub>2</sub> cycle

Using this technology at a higher pressure level and introducing the compressors to work on the low stage enables us to utilise the benefits of CO<sub>2</sub>.

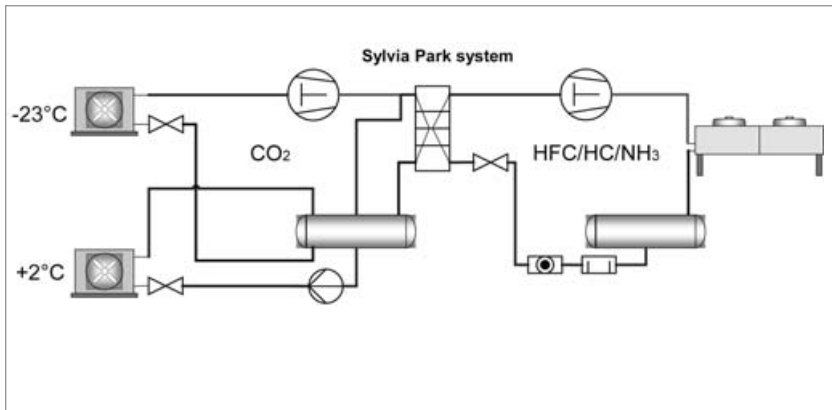

Figure 7: Using compressors on the low temperature stage enables the utilisation of the benefits CO<sub>2</sub> offers

One of the benefits with CO<sub>2</sub> compressors is the high volumetric capacity. In comparing the capacity of the installed compressors at Sylvia Park, it is found that a R404A compressor with a similar cooling capacity, would require four cylinders instead of two and a motor with 20 horse power (HP), instead of the 7 HP motors in the CO<sub>2</sub> compressors.

## Problems in case of leaks

Safety considerations should always be taken seriously regardless the type of refrigerant used. It can be calculated how much can be released in the cold rooms before a dangerous concentration occurs. There is a lot of focus on the hazards of CO<sub>2</sub> systems, but the same hazards may occur with synthetic refrigerants such as R404A and R22. There are different accepted concentration levels for human safety in each country and therefore it is recommended to check the national regulations what levels should be used for low level alarms and what levels should be used for high level alarms. Some general recommendations are given in EN 378 explain, what is that? but they can only be used as guidelines because local laws out-rank any standards.

There is no reason to install alarms in areas where dangerous concentrations cannot build up, but in the case of glass door freezers it is highly recommended to use an alarm as the concentration can build up to dangerous levels.

<p>Ref\$= CarbonDioxide</p> <p>T<sub>room</sub> = 25 [°C]</p> <p>T<sub>liquid</sub> = 0 [°C]</p> <p>Height = 2.7 [m]</p> <p>Floorwidth = 4.5 [m]</p> <p>Floorlength = 45 [m]</p> <p>Floorarea = 202.5 [m<sup>2</sup>]</p> <p>V<sub>room</sub> = 546.8 [m<sup>3</sup>]</p>	<p>m<sub>liquid</sub> = 38.27 [kg]</p> <p>Conc<sub>room</sub> = 3.873 [%]</p> <p>Conc<sub>ppm</sub> = 38726 [ppm]</p> <p>V<sub>liquid</sub> = 0.04127 [m<sup>3</sup>]</p> <p>V<sub>CO2,room</sub> = 21.17 [m<sup>3</sup>]</p> <p>EN378<sub>limit</sub> = 0.07 [kg/m<sup>3</sup>]</p> <p>?<sub>gas</sub> = 1.808 [kg/m<sup>3</sup>]</p> <p>?<sub>liquid</sub> = 927.4 [kg/m<sup>3</sup>]</p>	 <p><b>A JOHNSON CONTROLS COMPANY</b></p> <p>Practical limit kg/m<sup>3</sup> for selected refrigerants</p> <p>R134a Practical limit 0.25kg/m<sup>3</sup> ATEL 0.25kg/m<sup>3</sup></p> <p>R407C Practical limit 0.31kg/m<sup>3</sup> ATEL 0.31kg/m<sup>3</sup></p> <p>R404A Practical limit 0.48kg/m<sup>3</sup> ATEL 0.48kg/m<sup>3</sup></p> <p>R507A Practical limit 0.49kg/m<sup>3</sup></p> <p>R410A Practical limit 0.44kg/m<sup>3</sup> ATEL 0.44kg/m<sup>3</sup></p> <p>R744 Practical limit 0.07kg/m<sup>3</sup> ATEL 0.07kg/m<sup>3</sup></p> <p>R290 Practical limit 0.008kg/m<sup>3</sup> ATEL 0.008kg/m<sup>3</sup> LFL 0.038 kg/m<sup>3</sup></p> <p>R1270 Practical limit 0.008kg/m<sup>3</sup> ATEL 0.008kg/m<sup>3</sup> LFL 0.040kg/m<sup>3</sup></p> <p>R717 Practical limit 0.00035kg/m<sup>3</sup> ATEL 0.00035kg/m<sup>3</sup> LFL 0.104 kg/m<sup>3</sup></p>
<p>▶ <b>Gas detection is required in machinery rooms if the CO<sub>2</sub> charge is &gt; practical limit (0.1 kg / m<sup>3</sup>. ≈ 55.000 ppm)</b></p> <p>▶ (New draft prEN378,2005: charge &gt; 25 kg).</p>		
<p>▶ <b>Max pre-alarm level:</b> <b>55.000 ppm</b></p> <p>▶ (New draft prEN378,2005: <b>19.500 ppm</b>)</p>		
<p>▶ <b>Recommendations acc. to IOR safety code for CO<sub>2</sub> systems):</b></p> <ul style="list-style-type: none"> <li>• <b>Pre-alarm level:</b> <b>5.000 ppm</b></li> <li>• <b>Main-alarm level:</b> <b>10.000 ppm</b></li> <li>• <b>Detectors are recommended in machinery rooms and process areas containing part of the CO<sub>2</sub> charges.</b></li> </ul>		
<p>▶ <b>MAK-value:</b> <b>5.000 ppm</b></p> <p>(Maximale Arbeitsplatzkonzentrationen-Germany)</p>		

Figure 8: A calculation of the maximum allowed concentration of CO<sub>2</sub> in the largest cold-room shows that it is required to install an alarm sensor here. In all other cases it will not be possible to build up a concentration that can cause any problems



## Flammability issues

Hydrocarbon refrigerants are flammable and measures have to be taken to avoid accidents. In this case the plant has been installed on the roof. The components that contain the refrigerant are placed in one end of the unit while the controls are placed in the opposite end of the unit. All controls that are directly connected to the refrigerant, such as pressure switches, are powered by special low voltage supplies so that switching cannot create a spark with sufficient temperature or energy to ignite the gas. A fan ensures that the machine end is vented and that in case of major leaks all power supplies are cut off by means of pressure switch. Pressure relief valves and the connecting pipes are led to the open air in a way that no gas can accumulate and become a threat to anybody.

Conversely, a positive characteristic of R1270 is that it has a very distinctive smell and it becomes unpleasant in even low concentrations. This smell is a natural smell that does not disappear over time. If one uses propane (R290) the smell is obtained by adding mercaptan. The disadvantage of mercaptan, which over time is being absorbed by the filter drier, is that it becomes an acid, because it is sulphur based. Most installations are therefore done with R1270 for safety reasons, but also for economic reason. The first cost using R290 is higher than a system with the same capacity using R1270. This is due to the fact that R290 with the same swept volume has a lower capacity than R1270 and to compensate for this the compressors are larger and more expensive. R290 is mostly used in heat pumps where higher temperatures can be obtained without developing such high pressures in the system. The HC system is made in two independent circuits in order to avoid problems in case of failure of one of the circuits. The two circuit system is also a matter of the availability of evaporators with sufficient capacity. The refrigerant charge in each circuit is about 20 kg.

## CO<sub>2</sub>

The influence on the human body is important to know. At increased levels the CO<sub>2</sub> will react with water to create carbonic acid. Acid can be generated in the eyes and in the throat and gives a sting or irritation. At higher levels you get dizzy and you can get a headache. You will recover as soon as you get out in fresh air. It is important to leave the area as soon as these symptoms are felt.

CO<sub>2</sub> is produced in many ways but is always a waste product from other activities, which is for example the case in breweries, which are big producers of CO<sub>2</sub>. CO<sub>2</sub> is also collected from natural sources where it comes out of the earth. Also the production of NH<sub>3</sub> generates a lot of CO<sub>2</sub> as a by product when natural gas or crude oil is the

source. When you produce one kg of NH<sub>3</sub> you also produce one litre of CO<sub>2</sub> as a by product. CO<sub>2</sub> is a cheap refrigerant and is available at large all over the world in many qualities and purities. It is therefore normally produced locally because the distribution will add too much to the price.

## CO<sub>2</sub> as a refrigerant

CO<sub>2</sub> has many of the same characteristics of other refrigerants but at the same time it is also very different: the triple point is high and the critical temperature is low. When the state goes below the triple point, the liquid turns in to what is know as dry ice. If the temperatures and pressures becomes too high the state will pass above the critical point. Over this point it is not possible to condense the gas. This situation has some impact on how to design and control the refrigeration system. At the same time the system will loose some capacity and therefore some additional compressor capacity should be installed to handle this situation.

The CO<sub>2</sub> part of the installation is unaffected by ambient temperature fluctuations. Only the HC chiller is affected to these fluctuations and the R1270 is better suited to

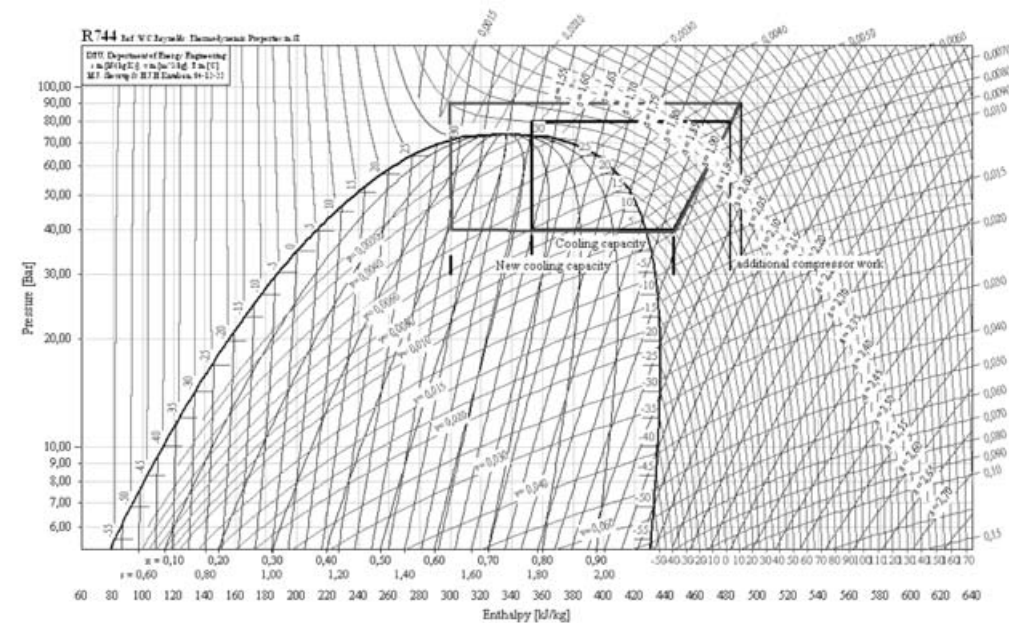

Figure 9: In a sub-critical cycle you loose capacity and the efficiency suffers when you increase the discharge pressure, but this is not necessarily the case in a super-critical CO<sub>2</sub> system

handle the temperature changes over the year, because if it's higher critical temperature. Using the R1270 option even reduces the total energy consumption by 7% compared to the more traditional solution using greenhouse gases such as the synthetic R404A and similar products. In systems operating over the critical point you lose capacity, when you start operating in transcritical mode. You can then try to recover portions of this loss by introducing different measures. Some help more and others not as much. Finding the optimal high pressure is one of the most essential items in running transcritical.

Once over the critical point, the control strategy is important since increasing the pressure is an option to increase both the capacity and also the efficiency. There is an optimum condition over which the system will start losing capacity and efficiency. The condition at which capacity begins to reduce might not be the same as the point at which the efficiency drops.

---

### Final remarks

---

The system had some initial problems that were solved. Since then, the system has now been running for two years and has been very reliable. For warmer climates a cascade using hydrocarbon refrigerants on the high stage side offer good energy efficiency and is very tolerant to high ambient temperature (HC does not break down to acids when the ambient temperatures increase). The CO<sub>2</sub> circuits rarely give problems because it is not exposed to the ambient temperatures. One thing to be careful of is the purity of the gas; non-condensable gases cannot be blown off, and that can lead to a shut down of the plant and evacuation of the system before recharging, which can easily take a whole day.

The system works perfectly in the Auckland climate. Since the first start up, the competing supermarkets have been testing alternative technologies. For example, Woolworth Supermarkets in Australia have recently announced that they have based on their experience with cascade systems now taken the decision to go down this route. Both HC and CO<sub>2</sub> refrigerants are forgiving refrigerants, provided that you observe some general rules of thumb. The HC charge can be isolated to a safe place and CO<sub>2</sub> does give a very good cooling for the user.

# Natural Refrigerants in Dairy Processing, Supermarket Refrigeration and Air Conditioning

DR. KARIN JAHN, Eurammon, Germany

---

## Introduction

---

In February 2007, the Intergovernmental Panel on Climate Change (IPCC) presented its climate report. This report predicts that the mean global temperature of the lower atmosphere will rise by about 3°C by the year 2100. The consequences include the melting of the Greenland Ice Sheet and Arctic ice, rising sea levels, and increases in extreme weather conditions. The only way to slow climate change is by cutting greenhouse gas emissions.

“For refrigeration, this means giving priority to natural refrigerants,” says Monika Witt, CEO of eurammon, the European initiative for natural refrigerants. “Either they make no contribution at all, as in the case of ammonia, or a negligible contribution, as in the case of carbon dioxide or hydrocarbons, to the greenhouse effect. The fact that the use of carbon dioxide in refrigeration is considered environmentally compatible may seem surprising at first, but the quantities and the amount of energy used in producing it are so small when compared to worldwide carbon dioxide emissions that they would pale to insignificance in the climate statistics.”

---

## World first carbon dioxide freezer

---

One of the first companies to opt for carbon dioxide as a natural refrigerant is the food and beverages giant Nestlé, which beyond mineral water, baby food and coffee, is especially well known for its ice cream products. Nestlé operates a large ice cream factory in Bangchan, Thailand. To meet the growing demand for Nestlé's brands, Nestlé Thailand needed to extend its Bangchan ice cream factory and increase production capacity. This also involved the refrigeration units, which still used the synthetic refrigerant HCFC-22. In line with Nestlé's environmental sustainability policy, natural refrigerants were to be given preference. In cooperation with Johnson Controls Inc. (formerly York Refrigeration International) and Gram Equipment A/S,

Nestlé engineers installed the world's first commercial ice cream freezer using carbon dioxide. The freezer surpasses the efficiency of conventional freezing solutions. In addition to the new freezer, Nestlé also installed a new freezing tunnel, which is used to harden ice cream. The refrigeration required by the tunnel is provided by a compact cascade system containing an ammonia and carbon dioxide cycle. Nestlé put both of these new facilities into operation in 2005/2006, setting new standards for the use of natural refrigerants in the Asia-Pacific region: This is well ahead of what was required by the Montreal Protocol for developing countries such as Thailand, where the HCFC phase-out is not due until 2030.

Other companies of the food sector have moved to natural refrigerants as well. A high efficiency ammonia-based refrigeration plant was built in Prague, where a consumer goods manufacturer has its Czech headquarters, which encompasses numerous production and administrative buildings. Because the margarine and edible fats unit, which produces well-known brands, needed to expand, the company needed a new store at short notice. The aim was to minimise the refrigerant charge while maximising the cooling output. So the Czech contractor Bohemiachlad implemented a central dry expansion ammonia plant, which has a refrigerant charge of just 100 kg. Ammonia is only used in the machine room, while the chill store is refrigerated using water as a coolant. The chiller provides cold water at 3°C, which warms to about 10°C in the wake of the cooling process. Among the main components of the plant are three screw compressors, variable speed compressors, plate heat exchangers and condensers. The coolant evaporating temperature is 0°C, and the condensation temperature is 35°C. The two-megawatt chiller is one of the largest plants in Europe. All of its processes are centrally controlled and monitored by a computer-aided control system.

---

### Storing cooling energy in an ice bank

---

The German contractor Kältetechnik Dresen + Bremen GmbH built a single-stage pumped-ammonia refrigeration system with an ice water silo for crushed ice for the Nordmilch eG dairy. At the heart of the facility in Beesten, Lower Saxony/Germany, are two Grasso screw compressors, which are installed together as a so-called Duo-Pack on a shared frame. The entire cooling system is filled with 2,700 kg of ammonia and has a maximum refrigerating capacity of 1,200 kilowatts for direct cooling of ice water or for making crushed ice. The coolant evaporating temperature is -2°C for direct cooling and -6°C for ice making. The condensation temperature is 35°C. The ice is made at night and at off-peak times by three trickle coolers and is then stored as cooling energy in a silo, or ice bank. During the day, three pumps are used to pump ice water, that is about 0°C to 1°C in temperature, to where it is needed for the production processes, for example to cool the raw milk that has just been delivered. The

chilled water, which by that time has been warmed up, is then cooled again in an ice water pre-cooler, before being returned to the ice bank. The trickle coolers are also used for direct water cooling as well as for ice making. Using the crushed ice bank, Nordmilch can, on the one hand, take advantage of the cheaper off-peak electricity and, on the other, reduce peaks in power consumption. A key advantage of this plant's method of using a crushed ice bank is the ability to attain a very high melting rate thanks to the high contact surface area of the crushed ice in the ice bank. Indeed, the operator has repeatedly confirmed that the ice water supply temperature never exceeds 1°C, even though the load is now twice what the system was originally designed for. The Sachsenmilch AG dairy was also seeking ways to save money by reducing the high power costs incurred by cooling and refrigeration. So Johnson Controls Systems & Service GmbH (formerly York Deutschland GmbH) designed an ice water pre-cooling plant for its headquarters in Leppersdorf, Saxony/Germany. This allows the warmed water, returning from the cooling system, to be cooled to 1°C before it is returned to the ice water tank, reducing the load on the system. A key component of the ice water pre-cooling system are Sabroe screw compressors, which have a refrigeration capacity of 2,400 kilowatts each. They use ammonia, with a charge of less than 750 kg per unit. The evaporating temperature is -1.5°C and the condensation temperature is 35°C. The evaporator is a gravity-driven plate heat exchanger fitted with a separator. This improves the efficiency vs. direct expansion systems, which again cuts operating expenses. Other components include a 3,000 kilowatt evaporative condenser as well as a heat dissipater and oil coolers for recovering waste heat. Complex PLC controls ensure that the temperature of the ice waters fluctuates by no more than 0.5°C. So far, Johnson Controls Systems & Service has installed four such cooling systems for Sachsenmilch, with a total refrigeration output of 9,600 kilowatts.

---

### Cooling supermarkets the environmentally friendly way

---

Intense research and development since it was rediscovered have led to carbon dioxide now being practical for use in many different applications. One promising field of application is supermarket refrigeration, where HFCs still dominate at present. For example, the Danish supermarket chain Super Best has installed a carbon dioxide based cascade system at its Copenhagen branch. In Denmark, the use of more than 10 kilograms of fluorinated gases (F-gases) in newly installed refrigeration systems has been prohibited by law since 2007. So refrigeration specialists Knudsen Køling designed a refrigeration system that uses two refrigeration circuits linked by a plate heat exchanger. This allows three different temperature levels to be achieved, two of which are used for cooling and one for heat dissipation. The first temperature level is needed in frozen food cabinets and the deep freeze chambers in the cellar. At an evaporating

temperature of -28°C, the carbon dioxide is used to maintain an ambient temperature of -20°C. The second temperature level is used for refrigerators and cold stores requiring an air temperature of a few degrees above 0°C. This is achieved by supplying the evaporators with carbon dioxide at an evaporating temperature of -10°C. The third and highest level ensures reliable heat dissipation by condensation or gas cooling, depending on the ambient temperature. Overall the cascade system has a refrigeration capacity of 150 kilowatts.

Güntner components are used for the various temperature levels generated by the system and the cold stores are fitted with evaporators. The heat dissipation enables an evaporator to function as a gas cooler at elevated ambient temperatures and hypercritical processing. To guarantee the operational safety of the system even at pressures of around 120 bar, Güntner used 0.7 mm thick stainless steel for the gas cooler and the entire piping network. Thanks to its low-noise design, the gas cooler can even be used in locations with very high noise-control requirements, e.g. residential areas. The injection to the evaporators and the cooling unit is controlled by Danfoss electrical components. There are currently eleven of these combined deep-freezing/normal refrigeration systems installed throughout Europe, as well as 100 deep freezer systems in use in supermarkets.

---

### Protecting servers against overheating

---

Carbon dioxide is also used in air conditioning. The Dutch bank ABN Amro, for example, has since 2006 used a carbon dioxide air-conditioning system to protect the powerful blade servers from overheating in the computer centre at its London office. It was planned, implemented and commissioned by Trox AITCS in cooperation with Star Refrigeration. The system consists of two compact heat exchanger and pumping units. The heat exchanger uses cold water to condense carbon dioxide gas, which has been evaporated in a heat exchanger mounted on the backs of the blade server cabinets. A stainless steel piping system connects the carbon dioxide circuit to 15 cooling units. These cooling units have five independently powered fans, which extract the heat from the cabinets. The chilled water circuit, at 6°C, condenses carbon dioxide, which is pumped out to the server cabinets by centrifugal pumps, evaporated and returned to the condenser to begin the process again, all at a constant saturated temperature of 14°C. Carbon dioxide is ideal as a refrigerant for this application because it is an electrical insulator and is thus totally safe, and in comparison to a water cooling system the operator makes an energy saving of about 30%. The carbon dioxide concentration in the cabinets and in the server room is monitored continuously. The whole system has a refrigeration capacity of 300 kilowatts – 20 kilowatts per cooling unit. This high cooling capacity makes it possible to put more servers than usual in

each cabinet, thereby reducing the space required by more than half. Trox AITCS and Star Refrigeration have installed similar systems for JP Morgan, Barclays Bank, Norwich Union and at Imperial College London. The most recent development in this application of carbon dioxide as a volatile secondary refrigerant is for close control cooling of dealer desks on the trading floors of investment banks.

---

### Natural refrigerants are spreading

---

“These examples clearly show that plants using natural refrigerants like ammonia or carbon dioxide are not only better for the environment, but also cut overhead costs,” says eurammon’s Monika Witt. “Because natural refrigerants are very efficient, it is possible to achieve the required refrigeration output while consuming significantly less energy. That really adds up for the plant operators.” Due to these qualities, the interest for natural refrigerants is spreading beyond their traditional fields of application such as the food industry, air-conditioning in buildings, and the chemical industry. For instance, in September 2007 car manufacturers of the German Association of the Automotive Industry agreed to use carbon dioxide as the future refrigerant in air conditioning units – an important step on the road to more sustainable refrigeration and air conditioning technology.

# Water Chillers with Ammonia for Building Services

DR. ANDY PEARSON, Star Refrigeration Ltd., UK

---

## Introduction

---

When R-22 is to be replaced in larger refrigeration and air-conditioning systems it is not always possible to find an HFC refrigerant suitable for the substitution. There are no azeotropic blends suitable for use as drop-in replacements in flooded R-22 systems and the cost of modifying the system to cope with R-404A or R-507 can be prohibitively expensive. The risk of refrigerant leakage from a large system is also a factor when considering replacement – the high cost of HFC refrigerants creates a significant risk of severe financial penalty in the event of some losses after conversion.

When R-22 is being phased out, it is therefore more common to find a natural refrigerant being used in new systems. Those most commonly used in large industrial systems are ammonia and carbon dioxide. Both are long established as refrigerants, having been in use since the mid-nineteenth century in the early days of mechanical refrigeration, and both are commonly used in other industrial processes, so they are cheap and readily available. They are also not likely to be subject to any production or use bans in future legislation.

Ammonia is recognized as the most efficient and reliable solution for industrial refrigeration where its toxicity and mild flammability are not deemed to be a hazard, but these characteristics limit its applicability to large installations where a moderate leak from the refrigeration system cannot directly affect large numbers of people.

For these reasons ammonia is also of interest to building services applications such as air conditioning. In situations where ammonia is difficult to employ, carbon dioxide can be used alongside it. This therefore provides an overview of the implications associated with using ammonia in such applications, how to overcome certain problems, and lastly, indicates some situations where carbon dioxide has also been employed.

---

## Background

---

Anhydrous ammonia has been used as a refrigerant since 1872, but towards the end of the 20th century its use was increasingly limited, being generally restricted to large industrial systems and some older ice rinks. Between 1950 and 1985 it was not used in air-conditioning applications, being displaced by equipment which was cheaper to install and easier to maintain. Smaller water chillers in this market used R-12 or R-22 reciprocating compressors and larger plant (typically above about 2,000 kW) used centrifugal compressors with R-12 or R-11, or in some cases azeotropic blends such as R-500, which allowed equipment designed for 60 Hz to be used in Europe. It might be thought that concerns about safety would feature highly in the decision to avoid ammonia, but it seems that cost and convenience were more important factors. The hazards presented by an ammonia system are different to those of, for example an R-12 plant but a rigorous risk analysis would show that the dangers of asphyxiation in the event of a leak or phosgene poisoning in the event of a fire are far greater when CFCs are used. The threat of a phase-out of CFCs prompted a re-evaluation of ammonia as an alternative to HFCs in the early 1990s, and when the CFC phase-out was coupled with a ban on new HCFC equipment, which was completed in Europe in 2000, there was a sharp increase in the installation of ammonia chillers. They are not simple substitutes for fluorocarbon chillers, and if used they must be positioned and installed with care. This can cause difficulties for building services designers who have become accustomed to the flexibility of location offered by traditional chillers, but it is also noted that requiring a building designer to give consideration to equipment access and maintainability is not a bad thing. It has been suggested that ammonia chillers are less efficient than those using R-134a as refrigerant, but careful analysis of their respective performance maps has shown that this is not the case, indicating instead that a typical ammonia system will be up to 20% more efficient on an Integrated Part Load Value (IPLV) basis (Pearson, 2004).

---

## Location options

---

The European Standard on Refrigeration Safety and the Environment, EN378:2000, places some constraints on the ways in which ammonia plant can be used and the locations in which it can be placed. Ammonia is classed as a B2 refrigerant; toxic and mildly flammable, and so access to ammonia plant must be restricted to authorised personnel. Chillers must be placed in a machinery room, or outside the building where access is restricted.

## Rooftop

If a rooftop location with safe access can be provided then this is likely to be the preferred option. It is usually possible to design a chiller/condenser combination to fit within the same footprint as would be required for cooling towers. Access to the area of the roof will typically be controlled by a keyholder and permit to work system, which will provide sufficient security. Care must be taken to consider the consequences of a leak of ammonia, particularly with regard to fresh air inlets, openable windows and other accessible spaces such as balconies. This applies to neighbouring properties as well as to the chiller building. Consideration must also be given to what will happen in the event of a large spill of liquid, bearing in mind that ammonia should not be discharged into rainwater drains. A typical solution is to minimise the run of high pressure liquid line from the condenser, and to house the chiller in a sealed, weather-proof enclosure. In this case a leak of liquid will reach the atmosphere as vapour in a controlled manner and will present less of a hazard. If the neighbouring properties overlook the rooftop location it is probably not suitable for large ammonia chillers, but if the building is the same height or higher than the adjacent ones then a rooftop system is more feasible.

## Internal plantroom

If a rooftop location is not feasible, either because of space, or suitable access, or proximity to air intakes or windows then EN378 permits the use of an internal plantroom. However there are several stipulations. The plantroom must be fitted with self-closing, tightly sealed doors, and must provide a means of emergency escape to fresh air, or to an escape corridor leading directly to fresh air. In practice this means that internal plantrooms are usually on the ground floor at the edge of the building, and it is not usually possible to find a suitable site in an office block. An alternative location which would be permitted would be on an upper floor where the escape route was onto a lower roof level, or for example into the upper floors of a multi-storey car park. The internal plantroom should be designated as a refrigeration plant room and should not be used for other purposes. It must not for example contain any fired burners or naked flames, and it should not be used as a workshop or other generally occupied space. It should not be used for storage of combustible materials, and the electrical supply should be capable of isolation from a safe location outside the plant room. It is usual to install gas detection equipment and automatic isolation in the event that an ammonia leak occurs in the plant room.

## Basement

Usually it is not possible to install ammonia chillers in basement plantrooms, however in one recent project where R-11 chillers were replaced, this was feasible. The requirement in EN378 that there should be a means of emergency escape leading directly to fresh air is what precludes this location.

In the successful project the R-11 chillers were located in a room at the first basement level in an acoustically lined plantroom. The exit path from the R-11 chillers led through the boiler plant room, through a vestibule and past a lift to a fire exit at the entrance to an underground car park. In surveying the building it was noticed that a new exit could be created by knocking a door through from the plant room to the foot of the car park ramp. This provided a sufficiently direct means of escape. The acoustic panelling was replaced by a blockwall construction to seal the plantroom from the boilers, and fresh air inlet ducts were installed from street level to provide normal and emergency ventilation. The chiller room has two ventilation fans, sized to provide adequate temperature control of the plant room in summer conditions. This equates to 30 air changes per hour, which means that only one of the fans is required to deliver the emergency ventilation rate of 15 air changes per hour. In the event of an ammonia leak both fans are energised, but if one fails the emergency vent is not compromised. The exhaust duct runs from the plantroom to the roof of the building, some 30 m above street level. Care was taken to ensure that the vent terminated where there was no risk of affecting any maintenance workers who might be on the roof, and a repeater beacon from the ammonia detection system in the basement was positioned next to the roof access door to give a visual warning that the system was operating. To ensure the integrity of the extract duct a double-skinned stainless steel boiler flue was used, with the extract fans placed outside the plantroom so that the room is at negative pressure under emergency conditions. The boiler flue ran within some redundant air conditioning ductwork and services risers to roof level in the same way as normal flue gases would be handled.

---

## Heat rejection options

---

Heat rejection options include water cooled systems such as evaporative condensers, air cooled systems, and indirect configurations using cooling towers.

### Water cooled

All chillers are most efficient when the temperature lift is minimised, and as evaporative cooling equipment rejects heat at the wet-bulb temperature rather than the dry-bulb, the design condensing condition for an evaporative condenser can typically be 15 K lower than for an air-cooled condenser. However the major objection to evaporative cooling of all types in the United Kingdom is the risk that people in the vicinity may suffer the effects of Legionnaire's Disease and the user of the chiller might be prohibited from using it until the source of the bacteria has been established and treated. There are also substantial penalties for failure to comply with legislation, which in turn can require extensive record keeping and additional work on site.

For larger systems, typically above about 750 kW, the evaporative condenser is particularly well suited because it offers a relatively small footprint and low noise level compared with air cooled alternatives.

### Air-cooled

Air cooled condensers are well suited to smaller duties, below about 500 kW, and are usually impractical for chillers above about 1500 kW. The higher discharge pressure required to reject heat to the dry bulb temperature is a major disadvantage for HFC refrigerants, particularly blends with low critical temperatures like R-407C and R-410A as they become very inefficient at higher discharge pressures. Although ammonia has a very high index of compression, and therefore would tend to run at high discharge superheats this is not a problem for chillers using screw compressors because the discharge temperature can be moderated through oil-injection. The oil cooling circuit can easily be incorporated into the condenser, either directly if the condenser is adjacent to the compressor, or by using a closed loop glycol circuit in the condenser. This has no effect on the overall size of the condenser as the same amount of heat is rejected, and the condenser performance is dominated by the air-side heat transfer coefficient.

### Indirect heat rejection

If the amount of refrigerant contained in an evaporative or air-cooled condenser is not acceptable for the particular installation, or there is some distance from the plant room to the heat rejection equipment then a water cooled condenser can be used, coupled with an evaporative cooling tower or a dry air cooler. This is a very convenient solution as there is no need for long ammonia pipes between plant room and roof, but it does make the overall system less efficient. This is partly due to the higher discharge pressure required in the refrigeration plant, but is mainly because of the additional water pumps required. It is important to include strategies for minimising this energy use, through careful system design and control strategies such as variable speed pumps. A further advantage of this type of heat rejection is that it provides good opportunities for the recovery of large amounts of low grade heat – typically water can be heated to about 35°C without excessive head pressure on the ammonia plant. If higher temperatures are required then a careful assessment of the benefit versus the increased power consumption of the chiller is required bearing in mind that the chillers would run at much lower head pressures in colder weather if heat recovery were not required.

## Charge considerations

One of the key strategies for minimising risk in the design of an ammonia chiller is to make the charge as small as can be achieved within reason. The benefits of low charge are that in the event of a leak there is less scope for creating a major incident, but a full risk analysis requires more complex treatment of the issues. For example it is possible to design systems with extremely low charge – 28 g per kW has been reported (Tychsen, 1996). However such systems are very susceptible to slight losses of refrigerant, which can lead to lack of capacity, impaired efficiency or reduced reliability. In such cases there will be an increased need for on-site maintenance, sometimes involving bringing ammonia cylinders onto site and re-charging. This represents a significant proportion of the total hazard, so designing for absolute minimum charge can actually increase the risk of an ammonia leak. The optimum system will have as low a charge as can reasonably be achieved without compromising operability. In such a system a slight loss of ammonia will be evident from system running logs but will not have a significant impact on system operation in the short term.

For example a low pressure receiver system used for ammonia chillers with plate heat exchangers and plate evaporators will typically have a charge of about 100g per kW. If some of that charge is lost the first effect observed will be a reduction in liquid sub-cooling, followed by an increase in suction superheat. The plant capacity and efficiency will only be affected once the superheat is further increased, so the inherent characteristics of the system, if correctly monitored, can provide early warning of small losses of refrigerant, even if the ammonia detection system has not been activated. Low charge can be achieved by avoiding the use of direct condensers, avoiding high pressure liquid receivers, avoiding gravity fed evaporators and ensuring that there are no other large volumes of liquid in the circuit. Oil cooling systems which require a preferential liquid feed, such as thermo-siphon or liquid injection should be avoided for this reason. A system illustrating all of these low charge features is shown in Figure 1 (Pearson, 2002).

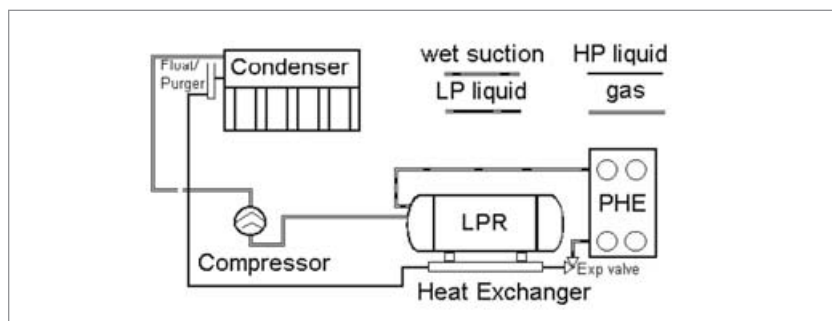

Figure 1: Low pressure receiver system used with plate heat exchanger

## Ventilation options

If the chillers are installed in a machinery room then it will require mechanical ventilation for normal running and emergency ventilation designed to keep the ammonia concentration down to acceptable levels and to minimise flammability hazards. The normal ventilation is typically designed to limit the temperature rise in the plant room to 10K above ambient when all plant is running, and this can typically give a ventilation system of up to 30 air changes per hour. The emergency ventilation requirement is defined in EN378:2000. An alarm is required at 500 ppm (v/v) ammonia concentration, and at a level not exceeding 30,000 ppm (v/v) the electrical supply to the machinery room must be isolated, either automatically or by manual action from a permanently manned monitoring station, except for equipment suitable for use in a potentially explosive atmosphere. It should be noted that these requirements do not provide personnel protection, but are designed to avoid ammonia explosions. It is not necessary under the regulations to provide detection in the plant room to indicate the long term exposure level or short term exposure level of 25 ppm and 35 ppm, nor is it necessary to provide ventilation to meet these levels as by definition the plant room should not be occupied in normal operation. Considered in this light, provided the electrical equipment is correctly isolated and provided there is no hazard to personnel or equipment there is not any need to clear the atmosphere in the plantroom rapidly. In an office building situation it might be more appropriate to develop procedures which contain the ammonia vapour within the plantroom, and then ventilate it in a controlled manner. This could be through an air scrubber or other treatment system, or just gradually venting to atmosphere. Of course this would take time, and meanwhile the leak could not be repaired and the plant would be offline, but it is common in such buildings to contain each chiller within a separate compartment, and to provide some standby capacity. In addition if the leak occurs at night, at the weekend or in the winter then the cooling demand is probably less and so immediate ventilation and repair is not necessary. A suitable scrubber might take the form of a simple water curtain in the exhaust duct, or the water might be treated with a weak acid, such as citric acid, to increase the treatment capability. This tends to neutralise the ammonia solution, ideally to a neutral pH which can be more readily removed. It is also possible to inject carbon dioxide either into the air or into the water to achieve the same effect. Mixing ammonia and carbon dioxide in air produces ammonium bicarbonate, a key ingredient of biscuits and cakes.

In a rooftop installation where the chillers are each contained in a weatherproof housing it is not necessary to follow the machinery room guidance, but it is still common to find these housings equipped with detectors and ventilation systems. The minimum requirement for rooftop housing would be to ventilate in order to keep the plant within



temperature limits in normal operation and to isolate the electrical supply (manually at a manned station or automatically under control of the gas detection system). There is no need to run emergency extract fans automatically, and it might be decided in some situations that it is better to reduce the ammonia level gradually in a controlled way. On one installation in England, on the roof of a supermarket in a crowded shopping mall, the ammonia compressors suffered frequent gland seal failures. It was possible to lose the entire charge of the chiller (300 kg) several times without any complaints from staff or shoppers of the smell of ammonia. The first sign of trouble was when the chiller was called to run and failed to start because it had completely lost its charge. Where the chiller is contained within a housing it might therefore be preferable to minimise uncontrolled loss of ammonia by turning off the ventilation when the trigger level is reached. The ammonia within the housing could then be dealt with in a controlled manner, for example by purging the housing with carbon dioxide, or ventilating the housing into a water tanker brought to site for the purpose.

---

## Noise and vibration

---

In comparison with standard HFC chillers the plant installed in ammonia systems tends to be of heavier construction using industrial components. This can cause issues with noise and vibration, particularly if reciprocating compressors are used, and particularly for rooftop locations. There are three considerations when designing chiller installations for noise and vibration: the maintenance engineer, the building occupants and the neighbours. It is expected that the noise levels within plant rooms will be sufficiently high as to require the use of ear defenders during maintenance. Construction of a sufficiently heavy plantroom wall will prevent this airborne noise from travelling to the building occupants, but attention must also be paid to noise breakout through doors, ventilation ductwork or poorly sealed pipe penetrations. Other sources of noise transmission to occupants are generally vibration related. When reciprocating compressors are used this is particularly a problem at low frequencies. It may even be necessary to isolate the evaporator from the compressor to eliminate vibration through the chilled water. This can be difficult because the compressor will be open drive, either direct coupled or belt driven, and the compressor – motor combination must be treated as a single unit. It might be simpler to isolate the evaporator from the compressor base-plate and allow plenty of flexibility in the suction pipe. With larger chillers screw compressors are more likely to be used. They will transmit less low frequency vibration to the fabric of the building, but the higher frequency vibrations generated are more likely to cause complaints unless they are attenuated. It should also be noticed that a typical screw compressor running at 3000 rpm will have a rotor passing frequency on the discharge port, where most of the noise is generated,

of about 250 Hz. This could be high enough to interact with traditional vibration isolators at the spring surge frequency, transmitting a tone through the mounting at this frequency or a harmonic of it.

The springs should be selected to ensure that the surge frequency is not within 5% of any of the harmonics of the rotor passing frequency. This can be a problem with a variable speed drive as there is bound to be a clash at some point across the speed range. In the example above the vibration generated at the discharge port of the compressor will exactly match the spring surge frequency at a compressor speed of 1860 rpm. It may be necessary to program the drive to avoid certain speeds, or to mount the whole chiller assembly on a high frequency isolation pad in addition to the spring mounts. Alternatively the surge frequency can be modified by changing the number of active coils. Two “half-springs” fitted end to end will give the same basic performance, but with double the surge frequency. In the example this would raise the surge frequency to 310 Hz – above the maximum frequency generated at the discharge port. Transmission of noise to neighbours is very likely to be airborne. The main source will be the condensers, which can be treated in exactly the same way as for traditional chiller plant, either by selecting low speed fans coupled with larger coil areas, or by adding attenuation. For rooftop mounted plant with screw compressors an attenuated housing will also be required in sensitive areas, bearing in mind the possibility of airborne noise breaking back into the building as well as reaching the neighbours.

---

## Further developments

---

Smaller compressors are likely to be developed for packaged ammonia chillers, particularly screw compressors in the capacity range 50 kW to 150 kW and reciprocating compressors in the range 10 kW to 50 kW. This may be in conjunction with the development of semi-hermetic compressors for ammonia. This has been done by two German manufacturers using aluminium windings, with mixed results, and the machines are not widely used. For smaller machines canned motors as used in liquid pumps may also be used, but probably with a limit of 7.5 kW using current technology. The hermetic ammonia compressor would resolve several of the issues mentioned previously, including shaft seal leaks, size and weight, and vibration isolation. The arrival of a small centrifugal compressor for R-134a has prompted speculation that a similar low noise, low vibration oil-free machine might be developed for ammonia. While these characteristics would be highly beneficial in the building services market, the development is unlikely to happen. The very low molecular weight of ammonia (one-sixth of R-134a) means that very many stages of compression would be required; at least eight in the rotor size and speed range available. Another development which would favour the use of ammonia chillers is the air-cooled condenser based on a microchannel

heat exchanger. This would enable low charge systems, of the order of 75 g per kW to be designed using direct heat rejection rather than a plate heat exchanger and dry air cooler. Condenser systems of about 30 kW have been tested very successfully and production facilities are coming on line for larger units, perhaps up to 500 kW in a single condenser.

---

## Installations using carbon dioxide

---

Where ammonia cannot be used the favoured alternative is often carbon dioxide. This offers efficiencies similar to ammonia, but generally from slightly more complex systems. This is due to the high operating pressure of carbon dioxide, which means that the pressure in the system is higher than atmospheric at all operating temperatures. The high pressure also reduces the size of carbon dioxide pipes and compressors, but it means that evaporators may need to be designed for high operating pressures, particularly if hot gas defrosting is required.

When these natural refrigerants are used instead of existing R-22 systems it is often as part of a complete plant replacement, but in some cases parts of the old system can be re-used. Several brief descriptions of projects where R-22 was removed and ammonia or carbon dioxide was used are described here.

- In a freezer drying plant in 2001 a two-stage R-22 plant was stripped out and replaced with a carbon dioxide/ammonia cascade system. New air coolers were provided for the freezer chamber, but the existing vacuum freeze drying coils were cleaned out and re-used with low temperature carbon dioxide. This raised the operating pressure in the coils from -0.5 bar (gauge) to 8 bar (gauge), but the original coils were suitable for the higher pressure. The total plant capacity was 2,400 kW at -50°C.
- In an office complex in England in 2001 a pair of R-11 chillers were replaced with two evaporative cooled, roof mounted ammonia chillers. The new plant fitted within the footprint of the original cooling towers and provided a significant reduction in electrical consumption for the plant. Installing all the chiller plant at roof level also freed a significant amount of plantroom space in the basement when the old chillers were removed.
- In a distribution centre in England in 2005 the R-22 plant was completely replaced with a carbon dioxide/ammonia cascade system. The old plant remained in operation while the conversion work was completed, and was then stripped out at the end of the project. The distribution centre remained in operation throughout the project. To achieve this it was necessary to construct a new machinery room alongside the existing one and install the new system while the old one was still in operation.

- When an existing R-22 system is to be replaced in order to eliminate ozone depleting substances it can sometimes be possible to re-use a significant amount of original equipment. For example although converting the original R-22 system to R-404A may be very unattractive it may be possible to retain the existing compressors, convert them to R-404A and feed a carbon dioxide cascade heat exchanger, substituting the R-22 in the evaporators with carbon dioxide. The R-404A charge is kept extremely small for the size of plant, and the risk of leakage and expensive refrigerant loss is minimized because all the refrigerant is contained within the machinery room and the condensers. A project of this type was completed in England in 2007 for a food hall in a large department store. In this case the display cases were replaced as part of a major refurbishment, but the compressor/condenser unit on the roof of the store was retained. The liquid feed from the condenser was connected to a carbon dioxide cascade heat exchanger and liquid carbon dioxide was pumped through new pipework to new evaporators in the new display cases. The new pipework was rated for 40 bar, and was copper brazed throughout. In this way the R-404A charge was reduced from several tonnes to tens of kilogrammes. With the correct control of the new R-404A such a system can operate more efficiently than the old style because the suction line pressure loss is greatly reduced.

---

## Conclusions

---

Ammonia chillers have been shown in numerous installations to be a viable alternative in a building services environment. Care must be taken in the early stages of the design process to ensure that the hazards associated with ammonia are designed out of the installation. Chiller location, heat rejection equipment and emergency arrangements are key aspects. The use of ammonia also offers beneficial possibilities in the effective, reliable and efficient operation of the plant. The use of industrial style equipment in a commercial building requires particular attention to structural support, acoustic treatment and vibration isolation. These issues are also best dealt with early in the project, and can often be designed out completely. In some cases the generic requirements of codes and standards are not appropriate, and so these should always be challenged in a site specific hazard analysis and risk assessment, leading to a design for the installation which includes consideration of building occupants and neighbours. In situations where the use of ammonia is difficult to implement, carbon dioxide can be employed to overcome certain restrictions, or indeed where it leads to improved system efficiency of a plant. These systems can give significant improvements in the energy efficiency of the installation in comparison with standard chiller arrangements. However the greatest energy savings are still made when air conditioning loads are minimised and chillers are not run unnecessarily.

---

## References

---

Pearson, A.B. "Low Charge Ammonia Plants – Why Bother?", International Institute of Ammonia Refrigeration, Albuquerque, 2003.

Pearson, A.B. "Assessment of Life Cycle Climate Performance for Chillers", International Institute of Refrigeration, Glasgow, 2004.

Tychsen, H. "Super-efficient low-charge ammonia chiller", International Institute of Refrigeration, Aarhus, 1996.

## Green Ice Cream Cabinets

### Unilever's Move from Hydrochlorofluorocarbons (HCFCs) to Hydrocarbons (HCs)

ALAN GERRARD, Unilever Ltd, UK



---

#### Unilever's ice cream business

---

Unilever owns the largest ice cream business in the world, familiar to many through brands like Magnum, Cornetto, Ben & Jerry's and Good Humor amongst others. A large proportion of our ice cream is sold through small outlets, where the ice cream is stored and displayed at  $-18^{\circ}\text{C}$  using an ice cream cabinet. Unilever owns about 2 million of these cabinets worldwide and replaces a significant number of the older and broken cabinets each year.

---

#### Ice cream cabinets

---

Ice cream cabinets use small hermetically sealed compressors with swept volumes of around 5 to 13 cc. Cooling capacities are typically between 170 and 520 W (measured under ASHRAE conditions at  $-23^{\circ}\text{C}$ ). The condenser and evaporators are simple pipes mounted on the outer and inner vertical surfaces of the cabinet. Often a simple tubular pre-condenser (desuperheater) is fitted in the compressor compartment. Small amounts of refrigerant are used with charges of around 200g per circuit for hydrofluorocarbons (HFCs) and around 100g for hydrocarbons (HCs). HFCs are the

most commonly used refrigerant for ice cream cabinets worldwide. The cabinet's principal environmental impact is its power usage throughout its life. However, any leak of refrigerant from the refrigeration circuit, may also add to its impact if the refrigerant has an Ozone Depleting or Global Warming Potential (ODP, GWP).



Figure 1: Typical ice cream cabinet used in small outlets

Leaks may occur from the circuit during operation and storage, predominantly from pin holes in soldered joints. The refrigerant escapes from these holes at a very slow flow rate and the cabinet may continue to run for many months before a reduced performance is noticed. Higher flow rate leaks may occur during servicing or disposal if incorrect procedures are used and there are some instances of damage occurring to the circuit during transport and moving within customers' premises.

Some 'blowing gases', used to produce the voids in the insulation foam, may also have significant ODP and GWP. As this gas escapes it will also contribute to the cabinet's environmental impact.

## Refrigerants in Unilever's ice cream cabinets

Unilever has actively supported changes to ice cream cabinets on environmental grounds over the last 15 years. Unilever recognised that it is not able to influence all parts of the cold chain, but its relative size in the market and large purchasing requirements for cabinets allow it to accelerate the pace of change when required, providing leadership for the rest of the industry.

In 1994, Unilever stopped buying cabinets with (H)CFC refrigerants (R11, R12, R22, R141), replacing them with zero ODP HFC refrigerants (R134, R404a). Also in 1994, Unilever began buying ice cream cabinets with cyclopentane as the blowing gas in the insulation. Cyclopentane has zero ODP and a comparatively low GWP of -11.

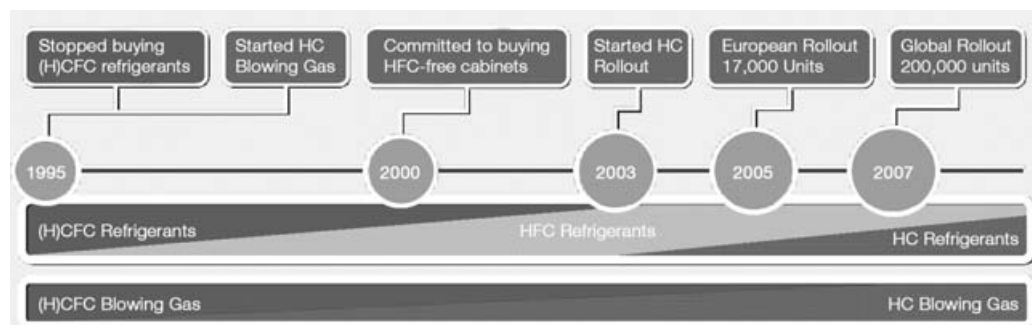

Figure 2: Schematic overview of refrigerant and blowing gas used in Unilever's Ice Cream Cabinets

In 2000, Unilever made a commitment to...

...implement by 2005 a non-HFC purchasing policy for ice cream freezer cabinets in all countries where commercially viable alternatives can be legally used.

**LESSON LEARNT:** Focus on one area with the highest impact and where there is the most leverage to ensure successful implementation.

## Alternatives to HFCs as refrigerants in ice cream cabinets

Prior to 2000, Unilever undertook a full study to ascertain what alternatives to HFCs were currently available or may be available in the near future. The only available HFC replacements at this point of time were hydrocarbons, already in use in the domestic refrigeration industry in the form of isobutane (R600a) but also available as propane (R290). Propane (R290) with its higher cooling capacity was the most appropriate choice of hydrocarbon to meet the high load demands of ice cream cabinets.

Small compressors using carbon dioxide (CO<sub>2</sub>) were also becoming available for trial in 2000. Unilever concluded that it was unlikely that CO<sub>2</sub> would be a fully developed alternative at competitive cost in the medium term (5 to 10 years) and that development of new equipment and suppliers would compromise the target for a 2005 implementation of an HFC-free buying policy. This has subsequently proved to be correct for ice cream cabinets. A similar conclusion was reached for Stirling cycle coolers. A more far reaching modification to the cabinet design would also be required.

Unilever's American based ice cream company, Ben & Jerry's, sponsored some research into thermoacoustic cooling at Penn State University, which resulted in a working model publicly demonstrated in a number of venues. Once again, cost and timing were not likely to meet Unilever's requirements. In short, by choosing to use propane, Unilever concluded that both the timing and cost elements of the project could be met with minimum disruption to our suppliers.

**LESSON LEARNT:** Get agreement on the targets to meet (cost, time, performance...) and be realistic when screening the potential solutions.

## Implementation

Following the decision to use propane as the replacement refrigerant for HFCs, a comprehensive programme of testing and approval were started. Unilever had already had some experience with HC refrigerants: in Denmark as part of a syndicate exploring technologies to increase the efficiency of ice cream freezers; and in India where some trials had taken place with a view to moving directly from (H)CFCs to HCs without going to HFCs (this trial subsequently stopped due to legislative difficulties in India rather than any technical difficulties). Important points in the testing and approval phase for HC refrigerants were:

- Establish an implementation team
- Simplify the range of equipment before implementing the changeover
- Assessment of safety, liability and legislative barriers

- Initial short term and long term testing in the field
- Maintaining close communication with suppliers over future plans
- Preparation of training material for service technicians
- Stakeholder engagement

## Establish an implementation team

Unilever appointed a single person with responsibility for the implementation of their commitment to move their cabinets out of HFC refrigerants. As a global business with many potential stakeholders internally and externally, a single point of contact simplified communications and provided a mechanism to follow the progress of the project. Core team members included experts in refrigeration, public affairs/communication, cabinet buying, safety, and cabinet management (maintenance and disposal). Key experts and internal and external stakeholders were also identified.

## Equipment range

Unilever benefited from a relatively small number of equipment models and suppliers and a global buying structure. Unilever was able to focus on just a few models whilst still being able to cover a large proportion of the cabinet fleet and most potential suppliers. This reduced the resource load and speeded up the implementation. Companies attempting similar changeovers with more complex equipment ranges and supplier relationships would find the implementation much more difficult.

**LESSON LEARNT:** Take the opportunity to reduce equipment models and suppliers to assist in managing the complexity of the changeover. Identify the key models and suppliers and focus on them to maximise the impact of the change.

## Safety and legislative barriers

Whilst propane has excellent thermodynamic properties, its flammability means that its use needs to be considered carefully. Safety and legislative issues need to be fully understood. The use of hydrocarbons has been widespread in the European domestic refrigeration market since the mid-nineties. Although domestic fridges and freezers are very similar in construction and materials used, freezers used in the commercial sector have a larger cooling load placed on them and are subjected to more severe usage patterns. So whilst the safety data available from the domestic industry is relevant, it could not be used to assess the risk of using HCs in commercial freezers.

For an accurate assessment of risk, cabinet and component failure data is a key requirement. Failure frequency may be specific to the source of the components, cabinet manufacturer and the severity of use whilst in the field. Unilever uses cabinets all over the world, so was able to take these potential variations into account. Frequency of refrigerant leaks (% cabinets/year) and the leak rate (mass/time) are particularly important data to be collected. In ice cream cabinets, leaks typically occur from 'pin-holes' at soldered joints between pipes. Very infrequently leaks occur from physical damage of the pipe work through mishandling during transport.

In Unilever's experience, leak frequencies are low. No data on leak rates were available for pin holes, probably because they are very low (grams per year). Models exist to calculate leak rates from physically damaged pipes.

Unilever undertook a Quantitative Risk Assessments (QRAs) using an independent body. The QRAs study usage scenarios (e.g. cabinet servicing, cabinet operation in a small shop, etc.), based on generic equipment types, using published failure data and consequence models. Calculated risks are specific only to that scenario.

A second assessment was undertaken using a computational fluid dynamics model which allowed risk assessments to be undertaken for more specific situations and usage patterns. Inputs to the model included amongst others: position and number of sources of ignition; ventilation rates; leakage data; size of room; and amount of refrigerant. Data from both studies confirmed that risk of ignition was very low. Of the scenarios looked at, servicing had the highest risk associated with it.

**LESSON LEARNT:** Failure data from a company's own records will allow a much more accurate risk assessment to be made. Generic data available in literature may not reflect the actual failure rates.

Fault	Type	% Cabinets
Correct Elect Fault in Cabinet	Electrical	0.58%
Replace Thermostat	Electrical	0.40%
Replace Cabinet Cable	Electrical	0.23%
Replace Condenser Fan Motor	Electrical	0.17%
Replace Incorrect Fuse in Plug	Electrical	0.12%
Replace Timer	Electrical	0.06%
Sum		1.56%
Repair Leak & Add Gas	Refrigerant	0.58%
Recharge Gas Using Scales	Refrigerant	0.35%
Internal Leak	Refrigerant	0.29%
Sum		1.21%
Repair Water Leak	Mechanical	0.40%
Warranty Change Out	Mechanical	0.35%
Repair/ Cure Noise Problem	Mechanical	0.23%
Replace Lids	Mechanical	0.23%
Fit Parts	Mechanical	0.17%
Repair Lids	Mechanical	0.17%
Repair Trims	Mechanical	0.12%
Repair Door	Mechanical	0.12%
Repair Trims	Mechanical	0.12%
Repair Insulation	Mechanical	0.06%
Sum		1.96%
Attended Parts Needed	Other	0.23%
Attended Further Att Req'd	Other	0.17%
Wrong Part Sent	Other	0.12%
Site / Equipment Report	Other	0.06%
Sum		0.58%
Replace Compr/Elect/Door/Gas	Components	0.12%
Fit Filter Drier	Components	0.12%
Sum		0.23%

Table 1: Typical failure data for one country over one year

## Functional specifications

The risk assessment work also identified those parts of the cabinet that contributed most to the overall risk associated with the use of HC cabinets. Incorporating this knowledge with the more obvious risk mitigation actions, like using spark proof components, Unilever issued its suppliers with functional specifications highlighting areas that suppliers should consider when designing and manufacturing HC cabinets. These were used as a template for subsequent audit work on initial trial samples. In particular suppliers were expected to ensure that:

- Any potential ignition sources in the equipment had been identified and eliminated at the design stage
- The design and manufacture minimised the possibility of leaks occurring (e.g. minimal joints, attention to corrosion issues)
- Any gas that does leak should be able to dissipate wherever possible
- The cabinets and refrigeration components are clearly labelled for use with propane

## Initial testing

Initial testing of ice cream cabinets took place during the Sydney Olympics in 2000. As Unilever's ice cream business in Australia was a sponsor of the Sydney Olympics, Unilever was challenged by Greenpeace to help make those Olympics the 'Green Olympics'. Fifty cabinets were specially manufactured to run HC refrigerants and placed on the Olympic site for the five weeks of the Olympics and Paralympics. Cabinets



were placed in a variety of positions inside the venues. All cabinets experienced usage patterns much higher than typical. During this trial, the HC cabinets and a representative sample of HFC cabinets were fitted with temperature recorders outside and inside the cabinet (measuring the ambient and storage temperature). The cabinets were also fitted with power meters. This data confirmed that the HC cabinets would be able to maintain the correct temperatures even under severe conditions of use.

Figure 3: HC cabinet in use at the Sydney Olympics

Following the success of the Olympic trial the HC and HFC cabinets, still fitted with the monitoring equipment, were placed on the market in either Sydney or Brisbane for a further year. Engineers from the Danish Technological Institute (DTI) assessed this data from the trial. The DTI presented their findings at the IIR Gustav Lorentzen conference in Beijing, in 2002. In summary, comparing the HC cabinets to their HFC counterparts over the year on the market, the HC cabinets had:

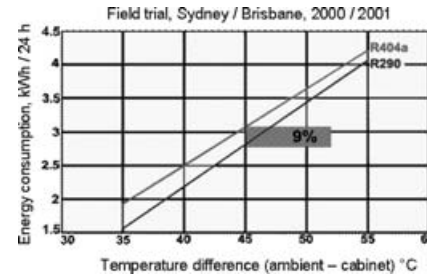

- Used ~ 9% less energy under comparable conditions (difference between ambient and storage temperatures)
- No additional maintenance or breakdown
- Maintained the ice cream at the correct temperature

Figure 4: Graph of energy consumption versus temperature difference between ambient and storage temperatures inside HFC and HC cabinets placed in the field in either Sydney or Melbourne

**LESSON LEARNT:** A well designed trial, independently run and assessed, gives confidence in the data and will assist in 'selling in' the technology change both internally and externally.

## Supplier interaction

Unilever began discussions with its main suppliers before 2000. By ensuring that our suppliers were kept informed, they had sufficient time to consider the implications of any technological change in terms of investment in manufacturing equipment and cabinet design changes. Time was also spent discussing the reasons for the change (in 2000, climate change was not as news worthy as it is now) building commitment for the change on an emotional as well as financial level. Early communication also helped to identify potential pitfalls and barriers. Clear deadlines and unequivocal messages of intention to implement the HFC-free policy ensured that suppliers took the appropriate actions.

**LESSON LEARNT:** Early interaction with suppliers to explain what is required and why it helps to reduce the barriers to change and the time to make those changes. Global buying policies are agreed, communicated and acted on in a timely manner.

## Training

During the initial stages of the project it was clear that servicing of the cabinets was an area where training would be required. Training would ensure safe servicing and repair of the HC cabinets. Some countries already had a pool of trained technicians available, but in many countries suitable training courses were not available. Unilever commissioned a training package for refrigeration technicians specifically for ice cream cabinets. This training package consisted of a detailed presentation, A4 and pocket sized reminder sheets and a post training test sheet. The presentation included detailed notes so that experienced refrigeration technicians could deliver the material if necessary. The presentation highlights to technicians why the change to HCs was being made, the safety hazards and the specific areas where extra care was required. The training package was professionally illustrated, keeping words to a minimum, facilitating its translation into German, Spanish and French.

### Cylinder Storage

Outside - follow local regulations for LPG, if none at least:

- ☉ In a locked cage
- ☉ At ground level
- ☉ Away from air intakes to building
- ☉ Remote from ignition sources
- ☉ No smoking



Figure 5: Example of information in Training Presentation. Figure 6: Pocket sized reminder for technicians after completion of training

**LESSON LEARNT:** Servicing was identified as the highest risk in the QRA. Ensure technicians are properly trained by providing excellent training material.

## Internal communication



Figure 7: Internal magazine article on HC rollout

The change to HC refrigerants potentially touched many functions within Unilever: Sales; Cabinet Management; Safety, Health and Environment; Marketing; and Public Affairs. Cabinet managers were a key group and regional meetings were used so that these groups could share their experiences before and after the rollout. Familiarity with the impact that the roll out would have in the field allowed a roll out package to be prepared to support the local 'champions'. Rapid follow up on any issues raised ensured that any negative issues were not allowed to slow down the rollout. General information was shared with the Unilever's Ice Cream community with articles in internal publications to raise awareness of the project. Key countries were identified in each region and one to one meetings were used with the affected functions allow more detailed discussion to take place.

**LESSON LEARNT:** Targeted internal communications reduced the barriers to implementation of the HC cabinets by ensuring internal stakeholders were informed at an appropriate level of detail. Ensure mechanisms exist for identifying and solving any problems as early as possible.

## External communication



Figure 8: Presentation in Athens on the rollout of HC cabinets in Greece

During initial testing and rollout of the HC cabinets Unilever continued to engage with its suppliers and other external stakeholders. Where appropriate, country based PR launches were used to inform the outside world about Unilever's activity. A wide range of stakeholders were invited, typically: industry groups; the media; and policy makers. The events lasted a couple of hours and followed a consistent pattern:

- Academic presentation to explain the background to climate change
- Company presentation to give specific details of the local rollout of HC cabinets
- Presentation by Greenpeace to highlight their environmental concerns with HFC refrigerants and support the work done by Unilever

- Overview of Unilever global commitment to replacing HFC cabinets
- In addition to the local events, opportunities to spread the message were taken by speaking at conferences, contributing to articles and speaking with the media.

**LESSON LEARNT:** A local PR event builds commitment in the local team and ensures sufficient resource is available to push the roll out through.

## Joint initiatives

Unilever has been involved in a joint initiative with several companies equally committed to eliminating HFC refrigerants from their point of sale equipment (e.g. freezers, chillers, HVAC systems). Carlsberg, The Coca-Cola Company, IKEA, McDonald's, PepsiCo and Unilever, supported by Greenpeace and UNEP have formed an initiative called Refrigerants, Naturally! (<http://www.refrigerantsnaturally.com>).

Refrigerants, Naturally! provides ...

- a working group and supportive environment where information is shared to encourage and spread excellence for those committed to eliminating HFCs in point-of-sale refrigeration.
- a platform and a critical mass in communicating with the refrigeration technology supply chain, with other users, governmental, political and public institutions about the feasibility and environmental gain of non-HFC-cooling.



Refrigerants, Naturally! members are committed to ...

- the elimination of HFCs in point-of-sale cooling applications
- developing a timetable for doing so
- making a substantial resource commitment to achieve fluorocarbon elimination, including R&D, testing, financial investment, staff time or political energy
- sharing information between members, sharing data and results with other companies, government decision makers and the public

The initiative were awarded the United States Environmental Protection Agency's Climate Protection Award 2005 in recognition for their leadership in developing innovative ways to combat global warming by promoting the development of environmentally friendly refrigeration technology. Refrigerants, Naturally! is recognised as a "Partnership for Sustainable Development" by the UN Commission on Sustainable Development.

Refrigerants, Naturally! staged a major event in Brussels in 2004. The event brought together suppliers, policy makers, media and our peer group to listen to key note speakers from the EU, UNEP, Greenpeace and show cased the technical developments of the companies at that point of time.



Figure 8: Guest and company key note speakers at the 2004 Refrigerants, Naturally! event

**LESSON LEARNT:** Industry alliances create extra leverage to accelerate the pace of change. Managing the expectation of external parties is important. By engaging with these groups, explaining business models, highlighting potential problem areas, this expectation can be managed.

## Concluding remarks

Unilever has been successful in implementing the change from HCFC to HFC to HC refrigeration. Close co-operation between all parties in the supply chain has enabled Unilever to meet its targets in terms of timescales and economic viability. Any cost changes have been sufficiently small to be absorbed without affecting the business model.

Unilever has built up considerable expertise since their change programme started in 2000 and has been prepared to share this data through Refrigerants, Naturally! activities. Service technician training material as been shared with third party suppliers and companies in our peer group.

Unilever is proud to be leading this change in the ice cream business. Unilever's leadership in this area has had a positive impact on employees; most directly on those involved in the project but also on those that have heard about it through internal communications.



# Application of Hydrocarbon Refrigerants in Existing Large Systems

DR. LADAS TAYLOR, Energy Resources Group, Australia  
JACKSON ONG, Nat-Energy Resources, Singapore

---

## Barriers to hydrocarbons

---

The Energy Resources Group (ERG) and one of their key agents previously identified the potential for natural refrigerants, and in particular hydrocarbons. In the beginning, a number of major problems were identified, which are described below:

- **Product distribution.** The issues were getting the product to where it was needed, having investment in stock and quality, and developing regular supply lines.
- **Availability.** Linked to the distribution problem – but more localised to where it affects the field technician – was the argument that local stockists often ran out of stock or would not stock the product based on unfounded fears caused by the propaganda of fluorocarbon refrigerant suppliers/manufacturers. There was also the threat of exclusion of supplies by the same fluorocarbon refrigerant suppliers/manufacturers.
- **Quality.** Another main issue, like any refrigerant is the guarantee of quality. There are many refrigerants in the market that are of questionable quality, and hydrocarbon refrigerants are not exempt from this. It is not just impurities like sulphur, oxides, moisture, etc., but also the correct blending of the hydrocarbon refrigerant components, such as achieving the necessary proportions of R-290, R-600a, and others. Base stocks of hydrocarbons usually contain high levels of n-butane, iso-butane, propylene, ethane, pentane, and other hydrocarbons which can alter the pressure/temperature relationship, as well as other properties. This makes it difficult for original equipment manufacturers (OEM's) and service personnel to balance the system properly. Therefore the use of high quality – highly refined base products is critical in the blending process.
- **Training.** While the use of HC refrigerants is very similar to other types of refrigerants, there are a couple of additional items that the technicians need to be aware of. To a degree, it is not additional training but more of a reminder of the correct way of doing things that was taught when they were learning their trade skills. ERG edu-

cates technicians about the “bad habits” and shortcuts that they may have picked up over the years. The training ensures when converting to hydrocarbon refrigerants, the high quality practices be reflected in achieving the best results for the environment and energy saving. In the refrigeration industry many technicians have adopted improper procedures particularly in handling hydrocarbon refrigerants. The technician needs to fully understand the characteristics of hydrocarbons so that they do not cut corners or carry out sub-standard procedures; instead they must follow ERG conversion methodologies which comply to international standards.

- **Fluorocarbon industry lobbying.** This topic is a complex one. Most manufacturers of chemical refrigerants are huge conglomerates with very deep pockets, and they can therefore afford to employ PR and marketing staff, which dwarfs the resources of the HC refrigerant industry, which therefore suffers from limited access to marketing and PR.

With their partners, ERG successfully addressed nearly all of the above issues (with the exception of the last item). This last problem is one that will take much longer to resolve.

### Conversion to hydrocarbon refrigerants

Over the past eight years, the ERG in association with key partners in Asia, especially Nat-Energy Resources of Singapore, have developed a programme to offer companies the opportunity to reduce or eliminate their reliance on ozone depleting or high-GWP synthetic refrigerants. Such conversions generally adhere to the same following procedure:

- Introduction of concept
- Equipment diagnosis survey and report
- Safety audit
- Pre-retrofit repairs and servicing
- Pre-retrofit system and energy consumption monitoring
- Fitting of safety devices
- System conversion
- Post retrofit system and energy consumption monitoring
- Conversion report
- Regular service and maintenance – unless client opts for in-house personnel to be trained

The sequence of events is detailed within the flow chart in Figure 1.

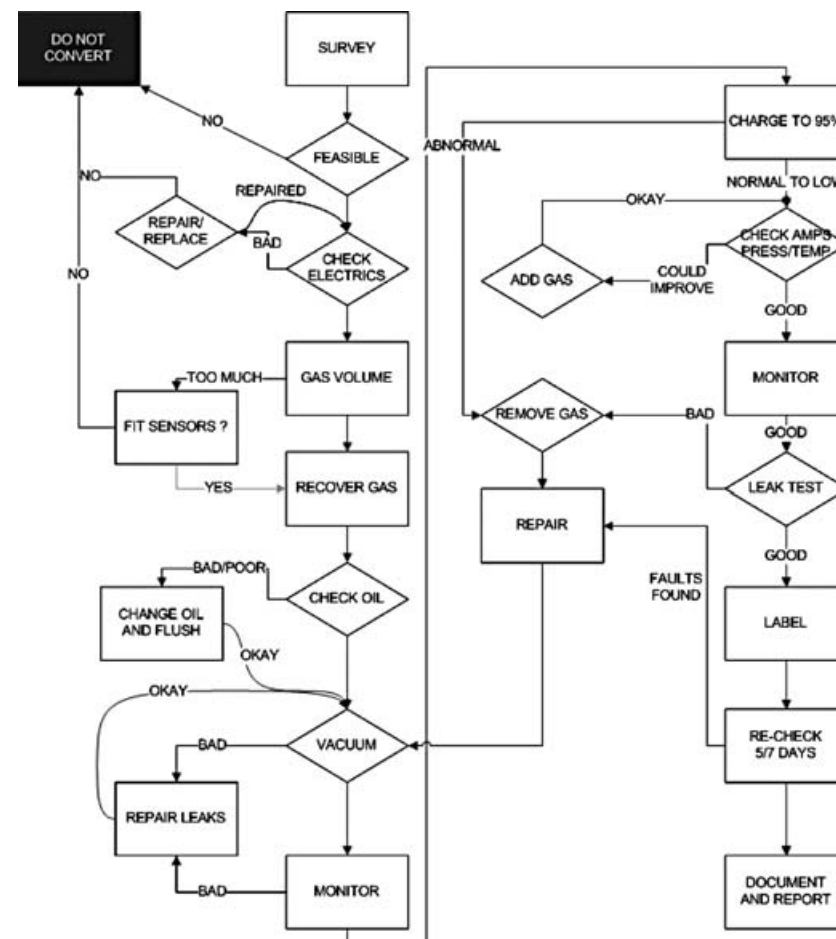

Figure 1: Hydrocarbon conversion flow chart

Most projects are sourced through introductions from previous customers, partners, associates, or website enquiries from organisations looking for environmentally-sustainable technologies, for example, in line with ISO 14001 certification requirements, or from energy savings technology providers looking for partnerships. Nevertheless, there has, and always will be some projects, sites or chillers that are not suitable for conversion to hydrocarbon refrigerants. This could be due to reasons like location, serviceability etc., and this is the reason why a full site survey and safety audit must be carried out.

A list of the projects completed to date is included in Appendix 1. An example in the form of a case study is provided next to illustrate the activities carried out.

## Case study of a conversion of large chillers in Singapore

This project was located at the Far East Square in Singapore, and the client was China Classic Pte Ltd (a subsidiary of Far East Organisation). Nat-Energy Resources – Singapore managed the project during April 2005. The equipment that was converted was five York air-cooled chillers, model: YDAJ98MU7-50PA, with a nominal capacity of 700 kW for each of the five equally sized units. Figures 2 and 3 are photographs of the chillers involved.



Figures 2 and 3: Far East Square Shopping Complex, Roof Top, Chiller No 3, York Air-Cooled System Model: YDAJ98MU7-50PA

The following stages were carried out:

- **Equipment survey and report:** A standard inspection on the system was carried out and reports were submitted to client. In case of leaks or defects, appropriate action should be taken. (Attached report given to client)
- **Safety Audit:** As these chillers were on the open rooftop, leak detectors were not required. An officer from Singapore Civil Defence Force (SCDF) inspected the site after conversion and gave an official approval, which was submitted to the National Environment Agency's (NEA). We carried out a safety survey to ensure that there is adequate ventilation, no exposed electrical or fire source nearby, no smoking signs, proper control of access by public. Seal all electrical components and panel. Please refer to attached Pre-conversion Safety Audit report for detail.
- **Pre retrofit repairs and servicing:** Leaks were detected and repaired before the conversion. Monthly routine checks are carried out. Only normal servicing is required.
- **Pre retrofit system and energy consumption monitoring:** Install kWh and run-hour meter to capture and determine pre- and post-HC conversions data, according to:

- Monitoring devices installation Date: 19th February 2005
- Pre-conversion monitoring period: 19th February 2005 – 8th March 2005
- Baseline kW per hour consumption: 193.82 kW per hour (2 compressors)
- Cooling performance: LCWT = 7.7 °C, ECWT = 10.1 °C

- **Fitting of safety devices:** Gas leak sensors are only required when concentration of air for HC in an enclosed area falls into the flammability window between 1.9% and 10%. Obviously detection devices can be fitted to any system. These sensors will be connected to the ventilation fans and/or an alarm that will be triggered once a leak is detected. Further interfaces like solenoid valves etc., can also be integrated into an alarm system. In such a case, clear warning labels such as, "Chiller Refrigerant is Flammable" and "No Smoking" signs should be prominently displayed.

In addition, a safety talk should be given to engineers and contractors in charge of the chillers. In the case of Far East Square, it was not necessary to install leak sensors.

The procedures for converting the system were according to the following:

- **Recover existing refrigerant:** Existing refrigerant in the system was recovered and stored in dedicated recovery cylinders. Amount of refrigerant was weighed to ascertain current refrigerant charge.
- **Replace spare parts where necessary:** Pre-conversion servicing was carried out i.e. filters, driers or valve cores were replaced where necessary. Leaks were repaired; oil quantity and quality were checked and replaced if necessary. The system was flushed with nitrogen in order to ensure the removal of any residue substance.
- **Vacuum/leak test system:** The system was vacuumed overnight. After this was completed, a tight vacuum was held for 30 minutes to test for leakages on the system.
- **Charging of hydrocarbon refrigerant:** The original gas charge/weight was determined by documents or nameplates provided by the manufacturer or from the quantity of recovered gas. With this knowledge of the original charge, divide the number by three, and then take 90% of the resulting number. For example, if the original R22 charge was 10 kg, the calculation would be  $10 \text{ kg} \div 3 = 3.3 \text{ kg} \times 0.90 \text{ (90\%)} = 2.97 \text{ kg}$ . Charge initially through the high-side/discharge service valve with the unit at OFF condition of 2.97 kg, run the unit for 30 minutes and allow compressors to settle, and turn off unit for 10 minutes.
- **Fine tuning to optimise performance:** Re-start unit for 10 minutes. The pressure should drop by 1-2 PSI because of refrigerant absorption by oil. Then very slowly add 5 to 10 g each time (not more than 5 PSI at a time), allowing the unit to settle until we can get the best cooling result for the lowest amp reading. By doing this slowly, we have eliminate the chances of over-charging the unit. Allow the system to

run for another 15 to 20 minutes to ensure that we have reached optimal performance.

- **Check for leaks:** The system was tested for leaks using soap and water.
- **Fill up label and monitor:** The Nat Energy information label was filled up and displayed in a prominent position on the unit. The unit was monitored over the next few days.
- **Post retrofit system and energy consumption monitoring:** kWh and run-hour meters were installed to monitor the monthly energy consumption. These readings were recorded monthly for billing purposes. For example:
  - HC Conversion date: 28<sup>th</sup> March 2005 – 30<sup>th</sup> March 2005
  - Post-Conversion Monitoring Period: 1<sup>st</sup> April 2005 – 11<sup>th</sup> April 2006
  - kW per hour consumption: 162.64 kW per hour (2 compressor)
  - Cooling Performance: LCWT = 6.4°C, ECWT = 11.2°C
  - Savings Achieved: 31.18 kW per hour or 16.10%

Figures 4 and 5: Monitoring Device Installed – kW-hr Meter & Run-hr Meter, York Air-Cooled System Model: YDAJ98MU7-50PA

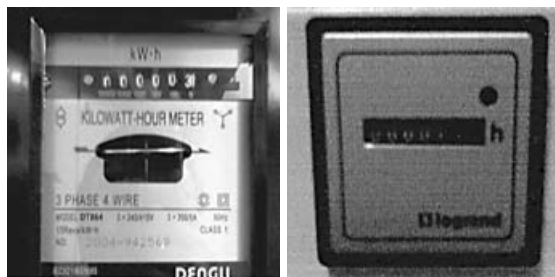

A conversion report of the type shown in Appendix 2 is provided to the client upon completion, which illustrates the performance pre- and post-HC conversion. After conversion, these 8 year-old chillers saw an achievement of 16.1% savings in energy consumption, as well as a drop of 12.2% in total current (amps) consumed. Cooling efficiency improved by 16.88%. Further to the completion of the project, no additional cost or special maintenance was required; only standard monthly servicing, maintenance and annual shutdown. Some photographs of the power meters are provided in Figures 4 and 5.

## Final remarks

There is nothing new or unique about converting larger chillers and cooling system to hydrocarbon refrigerants. However, it is of utmost importance to ensure that the correct procedures are followed, that the technicians are trained correctly and the right safety devices are in place. Provided these requirements are carried out, a HC charged chiller will offer a lifetime of service with reduced power consumption and more efficient cooling. After conversion the units draw less current, generally cool faster and operate on lower head pressures.

Lastly, as an addition to the provision of hydrocarbon refrigerants for retrofitting systems, the production facilities in Singapore also includes a state of the art CFC, HCFC, HFC and halon destruction system (Figure 6), so prevention of emissions of ODS and high-GWP gases can be guaranteed.



Figure 6: CFC, HCFC, HFC and halon destruction system

---

## Appendix 1:

---

### Project examples of conversions to hydrocarbon refrigerants carried out successfully by ERG and their associate companies across Asia

#### 1. Singapore

- Far East Square Shopping Mall using York 200TR Water-cooled Recip Chiller recorded 16% savings.
- Defence Science & Technology Agency using Carrier 1hp Air-cooled split unit recorded 16% savings.
- Dapenso Building using Carrier 21TR Water-cooled Packaged Unit recorded 32% savings.
- Watson's Stores using Daikin Air-cooled Split Unit recorded 24% savings.
- The Moomba Restaurant, Boat Quay using McQuay 8hp Air-cooled split unit recorded 16% savings.

#### 2. Malaysia

- 7-eleven Stores Kuala Lumpur, Topaire Air-cooled Split Unit recorded 24% savings.
- Flairis Kota Tinggi, Water-cooled Packaged Unit recorded 19% savings.
- Nichicon Bangi, Topaire Water-cooled Packaged Unit recorded 20% savings.
- Sumiden Electronics Shah Alam, Topaire Air-cooled Split Unit recorded 22% savings.
- Hosiden Electronics Bangi, Air-cooled Split Unit recorded 25% savings
- Alps Electric Nilai, Dunham-Bush Water-cooled Packaged Unit recorded 17% savings
- Panasonic AVC Network Shah Alam, Air-cooled Split Unit recorded 19% savings
- Venture Tebrau I Johor, Dunham-Bush 65TR Water-cooled Packaged recorded 47% savings.
- Panasonic Communication Senai Johor, National 20hp Water-cooled Packaged recorded 20% savings.
- Celestica Electronics Tampoi Johor, Topaires 3 x 80TR Water-cooled Packaged recorded 24% savings.
- Menara Ansar Johor, Carrier 23TR Water-cooled Packaged recorded 13% savings.
- Bangunan PharmaCARE KL, Topaires 26TR Air-cooled Packaged recorded 23% savings.
- Sumitomo Electronics Tebrau II Johor, York 32TR Water-cooled Packaged recorded 21% savings.
- Taiko Electronics Senai Johor, York 21TR Water-cooled Packaged recorded 20% savings.

- GG Circuits Industries Tampoi Johor, Carrier 35TR Water-cooled Packaged recorded 14% savings.
- YKJ Industries Kulai Johor, Acson 4TR Air-cooled Split Unit recorded 27% savings.
- Tru-Tech Electronics Ulu Tiram Johor, York 20TR Air-cooled Packaged recorded 19% Savings.
- Matsushita Electric Company Shah Alam, Carrier 35TR Water-cooled Packaged recorded 15% savings.
- Menara AmFinance KL, York 21TR Water-cooled Packaged recorded 16% savings.
- Li Tat Mfg Masai Johor, York 17TR Air-cooled Ducted Type Split Unit recorded 29% savings.
- OYL HQ (R&D Lab) where new 3TR split units recorded 27% savings.
- UiTM Shah Alam Campus using Hitachi screw chiller recorded 19.7% savings.
- Damansara Realty using Carrier 10TR Packaged units recorded 32% savings.
- Pantai Medical Centre Bangsar, York 80TR Heat Recovery Unit recorded 24% savings.
- Pantai Medical Centre Bangsar, York Air-cooled Chiller Packaged recorded 18% savings.
- Lam Wah Ee Hospital Penag, Carrier Water-cooled Packaged recorded 20% savings.
- Elecan Semiconductor Penang, Air-cooled Packaged recorded 14.8 % savings.
- Comfort Engineering Puchong, Carrier Air-cooled Packaged recorded 18.5% savings.
- Cepak Rea Johor, National Air-cooled Split Unit recorded 16.7% savings

#### 3. Thailand

- Carrier HQ Building using Carrier 150TR recip chiller recorded 14% savings.
- Two 7-11 stores using split unit and walk-in-freezer recorded 20% savings.

#### 4. Indonesia - Jakarta

- Alfamart 649 stores in Jakarta using air-cooled split units recorded 25% savings.
- ITC Mangga Dua using 208 tr Carrier recip chillers recorded 34.7% savings.
- JW Marriott Hotel using 132 tr York recip chillers recorded 25% savings.
- Supermal Karawaci using 60 tr Hitachi screw AHU recorded 30% savings.
- Mulia Hotel using Copematic 5 tr semi-hermetic comp recorded 13.3% savings.
- Sol Elite Marabella Hotel using 1.5 tr Sanyo split unit recorded 24.4% savings.
- Maspion Plaza using 150 tr York recip chiller recorded 15% savings.
- Kondominium Simpruk Teras using 10 tr Fair pckg unit recorded 22% savings.
- Mal Kelapa Gading using 200 tr Carrier recip chillers recorded 28% savings.
- Darmawangsa Square using 2 tr General split unit recorded 24% savings.
- Siloam Gleneagles Hospital using 1 tr Mitsubishi split unit recorded 45% savings.
- Yayasan Pendidikan Permai using 1 tr Gree split unit recorded 22% savings.

## 5. Indonesia - Bali

- Maya Ubud Resort & Spa recorded 41% savings.
- Sahid Jaya Hotel recorded 51% savings.
- Ritz Carlton Hotel recorded 28% savings.
- Kartika Plaza Beach Hotel recorded 55% savings

## 6. Indonesia - Lombok

- Sahid Jaya Hotel recorded 72% savings.
- Oberoi Hotel recorded 18% savings.
- Novotel Hotel recorded 39% savings.
- Lombok Raya Hotel recorded 27% savings.
- Sheraton Senggigi Hotel recorded 53% savings.
- Senggigi Beach Hotel recorded 36% savings.
- Jayakarta Hotel recorded 25% savings.
- Intan Lombok Hotel recorded 21% savings.
- Holiday Inn Hotel recorded 20% savings

## 7. Philippines

- Gaisano Country Mall - 50tr Hitachi Screw Type Compressor - 16%
- Park Square One (Ayala Mall) - 7.5tr Frascold Semi - Hermetic Reciprocating Compressor - 12%
- Delsa Chemicals Office - 5tr Maneurop Hermetic Reciprocating Compressor - 14%
- McDonalds Restaurant - 7.5tr Maneurop Scroll Type Compressor - 12%
- Legenda Hotel - 2tr Matsushita Rotary Type Compressor - 19%
- Federal Express (Fedex) - 7tr Copeland Hermetic Reciprocating Compressor - 21%
- Iglesia ni Cristo Church - 3tr Copeland Scroll Type Compressor - 15%
- INARP Research Inc. - 2tr Matsushita Rotary Compressor - 12%
- Building Care Corporation - 5tr Copeland Hermetic Reciprocating Compressor - 20%
- Mandarin Restaurant - 40tr Century Screw Type Compressor - 17%

---

## Appendix 2:

---

### Example of conversion report

Customer Name :	Far East Square Shopping Complex
Address :	43 Pekin Street, Singapore 048773
<b>Air Conditioning System Data</b>	
Pre-conversion Meter Installation Date :	19 <sup>th</sup> February 2005
Baseline Monitoring Period :	19 <sup>th</sup> February 2005 - 8 <sup>th</sup> March 2005
Conversion Date :	28 <sup>th</sup> March 2005
Post-conversion Monitoring Period :	1 <sup>st</sup> April 2005 - 11 <sup>th</sup> April 2005
Location :	Roof Top, Air-Cooled Chiller Unit No: 3
Brand :	York
Model :	YDAJ98MU7-50PA
Type :	Air-Cooled Chiller Unit
Capacity :	2,400,000 BTU/HR
Existing Refrigerant :	R22
Nat Energy Hydrocarbon Product :	MINUS 50

<i>Data Recording</i>						
Description	Parameter Before		Parameter After		% Saving	
Start date of data recording	19th February 2005		1st April 2005			
End date of data recording	8th March 2005		11th April 2005			
Entering chilled water temp (ECWT) °C	10.1		11.2			
Leaving chilled water temp (LCWT) °C	7.7		6.4			
Water temperature difference (ΔT) K	<b>2.4</b>		<b>4.8</b>			
Average current, comp 1 (amp)	202.2		178.8			
Average current, comp 2 (amp)	167.1		145.6			
Total current (Amp)	<b>369.3</b>		<b>324.4</b>			<b>12.2%</b>
Low / high pressure, comp 1 (Psi)	59	251	52	221		
Low / high pressure, comp 2 (Psi)	65	237	53	208		
Starting kW-hr meter reading (Comp 1 and 2)	343,230		479,260			
Ending kW-hr meter reading (Comp 1 and 2)	397,900		499,920			
Total kW-hr consumed	<b>54,670</b>		<b>20,660</b>			
Starting running-Hr meter reading (Comp 1/2)	2,439.48	2,439.39	3,153.76	3,121.18		
Ending running-Hr meter reading (Comp 1/ 2)	2,726.83	2,716.15	3,281.08	3,247.92		
Average running hour	<b>282.06</b>		<b>127.03</b>			
Average power (kW per hour )	<b>193.83</b>		<b>162.64</b>		<b>16.1%</b>	

## Developing a Product Range for Climate- and Ozone-Friendly Technologies

NICK COX, Earthcare Products Ltd, UK

### Introduction

With the growing attention on environmental concerns, and particularly the issues of ozone depleting and global warming substances associated with refrigeration and air conditioning equipment, the company Earthcare Products was set up to respond to the subsequent changes in the market.

Founded in October 1997, Earthcare provides advice, products and services that are progressive in terms of energy efficiency, sustainability and low environmental impact. The services and products are aimed at end-users who are investing in systems that must anticipate evolving building regulations (such as the European Energy Performance of Buildings Directive, EPBD), companies whose properties need to score highly with green-building ratings (such as the BRE Environmental Assessment Method, BREEAM; <http://www.breeam.org/>), or for companies with prescriptive environmental CSR requirements.

This article provides an insight into the types of systems and applications where Earthcare has successfully implemented the use of both natural refrigerants and improved energy efficiency.

### Project examples

The following illustrates a number of products developed by the Company that employ only natural refrigerants instead of HCFC and HFCs.

#### Very Environmentally Friendly (VEF) heat pump air conditioning split systems

In 1998, using grant funding from the UK Government's Department of the Environment, Transport and the Regions (DETR) a new range of VEF heat pump air conditioning split systems was developed and launched.

The products resulted from research investigating improvements to the energy efficiency of small split air conditioning systems. The exercise formed part of a wider ranging project – part funded by the DETR’s “Partners in Technology” scheme – to look at energy saving opportunities at the time of refrigerant replacement. The resulting VEF split systems were launched at the IKK Exhibition in Nuremberg in 1998. These systems minimise environmental impact by offering the combination of natural refrigerants and optimised efficiency. The result is an efficiency gain of 20% over the original HCFC-22 systems. Hence both the direct and indirect aspects of global warming impact were addressed. The units have been re-engineered to optimise their performance with hydrocarbon refrigerants – thereby eliminating the powerfully global warming HFC and HCFC alternatives – whilst the use of motor voltage controllers has further brought indirect emissions down with reduced energy consumption.

Direct global warming impact was minimised in several ways:

- Minimised the amount of refrigerant held within the units;
- Traditional flared copper joints that are responsible for a high percentage of refrigerant leaks were eliminated from the systems. Copper capillary lines (small pipes for instrumentation and sensors that are particularly prone to cracking) were also eliminated;
- Charged the system with the hydrocarbon CARE 40 (R-290), a refrigerant with a Global Warming Potential (or GWP) of <3, a fraction of the GWP of the competing hydrofluorocarbons (HFCs)

Indirect global warming was also minimised by maximising energy efficiency:

- The thermodynamic properties of hydrocarbon refrigerants are well suited to this type of application, competing favourably on efficiency with all other alternatives;
- The refrigerant charge was optimised in laboratory trials and the installation process achieves precise repetition of optimum charge for each unit;
- The indoor unit (evaporator) was optimised using enhanced heat exchangers where necessary;
- Floating head pressure control was used, this allows the condensing temperature to float as low as 20°C if ambient conditions allow, instead of being held artificially at around 40°C. This can achieve up to a 30% increase in efficiency compared to fixed head pressure;
- The systems use fully flooded evaporators. This increases both the cooling capacity and efficiency.

These were all comparatively small changes which, when combined, make a big difference. In re-designing the split system from bottom up, it was possible to maximise the advantage that could be gained by matching sensible heat ratio to local environmental conditions. Most split system manufacturers optimise for comfort conditions based on a worldwide average climate model. For most sites that were surveyed, the majority

of the cooling requirement is for equipment or process cooling, predominantly with sensible heat loads. However, the cooling coils used are generally unsuitable for these conditions. By way of example, one can compare the sensible heat ratios for commonly used Mitsubishi models against the equivalent model developed within the project. A 4.9 kW PLH2 Mitsubishi Electric split system has a sensible heat ratio of 0.76, compared with 0.93 for a similar Earthcare model, based on Mitsubishi’s “UK cooling” conditions of 23°C dry-bulb and 16°C wet-bulb indoor, and 30°C dry-bulb outdoor. Therefore, by simple optimisation of the indoor coil to suit the specific climate of operation, it is possible to achieve an average 6% improvement in sensible heat ratio, which in turn becomes a 6% improvement in energy efficiency. This kind of engineering is also needed to optimise equipment in hot climates although a slightly different approach would be needed according to local climatic conditions.

### **The UK’s largest air conditioning thermal storage system, using ammonia and slurry-ice**

At Middlesex University an air conditioning system has been installed, incorporating slurry ice thermal storage in a similar fashion to domestic storage heaters. It builds ice over night, which can then be pumped around the premises during the day. The installation has a capacity of 72 cubic metres, which makes it the largest slurry ice system in the UK. Additionally, it is Very Environmentally Friendly, using energy efficient ammonia natural refrigerant. The installation is used to provide cooling for the whole of the university site at Bounds Green, North London. This provides them with annual running cost savings of almost 50% relative to conventional installations for the same application.

Middlesex University follows a strong environmental policy with other initiatives such as adiabatic cooling air handling units being implemented. However, this was their biggest investment in a single green application. The Environmental and Services Engineer explained that it made business sense. “The energy savings which we make as a result of installing this plant makes sense financially. The initial financial outlay was competitive with other installations, so contrary to popular belief, it actually pays to be green. I had been looking at how we could replace our old system which used CFCs and decided to install the Slurry Ice Thermal Storage System. When I looked at the capital outlay and the reduced running costs, it seemed to be perfect for us.”

### **Range of ground source heat pumps**

The company developed a range of ground-source heat pumps (GSHP) that employs the hydrocarbon refrigerant R-290 and optimal ground heat exchanger geometry. One example is the GSHP project at Buntingsdale Infant School near Market Drayton, North Shropshire in the UK, installed with the help of a Carbon Trust Grant by the Shropshire County Council Energy Conservation and Sustainable Construction Unit.



The heat pump system replaces electric night storage heaters, which were noisy, bulky and very difficult to control in terms of heat output, particularly during the spring and autumn. This innovative scheme used a GSHP, which draws heat from the soil in a nearby field to heat the school. The system removes heat from the soil and delivers it to the school in an upgraded form. A glycol solution is pumped around an underground loop of plastic pipe work to extract heat from the ground. This heat is then upgraded to a useful temperature by the heat pump unit before being distributed around the building to fan coil units.

Local geological conditions meant that installing the underground pipework in boreholes was not cost effective, so fifteen 50 m long trenches, 1.3 m deep by 1.5 m wide were dug in a farmer's field adjacent to the school. The pipework was arranged into 'slinky coils' 1.2 m in diameter and laid horizontally at the bottom of the trenches.

The project uses one Earthcare CWP21 to provide 36.4 kW heating output as water at 46°C, and with a power input of 8.46kW, it gives a COP of 4.3, when using a ground coupled heat exchanger supplying propylene glycol at 0°C as the heat source. 18 fan coil units of varying sizes are used to distribute heat around the building. These units are far smaller, less intrusive, more controllable and quieter in operation than the electric night storage heaters they replaced.

The insistence on the use of natural refrigerants together with the use of the latest ground source heat pump technologies has resulted in the most energy efficient and environmentally friendly heating system of its kind in the country. The combined effect of these energy efficiency measures result in energy savings in excess of 75% relative to direct electric heating. In addition the plant will run for only 5 days per week instead of 7 saving a further 28%, taking the total savings to a staggering 79%. It was anticipated that the heat pump will save 18 tonnes of CO<sub>2</sub> per annum, based on data from the Edinburgh Centre for Carbon Management.

### **A range of hydrocarbon air cooled chillers up to 1265 kW capacity**

The EHS range of air cooled chillers was designed within the constraints of the EU's BAT (Best Available Technology) protocol and uses the hydrocarbon (HC) refrigerant R-290, which is an ideal replacement for R22 with the lowest Global Warming Potential. Over the last three years, the company has been developing larger sizes to extend the application of HC environmentally benign refrigerants and these are the first air-cooled chillers operating on HC refrigerants to deliver very large cooling outputs – the largest model in the range offers 1,265 kW. HC chillers have been available on the UK market since 1995, but their capacities were previously limited to around 200kW.

Indirect global warming is reduced by maximising energy efficiency through a combination of factors including the favourable thermodynamic characteristics of HCs, the use of subcooling circuits, which improve the coefficient of performance (COP) and

floating head pressure control that allows the condensing temperature to float as low as 20°C if ambient conditions allow, instead of the normal 40°C. This is said to be particularly beneficial for chillers that operate year round or at night when ambient temperatures are lower. The combined effect of these energy efficiency measures will result in a potential energy saving in excess of 50% relative to chillers that operate year round without these energy saving features. Further improvements will be achieved by the development of a new vapour injection economised screw. There is an increased demand for this type of solution because until now specifiers and users of screw compressor chillers have been restricted to choosing between expensive ammonia chillers or HFC chillers.

Britain's largest ever hydrocarbon refrigerant chiller for a building services application was installed at the historic Church House building in Westminster close to the Houses of Parliament in 2007. The 600kW air cooled water chiller is part of the new EHS range of hydrocarbon (HC) chillers developed by the company. The original Church House was built to commemorate Queen Victoria's golden jubilee and the current building was opened by King George VI in 1940. It is calculated that the long-term pay back, both financially to Church House and in reduced environmental impact, will more than offset all the capital, installation and disruption costs.

With both government departments and large corporations increasingly looking for cost effective alternatives to HFCs, this project is a practical demonstration that natural refrigerants can offer cost effective and practical solutions across the whole range of building services applications..

### **Project to develop new refrigerants blends**

An agreement with the Odessa State Academy of Refrigeration in the Ukraine gives the company the exclusive right to commercialise its research into low environmental impact refrigerants and funding by E-Synergy from its £30m Sustainable Technology Fund has allowed the company to develop and patent three new high pressure azeotropic refrigerants: There are distinct advantages of fluids that possess low normal boiling point (NBP) – or high saturation pressure – such as more compact systems, possibilities for achieving higher system efficiency, and advantages associated with operating above atmospheric pressure. However, the currently available refrigerants, such as R410A and R744 suffer from negative characteristics such as high GWP and/or low critical temperature. There is no single-component refrigerant with low-GWP and high critical temperature using these fluids, and most mixtures that may achieve these criteria are zeotropes with high temperature glide.

It was therefore concluded that azeotropes with thermodynamic characteristics similar to R410A and R744 would be commercially attractive. A development project was subsequently undertaken with the objective of identifying such blends.

### Three mixtures have arisen from this work:

#### ECP410A – Blend for domestic and commercial air conditioning and heat pumps

The saturated pressure-temperature characteristics and volumetric refrigerating capacity are close to that of R410A. The critical temperature is significantly higher (almost 20 K), indicating improved performance, particularly at higher ambient temperatures. Given these aspects, the blend is considered to be broadly applicable to systems used for domestic and commercial air conditioning, and heat pumping.

System performance evaluations conducted around European rating conditions revealed the following, when compared to R410A:

- Evaporating capacity was a little greater than the theoretical results, being about 85% of R410A, and condensing capacity being a little less.
- Cooling COP was between 6 – 10% higher than R410A, whilst heating COP was at least 15% higher.
- Evaporating temperature was up to 4 K higher than R410A, condensing temperature is about 1 K lower for the mixture and discharge temperature around 2 – 4 K lower than R410A.

#### ECP717 – Blend for industrial process, food and blast freezing applications

This mixture possesses advantages over the refrigerants normally used in industrial type applications. In the case of pure ammonia, which has a relatively high NBP and low specific heat, low evaporating temperatures lead to sub-atmospheric operation which allows for the leakage of air into the system, and high compressor discharge temperatures. ECP717 overcomes these drawbacks by significantly reducing the NBP and also allowing much lower discharge temperatures. Consequently single-stage compression may be used instead of two-stage, which requires an additional compressor. In comparison to the use of R744, the problem of high triple point is overcome. Lastly, there are ongoing problems with refrigeration oils given the poor miscibility with R717, which ECP717 overcomes. Given these aspects, the blend is considered to be broadly applicable in systems used for industrial process, food and blast freezing applications.

The property data for this mixture was used to analyse the performance and the following findings were made:

- COP is similar to pure R717.
- Volumetric refrigerating effect (VRE) exhibits a synergistic behaviour and gives considerably higher values of VRE than the pure components.
- Discharge temperature is significantly lower than R717, which favours system reliability.

- Improved heat transfer, particularly in the evaporator, resulting in higher evaporating temperatures.
- The degradation in COP and refrigerating capacity with increasing temperature lifts in a single stage cycle is reduced relative to pure ammonia.

The azeotropic blend is optimised for below -33°C applications. It has particular utility for industrial process, food and blast freezing applications and will displace liquid nitrogen as well as two stage ammonia systems.

#### ECP744 – Blend for commercial point-of-sale refrigeration and vehicle air conditioning equipment

ECP744 has advantages in terms of property changes, specifically, raising the critical temperature and lowering the triple point. For pure R744 these introduce hindrances in its application which result in super-critical operation at ambient temperatures above 25°C and solid formations when it undergoes rapid reduction of pressure towards atmospheric. Whereas R744 is being introduced into commercial refrigeration and point-of-sale applications, the characteristics of this mixture could help overcome several of the existing problems.

System performance evaluations were carried out and it was found that the refrigerating capacity and pressure was significantly greater than that of R410A, and less than pure R744. The cooling COP was found to be about 6% higher than pure R744. This was attributed to the higher critical temperature of the mixture. An additional consideration is the potential reduction in pressure rating of the system.

The higher critical temperature, lower triple point and more efficient refrigeration cycle are all significant benefits, but the commercial benefit arises from the reduction in condensing pressure, allowing the leak tight use of silver soldered joints. The real problem for UK refrigeration engineers using CO<sub>2</sub> is the condensing pressure. Realistically all joints should be TIG welded stainless steel, but UK refrigeration engineers do not have the necessary skills and UK refrigeration customers are not prepared to pay for specialist labour. Consequently most CO<sub>2</sub> installations in the UK have used compression fittings or silver soldered joints with seamed mild steel pipe. As a result most UK CO<sub>2</sub> systems leak at more than 25% per annum. Arguably, the average HFC system is no better, but 25% leakage is unacceptable regardless of the working fluid, if only because under-charged systems use more energy.

Using a combination of novel property modelling, safety analyses and comprehensive system simulation, a number of previously unidentified azeotropic and near-azeotropic blends have been identified for use in certain applications where existing refrigerant options are subject to a variety of hindrances. A summary of the characteristics of these new blends is provided in Table 1 below.

Name	ECP410A	ECP717	ECP744
Molar Mass	43.6	22.9	39.0
NBP (°C)	-49.2	-89.0	-84.5
Critical temp (°C)	94.9	41.9	37.9
LFL (% vol)	2.7 – 2.9	4.0 – 4.2	non-flammable
Likely safety class	A3	A2	A1
ODP	0	0	0
GWP (100)	7	2	46

Table 1: Characteristics of new blends

These new blends offer notable advantages over existing refrigerants, in particular:

- Zero ODP and low GWP, below 150, and mainly “naturally” occurring
- Improved thermodynamic properties (such as critical temperature and minimal temperature glide) over similar existing refrigerants
- Good solubility with oils
- Low toxicity, and reduced flammability
- Known and understood chemical and material compatibility

Earthcare is currently negotiating global licenses for the new refrigerants.

---

## Influencing political decision-makers

---

Earthcare’s work is not completed yet, as global CO<sub>2</sub> emissions are spiralling out of control and there is an urgent need to start replacing fossil fuel boilers with heat pumps. However suitable equipment does not yet exist, and research in this area is still at an early stage. Moreover, anyone who thought that the F Gas Regulations have neutralised the HFC problem needs to think again. The formidable F Gas lobby continues to exert its malevolent influence and halocarbon emissions still account for some 13% of man made global warming. To counteract this Earthcare is campaigning for:

- The EU to provide funding for the research and promotion of F gas alternatives as committed by the EU environment directorate climate change program priority measures for F gas abatement, but never implemented.
- The EU to implement the F gas regulation commitment on the promotion of alternatives.
- The EU to ensure that the F gas review considers natural refrigerants not just leakage reduction.
- The EU to recommend natural refrigerants within the eco-design directive.
- The EU to investigate how trade standards hinder the adoption of natural refrigerants.
- UNEP to stop subsidising the manufacture of ozone depleting refrigerants and to start providing carbon credits for the conversion of equipment manufacturing factories from ozone depleting refrigerants to natural refrigerants.

---

## Concluding remarks

---

To conclude, it would be fair to say that the changes in refrigeration technology – spurred on by legislation and environmental concern – give users an unrivalled opportunity to adopt energy efficient equipment utilising natural refrigerants. Current and proposed legislation will make it even more important to meet environmental best practice requirements. Earthcare is not yet a global player but will continue to tackle corporations head-on when they disagree with them. They believe that with vision, action and commitment the campaign for a sustainable future for our industry is winnable and that they will be on the winning side.

---

**Annex**

---

---

List of contributors

---

---

## Jason Anderson

---

Head of Climate Change Programme  
Institute for European Environmental Policy (IEEP)  
Quai au Foin/Hooikaai 55  
1000 Brussels, Belgium

Phone: +32 (0)2 738 7470, Fax: +32 (0)2 732 4004  
janderson@ieep.eu

Jason Anderson is a Senior Fellow at the Brussels office of the Institute for European Environmental Policy (IEEP), where he has led the Climate Change Programme since 2004. Prior to this he was an energy policy analyst at Climate Action Network Europe and a consultant to the Dutch government on the Montreal Protocol. In the 1990s he helped create project finance opportunities for solar energy projects in Central America, and was an energy efficiency and renewable energy specialist at the US Department of Energy. He has degrees from the University of California, Berkeley, and from Harvard University.

---

## Katja Becken

---

Federal Environment Agency  
Wörlitzer Platz 1  
06844 Dessau-Roßlau, Germany

Phone: +49 (0)340 2103 3407  
katja.becken@uba.de

Katja Becken holds a degree in environmental engineering from the Technical University of Berlin (Germany). She is currently a national expert and policy adviser at the German Federal Environment Agency. In this position she compiles and evaluates technical, economical and political information on halogenated substances that deplete the ozone layer and/or are responsible for global warming. She is also responsible for European and national laws and regulations regarding these substances.

---

## Prof. Dr. José M. Corberán

---

Professor, Applied Thermodynamics Department  
Instituto de Ingeniería Energética (IIE)  
Ciudad Politécnica de la Innovación, Edificio 8E, Cubo F, Planta 5ª  
Universidad Politécnica de Valencia, Camino de Vera s/n  
46022 Valencia, Spain  
corberan@ter.upv.es

Prof. Dr. José Corberán is University Professor at the Applied Thermodynamics of the Universidad Politecnica de Valencia, Spain and head of the Thermal Area of the Institute for Energy Engineering. He is an expert on modelling, especially refrigeration systems, non-steady and compressible flows, and thermal systems. He has led a number of R&D projects dealing with refrigeration equipment modelling and optimisation. He has been lead scientist in several conferences concerning Refrigeration, Heat Transfer and Two-Phase Flow. He has authored a great number of international scientific papers. His software for designing refrigeration equipment IMST-ART was awarded with an honourable mention at the Software Innovation Award of the AHR Expo 2006 in Chicago.

---

## Dr. Daniel Colbourne

---

Re-phridge  
PO Box 4745  
Stratford-upon-Avon  
Warwickshire CV37 1FE, United Kingdom  
Phone: +44 (0)1789 268285  
d.colbourne@re-phridge.co.uk

Dr. Daniel Colbourne is an independent consultant working on environmental, safety and efficiency aspects related refrigerants, and amongst other projects, involves development work on new refrigerants, system and component modelling, and related experimental work. He is a member of the UNEP Technical Options Committee, a number of standardisation committees and industry technical committees. He was previously the refrigerants technical manager for Calor Gas Ltd., development manager for BOC Special Gases, and in addition has worked for refrigeration companies, being involved with the design, installation and servicing of commercial and other refrigeration and air conditioning equipment.

---

## Nicholas Cox

---

Earthcare Products Limited  
405 Mill Studio, Crane Mead, Ware  
Herts SG12 9PY, United Kingdom

Phone: +44 (0)1920 444082, Fax: +44 (0)845 2802334  
NJC@earthcareproducts.co.uk, www.earthcareproducts.co.uk

Nicholas Cox is the Managing Director of Earthcare Products Limited, the company that he founded in 1997. During a long career in this field, he has presented many papers on the subject. A fellow of the Institute of Sales and Marketing Management, he was awarded a graduateship of the City and Guilds of London Institute for his work on how industry could better utilise natural refrigerants and energy efficiency. Nicholas Cox is considered a leading authority on environmentally friendly refrigeration and air conditioning. He has advised both the UK government and the EU commission on environmental aspects of refrigeration and air conditioning, and he has carried out reviews and submitted written responses to proposed and pending policy documents and legislation regarding refrigerant issues.

---

## Dr. Sukumar Devotta

---

National Environmental Engineering Research Institute (NEERI)  
Director Dr. Sukumar Devotta  
Nehru Marg  
Nagpur, 440020, India

Phone: 091-0712-2249999, Fax: 091- 0712-2249900  
director@neeri.res.in, www.neeri.res.in

Dr. Sukumar Devotta, Director of the NEERI, is a Chemical Engineer with Ph. D. in 1978 from the University of Madras, followed by his Post-Doctoral Fellowship from the University of Salford, England during 1979-84. He also obtained M.Sc. in Chemical Engineering from the University of Salford. Dr. Devotta began his research carrier at NCL, Pune, in 1984, as Scientist E-I in Chemical Engineering Division became Director Grade Scientist in 1996. He assumed the office as Director, NEERI on 1st August, 2003. He has also served and continues to serve in many National & International environmental committees including, United Nations Environment Programme, Intergovernmental Panel on Climate Change, and MoEF Committees.

---

## Alan Gerrard

---

Centre of Excellence Ice Foods, Unilever Foods R&D

Colworth Science Park, Sharnbrook

Beds MK44 1LQ, United Kingdom

Phone: +44 1234 22 28 13, Fax: +44 1234 22 20 07, Mobile: +44 77 14 70 86 27

alan.gerrard@unilever.com

Alan Gerrard is a Chemical Engineer by training and has been working for Unilever in various jobs and countries for 25 years. Alan has worked principally in the foods part of the business specifically in Unilever's Tea and Ice Cream businesses and has had overseas postings in Holland, Austria and Thailand. He has experience in most parts of the supply chain. He is currently working in Unilever Foods R&D Centre of Excellence in the UK. In addition to technical responsibility for global innovation projects, Alan is responsible for the rollout of Unilever's HFC-free, hydrocarbon ice cream cabinets. Starting with a small trial at the Sydney Olympics in 2000, the project has now delivered 270,000+ HC cabinets into the market place globally. As well as coordinating the internal element of Unilever's hydrocarbon cabinet rollout, Alan liaises with suppliers, NGOs and other multinationals on a regular basis.

---

## Sergio Girotto

---

Enex srl

Via Camalò, 22

31050 Ponzano (TV), Italy

sergio.girotto@enex-ref.com

Sergio Girotto has studied Mechanical Engineering in Padova University. He has over 20 years experience in industrial and commercial refrigeration, mainly involved in design, R&D, quality assurance, contracting and production. Presently Sergio Girotto is managing Enex srl, a company founded in 2004, producing refrigeration systems and heat pumps and supplying engineering services.

The main fields of activity of Enex are development, design and installation of energy-efficient refrigeration and heat pump, mainly with natural working fluids. Refrigeration units designed and produced by Enex were installed recently in UK, Hungary, Switzerland, Australia and Italy. Sergio Girotto is author or co-author of many papers, published on International Journal of Refrigeration or presented at international conferences or published in Italy and Sweden.

---

## Dr. Thomas Grammig

---

GTZ Proklima

c/o HEAT International

Zum Talblick 2

61479 Glashuetten, Germany

Phone: +49 (0)6174 964575, Fax: +49 (0)6174 61209

thomas.grammig@proklima.net, www.gtz.de/proklima

Dr. Thomas Grammig is an energy engineer specialising in CDM project development. Before joining Proklima, he has extensively advised on CDM for the LEAD Foundation, USAID and the EU development assistance since 1996. He has also published management research on technology transfer and intercultural relations.

---

## Roland Handschuh

---

Güntner AG & Co. KG

Hans-Güntner-Straße 2-6

82256 Fürstenfeldbruck, Germany

Phone: +49 8141 242- 204, Fax: +49 8141 242- 5243

r.handschuh@guentner.de, www.guentner.de

Dipl. Ing. Roland Handschuh studied power plant engineering combined with the optional subject refrigeration and air conditioning technology at the Technical University Munich (TU München). After having accomplished his studies, he worked in sales departments of several companies, among others at Danfoss, selling components for refrigeration and air conditioning technology. He has worked for 15 years in the field of heat exchanger technology in sales, product management and marketing departments, since seven years he is the head of the sales department at the company Güntner AG & Co. KG.



---

## Dr. Karin Jahn

---

eurammon  
Lyoner Strasse 18  
60528 Frankfurt, Germany

Phone: +49 (0)69 6603-1277, Fax: +49 (0)69 6603-2276  
karin.jahn@eurammon.com, www.eurammon.com

Dr. Karin Jahn is Managing Director of eurammon, the European initiative for natural refrigerants. The initiative was set up in 1996 and is open to European companies and institutions with a vested interest in natural refrigerants, as well as to individuals e.g. scientists and researchers. For further information about eurammon, consult the "Further help" section.

---

## Dr. Heinz Jürgensen

---

Danfoss Compressors GmbH  
Application Department  
Mads-Clausen-Strasse 7  
D-24939 Flensburg, Germany

j.juergensen@danfoss.de, www.danfoss.de

Dr. Heinz Jürgensen was born on 29. July 1959 in Sønderborg, Denmark. He studied Mechanical Engineering at the University of Hanover in Germany. In 1986 he graduated with a diploma ("Diplom-Ingenieur", Speciality in Refrigeration.) From 1986 to 1990 he was involved in research projects at the Institute on Refrigeration and in 1991 he obtained the Doktor-Ingenieur at the University of Hanover, Institute on Refrigeration, Prof. Dr.-Ing. Horst Kruse. From 1990 to 1997 he worked for AEG Hausgeräte GmbH, Germany, Factory for Refrigerators and Freezers, Basic Development Team. Since 1998 he is with Danfoss Compressors, Germany, Application Department.

---

## Prof. Dr. Michael Kauffeld

---

Karlsruhe University of Applied Sciences  
Department of Mechanical Engineering and Mechatronics  
Institute of Refrigeration, Air Conditioning and Environmental Engineering  
Moltkestr. 30, D-76133 Karlsruhe, Germany

Phone: +49 721 925 1843, Fax: +49 721 925 1915  
michael.kauffeld@hs-karlsruhe.de, www.hs-karlsruhe.de

Prof. Dr.-Ing. Michael Kauffeld studied mechanical engineering at the University of Hannover, Germany and at the Catholic University of America, Washington, D.C. He holds a Master degree and Doctorate in mechanical engineering from the University of Hannover. Since 1986, he has worked with a variety of development projects within the field of refrigeration. Since 2002 he is a professor in refrigeration technology at the Karlsruhe University of Applied Sciences. Most of his work has focused on natural working fluids. He has worked on the formulation of refrigerant management plans for Uruguay, Jamaica and Syria. Since 1997, he serves on the UNEP RTOC and served on the UNEP TEAP Task Force on Global Warming.

---

## Dr. Lambert Kuijpers

---

Technology for Sustainable Development  
Technical University R 1.15b, PO Box 513  
NL- 5600 MB Eindhoven  
UNEP Technology and Economics Assessment Panel Co-chair  
UNEP RTOC co-chair / IPCC AR4 Lead Author

lambert.kuijpers@hotmail.com

Dr. Lambert Kuijpers has a MsC and a PhD from the Technical University Eindhoven on nuclear physics, has been working on these issues in research centres in the Netherlands, Italy and the UK. He has been a group leader for thermodynamics (with R&D on refrigeration and AC topics) at Philips Research Labs Eindhoven, NL, which assignment finished in 1993. Since 1992 he has been co-chairing the UNEP Technology and Economics Assessment Panel and also the UNEP TOC Refrigeration and AC. He has been guiding and has also been very instrumental in the drafting of many reports related to all relevant Montreal Protocol issues; this also includes the reports on the replenishment of the Multilateral Fund. He has been actively involved in several IPCC reports, lastly in the AR4.

---

## Anders Lindborg

---

Nyponvägen 24  
260 40 Viken, Sweden

Phone: +46 42 238 155, Mobile: +46 708 238 175  
anders@ammoniapartnership.se, www.ammoniapartnership.se

Anders Lindborg studied Mechanical Engineering at the Royal Technical University of Stockholm. He has specialised in Industrial Refrigeration, Refrigeration Air Conditioning, use of Heat Pumps, Cold Storage, and IQF Food Freezing and Safety related to the use of Ammonia as a Refrigerant, as well as risk analysis of ammonia and flammable refrigerants and legal matters, including fire safety related to cold storage and food processing. Anders Lindborg has developed several publications on industrial ammonia refrigeration and related safety. He has been part of the Assessment Committees to the Montreal Protocol and is member in several international refrigeration associations and has contributed to the development of several European standards. At present, he is the President of the Ammonia Partnership AB in Sweden.

---

## Barry Lyons

---

Business Development Manager, Refrigerants, BOC UK  
The Priestley Centre  
10 Priestley Road, Surrey Research Park  
Guildford  
Surrey GU2 7XY, United Kingdom  
barry.lyons@boc.com

Barry Lyons started his career with York-Borg-Warner as an apprentice obtaining HNC in Engineering and Diploma in Refrigeration and Thermodynamics at the then National College. Worked in both refrigeration and air conditioning sales and service departments within York, held various management positions within York UK and Internationally.

Moved to Stal Refrigeration as Service Sales Manager, Gresco Refrigeration as a Sales Engineer, then Service Director and latterly Sales Director. He joined BOC in 2006 as Business Development Manager for Refrigerants. Barry Lyons is a Fellow of the Institute of Refrigeration, a committee member on ACRIB, BRA, and FETA. He represents BOC on various stakeholder groups for F-Gas and ODS regulation implementation.

---

## Dr. Ian L. Maclaine-cross

---

35 Hall Drive  
Menai NSW  
Australia 2234

Phone: +61295435787, Mobile: +61403224361  
ilm@patch.bpa.nu

Dr. Maclaine-cross completed a Bachelor of Engineering degree at The University of Melbourne in 1965 and a Doctor of Philosophy degree at Monash University in 1974. He researched at CSIRO from 1966 to 1968 and taught, researched and published in mechanical engineering at The University of New South Wales from 1973 to 2005.

---

## Dr. Silvia Minetto

---

Università degli Studi di Padova- Dipartimento di Fisica Tecnica  
Via Venezia, 1  
I-35131 Padova, Italy  
silvia.minetto@unipd.it

Dr. Silvia Minetto is a Post Doctoral Researcher at the University of Padova, where she also got her master degree in Mechanical Engineering in 1998. She has a background in commercial refrigeration and in domestic refrigeration, which was acquired during her employment in the refrigeration industry. She was engaged in several research works, mainly concerning thermodynamics of the inverse cycles, refrigerating equipment and installations. At present she is involved in analytical and experimental works on carbon dioxide refrigerating machines with reference to energy saving and environment safety.

---

## Dr. Dieter Mosemann

---

Consultant for Screw Compressor Technology at the DKV  
Deutscher Kälte- und Klimatechnischer Verein e.V. DKV  
Pfaffenwaldring 10  
70569 Stuttgart, Germany

info@dkv.org

Dr. Dieter Mosemann is a Manager R&D for screw compressors since 1983. Until 1968 he studied at Technical University Dresden and obtained a Doctor degree in 1991.

---

## Michael Müller

---

Parliamentary State Secretary at the Federal Ministry for the Environment,  
Nature Conservation and Nuclear Safety  
Alexanderstraße 3  
D-10178 Berlin-Mitte, Germany

Phone: +49 030 18 305-0, Fax: +49 030 18 305-4375  
www.bmu.de/english

Michael Müller was born on 10 July 1948 in Bernburg/Saale. He is a member of the German Bundestag since 1983. From 1992 to 1998 he was the environment spokesman; from 1998 to 2005 he was deputy chair of the SPD parliamentary group in the Bundestag. Since November 2005 Michael Müller ist the Parliamentary State Secretary in the Federal Ministry for the Environment, Nature Conservation and Nuclear Safety.

---

## Jackson Ong

---

Nat Energy Resources  
48 Toh Guan East  
#08-98  
Enterprise Hub, Singapore 608586

Phone: +65 98196479, Fax: +65 64699235  
Jackson@nat-energy.com.sg

Jackson Ong studied at the London School of Economics. He has been working as foreign exchange trader for the past 18 years. Currently he is working as self man businessman.

---

## Alexander Cohr Pachai

---

Johnson Controls  
Christian X's Vej 201  
8270 Højebjerg, Denmark

alexander.c.pachai@jci.com, www.johnsoncontrols.com

Alexander Pachai has a background as service technician, teacher, technical manager, and product manager and has been involved in R&D, business development and technical helpdesk. Mostly engaged with natural refrigerants in particular HC and CO<sub>2</sub> since 1995. Involved in the sale and installation of the first large HC systems (1.8MW) in Denmark for a telecom internet head quarter in 1999. Designed and installed the first CO<sub>2</sub>/R404A cascade systems in Denmark, designed and sold the first CO<sub>2</sub>/HC cascade system in New Zealand and in the UK. Engaged with the phase out first of the CFC refrigerants and education and training of service technicians. Engaged now with the phase out of the of the HCFC refrigerants.

---

## Dr. Atul Sitaram Padalkar

---

Sinhgad College of Engineering, Pune  
44/1, Vadgaon (Bk),  
Pune 411 041, India

Phone: 91-20-24354705, Fax: 91-20-24357243  
principal.scoe@sinhgad.edu, atulpadalkar@rediffmail.com

Dr. Padalkar was born on June 1, 1962. He obtains a B.E, M.E and Ph.D in Mechanical Engineering. Presently, he is principal at the Sinhgad College of Engineering in Pune and Member of the Academic Council. He has been professors at the AISSMS College of Engineering before from 1996-2004. He is a fellow of the institution of engineers (FIE) Life Member, ISTE, in New Delhi.

---

## Dr. Andy Pearson

---

Star Refrigeration  
Thornliebank Industrial Estate  
Glasgow, G46 8JW, United Kingdom

apearson@star-ref.co.uk, ww.star-ref.co.uk

Dr. Andy Pearson is the Managing Director of Star Refrigeration's Contracts Group. He studied Manufacturing Science and Engineering at the University of Strathclyde, graduating with first class honours degrees BSc and BEng in 1986. He returned to Strathclyde to complete his PhD thesis "The Optimisation of Carbon Dioxide Refrigeration Systems" in 2005. Andy is a Fellow of the Institute of Refrigeration and the Institution of Mechanical Engineers. He is a member of the BSI, CEN and ISO technical committees on refrigeration safety standards and is the chairman of the Institute of Refrigeration's technical committee. In 2007 he received the Institute of Refrigeration's J&E Hall Gold Medal for his work on carbon dioxide systems.

---

## Prof. Dr. René Rieberer

---

Graz University of Technology  
Institute of Thermal Engineering  
Inffeldgasse 25 / B  
A 8010 Graz, Austria

Phone: +43 316 873-7302, Fax: +43 316 873-7305  
rene.rieberer@tugraz.at

Prof. Dr. René Rieberer is an Associate Professor and group leader at the Institute of Thermal Engineering, Graz University of Technology. In addition to his university activities, he is Key Researcher at the 'Virtual Vehicle Competence Center (vif)' and member of technical committees at the Austrian Standards Institute (ON). His R&D activities focus on heating, refrigerating, and air-conditioning technology. His doctoral thesis (1998) deals with CO<sub>2</sub> as working fluid for heat pumps. His know-how is proven by about 60 scientific publications.

---

## Samer Sawalha

---

PhD student at the Energy Technology Department at the Royal Institute of Technology (KTH), Stockholm Sweden  
Energy Technology Department  
Brinellvägen 68  
10044 Stockholm, Sweden

Phone: +46 (0)8 790 7889  
samer@energy.kth.se

Samer Sawalha is currently a PhD Student at the Energy Technology Department of the Royal Institute of Technology (KTH). Stockholm, Sweden. Graduation is expected in May 2008. He has been working on investigating the use CO<sub>2</sub> as a refrigerant in supermarket refrigeration and in ice rink application. The work includes computer simulation modeling and experimental investigations of the various CO<sub>2</sub> system solutions. The list of publications consists of 8 conference papers, 3 journal papers, several magazine articles and three main reports.

---

## Veronica Shiels

---

Global Product Manager, Refrigerants, The Linde Group  
The Priestley Centre  
10 Priestley Road  
Surrey Research Park  
Guildford  
Surrey GU2 7XY, United Kingdom

Phone: +44 (0) 7748 703698  
veronica.shiels@boc.com

Veronica Shiels joined BOC as a graduate working in sales and marketing in Industrial and Food Grade gases before becoming UK Product Manager, Refrigerants in 1994. She moved to an international business development role within The BOC Group before transferring to Global Product Manager, Refrigerant Gases in The Linde Group following Linde's acquisition of BOC in 2006.

---

## Prof. Dr. Jørn Stene

---

Research scientist at SINTEF Energy Research, Dept. of Energy Processes  
Associate professor at The Norwegian University of Science and Technology (NTNU), Dept. of Energy and Process Engineering  
Kolbjørn Hejes vei 1 D,  
7465 Trondheim, Norway

Jorn.Stene@sintef.no

Prof. Dr. Jørn Stene was born in 1962. He obtained a Ph.D. from NTNU in 2004 – “Residential CO<sub>2</sub> heat pump systems for combined space heating and hot water heating”. His main fields of competence are: Heat pump technology for heating and cooling of buildings, Energy conservation technology, CO<sub>2</sub> technology – heat pumps and refrigerating systems.

He is an international Member of the ASHRAE Committee TC.07 “Unitary and Room Air Conditioners and Heat Pumps (1998-2002) and a consulting member of the UNEP’s Technical Assessment Committee (UNEP TAC) for Ozon Protecting Technologies in Refrigeration, Air-conditioning and Heat pumps (1994-2004). He is a reviewer for The International Journal of Refrigeration, The International Journal of Energy and The IIR Gustav Lorentzen Conference

---

## Prof. Dr. Aryadi Suwono

---

Division of Energy Conversion  
Faculty of Mechanical and Aeronautical Engineering  
Bandung Institute of Technology  
Jalan Ganesha 10, Bandung 40132, Indonesia

Phone: +62 8 1122 7569, Fax: + 62 22 2501760  
aryadi@termo.pauir.itb.ac.id

Prof. Dr. Aryadi Suwono was born in Cilacap, Indonesia on 28 July 1949. In 1973 he obtained a undergraduate in Mechanical Engineering and in 1977 a Doctorat d’Etat es Science Physique (State Doctor of Science) at the Universite de Perpignan in France. Since 1973 he is a Faculty Member of Mechanical Engineering, ITB. From 2001-2006 he was involved in the Technical Options Committee of the United Nation Environment Programme (UNEP) to the Montreal Protocol. Since 2004 he is Head of Research Group of Thermal Energy Energy Conversion Mechanical Engineering, Bandung Institute of Technology (ITB).

---

## Amir Tadros

---

Connell Wagner Pty Ltd  
116 Military Road  
Sydney (Neutral Bay) NSW 2089  
Australia  
(PO Box 538)

Phone: +61 2 94655 447, Fax: +61 2 94655 881  
TadrosA@conwag.com, www.conwag.com

Amir Tadros has more than 11 years experience, which includes mechanical design, refrigeration and air-conditioning, piping projects, thermo-fluids and heat transfer applications. Amir Tadros expanded his technical knowledge by undertaking post-graduate research.

---

## Dr. Ladas D. Taylor

---

Energy Resources Group P/l  
Suite 10, 317-321 Whitehorse Road, Nunawading  
Victoria, 3131 Australia

Phone: +61 3 9894 7100, Fax: +61 3 9894 7055  
ladas@erg1000.com, info@erg1000.com, sales@erg1000.com

Dr. Ladas Taylor studied in the UK at the University of South London (Formerly South Bank Poly) where he obtained a Ph.D. He has experience in Design and Contract for all types of Refrigeration and Air Conditioning systems, including process cooling as well as R&D into alternative lubricants for use with refrigerants and especially HC's and HFC's. Currently Ladas Taylor is involved in R&D into alternative, natural refrigerants, technical support and training at the Energy Resources Group.

---

## Prof. Dr. Reiner Tillner-Roth

---

EPTA Group Customer Service Director  
c/o EPTA Deutschland GmbH  
Ludolf-Krehl-Straße 7-11  
68167 Mannheim, Germany

Dr.-Ing. Habil. Reiner Tillner-Roth was born on 3.1.1963. From 1982 to 1989 he studied Mechanical Engineering (System Design Engineering). He obtains a PhD (German Dr.-Ing.) and postdoctoral thesis (German Habilitation) in Thermodynamics. He worked as Associate Professor in Germany (University Hannover) and Japan (Keio University, Yokohama) in Thermodynamics. He entered EPTA Germany (former BKT) in 1998. Positions: Technical manager BKT (1998-2000), Quality and technology manager (2000-2003), Logistic manager (2001-2003), EPTA Group Service Support manager (2003-2006), George Barker Ltd. UK acting Service director (2005-2007), EPTA Group Customer Service Director (since 2006).

---

## Juergen Usinger

---

Senior Project Advisor to Proklima  
c/o HEAT International  
Zum Talblick 2  
61479 Glashuetten, Germany

Phone: +49 6174 964077, Fax: +49 6174 61209  
juergen.usinger@proklima.net

In 1985 Juergen Usinger started his career as an overseas employee of the GTZ in the field of energy supply and efficiency schemes in Southern Asian and African countries before he finally got involved with the GTZ Montreal Protocol Programme "Proklima" in 1995. Since then he provides policy advice for the design of ODS phase out activities and manages their implementation in Article-5-countries. He advises various political institutions such as the German Federal Ministry for economic cooperation and development, the German Federal Environment Ministry and several Article-5-environment institutions on Montreal Protocol issues, is a permanent member of the German delegation to the Executive Committee of the Multilateral Fund of the Montreal Protocol.

---

## Dr. Dmytro Zaytsev

---

R&D Engineer Screw Compressors  
Grasso GmbH Refrigeration Technology  
Holzhauser Str. 165  
13509 Berlin, Germany

Phone: +49 30 43 592 839, Fax: +49 30 43 596 839  
dzaytsev@grasso.de

Dr. Dmytro Zaytsev obtained a Mechanical Engineer degree in 1996 from the Odessa State Academy of Refrigeration, Ukraine. In 2003 he got a Doctor degree, Delft University of Technology, The Netherlands. Since 2002 he is working as R&D Engineer at Grasso.

---

Further help section

---

---

## ARF – Ammonia Refrigeration Foundation

---

The Ammonia Refrigeration Foundation was formed in 2006. It is a non-profit research and education foundation organized by members of the International Institute Of Ammonia Refrigeration (IIAR). The mission of the Ammonia Refrigeration Foundation is to raise financial resources and to use these resources in the support of educational programs and research that benefit the industrial refrigeration industry. Some of the ways the foundation envisions accomplishing its goals are to create and fund scholarship programs and to fund industry-specific research.

### Contact for further information

Belinda Ross – Director of Member Services  
belinda\_ross@iiar.org, Phone: 703-312-4200

---

## eurammon

---

eurammon is a joint European initiative of companies, institutions and individuals who advocate an increased use of natural refrigerants. As a knowledge pool for the use of natural refrigerants in refrigeration engineering, the initiative sees as its mandate the creation of a platform for information sharing and the promotion of public awareness and acceptance of natural refrigerants. The objective is to promote the use of natural refrigerants in the interest of a healthy environment, and thereby encourage a sustainable approach in refrigeration engineering. eurammon provides comprehensive information about all aspects of natural refrigerants to experts, politicians and the public at large. It serves as a qualified contact for anyone interested in the subject.

### Contact for further information

eurammon, Dr. Karin Jahn  
Lyoner Strasse 18, D-60528 Frankfurt, Germany  
Phone: +49 (0) 69 6603-1277, Fax: +49 (0) 69 6603-2276  
karin.jahn@eurammon.com  
www.eurammon.com



---

## Faculty of Mechanical Engineering, University "Sv. Kiril & Metodij"

---

Proposal to establish a "Natural Refrigerants Fund": Implementation of technologies with natural refrigerants in developing countries together with developed countries.

[www.nrfund.org](http://www.nrfund.org)

Organization of international conference together with the IIR on:

Ammonia Refrigeration Technology

[www.mf.ukim.edu.mk/web\\_ohrid2007/ohrid-2007.html](http://www.mf.ukim.edu.mk/web_ohrid2007/ohrid-2007.html)

Establishing of Center for Climate Change and Energy technologies

[www.mf.ukim.edu.mk/ccet/home%20page](http://www.mf.ukim.edu.mk/ccet/home%20page)

Education, research and training.

Cooperation with industry.

Cooperation with UNEP, UNIDO, UNDP on ozone protection and climate change

### Contact for further information

Prof. Dr. Risto Ciconkov, [ristoci@ukim.edu.mk](mailto:ristoci@ukim.edu.mk)

PO Box 464, 1000 Skopje, Republic of Macedonia

---

## IIAR – International Institute of Ammonia Refrigeration

---

IIAR is an organization that serves those who use industrial refrigeration technology through education and advocacy. The Institute promotes the safe use of ammonia and other natural refrigerants through education, information, and standards. Our members include industrial refrigeration end users, many of whom are large multinational food processing companies, beverage producers and cold storage warehouse operators. Our membership also includes ammonia refrigeration contractors, engineers, component manufacturers, suppliers and academics. Each year, more than 1,000 ammonia refrigeration professionals representing all of our membership categories from around the world, attend the IIAR Industrial Refrigeration Conference & Exhibition.

### Contact for further information

Kirsten McNeil – Deputy Director for Technical Communications

[kirsten\\_mcneil@iiar.org](mailto:kirsten_mcneil@iiar.org), Phone: 703-312-4200

---

---

## International Institute of Refrigeration (IIR)

---

The IIR is an intergovernmental organization. It also comprises corporate and private members which receive information services.

The IIR's mission is to promote knowledge of refrigeration technology and all its applications in order to address today's major issues, including food safety and protection of the environment (reduction of global warming, prevention of ozone depletion), and the development of the countries (food, health).

The IIR services are publications (journals, books, statements, ...), working parties (WP) and conferences.

### Contact for further information

Didier Coulomb, Director of the International Institute of Refrigeration (IIR)

177 boulevard Malesherbes, 75017 Paris, France

Phone: 33 (0)1 42 27 32 35, Fax: 33 (0)1 47 63 17 98

[iif-iir@iifiir.org](mailto:iif-iir@iifiir.org)

[www.iifiir.org](http://www.iifiir.org)

---

## Refrigerants, Naturally!

---

Refrigerants, Naturally is a global initiative of companies committed to combat climate change and ozone layer depletion by substituting harmful fluorinated gases ("F-gases", such as CFCs, HCFCs and HFCs) with natural refrigerants with a focus on their point-of-sale cooling applications. Point-of-sale cooling may include the entire retail infrastructure, e.g. HVAC, but excludes manufacturing and distribution. Refrigerants, Naturally! is supported by Greenpeace and the United Nations Environment Programme (UNEP) and recognised as a "Partnership for Sustainable Development" by the UN Commission on Sustainable Development.

### Contact for further information

Refrigerants, Naturally! Secretariat, c/o HEAT GmbH

Zum Talblick 2, 61479 Glashütten, Germany

Tel: + 49 6174 964575, Fax: + 49 6174 61209

Contact person: Linda Ederberg

[Linda.Ederberg@refrigerantsnaturally.org](mailto:Linda.Ederberg@refrigerantsnaturally.org)

[www.refrigerantsnaturally.com](http://www.refrigerantsnaturally.com)

---

---

## Index

---

- AC, see Air Conditioner /Air Conditioning  
ACRIB, see Air-Conditioning and Refrigeration Industry Board  
Air 77, 87-92, 101-105, 113, 115, 127, 150, 155, 157, 167-168, 228-229, 231-233, 291- 296, 310, 321-323  
**Air Conditioner** 33, 41-42, 56, 64, 67-68, 111, 203, 209-220, 268 -269  
–, Commercial 360  
–, Domestic 243  
**Air Conditioning** 12, 14, 24, 26, 31-34, 45-50, 55, 62, 79, 82, 85, 108, 111, 113, 133, 136, 147, 149, 157, 161-163, 186, 209, 218, 273, 283, 287, 313, 316, 317, 319-327, 355,  
–, Residential 85, 147, 156, 220  
–, Stationary 33, 261  
–, Systems 31,33, 45-50, 62, 85, 111, 133, 159, 162, 210, 287, 316, 319, 353, 356, 357  
Air-Conditioning and Refrigeration Institute 210, 235  
Air-cooled systems 164, 166, 322, 323, 327, 346, 348, 358  
Alternative Refrigerant Evaluation Program 210  
AM, see Approved Methodology  
American Society of Heating, Refrigerating and Air-Conditioning Engineers (ASHRAE) 74, 77, 79, 83, 84, 88, 93, 113, 209, 215, 216, 331  
**Ammonia** 31, 33, 48, 58, 69-79, 80, 111-113, 127, 131, 137-144, 155, 161, 167, 171, 176-177, 209, 225, 232-234, 240, 245, 313-317, 319-329, 357-361  
–, Chillers 320-329, 359  
–, Reputation 69-79  
–, Safety 69-79  
–, Smell 69-79  
Ammoniapartnership 69, 376  
Ammonia Refrigeration Foundation (ARF) 389  
Approved Methodology 39-41  
AREP, see Alternative Refrigerant Evaluation Program  
ARF, see Ammonia Refrigeration Foundation  
ARI, see Air-Conditioning and Refrigeration Institute  
Article-5-Countries 9, 11, 13, 16, 17, 20, 22, 23, 173, 238, 385  
ASHRAE, see American Society of Heating, Refrigerating and Air-Conditioning Engineers  
Association for the Recognition of Refrigeration (STEK) Regulations 31  
ATEX, see ATmospheric EXplosible  
ATmospheric EXplosible 56, 67, 76-77  
Auckland 303-305, 312  
BA, see Blowing Agent  
Bali 28, 352  
Bandung Institute of Technology 203, 205, 383  
Bangchan 313  
Bangkok 293-296  
Banks (of ODS) 12-21, 30  
BAU, see Business As Usual  
Benzene 189, 231  
BIT, see Bandung Institute of Technology  
Blends, Refrigerants 31-33, 71, 173, 199, 319-323, 359, 362  
Blowing Agent 15  
BMU, see Bundesumweltministerium  
BOC 225  
Building Services 319-329, 359  
Bundesumweltministerium (BMU) 7  
Business As Usual 14, 269  
Butadiene 176, 231  
Butane 34, 111, 127, 131, 132, 190, 199, 200, 261, 270, 275, 353, 343  
**Cabinets** 164, 168, 173-175, 180, 182, 304, 306-307, 315, 318, 331-341  
Cabinets, Ice-cream 331-341  
**Carbon Dioxide (CO<sub>2</sub>)** 7,8, 26-28, 31-34, 37, 44, 49, 58, 78, 81-93, 111, 127-128, 132, 137, 145-159, 161-173, 174, 175, 209, 225-229, 231-235, 239-241, 268, 270, 273-281, 283-286, 303-312, 313-317, 283-286, 287-293, 319-329, 358, 361, 362, 301, 303-312, 313-317, 319-329, 358, 361, 362  
–, Cycle 33, 81, 98-99, 132, 145, 149, 151, 228, 283, 285-286, 287-301, 311, 314, 361  
–, Evaporator 64, 273-281  
–, Safety 81-93  
–, Supermarkets 32, 33, 81-93, 134, 161-172, 173-185, 303-317

Carbon Tetrachloride 17  
Carlsberg 340  
Cascade system 82, 85, 163, 166, 283, 284, 312, 314, 315, 316, 328  
CDM, see Clean Development Mechanism  
CEN, see Comité Européen de Normalisation/European Committee for Standardisation  
CENELEC, see European Committee for Electrotechnical Standardisation  
Central Multiplex System 167  
Centralised Direct Expansion 174  
Certified Emission Reductions (CER) 37-41  
CFCs, see Chlorofluorocarbons  
Chiller 33, 37-41, 111-122, 132, 133, 134, 142, 143, 163, 174, 175, 177, 193, 203-207, 238, 242-244, 260, 303, 307, 311, 314, 319-330, 343-353, 358-359  
Chlorofluorocarbons (CFC) 24, 25, 26, 43, 55, 209  
Classification, refrigerants 59, 84, 76, 121, 128, 189, 132  
Clean Development Mechanism (CDM) 22, 29, 37-42  
CO<sub>2</sub>, see Carbon Dioxide  
CO<sub>2e</sub>, see CO<sub>2</sub>-equivalent  
CO<sub>2</sub>-equivalent 178, 307  
Coefficient of Performance (COP) 138, 141, 146-148, 150, 151, 153, 156-159, 166, 171, 176-177, 196-198, 200, 210, 215-216, 245-260, 265-267, 289-299, 358, 360, 361  
Cold storage and food processing 169  
Commercial Refrigeration 32-33, 56, 64, 161, 163, 165, 166, 287-289, 361  
**Compressor**  
–, CO<sub>2</sub> 270, 308  
–, Design 262, 273-286  
–, Efficiency 42, 139, 194, 196, 200, 250  
–, Screw 139, 143, 314, 245-260, 315, 323, 326, 327, 359  
–, Semi hermetic 64, 154, 244, 289, 297, 327, 351  
–, Small hermetic 64, 154, 261, 262, 268, 270, 271, 331  
Conference of the Parties (COP) of the Montreal Protocol 27, 28  
Conversion of refrigeration systems 19, 32-34, 44, 47, 49, 189, 203-208, 238, 240, 244, 251, 319, 326, 344, 345, 347, 349, 350-351  
Cooling capacity 142, 143, 177, 176, 180-182, 192-195, 206, 211, 215, 219, 220, 235, 268, 287, 300, 305, 308, 316, 333, 356  
COP, see Coefficient of Performance  
CPU, see Central Processing Unit  
Critical Temperature 129, 145, 166, 266, 287, 311, 312, 323, 359, 361, 362  
Critical Use Exemptions 17, 20  
CTC, see Carbon Tetrachloride  
CUE, see Critical Use Exemptions  
Dairy Processing 313  
Danfoss Compressor GmbH 261, 268-270, 316  
Danish Technological Institute (DTI) 337  
DBT, see Dry bulb temperature  
DC, see Developing Countries  
Dehumidification 157, 274  
Demand-side Energy Efficiency 37-42  
Density, vapour density of refrigerant 63, 100, 117, 137, 190-195, 214, 215, 275  
Destruction, of ODS 13-15, 28-31, 349  
Deutscher Kälte- und Klimatechnik Verein (German Association of Refrigeration and Air Conditioning Technology, (DKV) 273  
Developing Countries 8-9, 11, 19, 23, 27, 33, 34, 37, 175, 181, 184  
Direct Expansion Systems 60, 81, 134, 163-167, 173-185  
Directives, Natural Refrigerants 55-59, 67  
DIS ISO 5149: 2007 59, 62  
Discharge pressure 204, 217, 219, 226, 232, 262, 250, 263, 311, 323  
Discharge temperature 107, 198, 218, 219, 242, 254, 262, 266, 289, 300, 323  
Dispersion, refrigerant 100  
DKV, see Deutscher Kälte- und Klimatechnik Verein (German Association of Refrigeration and Air Conditioning Technology)  
Domestic Refrigeration 32-34, 108, 333-334  
Drop-in 189, 199, 200, 207, 210, 215, 238, 319  
Dry bulb temperature (DBT) 212, 292-295, 323  
Drying 147, 153-155  
DTI, see Danish Technological Institute  
DX, see Direct Expansion Systems  
Earthcare Products Ltd. 355, 371  
EcoCute 149, 153, 158  
EE, see Energy Efficiency

EER, see Energy Efficiency Ratio  
Emergency Procedures 111, 114, 119, 120  
Emissions, Direct 161-171, 240, 303  
Emissions, Indirect 161-171, 240, 356  
EN 378: 2000 59, 68, 77, 79, 131  
EN 378: 2007 59, 62, 68, 83, 93, 110  
EN 60335-2 series of standards 56, 59, 60-63, 68, 271  
EN 60335-2-24: 2007 56, 59, 62, 68  
EN 60335-2-40: 2006 56, 59, 62, 68  
EN 60335-2-89: 2007 56, 59, 62, 68  
End-of life management 14  
End-of life options 15  
**Energy Efficiency** 9, 37-42, 48, 138-139, 167-171, 210-212, 253, 287-291, 300, 304, 312, 329, 355-359  
– CDM 37-42  
– Ratio 210  
– Group 343, 384  
Enx 287, 372  
Energy Resources Group (ERG) 343-345, 379  
Environmental Protection Agency 340  
EOL, see End-of-life  
EPA, see Environmental Protection Agency  
EPBD, see European Energy Performance of Buildings Directive  
Epta Group 283, 284  
ERG, see Energy Resources Group  
EU legislation 43-50  
EU, see European Union  
Eurammon 313, 317, 374, 389  
European Committee for Electrotechnical Standardisation 56  
European Energy Performance of Buildings Directive 355  
European Regulation (EC) No. 842/2006 on certain F-Gases (e. g. HFCs)/ F-Gases Regulation 30-31, 162, 286  
European Union (EU) 8, 13-17, 28, 30, 43-50, 56, 58, 67-68, 77, 209, 237, 238, 269, 283-285, 340, 358, 362  
Evaporation temperature 81, 147-148, 151, 153, 168, 193-199, 245-260, 298, 299  
Evaporative condensers 177, 322  
Evaporative cooling 168, 291-296, 300, 322-323  
Expansion device 196, 201, 227  
Faculty of Mechanical Engineering, University “Sv. Kiril & Metodij” 390

F-Gas Regulation, see European Regulation (EC) No. 842/2006 on certain F-Gases (e. g. HFCs)  
**Flammability** 54, 58, 63, 74, 76, 95-109, 113, 128, 131, 132, 187, 207, 210, 219, 261, 310, 319, 325, 332, 347  
–, Ammonia 74, 76, 131, 319, 325  
–, Hydrocarbon 54, 58, 63, 95-109, 113, 128, 132, 187, 207, 210, 219, 261, 310, 332, 347  
Foam 8, 12, 14, 15, 30, 42, 43, 48, 49, 184, 225, 332  
Freezer 45, 67-68, 111, 170, 261, 263, 269, 271, 309, 313, 314, 316, 328, 332, 333, 334, 340, 351  
Gas Cooler 145-146, 148, 151, 153, 157, 287-301, 316  
German Association of the Automotive Industry 317  
GHG, see Greenhouse Gas  
**Global Warming** 7-9, 25, 29, 31, 42, 111, 161, 169, 178, 209, 238, 239, 245, 303, 306, 340, 355, 356, 358, 362  
– Potential (GWP) 13, 24-35, 39, 46-48, 55, 66, 71, 112, 128, 145, 161, 165, 171, 178, 179, 184, 187, 207, 209, 239, 240, 284, 303, 331, 332, 344, 349, 356, 358, 359, 362  
– Impact 356  
Gram Equipment 313  
Grasso GmbH 245, 246, 255, 259, 385  
Graz University 145  
Greenhouse Gas 7-9, 21-30, 43-50, 161, 162, 165, 173, 312, 313  
Greenpeace 32, 339-340, 356, 391  
Ground-Source Heat Pump 357  
GTZ Proklima 25, 37  
Güntner AG 273, 373  
Gustav Lorentzen Conference 122, 127, 159, 169, 220, 301, 337  
GWP, see Global Warming Potential  
Halons 14, 17  
Harmonised Standards 56  
HC, see Hydrocarbons  
HFCs, see Hydrochlorofluorocarbons  
Health and Safety Executive 108  
Health Risks, see Safety  
Heat Exchanger 64, 81, 143, 141, 143, 146, 151, 163-167, 193, 199, 218, 227, 264, 274, 277, 316, 324, 328, 329, 356 – 258  
Heat Pump 45, 49, 56, 64, 67, 68, 69,

93, 111, 131, 133, 137-144, 145-160, 185, 187-201, 211, 215, 220, 242, 269, 271, 310, 355, 357, 358, 360, 362

Heat Rejection 145, 146, 152, 157, 262, 284, 293, 323, 328, 329

Heat Transfer Fluid 64, 174

Heating 64, 66, 85, 137-144, 145-160, 169, 192, 194, 195, 199, 200, 358, 360

Heating capacity 137, 143, 146, 156, 192, 195, 200

HFCs, see Hydrofluorocarbons

HSE, see Health and Safety Executive

HTF, see Heat Transfer Fluid

Hydrocarbons (HCs) 8, 31-33, 48, 55, 78, 101, 111-112, 121-122, 127, 132, 137, 167, 187, 191, 192, 200, 209, 219, 225-235, 313, 331, 341, 343-354

**Hydrochlorofluorocarbons (HCFCs)** 8, 12-13, 15, 19, 21, 22, 25-35, 43-50, 55, 133, 137, 145, 161, 173, 185, 187, 200, 203-208, 209-220, 239, 261, 273, 331

– phase-out 8, 27, 30, 43, 44, 46, 47, 49, 50, 237-244, 314, 320

Hydrofluorocarbons (HFCs) 13, 21, 22, 25-35, 43-50, 55, 67, 74, 78, 133, 137, 139, 145, 154, 156, 157, 158, 161-162, 165, 167, 170-173

Ice bank 314-315

Ice cream cabinet 331-341

ICICI 39, 41

IEA, see International Energy Agency

IEC, International Electrotechnical Commission

IEEP, see Institute for European Environmental Policy

**Ignition** 65, 76-77, 95-110, 113-120, 132, 140, 214, 335

–, Prevention, see Safety

IIAR, see International Institute of Ammonia Refrigeration

IIE

IIR, see International Institute of Refrigeration

IKEA 340

ILO, see International Labour Organisation

Imperial College London 317

Indirect Distributed Condensing Units 174

Indirect Refrigeration Systems, see secondary system

Industrial Refrigeration 33, 41, 48, 133, 245, 257, 319, 377, 389, 390

Institute for European Environmental Policy 11, 369

Integral Systems 173

Intergovernmental Panel on Climate Change 7, 13, 15, 16, 23, 25, 28, 29, 35, 112, 178, 185, 239, 240, 313, 371, 375

Internal Plantroom 321

International Electrotechnical Commission (IEC) 56, 59, 60, 63, 65, 67-68, 167, 269, 271

International Electrochemical Commission (IEC) 209

International Energy Agency (IEA) 93, 160

International Environmental Agreements (IEA) 7, 8, 13, 16

International Institute of Ammonia Refrigeration (IIAR) 390

International Institute of Refrigeration (IIR) 127, 220, 330, 391

International Standardisation Organisation (ISO) 56

IPCC, see Intergovernmental Panel on Climate Change

ISO 5149: 1993 59, 67

ISO, see International Standardisation Organisation

Isobutane, see also Hydrocarbon 34, 111, 190, 199, 200, 261, 270, 333

Japan Air Conditioning, Heating & Refrigeration News 149

JARN, see Japan Air Conditioning, Heating & Refrigeration News

Johnson Controls 237, 303, 313, 315, 379

Karlsruhe University of Applied Sciences 161, 375

Karolinska Tekniska Högskola (KTH) 185, 381

Kyoto Protocol 7-9, 13, 15, 21, 25-35, 37-42, 46, 161, 239

LBP, see Low Back Pressure

LCCP, see Life Cycle Climate Performance

LCD, see Liquid Carbon Dioxide

LCWI, see Life Cycle Warming Impact

**Leak** 60-62, 65, 71, 95-110, 113, 162-171, 184, 210, 214, 238, 309-310, 320-330, 331-336, 346-347, 356, 361

–, Checking 45, 181, 286, 348

–, Catastrophic 60

–, Detector 141-143

–, Minimization 115

–, Stimulation 65

–, Tightness 47

Leakage 12, 31, 45, 47, 69-7981-83, 95-110, 113, 140, 173-184, 227, 228, 319, 335, 362

Legislative Barriers 333, 334

Life Cycle Climate Performance 178, 330

Life Cycle Warming Impact 178

Limits, refrigerant charge 59-62, 132, 210

Linde Group 382

Liquid Carbon Dioxide (LCD) 329

Lobbying 344, 362

Low Back Pressure (LBP) 261- 269

Low Pressure Receiver System 324

Low Temperature (Loop) 82, 85, 86, 138, 143, 163, 171, 174-181, 190, 195, 199, 207, 259, 264, 275, 288, 291, 297, 300, 304, 307, 308, 328

Low Voltage Directive 56, 67

Lubricating Oils 188

MAC, see Mobile Air Conditioning

Machinery Safety Directive 56, 67

Maintenance (of refrigeration equipment) 14, 47, 59, 67, 66, 82, 89, 97, 98, 107, 109, 113, 131, 162, 170, 181, 183, 184, 269, 282, 284, 322, 324, 326, 334, 337, 344, 348

Market Mechanisms 14, 31

MBP, see Medium Back Pressure

McDonald's 341

MDI, see Metered Dose Inhaler

Measures, EU 9, 14, 27, 30, 34, 43-50, 362

Mechanically Ventilated Enclosure 63

Medium Back Pressure (MBP) 261-268

Medium Temperature 86, 161, 163, 169, 171-177, 280, 290, 296, 299, 300, 304

Meeting of the Parties to the Montreal Protocol (MOP) 26

Metered Dose Inhaler 12

Methane 27, 76, 229, 232, 234, 283

Methanol 233, 234

Methyl Bromide 12-23

Methyl Bromide Technical Options Committee (MBTOC) 20

Middlesex University 357

Milk cooling units 203-205

MLF, see Multilateral Fund

Mobile Air Conditioning (MAC) 31, 33, 34, 82, 85, 111, 133

Montreal Protocol 1-3, 7-9, 11-23, 25-35, 43-50, 71, 208, 237-239, 283, 314, 369, 375, 376

MOP, see Meeting of the Parties to the Montreal Protocol

Multilateral Fund (MLF) 9, 11, 13, 14, 19, 20, 27, 29, 32, 375, 385

Multi-stage vapour compression cycles 127

Nat Energy Resources 343, 344, 346, 379

National Committee 57

National Environment Agency, Singapore 356

National Ozone Unit 19, 29

Nestlé 313, 314

NGO, see Non-Governmental-Organisation

NH<sub>3</sub>, see Ammonia

Nitrogen 38, 69, 77, 107, 127, 229, 231, 234, 235, 347, 361

Non-Governmental-Organisation 37

Non-Harmonised standards 37, 56

Non-HFC purchasing policy 332

Nordmilch 314-315

Normal Boiling Point 112, 129, 190, 232, 359

Norwich Union 317

NOU, see National Ozone Unit

Occupational Safety and Health Administration 84, 87

ODP, see Ozone Depleting Potential

ODS, see Ozone Depleting Substances

OECD, see Organisation for Economic Cooperation and Development

OEM, see Original Equipment Manufacturers

Olympics 32, 336, 372

Open flash tank cycle 288, 297, 300

Organisation for Economic Cooperation and Development (OECD) 40

Original Equipment Manufacturers 343

Overpressure, see also Pressure 85, 96, 104, 105, 114-120

Oxygen 76, 229-234

Ozone Depleting Potential 2, 12, 14, 17, 18, 30, 43, 49, 55, 66, 71, 81, 128, 130, 161, 165, 171, 187, 203, 209, 331, 332, 362

Ozone Depleting Substances 1, 7-9, 11, 28, 43, 45, 329

PDD, see Project Design Document

PED, see Pressure Equipment Directive

PepsiCo 348

Permissible Exposure Limit 84, 87

Perfluorocarbons (PFC) 13, 23, 25, 35, 43, 46, 58, 239

Pipe Size 132  
 Plantroom 111-122, 244, 321-329  
 Plastics 187, 188, 227  
 Plug-in units (system) 161, 167, 170, 171, 173, 269  
 PoA, see Programme of Activities  
 Political Framework 26-30  
 Potential Efficiency 128-129  
 Power Consumption 40, 41, 46, 204, 206, 207, 212, 213, 215, 216, 219, 228, 286, 315, 232, 349  
**Pressure**  
 – Difference 63, 213, 262, 263  
 – Drop 117, 120, 193, 196, 199, 218, 219, 240  
 – Equipment Directive 56, 67, 74, 77, 242, 269, 271  
 – Ratio 138, 165, 193-201, 216, 250, 256, 263, 264, 267, 268, 288  
 – Vapour 166, 188, 191, 229-233, 275  
 Process Cooling 246, 357, 384  
 Programme of Activities 42  
 Project Design Document 37-42  
 Propadiene, see Hydrocarbons  
 Propane, see also Hydrocarbons 33, 81, 111, 127, 132, 145, 155, 161, 167, 172, 187, 189, 190-201, 203-209, 210, 220, 225, 229, 230-231, 242, 244, 261-271, 310, 333, 334, 336  
 Propene, see also Hydrocarbons 76, 190, 195, 200  
  
 QRA, see Quantitative Risk Assessments  
 Quantitative Risk Assessments 219, 335  
  
 R&D, see Research and Development  
 R12, see Chlorofluorocarbons  
 R1270, see Hydrocarbons  
 R134a, see Hydrofluorocarbons  
 R22, see Hydrochlorofluorocarbons  
 R290, see Propane  
 R404a, see Hydrofluorocarbons  
 R600a, see Isobutane  
 R717, see Ammonia  
 R744, see Carbon Dioxide  
 Recovery 13-16, 30, 45-47, 66, 97, 106, 107, 115, 164, 169, 297, 304, 323, 347, 351  
**Refrigerant**  
 –, Availability 45, 343  
 –, Blend 31-33, 71, 73, 199, 319, 320, 323, 343, 359-362  
 –, Carbon Dioxide, see Carbon Dioxide  
 –, Charge 45, 59, 60, 63, 65, 66, 83, 85, 89, 95, 99, 101-102, 107-108, 112-114, 132, 161-171, 184, 210, 215, 268, 275, 310, 314, 347, 356  
 –, Circuits 59, 60, 66, 106, 211, 246  
 –, Comparison 71, 128-130, 190, 193, 198-199, 104, 106, 207, 208, 210, 240, 242, 244, 261-268, 275-281, 360  
 –, Contamination 226  
 –, Cost (per kg or per system charge) 128  
 –, Drop-in, see Drop-in  
 –, Handling 7, 48, 55, 59, 64, 66, 78, 95, 107, 113, 114, 119, 129, 132, 187, 270, 344, 357  
 –, Hydrocarbons (see Hydrocarbon)  
 –, Leaks (see Leakage)  
 –, Mass Flow 88, 102, 137, 192, 193, 197, 200, 240, 274, 295, 300  
 –, Pressure, see Pressure  
 –, Properties 2, 43, 70-71, 75, 78, 106, 128, 132, 137, 138, 140, 145, 154, 165, 188, 190-192, 201, 210, 219, 226-227, 235, 261, 275, 343, 356  
 –, Purity 225-235, 305, 312  
 –, Recovery, see Recovery  
 –, Release 63, 101, 103  
 –, Secondary 81, 86, 163, 317  
 –, Supply 343  
 –, Volatile 163, 232, 209, 307, 317  
 Refrigerants, Naturally! 341, 391  
 Refrigerating Capacity 71, 196, 246-254, 257-263, 274-277, 314, 360-361  
**Refrigeration**  
 – CDM 37-41  
 – Concepts 173  
 – Cycle 190, 193, 199, 211, 288, 361  
 Regulations 41-50, 56, 63, 67, 69, 74, 81, 95, 108, 137, 244, 309, 325, 355, 362, 369  
 Renewable Energy 162, 170, 245, 301, 307, 369  
 Research and Development 155, 315, 340, 351  
 Residential air conditioning, see Air Conditioning  
 Retail Refrigeration, application of natural refrigerations 3, 174, 283-286, 391  
 Retrofill 134  
 Retrofit 134, 151, 177, 184, 192-195, 204-208, 240-244, 340, 344, 346  
 Rooftop 321, 325-327, 346  
  
 SAC, see Stationary Air Conditioning  
 Sachsenmilch AG 315  
 Safe Design 63, 67  
 Safe Plantrooms 111-122, 244, 321-329

Safeguarding the Ozone Layer and Climate Change, Special Report by the IPCC/TEAP 13, 15, 50  
**Safety** 53-124  
 –, Ammonia 69-80  
 –, CO<sub>2</sub> 81-94  
 –, Hydrocarbon 94-124  
 Saturation Pressure 190, 202, 233, 275, 359  
 SCC, see Stress Corrosion Cracking  
 Screw Compressor, see compressor  
 Secondary Cooling Circuit  
 Secondary Refrigerant, see refrigerant, secondary  
 Secondary System 81, 129, 131, 132, 134, 163, 165, 167, 173-185  
 Servicing 2, 14, 21, 31, 45, 47, 59, 67, 76, 95-97, 106-108, 181-183, 187, 270, 283-284, 332, 335, 338, 344, 347, 348, 370  
 Singapore 343-353, 379  
 Single-Stage Compression 246, 250, 254, 256, 257, 260, 287, 288, 360  
 SINTEF Energy Research 137, 145, 156, 392  
 Solvents 8, 14, 43, 225  
 Standards on Natural Refrigerants 55-68  
 Star Refrigeration 316, 317, 319, 380  
 Stationary Air Conditioning, see Air Conditioning  
 STEK, see Association for the Recognition of Refrigeration  
 STOC, see UNEP Solvents Technical Options Committee  
 Stress Corrosion Cracking (SCC) 233-234  
 Subcooling 196, 324, 358  
 Sub-critical Cycle 311  
 Sulphur 161, 230, 233, 234, 310, 343  
 Superheat 138, 143, 151, 168, 194, 197, 198, 201, 254, 278, 280, 288, 299, 323, 324, 331  
 Supermarket Plant 303-312  
 Supermarket Refrigeration 81-83, 161-172, 173-186, 303-312, 313-317, 381  
 Supplier Interaction 337  
 Supplier Refrigerant 225, 343  
 Sweden 72-73, 75, 81, 83, 86, 149, 163, 165, 170, 228, 285, 307, 372, 376, 381  
  
 TCCC, see The Coca Cola Company  
 TD, see Temperature Difference  
 Technical Committee 55, 57, 370, 380, 381  
 Temperature Difference 81, 199, 274, 277, 278, 280, 337

Temperature Conditions (ambient temperature) 111, 114, 119, 141, 150, 151, 167, 176, 177, 194, 234, 261-271, 285-291, 304, 311, 312, 316, 359-361  
 Testing, see Leak Testing  
 TEWI, see Total Equivalent Warming Impact  
 The Coca-Cola Company 340  
 Third Assessment Report 35  
 Threshold Limit Value 84  
 Total Equivalent Warming Impact 178, 184, 240, 210, 303-307  
 Toxicity 59, 74, 76, 83, 84, 90, 95, 113, 128, 129, 131, 132, 143, 226, 235, 319, 362  
 Training, Technicians 78, 98, 106, 109, 128, 131, 244, 334, 338, 343-344  
 Transcritical CO<sub>2</sub> systems 284, 285  
 Transcritical Cycle 190, 287, 298  
 Transport 210, 335  
 Tripoli 294-296  
 Trox AITCS 316, 317  
 Two-stage compression 246, 254, 257, 260, 288, 289, 290, 297, 298, 300  
  
 UBA, see Umweltbundesamt  
 Umweltbundesamt (UBA) see 43, 48, 369  
 Underground Thermal Energy Storage 143  
 Underwriters Laboratories 209  
 UNEP, see United Nations Environment Programme  
 – Refrigeration, Air Conditioning and Heat Pumps Technical Options Committee (RTOC)  
 – Technical Options Committee (TOC) 16, 370, 383  
 – Technology and Economic Assessment Panel (TEAP) 13, 15, 16, 20, 23, 25-29, 178, 185, 375  
 UNFCCC, see United Nations Framework Convention on Climate Change  
 Unilever 331-341  
 United Kingdom 58, 322, 331  
 United Nations Environment Programme (UNEP) 14, 17-20, 25, 29, 38, 173, 340, 362, 375, 382, 383  
 United Nations Framework Convention on Climate Change (UNFCCC) 13-14, 21, 27-29, 37, 46  
 United States 13, 16, 17, 20, 21, 27, 34  
 Upper Flammability Limit 101  
 US, see United States  
 – Environmental Protection Agency

Vacuum pumps 107  
 Ventilation 69, 63, 76-77, 82, 84, 87, 88,  
 90, 95, 101, 106-107, 115, 131, 138,  
 140, 141, 143, 150, 157, 158, 296,  
 322, 325, 326, 335, 346, 347  
 Venting 14, 111, 116, 119, 325  
 Very Environmentally Friendly (VEF)  
 355, 357  
 Volumetric Efficiency 193, 194, 267  
 Volumetric Energy Consumption 195-  
 199  
 Voluntary Agreements 14, 26, 30, 32, 34

### Water

– Chillers 111, 113, 319-330  
 – Consumption 287-301  
 – Heating 140, 145-159  
 World Meteorological Organisations  
 (WMO) 12, 35  
 World Banks' Chiller CDM 37-41  
 World Trade Organization (WTO) 28

## Acronyms and Abbreviations

ABS	Acrylonitrile Butadiene Styrene	DOT	Design Outdoor Temperature
AC	Air Conditioning	DX	Direct Expansion
ACRIB	Air-Conditioning and Refrigeration Industry Board	EC	European Commission
ADR	Annual Death Rate	EE	Energy Efficiency
AM	Approved Methodology	EER	Energy Efficiency Ratio
AREP	Alternative Refrigerant Evaluation Program	EN	European Standards
ARI	Air-Conditioning and Refrigeration Institute	EOL	End-of-life
ASHRAE	American Society of Heating, Refrigerating and Air-Conditioning Engineers	EPA	Environmental Protection Agency
ATES	Aquifer Thermal Energy Storage	EPBD	European Energy Performance of Buildings Directive
ATEX	ATmospheric EXplosible	EPS	Expanded polystyrene
BA	Blowing agent	ERG	Energy Resources Group
BAU	Business As Usual	ERPA	Emission Reduction Purchase Agreement
BIT	Bandung Institute of Technology	ESCO	Energy Service Company
CDM	Clean Development Mechanism	EU	European Union
CEITs	Countries with Economies in Transition	FAO	Food and Agriculture Organization of the United Nations
CEN	Comité Européen de Normalisation/European Committee for Standardisation	F-gases	Fluorinated gases
CENELEC	European Committee for Electrotechnical Standardisation	GDP	Gross Domestic Product
CER	Certified Emission Reductions	GEF	Global Environment Facility
CFCs	Chlorofluorocarbons	GEIA	Global Emissions Inventory Activity
CHCP	Combined heating, cooling and power generation	GHG	Greenhouse Gas
CHPS	Chiller and Heat Pump System	GSHP	Ground-Source Heat Pump
CO <sub>2</sub>	Carbon Dioxide	GTZ	Deutsche Gesellschaft für Technische Zusammenarbeit GmbH (German Technical Cooperation)
CO <sub>2</sub> e	CO <sub>2</sub> -equivalent	GWP	Global Warming Potential
COP	Conference Of the Parties	HCs	Hydrocarbons
COP	Conference of the Parties	HCFCs	Hydrochlorofluorocarbons
COP	Coefficient of Performance	HFCs	Hydrofluorocarbons
CPU	Central processing unit	HPWS	Heat Pump Water Heaters
CTC	Carbon Tetrachloride	HSE	Health and Safety Executive
CUE	Critical Use Exemptions	HTF	Heat Transfer Fluid
DBT	Dry bulb temperature	IEA	International Energy Agency
DC	Developing Countries	IEC	International Electrotechnical Commission
DETR	Department of the Environment, Transport and the Regions of the UK	IEC	International Electrochemical Commission
DHW	Domestic Hot Water Heating	IEEP	Institute for European Environmental Policy
DKV	Deutscher Kälte- und Klimatechnik Verein (German Association of Refrigeration and Air Conditioning Technology)	IIR	International Institute of Refrigeration
DNA	Designated National Authority	ILO	International Labour Organisation
DOE	Designated Operational Entity	IPCC	Intergovernmental Panel on Climate Change
		IPCC AR4	4 <sup>th</sup> Assessment Report
		ISO	International Standardisation

	Organisation	SCC	Stress Corrosion Cracking
JARN	Japan Air Conditioning, Heating & Refrigeration News	SCDF	Singapore Civil Defense Force
JI	Joint Implementation	SF6	Sulfur Hexafluoride
kW	KiloWatt	SMEs	Small and Medium Enterprises
LBP	Low Back Pressure	SO <sub>2</sub>	Sulfur Dioxide
LCA	Life Cycle Assessment	SROC	Safeguarding the Ozone Layer and Climate Change, Special Report by the IPCC/TEAP
LCCP	Life Cycle Climate Performance	STEK	Association for the Recognition of Refrigeration
LCD	Liquid Carbon Dioxide	STOC	UNEP Solvents Technical Options Committee
LCWI	Life Cycle Warming Impact	TAR	IPCC Third Assessment Report
LT	Low Temperature	TC	Technical Committee
LVD	Low Voltage Directive	TCCC	The Coca Cola Company
MAC	Mobile Air Conditioning	TD	Temperature Difference
MB	Methyl Bromide	TEAP	Technology and Economic Assessment Panel
MBP	Medium Back Pressure	TEWI	Total Equivalent Warming Impact
MBTOC	Methyl Bromide Technical Options Committee	TLV	Threshold Limit Value
MDI	Metered Dose Inhaler	UFL	Upper Flammability Limit
MLF	Multilateral Fund	UK	United Kingdom
MOP	Meeting of the Parties	UL	Underwriters Laboratories
MSD	Machinery Safety Directive	UN	United Nations
MT	Medium Temperature	UN-ECE	United Nations Economic Commission for Europe
MVE	Mechanically Ventilated Enclosure	UNEP	United Nations Environment Programme
N <sub>2</sub> O	Nitrous Oxide	UNEP-DTIE	UNEP Division of Technology, Industry, and Economics
NASA	National Aeronautics and Space Administration	UNEP-RTOC	UNEP Refrigeration, Air Conditioning and Heat Pumps Technical Options Committee
NBP	Normal Boiling Point	UNEP-TOC	UNEP Technical Options Committee
NC	National Committee	UNFCCC	United Nations Framework Convention on Climate Change
NCEP	National Centres for Environmental Prediction	US	United States
NEA	National Environment Agency	US EPA	US Environmental Protection Agency
NGO	Non Governmental Organisation	US FDA	US Food and Drug Administration
NH <sub>3</sub>	Ammonia	UTES	Underground Thermal Energy Storage
NOU	National Ozone Unit	UV	Ultraviolet
NOx	Nitrogen Oxides	VDA	German Association of the Automotive Industry
NPV	Net Present Value	VEF	Very Environmentally Friendly
ODP	Ozone Depleting Potential	WBT	Wet bulb temperature
ODS	Ozone Depleting Substances	WG	Working Group
OECD	Organisation for Economic Co-operation and Development	WHO	World Health Organisation
OEM	Original Equipment Manufacturers	WMO	World Meteorological Organisations
OSHA	Occupational Safety and Health Administration	WTO	World Trade Organization
PDD	Project Design Document		
PED	Pressure Equipment Directive		
PEL	Permissible Exposure Limit		
PFC	Perfluorocarbons		
PoA	Programme of Activities		
QPS	Quarantine and Pre-Shipments		
QRA	Quantitative Risk Assessments		
R&D	Research and Development		
RAC	Refrigeration and Air Conditioning		
RACE	Refrigeration and Air Conditioning Equipment		
SAC	Stationary Air Conditioning		

The replacement of R22 in the commercial and industrial refrigeration and air conditioning sector poses a big challenge for developing countries when designing and implementing the accelerated HCFC phase-out. This collection of articles was compiled to highlight that natural refrigerants may be applied in various systems which previously used R22 and that they have proven to be energy-efficient, economically feasible and environmentally friendly replacements to HCFCs.

The handbook contains 31 articles by individual authors covering the following issues: policies and legislation on F-gases and related issues (Part 1), safety concerns and means to overcome (Part 2), a technical assessment of natural refrigerants in different applications (air conditioning, commercial and industrial refrigeration and heat pumps) (Part 3), and case studies by manufacturers and end-users providing insights into market developments and examples of successful conversions to natural refrigerants (Part 4).

Deutsche Gesellschaft für  
Technische Zusammenarbeit (GTZ) GmbH

– German Technical Cooperation –

Programme Proklima

Dag-Hammarskjöld-Weg 1-5

65760 Eschborn

T + 49 6196 79 - 0

F + 49 6196 79 - 6318

E [proklima@gtz.de](mailto:proklima@gtz.de)

I [www.gtz.de/proklima](http://www.gtz.de/proklima)

