

Novel Measurements of Volatility- and Polarity-Separated Organic Aerosol Composition and Associated Hygroscopicity to Investigate the Influence of Mixed Anthropogenic-Biogenic Emissions on Atmospheric Aging Processes

Brent J. Williams

Washington University in St. Louis

Department of Energy, Environmental and Chemical Engineering

U. Colorado – Boulder and CIRES (Jimenez)

U. California – Berkeley (**Goldstein**)

Aerosol Dynamics Inc. (Berkeley, CA)

Aerodyne Research Inc. (Billerica, MA)

U. Minnesota (**Millet**)

Georgia Tech (**Ng**, Weber)

Penn State University (Brune)

WashU (Turner)

Acknowledgements: Participating Lab Members

PhD

Dhruv Mitroo

Chris Oxford

Michael Walker

Raul Martinez

Yaping Zhang

Claire Fortenberry



Research Scientist: Munkhbayar Baasandorj

Masters: Xiaochen Zuo, Mayura Patankar

Undergrads: Hagan, Dhawan, Geyer, Streff, Sussman, Wilcosky

Motivation

- Atmospheric primary and secondary organic gases and particles originate from biogenic and anthropogenic emissions, and bio/anthro interactions have been observed to alter production of secondary organic aerosol (SOA).
- Impacts health and climate
- *Uncertainty remains in determining sources and evolution of organic aerosol (OA)
- *There is a need for improved chemical characterization of complex OA composition
- *We want manageable parameterizations of this chemistry to enable modeling of complex atmospheric OA (mixture can contain tens of thousands of compounds). Approach through novel data analysis methods and new measurement techniques.

Oxidative Evolution of Organic Material in Atmosphere

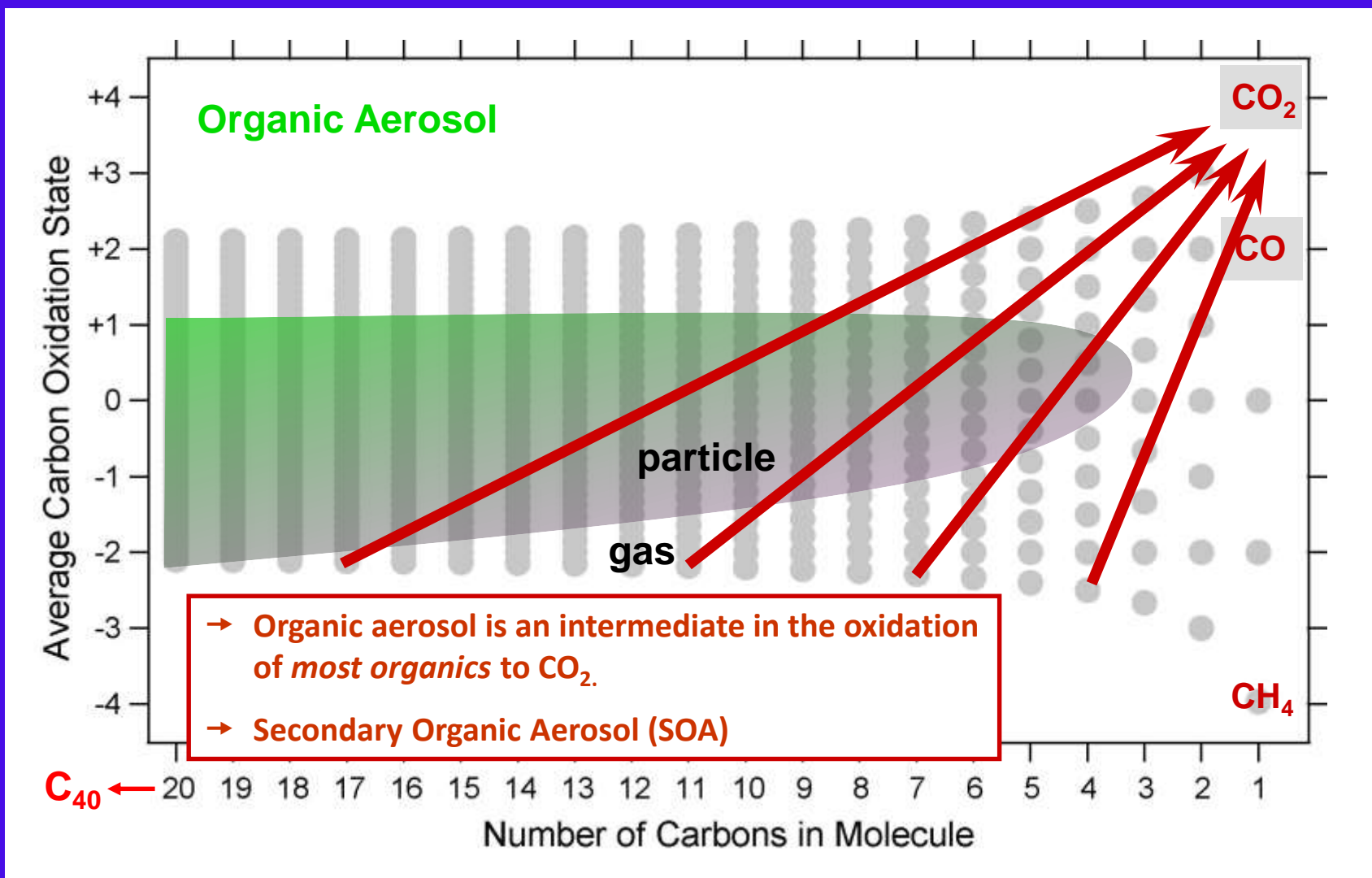

Oxidative Evolution of Organic Material in Atmosphere

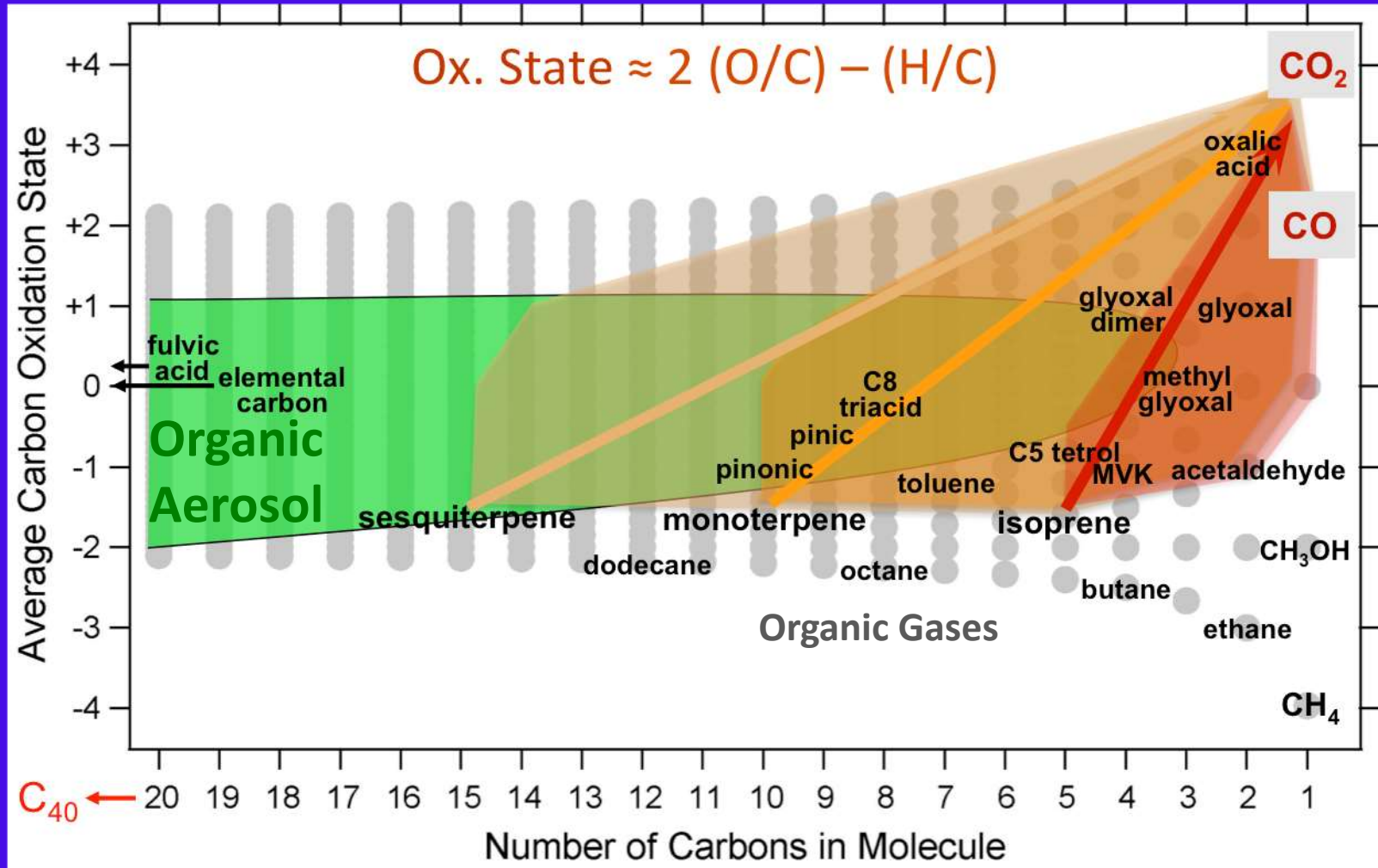

- A small molecule like isoprene (C5) only crosses edge of the condensed phase
- More likely for larger molecules (e.g., C10, C15) to cross through condensed phase
- Aerosol Yield from smaller molecules may be very sensitive to altered reaction paths

Our goal is to contribute to a better understanding of the anthropogenic enhancement of biogenic SOA production

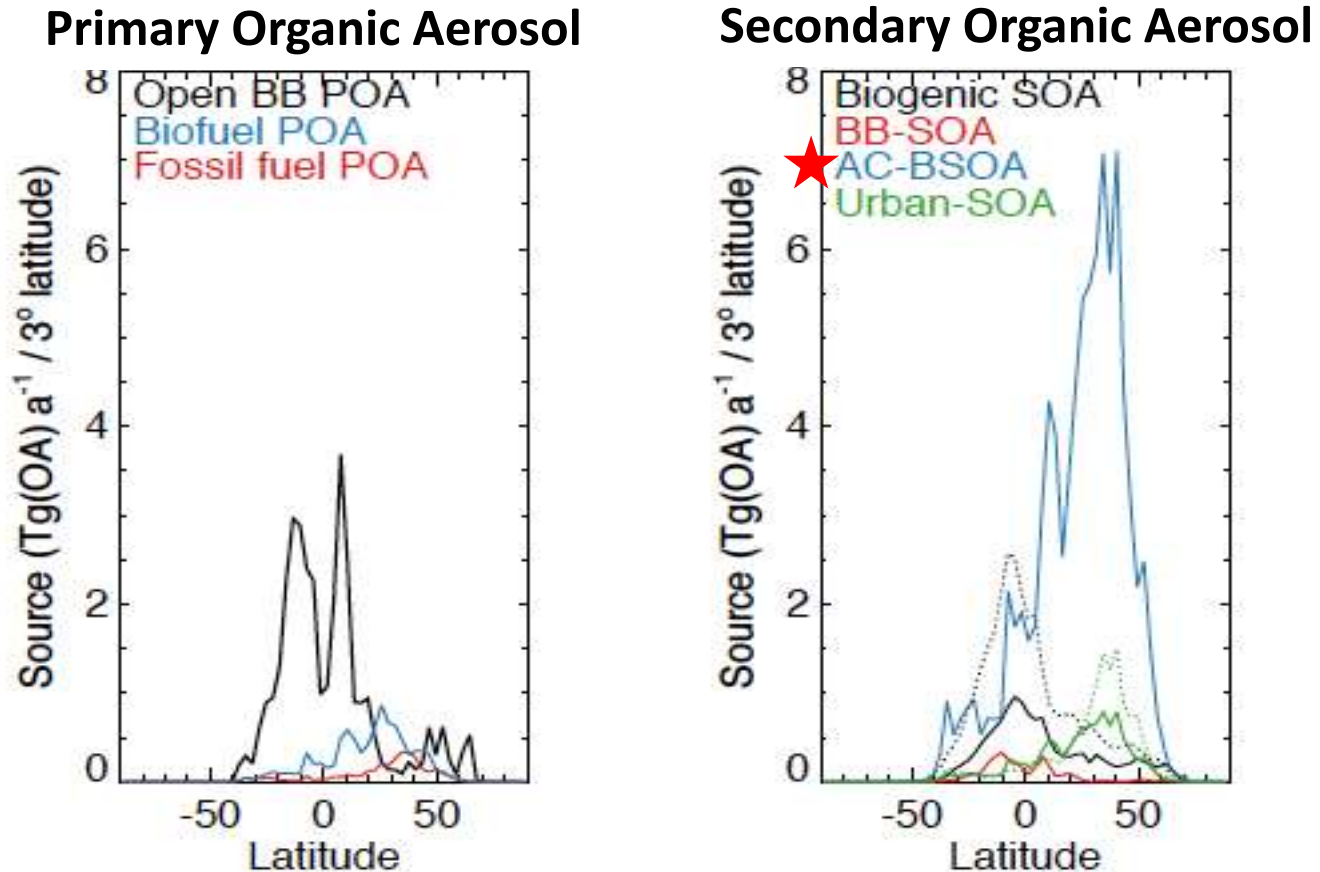
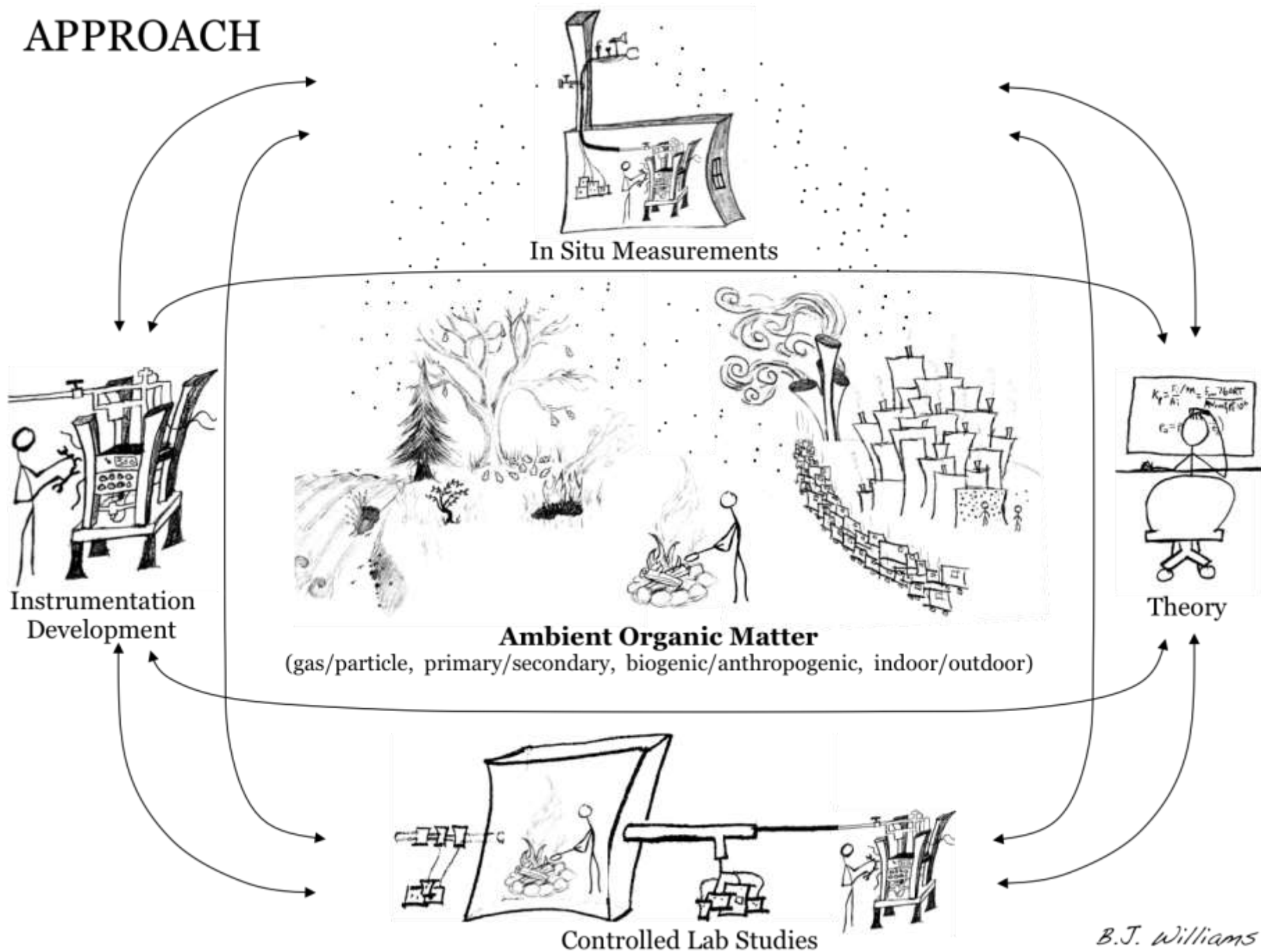

Fig. 11. Estimated zonal mean distribution of (a) POA and (b) SOA sources: biomass burning (BB-SOA); anthropogenically controlled biogenic SOA (AC-BSOA). Sources of SOA estimated in this work (solid lines) are plotted for comparison against sources estimated by de Gouw and Jimenez (2009) (dotted lines). POA emissions in the two studies are identical.

APPROACH



B.J. Williams

OUTLINE

- **Instrument Development**
- **Novel Data Analysis Methods**
- **Field observations: SOAS – Centreville, AL**
- **Field observations: SLAQRS – East St. Louis, IL**
- **Laboratory-based oxidation studies**
- **Conclusions**

Our methods for *In-Situ* Organic Aerosol Chemical Characterization

Aerosol Mass Spectrometer (AMS)

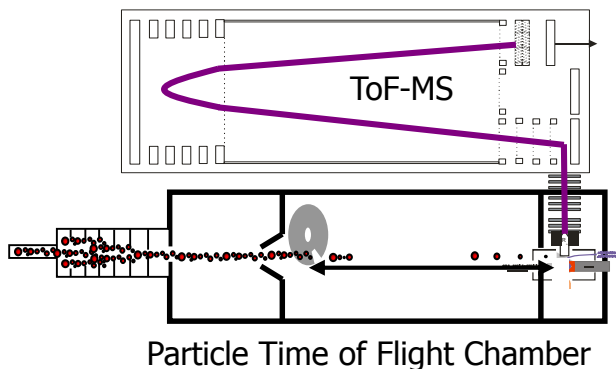

High Resolution MS

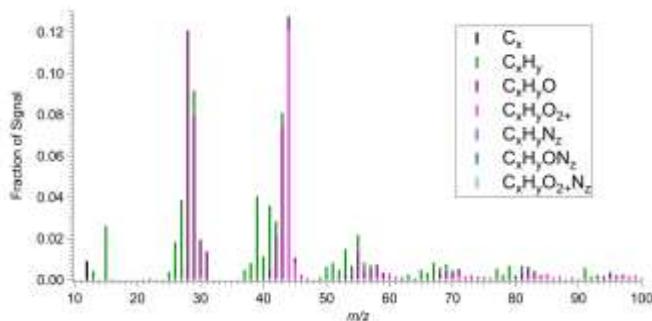

Displaying Organic Ions Only

Canagaratna et al, MS Reviews 2007

Thermal desorption Aerosol Gas chromatograph (TAG)

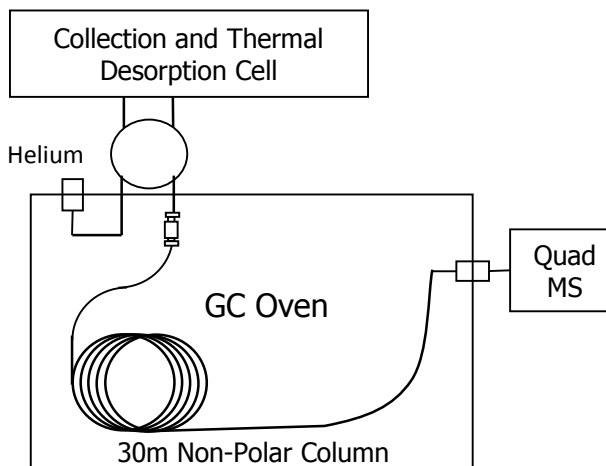

Chromatography-Separated MS

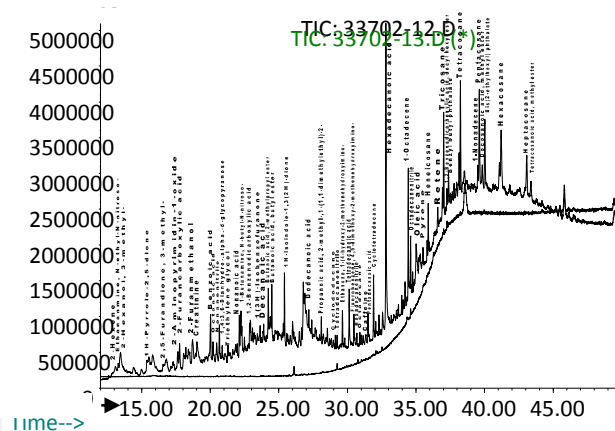

Williams et al, AS&T 2006
Goldstein et al, J.ChromA 2008

Volatility and Polarity Separator (VAPS)

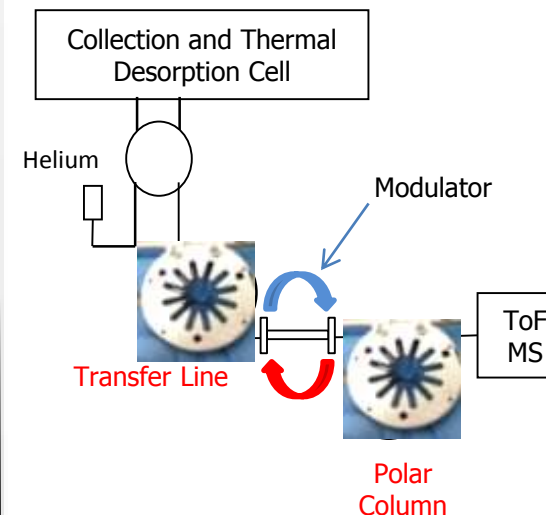

Vol. & Pol.- Separated MS

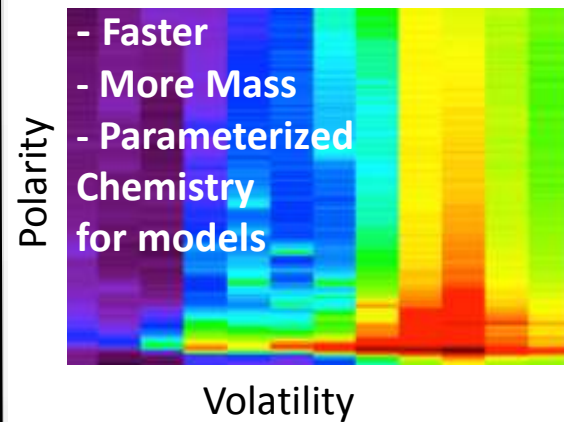

Martinez et al, AS&T 2016

Organic Aerosol Analysis in Perspective

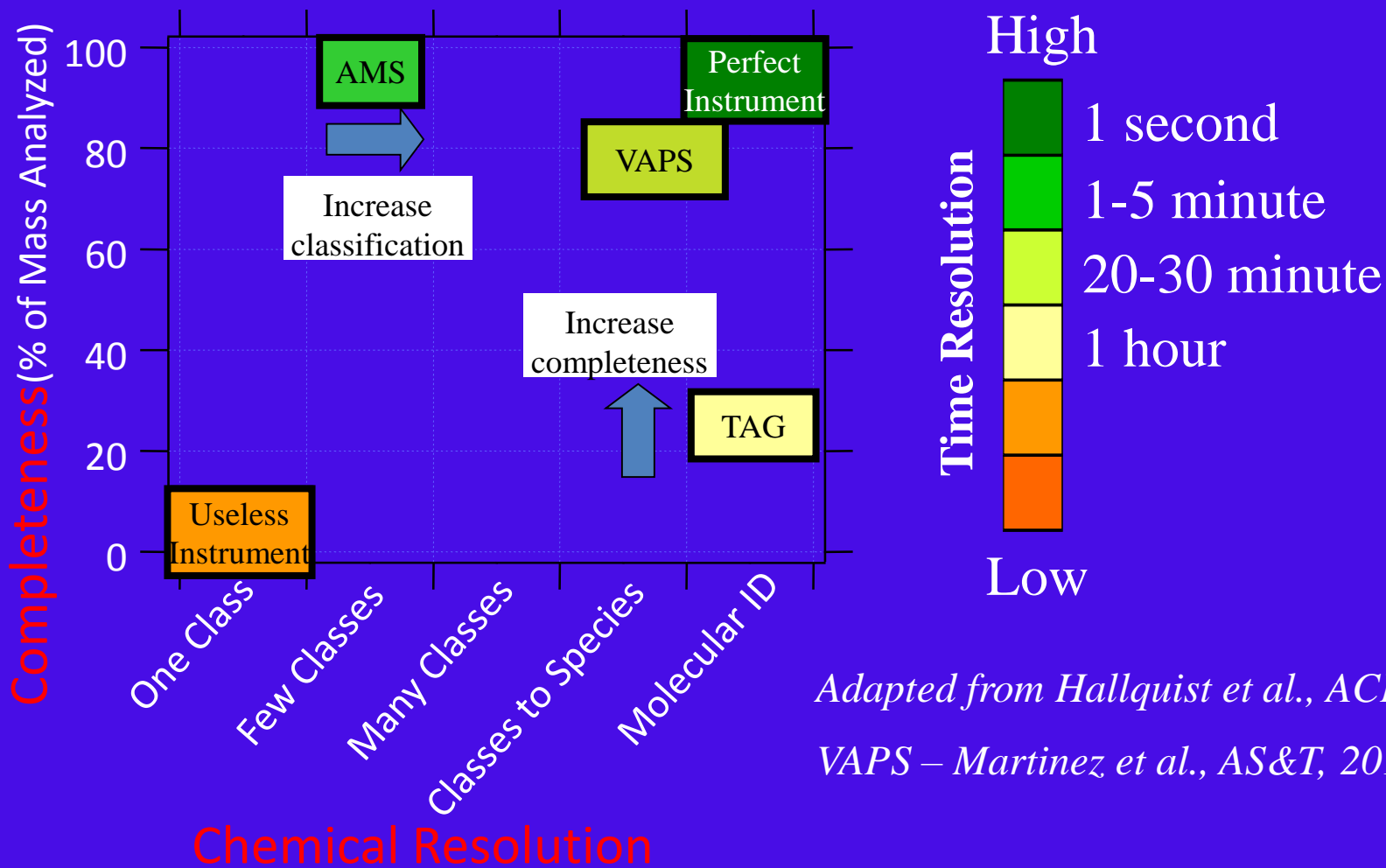

Adapted from Hallquist et al., ACP, 2009

VAPS – Martinez et al., AS&T, 2016

Aerodyne Research Inc. (US-DOE – SBIR, Phases I, II): Volatility and polarity separated total organic aerosol using thermal desorption modulated chromatography

In-Situ Measurements

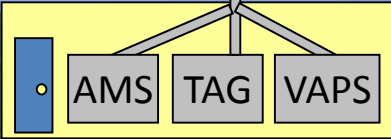
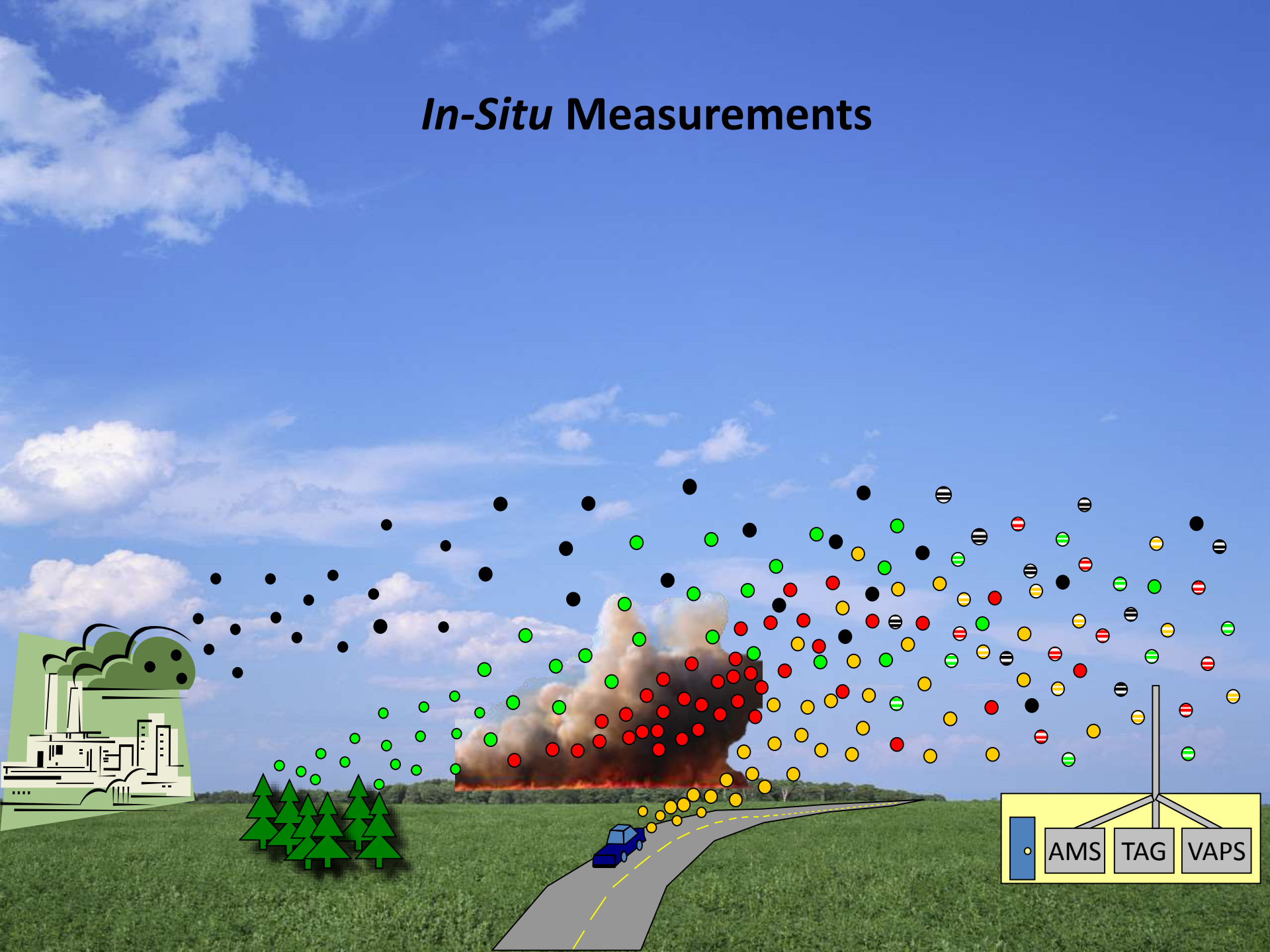

In-Situ Measurements

Sample and separate using complementary techniques:

AMS (Mass Spec. of organic and inorganic components)

VAPS (organic components with additional chemical separation)

TAG (individual organic "marker" compounds)

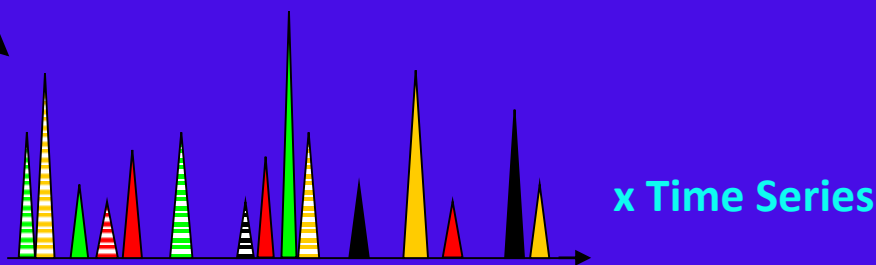

Group covarying chemical signals:

Positive Matrix Factorization (PMF)

Match to known source profiles

Factors can also represent atmospheric transformation processes

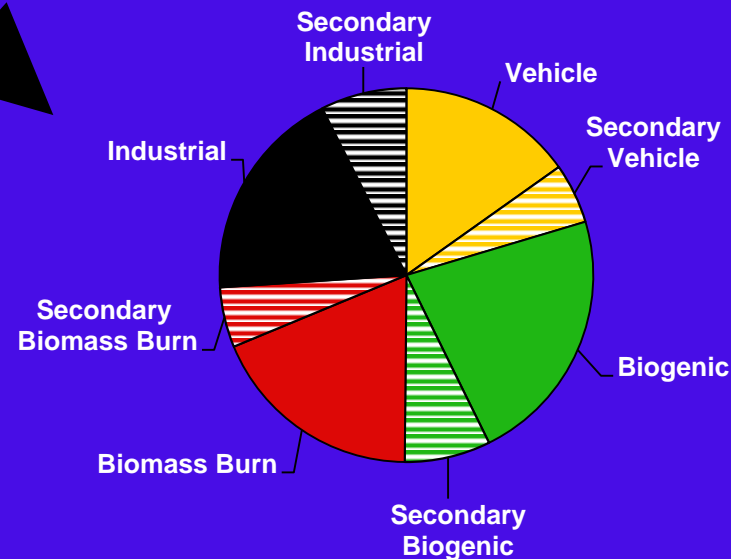

OUTLINE

- Instrument Development
- Novel Data Analysis Methods
- Field observations: SOAS – Centreville, AL
- Field observations: SLAQRS – East St. Louis, IL
- Laboratory-based oxidation studies
- Conclusions

New binning method developed to directly insert a collection of TAG chromatograms or VAPS “vapograms” into PMF.

- Saves from having to integrate individual compounds
- Incorporates the unresolved complex mixture (UCM)

Chromatogram

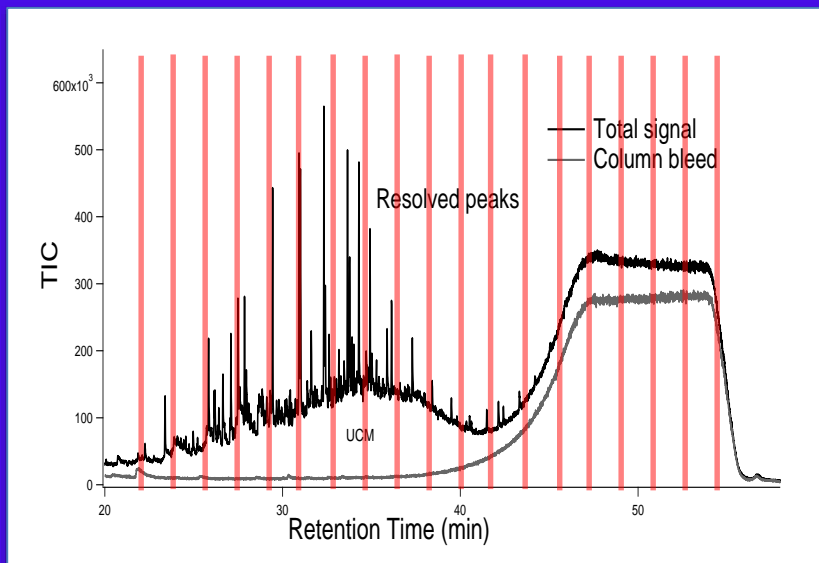

“Vapogram”

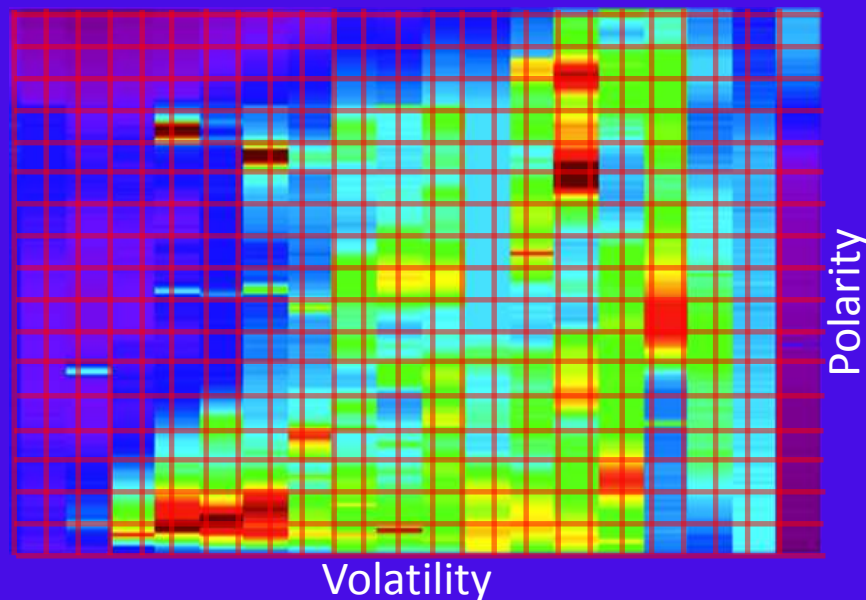

Bin size determines degree of chemical resolution

Binned PMF data matrix can be arranged to separate for:

- 1) Major chromatogram components (e.g., compounds with similar mass spectral features or functionality)

Chromatogram Deconvolution PMF

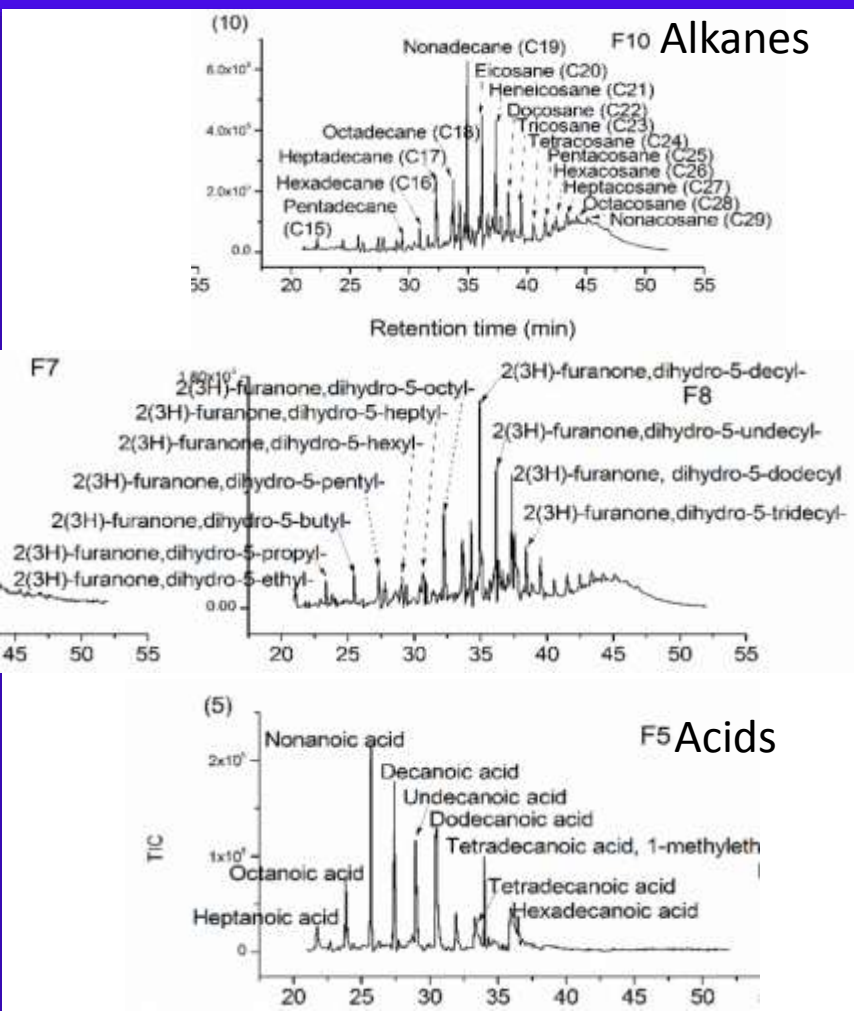

- 2) Major study-time components (e.g., Sources or Transformations)

Source Apportionment PMF

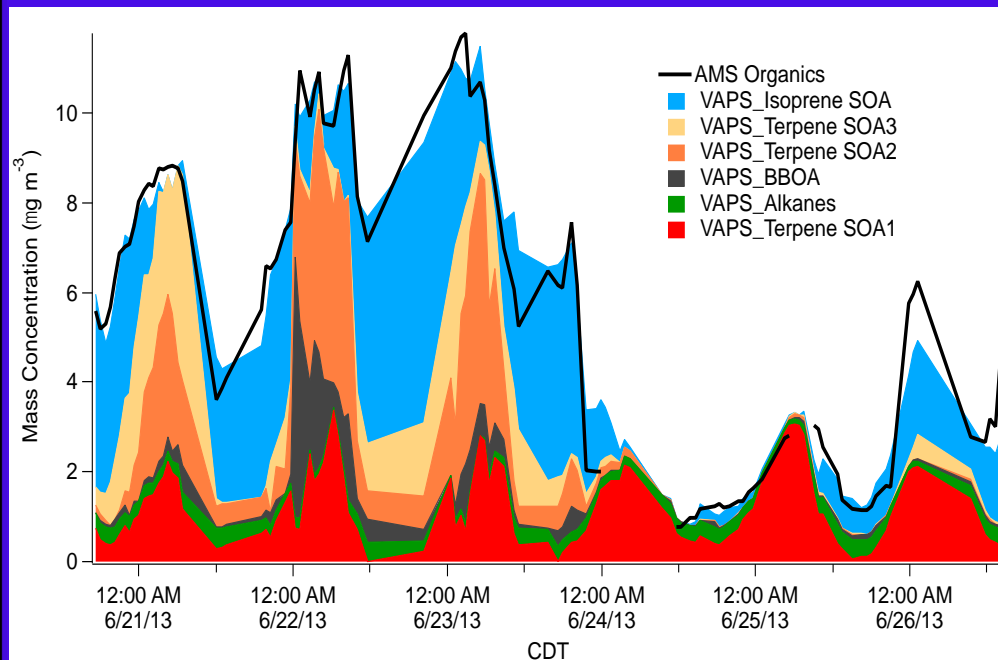

OUTLINE

- Instrument Development
- Novel Data Analysis Methods
- Field observations: SOAS – Centreville, AL
- Field observations: SLAQRS – East St. Louis, IL
- Laboratory-based oxidation studies
- Conclusions

Observations from two recent field studies



Modeled Isoprene Emissions

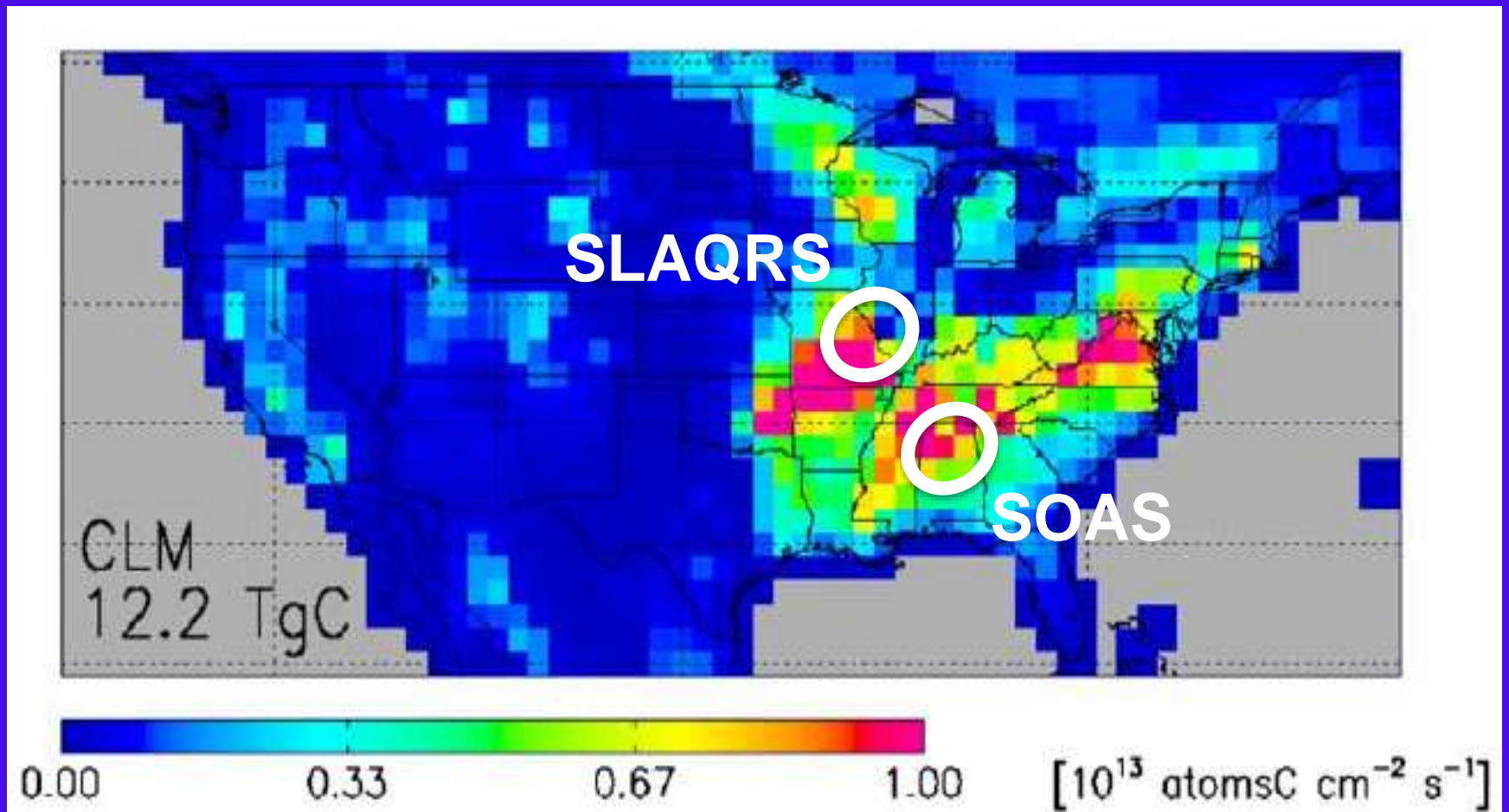

Millet et al. (2008)

Now known that isoprene can produce SOA....

Formation of Isoprene SOA

(anthropogenic influences)

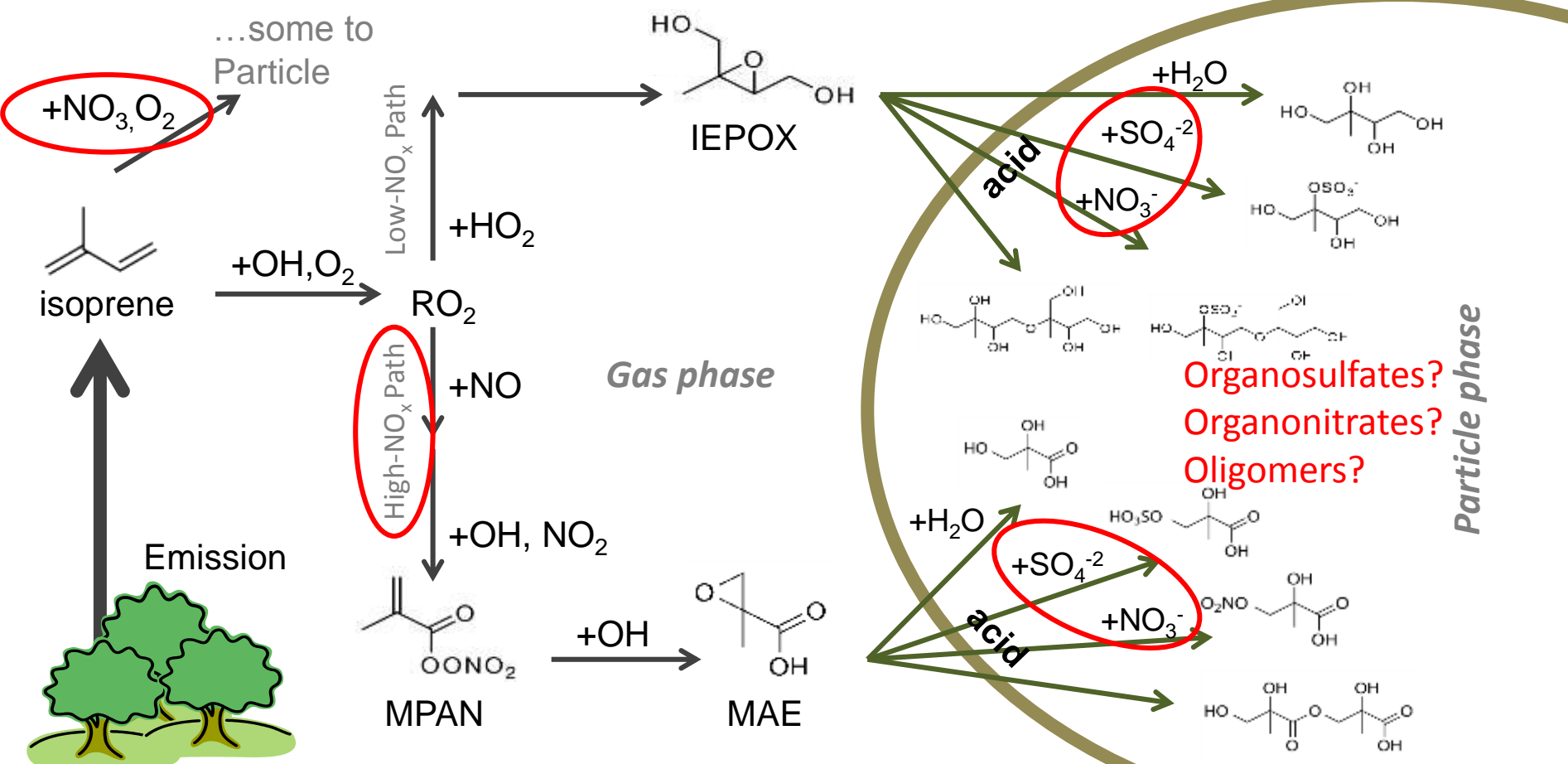

Figure from Surratt et al.

Biogenic carbon and anthropogenic pollutants combine to form a cooling haze over the southeastern United States

Allen H. Goldstein¹, Charles D. Koven², Colette L. Heald³, and Inez Y. Fung¹

Department of Environmental Science, Policy, and Management, University of California, Berkeley, CA 94720

Contributed by Inez Y. Fung, April 15, 2009 (sent for review July 28, 2008)

Goldstein, Fung, et al, 2009
(satellite observations)

Alabama ground site (**SOAS**)

East St. Louis (**SLAQRS**)

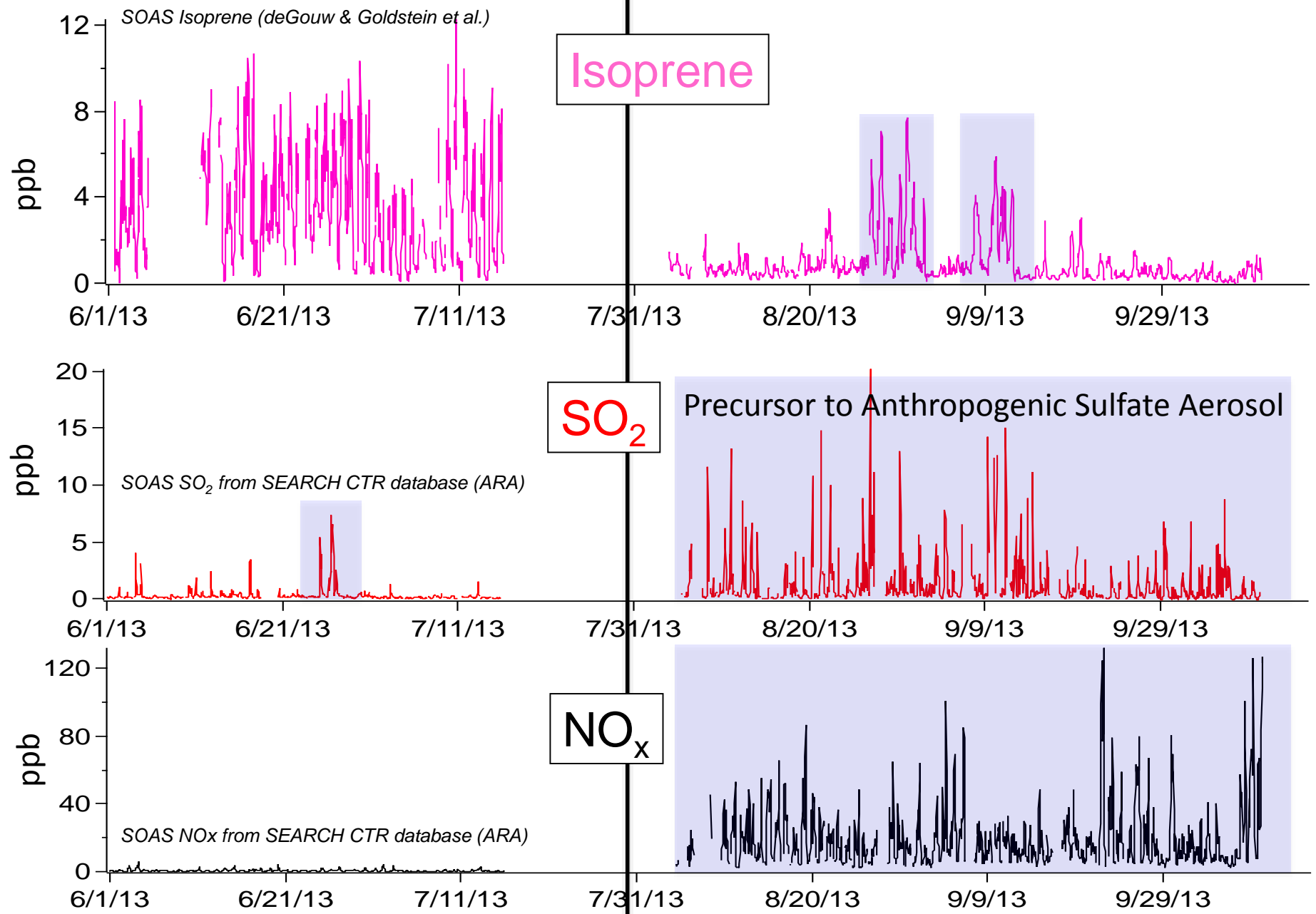

AMS Factors from SOAS

Xu et al., PNAS, 2015

AS PNAS PNAS

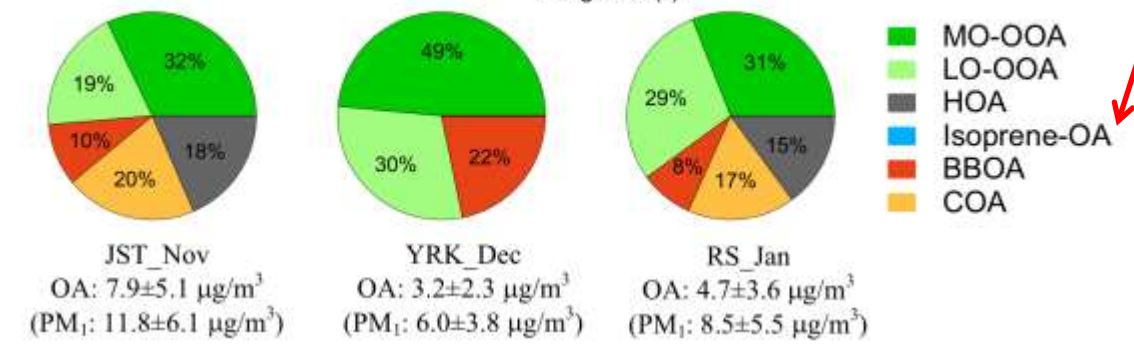
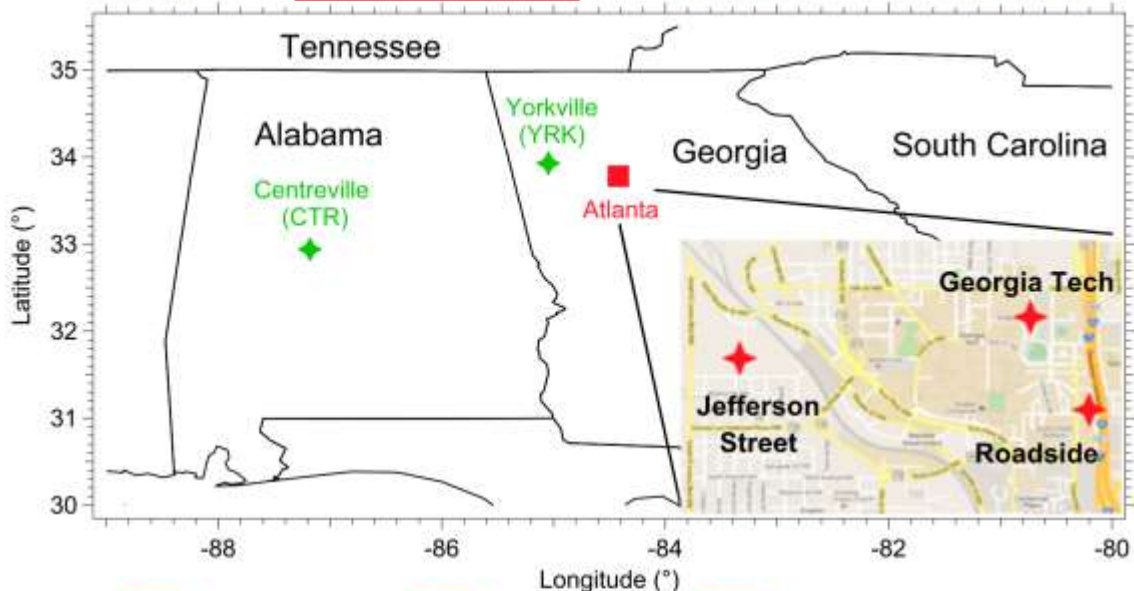
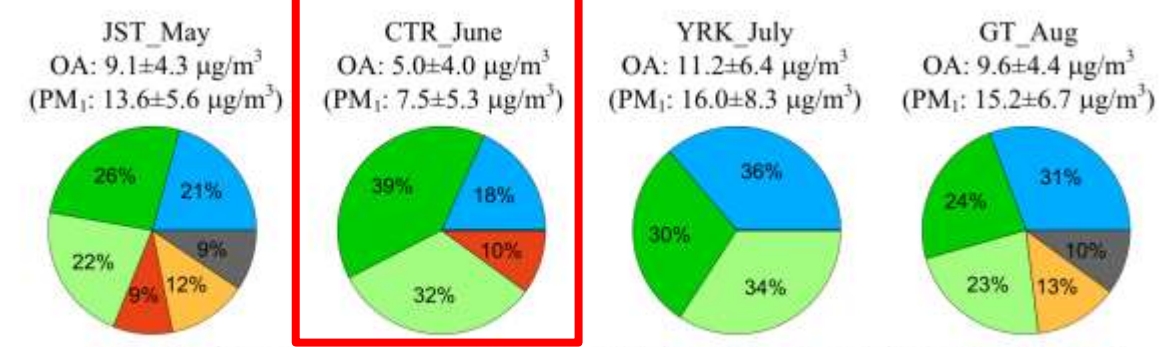

AMS only finds 1 type of isoprene SOA, although there are various formation pathways. AMS may not easily differentiate.

Some lab evidence showing LO-OOA may be terpene SOA.

Can VAPS offer more information?

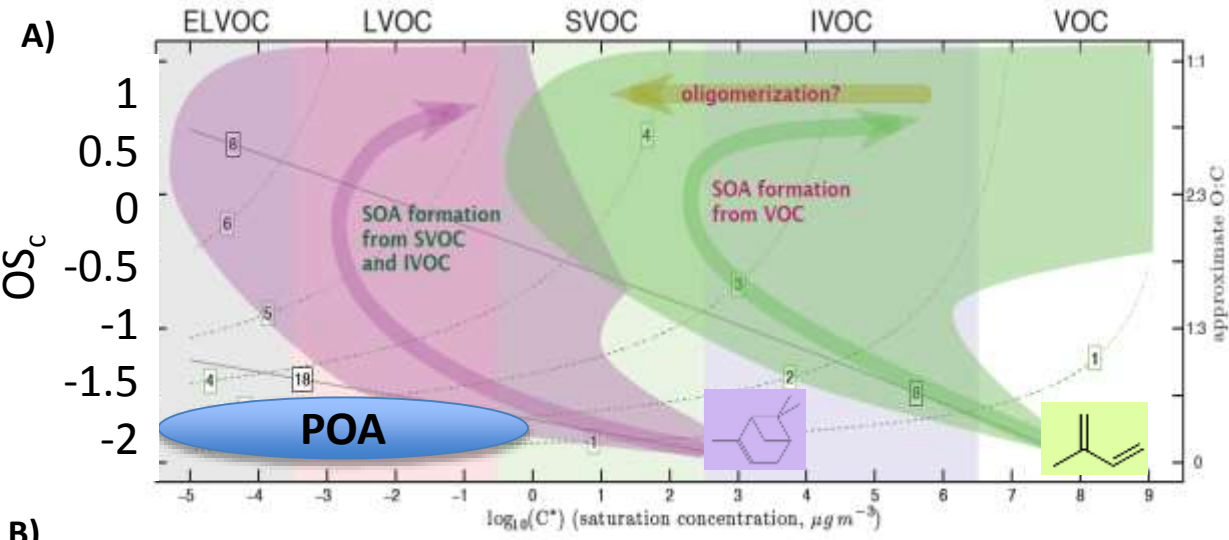

2D-VBS Oxidation pathways
(Donahue et al., ACPD 2012)

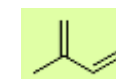

C_5H_8 Isoprene



$\text{C}_{10}\text{H}_{16}$ Terpenes

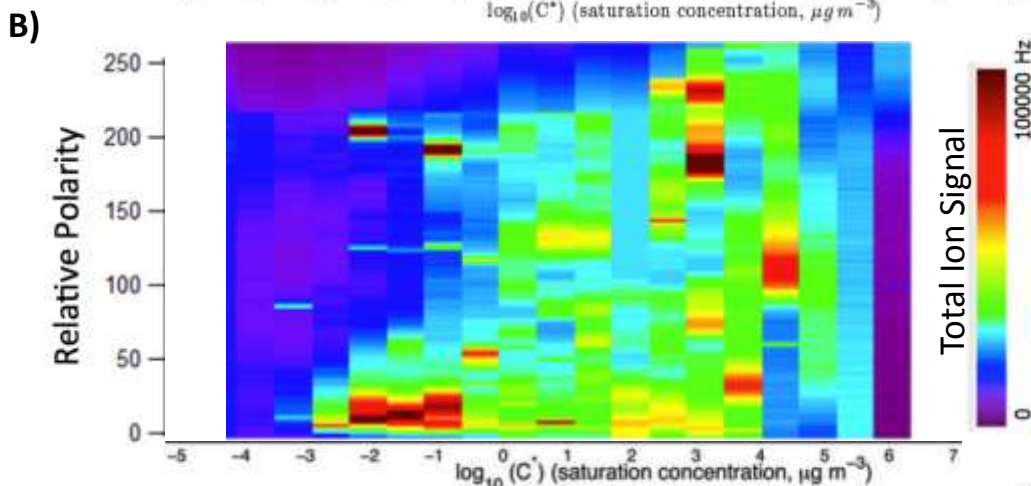

First Field deployments for VAPS

VAPS - SOAS

Rural Alabama

(lots of Isoprene and Terpene SOA)

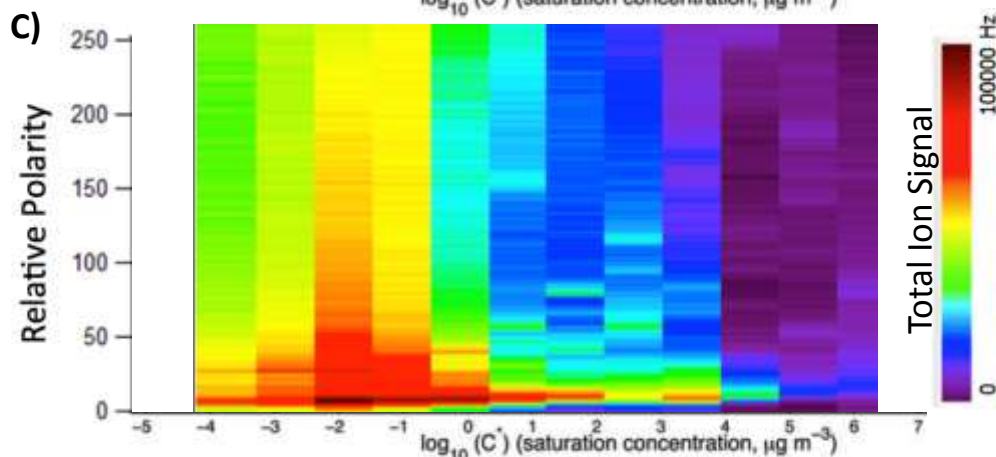

VAPS - SLAQRS

Urban St. Louis (more POA)

Chromatogram Deconvolution PMF on Binned VAPS Data (SOAS)

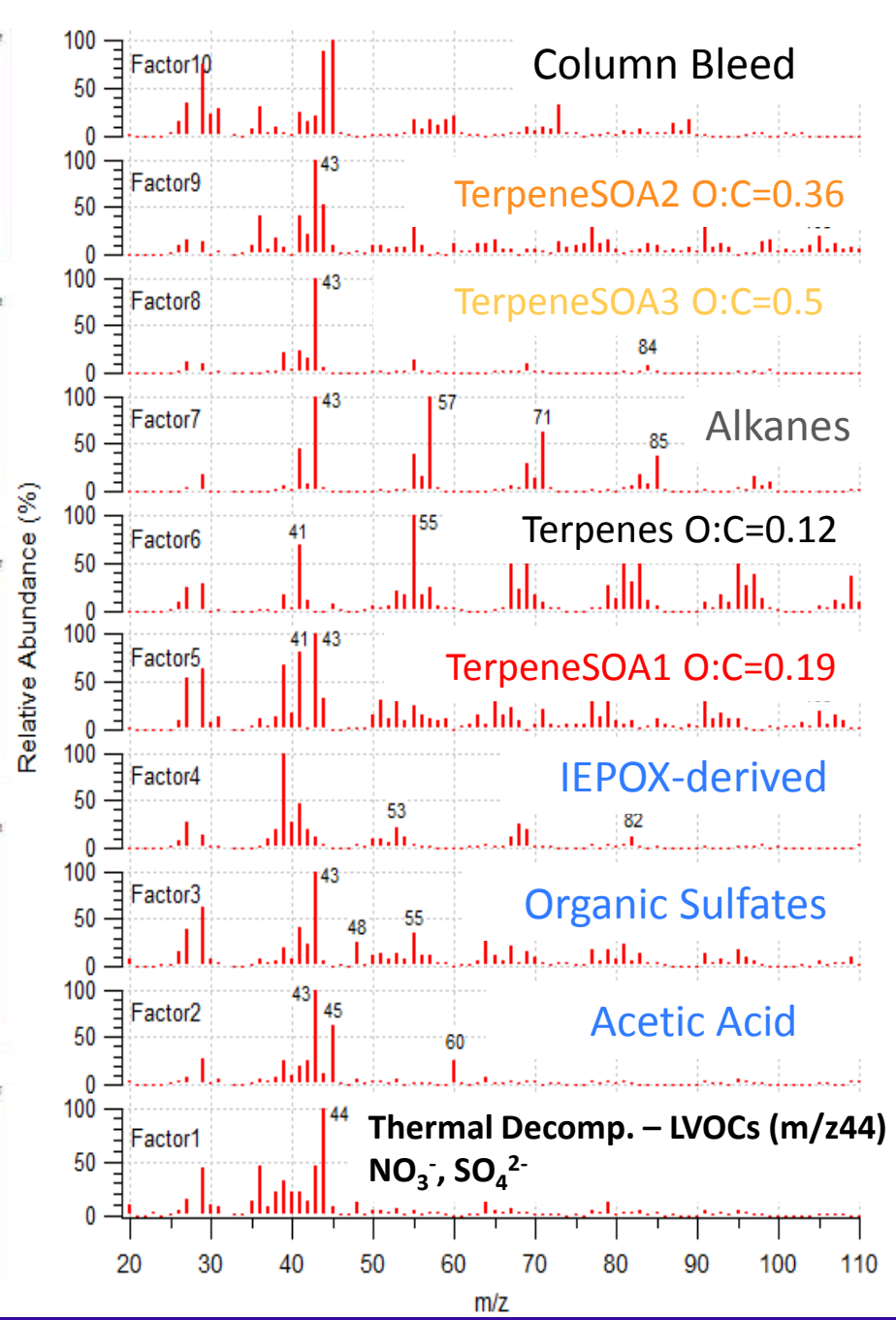
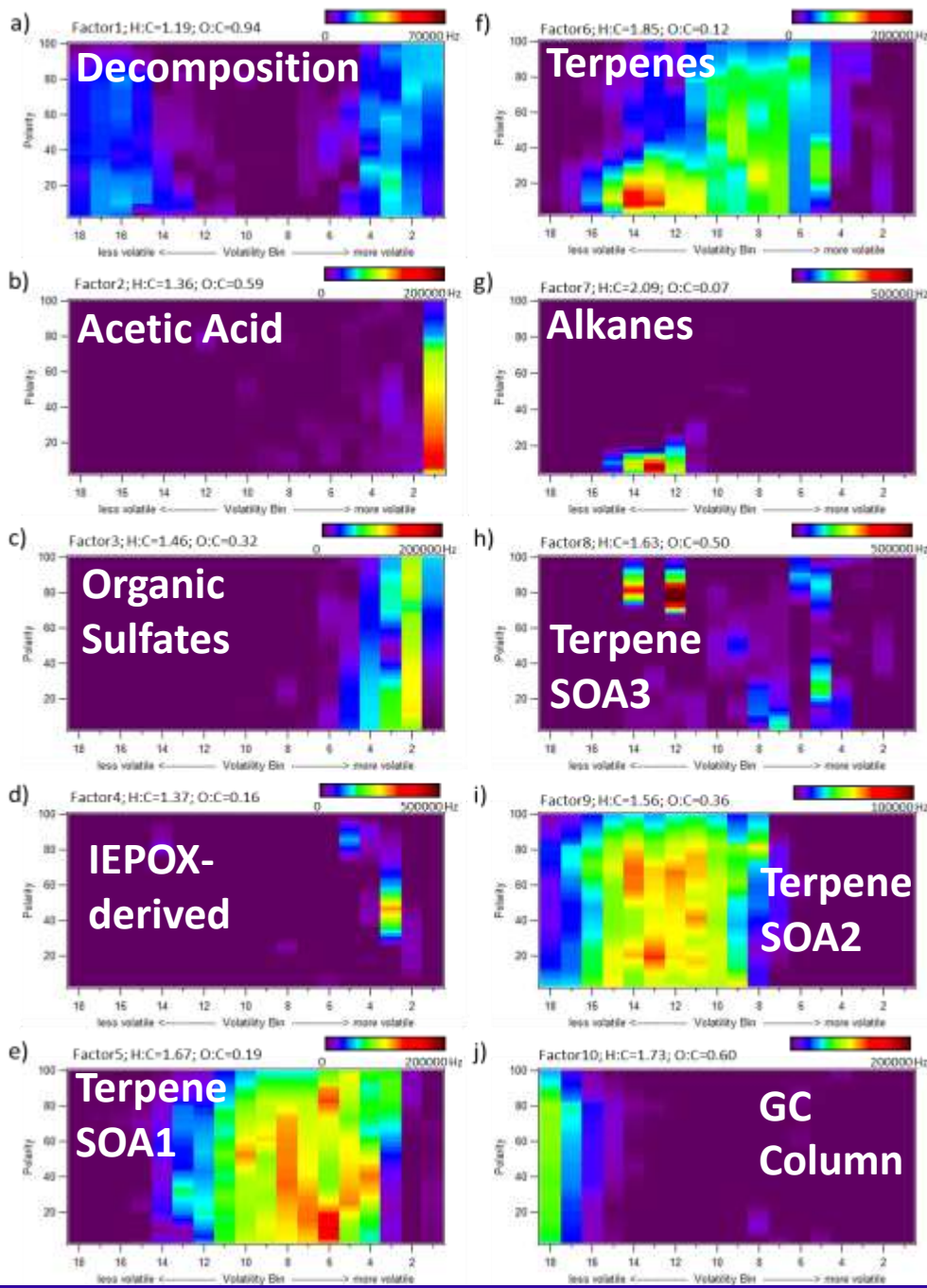

Source Apportionment PMF on Binned VAPS Data (SOAS)

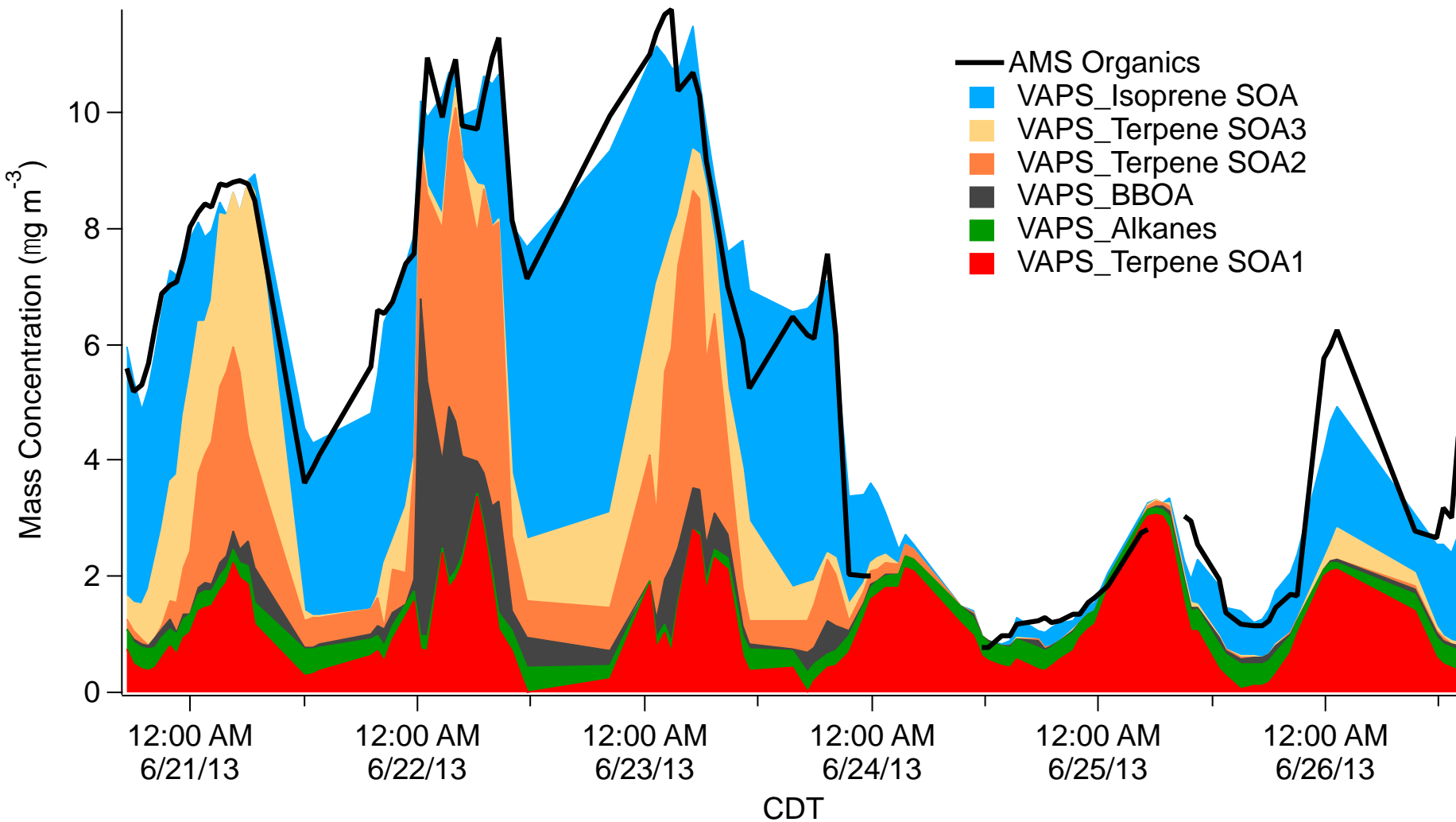

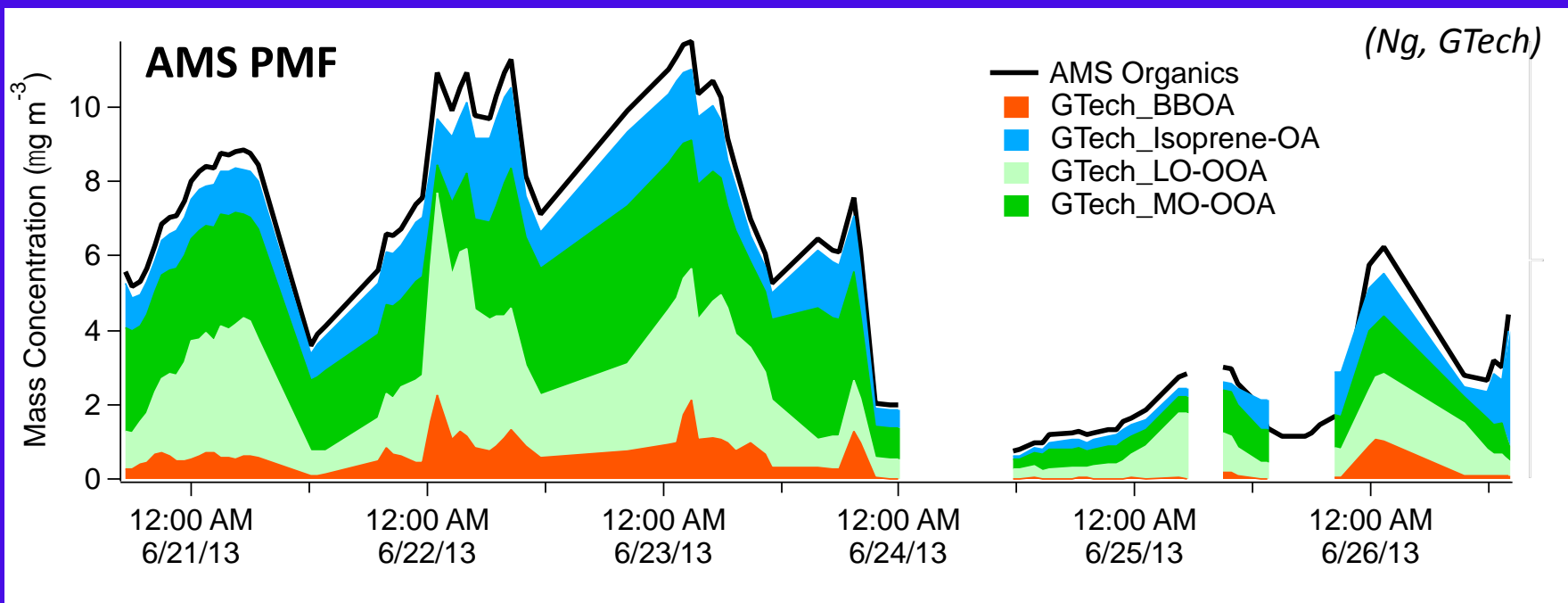
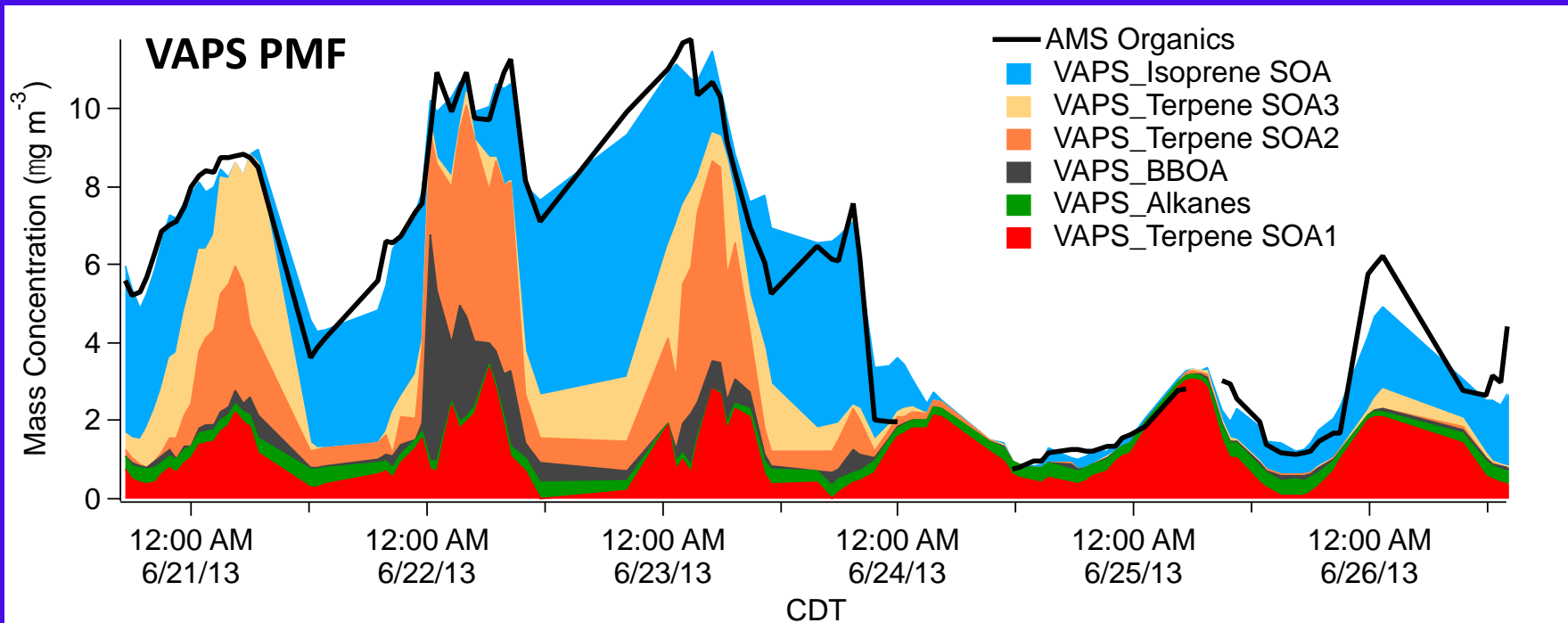

Correlations (Pearson r)

		SV-TAG (UC-Berkeley)									AMS				
		C5 alkene triol 1	C5 alkene triol 2	2-methyltetrol 1	2-methyltetrol 2	methylglyceric acid	pinic acid	pinonic acid	hydroxyglutaric acid	levoglucosan	Isoprene OA	LO-OOA	MO-OOA	BBOA	Isoprene OA + MO-OOA
VAPS	Isoprene SOA	0.67	0.67	0.53	0.55	0.45	-0.04	0.29	0.55	0.22	0.43	0.04	0.65	0.28	0.67
	Terpene SOA1	-0.18	-0.25	-0.10	-0.28	-0.46	0.56	0.27	0.17	0.19	0.24	0.56	0.14	0.28	0.06
	Terpene SOA2	0.43	0.39	0.59	0.50	0.08	0.70	0.40	0.65	0.60	0.23	0.54	0.60	0.30	0.55
	Terpene SOA3	0.44	0.32	0.51	0.31	0.17	0.73	0.79	0.55	0.35	0.66	0.86	0.55	0.70	0.65
	BBOA	0.25	0.15	0.18	0.08	0.20	0.29	0.63	0.27	0.15	0.37	0.62	0.10	0.67	0.26
	IsopreneSOA + TerpeneSOA3	0.78	0.69	0.73	0.60	0.40	0.47	0.75	0.76	0.40	0.80	0.67	0.87	0.73	0.92
	TerpeneSOA1+2 + BBOA	0.31	0.20	0.43	0.23	-0.11	0.87	0.70	0.64	0.55	0.45	0.93	0.51	0.67	0.52
AMS	IsopreneOA	0.78	0.67	0.69	0.61	0.68	0.40	0.62	0.52	0.25					
	LO-OOA	0.52	0.38	0.53	0.38	0.23	0.83	0.85	0.68	0.51					
	MO-OOA	0.77	0.74	0.79	0.73	0.43	0.54	0.54	0.85	0.46					
	BBOA	0.62	0.54	0.50	0.40	0.28	0.51	0.71	0.61	0.50					
	Isoprene+MO-OOA	0.79	0.70	0.81	0.68	0.40	0.55	0.69	0.80	0.51					

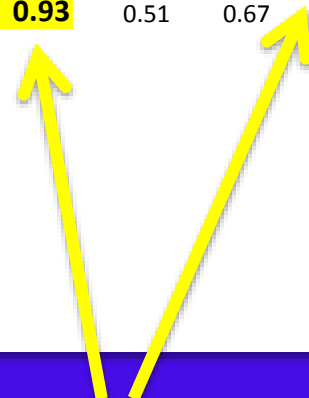

Combinations of Components
Provides highest correlations

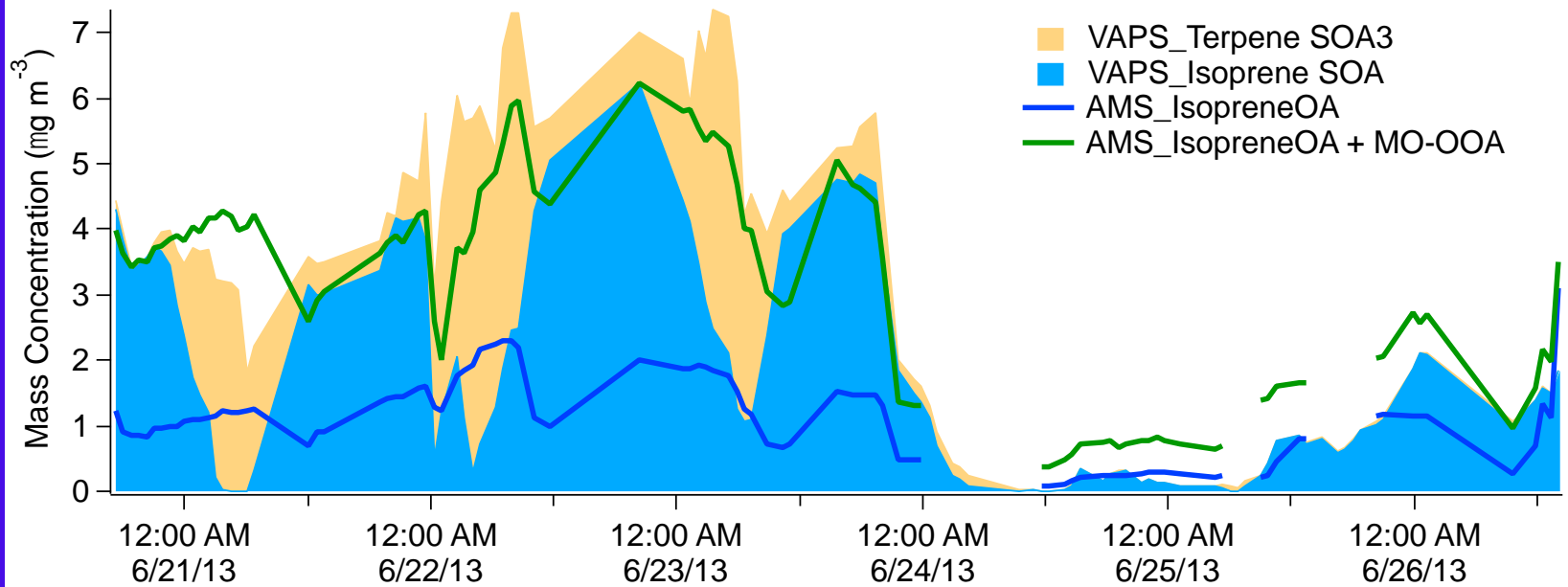
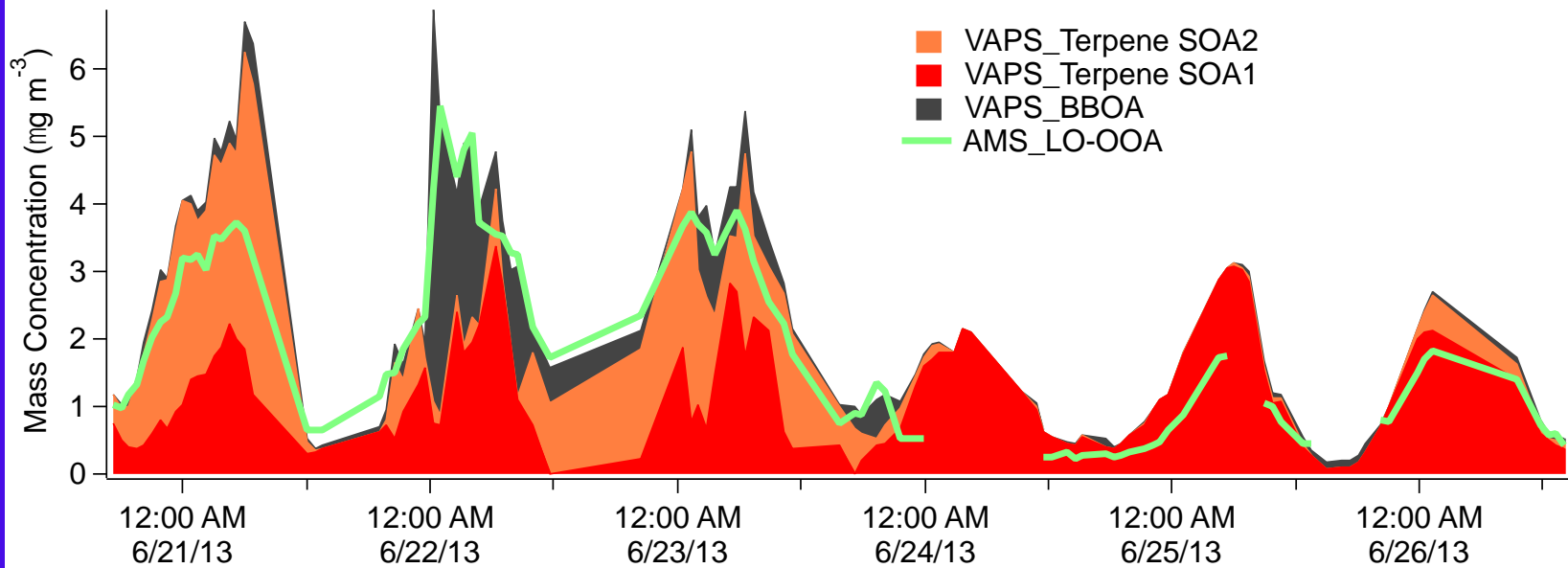

AMS

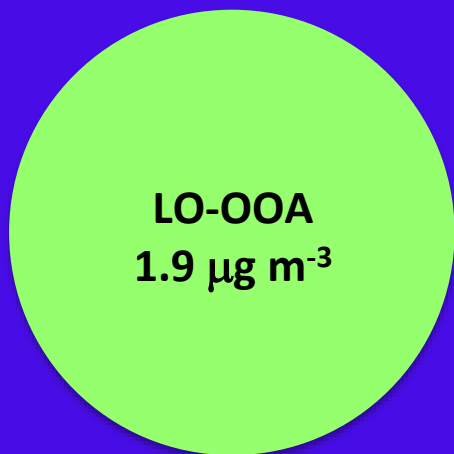

$r = 0.93$



VAPS

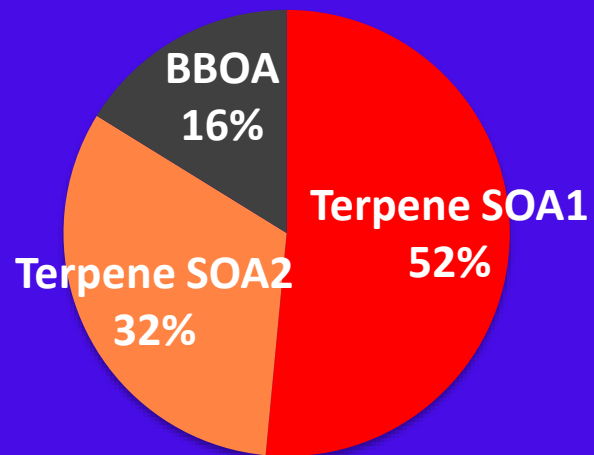

$r = 0.92$

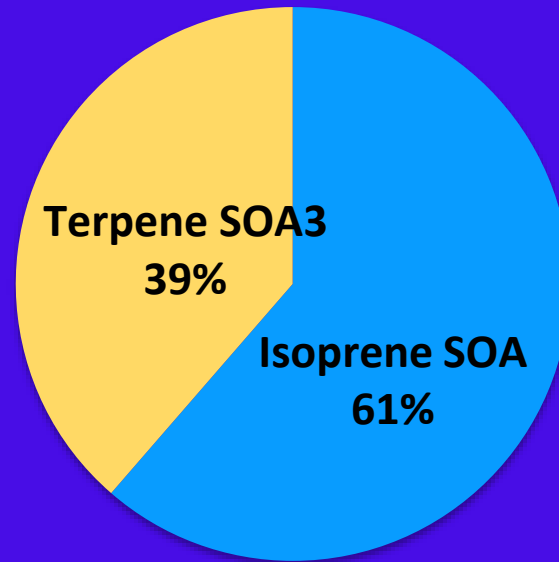
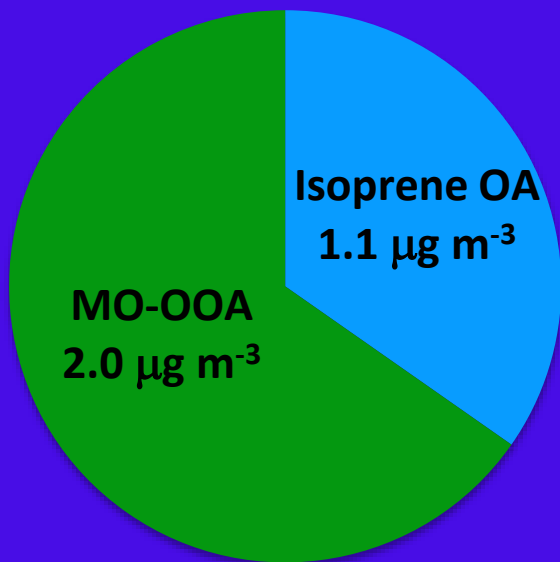

CTR_June
OA: $5.0 \pm 4.0 \mu\text{g}/\text{m}^3$
(PM_{10} : $7.5 \pm 5.3 \mu\text{g}/\text{m}^3$)

VAPS Indicates:

40% Isoprene SOA
60% Terpene SOA3

52% Terpene SOA1
32% Terpene SOA2
16% BBOA

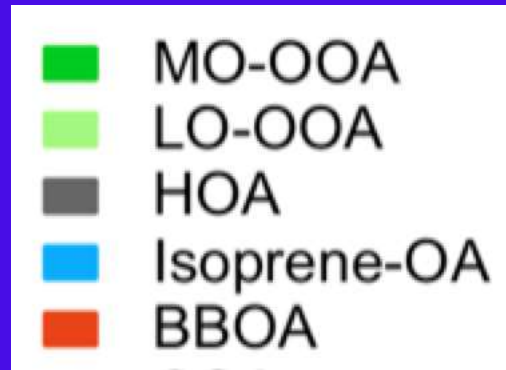
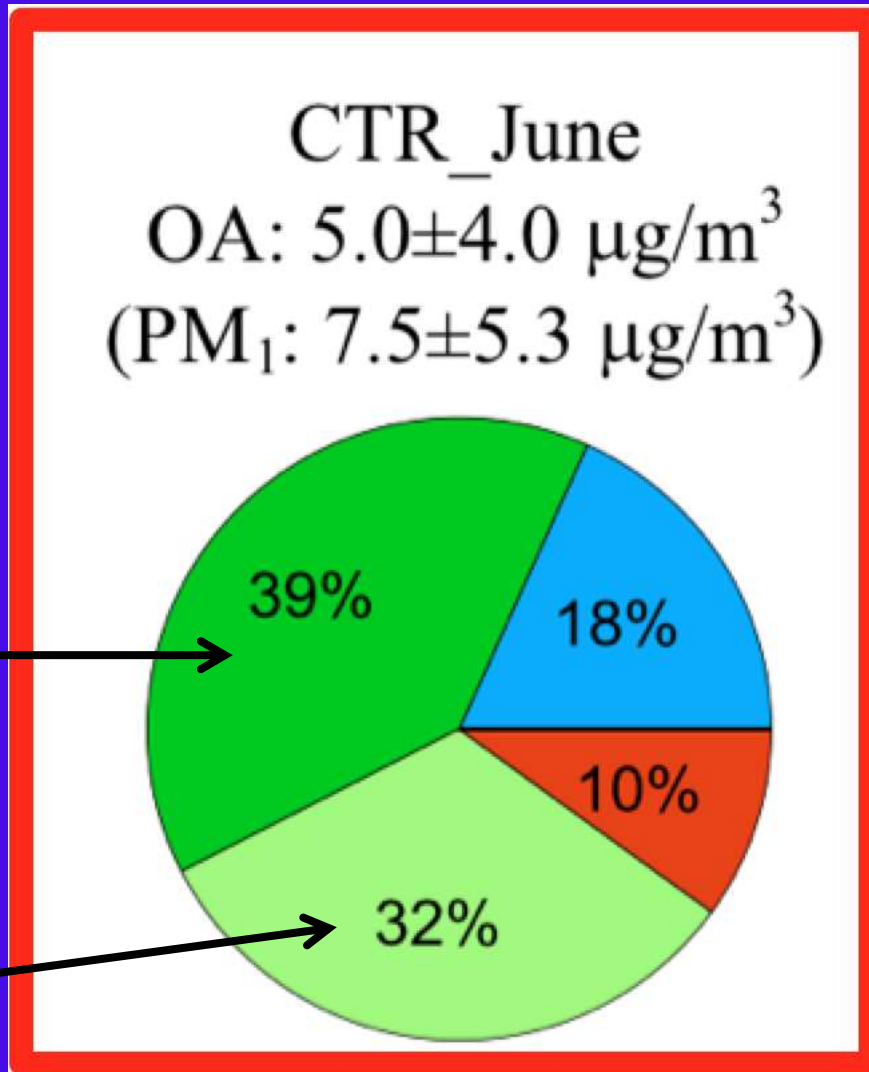

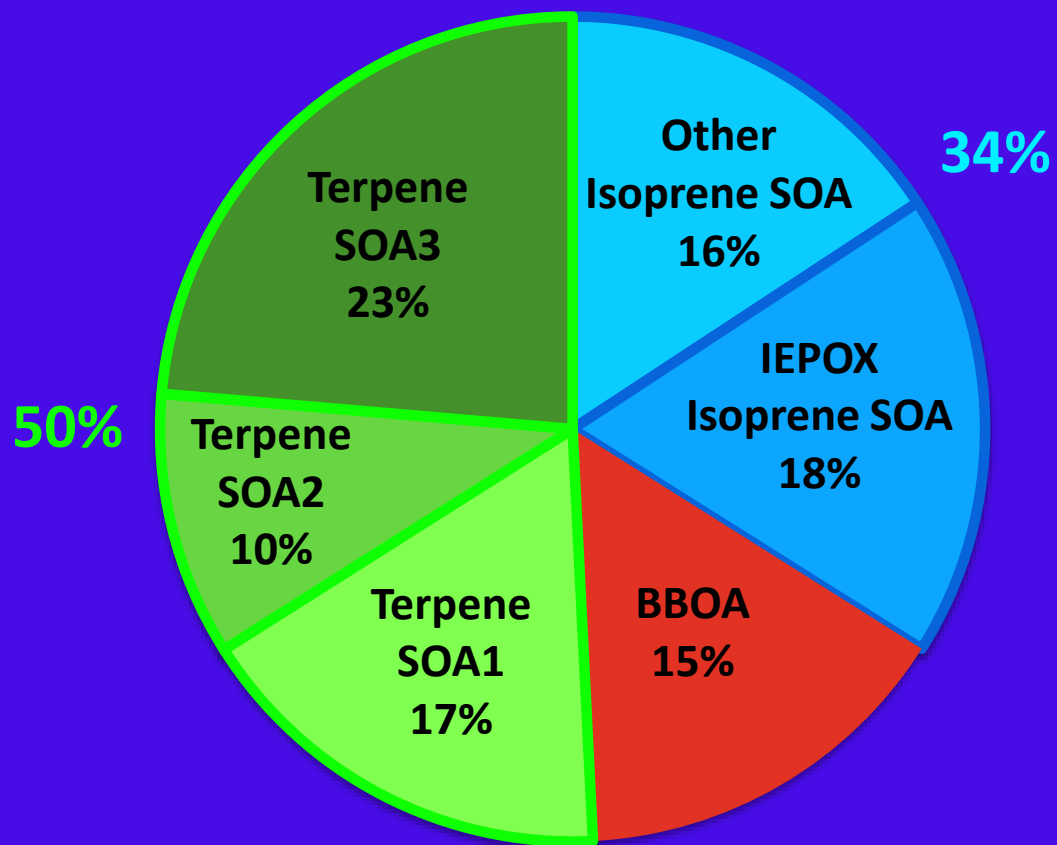

*VAPS analysis based only on 1 week time period, AMS analysis was over entire month

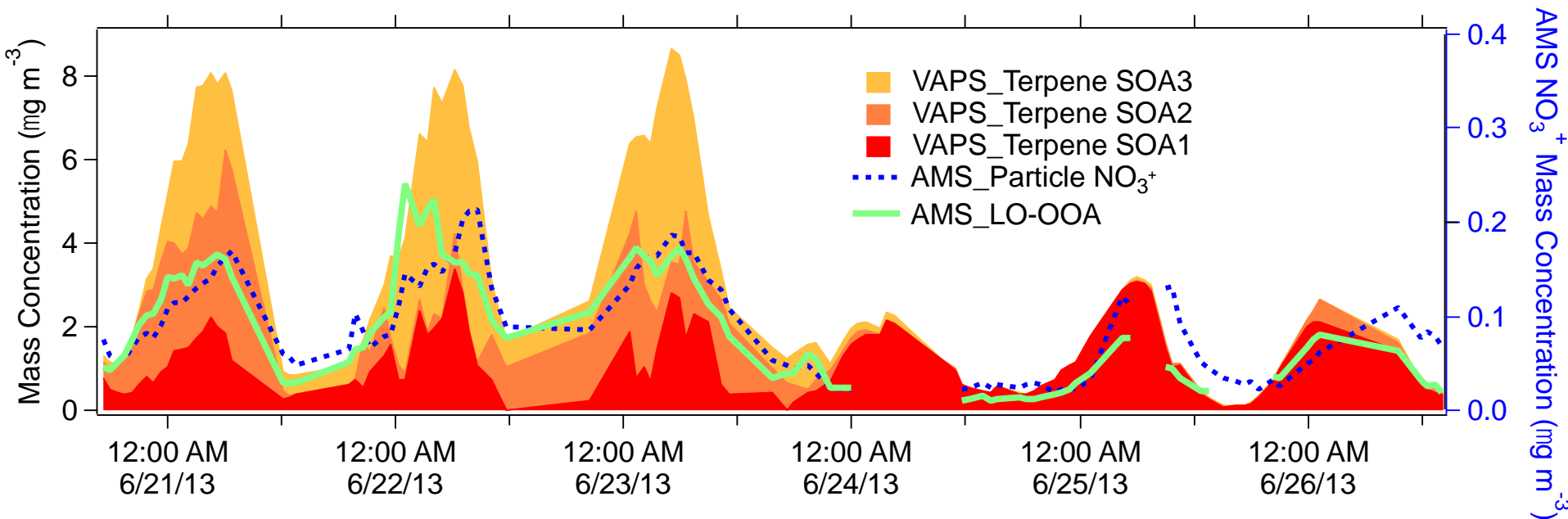

- *Xu et al.* (2015) suggests LO-OOA is largely from terpene **BVOC+NO₃** and **locally** produced.
- VAPS Terpene SOA3 is in excess of LO-OOA and has highest O:C ratio. It may represent a more aged – regional component.
- Or altered chemistry.....need additional lab studies to test
- Currently developing **Isoprene/Terpene + NO₃** lab studies + analysis of **standards**
- Many of the compounds observed by VAPS do not exist in current “underivatized” mass spectral libraries!

OUTLINE

- Instrument Development
- Novel Data Analysis Methods
- Field observations: SOAS – Centreville, AL
- Field observations: SLAQRS – East St. Louis, IL
- Laboratory-based oxidation studies
- Conclusions

St. Louis Air Quality Regional Study (SLAQRS)

Aug.3 – Oct.15, 2013



1) PMF results from SLAQRS, East St. Louis: (AMS Data)

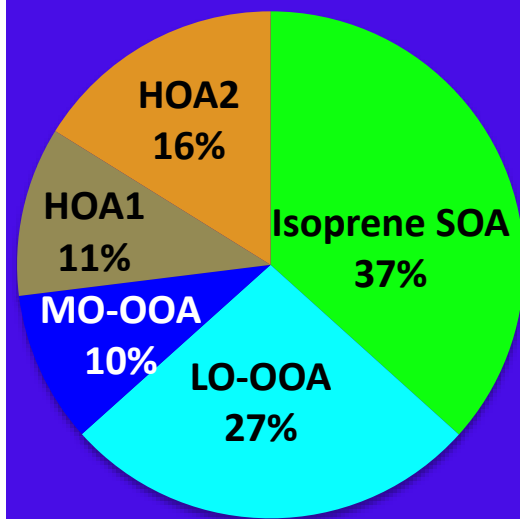
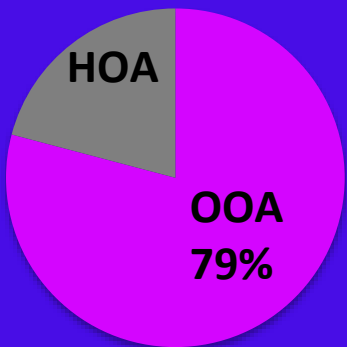
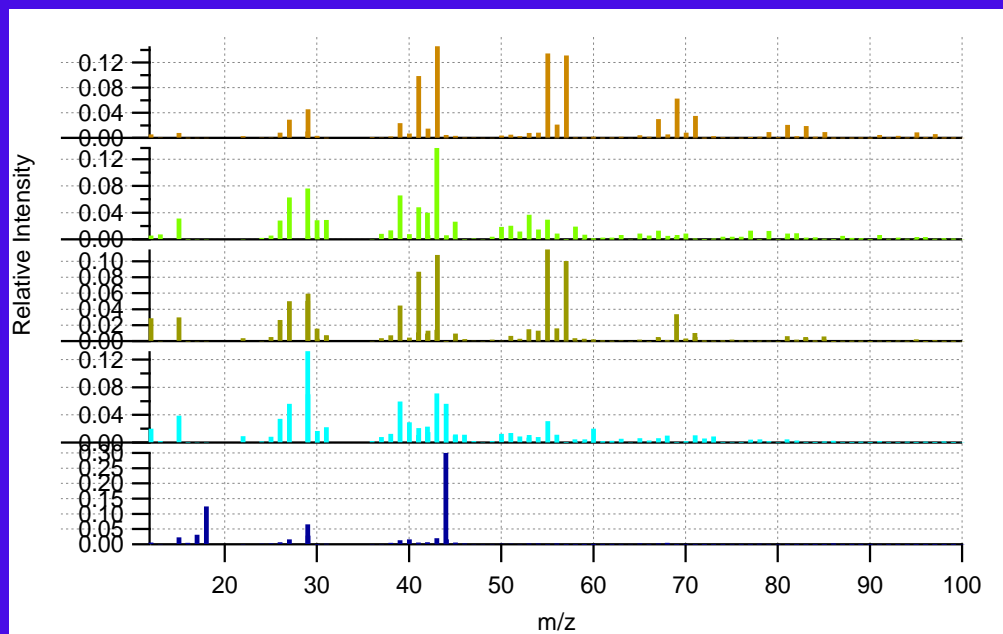
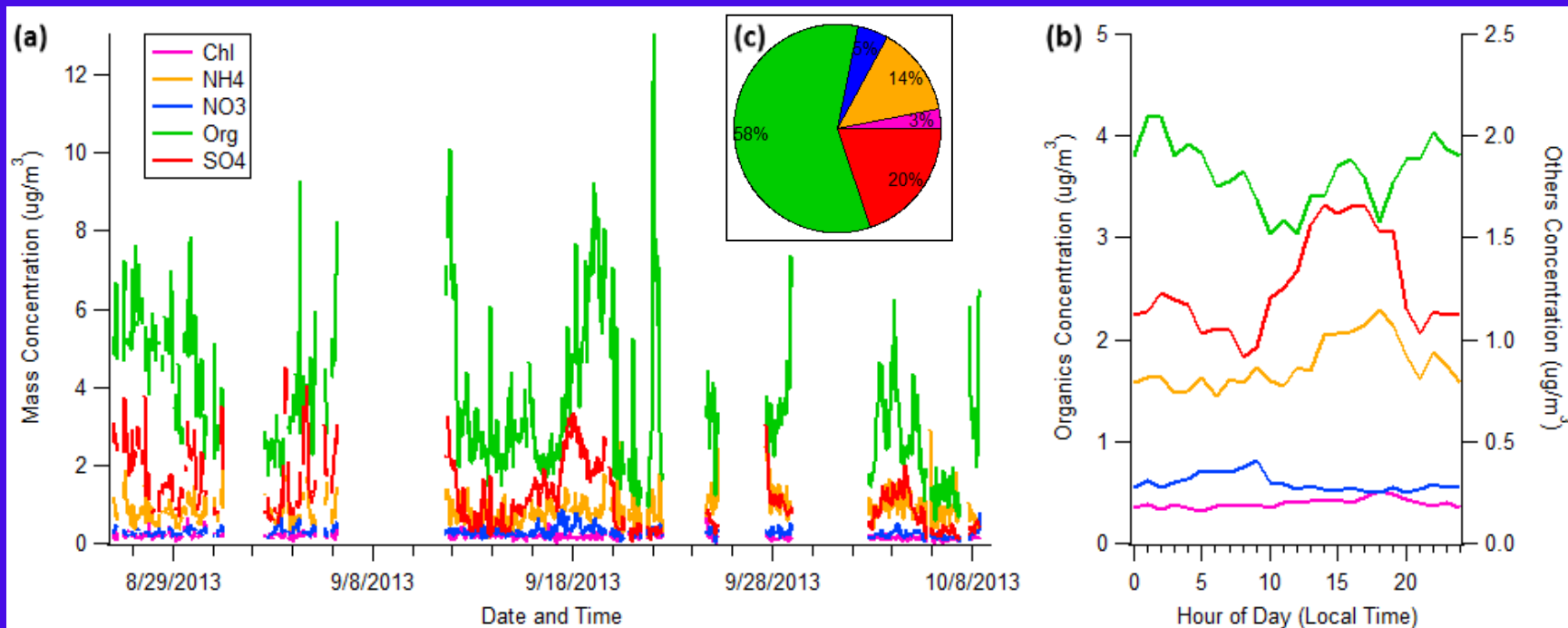

Made an interesting discovery during SLAQRS (TAG and VAPS decomposition signal)

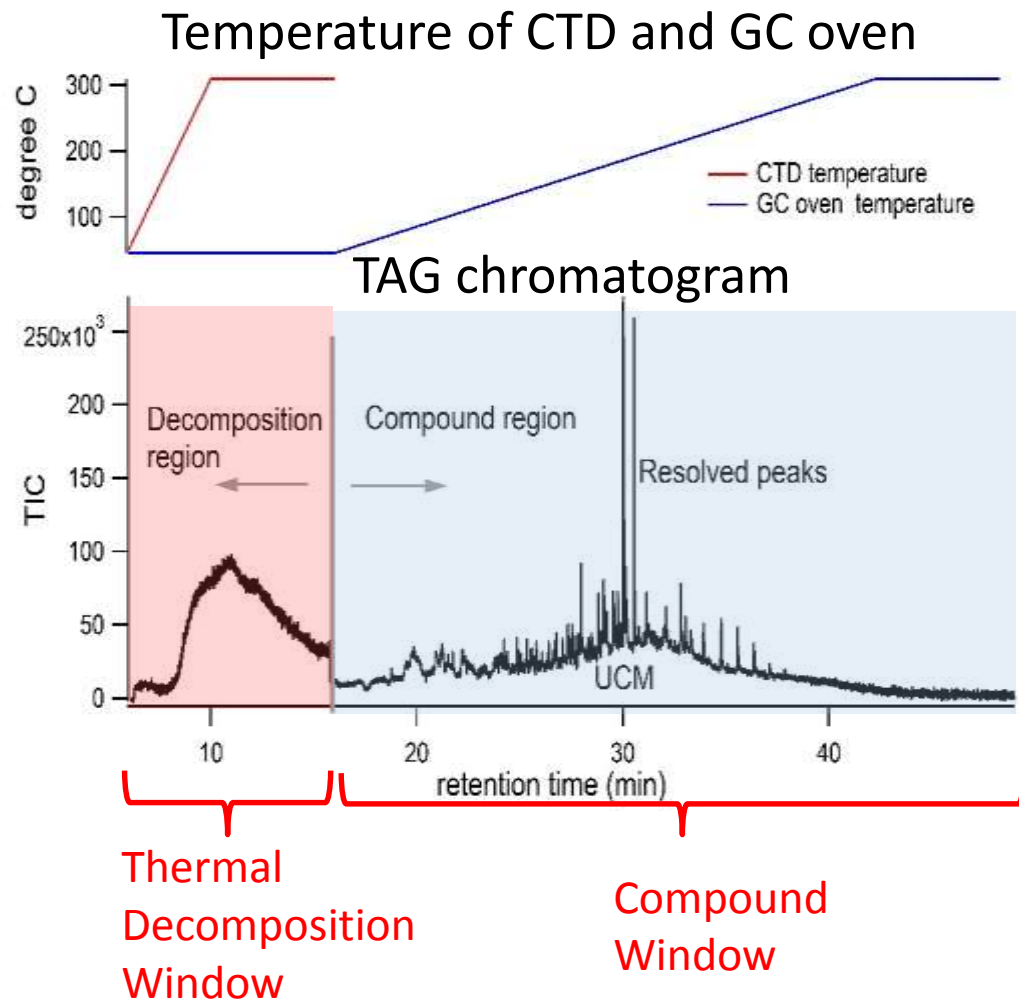
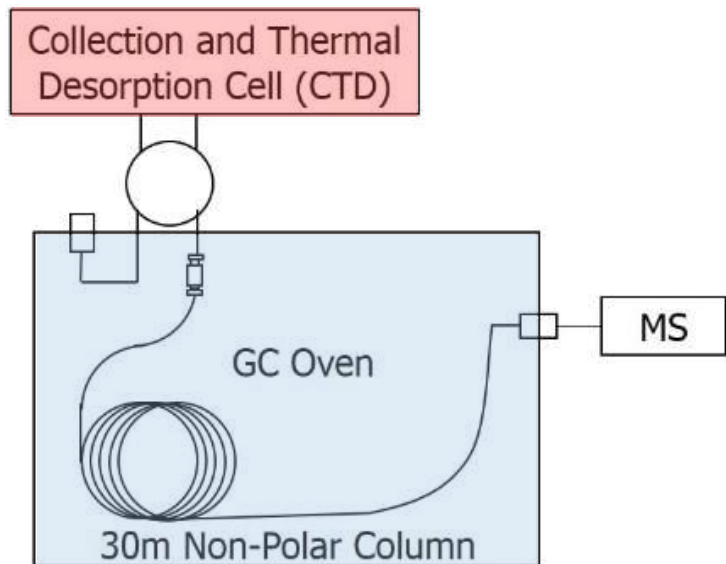

The thermal decomposition signal seems to contain information on the fraction of the aerosol that traditional operation of TAG and VAPS are not capable of detecting

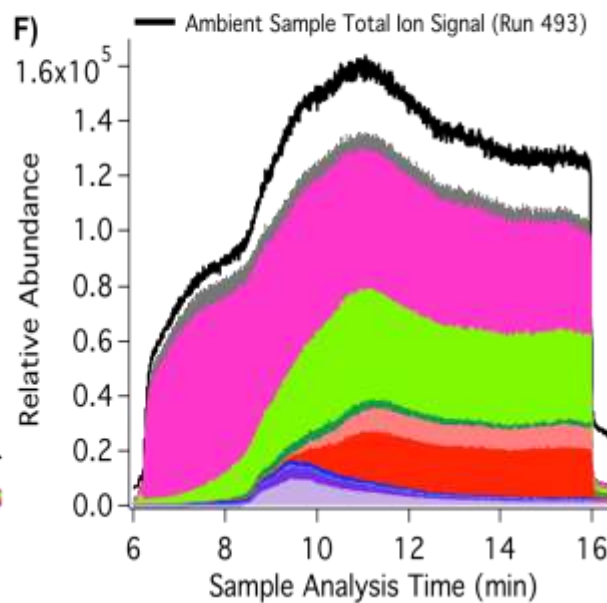
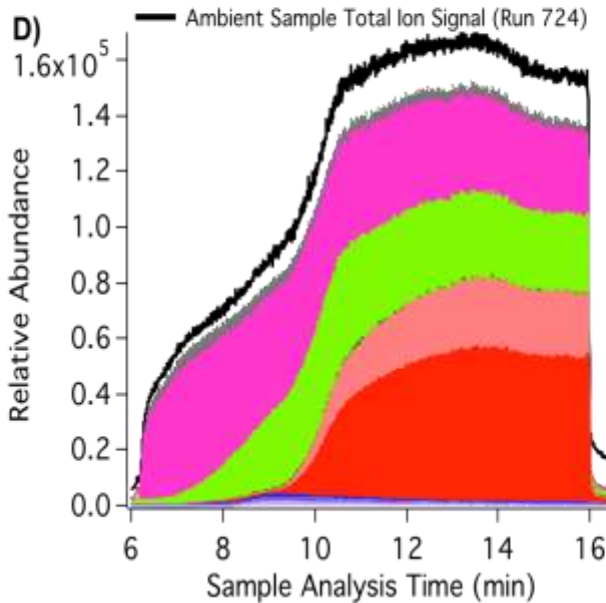
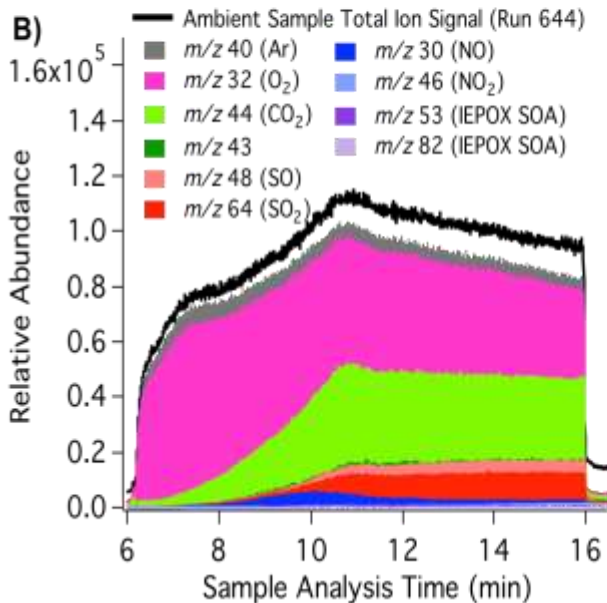
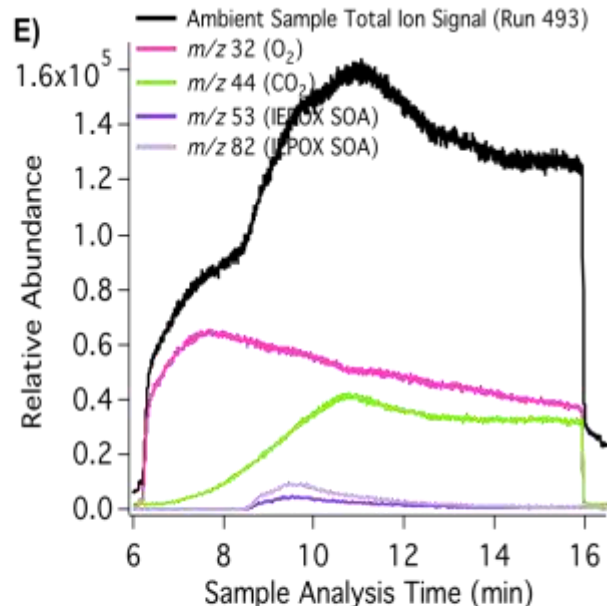
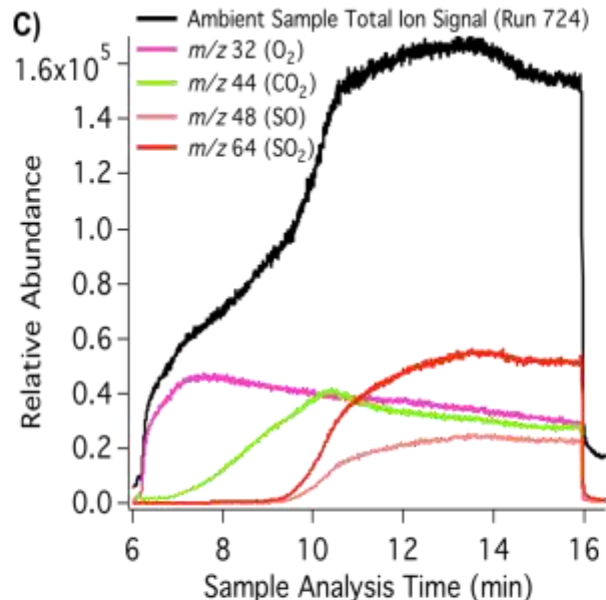
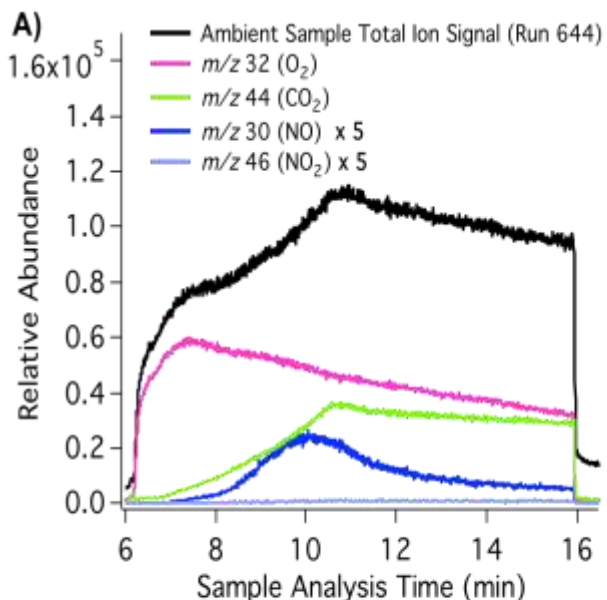

Tracking major ions in the **decomposition window** reveals some good correlations to major AMS components:

A large fraction of the IEPOX signal is in the Decomposition Window

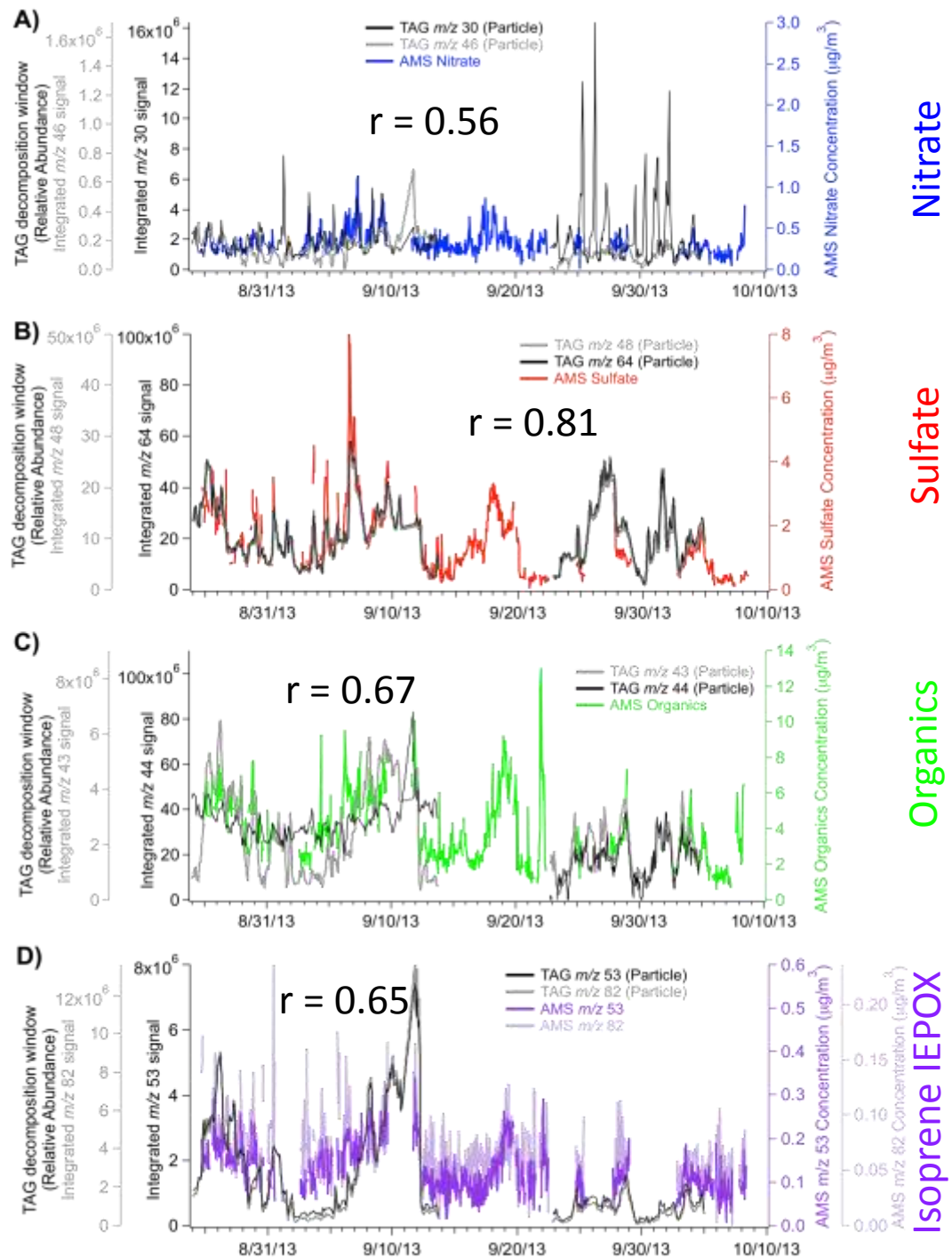
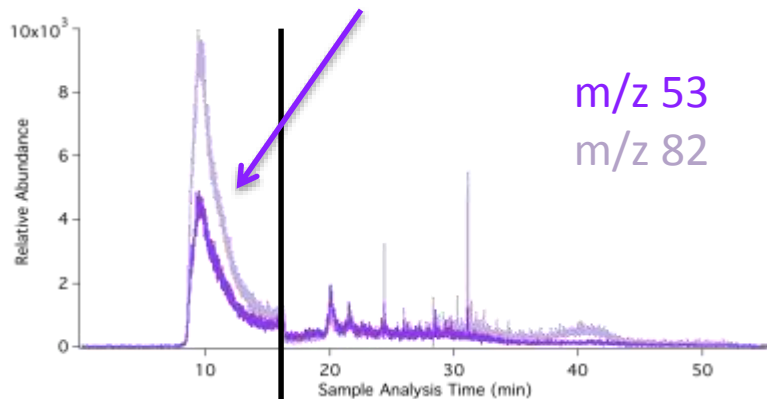

2) PMF results from SLAQRS, East St. Louis: (TAG decomposition signal)

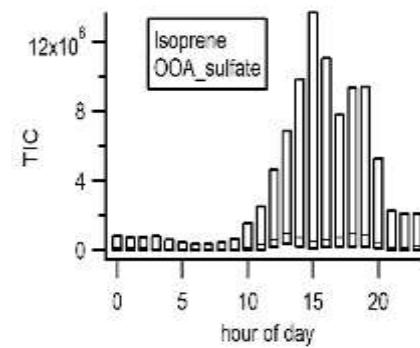
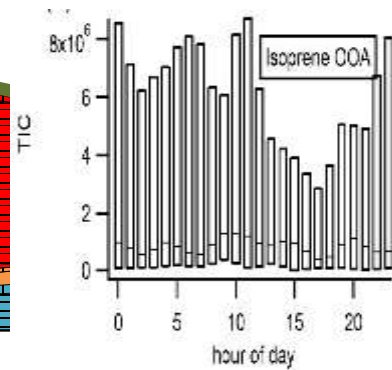
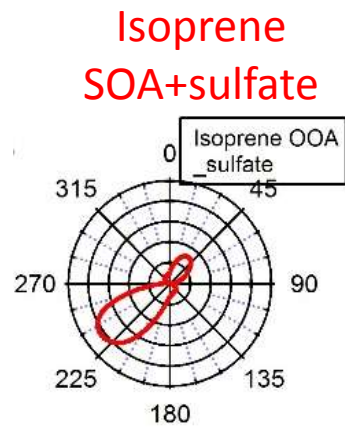
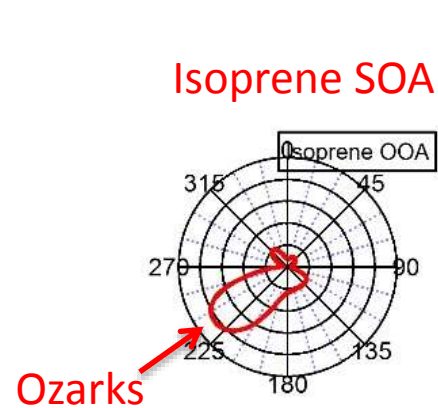
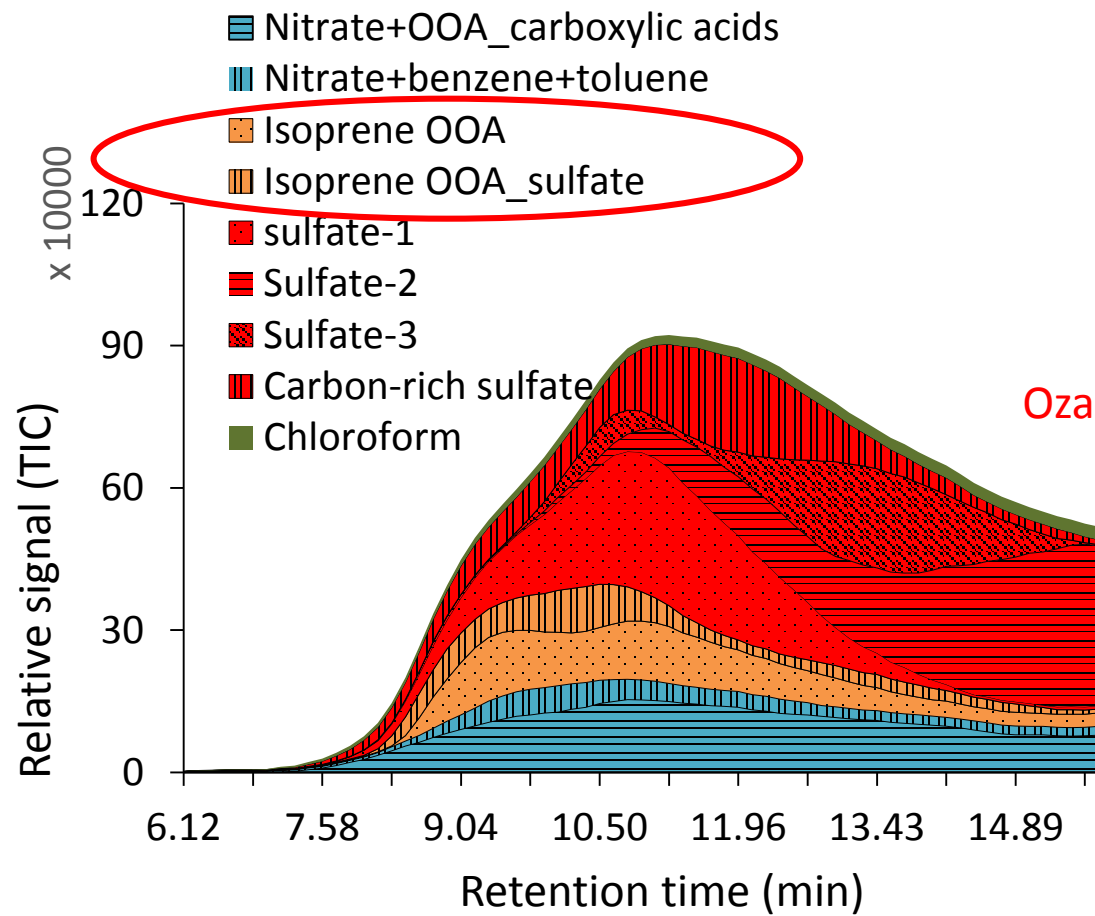

Indicators that this factor represents fresh isoprene SOA, not chemically processed

Isoprene SOA enhancement from presence of acidic seed aerosol

3) PMF results from SLAQRS, East St. Louis: (TAG binned compounds)

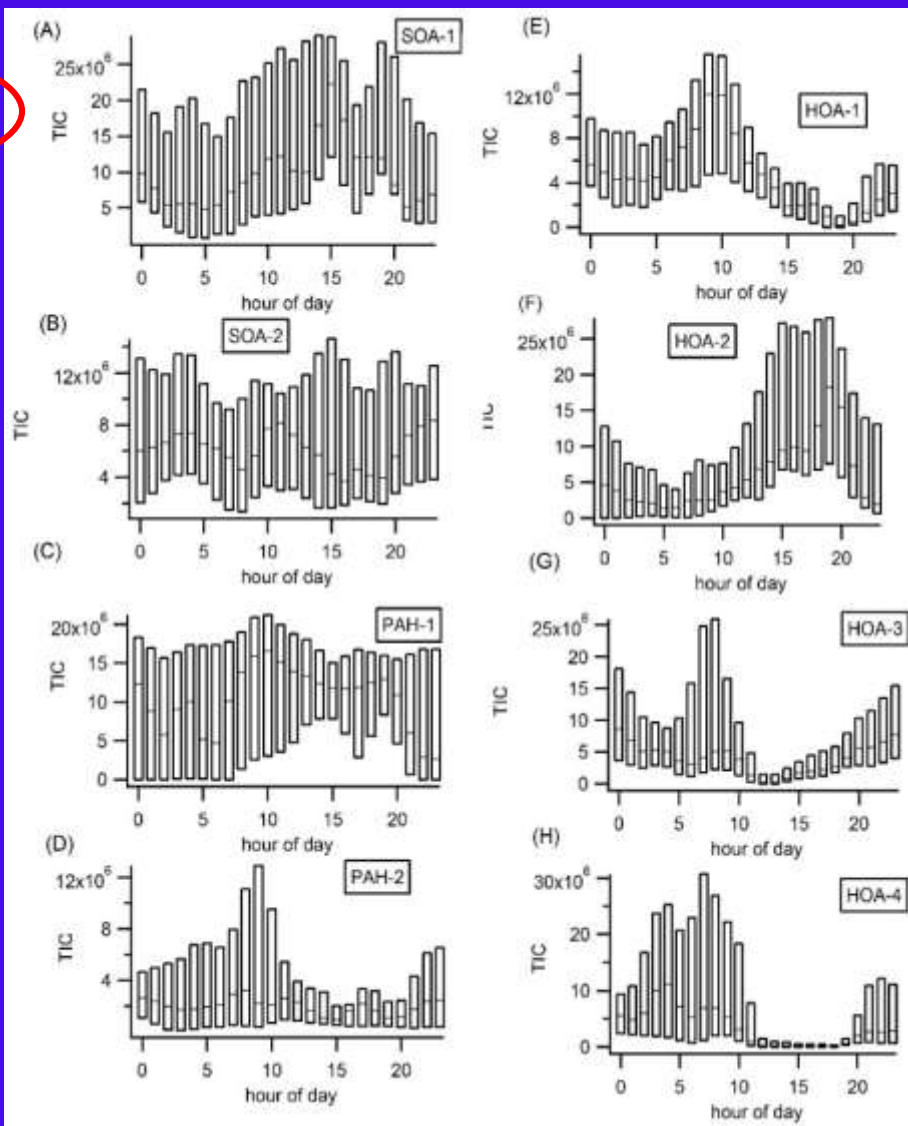
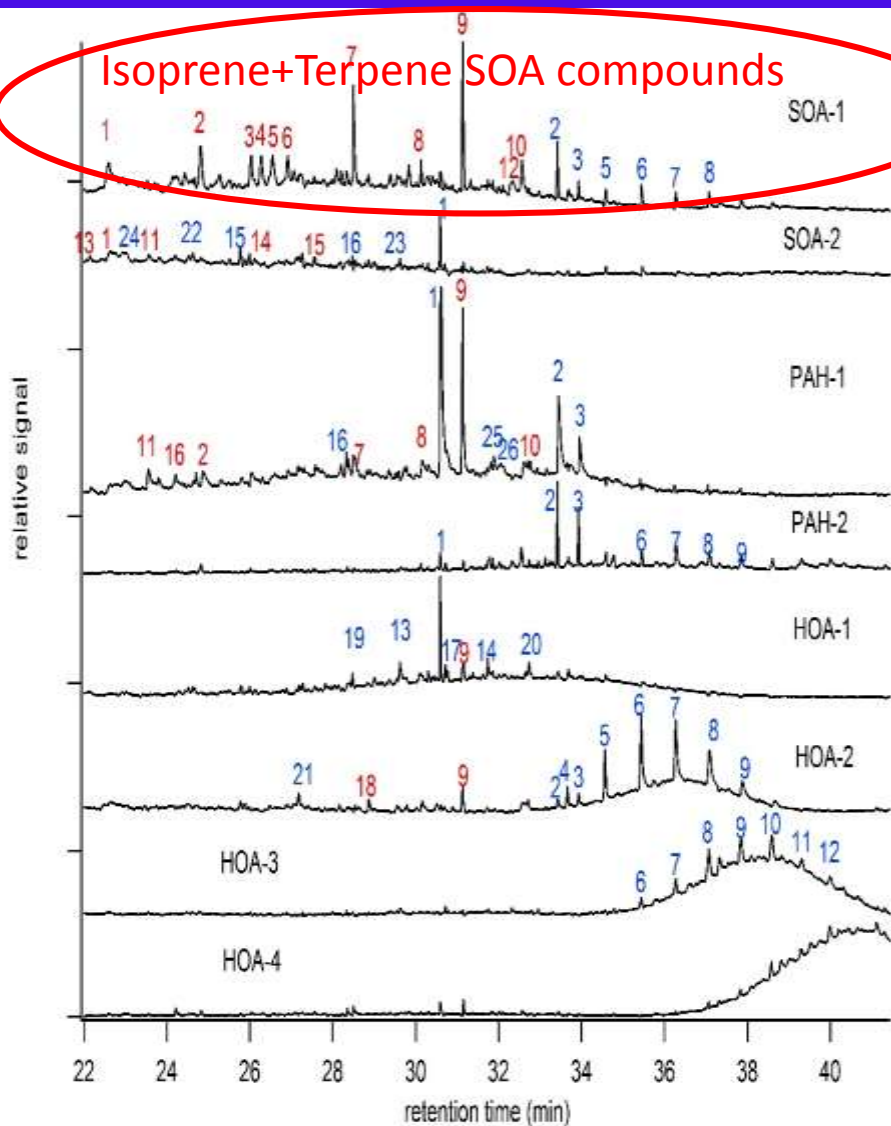

4) PMF results from SLAQRS, East St. Louis: (TAG individual compounds)

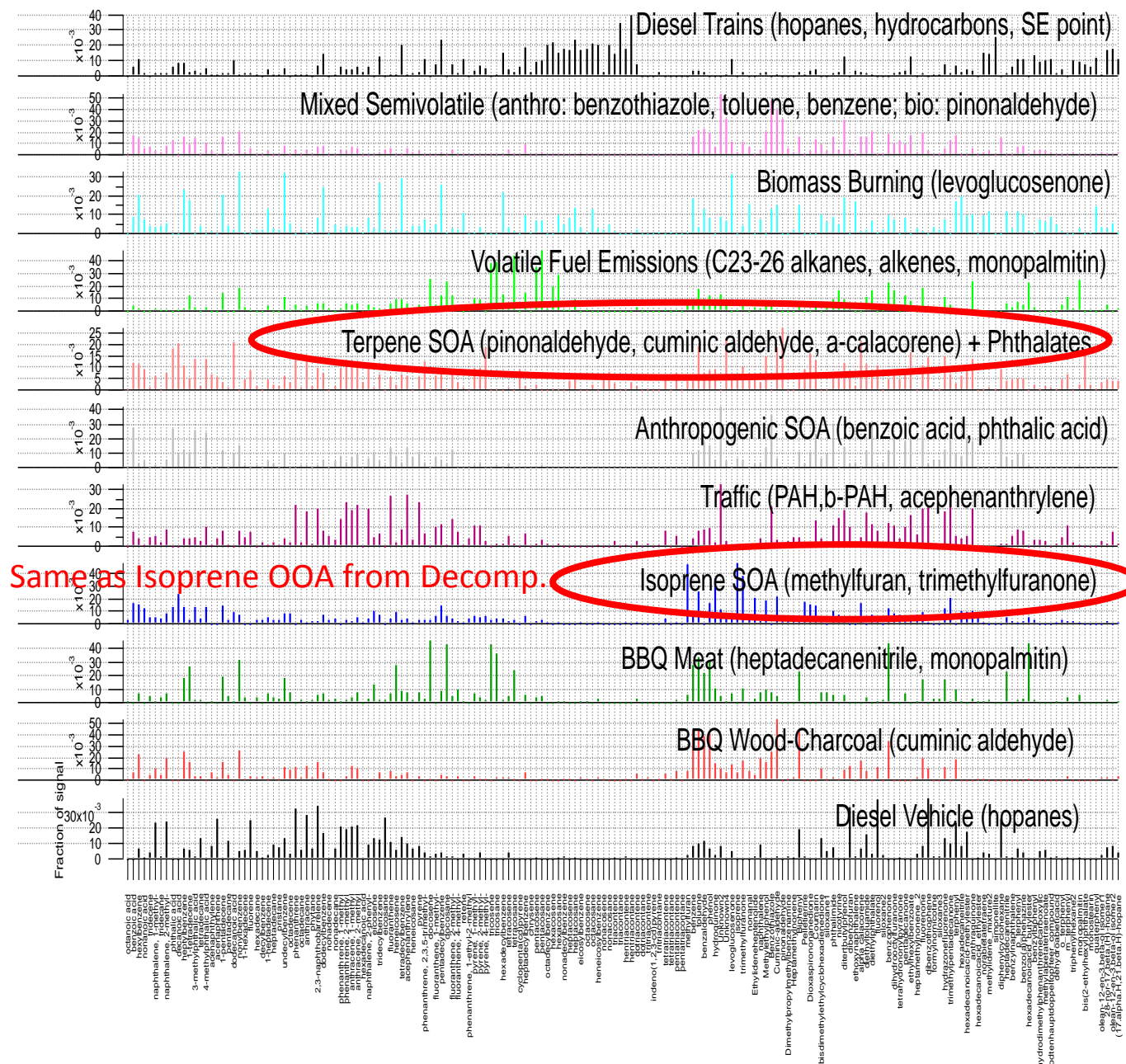
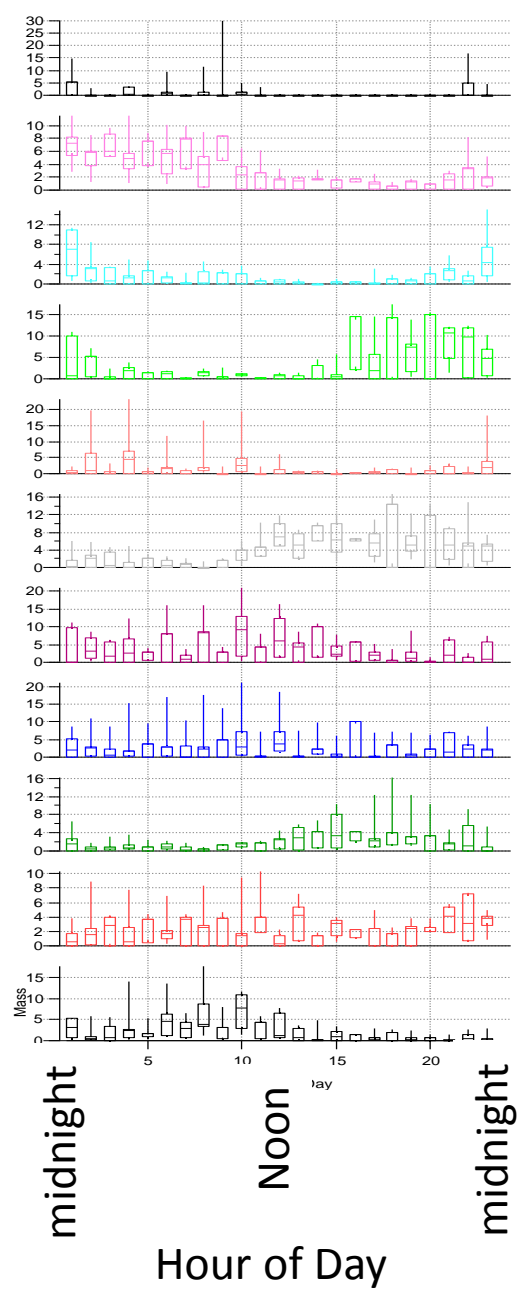

Currently working to combine SLAQRS PMF results from:

- 1) AMS
- 2) TAG (decomposition signal)
- 3) TAG (binned compounds + UCM)
- 4) TAG (integrated compounds)
- 5) VAPS

Created a bit of a data monster, but learning a lot as we now make comparisons!

Good correlations amongst the various Isoprene SOA factors and major Anthropogenic HOA/POA factors.

Observations of Nighttime Chemistry during SLAQRS

Study Average (black dots)

Winds from Ozarks:
Active NO_3 chemistry
to remove Isoprene

Winds from Ozarks:
No active NO_3 chemistry
= results in elevated morning O_3

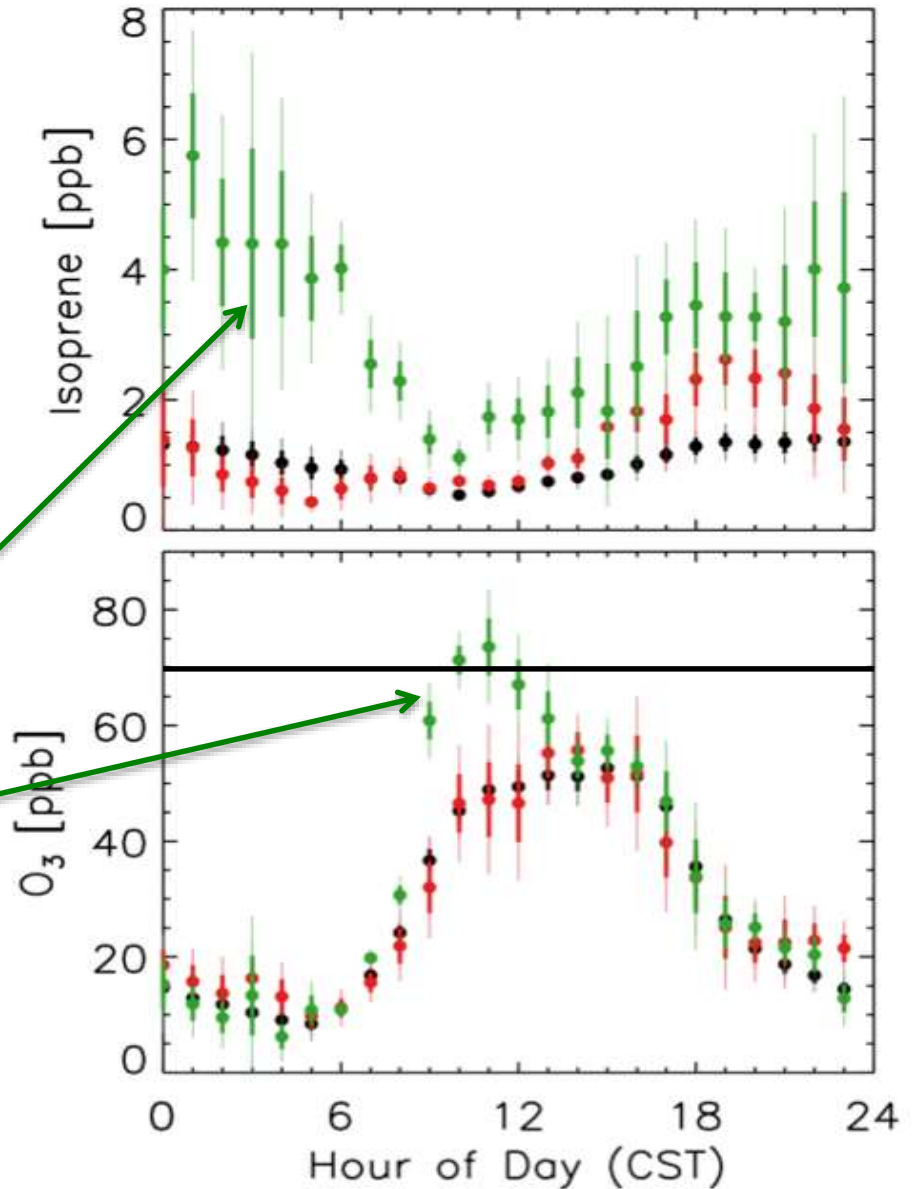

Diurnal Average NO_3 +Isoprene reaction rate

June 2013 climatology, surface to 20.89 km integral

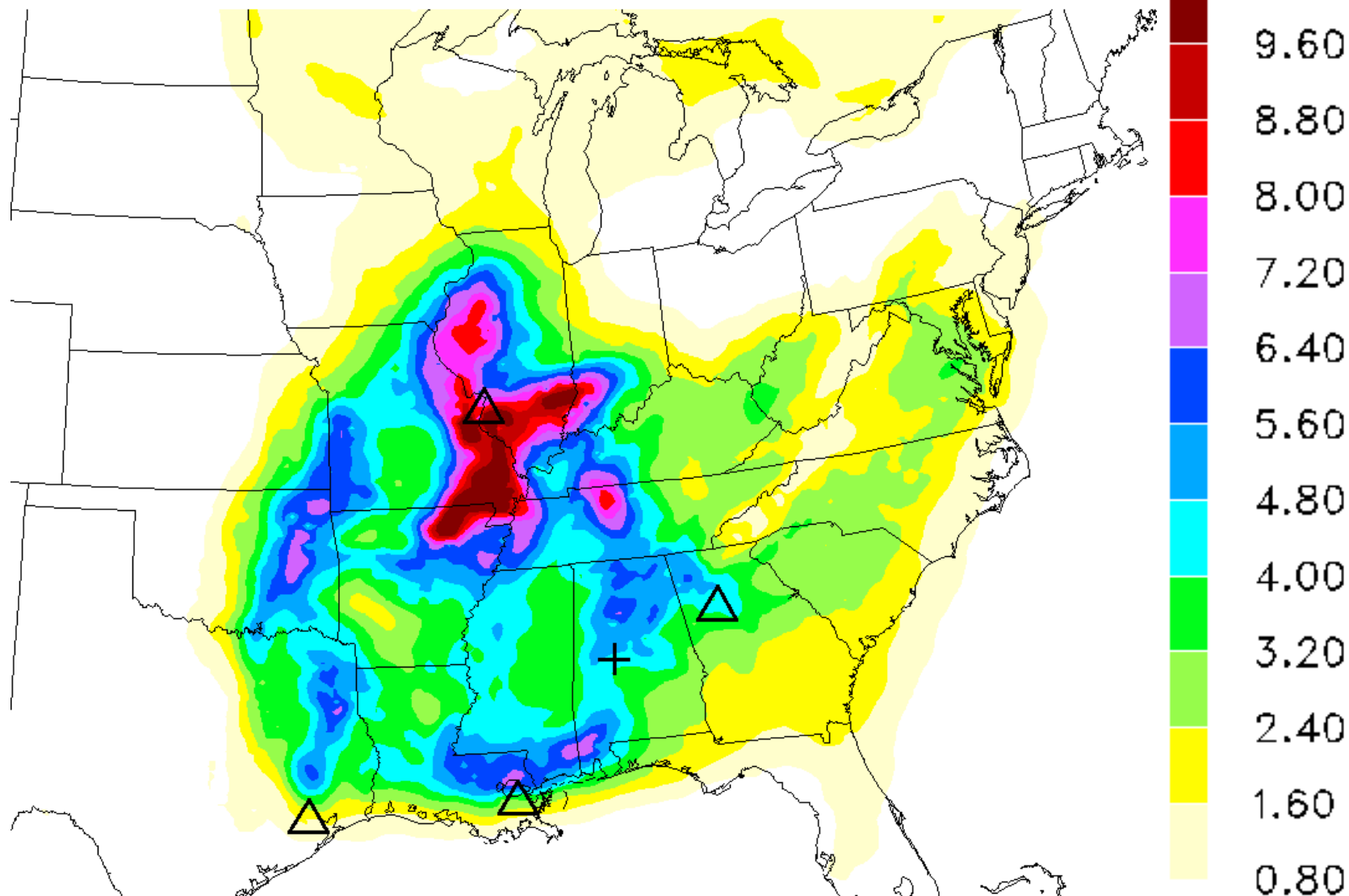

US Av = 0.943 mole/km²/hr

McKeen, Brown (NOAA)

OUTLINE

- Instrument Development
- Novel Data Analysis Methods
- Field observations: SOAS – Centreville, AL
- Field observations: SLAQRS – East St. Louis, IL
- **Laboratory-based oxidation studies**
- Conclusions

Design for Laboratory-based Oxidation Studies

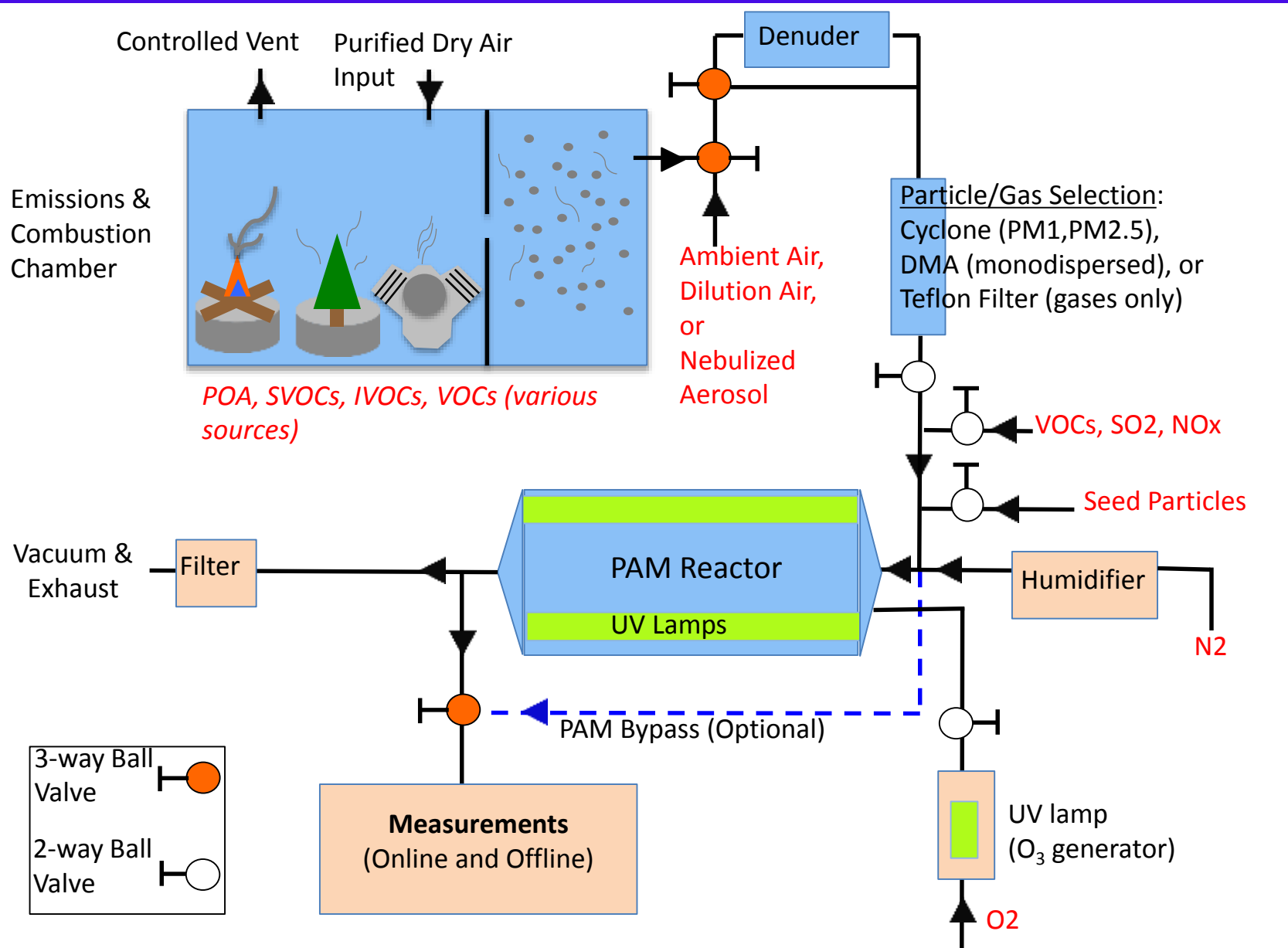



VOC



I/SVOC



LVOC



Real Emissions



Thermal desorption Aerosol Gas Chromatograph (TAG)



Potential Aerosol Mass (PAM) Reactor



O₃, NO, NO₂, SO₂, CO, CO₂



Volatility & Polarity Separator – Aerosol Mass Spectrometer (VAPS-AMS)

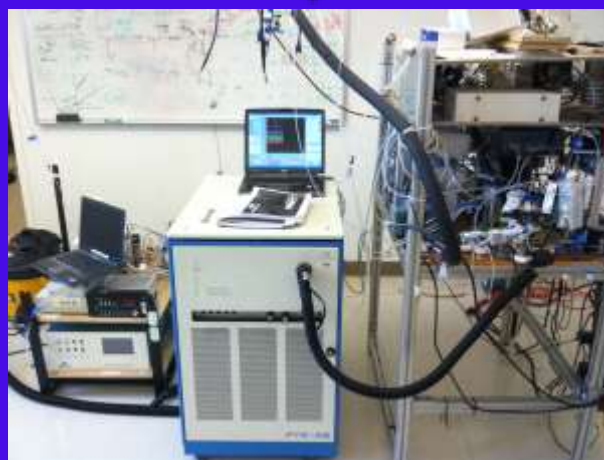

Proton Transfer Reaction Mass Spectrometer (PTR-MS)

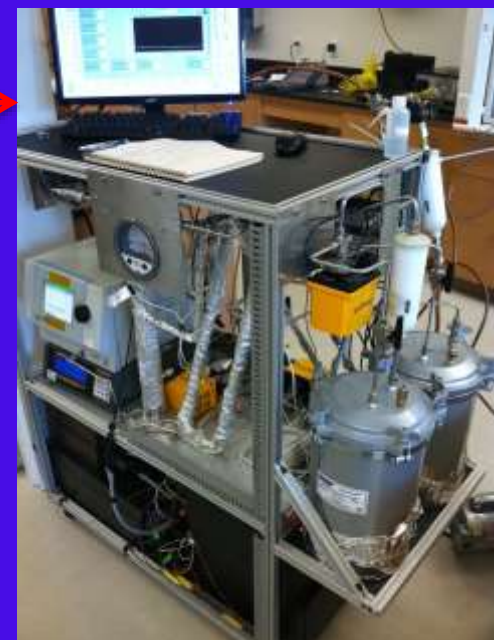

Volatility+Hygroscopicity-TDMA, SMPS

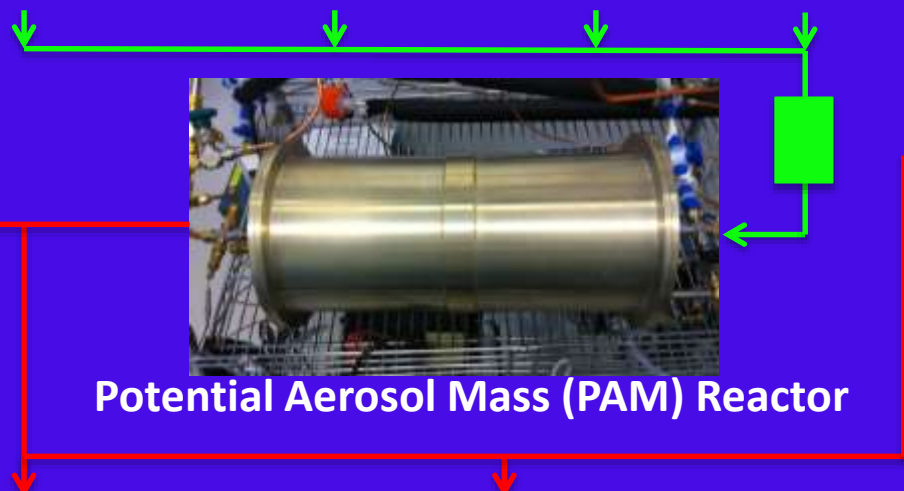

Building and Adding to Chemical Databases

Aerosol Mass Spectrometer (AMS)

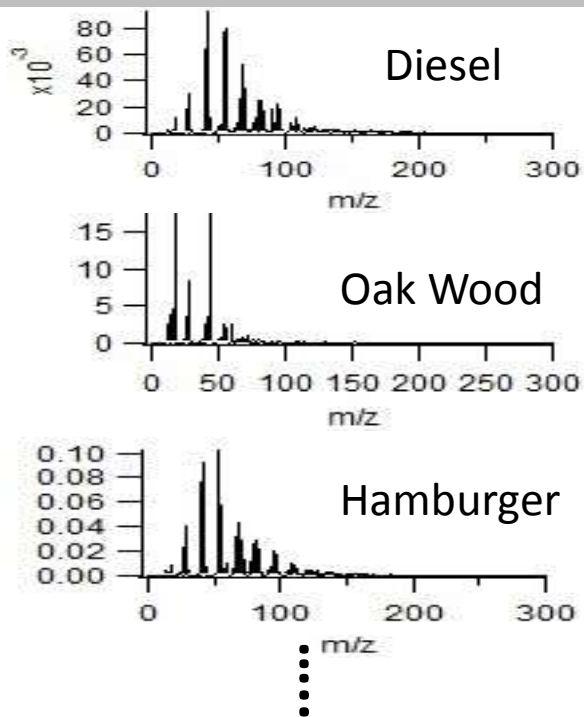

Thermal desorption Aerosol Gas chromatograph (TAG)

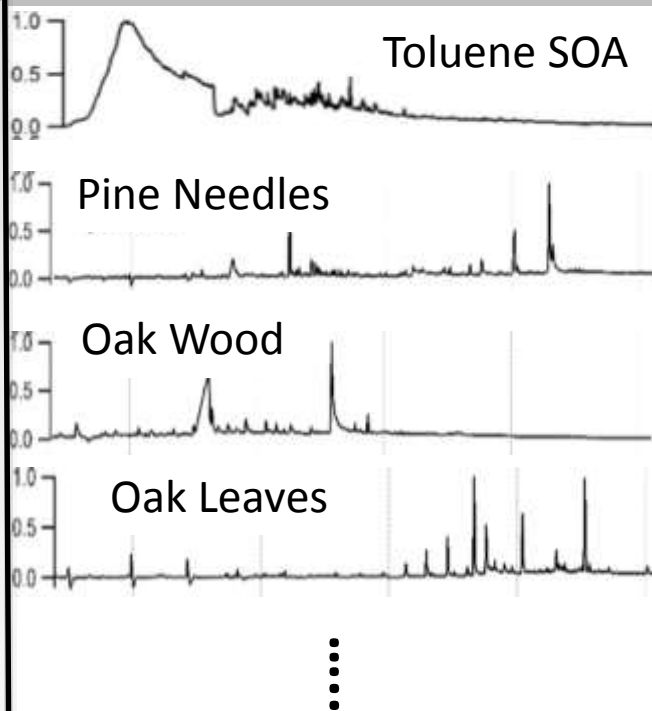

Volatility and Polarity Separator (VAPS)

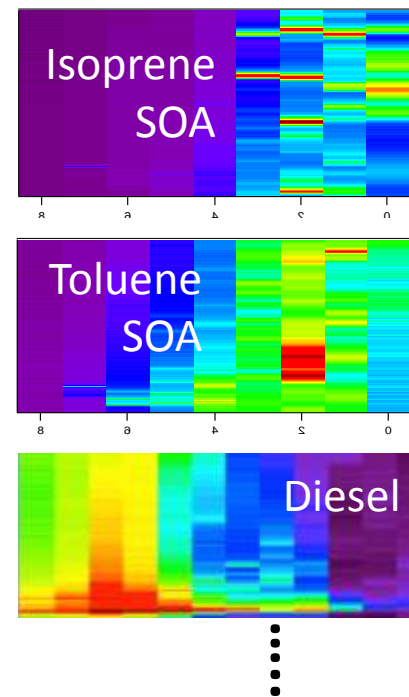

For purpose of this project we are characterizing oxidation of **Isoprene + several Terpenes** (over a range of: oxidation states, humidity, oxidants, acidity, NO_x)

Connecting chemistry to hygroscopicity

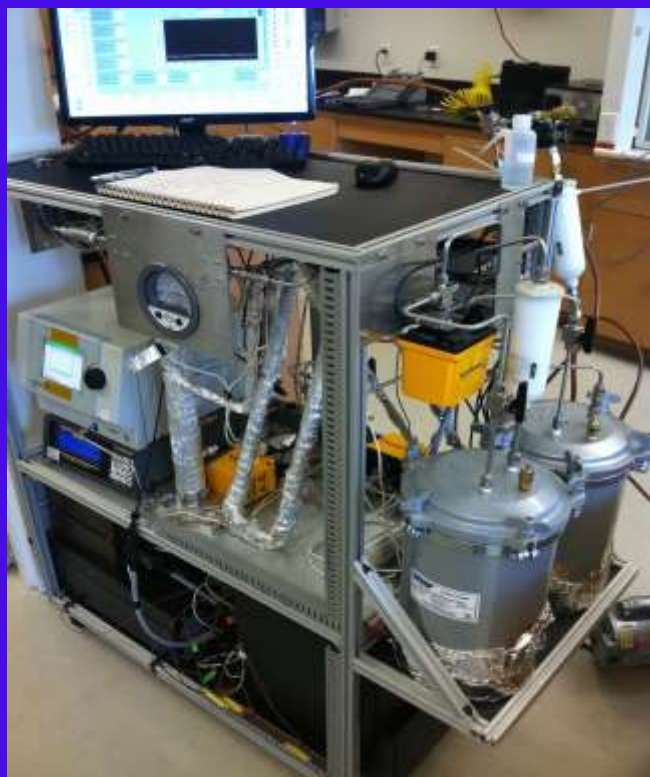

Multi-Channel TDMA

hygroscopicity, volatility, etc.

(developed through EPA Early Career award)

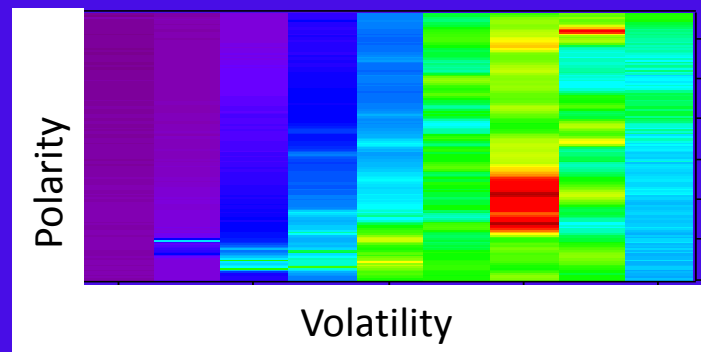
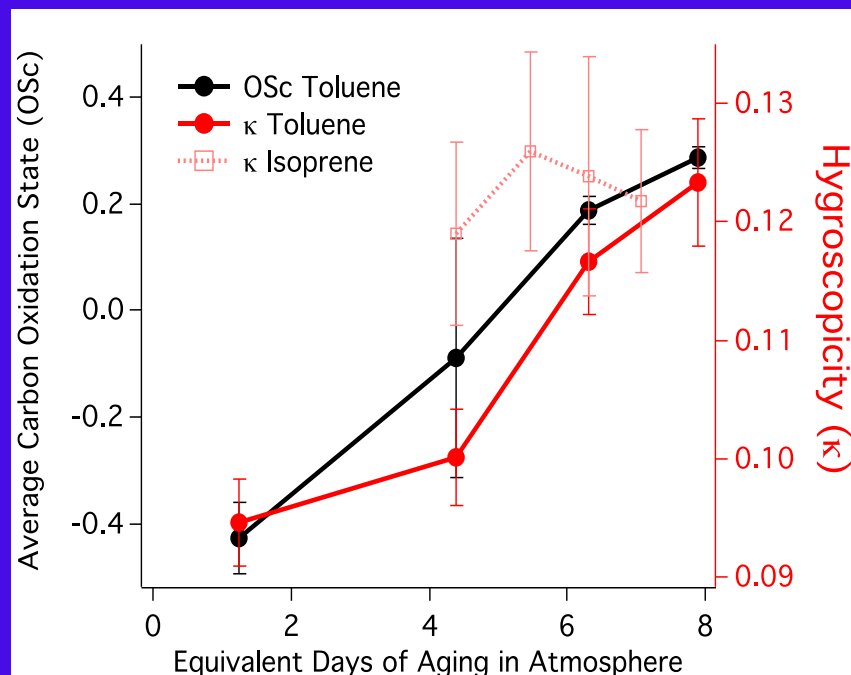

Currently attempting to map hygroscopicity onto 2D VAPS maps of volatility- and polarity-separated OA functional groups.

Conclusions

- Our **novel research tools** are offering new insights on the chemical composition of atmospheric OA
- A combination of **new binning analysis techniques**, incorporation of **thermal decomposition** data, and **controlled lab studies** are improving our understanding of complex ambient chemical signatures observed by TAG, VAPS, and AMS
- VAPS data from **SOAS** (Alabama) suggests major contributions to OA loadings from **Terpene SOA** and additional contributions from **Isoprene SOA** not previously reported.
- OA observed during **SLAQRS** (St. Louis Region) was composed of a mix of **anthropogenic sources** with **biogenic events** delivered from the Ozarks. **Nighttime chemistry** plays an important role during these periods of biogenic influence. Larger-scale studies should be performed in this region of interest.

