

STANDARD OPERATING PROCEDURE

**DRI Model 2015 Multiwavelength Thermal/Optical Carbon Analysis (TOR/TOT)
of Aerosol Filter Samples – Method IMPROVE_A for the Chemical Speciation Network
(CSN)**

February 28, 2017

Prepared by:

**Environmental Analysis Facility
Desert Research Institute
Division of Atmospheric Sciences
2215 Raggio Parkway
Reno, NV 89512**

(775) 674-7074

Prepared By: *Wang*

Date: 2/28/2017

Reviewed By: *Jim Zittel*

Date: 2/28/2017

Approved By: *Judith Chou*

Date: 2/28/2017

TABLE OF CONTENTS

	<u>Page</u>
1 INTRODUCTION	6
1.1 Purpose of Procedure	6
1.2 Measurement Principle	6
1.3 Measurement Interferences and Their Minimization.....	7
1.4 Ranges and Typical Values of Measurements	8
1.5 Typical Lower Quantifiable Limits, Precision, and Accuracy	9
1.6 Personnel Responsibilities	9
1.7 Definitions for IMPROVE_A Thermal Protocol for Carbon Analysis	9
1.8 Related Procedures.....	12
2 APPARATUS, INSTRUMENTATION, REAGENTS, AND FORMS ..	13
2.1 Apparatus and Instrumentation	13
2.1.1 Description.....	13
2.1.2 Instrument Characterization.....	14
2.1.3 Maintenance.....	16
2.2 Spare Parts List	16
2.3 Reagents.....	18
2.3.1 Chemicals.....	18
2.3.2 Gases.....	19
2.4 Forms, Paperwork, and Logbook.....	19
3 CALIBRATION PROCEDURES AND STANDARDS.....	23
3.1 Types of Instrument Calibrations.....	23
3.2 End-of-Run Calibration	23
3.3 Daily Routine Calibration	23
3.3.1 Automated Routine Gas Calibration.....	23
3.3.2 Manual Routine Gas Calibration	25
3.3.3 Daily Routine Sucrose and KHP Calibration.....	26
3.4 Full Carbon Calibration	27
3.4.1 Full Carbon Calibration Description.....	27
3.4.2 Preparation, Ranges and Traceability of Standards	27
3.4.3 Full CH ₄ and CO ₂ Gas Calibration Instructions	28
3.4.4 Full Sucrose and KHP Calibration Instructions.....	29
3.4.5 Calculating Calibration Slope	30
3.4.6 Typical Accuracy of Calibration Standards	32
3.4.7 Carbon Calculation	32
3.5 Temperature Calibration	33
3.5.1 Calibration with Temperature Indicators	33
3.5.1.1 Temperature Indicators	33
3.5.1.2 Analyzer Preparation	33
3.5.1.3 Standard Preparation.....	33

Title: DRI Model 2015 Multiwavelength Carbon Analysis
(TOR/TOT) of Aerosol Filter Samples - Method IMPROVE_A for CSN

3.5.1.4	Temperature Program	34
3.5.2	Temperature Calibration with a NIST Certified Thermocouple.....	35
4	ROUTINE PROCEDURES	38
4.1	Analyzer Start-Up	38
4.1.1	Leak Checks.....	39
4.1.2	Oven Bake.....	41
4.1.2.1	Manual Oven Bake	41
4.1.2.2	Automatic Oven Bake.....	41
4.1.3	Laboratory Blanks.....	43
4.1.4	Daily Routine Startup Calibrations.....	44
4.2	OC/EC ANALYSIS	44
4.2.1	Carbon Analysis Preparation	44
4.2.2	Software Setup Procedures	44
4.2.3	OC/EC Analysis.....	45
4.2.4	Post-Analysis	48
4.2.5	Special Analysis.....	49
4.2.5.1	System Blanks.....	49
4.2.5.2	Carbonate Analysis	49
4.2.6	Analyzer Shut-Down	50
4.3	DAILY OPERATOR CHECKLIST	51
4.3.1	General.....	51
4.3.2	Each Analyzer.....	51
4.3.3	Routine Sample Analysis.....	51
4.3.4	Routine Precautions	52
5	QUANTIFICATION	55
5.1	Measurement Calculations.....	55
5.2	Precision (Uncertainty) Calculations	55
6	QUALITY CONTROL	56
6.1	Acceptance Testing.....	56
6.2	Performance Testing	56
6.3	Reproducibility Testing	57
6.4	Control Charts and Procedures	58
6.5	Data Validation	58
6.5.1	Analysis Flags.....	58
6.5.2	Daily Validation.....	58
6.5.3	Validation of Data File.....	62
6.6	Summary of Quality Assurance/Quality Control Activities	65
7	REFERENCES	69
8	CHANGE DOCUMENTATION.....	71
APPENDIX A: Abbreviations and Acronyms		72
APPENDIX B: Basic Troubleshooting Guide.....		75

LIST OF TABLES

	<u>Page</u>
Table 3-1. Daily analyzer calibration schedule.....	24
Table 3-2. Example of calibration summary worksheet used to determine calibration slope.	31
Table 4-1. Detailed suggested metadata and protocols for analysis types.....	53
Table 6-1. Common laboratory analysis flags.	59
Table 6-2. Laboratory carbon analysis technician temporary data validation flags.	65
Table 6-3. Summary of Quality Assurance/Quality Control Activities for IMPROVE_A Analysis of Carbon*	66

LIST OF FIGURES

	<u>Page</u>
Figure 2-1. Schematic diagram of the DRI Model 2015 Multiwavelength Carbon Analyzer.....	13
Figure 2-2. Flow diagram of DRI Model 2015 Multiwavelength Thermal/Optical Carbon Analyzer.....	15
Figure 2-3. Schematic sealing diagram of the DRI Model 2015 Multiwavelength Thermal/Optical Carbon Analyzer.	15
Figure 2-4. Example of carbon analysis logbook format.....	20
Figure 2-5. Example of a DRI Carbon Sample Analysis Run List.	21
Figure 2-6. Example of daily analyzer check list.	22
Figure 3-1. Calibration thermogram from the AutoCalib protocol.....	24
Figure 3-2. Example of a DRI carbon analyzer carbon calibration curve.	31
Figure 3-3. Calibration Controls, Oven Calibration.	36
Figure 3-4. Temperature ramping with a Tempilaq° G Indicator rated at 184 °C. Also shown are reflectance and transmittance of the temperature indicator. The vertical dashed line indicates the achievement of the rated temperature.	36
Figure 3-5. Reflectance and transmittance measurements and their first and second derivatives over time with a Tempilaq° G temperature indicator rated at 184 °C (Figure 3-4). The vertical dashed line indicates the achievement of the rated target temperature.....	37
Figure 3-6. Example of temperature regression and toggle point determination.	37
Figure 4-1. Carbon2015 software screens: a) Query Status; and b) Software Selection.....	39
Figure 4-2. Calibration Controls - Flow Calibration.	40
Figure 4-3. Analyze Sample Screen.....	42
Figure 4-4. Enter Sample Details Screen.....	42
Figure 4-5. Sample analysis status screen.....	46
Figure 4-6. Sample analysis status screen with prompt to open the chamber.	46
Figure 4-7. Sample analysis status screen with prompt to load the sample punch.	47
Figure 4-8. End of run form for entering post-analysis flags and comments.	47
Figure 4-9. Example of tabular data printout of sample analysis.	48
Figure 4-10. Example of graphical printout of sample analysis thermogram.....	49
Figure 6-1. Example of carbon analyzer replicate checklist.....	57

1 INTRODUCTION

1.1 Purpose of Procedure

This standard operating procedure is intended to:

- Provide a basic understanding of the principles of carbon analysis and carbon analyzer operation;
- Describe routine determination of organic, elemental, and carbonate carbon from ambient- and source-filter samples using the DRI Model 2015 Multiwavelength Thermal/Optical Carbon Analyzer; and
- Detail the concerns and procedures which will ensure a state-of-the-art carbon analysis measurement process.

1.2 Measurement Principle

Thermal/optical carbon analysis is based on the preferential oxidation of OC and EC materials under different temperatures and atmospheres (Watson et al., 2005). Its function relies on the fact that organic compounds can be volatilized from the sample deposit in a non-oxidizing helium (He) atmosphere, while EC must be combusted with an oxidizer. Figure 2-1 shows a schematic diagram of the analyzer. It operates by: 1) liberating carbon compounds under different temperature and oxidation environments from a small sample punch (~0.5 cm²) taken from a quartz-fiber filter or other sample forms; 2) converting these compounds to carbon dioxide (CO₂) by passing the volatilized compounds through an oxidizer (heated manganese dioxide, MnO₂); 3) quantifying the CO₂ by a nondispersive infrared (NDIR) CO₂ detector (Chen et al., 2015; Chow et al., 2015).

Seven modulated diode lasers measure the reflectance (R) from, and transmittance (T) through, each filter sample at wavelengths from 405 to 980 nm (Chen et al., 2015; Chow et al., 2015). The 635 nm laser maintains the constancy with the DRI Model 2001, which uses a He-neon 632.8 nm wavelength laser to correct for pyrolysis charring of OC compounds into EC. Without this correction, the OC fraction of the sample might be underestimated and the EC fraction might include some pyrolyzed OC. The correction for pyrolysis is made by continuously monitoring the sample R and T throughout an analysis cycle. The R and T, largely dominated by the presence of light absorbing carbon, decrease as pyrolysis takes place and increase as light-absorbing carbon is liberated during the latter part of the analysis. By monitoring the R and T, the portion of the EC peak corresponding to pyrolyzed OC can be accurately assigned to the OC fraction. The correction for the charring conversion of OC to EC is essential for a less-biased measurement of carbon fractions (Johnson et al., 1981). The Thermal Optical Reflectance (TOR) and Thermal Optical Transmittance (TOT) charring corrections are not necessarily the same, owing to charring of organic vapors adsorbed within the quartz fiber filter (Chen et al., 2004; Chow et al., 2004). Traditionally, charring is only monitored by one red laser. The multiwavelength R and T monitoring provides an opportunity to systematically study charring under different wavelengths

and potentially improve the charring correction accuracy. Charring by both reflectance and transmittance for all seven lasers is reported.

The multiwavelength measurements allow estimation of light absorption by black carbon (BC) and brown carbon (BrC) as well as their absorbing properties (Andreae and Gelencser, 2006; Moosmüller et al., 2009). BC dominates the light absorption at red and near infrared wavelengths, while BrC absorbs strongly in the shorter wavelengths (<600 nm). In the DRI Model 2001, the 632.8 nm R measure of filter darkening, similar to that of British Smoke (Heal and Quincey, 2012), was used to further demonstrate a consistent EC trend when the Model 2001 replaced the earlier DRI/OGC analyzers (Chen et al., 2012; Chow et al., 1993). In Model 2015, R and T allow spectral light absorption properties for each sample to be estimated by taking the ratio of the initial R and T to the final R and T after the light absorbing carbon was removed, leaving a filter remnant that was usually white, like the unexposed filter. Using filter transfer standard characterized by a UV-VIS-NIR spectrophotometer (e.g., Lambda 35, Perkin Elmer, Waltham, MA), absolute spectral R, T, and absorption can be quantified (Chen et al., 2015; Chow et al., 2015). Using a simplified two-component model consisting of BC and BrC (Sandradewi et al., 2008), each with explicit absorption Ångström exponents, their contributions to spectral light absorption can be estimated. When mass- and wavelength- specific absorption efficiencies are measured or assumed, the optical BC and BrC mass can also be estimated (Chen et al., 2015).

Carbonate carbon can be determined by measuring the CO₂ evolved upon acidification of the sample punch before the normal carbon analysis procedure.

When the IMPROVE_A protocol (Chen et al., 2015; Chow et al., 2007; 2011; 2015) is used, the Values routinely reported include: 1) total carbon (TC, sum of total OC and total EC); 2) seven-wavelength total OC and total EC; 3) seven temperature fractions (i.e., OC1-4 and EC1-3); 4) pyrolyzed carbon, monitored by both reflectance (OPR) and transmittance (OPT) for each of the seven wavelengths; and 5) attenuation by reflectance and transmittance for each wavelength. Carbonate carbon is also reported when its analysis is specified by the analytical protocol.

1.3 Measurement Interferences and Their Minimization

Precision of thermal/optical carbon analysis depends on the sample temperature in the analysis. Therefore, the correlation between sample temperature and thermocouple temperature should be established and calibrated semiannually so that the thermal protocol can truly reflect the sample temperature during the analysis (Chow et al., 2005). The thermocouple's position in relation to the sample, as well as the different heating properties of the thermocouple and the sample, govern the temperature offset. This relationship must be maintained for the temperature calibration to hold. The analyzer must not be used if the sample boat shifts position or becomes loose in its holder.

Carbonate carbon may bias carbon concentrations if it constitutes more than 5% of TC in the ambient or source sample. Carbonate carbon may be measured as either OC or EC depending on the chemical nature of the carbonates and their thermal decomposition temperatures. Acid pretreatment of filter samples can eliminate the carbonate interference (Novakov, 1981; Novakov, 1982; Rosen et al., 1982). Carbonate carbon has been found at only a few IMPROVE monitoring

sites, and the levels at these sites do not appreciably bias OC and EC concentrations (Chow et al., 2001; Chow and Watson, 2002).

The presence of certain minerals in some soils can affect the laser correction for pyrolysis. These minerals change color as the sample punch is heated, generally resulting in a darker sample. For samples which contain large fractions of resuspended soils, the split between OC and EC should be examined manually.

Some minerals, again predominantly in soil samples or soil-dominated samples, may affect the laser correction by temporarily changing color or changing the surface texture of the deposit residue. Unlike the effect described above, these changes are reversible and temperature-dependent.

Some colored organic compounds can affect the laser correction, causing increased reflectance or decreased transmittance as these compounds are removed. This effect is ascertained by examining the laser response during the organic portion of the analysis. The split between OC and EC should be examined manually if the effect is large.

The presence of certain elements (Na, K, V, Cr, Mn, Co, Ni, Cu, and Pb), existing either as contaminants on the filters (e.g., glass-fiber filters or borosilicate binders), or as part of the deposit material, has been shown to catalyze the removal of EC at lower temperatures (Lin and Friedlander, 1988). Such catalysis would affect the distribution of carbon peaks during the analysis.

Water vapor (either contained in the deposit or remaining after acidification of the sample punch), if present in sufficient levels, can shift the NDIR baseline. To eliminate this effect, allow the sample punch to dry in the analyzer by passing carrier gases over it before starting the analysis.

1.4 Ranges and Typical Values of Measurements

Source-dominated or heavily polluted environments, which would normally have carbon concentrations above the working range of the carbon analyzer, may be sampled and analyzed within the range of the carbon analyzer by increasing the filter deposit area or by decreasing the sampling flow in the field equipment. Deposits that are very black, such that the initial reflectance is close to zero, provide a less precise OC/EC split, because additional blackening due to OC charring is not quantified by the reflected light.

The carbon analyzer can effectively measure between 0.1 and 4000 $\mu\text{g carbon/cm}^2$ for a typical punch size of 0.5 cm^2 . The upper limit depends on the particular compounds on the filter and the temperatures at which they evolve. This upper limit may be extended by reducing the punch size or extending analysis times at lower temperature plateaus to avoid an over-range NDIR signal.

Typical carbon values range between 10 and 100 $\mu\text{g C/cm}^2$ for 24-hour ambient samples. The distribution between OC and EC depends on the particulate source types, ranging from negligible levels of EC (e.g., secondary sulfate) to 80% or more EC (e.g., diesel exhaust).

1.5 Typical Lower Quantifiable Limits, Precision, and Accuracy

MDLs (minimum detection limits) and LQLs (lower quantifiable limits) are defined as three times the standard deviation of the instrument response to a known concentration of zero (ie., a filter extract using laboratory blanks) and dynamic field blanks, respectively (Chow and Watson, 1999). MDLs reflects instrument performance at low analyte concentrations, used to ensure no contamination of filter lots and establish instrument sensitivity. LQL provides background levels in passive field samples (the dynamic field blank may vary from each airborne particle sampling program and sampling location).

1.6 Personnel Responsibilities

Before performing carbon analysis, all analysts in the laboratory should read and understand the entire Standard Operating Procedure (SOP), including routine system calibration, actual analysis, and immediate review of the data as it is produced, and how to correct system problems.

The responsibilities of the laboratory manager or supervisor are: to ensure that the carbon analyses procedures are properly followed; to examine and document all replicate, standard, and blank performance test data; to designate samples for reanalysis; to arrange for maintenance and repair of instruments; to verify an adequate quantity of supplies and gases are in stock to ensure uninterrupted analysis; and to deliver the analysis results in database format to the project manager within the specified time period.

The quality assurance (QA) officer of DRI's DAS is responsible for determining the extent and methods of quality assurance to be applied to each project, to estimate the level of effort involved in this quality assurance, to periodically review and assess quality assurance and quality control data, to update this procedure periodically, and to ascertain that these tasks are budgeted and carried out as part of the performance on each contract.

1.7 Definitions for IMPROVE_A Thermal Protocol for Carbon Analysis

The following terms are used in this document:

IMPROVE_A Thermal Protocol:	A thermal protocol used in carbon analyzers to quantify carbon fractions evolved at different temperature plateaus and atmospheres. The IMPROVE_A thermal protocol derives from the Interagency Monitoring of Protected Visual Environments (IMPROVE) thermal protocol initiated in 1987 (Chow et al., 2005; 2007).
Calibration Injection:	The injection of calibration gases, either CO ₂ or CH ₄ , into the sample stream at the beginning and end of each work day to check instrument performance.

Calibration Peak:	The peak of (NDIR CO ₂ concentration × NDIR flow rate / 120) resulting from the automatic injection of methane calibration gas (CH ₄ /He) at the end of each analysis run for each sample. All integrated peak areas are divided by the calibration peak area and multiplied by an instrument-specific calibration factor to obtain µg carbon per sample punch.
Elemental Carbon (EC):	Carbon evolved from the filter punch in a 98% He/2% O ₂ atmosphere at 580, 740, and 840 °C minus any pyrolyzed OC at each laser wavelength (405, 445, 532, 635, 780, 808, 980) for Reflectance (R) and Transmittance (T).
EC1:	Carbon evolved from the filter punch in a 98% He/2% O ₂ atmosphere at 580 °C.
EC2:	Carbon evolved from the filter punch in a 98% He/2% O ₂ atmosphere from 580 to 740 °C.
EC3:	Carbon evolved from the filter punch in a 98% He/2% O ₂ atmosphere from 740 to 840 °C.
High Temperature OC:	Carbon evolved from the filter punch in a He-only atmosphere at 280, 480, and 580 °C plus pyrolyzed organic carbon. This is OC minus the first OC peak (OC1).
High Temperature EC:	Carbon evolved from the filter punch in a 98% He/2% O ₂ atmosphere at 740 and 840 °C minus any pyrolyzed organic carbon present in these two peaks. This is EC minus the first EC peak (EC1).
Laser Split:	The separation between OC and EC, which depends on the laser-measured reflectance and/or transmittance of the filter punch returning to its initial value. At this point all pyrolyzed OC has been removed and EC is beginning to evolve.
Laser Split Time:	The time at which each laser split occurs plus the transit time required for thermally evolved carbon to travel from the sample punch to the NDIR. It has 14 values including seven for reflectance and seven for transmittance.
Lower Split Time:	The time at which the laser-measured reflectance and/or transmittance of the filter punch reaches its initial value minus the precision of the laser signal (currently defined as one standard deviation of the laser baseline).

Title: DRI Model 2015 Multiwavelength Carbon Analysis
(TOR/TOT) of Aerosol Filter Samples - Method IMPROVE_A for CSN

- Organic Carbon (OC):** Carbon evolved from the filter punch in a He-only (> 99.999%) atmosphere at 140, 280, 480 and 580 °C plus pyrolyzed organic carbon at each laser wavelength (405, 445, 532, 635, 780, 808, 980) for Reflectance (R) and Transmittance (T).
- OC1:** Carbon evolved from the filter punch in a He-only (> 99.999%) atmosphere from ambient (~25 °C) to 140 °C.
- OC2:** Carbon evolved from the filter punch in a He-only (> 99.999%) atmosphere from 140 to 280 °C.
- OC3:** Carbon evolved from the filter punch in a He-only (> 99.999%) atmosphere from 280 to 480 °C.
- OC4:** Carbon evolved from the filter punch in a He-only (> 99.999%) atmosphere from 480 to 580 °C.
- OP:** The carbon evolved from the time that the carrier gas flow is changed from He to 98% He/2% O₂ at 580 °C to the time that the laser-measured filter reflectance (OPR) or transmittance (OPT) reaches its initial value. A negative sign is assigned if the laser split occurs before the introduction of O₂. The Model 2015 reports OPR and OPT for each of the seven wavelengths (405, 445, 532, 635, 780, 808, 980).
- Pyrolysis:** The conversion of OC compounds to EC due to thermal decomposition; this may be envisioned as "charring" during the organic portion of the analysis.
- Regular Split Time:** The time at which the laser-measured reflectance and/or transmittance of the filter punch reaches its initial value.
- Total Carbon (TC):** All carbon evolved from the filter punch between ambient and 840 °C under He and 98% He /2% O₂ atmospheres.
- Transit Time:** The time required for thermally evolved carbon to travel from the sample punch to the NDIR. It is approximated by the time between CH₄ injection through the light pipe near the filter punch and the detection of the CO₂ peak by the NDIR.

Upper Split Time: The time at which the laser-measured reflectance and/or transmittance of the filter punch reaches its initial value plus the precision of the laser signal (currently defined as one standard deviation of the laser baseline).

1.8 Related Procedures

Standard Operating Procedures (SOPs), related carbon analysis activities, and other manuals that should be reviewed in conjunction with this document are:

- DRI SOP #2-106 Pre-Firing of Quartz Filters for Carbon Analysis.
- DRI SOP #2-111 Sample Shipping, Receiving and Chain-of-Custody
- DRI SOP #4-118 Testing Oxygen Level in Helium Atmosphere of Carbon Analyzers

The DRI Multiwavelength Thermal/Optical Carbon Analyzer: Installation, Operation, and Service Manual revised 11/2015 (Desert Research Institute, Reno, NV).

2 APPARATUS, INSTRUMENTATION, REAGENTS, AND FORMS

2.1 Apparatus and Instrumentation

2.1.1 Description

The components of the DRI Model 2015 Multiwavelength Thermal/Optical Carbon Analyzer are depicted in Figure 2-1 through 2-3. Other details of the configuration of the DRI Model 2015 are referred to the Installation, Operation, and Service Manual. The programmable combustion oven is the heart of the carbon analyzer and includes loading, combustion, and oxidation zones in a single quartz cross "oven" as depicted in Figure 2-3.

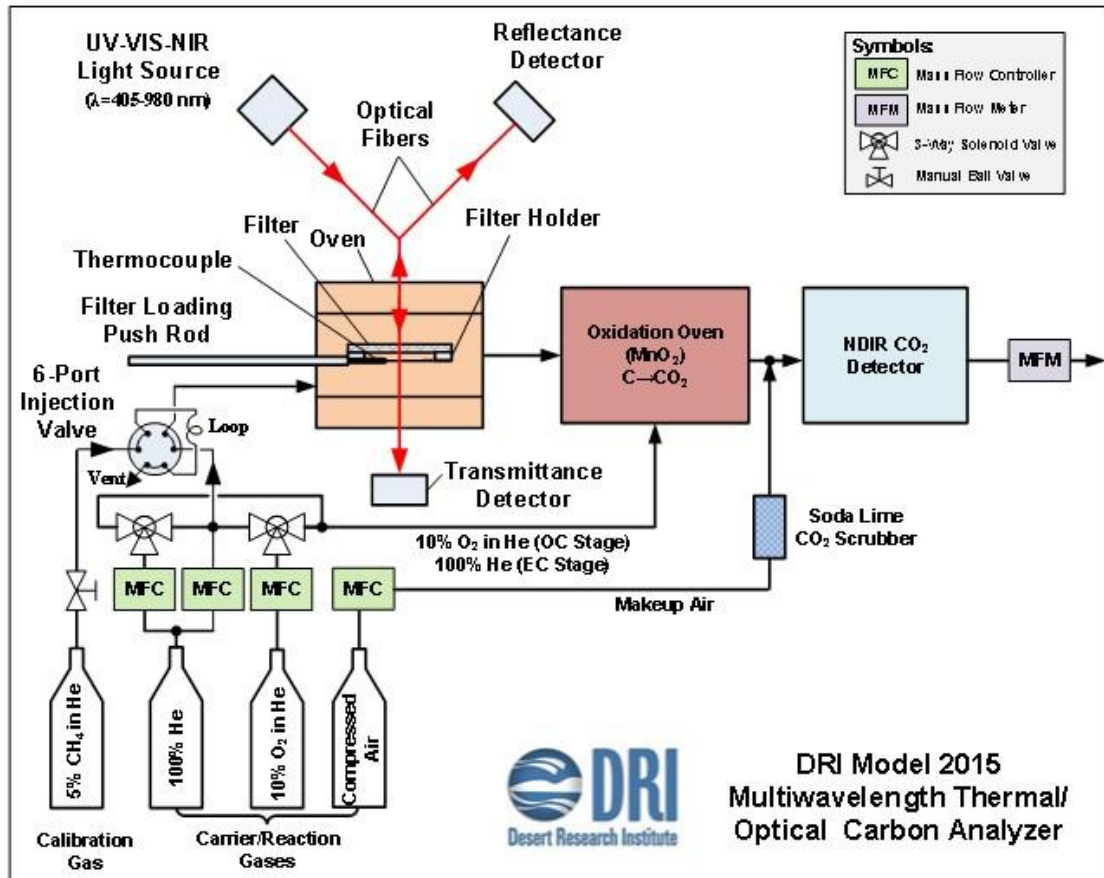

Figure 2-1. Schematic diagram of the DRI Model 2015 Multiwavelength Carbon Analyzer.

In addition to the DRI Model 2015 Multiwavelength Thermal/Optical Carbon Analyzer, which is connected to a computer, the following items are needed for routine carbon analysis:

- Stainless steel punching tool: 5/16-inch diameter, 0.5 cm² nominal area for removing small sample punches from quartz filters. This punching tool must be kept clean and sharp. If

the punching tool is resharpened, the punch area must be re-verified. Verification is performed by removing 10 punches from a 47-mm quartz-fiber filter (17.35 cm²); then calculating the punch area [= 17.35 cm² x (initial filter weight minus the final weight after punches have been removed) / 10 times the initial filter weight]. Further verification can be done by taking a precise measurement of the punching tool.

- Syringes: Hamilton Gas-Tight 1000 and 2500 µl syringes for calibration injections; 25 µl syringe for carbonate analysis and for analyzer calibration.
- Quartz filters: Pallflex® Tissuquartz, 2500 QAT-UP (Pall Life Sciences, Ann Arbor, MI) quartz-fiber filter or equivalent.
- Flat-tip tweezers.
- Flat glass plate.
- Logbook/notebook.
- Transparent tape.
- KIMTECH Pure* CL4 Critical Task Wipes and large KimWipes (EX-L).
- Small Styrofoam cooler or refrigerator.
- Blue ice (if using Styrofoam cooler).
- Butane or piezoelectric lighter.
- A copy of *Carbon2015* software (the analysis program) and Microsoft Word for printing thermograms and data output.

2.1.2 Instrument Characterization

The DRI Model 2015 Multiwavelength Thermal/Optical Carbon Analyzer is program-driven. Data is stored automatically to the hard drive via a PC-compatible computer processor board. The transit time is built into the parameter file that is loaded when the analysis program begins. The program is driven by the thermal protocol. For example, when using the IMPROVE_A protocol, the program will advance to the next temperature or carrier gas mixture once the NDIR signal returns to its baseline; i.e., after a minimum of 150 seconds at one analysis condition. A maximum time limit (580 seconds) per analysis condition is also established to prevent a slight baseline drift from holding the analyzer in one condition indefinitely. This method requires at least one ~0.5 cm² punch per filter and does not require sample pre-treatment. The sample punch is destroyed after analysis.

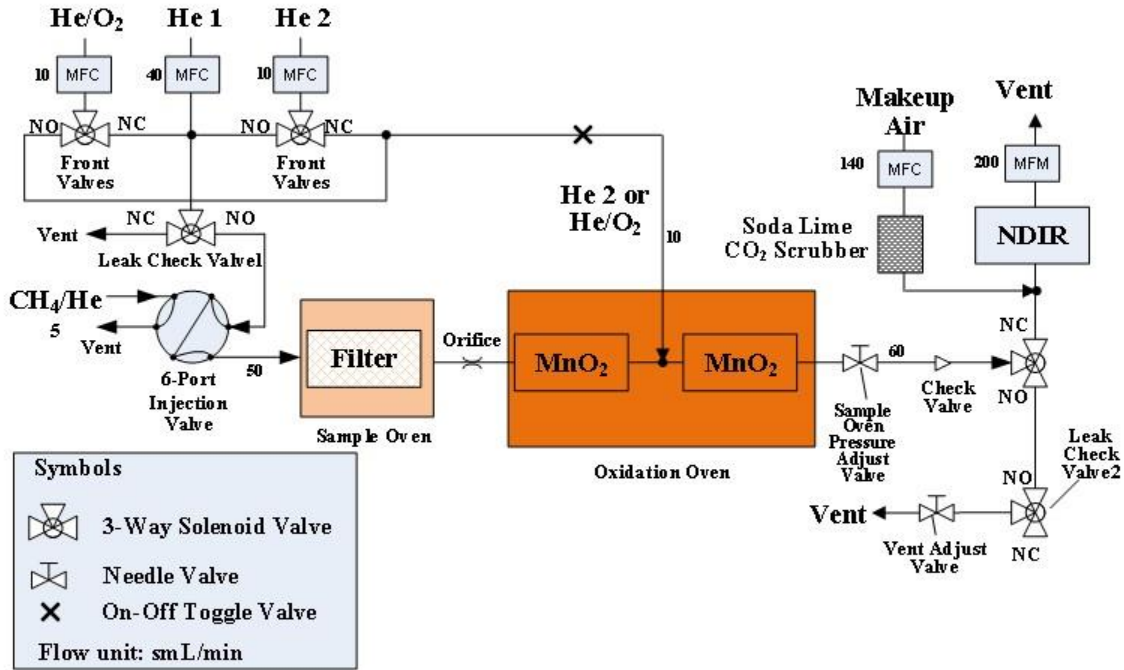

Figure 2-2. Flow diagram of DRI Model 2015 Multiwavelength Thermal/Optical Carbon Analyzer.

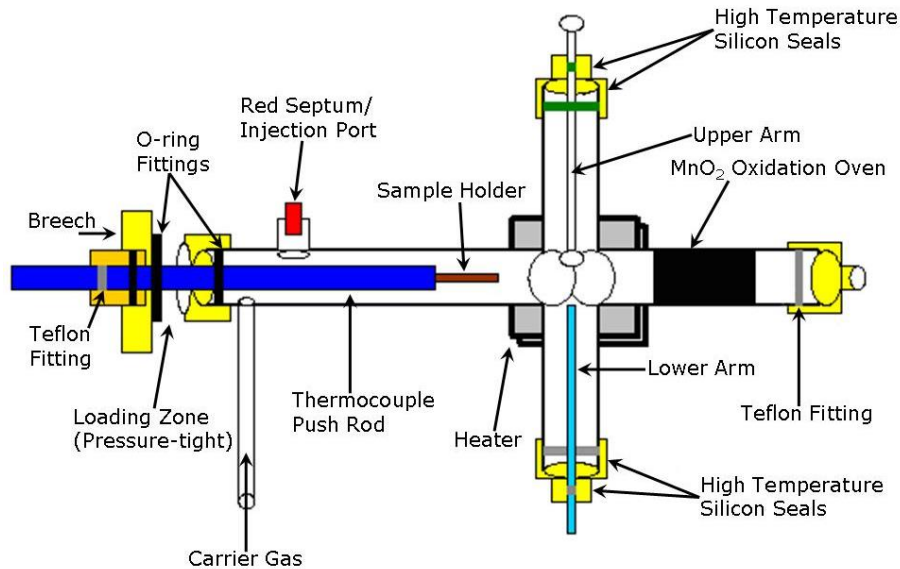

Figure 2-3. Schematic sealing diagram of the DRI Model 2015 Multiwavelength Thermal/Optical Carbon Analyzer.

Note: In the breech, there is a Teflon-reducing ferrule to seal the pushrod thermocouple, plus two O-rings to seal the breech against the inlet (coupler) connector and one Teflon fitting (See the Model 2015 Manual for more details).

Operator concerns for correct routine operation of the instrument include the following (refer to Section 4 for more details):

- Verify sample oven pressure reading and specified flow range.
- DO NOT leave the room until the analysis begins.
- Check analysis status screens during and after each analysis run to ensure that the: 1) NDIR, 2) temperature, and 3) laser signals are behaving as expected (Section 6.6). Report any anomalies to the lab supervisor immediately.
- The quartz oven is susceptible to breakage. Care should be taken when handling and cleaning.
- Be careful that no fiber from the KIMTECH wipe is left on the sample punch, tweezers, and/or glass plate.

2.1.3 Maintenance

Regular maintenance for the analyzer involves daily checking of compressed gas supplies, cleaning the punching tool and tweezers between each sample with dry KIMTECH wipes, ensuring that the lab is clean, and backing up data files to disc on a daily basis (unless files are automatically backed up to server). Temperature calibrations for the six temperature plateaus (140, 280, 480, 580, 580, 740, and 840°C) need to be performed semiannually (see details in Section 3.5). Checks of laser adjustments and leaks are made at least monthly or on an as needed basis. The procedure for leak checks can be found in Section 4.1.1. Additional leak tests are performed with a He leak detector each time a part is replaced, or whenever the analyzer fails the leak check during the daily routine. The system should show no He leaks at the various connections of the quartz cross oven. Since He has high diffusivity, freedom from He leaks will safeguard against O₂ diffusion into the system. These O₂ levels are determined semi-annually using a gas chromatography/mass spectrometry (GC/MS) instrument on the analyzer. Quarterly levels are determined using an O₂ detector that is calibrated against the GC/MS. This is also used when a fresh He cylinder is installed to assure the quality of the gas supply and the condition of the O₂ scrubber. If the *AutoCalib* command is used for calibration, the condition of the MnO₂ oxidizer will be indicated and appropriate action can be taken (such as MnO₂ replacement). All calibrations, repairs, and checks must be recorded in the Carbon Analyzer Logbook (Figure 2-4). Flow rates of all operating gases should be checked and adjusted (if needed) whenever a new quartz oven is installed or serviced. Additionally, a flow check and balance should be performed as well.

2.2 Spare Parts List

The following spare parts must be kept on hand to ensure minimal interruptions in carbon analysis:

- Quartz oven cross available from the manufacturer (Continental Glass Engineering, Burbank, CA; Part No. DRXMOD15).

Title: DRI Model 2015 Multiwavelength Carbon Analysis
(TOR/TOT) of Aerosol Filter Samples - Method IMPROVE_A for CSN

-
- Quartz rods: 3 mm nominal diameter, optical quality (Continental Glass Engineering, Burbank, CA), polished for optical clarity with 108 mm (upper arm; Part No. ATM0003-3) and 119 mm (lower arm; Part No. ATM003-2) lengths.
 - Quartz Discs (for Tempilaq temperature calibration): 0.5 cm² disc (custom made by Continental Glass Engineering, Burbank, CA)
 - Quartz boats (CGE1021112-1R1, Continental Glass Engineering, Burbank, CA).
 - Glass plate (4" Dia.×1/4"thick, clear surface, Continental Glass Engineering, Burbank, CA)
 - Push rod thermocouple rod: 24.13 cm length by 0.32 cm outside diameter (OD), Type-K ground isolated with Inconel sheath (George T. Hall Co, K23EMHZ-011(13/32)-00-18-T3012-2, Sparks, NV). Remove 1 cm of the sheath with a file to obtain the longer tip needed in this application.
 - Orange ¼" Cylindrical Injection Septum for injection ports. (Grace Discovery Sciences, Catalog No. 6526)
 - High temperature silicon septa 0.25 cm and 1.11 cm for oven seals (Alltech #15427 and #15429, Deerfield, IL).
 - Oxidation oven replacement thermocouple (Omega; Part No. KMQXL-032G-6)
 - Quartz wool: For repacking the oxidation oven (Alltech Associates, #4033, Deerfield, IL)
 - Graphite ferrules (3/16", Grace Discovery Sciences, SF-300-G, Deerfield, IL)
 - Teflon ferrules: 0.32 cm to 0.64 cm for the thermocouple rod at the inlet breech (Alltech Associates, #RF-400/200-T, Deerfield, IL).
 - Teflon ferrules: Swagelok front and back ferrule for the quartz oven tube outlet connections (Swagelok, T-400-SET, Solon, OH).
 - High Temperature Silicone O-rings: 9/16" ID; ¾ OD; 3/32" Width. Two needed for quartz oven tube inlet. (Part No. 9396K26, McMaster-Carr)
 - Polyester Wipes for cleaning surfaces (Part# AMDE003 Radnor, PA)
 - 1 ml gas tight syringe for gas injections.
 - 25 µl syringes for liquid injections.
 - Replacement needles for syringes (Alltech #7729-06, Deerfield, IL).
 - MnO₂ Conditioning Heater: 15.24 cm length, 2.54 cm tube diameter element from the analyzer supplier. (Watlow, #VC401A06A-0000R [90° bend], Columbia, MO)
 - NDIR replacement (PP Systems, Part#AGA407, Amesbury, MA).
 - Oxygen/moisture trap (R&D Separations, Model OT3-2, Rancho Cordova, CA).

-
- Hydrocarbon trap (R&D Separations, Model HT200-4, Rancho Cordova, CA).
 - Indicating oxygen trap (Chromatography Research Supplies, Model 202223, Louisville, KY).
 - O₂ tester for checking O₂ level in the analyzer (0-500 ppm).
 - Flow meter (5-500 mL/min; e.g., Bios Defender 510; Mesa Labs, Butler, NJ) for flow calibration.
 - NIST-calibrated thermocouple (0-1500 °C) for temperature calibration.
 - Thermocouple: Digi-Sense Type-K, Hi-Temp 25In L, .063In Dia Probe, Mini Conn, GRD, 3Ft 24-Ga. (Item# FF-93631-21, Cole-Parmer Instrument Company)
 - Reader: OAKTON Temp-10 type K thermocouple thermometer with boot (Item# FF-91427-10, Cole-Parmer Instrument Company)
 - NIST-Traceable Calibration: (Item# FF-17002-10, Cole-Parmer Instrument Company)
 - Printer paper and toner cartridge.
 - Computer CD, memory stick, external hard drive for data backup.

2.3 Reagents

2.3.1 Chemicals

The following chemicals should be reagent grade or better:

- Potassium hydrogen phthalate (KHP), for calibration (Fisher Scientific, cat #P-243, CAS 877-24-7, Fairlawn, NJ).
- Sucrose, for calibration use (EM Science, #SX1075-1, Gibbstown, NJ).
- Custom Sucrose and KHP Solutions 1800ppm at 99.9% purity (ERA Golden, CO www.eraqc.com)
- Manganese dioxide (MnO₂), crystalline, as an oxidizer in the oxidation oven (Nurnberg Scientific, #C5162, Portland, OR; Aldrich Chemicals #24344-2, St. Louis, MO; or equivalent).
- Soda Lime 4-8 mesh for carbon dioxide scrubber (VWR, Part# JT3447-1(500g) Radnor, PA)
- Hydrochloric acid (HCl), 0.4 molar solution, for use in cleaning punch and quartz ovens, and for use in carbonate analysis (Fisher Scientific, cat #A508-212, CAS 7647-01-0, Fairlawn, NJ).
- Nanopure water.
- Tempilaq Liquid (MSC Industrial Supply Melville, NY)

Title: DRI Model 2015 Multiwavelength Carbon Analysis
(TOR/TOT) of Aerosol Filter Samples - Method IMPROVE_A for CSN

- 121°C (Part# 99176216), 184°C (Part# 99176257), 253°C (Part# 08661316), 510°C (Part# 94530706), 704°C (Part# 60798485), 816°C (Part# 60798543)

2.3.2 Gases

The following gases should be ultra-high purity (UHP) grade or better:

- He for a carrier gas, regulated to 20-40 psi with a metal diaphragm regulator. The higher pressure is required due to the pressure drop across the Supelco oxygen scrubber.
- 5% CH₄ by volume in He for calibration injections and calibration peaks; regulated to 10 psi by a metal diaphragm regulator.
- 5% CO₂ by volume in He for calibration injections; regulated to 10 psi by a metal diaphragm regulator.
- 10% O₂ by volume in He as a carrier gas, regulated to 15 psi by a metal diaphragm regulator.
- Compressed air for pneumatic activation, regulated to ~25 psi.

At least one backup cylinder per gas type should be kept on hand at all times. Depending on analysis volume, the 90% He/10% O₂ mixture are typically replaced every four to six weeks; H₂ and He are replaced once a week. All gases are replaced when the cylinder pressure drops below 500 psi (unless the cylinders are connected to an automatic change-over module). Check the O₂ scrubber and follow the manufacturer's recommendations for scheduling its replacement.

Detailed information on the mass flow controller settings can be found in the Manual. The pneumatic drivers for the breech should have a pressure of ~25 psi to operate effectively (sealing the opening).

2.4 Forms, Paperwork, and Logbook

All samples are logged in upon receipt at the laboratory. A sample analysis list will be prepared by the laboratory supervisor or designated technician indicating which samples will be analyzed, plus any special instructions. As individual samples are analyzed, entries are made in the Carbon Analyzer Logbook, as shown in Figure 2-4. Figure 2-5 provides an example of the cover sheet of the sample analysis run list. Figure 2-6 provides an example of the Daily Analyzer Check List that is completed at the start of each day in order to verify analyzer flow and NDIR response.

7/10/12
Cont.

\Improve | A12 | R34
S65275-2 R
S65289-1
S65297-1
S65305-1
S65304-2 R
S65321-1
S65329-1

CI1020120710-1\27784\2179

\IMPROVE | A12 | R34
S65336-1

\IMPROVE | C11 | J32
S53452-2
S53444-2
S53556-2

\IMPROVE | C11 | J32
S53213-2
S53314-2
S53357-3

7/11/12
CAL

\IMPROVE | A12 | R34
S65339-1
S65344-1
S65352-1
S65359-1
S65365-1
S65372-1

Leak test

LB1020120711-1\00

SU1020120711-1\27787\18.17

\IMPROVE | A12 | R34
S65379-1
S65387-1
S65387-2 R

\IMPROVE | A12 | S34
S65401-1

Figure 2-4. Example of carbon analysis logbook format.

DRI STANDARD OPERATING PROCEDURE

Title: DRI Model 2015 Multiwavelength Carbon Analysis
(TOR/TOT) of Aerosol Filter Samples - Method IMPROVE_A for CSN

Page: 21 of 76
Date: 02/28/2017
Number: 2-231r0
Revision: 1

IMPROVE\B12\U35 July 2012: Batch U3 Quartz

Date : 09/27/12 Account: 6300-683-6081
From : T. Pascal
To : Carbon Lab
Analysis: OC/EC by TOR : 200 samples, data in IMOETU3I.DBF

Sample Overview:

This analysis list covers samples from the NPS IMPROVE project. These are 200 PM2.5 samples on 25 mm Quartz filters, including no lab blanks and 6 field blanks. These samples were collected with an Improve sampler.

Analysis Overview:

Sample deposit area: 3.53 cm²
Analysis start date: When Ready
Analysis deadline :
Sample location : Carbon Lab

Analysis Details:

Replicate 10% on Model 2001. Flag all abnormalities.
Carbon analysis data will be stored in the D:\IMPROVE\B12\U35 directory.

Figure 2-5. Example of a DRI Carbon Sample Analysis Run List.

Title: DRI Model 2015 Multiwavelength Carbon Analysis
 (TOR/TOT) of Aerosol Filter Samples - Method IMPROVE_A for CSN

Daily Analyzer Check List CA#: 10 Month: DECEMBER 2011

Date	Leak Test/Int	System Pressure (T<100°C)	Trans*	Reflec*	System Blk (TC) in µg	Calib OC3 Area	Calib EC1 Area	Calib LT/Rpy -- Inj. Peak Area	Calib Peak Area	TC Carbon OC3 autocalib, TC Su/KHP
12/25 AM	MSU	5.41	709	1561	.00	25292	24157	24167	24628	22.06
PM										
12/26 AM	SWR	5.44	696	1518	.00	-	-	-	24692	18.38
PM										
AM										
12/30 PM	TP					25976	25191	25298	25338	22.03
1/1/1 AM	CAC	5.40	718	1571						
PM									25843	17.43
1/2 AM	TP	5.36			.00	-	-	-		
PM										
1/3 AM	CAC	5.36	693	1544	0.09	26089	25277	25477	25174	18.50
1/3 PM	TP					-	-	23816	25305	20.23
1/4 AM	SWR	5.19	661	1576	.02	-	-	-	25368	17.28
PM										
1/5 AM	CAC	5.14	672	1545	0.03	25952	25212	25398	25008	17.29
1/5 PM	TP					-	-	24129	25564	20.29
1/6 AM	CAC	5.19	692	1557	0.05	-	-	-	24988	17.75
1/6 PM	SWR					26171	25519	-	25587	21.98
1/7 AM	CAC	5.21	678	1533	0.01	25643	24779	25053	24816	22.21
1/7 PM	SL					-	-	-	25877	20.57
1/8 AM	CAC	5.18	675	1545	0.03	25927	25228	25420	25369	21.88
1/8 PM	SL					-	-	-	24951	19.79
1/9 AM	SWR	5.20	642	1539	.00	-	-	-	24947	17.72
1/9 PM	TP					25409	24589	24802	24640	22.16
1/10 AM	CAC	5.15	644	1484	0.02	26632	25967	26255	25950	18.03
1/10 PM	TP					-	-	24142	25594	20.27
1/11 AM	SWR	5.16	691	1533	.02	-	-	-	25703	17.53
1/11 PM	TP					26014	25245	25426	25350	22.06
1/12 AM	CAC	5.12	626	1511	0.00	26655	26105	26317	26026	18.55
1/12 PM	TP					-	-	23818	25841	19.81
1/13 AM	CAC	5.19	604	1369	0.03	-	-	-	25577	17.77
1/13 PM	SWR					26278	25522	-	25511	22.11

* Test on a blank filter is placed on "Analyze" position.

Figure 2-6. Example of daily analyzer check list.

3 CALIBRATION PROCEDURES AND STANDARDS

3.1 Types of Instrument Calibrations

The calibration procedures for the carbon analyzers are of four types: 1) the end-of-run calibration peak; 2) the routine beginning and end-of-day calibration injections of CH₄/He (or the auto calibration check using the *AutoCalib* protocol) and CO₂/He; 3) full instrument calibration, performed every six months, using KHP, sucrose, and the two calibration gases; and 4) temperature calibrations performed every six months using temperature-sensitive indicating liquids with different melting points.

3.2 End-of-Run Calibration

The end-of-run calibration consists of a set quantity of CH₄/He calibration gas which is automatically injected through the 6-port injection valve with a nominal 1000 µL loop by the carbon program. All NDIR readings during the analysis run are normalized to this peak to minimize the effects of MnO₂ oxidation efficiency and NDIR performance change over time. The end-of-run calibration occurs automatically at the end of each analysis run and requires no operator intervention. The integrated calibration peak counts should be checked by the operator immediately after each run to confirm that the analyzer is operating satisfactorily. Calibration peak area counts should be within an acceptable range (typically between 15,000 and 25,000 with minimal change between runs) for the specific analyzer. Check daily records to compare peak area counts and determine analyzer performance and stability.

3.3 Daily Routine Calibration

The daily routine calibration schedule is listed in Table 3-1. Routine calibrations with gas standards must be performed at the beginning and end of each day, either manually or by using the automated routine calibration *AutoCalib* protocol. Routine calibrations with sucrose or KHP are performed at the beginning of each day from Monday to Friday.

3.3.1 Automated Routine Gas Calibration

The automated calibration uses the 6-port injection valve to inject the CH₄ standard once in a He-only atmosphere, once in an O₂/He atmosphere, and finally, the normal calibration peak at the end of analysis. The three peaks should have similar areas if the MnO₂ is in good condition and the calibration factor holds (see Figure 3-1).

Use the following steps to perform this automated calibration:

- From the *Carbon2015* Software Selection screen, click the “Analyze Sample” button.
- Enter sample information details. Select the *AutoCalib* protocol. The project name should be “CALIB”, Batch # should be “YYYYmm” for the month, Sub-batch # should be “dd” for the day, and the Sample ID should be in the format “CxxYYYYmmdd” where “xx” is the analyzer number (e.g. C2220150226 for analyzer number 22, run on February 26, 2015). Look up Table 4-1 for suggested naming convention of different analysis types.

Table 3-1. Daily analyzer calibration schedule.

Daily Calibration Schedule							
(Based on 24/7 operation)							
	Sunday	Monday	Tuesday	Wednesday	Thursday	Friday	Saturday
Morning (Startup)	System Blank, Lab Blank, Autocalib	Lab Blank, Sucrose	Lab Blank, Autocalib, KHP	Lab Blank, Sucrose	Lab Blank, Autocalib, KHP	Lab Blank, Sucrose	Lab Blank, Autocalib
Evening	CO2 Injection	Autocalib	CO2 Injection	Autocalib	CO2 Injection	Autocalib	CO2 Injection

Note:
 Sucrose and KHP- Total Carbon (TC) must be between 17.1-18.9 ug C/filter in order to pass.
 System and Lab Blanks should be <0.2 µg C/cm²

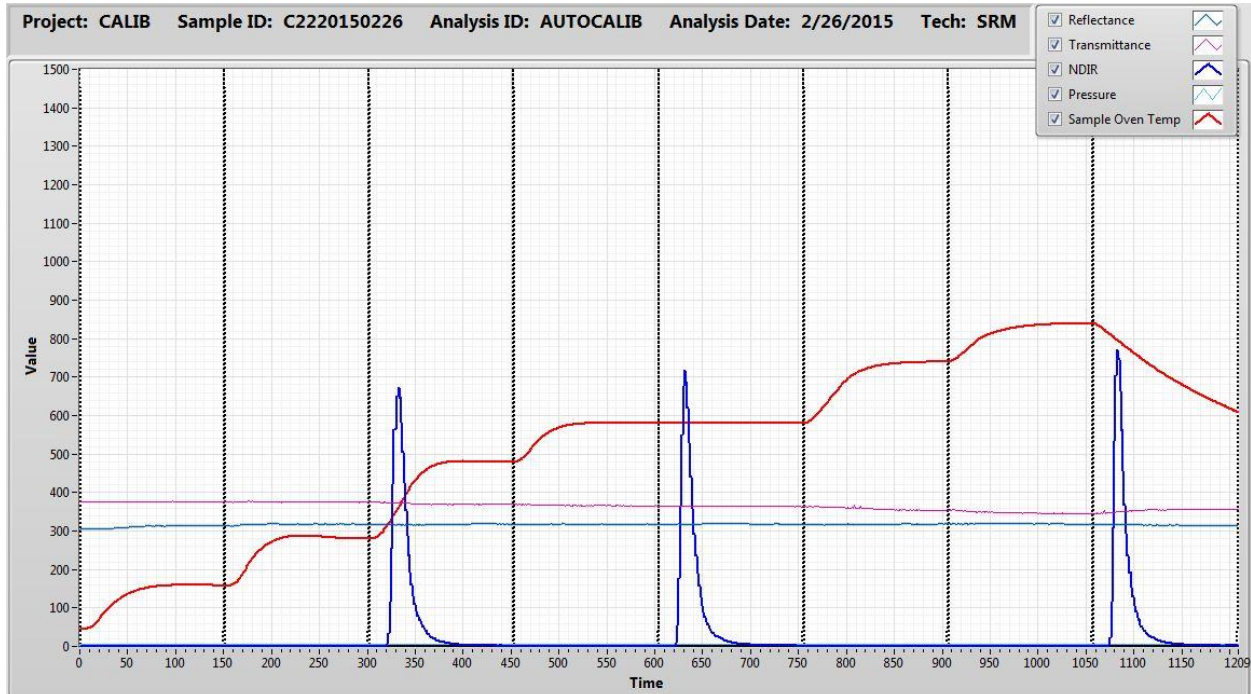

Figure 3-1. Calibration thermogram from the AutoCalib protocol.

Title: DRI Model 2015 Multiwavelength Carbon Analysis
(TOR/TOT) of Aerosol Filter Samples - Method IMPROVE_A for CSN

- Set the Run # (“1” for first calibration of the day and “2” for second calibration of the day, etc.). Enter “1” in the Punch area, and Deposit area fields. Click the “Press to Continue” button to start the analysis.
- Review the thermogram and record these values in the logbook and on the Daily Analyzer Checklist as shown in Figure 2-4.

The three calibration peak integrated counts (OC3, EC1, and CAL) should be 15,000 – 25,000 and within the acceptable range for the specific analyzer, and should be almost identical in area (and within 10% of the “Calibration Peak Area” value show on the tabular printouts). Check the average C value for the calibration gas against those posted on each carbon analyzer.

- Whenever the MnO₂ reactant is replaced, an automated routine calibration should be run to confirm that the previous calibration curve holds.

3.3.2 Manual Routine Gas Calibration

- From the *Carbon2015* Software Selection screen, click the “Analyze Sample” button.
- Enter sample information details. Select the HeOnly protocol. The project name should be “CALIB”, Batch # should be “YYYYmm” for the month, Sub-batch # should be “dd” for the day, and the sample ID should be in the format “MIxxYYYYmmdd” for CH₄ injection or “CIxxYYYYmmdd” for CO₂ injection where xx is the analyzer number (e.g. MI2220150310 for a CH₄ injection on analyzer number 22, run on March 10, 2015). Look up Table 4-1 for suggested naming convention of different analysis types.
- Set the Run # (“1” for first calibration of the day and “2” for second calibration of the day, etc.). Enter “1” in the Punch area, and Deposit area fields. Click the “Press to Continue” button to start the analysis.
- Note that standards are taken through the septum sampling port (typically orange in color) along the pressure regulated tubing of a size 10 cylinder. After the computer states, “Please load gas syringe”, follow the following gas injection procedure:
 - To load the syringe, open the main cylinder valve, secondary valves, and briefly (~2 seconds) the toggle valve (flip up) before inserting the syringe to draw the required gas volume. The toggle valve is opened briefly to purge out any air that may have been retained in the lines.
 - Insert the syringe into the sampling port and then pull the plunger until it is above the 1,000 µL mark. Pull the syringe off the sampling port and then push the needle to expel the contents. Repeat filling the syringe and expelling the content three times to ensure that residual air is eliminated. The fourth time, the contents of the syringe are expelled slowly until the plunger reaches the required volume.
 - The computer will start zeroing the NDIR and acquiring the NDIR baseline.
 - A 1,000 µL gas-tight syringe is loaded with the required standard volume within 2 minutes after setting the carbon analyzer for gas injection. [Note that routine checks

Title: DRI Model 2015 Multiwavelength Carbon Analysis
 (TOR/TOT) of Aerosol Filter Samples - Method IMPROVE_A for CSN

require 1,000 μL while gas calibrations require multiple volumes of 200, 500, 700, and 1,000 μL .]

- Insert the syringe into the injection port of the carbon analyzer and inject the gas when the interface states in the Sample Analysis Status window: OC1 measurement has begun. Hold the plunger down with the needle still inside the septum for 10 seconds or until a peak appears.
 - After injection, close the main and secondary valves of the gas cylinder to prevent gas leakage.
 - Return the syringe back to its drawer.
- Calibration gas injections should be in the following ranges for 1000 μl gas:

Manual Injection	Lower Allowable Limit	Upper Allowable Limit
CH ₄	20.36 μg carbon 1 *	22.50 μg carbon 1 *
CO ₂	20.28 μg carbon 2 *	22.41 μg carbon 2 *
Final Calibration Peak	20,000	--

¹ Calculated in a real laboratory environment. For a 5.12% CH₄ standard at 646 mm Hg at 24 °C, actual mass of methane is 21.43 μg carbon.

² Calculated in a real laboratory environment. For a 5.10% CO₂ standard at 646 mm Hg at 24 °C, actual mass of carbon dioxide is 21.34 μg carbon.

* Lower Allowable Limit equals to 5% lower than the actual mass; Upper Allowable Limit equals to 5% higher than the actual mass. Limits should be adjusted according to the real laboratory environment.

- Note: Each time the MnO₂ reactant is replaced, the instrument calibration should be checked to confirm that the previous calibration curve holds. A flow check and balance should always be performed after catalyst changes. Additional checks can be done by running a comparison sample (if available) or running two points from the six CH₄/He calibration volumes and two points from the six CO₂/He volumes used in the full calibration. The calibration peak area may also need to be checked for significant changes that would require a full calibration to calculate a new slope.

3.3.3 Daily Routine Sucrose and KHP Calibration

- From the *Carbon2015* Software Selection screen, click the “Analyze Sample” button.
- Enter sample information details. Select the IMPROVE_A protocol. The project name should be “CALIB”, Batch # should be “YYYYmm” for the year and month, Sub-batch # should be “dd” for the day, and the sample ID should be in the format “SUxxYYYYmmdd” for sucrose injection or “KHPxxYYYYmmdd” for KHP injection where xx is the analyzer number. Look up Table 4-1 for suggested naming convention of different analysis types.
- Set the Run # (“1” for first calibration of the day and “2” for second calibration of the day, etc.). Enter “1” in the Punch area, and Deposit area fields. Set the drying time to 900 s. Click the “Press to Continue” button to start the analysis.

Title: DRI Model 2015 Multiwavelength Carbon Analysis
 (TOR/TOT) of Aerosol Filter Samples - Method IMPROVE_A for CSN

- The total carbon (TC) must be between 17.1-18.9 ug C/filter for 10 µl injection of 1800 ppm sucrose and KHP to pass.

3.4 Full Carbon Calibration

3.4.1 Full Carbon Calibration Description

The complete instrument carbon calibration, performed semiannually or after major maintenance or repairs, establishes the calibration slope used in converting the NDIR counts to µg of carbon, as explained in the next section. Instrument calibration involves spiking pre-fired quartz punches with 5.0 to 20.0 µl of the 1800 ppm KHP and sucrose solutions and injecting 200 to 1000 µl of the CH₄ and CO₂ gases. Four types of standards are used to calibrate the carbon analyzers: 5% nominal CH₄ in He, 5% nominal CO₂ in He, KHP, and sucrose.

3.4.2 Preparation, Ranges and Traceability of Standards

The calibration is done by injection of a known volume of the standard to yield a calibration curve of peak area ratio of injected carbon to CH₄ (internal standard) versus µg C injected. For the best accuracy, the temperature and pressure at the time of analysis need to be taken into account. For a 100% CH₄ or CO₂ standard at 760 mm Hg at 20 °C, each microliter = 0.499 µg carbon. For a 5% standard, it will be 0.02495 µg C/µl at standard temperature and pressure (STP; 20 °C, 760 mm Hg). The Ideal Gas Law should be used to correct for the temperature and pressure of the laboratory.

$$\text{Actual } \mu\text{g C per } \mu\text{L} = 0.499 \times \% \text{ of Cal Gas} \times \frac{P}{760} \times \frac{273.15+20}{273.15+T}$$

where P is the local pressure in mmHg and T is the local ambient temperature in °C.

The calibration gases are traceable to NIST standards. They are assayed for exact concentrations by the gas supplier; the assay value is obtained from the tag on the cylinders and is typically determined by GC.

To prepare an 1800 ppm standard, the KHP is dried at 110 °C for two hours before dispensing. Transfer 0.3826 g of KHP into a glass 100 ml volumetric flask after the KHP has come to room temperature inside a desiccator. The weight of KHP used must be recorded. Dilute to volume with 0.4 ml concentrated hydrochloric acid (HCl) and 99.6 ml Nanopure water. Mix the KHP thoroughly. Store this solution in a refrigerator until it is used for calibration purposes. This solution is good for 40 days. Label the flask with the chemical name, the date of preparation, the name of the chemist preparing the solution, and the exact concentration. The concentration, nominally 1800 ppm carbon, is calculated by:

$$\text{Actual } \mu\text{g C per mL} = \left(\frac{\text{weight of KHP used in g}}{\text{vol of solution prep in ml}} \right) \left(\frac{\text{no of carbon in KHP} \times 12}{\text{MW of KHP}} \right)$$

$$\text{e.g.} = \left(\frac{\text{weight of KHP used in g}}{100 \text{ ml}} \right) \left(\frac{8 \times 12}{204.23} \right) \left(\frac{10^6 \mu\text{g}}{\text{g}} \right)$$

Title: DRI Model 2015 Multiwavelength Carbon Analysis
 (TOR/TOT) of Aerosol Filter Samples - Method IMPROVE_A for CSN

The nominal 1800 ppm carbon sucrose solution standard is prepared by transferring 0.428 g of sucrose into a glass 100 ml volumetric flask. Dilute to volume with acidified Nanopure water (see blank solution preparation instructions below). Mix the sucrose thoroughly. Store this solution in a refrigerator until it is used for calibration purposes. This solution is good for 40 days. Label the flask with the chemical name, the date of preparation, the name of the chemist preparing the solution, and the exact concentration. The concentration is calculated by:

$$\text{Actual } \mu\text{g C per mL} = \left(\frac{\text{weight of sucrose used in g}}{\text{vol of solution prep in ml}} \right) \left(\frac{\text{no of carbon in sucrose} \times 12}{\text{MW of sucrose}} \right)$$

$$\text{e.g.} = \left(\frac{\text{weight of sucrose used in g}}{100 \text{ ml}} \right) \left(\frac{12 \times 12}{342.31} \right) \left(\frac{10^6 \mu\text{g}}{\text{g}} \right)$$

To prepare a blank solution, add 0.4 ml of concentrated HCl to a glass 100 ml volumetric flask and dilute to volume with Nanopure water. This acidified Nanopure water is made fresh each time a 1800 ppm KHP stock solution is prepared.

Only a limited set of primary standards (NIST-traceable) currently exist for carbon analysis. Ideally, such standards should include a range of organic compounds from low- to high-molecular weights and with varying degrees of susceptibility to pyrolysis, as well as EC and carbonate compounds. Currently, KHP, sucrose, and the two calibration gases are used at DRI for calibration and system audit purposes. *Some standards can be purchased from commercial vendors. For example, 1800 ppm sucrose and KHP standards can be purchased from ERA (Golden, Colorado) at www.eraqc.com.*

3.4.3 Full CH₄ and CO₂ Gas Calibration Instructions

- To perform the full gas calibration, select “Analyze Samples” from the Software Selection Screen of the *Carbon2015* program.
- Select the HeOnly protocol in the Sample Info tab. The project name should be “CALIB”, Batch # should be “CARBON”, Sub-batch # should be “YYYYmmdd” for the year, month, and day. The sample ID should be in the format “MIxxYYYYmmdd_vvvv” for CH₄ injection or “CIxxYYYYmmdd_vvvv” for CO₂ injection where xx is the analyzer number and vvvv is the volume of gas injected). Look up Table 4-1 for suggested naming convention of different analysis types. You can also make comments and flag the analysis from this screen before the analysis starts.
- The CO₂ and CH₄ calibrations are run using the “Calibration” options from the main menu. The following volumes are injected:
 - 200 μl CO₂ & CH₄ gas (use 1000 μl calibrated gas-tight syringe)
 - 500 μl CO₂ & CH₄ gas (use 1000 μl calibrated gas-tight syringe)
 - 700 μl CO₂ & CH₄ gas (use 1000 μl calibrated gas-tight syringe)
 - 1000 μl CO₂ & CH₄ gas (use 1000 μl calibrated gas-tight syringe)

Record these calibration values in the logbook as in Figure 2-4.

- The integrated peak and CH₄ internal calibration peak counts are extracted manually from the tabular printouts or the database, and entered into the maintenance log spreadsheet which is used to determine the final calibration.

3.4.4 Full Sucrose and KHP Calibration Instructions

- Perform a system blank (without a blank filter punch) before running KHP or sucrose.
- A clean blank quartz punch is baked in the analyzer oven at 900 °C for 10 minutes using the *Bake* protocol.
- To perform the full calibration, select “Calibration Controls” from the Software Selection Screen of the *Carbon2015* program.
- Select the IMPROVE_A protocol in the Sample Info tab. The project name should be “CALIB”, Batch # should be “CARBON”, Sub-batch # should be “YYYYmmdd” for the year, month, and day. The sample ID should be in the format “SUxxYYYYmmdd_vv” for sucrose injection or “KHPxxYYYYmmdd_vv” for KHP injection where xx is the analyzer number and vv is the volume of gas injected). Look up Table 4-1 for suggested naming convention of different analysis types. You can also make comments and flag the analysis from this screen before the analysis starts.
- Enter the Run #; the Punch area and Deposit area should be “1” for the filter being analyzed.
- Enter the length of time in seconds you wish to delay the beginning of the analysis. This is used to purge dry a filter disc that has been deposited with an aliquot of KHP or sucrose standard solution, or when the sample is acidified for carbonate removal. In general, allow ~1.5 - 2 minutes of purge time for every μl of solution deposited (i.e., 5μl=600s, 10μl=900s, 15μl=1200s, and 20μl=1500s). Allow the punch to dry thoroughly; the punch will turn from translucent to opaque as it dries. The punch must be dry to avoid water vapor effects on the NDIR and the laser reflectance and transmittance signals.
- After the punch has cooled to less than 50°C, the sucrose or KHP solution (prepared as described in Section 3.4.2 and kept at room temperature) is injected onto the punch using a 25 μl syringe. The following volumes are used:
 - 5 μl KHP and sucrose solution
 - 10 μl KHP and sucrose solution
 - 15 μl KHP and sucrose solution (do twice)
 - 20 μl KHP and sucrose solution
 - no injection (as a laboratory blank)
- Flush the syringe at least three times with the calibration solution before taking up the volume for injection. Pump the syringe plunger to remove any trapped bubbles.

Title: DRI Model 2015 Multiwavelength Carbon Analysis
 (TOR/TOT) of Aerosol Filter Samples - Method IMPROVE_A for CSN

- Slowly spike the solution in the center of quartz punch and wash the syringe with Nanopure water after use. If the solution is spiked too quickly it will bead up and run off the punch.
- Start the calibration run.
- The integrated peak counts for all seven temperature fractions for the sample and calibration peaks are recorded in the database. The total inject peak is calculated by adding the peak area from OC1, OC2, OC3, and OC4, as well as EC1, EC2, and EC3. Pyrolysis counts are not included in the total.

3.4.5 Calculating Calibration Slope

Calibration values are entered in a worksheet as shown in Table 3-2, and are plotted as ratio of the integrated sample peak counts to the calibration peak counts vs. the actual calculated μg carbon (Figure 3-2). Obvious outliers are identified and rerun. Linear regression is performed on all calibration data. The slope (m) is calculated from:

$$\left(m = \frac{\sum (y_i x_i)}{\sum (x_i^2)} \right)$$

The standard deviation (s) is calculated by:

$$\sigma = \sqrt{\frac{1}{n-1} \frac{\sum (y_i - mx_i)^2}{\sum x_i^2}}$$

where:

$$x_i = \frac{(\text{injected carbon peak area})}{(\text{calibration peak area})}$$

and:

$$y_i = \text{calculated carbon in spiked filter or manual injection } (\mu\text{g})$$

- Note that this is a special form of the regression formula which ensures that the curve passes through the origin. All data points are included in the regression. This slope represents the response of the entire analyzer to generic carbon compounds and includes the efficiencies of the oxidation zones and the sensitivity of the NDIR. Note that the current calibration procedure is based only on TC, as no routine procedure exists to check the accuracy of the OC/EC split.

Title: DRI Model 2015 Multiwavelength Carbon Analysis
 (TOR/TOT) of Aerosol Filter Samples - Method IMPROVE_A for CSN

Table 3-2. Example of calibration summary worksheet used to determine calibration slope.

Cal Std	Run ID	Vol (µL)	Inject Peak Counts	Calib Peak Counts	Tech Initials	Peak vs µC	Area vs µC Label	Inject Peak/Calib Peak	Slope
CH4	MI0720110407-200	200	4506	24756	CDW	4.08	1.10	0.182	22.41
CH4	MI0720110407-500	500	11686	24914	CDW	10.20	1.15	0.469	21.74
CH4	MI0720110407-700	700	16162	25011	CDW	14.27	1.13	0.646	22.09
CH4	MI0720110407-1000	1000	22058	25063	CDW	20.39	1.08	0.88	23.17
CO2	ci0720110407-200	200	4381	24949	CDW	4.06	1.08	0.176	23.11
CO2	ci0720110407-500	500	10956	25027	CDW	10.14	1.08	0.438	23.17
CO2	ci0720110407-700	700	15421	24919	CDW	14.20	1.09	0.619	22.95
CO2	ci0720110407-1000	1000	22172	24823	CDW	20.29	1.09	0.893	22.71
SUC	SU0720110407_5	5	10529	24831	CDW	9.00	1.17	0.424	21.23
SUC	SU0720110407_10	10	21293	24743	CDW	18.00	1.18	0.861	20.92
SUC	SU0720110407_15	15	31159	24638	CDW	27.01	1.15	1.265	21.36
SUC	SU0720110407_15	15	31660	24747	CDW	27.01	1.17	1.279	21.11
SUC	SU0720110407_20	20	42388	24802	CDW	36.01	1.18	1.709	21.07
KHP	KHP0720110407_5	5	9674	24504	CDW	8.96	1.08	0.395	22.69
KHP	KHP0720110407_10	10	20449	24625	CDW	17.91	1.14	0.83	21.57
KHP	KHP0720110407_15	15	32170	24622	CDW	26.87	1.20	1.307	20.57
KHP	KHP0720110407_15	15	32345	24891	CDW	26.87	1.20	1.299	20.68
KHP	KHP0720110407_20	20	44640	24956	CDW	35.83	1.25	1.789	20.03

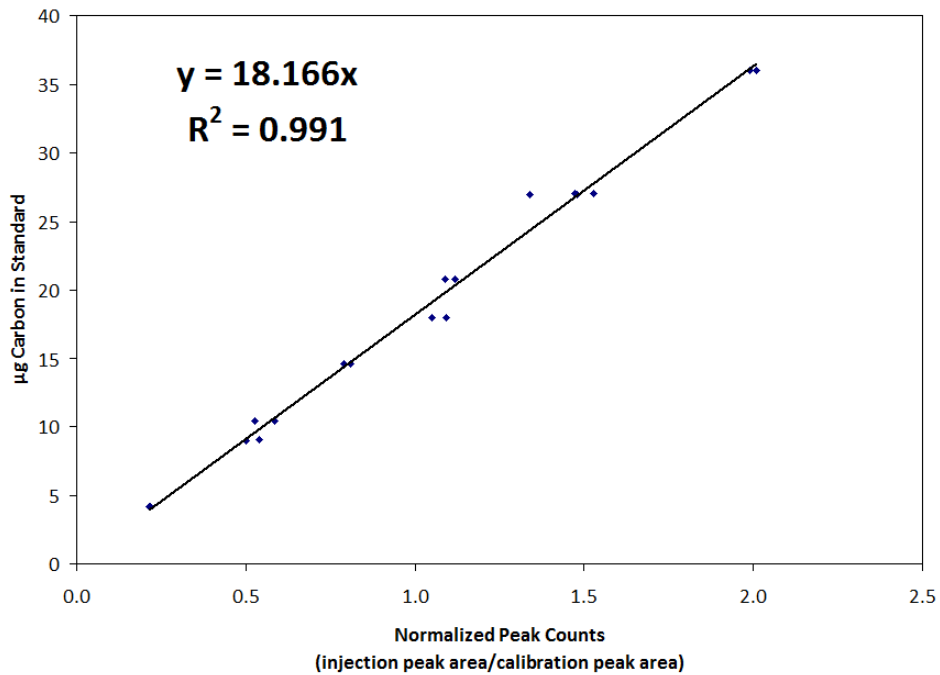

Figure 3-2. Example of a DRI carbon analyzer carbon calibration curve.

Title: DRI Model 2015 Multiwavelength Carbon Analysis
 (TOR/TOT) of Aerosol Filter Samples - Method IMPROVE_A for CSN

- The resulting slope is compared to previous calibration results. New values should be no more than 10% different than previous calibrations if no major analyzer changes have been made. If variation is > 10%, calibration must be redone to verify values.
- The new slope for each analyzer (derived from combined CH₄, KHP, and sucrose data) is placed into the *Config.par* file for each analyzer; this file contains analyzer parameters which are read into the Carbon program when it is first started. Therefore the *Config.par* file must be edited while the program is closed and the parameters will take affect when the program is restarted. The date and version number in the *Config.par* file is also updated.
- Calibration data and plots are retained electronically in the maintenance log database and in file folders stored with the raw analysis data.

3.4.6 Typical Accuracy of Calibration Standards

The accuracy of the calibration standards is primarily limited by the accuracy of the calibration gas assays, the accuracy of the preparation of the KHP and sucrose solutions, and the technician's injection technique. The calibration slopes determined by these four compounds historically differ by less than 5% on a given analyzer if sufficient care is taken during the calibration procedure. Figure 3-2 shows an example of plotted calibration curves.

3.4.7 Carbon Calculation

The conversion of integrated peak counts to µg of carbon for each peak in the thermogram is performed by the computer at the end of the analysis program. For reference purposes, the calculation is:

$$\mu\text{g C per punch} = \frac{\text{Integrated Peak Counts above Baseline} \times \text{Calibration Slope}}{\text{Internal Calibration Counts}}$$

For IMPROVE_A thermal protocol, the peaks reported are: four organic peaks (OC1, OC2, OC3, and OC4) corresponding to 140, 280, 480, and 580 °C in He atmosphere, respectively; three elemental carbon peaks (EC1, EC2, and EC3) corresponding to 580 °C after the introduction of O₂, 740, and 840 °C, respectively; and three pyrolyzed organic carbon peaks (Lower, Regular, and Upper Splits) by reflectance and transmittance, corresponding to the peaks after the introduction of O₂ and before the Lower Split Time, Regular Split Time, and the Upper Split Time, respectively, for the reflectance and transmittance optical charring correction for each wavelength; OC and EC after pyrolyzed organic carbon corrections by reflectance and transmittance for each wavelength; and TC.

Carbon values per punch are converted to µg C/cm² by:

$$\mu\text{g C/cm}^2 = \frac{\mu\text{g C/Punch}}{\text{Punch Area}}$$

Finally, carbon values are converted to µg C/filter by:

$$\mu\text{g C/Filter} = (\mu\text{g C/cm}^2) \times (\text{Filter Deposition Area})$$

3.5 Temperature Calibration

Sample oven temperature calibration is typically done semiannually or when the thermocouple is replaced. Since it is difficult to sense the temperature of the sample directly, it is recommended to use temperature indicators for temperature calibration (Chow et al., 2005). Alternatively, a National Institute of Standards and Technology (NIST) certified thermocouple can be used for calibrating the sample oven temperature.

3.5.1 Calibration with Temperature Indicators

3.5.1.1 Temperature Indicators

Temperature indicators were sought that: 1) could be placed where the sample would normally be located, and 2) would cause sharp reactions when known temperatures were achieved. Quick-drying temperature-indicating liquids of different melting points, Tempilaq^o G (Tempil, Inc., South Plainfield, NJ, USA), were used as temperature indicators in muffle furnaces. A Tempilaq^o G set contains long-chain hydrocarbons suspended in an organic solvent, which change their appearance at 44 specific temperatures spanning 80-1000 °C. The accuracy of Tempilaq^o G is certified within ±1% of its designated temperature and is traceable to the National Institute of Standards and Technology (NIST). Tempilaq^o G is bottled in liquid form and dries quickly to a dull, opaque film when applied to a surface. As the surface is heated to the designated temperature, the film liquefies and is accompanied by a change of appearance that can be optically monitored to determine sample temperature.

3.5.1.2 Analyzer Preparation

Preparation of the Model 2001 analyzer for temperature calibration with Tempilaq^o G includes the following:

- Go to the Oven Calibration Screen of the *Carbon2015* software (Figure 3-3), check the “Alter Calibration Values” box, and set the slope to 1 and the intercept to 0.
- Replace existing MnO₂ oven with a clean backup oven (without MnO₂) to prevent contamination of the main oven. Install without connecting to the back valve.
- Connect side and main quartz oven outlet(s) to rubber tubing that can be inserted into an Erlenmeyer flask filled with water. This will help condense the organics when the Tempilaq^o G is heated up.

3.5.1.3 Standard Preparation

Temperature calibration requires two pre-fired quartz-fiber filter (#2500 QAT-UP, Pall Life Sciences, Ann Arbor, MI) punches (0.5 cm² for DRI analyzer) and a clean matching-sized quartz disk (Continental Glass Engineering, Burbank, CA). Quartz-fiber filter punches are sliced in half (horizontally) with a filter-slicing device (Fung et al., 2004). A thin layer of Tempilaq^o G (~25 µL) is uniformly applied to the glass and/or quartz disk surface with a 0.1 ml Eppendorf graduated Combitip (Brinkman Instruments Inc., Westbury, NY), and, before drying, is immediately covered with a sliced filter punch. For cost savings, a glass, instead of quartz, disk can be prepared by a

technician in the lab from a glass slide cover and used for Tempilaq^o G at temperatures > 520 °C. Higher temperatures require the quartz disc to prevent melting. The disc sandwich (i.e., temperature standard) is then loaded on a sample holder for analysis. The mass of applied Tempilaq^o G is determined gravimetrically to ensure its mass is ~10%.

3.5.1.4 Temperature Program

After insertion of the temperature standard into the analyzer, the temperature is slowly (2 °C/min) ramped across a 50 °C range containing the specified Tempilaq^o G melting point. This slow ramping creates a quasi-equilibrium condition that allows the phase transition point to be resolved. Temperature indicators 121 through 510 are replicated three times and 704 and 816 are replicated twice. When the specified temperature is reached, the Tempilaq^o G liquefies, causing a detectable change in reflectance and transmittance.

Figure 3-4 demonstrates the thermocouple temperature, reflectance, and transmittance (635 nm) as a function of thermal analysis time. In the example provided, the reflectance and transmittance remained relatively flat until the temperature approaches its specified value of 184 °C. Figure 3-5 compares the time series of reflectance, transmittance, and their respective first- and second-order derivatives. The second-order derivative (change in the slope) recorded the inflection point of reflectance or transmittance that provided the best indication of the attainment of the designated temperature. Thermocouple temperature at this critical point was recorded as “measured” temperature. The temperature deviation (ΔT) between the sample and the thermocouple temperatures is determined by comparing the rated Tempilaq^o G temperature with this measured value (Chow et al., 2005).

In the Model 2015, the reflectance-based method generally gave a lower liquefying temperature than the transmittance-based method, within ± 2 °C. Given the uncertainty in the Tempilaq^o G temperature rating of $\pm 1\%$, calibrations based on the two optical methods were considered to be equivalent; therefore, their means were used. Among temperature indicators that achieve an adequate signal/noise ratio, temperature indicators of 121, 184, 253, 510, 704, and 816°C were chosen for IMPROVE_A protocol temperature calibration (Chow et al., 2005; 2007). Note, the 510 °C temperature experiences charring and therefore, transmittance results are variable.

Plot temperatures measured by the pushrod thermocouple against that measured by the Tempilaq^o G (Figure 3-6). A linear regression is done separately for the lower temperatures and higher temperatures separated with a toggle point typically around 200-300 °C. The toggle point is set to be the temperature at which the two regressions are equal to one another or intersect. Input the two separate regressions and the toggle point into the Oven Calibration Screen (Figure 3-3). Input the toggle point in the Oven Calibration Screen along with the high and low temperature regressions, and click the “Save Config File” button. Once the pushrod thermocouple calibration has been completed it is advised to run the Temperature Optimizer program to optimize the temperature ramping, which takes approximately 8 hours.

3.5.2 Temperature Calibration with a NIST Certified Thermocouple

The sample oven temperature can be calibrated with a NIST certified thermocouple following the procedure below:

- 1) Put a blank filter on the sample boat, and set the sample boat in ANALYZE position.
- 2) Remove the reflectance light rod on the top arm of the quartz cross oven.
- 3) Insert the NIST thermocouple probe through the top arm of the quartz cross oven, and make adjustments so that the thermocouple tip hovers directly above the punch.
- 4) Go to the Oven Calibration Screen (Figure 3-3), check the “Alter Calibration Values” box, and set the slope to 1 and the intercept to 0.
- 5) Set the sample oven temperature to a set point and record the pushrod thermocouple and NIST thermocouple readings when the temperature stabilize, Suggested temperatures to be used for temperature calibration are: 40, 60, 80, 100, 120, 140, 160, 180, 200, 220, 240, 260, 300, 360, 420, 480, 540, 580, 680, 740, and 840 °C. These temperatures encompass the temperature steps used in the IMPROVE_A protocol.
- 6) Plot temperatures measured by the pushrod thermocouple against that measured by the NIST thermocouple (Figure 3-6). A linear regression is done separately for the lower temperatures and higher temperatures separated with a toggle point typically around 200-300 °C. The toggle point is set to be the temperature at which the two regressions are equal to one another or intersect. Input the two separate regressions and the toggle point into the Oven Calibration Screen.
- 7) Input the toggle point in the Oven Calibration tab (Figure 3-3) along with the high and low temperature regressions, and click the “Save Config File” button.
- 8) Once the pushrod thermocouple calibration has been completed it is advised to run the Temperature Optimizer program to optimize the temperature ramping, which takes approximately 8 hours.

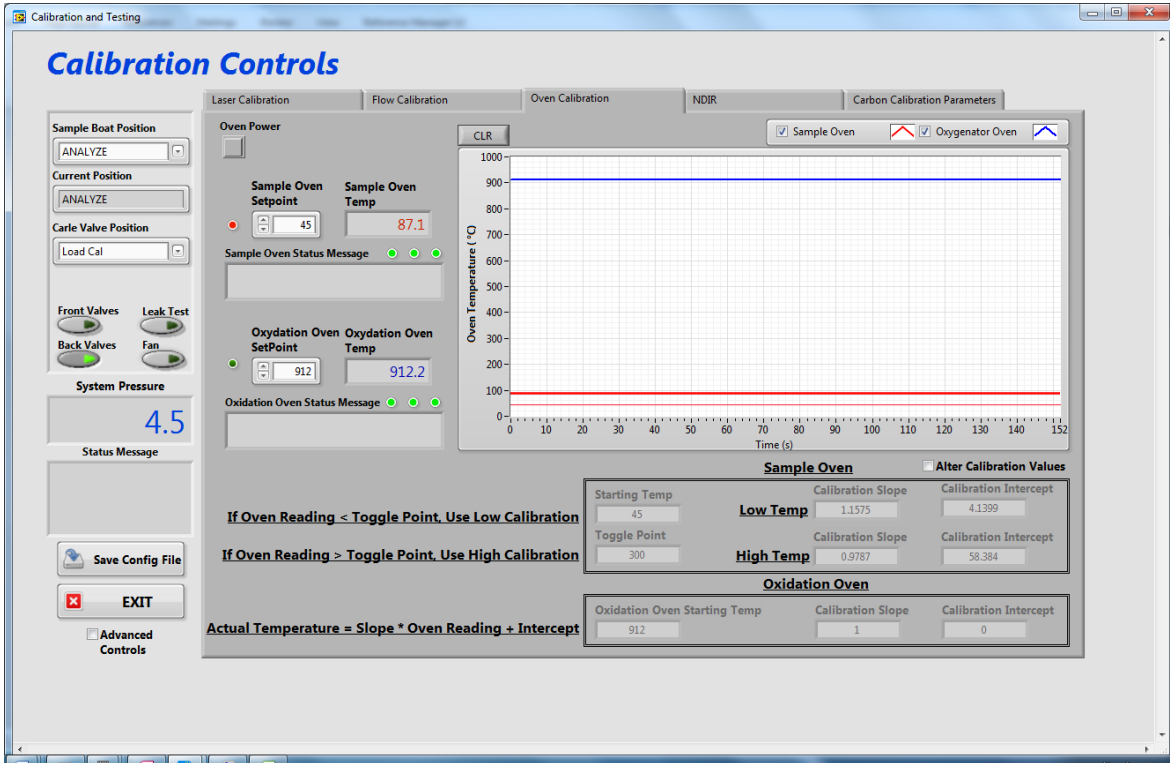

Figure 3-3. Calibration Controls, Oven Calibration.

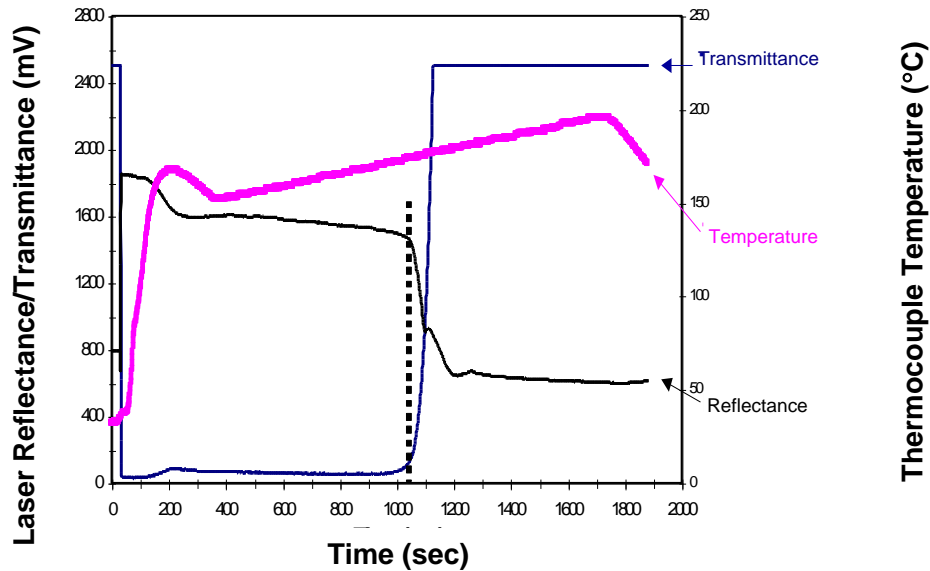

Figure 3-4. Temperature ramping with a Tempilaq[®] G Indicator rated at 184 °C. Also shown are reflectance and transmittance of the temperature indicator. The vertical dashed line indicates the achievement of the rated temperature.

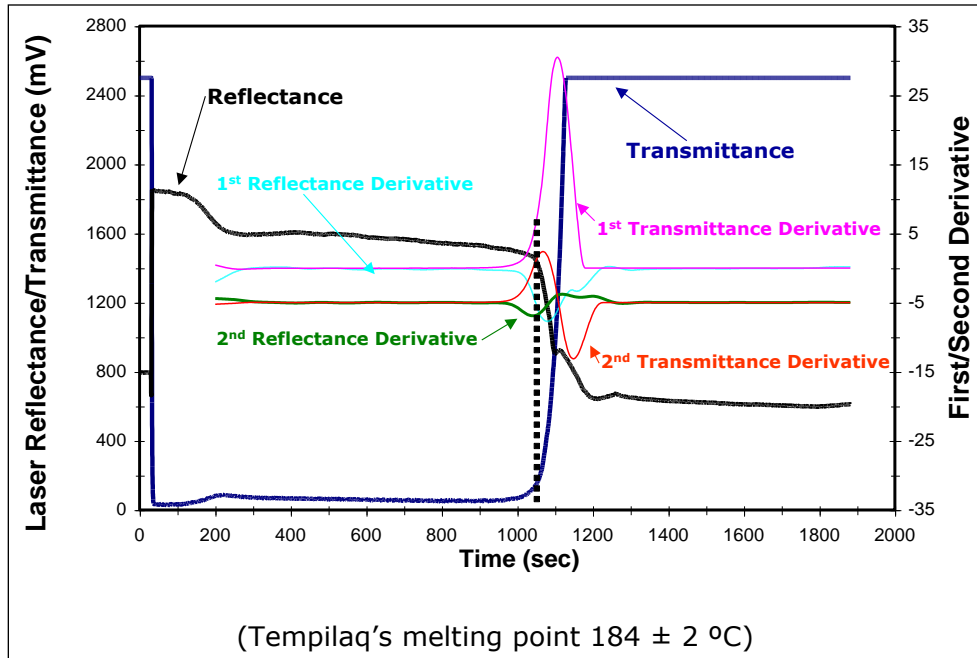

Figure 3-5. Reflectance and transmittance measurements and their first and second derivatives over time with a Tempilaq[®] G temperature indicator rated at 184 °C (Figure 3-4). The vertical dashed line indicates the achievement of the rated target temperature.

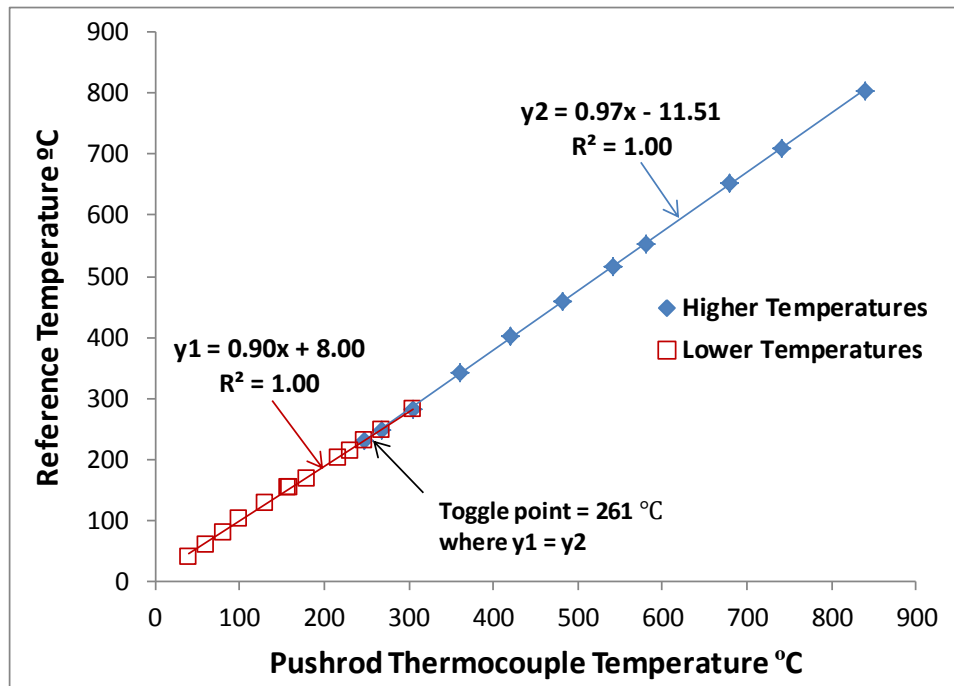

Figure 3-6. Example of temperature regression and toggle point determination.

4 ROUTINE PROCEDURES

4.1 Analyzer Start-Up

When the analyzer is started up for the first time, or after an extended period of non-operation, it requires conditioning to reach a stable system background. At start-up, allow ~30 minutes to purge all the gases before activating any heating zones. Activate the oxidation oven afterwards starting at setpoint of 120 °C then incrementing by 100 °C every 30 minutes until oxidation oven is 912 °C.

The following steps to start up the analyzer:

- Check all gas cylinder pressures; cylinders with gas pressures less than 500 psi should be replaced before beginning the day's analysis.
- Check that all gas delivery pressures are correct:

Helium(He)	20-40 psi (check label on regulator for current setting)
Compressed air	25 psi
O ₂ /He mix	15 psi
CH ₄ /He mix	10 psi
CO ₂ /He mix	10 psi

- Mass flow controllers regulate all gases except the CH₄ and CO₂. See the Manual for more information.
- Turn on the computer monitor. Note: the computers are generally left on at all times; only the monitors are turned off when the analyzers are not in use.
- Confirm that the date and time on the computer are correct.
- Wipe the sample tweezers, flat glass plate, and punching tool with clean lint-free polyester wipe, taking care not to contact the cleaned surfaces with fingers or other dirty items. Check to make sure that no fibers are left on the surfaces after wiping.
- Begin the daily entry in the Carbon Analyzer Logbook. Entries should follow the format in Figure 2-4.
- Open the file *Carbon2015* program icon to begin the carbon analysis program (or double click the *Carbon2015* shortcut on the computer desktop). This opens the LabVIEW software and the Query Status screen (Figure 4-1a).

- When all components are “green” on the Query Status screen click “Continue” and the Software Selection Screen will appear (Figure 4-1b).

a)

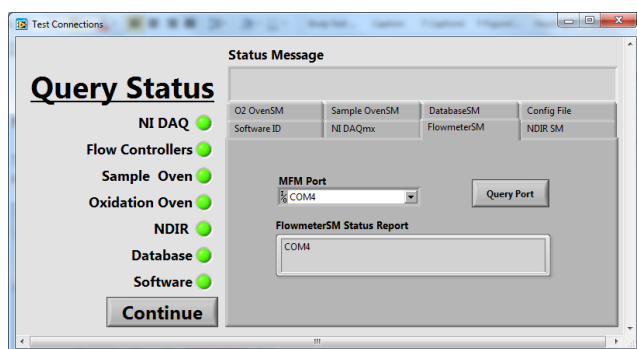

b)

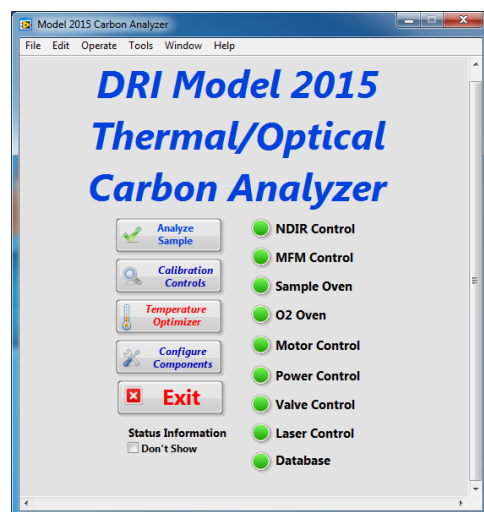

Figure 4-1. Carbon2015 software screens: a) Query Status; and b) Software Selection.

4.1.1 Leak Checks

Perform leak checks daily to detect leakage in the sample oven. The leak check valves are operated by the computer. To perform a leak check, use the following procedure:

- From the Software Selection window, click the “Calibration Controls” button.
- Set the He/O₂ flow to zero in the Flow Calibration tab (Figure 4-2), then turn off the on/off toggle valve on that line connected to the side arm of the quartz cross.
- In the Calibration Control window (Figure 4-2), toggle the back valve (from bright green to dark green color) to direct flow to the leak check valve.
- In the Calibration Controls window (Figure 4-2), toggle the leak check valve switch on. This seals the analysis region between the two leak check valves off from other components and the gas inlet.
- Observe the pressure reading. It will initially drop quickly and then stabilize in a minute. If it drops more than 0.1 psi per second after that, and does not stabilize, there is a leak in the system.
- Check for leaks using a sensitive helium leak detector or liquid leak detection solution (e.g., Snoop® Liquid Leak Detector).
- Likely leak areas are:

- The Teflon or graphite ferrules around the thermocouple push rod and the quartz oven inlet and outlet. A slight turn on the nut should cure the leak. If not, replace the ferrule.
- The septum port. Replace septum if necessary
- The top and bottom seals of the quartz oven cross. Be careful not to disturb the position of the light pipes if tightening is needed in these places.
- If leak persists, the oven may have a crack.
- When the system leak checks are satisfactory, toggle the leak check valves off in the *Carbon2015* software.
- If the system still leaks, wipe all threads, replace ferrules and O-rings.
- Check the breech O-ring sits squarely in the groove and confirm that the line air pressure is sufficient (>25 psi) to close the breech.
- Once the system passes the leak test, turn on the He/O₂ flow on/off toggle valve. Allow the system pressure to return to its original value and record this value on the Daily Analyzer Checklist shown in Figure 2-6. The pressure should be consistent with previous day's values.

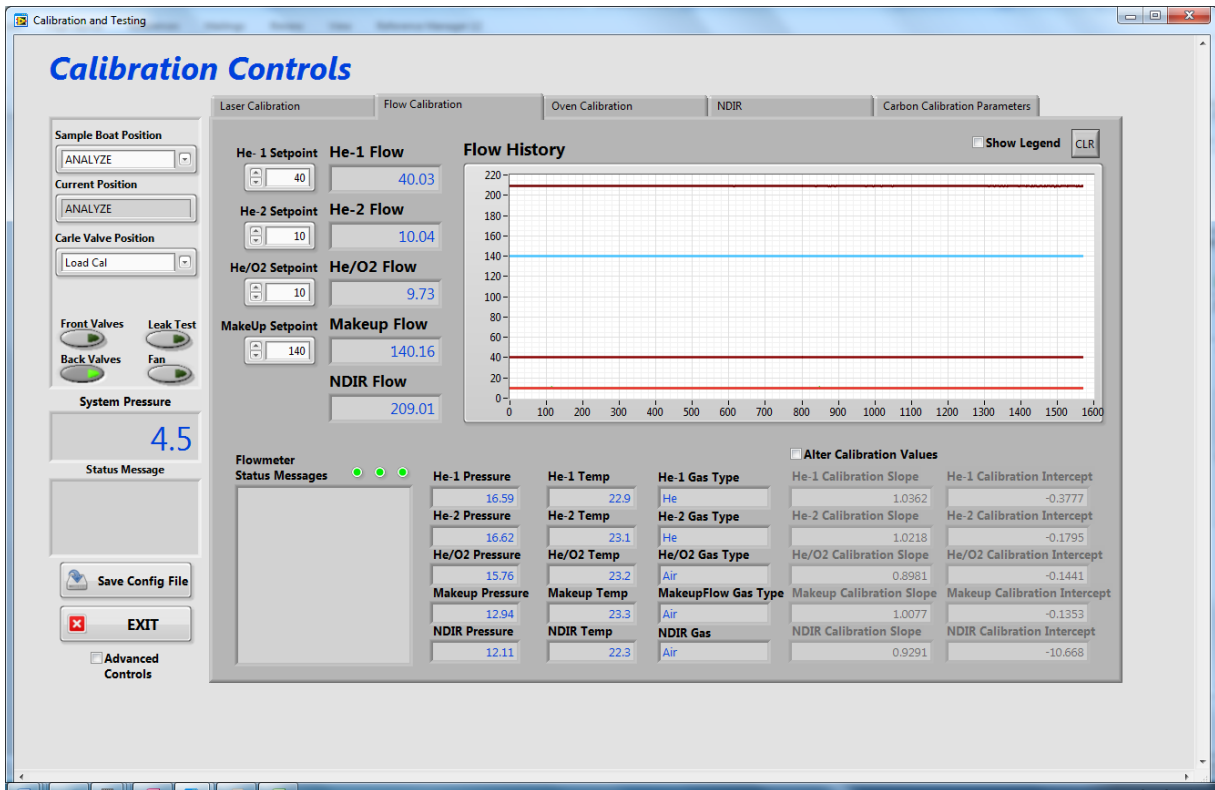

Figure 4-2. Calibration Controls - Flow Calibration.

4.1.2 Oven Bake

Perform an oven bake when: 1) analyzer has been idle for more than 2 hours; 2) a new blank punch is loaded; 3) excessive contamination is detected after a laboratory blank analysis; or 4) persistent EC contamination is observed from samples. The oven bake can be performed manually or automatically.

4.1.2.1 Manual Oven Bake

Use the following procedure to perform a manual oven bake:

- From the Software Selection window (Figure 4-1b), click the “Calibration Controls” button.
- Selected the Oven Calibration tab (Figure 3-3), and type in 840 in the Sample Oven Setpoint field and press enter. This will heat the oven to 840 °C. Exercise caution when working around hot surfaces of the analyzer.
- Continue until the NDIR returns to baseline.
- Repeat as necessary until the system is clean.
- System or laboratory blanks are run after the oven bake.
- After bake is done, set sample oven setpoint to 5 °C to cool the oven to the room temperature.

4.1.2.2 Automatic Oven Bake

Use the following procedure to perform an automatic oven bake:

- From the Software Selection window (Figure 4-1b), click the “Analyze Sample” button. The Analyze Sample Screen (Figure 4-3) will appear.
- Click the “Setup Analysis” button to bring up the Enter Sample Details screen (Figure 4-4).
- Select “Bake” analysis protocol.
- Use Project Name “LABBLK”, Batch # “YYYYmm” for the year and month, and Sub-batch # “dd” for the day.
- The Sample ID should be in the format “BAKExxYYYYmmdd” where “xx” is the analyzer number and YYYY is the year (e.g. Bake2220150715 for analyzer number 22 on July 15, 2015).
- Set the Run #, Punch area, and Deposit area fields to “1”. Click the “Press to Continue” button.
- System or laboratory blanks are run after the oven bake.
- Monitor the thermogram from printout or from the screen. Repeat the bake process when NDIR remains above the initial baseline levels.

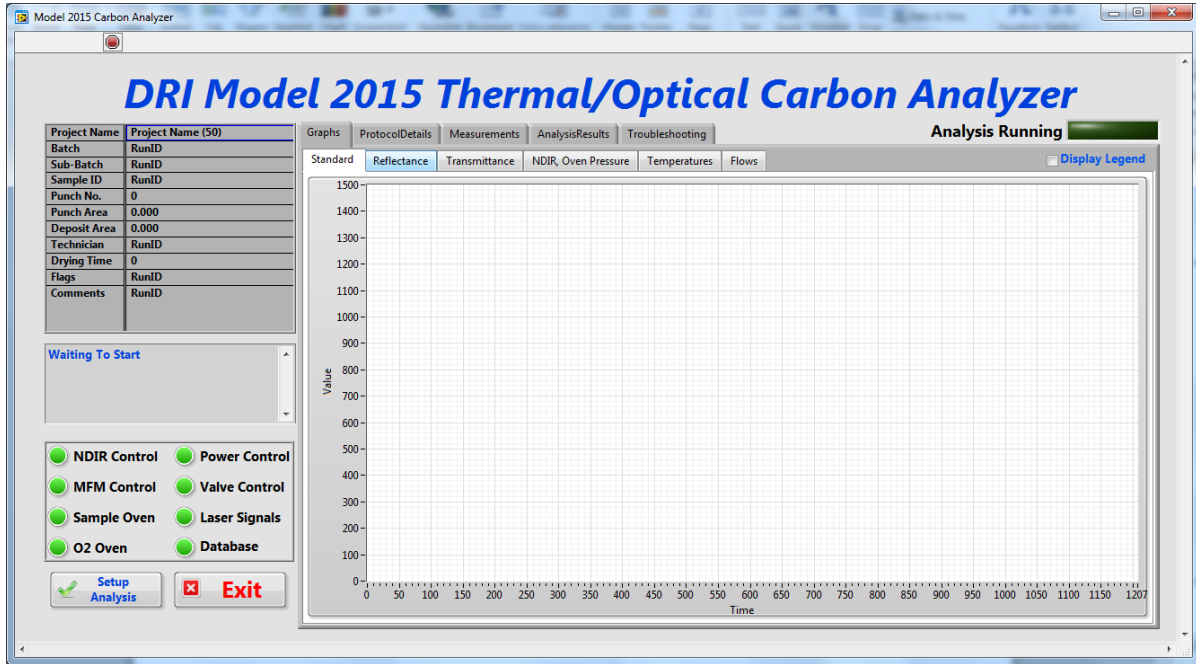

Figure 4-3. Analyze Sample Screen.

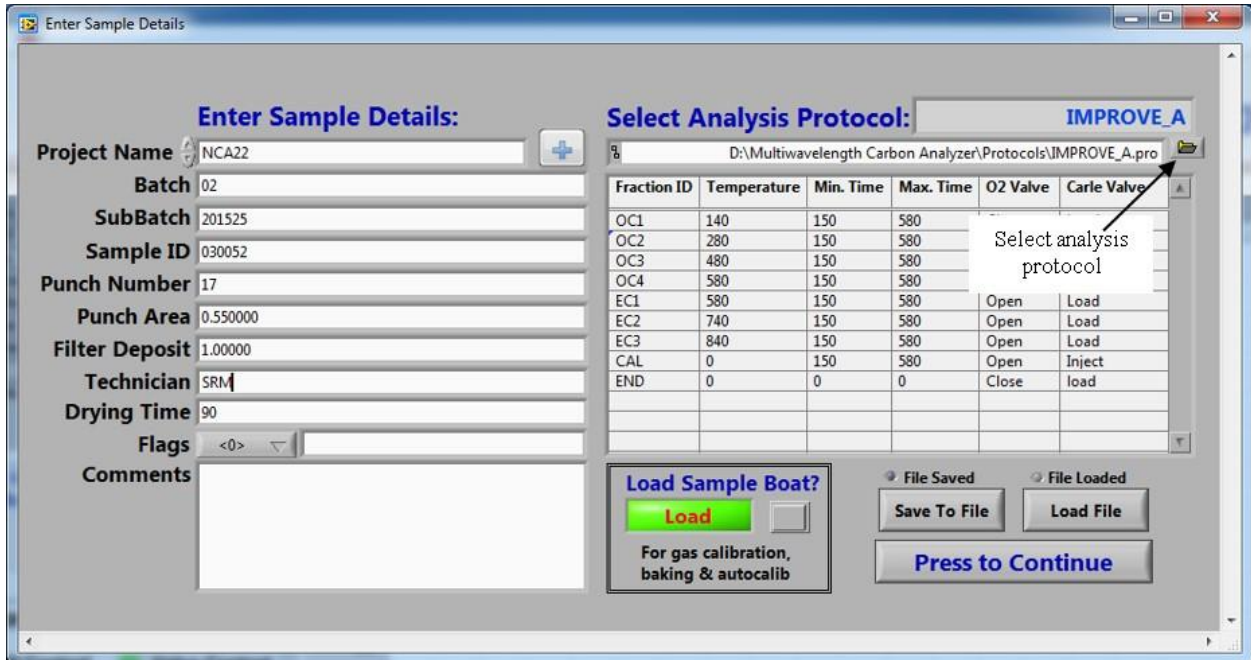

Figure 4-4. Enter Sample Details Screen.

4.1.3 Laboratory Blanks

Laboratory blank analyses are performed daily to check for system contamination and evaluate laser response. The following steps outline laboratory blanks analysis:

- Run the “Bake” protocol following the procedure in Section 4.1.2.
- Run a laboratory blank using the IMPROVE_A protocol.
- Use the following for the sample details:
 - Project Name: LABBLK
 - Batch: YYYYmm
 - Sub-batch: dd
 - Sample ID: LBxxYYYYmmddwhere xx, YYYY, mm, and dd refers to analyzer number, year, month, and day, respectively. Look up Table 4-1 for suggested naming convention of different analysis types.
- Enter 1 cm² for punch and deposit area. If additional laboratory blanks are run during the day, check for previous laboratory blanks and use a punch number one greater than the last.
- Void values and perform another laboratory blank if total carbon exceeds the 0.2 µg C/cm² limit. Perform bake procedure in between laboratory blank attempts until the system is clean (i.e., OC < 0.2 µg C/cm² and no EC).
- Monitor the reflectance (LR) and transmittance (LT) of 635 nm laser. A difference >5% of initial indicates significant laser drift.
- Update the DRI Carbon Daily Analyzer Checklist (see Figure 2-6) using reflectance (LR initial), transmittance (LT initial), total carbon (TC), and calibration peak area (Cal peak area) from the printout.
- Values for 635 nm laser reflectance should be between 350 and 550, transmittance should be between 100 and 300, and consistent with previous days’ values. The laser values should not have sudden changes at high temperature stages (EC1-EC3). A sudden drop of the laser signal indicates the photodiode is saturated due to oven glow. The laser or the light pipe may need adjustment.
- Total carbon from laboratory blanks must be less than 0.2 µg C/filter.
- Calibration peak areas must be consistent to within 1000 counts from previous days’ values.
- Analyzers exceeding the limit for laser drift, reflectance, transmittance, total carbon, and calibration peak area after three laboratory blank runs must be taken offline for maintenance.

4.1.4 Daily Routine Startup Calibrations

Each analyzer follows the daily routine morning startup calibration procedure listed in Table 3-1 to ensure performance. These include automated CH₄ injection (*AutoCalib*), sucrose injection, and KHP injection. Detailed calibration procedure and described in Section 3.3.

4.2 OC/EC ANALYSIS

Refer to the daily analysis run list (see Figure 2-5) for a list of samples to retrieve from the sample freezer. Transfer those samples into a Styrofoam cooler with blue ice, or place in the analysis room compact refrigerator.

Routine analysis procedure excludes carbonate measurements. For carbonate analysis, refer to section 4.2.5.2.

Always perform the analyzer start-up calibration outline in Section 4.1 each day before beginning analysis to ensure that the system is clean ($<0.2 \mu\text{g TC}/\text{cm}^2$), the optical signal and internal calibration peaks are consistent, and carbon signals for standards are within specification.

4.2.1 Carbon Analysis Preparation

- Confirm the computer date and time.
- Verify sample oven pressure reading and specified flow ranges in the software.
- Wipe the flat glass plate, tweezers, and punching tool thoroughly with a dry lint-free wipe.
- Remove the sample to be analyzed from the Styrofoam cooler or refrigerator in the order listed on the analysis run list.
- Record the filter ID in the analyzer log book (Figure 2-4).

4.2.2 Software Setup Procedures

- Open the file *Carbon2015* program icon to begin the carbon analysis program (or double click the *Carbon2015* shortcut on the computer desktop). This opens the LabView software and the Query Status screen (Figure 4-1a).
- When all components are “green” on the Query Status screen click “Continue” and the main Software Selection screen will appear (Figure 4-1b).
- Click on “Analyze Sample” in the Software Selection screen and the Analyze Sample screen (Figure 4-3) will open.
- Click “Setup Analysis” button in the Analyze Sample screen to bring up the Enter Sample Details screen (Figure 4-4).
- Click on the folder icon in the upper right corner to select the analysis protocol. For a normal analysis or a blank, select “IMPROVE_A”, for gas injections select “HeOnly”, to clean the oven, select “Bake”, and to run an auto calibration, select “AutoCalib”.

- Enter the Sample ID number, or place your mouse cursor in the field and use a barcode scanner to read the barcode on the Petri dish.
- Fill out the information about the sample, including: Project Name, Batch #, Sub-batch#, Run Number, Punch, and Deposit area of the filter being analyzed. These details are included in the analysis run list. Enter technician initials in the “Tech initials” field.
- For a normal run, set the drying time to **90** seconds. For a spiked filter (for sucrose and KHP), select 900 seconds. Assume one (1) minute of drying time for each μL .
- Under “Load Sample Boat”, the default is on in order to have it automatically load once “Press to Continue” is clicked. Toggle this off if needed.
- Select any pre-analysis flags from the drop-down menu in the “Flags” field. A list of valid choices is presented on the screen.
- Once sample details have been completed and the analysis protocol has been selected, click “Press to Continue” which returns the user to the analysis screen shown in Figure 4-5
- The status window will show the analysis initialization status.
- When the oven temperature is $<50^{\circ}\text{C}$ (as indicated in the status window) the push rod will retract the boat to the load/unload position and a prompt will appear stating, Press “OK to open Sample Chamber” as shown in Figure 4-6.

4.2.3 OC/EC Analysis

- Visually examine the filter and note any non-uniformity or unusual deposit. Remove it from the Petri slide or Petri dish with tweezers, handling the filter only by the edge. Place the filter on the glass plate and gently push down the punching tool to remove a sample punch. Rocking the punching tool slightly will ensure that the punch is completely severed. Try to remove the punch from the edge of the deposit to avoid wasting the filter, while trying to avoid areas of non-uniform deposits.
- Leaving the sample punch in the punching tool, place the punching tool on a clean lint-free wipe. Return the filter to the Petri slide or dish, being careful to handle only the filter with the tweezers.
- Use tweezers to remove any existing punch from a previous analysis on the sample boat. Remove the new punch from the punch tool and load it into the boat, *deposit side up*.
- Click “OK” button in Figure 4-7 after loading the punch and the analysis will proceed.
- The status of the analysis can be monitored in the status window as indicated in Figure 4-5.
- The thermogram will appear in the Standard graphic window. Check from time to time during the run to verify if the temperature, optical, and carbon signals are normal. Pay special attention to see if any indicator in Figure 4-5 is red instead of green.
- Wipe the tweezers, flat glass plate, and punching tool with a clean lint-free wipe.

- When the analysis is complete enter appropriate end-of-run flags and comments in the form shown in Figure 5-8 and click “Continue”.

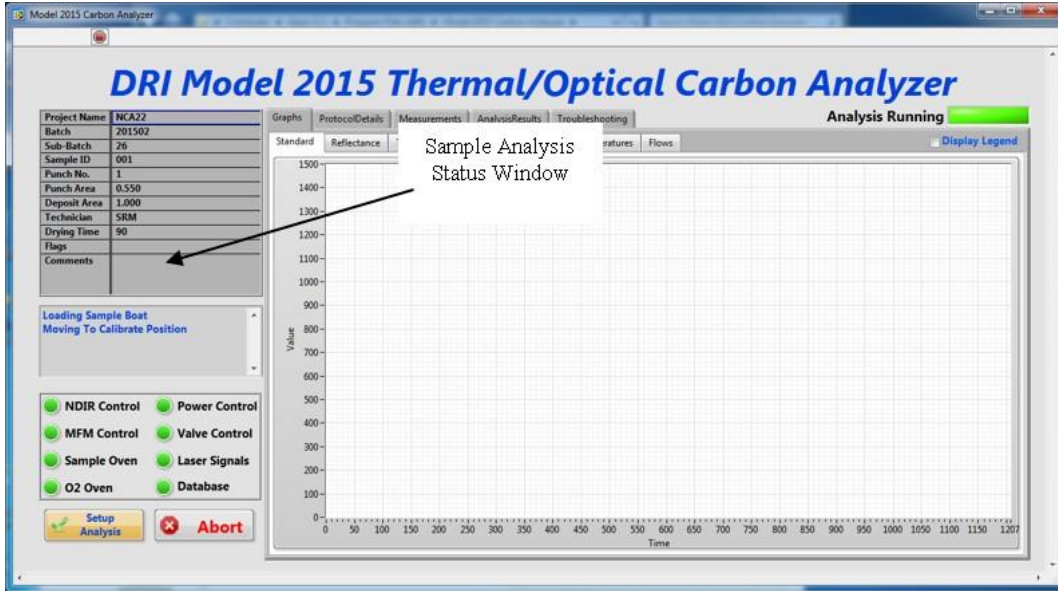

Figure 4-5. Sample analysis status screen

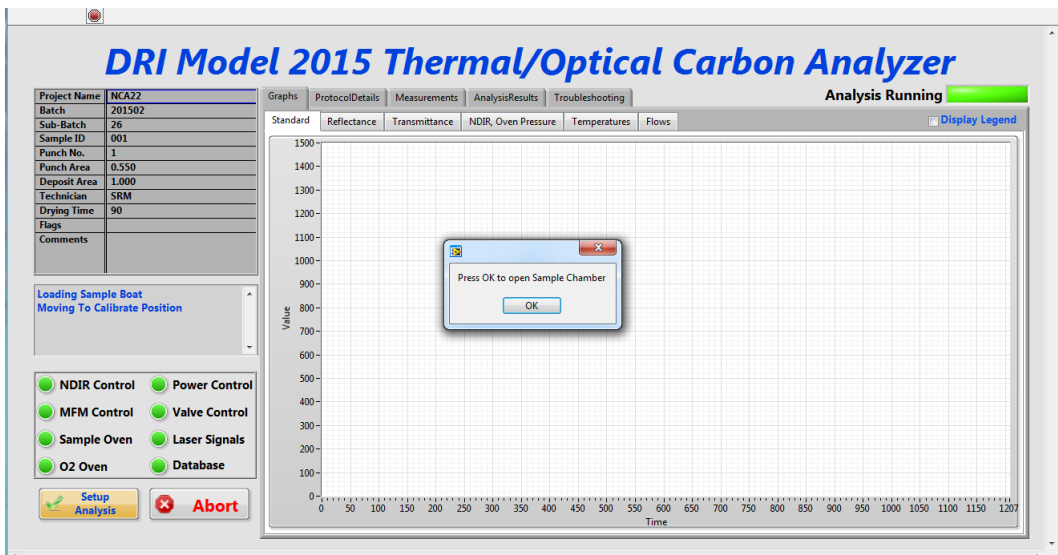

Figure 4-6. Sample analysis status screen with prompt to open the chamber.

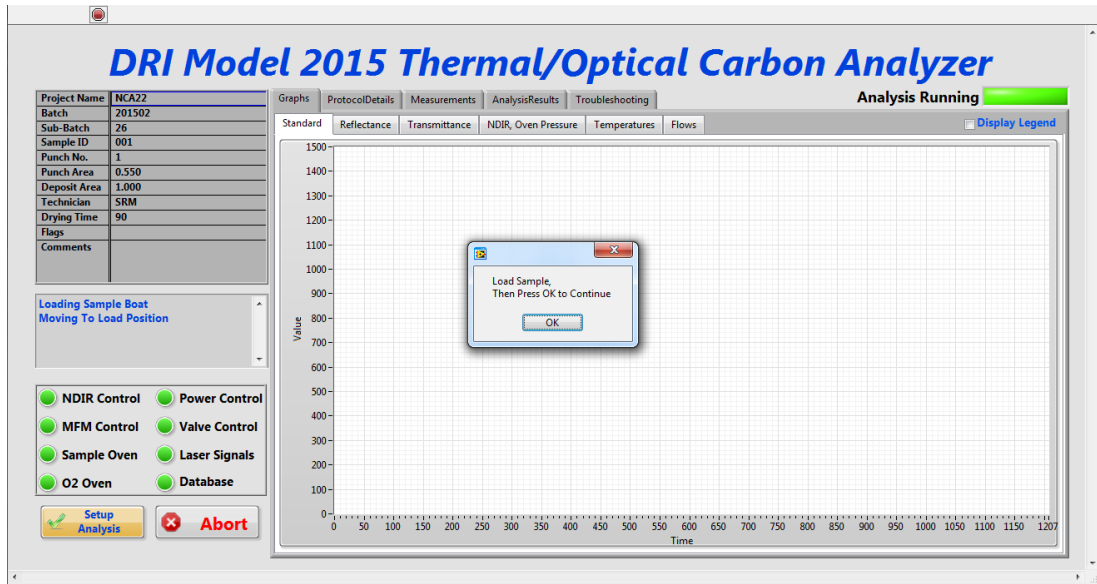

Figure 4-7. Sample analysis status screen with prompt to load the sample punch.

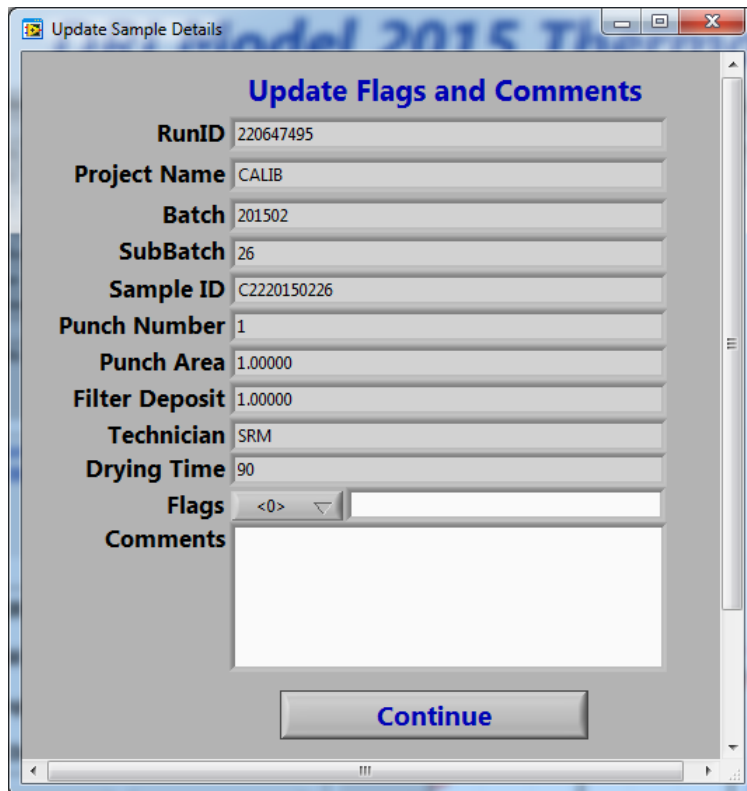

Figure 4-8. End of run form for entering post-analysis flags and comments.

4.2.4 Post-Analysis

At the end of each analysis, data is saved to the database, split times are calculated, carbon peaks are integrated, and tabular and graphical printouts are produced. The sample boat will retract to the calibration position when it is sufficiently cooled by the fan (to < 100 °C) and will continue to cool until it reaches less than 50 °C. Take the following actions:

- Examine the tabular printout (Figure 4-9) to confirm that the sample details were entered correctly, instrument responses are correct, and the calibration peak counts are within specifications (Section 3.2).
- Examine the graphical thermogram printout (Figure 4-10) to confirm that the NDIR, lasers, and sample oven temperature profile are normal. Pay special attention to NDIR baseline, reflectance and transmittance drift and signal level, sample oven temperature overshoot, and calibration peak height.
- If a problem is found, register it in the analyzer log book and run list, and notify the lab supervisor immediately.

Project Name		NCA22		Run ID		220646464		Carbon Fractions Units: µg C/cm2	OC1	3.32500
Analyzer ID		Anl 22		Batch		02			OC2	5.72970
Protocol		IMPROVE_A		SubBatch		201525			OC3	7.54060
Start Time		14:23:30		Sample ID		030041			OC4	4.39960
Date		2/25/2015		Punch Number		15			EC1	8.25880
Software Version		2015Feb22		Punch Area		0.550000			EC2	0.748700
Carbon Cal. Slope		18.1660		Filter Dep. Area		1.00000			EC3	0.00330000
Carbon Cal. Intercept		0.00000		Technician		SRM			Total EC	9.01080
Gas Transit Time		10.0000		Drying Time		90			Total OC	20.9950
Pyrolysis Bandwidth		0.00000		Int. Method		1			Cal Peak	20198.6
Noise Precision		3.00000		Int. Threshold		2.00000			Total Carbon	30.0058
Transmittance	635nm Laser	LTPy1	4.47470	Total OC LT 1	25.4697	Total EC LT 1	4.53610			
	405nm Laser	LTPy2	3.77790	Total OC LT 2	24.7729	Total EC LT 2	5.23290			
	445nm Laser	LTPy3	4.38070	Total OC LT 3	25.3757	Total EC LT 3	4.63010			
	532nm Laser	LTPy4	4.47470	Total OC LT 4	25.4697	Total EC LT 4	4.53610			
	780nm Laser	LTPy5	3.98530	Total OC LT 5	24.9803	Total EC LT 5	5.02550			
	808nm Laser	LTPy6	3.98530	Total OC LT 6	24.9803	Total EC LT 6	5.02550			
	980nm Laser	LTPy7	3.88340	Total OC LT 7	24.8784	Total EC LT 7	5.12740			
Reflectance	635nm Laser	LRPy1	0.0177000	Total OC LR 1	21.0127	Total EC LR 1	8.99310			
	405nm Laser	LRPy2	1.41390	Total OC LR 2	22.4089	Total EC LR 2	7.59690			
	445nm Laser	LRPy3	1.01300	Total OC LR 3	22.0080	Total EC LR 3	7.99780			
	532nm Laser	LRPy4	0.133200	Total OC LR 4	21.1282	Total EC LR 4	8.87760			
	780nm Laser	LRPy5	4.33670	Total OC LR 5	25.3317	Total EC LR 5	4.67410			
	808nm Laser	LRPy6	0.436600	Total OC LR 6	21.4316	Total EC LR 6	8.57420			
	980nm Laser	LRPy7	1.30530	Total OC LR 7	22.3003	Total EC LR 7	7.70550			

Figure 4-9. Example of tabular data printout of sample analysis.

Title: DRI Model 2015 Multiwavelength Carbon Analysis
 (TOR/TOT) of Aerosol Filter Samples - Method IMPROVE_A for CSN

- Mark the analysis date on the sample analysis run list.
- Using clean tweezers, remove the punch from the boat and tape it to the thermogram with transparent tape, ensuring that the punch is deposit-side up. Mark thermogram for any coloration that indicates minerals or unburnt material.

Repeat the above steps for additional analysis runs.

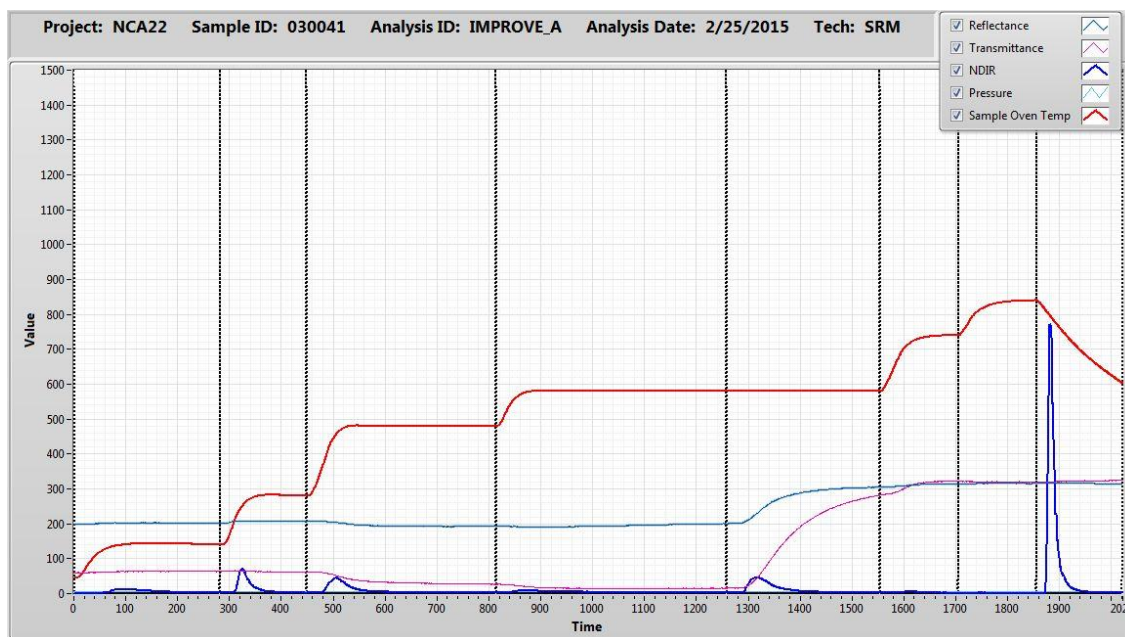

Figure 4-10. Example of graphical printout of sample analysis thermogram.

4.2.5 Special Analysis

4.2.5.1 System Blanks

- Go through all the steps for a normal analysis, but remove the punch from the previous analysis. Proceed with the routine analysis.
- Use Project name “SYSBLK”, Batch # “YYYYmm” for the year and month and Sub-batch # “dd” for the day. The sample ID should be in the format “SBxxYYYYmmdd” where “xx” is the analyzer number (e.g. SB2220150726 for analyzer number 22, run on July 26, 2015).
- Punch area and Deposit area should be “1”.
- Calculated carbon concentrations from the system blank should not be more 0.2 μg carbon. Values greater than this warrant an additional system blank or oven bake.

4.2.5.2 Carbonate Analysis

Title: DRI Model 2015 Multiwavelength Carbon Analysis
(TOR/TOT) of Aerosol Filter Samples - Method IMPROVE_A for CSN

-
- In the Enter Sample Details screen (Figure 4-4), enter the Sample ID, Run #, Punch area, Deposit area, and other information. Select *IMPROVEA_Carbonate* analysis protocol.
 - Follow the steps under Section 4.2.3 until the sample punch is loaded into the boat. Load sample and click “OK”. When asked if you want to delay or continue analysis, click “OK”. After 90 seconds the punch automatically centers under the acid injection port. The computer will prompt you to inject the hydrochloric acid (HCl), and then will state “Load syringe” and “XX seconds to acid injection”.
 - Prior to acidification (approximately 90 seconds elapsed analysis time), flush the 25 µl syringe with 0.4 M HCl into a waste beaker.
 - Inject 20 µl of 0.4 M HCl through the septum port to the sample, ensuring that the needle bevel is turned toward the punch and that the needle tip is touching the top of the punch.
 - When the analysis is underway, flush the syringe with Nanopure water to prevent corrosion of the syringe plunger.
 - After analysis, the program will delay any further analysis for 900 seconds to allow the punch to dry.
 - After the carbonate analysis is completed, a tabular summary and a copy of the graph will be printed (similar in format to Figure 4-9 and Figure 4-10). Select *cmdImproveA* from the “Command table” drop-down field and click “OK”. Click “Run” on the analysis Setup screen. The program will automatically cycle into the normal OC/EC analysis, using the same Sample ID. Heat from the oxidation oven will dry the sample in this position (for approximately 15 minutes) without prematurely baking carbon from the sample; the sample temperature should not exceed 42 °C. When the punch is dry proceed with normal OC/EC analysis.

4.2.6 Analyzer Shut-Down

At the end of the day, shut down the analyzers using the following procedures:

- Leave the last analyzed punch in the boat with the boat positioned in the Calibrate position. This punch will be used as the laboratory blank the following morning.
- Perform end-of-the-day calibration gas injection routine, or use *AutoCalib protocol*, and record the calibration peak counts following the schedule shown in Table 3-1. Any values outside the expected ranges should be investigated and rerun. Because low values from the end-of-the-day calibration could potentially invalidate the entire day's runs, any deviation from the accepted ranges must be noted and the cause identified. Notify the lab supervisor.
- Leave the *Carbon2015* software open.
- If desired, He/O₂ and CH₄ Cal Gas may be turned off with the toggle valves to conserve gases. However, all other gases should be left on as long as the oxidation oven is heated.

Title: DRI Model 2015 Multiwavelength Carbon Analysis
 (TOR/TOT) of Aerosol Filter Samples - Method IMPROVE_A for CSN

- Place all of the day's printouts, including calibration data in a file folder labeled with the date and analyzer number. Place on the lab supervisor's desk for Level I validation (Section 6.5).
- Turn off the monitors. Leave the computers and analyzers on overnight unless the potential for power outages or power surges exists. Make a final check of the gas cylinder pressures to ensure that gas flow, especially the compressed air, will continue until someone will be available to check them again.
- Move the samples and blue ice in the Styrofoam cooler or refrigerator back into the sample storage freezer and verify that the freezer doors are completely closed.
- If the 25 or 50 μl syringe was used for carbonate analysis, thoroughly rinse the syringe with distilled water. Tightly cap all solutions and store in the refrigerator. Avoid freezing the solution to prevent crystallization.

4.3 DAILY OPERATOR CHECKLIST

4.3.1 General

- ___ Check e-mail and notes on the board BEFORE starting analysis
- ___ Check all gas cylinders (> 200 psi)

4.3.2 Each Analyzer

- ___ Make sure a clean filter is on the sample boat (if the filter is an "m2" get a blank punch from the box labeled "Blank Filters")
- ___ Leak test all analyzers
- ___ Record Transmittance and Reflectance on the Daily Check List
- ___ Run laboratory blank (total carbon [TC] should be < 0.2 $\mu\text{g C/cm}^2$). If TC is > 0.2 μg , use the *Bake* protocol to bake oven, then repeat lab blank to check and see if TC is < 0.2 μg . Follow Table 4-1 for the suggested naming convention of different analysis types
- ___ Run appropriate morning calibration for that day (Sucrose, KHP, CO₂, Auto-calibration) following the schedule in Table 3-1 and record the results on the Daily Check List.
- ___ During the evening (~6 PM), perform a second calibration as indicated by Table 3-1 and record the results on the Daily Check List

4.3.3 Routine Sample Analysis

- ___ Retrieve **correct** sample and **mark** the analyzer it will be run on and the analysis date on the run list
- ___ Input **correct** parameters on the sample details information form and **verify** entries
- ___ Punch a sample
- ___ Load sample on the boat
- ___ **Record** all information in the log book
- ___ Clean the tweezers, dish, and punch with Kimwipes
- ___ Put the filter sample back in the refrigerator

Title: DRI Model 2015 Multiwavelength Carbon Analysis
(TOR/TOT) of Aerosol Filter Samples - Method IMPROVE_A for CSN

- Get the printout and **verify** the report carefully after a run
- Remove the analyzed punch from the analyzer and tape it to the thermogram printout
- **Flag** the analysis if there is anything wrong
- Repeat these steps for the next sample

4.3.4 **Routine Precautions**

- Keep all tools and working area clean
- Be careful not to contaminate filter samples (do not touch with bare hands)
- Double-check that you are running the correct sample on the correct analyzer
- Report any problem that cannot be solved to the supervisor

DRI STANDARD OPERATING PROCEDURE

Page: 53 of 76
 Date: 02/28/2017
 Number: 2-231r0
 Revision: 1

Title: DRI Model 2015 Multiwavelength Carbon Analysis
 (TOR/TOT) of Aerosol Filter Samples - Method IMPROVE_A for CSN

Table 4-1. Detailed suggested metadata and protocols for analysis types.

Analysis Type	Description of Purpose	Project Name	Batch	Sub-Batch	Sample ID	Protocol
Laboratory Blank	Routine non-cleaning analysis of blank, clean, filter punch	LABBLK	YYYYmm	dd	LBxxYYYYmmdd	<i>IMPROVE_A</i>
System Blank	Non-cleaning filter-free analysis	SYSBLK	YYYYmm	dd	SBxxYYYYmmdd	<i>IMPROVE_A</i>
Cleaning Blank	Cleaning run to eliminate contamination issues	TESTBLK	YYYYmm	dd	TESTxxYYYYmmdd	<i>IMPROVE_A</i>
Oven Bake	Cleaning run to eliminate contamination issues	TESTBLK	YYYYmm	dd	BAKExxYYYYmmdd	<i>Bake</i>
Auto Calibration	Routine auto injection of internal standard	CALIB	YYYYmm	dd	CxxYYYYmmdd	<i>Autocalib</i>
Carbon Injection (routine)	Routine carbon dioxide injection	CALIB	YYYYmm	dd	CIxxYYYYmmdd	<i>HeOnly</i>
Sucrose (routine)	Routine sucrose test	CALIB	YYYYmm	dd	SUxxYYYYmmdd	<i>IMPROVE_A</i>
KHP (routine)	Routine KHP test	CALIB	YYYYmm	dd	KHPxxYYYYmmdd	<i>IMPROVE_A</i>
Carbon Injection (calibration)	Carbon dioxide injection for carbon calibration	CALIB	CARBON	YYYYmmdd	CIxxYYYYmmdd_vvvv	<i>HeOnly</i>

Table 4-1. Detailed suggested metadata and protocols for analysis types (continued).

Analysis Type	Description of Purpose	Project Name	Batch	Sub-Batch	Sample ID	Protocol
Carbon Injection (calibration)	Methane injection for carbon calibration	CALIB	CARBON	YYYYmmdd	MIxxYYYYmmdd_vvvv	<i>HeOnly</i>
Sucrose (calibration)	Sucrose analysis for carbon calibration	CALIB	CARBON	YYYYmmdd	SUxxYYYYmmdd_vv	<i>IMPROVE_A</i>
KHP (calibration)	KHP analysis for carbon calibration	CALIB	CARBON	YYYYmmdd	KHPxxYYYYmmdd_vv	<i>IMPROVE_A</i>

5 QUANTIFICATION

5.1 Measurement Calculations

Section 3.4.7 contains the equations used to determine measurement values.

5.2 Precision (Uncertainty) Calculations

Precision is determined from replicate measurements as the average fractional difference between original and replicate analysis concentrations. Concentration uncertainty is the fractional precision times sample concentration. If sample concentration times fractional precision is zero, then the detection limit is used as concentration uncertainty.

The precision calculation program for chemical analysis methods also allows for rejection of outliers and selection of concentration ranges for precision calculations. The uncertainty is calculated using the following formulas:

$$CV = \frac{\sum_{i=1}^N \frac{2 \times |c_i - c_{i,r}|}{c_i + c_{i,r}}}{N}$$

$$Unc_i = \sqrt{(CV \times c_i)^2 + (MDL/3)^2}$$

- Where *CV* = coefficient of variance
N = number of samples
c_i = concentration of initial analysis
c_{i,r} = concentration of sample “i” replicate analysis
MDL = minimum detection limit (3σ of laboratory blanks)
Unc = uncertainty

6 QUALITY CONTROL

6.1 Acceptance Testing

Acceptance runs for pre-fired quartz filters result in $< 1.5 \mu\text{g}/\text{cm}^2$ OC, $< 0.5 \mu\text{g}/\text{cm}^2$ EC, and $< 2.0 \mu\text{g}/\text{cm}^2$ TC for IMPROVE_A protocol. Filters which exceed these levels must be re-fired or rejected. See DRI SOP #2-106, Pre-Firing of Quartz Filters Analysis for Carbon.

6.2 Performance Testing

System blanks are performed each Sunday and laboratory blanks at the beginning of each day (see Table 3-1) to confirm the system is not introducing bias in the carbon results and to confirm that the laser signal is not temperature-dependent. Contamination is potentially due to:

- Operator practices, such as improper cleaning of tweezers and punch.
- Teflon particles on the push rod getting into the heated zone of the quartz oven.
- Sample boat contamination.
- Contamination of the carrier gas.
- Fibers left on the punch tool or on the flat glass plate during cleaning.
- Contamination from field operator.
- Contamination from normal use of analyzer.
- Maintenance/part replacement.

A temperature-dependent laser signal is potentially due to:

- Physical coupling of the push rod to the boat during the run.
- Boat movement due to loose boat holder.
- A quartz rod (laser light pipe) ready for replacement. As quartz is heated to high temperatures, devitrification (white deposits of SiO_2) occurs that leads to a decrease in the laser intensity. The end surface becomes frosty. The bottom light pipe also receives droppings of quartz particles from filter discs during analysis. Thus, the bottom light pipe will deteriorate faster than the upper light pipe. Microscopic cracks in the quartz rod will increase internal reflectance of the laser light; as the number of these cracks multiply, the effect of temperature on these cracks, and thus on the reflectance, becomes an interference in the laser signal.

As described in Section 3.2, the calibration peak at the end of each analysis run serves as a regular standard; the integrated area under the calibration peak serves as a measure of analyzer performance. In addition, the daily injections of two calibration gases further serve as standards. Only a limited set of primary standards (NIST-traceable) currently exist for carbon analysis. These do not include a range of organic compounds from low- to high-molecular weights, with

varying degrees of susceptibility to pyrolysis, or EC and carbonate compounds. The *AutoCalib* protocol allows the condition of the MnO₂ oxidizer to be monitored and verified.

6.3 Reproducibility Testing

Replicates of analyzed samples are performed at the rate of one per group of ten samples. The replicate is selected randomly and run immediately after each group of ten is completed. The random analyzer for the replicate is identified using a chart created in Microsoft Excel (shown in Figure 6-1) using the random number generator, which results in replicate analysis on the same and different analyzers.

CARBON ANALYZER REPLICATE CHECKLIST																											
In order to keep track of the replicates between machines on large projects, please use the checklist below by placing an "X" in the appropriate box. For example in the first group below, once you have completed 10 runs on the run list, randomly select one QID from those 10 analyses, find that analyzer # in the "Orig Run" column and replicate it on the analyzer number listed in the next available box in the "Replicate On" section. Place an "X" on that number to indicate the replicate has been done. If an analyzer is not operating, draw a straight line through it and go to the next number in the row.																											
ORIG RUN	Replicate On																										
CA6	12	10	13	16	19	13	10	6	6	10	8	10	13	8	9	6	19	12	8	9	18	13	8	12	8	18	6
CA7	16	12	13	19	6	9	18	19	11	12	11	9	19	8	13	16	8	7	16	7	6	6	19	13	10	8	10
CA8	18	10	11	10	13	13	19	8	11	11	9	7	18	8	11	16	6	9	19	7	10	16	18	16	6	12	9
CA9	18	7	19	6	10	13	11	12	12	13	13	19	8	8	8	19	12	10	19	11	8	18	18	11	8	16	11
CA10	9	16	8	9	6	13	6	19	19	9	16	6	16	13	8	9	19	16	7	16	6	9	6	13	16	8	6
CA11	7	11	13	6	18	12	9	11	10	19	8	12	9	7	9	12	7	18	11	18	11	9	6	19	11	7	6
CA12	18	8	10	9	19	9	16	18	16	19	7	13	11	8	19	11	19	19	18	12	18	16	18	16	10	16	9
CA13	8	8	7	10	13	9	18	16	13	9	8	8	16	19	12	12	6	9	18	10	18	10	11	9	6	13	6
CA16	11	12	10	7	12	10	10	9	7	11	8	12	10	18	19	8	16	8	8	7	12	6	8	7	8	6	19
CA18	13	6	18	19	8	16	19	18	8	12	11	16	16	7	16	7	7	8	19	6	11	13	10	7	11	18	10
CA19	11	19	6	13	19	11	6	19	6	18	12	18	19	13	18	16	10	12	12	9	7	13	10	7	16	7	13

Figure 6-1. Example of carbon analyzer replicate checklist.

This practice provides a better indication of potential differences if samples are analyzed by different laboratories. The $\mu\text{g}/\text{cm}^2$ values for OC, EC and TC are compared with the original run. The values should meet the following acceptance levels:

Range	Acceptance Levels
OC or TC < 10 $\mu\text{g}/\text{cm}^2$	< $\pm 1.0 \mu\text{g}/\text{cm}^2$
OC or TC > 10 $\mu\text{g}/\text{cm}^2$	< 10 % of average of the 2 values
EC < 10 $\mu\text{g}/\text{cm}^2$	< $\pm 2.0 \mu\text{g}/\text{cm}^2$
EC > 10 $\mu\text{g}/\text{cm}^2$	< 20 % of average of the 2 values

Notice that the acceptance levels converge at $10 \mu\text{g}/\text{cm}^2$. Replicates which do not meet the above criteria must be investigated for analyzer or sample anomalies. Analyzer anomalies include poor response (as reflected in the calibration peak areas) or poor laser signals affecting the splits between OC and EC. Typical sample anomalies include inhomogeneous deposits or contamination during analysis or from the field sampling location. Inconsistent replicates for which a reason cannot be found must be rerun again unless the filter condition will not allow an additional representative punch to be taken.

6.4 Control Charts and Procedures

Control charts are updated at the beginning of each month. These charts include a month of calibration data and are posted in the carbon room until the end of the month, after which they are filed with the raw analysis results.

The control chart gives a plot of calibration peak counts as percent deviation from a historical mean versus date. Instances where the calibration peak area deviates by more than 10% from the historical mean must be investigated and the cause must be corrected. The historical mean covers results from the previous three months and is updated either quarterly, when the CH_4 calibration gas is changed, when the MnO_2 is replaced, or when extensive repairs are performed.

6.5 Data Validation

6.5.1 Analysis Flags

During Level 0 validation (see Section 6.5.2), unusual conditions of the deposit or analysis problems are noted on the analysis printouts. Errors in pre-analysis data entry (e.g., in filter ID, punch size, deposit area) are corrected.

Flags are applied to the Access file created from the analysis results (see Section 6.5.2). The analysis flags commonly used are presented in Table 8-1. Note that all results flagged with "v" must include a description of the reason for invalidating the sample in the remarks field unless a subcode is included which provides additional information (such as v3-“potential contamination”).

6.5.2 Daily Validation

Level 0 validation is performed by manually checking the tabular and thermogram printouts the day after the analysis is performed. The laboratory supervisor or a designated technician is responsible for checking the data. The following items are checked on the tabular data (Figure 4-9):

- The filter ID is correct and Punch #.
- For calibration runs, the tabular and thermogram printouts are checked to make sure the catalysts are operating at required level.
- The analysis date and time is correct.
- The punch area is correct; errors in entry require that the calculated carbon concentrations be recalculated.

Title: DRI Model 2015 Multiwavelength Carbon Analysis
 (TOR/TOT) of Aerosol Filter Samples - Method IMPROVE_A for CSN

Table 6-1. Common laboratory analysis flags.

Validation Flag	Sub Flag	Description
b	b1	Blank.
	b2	Field/-dynamic blank.
	b3	Laboratory blank.
	b4	Distilled-deionized water blank.
	b5	Method blank.
	b6	Extract/-solution blank.
c	c1	Transport blank.
	c2	Analysis result reprocessed or recalculated.
d f	c1	XRF spectrum reprocessed using manually adjusted background.
	c2	XRF spectrum reprocessed using interactive deconvolution
	f1	Sample dropped.
	f2	Filter damaged or ripped.
	f3	Filter damaged, outside of analysis area.
	f4	Filter damaged, within analysis area.
g	f5	Filter wrinkled.
	f6	Filter stuck to PetriSlide.
	g1	Teflon membrane separated from support ring.
	g2	Pinholes in filter.
	g3	Filter deposit damaged.
	g4	Deposit scratched or scraped, causing a thin line in the deposit.
h	g5	Deposit smudged, causing a large area of deposit to be displaced.
	g6	Filter deposit side down in PetriSlide.
	h1	Part of deposit appears to have fallen off; particles on inside of PetriSlide.
	h2	Ungloved finger touched filter.
	h5	Gloved finger touched filter.
i	h1	Filter holder assembly problem.
	h2	Deposit not centered.
	h4	Sampled on wrong side of filter.
	h5	Filter support grid upside down- deposit has widely spaced stripes or grid pattern. Two filters in PetriSlide, analyzed top filter
m	i1	Inhomogeneous sample deposit.
	i2	Evidence of impaction - deposit heavier in center of filter.
	i3	Random areas of darker or lighter deposit on filter.
	i4	Light colored deposit with dark specks. Non-uniform deposit near edge - possible air leak.
m	m1	Analysis results affected by matrix effect.
	m2	Organic/elemental carbon split undetermined due to an apparent color change of non-carbon particles during analysis; all measured carbon reported as organic. Non-white (red) carbon punch after carbon analysis, indicative of mineral particles in deposit.

Title: DRI Model 2015 Multiwavelength Carbon Analysis
 (TOR/TOT) of Aerosol Filter Samples - Method IMPROVE_A for CSN

Table 6-1 Common laboratory analysis flags (continued).

Validation Flag	Sub Flag	Description
m	m3	A non-typical, but valid, laser response was observed during TOR analysis. This phenomenon may result in increased uncertainty of the organic/elemental carbon split. Total carbon measurements are likely unaffected.
	m4	NDIR drift quality control failure
	m5	Non-white (grey) carbon punch after carbon analysis
n	n1	Foreign substance on sample.
	n2	Insects on deposit, removed before analysis.
	n3	Insects on deposit, not all removed.
	n4	Metallic particles observed on deposit.
	n5	Many particles on deposit much larger than cut point of inlet.
	n6	Fibers or fuzz on filter.
	n7	Oily-looking droplets on filter.
	n8	Shiny substance on filter.
	n9	Particles on back of filter.
q	q1	Standard.
	q2	Quality control standard.
	q3	Externally prepared quality control standard.
	q4	Second type of externally prepared quality control standard. Calibration standard.
r	r1	Replicate analysis.
	r2	First replicate analysis on the same analyzer.
	r3	Second replicate analysis on the same analyzer.
	r4	Third replicate analysis on the same analyzer.
	r5	Sample re-analysis.
	r6	Replicate on different analyzer.
	r7	Sample re-extraction and re-analysis. Sample re-analyzed with same result, original value used.
s v	v1	Suspect analysis result. Invalid (void) analysis result. Quality control standard check exceeded $\pm 10\%$ of specified concentration range.
	v2	Replicate analysis failed acceptable limit specified in SOP.
	v3	Potential contamination.
	v4	Concentration out of expected range.
	v5	Instrument error
	v6	Operator error
	v7	Software error
w	w1	Wet Sample. Deposit spotted from water drops.
	y	Data normalized
y	y1	XRF data normalized to a sulfate/sulfur ratio of three
	y2	Each species reported as a percentage of the measured species sum

- The deposit area is correct; errors in entry require that the calculated carbon concentrations be recalculated by hand.
- The calibration peak area is in the correct range (Section 3.2).
- The initial and the final NDIR baseline readings are within three counts of each other; excessive NDIR baseline drift is a cause for re-analysis. NOTE: Some very heavily loaded filters will have an NDIR baseline drift greater than three counts no matter which carbon analyzer the sample is run on; typically a NDIR baseline drift greater than three counts signals either a problem with the sample (e.g., very light or very heavy loading) or with the carbon analyzer.
- The lower laser split time and the upper laser split time are within 10 seconds of each other. If the times differ by more than 10 seconds, check that the lower split OC and upper split OC differ by no more than 5%. OC values which differ by more than 5%, unless due to a small change in laser signal resulting from an extremely clean or very dark sample, require re-analysis. Flags should be added to the data file print out as follows:
 - If Regular OC Reflectance split is greater than 5% note “RO” in comments field;
If Transmittance split is greater than 5% note “TO” in comments field.
 - If Regular EC Reflectance split is greater than 20% note “RE” in comments field;
If Transmittance split is greater than 5% note “TE” in comments field.
- Calculated carbon values for calibration injection runs are within 10% of the current mean value for the injected gas type on that analyzer.

Items which are found to be okay are underlined in red. Items which have problems are circled in red.

The thermograms are checked for the following (Figure 4-10):

- The initial NDIR baseline is flat, indicating that the analyzer has been thoroughly purged before analysis began.
- The final NDIR baseline prior to the calibration peak is within three counts of the initial NDIR baseline; excessive drift is cause for reanalysis.
- The laser signal should dip below the initial laser line until O₂ is introduced, at which point the signal should rise steeply. (For most samples, charring does occur). High temperature soot samples may not show this characteristic. The laser signal during OC4 stage should be nearly flat for most samples. If an analyzer show consistent early split for samples and increasing laser signal during OC4 for sucrose runs, the analyzer need be checked for laser stability and leak.

- The temperature readings reflect stable and smooth temperatures at each level and quick transitions between levels.
- Problems or deviations from normal should be circled in red. If the sample punch taped to the thermogram is not white, it is also circled.

If examination of the tabular and thermogram printouts results in a decision that a sample should be reanalyzed, write "Rerun" in red on the printouts and prepare a re-analysis list. This list should be posted immediately after the validation is complete, and those samples should be rerun as soon as they can be conveniently fit into the analysis queue.

Evidence of persistent analyzer problems must be resolved, either by physically examining the analyzer or reviewing the problems with the analyzer operator.

6.5.3 Validation of Data File

The following steps are followed to create a database generated file containing carbon data and to perform Level "I" validation on it:

- Each analyzer will have an Access database containing all of the raw carbon data.
- A query (manual or automated by connected server) is used to generate the project data in $\mu\text{g}/\text{cm}^2$ or $\mu\text{g}/\text{filter}$ and a validation report is then generated from this query.
- The output of the Access query is saved or exported as an Excel file or database report for data validation and processing. The MS Excel file naming convention calls for a name in the following format:

xxOETnnt.xls

where:

xx is the two-character project identifier

OET is organic/elemental carbon

nn is the two- or three-digit batch number (generally used to distinguish between different projects for the same client or between sampling quarters for an extended project)

t is the sample type based on sampler technology:

A is agricultural burn emissions dilution sampler

C is combination particle/gaseous sampler

D is dichotomous sampler for $\text{PM}_{2.5}$, $\text{PM}_{\text{coarse}}$, and PM_{10}

G is gaseous

H is high-volume sampler

I is IMPROVE/NPS sampler

P is MiniVol Sampler

Q is audit samples

R is resuspension chamber

Title: DRI Model 2015 Multiwavelength Carbon Analysis
(TOR/TOT) of Aerosol Filter Samples - Method IMPROVE_A for CSN

S is sequential filter sampler (SFS)

W is wet Deposition

X is unknown

Y is y-sampler (DRI source sampler)

- The final MS Excel or dbf file name is specified on the analysis list posted in the carbon room.
- Begin validation by matching the filters listed on the analysis list with the filters listed on the MS Excel or database printout. There must be at least one entry on the printout for every filter listed on the analysis list.
- Flag field and lab blanks while the list is being reviewed by placing "b1", "b2", "b3", or "b6" in the second column of the printout. Because the MS Excel or database printout is sorted by ID number, replicates and reruns will be grouped together.
- Indicate missing data by writing the missing filter ID in the margin with an arrow drawn to the appropriate place of insertion. Scan the printout for unusual IDs which may have been mistyped or misread by the scanner during analysis. Generally, these will appear at the beginning or end of the printout, due to the sorting process. Make sure that all samples listed on a rerun list appear on the printout.
- Resolve all missing data. Scan the deposit area column for incorrect entries. Circle the incorrect entries to ensure that corrected values replace those currently in the database.
- Scan the filter IDs for multiple entries of ID numbers. Under normal conditions, the only times multiple entries should occur are reruns and replicates. All multiple entries must be flagged appropriately.
- Scan for missing runs. The most common example is an error in the filter ID data entry. If a run is invalid, an entry for the first run must be inserted, flagged as invalid, and labeled with the reason it was invalid. All punches taken from the filters **MUST** be accounted for and documented in the file.
- Pull the analysis folders and go through the analysis summaries and thermograms one by one. Check for the conditions listed in Section 6.5.2
 - Reflectance and Transmittance Regular OC Lower Split and Upper Split are within 5% and Regular EC Lower Split and Upper Split are within 20%. OC values which differ by more than 5%, unless due to a small change in laser signal resulting from an extremely clean or very dark sample, requires reanalysis. Comments should be added to the print out as follows:
 - If Regular OC Reflectance split is greater than 5% note "RO" in comments field; If Transmittance split is greater than 5% note "TO" in comments field.
 - If Regular EC Reflectance split is greater than 20% note "RE" in comments field; If Transmittance split is greater than 5% note "TE" in comments field.

Title: DRI Model 2015 Multiwavelength Carbon Analysis
 (TOR/TOT) of Aerosol Filter Samples - Method IMPROVE_A for CSN

- Punch discoloration after analysis is complete (See Table 6-1 for m2 flag)
- Verify and resolve all circled items and missing flags.
 - Determine if analyses flagged by the operator are legitimate. These flags are determined by the operator at the end of the analysis run and are defined in Table 6-2.
 - If the temporary flag is not warranted, draw a line through the flag to indicate that it should be removed.
 - If the sample should be rerun, add it to a rerun list.
 - If the analysis has some anomaly, but still appears to be legitimate, either flag or add notes to the comments field as appropriate.
 - Analysis flags are defined in Table 6-1.
- Invalid samples without a definitive void flag must have an entry in the comments field to describe the reason that the sample is invalid.
- Scan the OC and EC columns looking for unusually high or low values. At this time make sure that the field blanks and/or lab blanks are all close to one another. Circle any possible outliers for further investigation.
- Compare replicates against original run. The values should meet the following acceptance levels:

Range	Acceptance Levels
OC or TC < 10 µg/cm ²	< ±1.0 µg/cm ²
OC or TC > 10 µg/cm ²	< 10 % of average of the 2 values
EC < 10 µg/cm ²	< ±2.0 µg/cm ²
EC > 10 µg/cm ²	< 20 % of average of the 2 values

- Check the OC/TC ratio. Typical rural samples should not be less than 0.65. Circle any possible outliers for further investigation.
- Scan for records where EC is greater than OC. These may require additional investigation, depending on loading and sample source. Circle records for further investigation.
- Scan blanks for OC being greater than 3.95 × deposit area and for EC greater than the deposit area. Rerun any unusually high blanks.
- All operator-generated flags must be either converted to standard analysis flags (Table 6-1) or removed. The flags in Table 6-2 are temporary flags only and are not recognized as legitimate analysis flags at DRI.
- After all thermograms have been reviewed and all possible reruns have been identified, post the rerun list in the carbon room and have the reruns done as soon as possible.

Title: DRI Model 2015 Multiwavelength Carbon Analysis
 (TOR/TOT) of Aerosol Filter Samples - Method IMPROVE_A for CSN

Table 6-2. Laboratory carbon analysis technician temporary data validation flags.

Flag	Description
EI	Error in sample ID
EA	Error in sample deposit area
ST	Suspect temperature profile
SF	Suspect NDIR signal
SL	Suspect laser signal
Mi	Miscellaneous problem
m2	Non-white sample punch after analysis
v	Invalid run
r	Replicate
b	Blank
i	Inhomogeneous
f	Filter media damaged
g	Sample deposit damaged
d	Sample dropped
n	Foreign substance on filter
w	Sample wet

- Review the data from the reruns, looking for inconsistencies. Confirm that the reasons for the rerun have been addressed. Mark the printout with the new values for manual insertion into the MS Excel or database file. Previous runs must be flagged as invalid or the reruns flagged as replicates.
- Finally, all comments, flags, insertions, and other changes made to the printout are entered into the database file. After all changes are made, generate a new printout. Label the new printout with the file name and printout date. Assemble a copy of the printout and the database file for further validation and reporting.
- Data is finalized in an MS Excel or database file and then processed through the SQL server to match the filter transfer file to the filter IDs. This is combined into XML files that are submitted to U.C. Davis.

6.6 Summary of Quality Assurance/Quality Control Activities

Table 6-3 provides a summary of routine quality assurance/quality control (QA/QC) activities for the IMPROVE_A analysis of organic and elemental carbon, including frequencies and tolerances. See Table 3-1 for the daily calibration schedule.

Title: DRI Model 2015 Multiwavelength Carbon Analysis
 (TOR/TOT) of Aerosol Filter Samples - Method IMPROVE_A for CSN

Table 6-3. Summary of Quality Assurance/Quality Control Activities for IMPROVE_A Analysis of Carbon*

QA/QC Activity	Calibration Standard and Range	Calibration Frequency ^b	Acceptance Criteria	Corrective Action
Laboratory Blank Check	NAa	Beginning of analysis day.	<0.2 µg C/cm ² .	Check instrument and filter lots.
Leak Check	NA	Beginning of analysis day.	Oven pressure drops less than 0.1 psi per second	Locate leaks and fix.
Laser Performance Check	NA	Beginning of analysis day.	635 nm laser transmittance 100-300; Reflectance 350-550; No saturation at EC stage	Check light pipes and filter holder position; adjust reflectance or transmittance trim pot.
Calibration				
Peak Area Check	NIST 5% CH ₄ /He gas standard; 20 µg C (6-port valve injection loop, 1000 µl).	Every analysis.	Counts >17,000 and 95-105% of average calibration peak area of the day.	Void analysis result; check flowrates, leak, and 6-port valve temperature; conduct an auto-calibration; and repeat analysis with second filter punch.
Auto-Calibration Check	NIST 5% CH ₄ /He gas standard; 20 µg C (Carle valve injection loop, 1000 µl).	Alternating beginning or end of each analysis day.	95-105% recovery and calibration peak area 90-110% of weekly average.	Troubleshoot and correct system before analyzing samples.
Manual Injection Calibration	NIST 5% CH ₄ /He or NIST 5% CO ₂ /He gas standards; 20 µg C (Certified gas-tight syringe, 1000 µl).	Four times a week (Sun., Tue., Thu., and Sat.)	95-105% recovery and calibration peak area 90-110% of weekly average.	Troubleshoot and correct system before analyzing samples.

* Assuming 24/7 Operation

Title: DRI Model 2015 Multiwavelength Carbon Analysis
 (TOR/TOT) of Aerosol Filter Samples - Method IMPROVE_A for CSN

Table 6-3 Summary of Quality Assurance/Quality Control Activities for IMPROVE_A Analysis of Carbon (continued)

Requirement	Calibration Standard and Range	Calibration Frequency ^b	Acceptance Criteria	Corrective Action
Sucrose Calibration Check	10 μ L of 1800 ppm C sucrose standard; 18 μ g C.	Thrice per week (began March, 2009).	17.1-18.9 μ g C/filter	Troubleshoot and correct system before analyzing samples.
Potassium Hydrogen Phthalate (KHP) Calibration Check	10 μ L of 1800 ppm C KHP standard; 18 μ g C.	Twice per week (Tue. And Thu.)	17.1-18.9 μ g C/filter	Troubleshoot and correct system before analyzing samples.
System Blank Check	NA	Once per week.	<0.2 μ g C/cm ² .	Check instrument.
Multiple Point Calibrations	1800 ppm C Potassium hydrogen phthalate (KHP) and sucrose; NIST 5% CH ₄ /He, and NIST 5% CO ₂ /He gas standards; 9-36 μ g C for KHP and sucrose; 2-30 μ g C for CH ₄ and CO ₂ .	Every six months or after major instrument repair.	All slopes \pm 5% of average	Troubleshoot instrument and repeat calibration until results are within stated tolerances.
Sample Replicates (on the same or a different analyzer)	NA	Every 10 analyses.	\pm 10% when OC and TC >10 μ g C/cm ² \pm 20% when EC > 10 μ g C/cm ² or \leq 1 μ g/cm ² when OC and TC <10 μ g C/cm ² \leq 2 μ g/cm ² when EC <10 μ g C/cm ²	Investigate instrument and sample anomalies and rerun replicate when difference is > \pm 10%.
Temperature Calibrations	Tempilaq® G (Tempil, Inc., South Plainfield, NJ, USA); Three replicates each of 121, 184, 253, 510, 704, and 816 °C.	Every six months, or whenever the thermocouple is replaced.	Linear relationship between thermocouple and Tempilaq® G values with R ² >0.99	Troubleshoot instrument and repeat calibration until results are within stated tolerances.
Oxygen Level in Helium Atmosphere (using GC/MS) ^c	Certified gas-tight syringe; 0-100 ppmv.	Every six months, or whenever leak is detected.	Less than the certified amount of He cylinder	Replace the He cylinder and/or O ₂ scrubber.
Interlaboratory comparisons	NA	Once per year.	NA	Review and verify procedures.
External systems audits	NA	Once every two to three years.	NA	Take action to correct any deficiencies noted in audit report.

^a NA: Not Applicable.

DRI STANDARD OPERATING PROCEDURE

Title: DRI Model 2015 Multiwavelength Carbon Analysis
(TOR/TOT) of Aerosol Filter Samples - Method IMPROVE_A for CSN

Page: 68 of 76
Date: 02/28/2017
Number: 2-231r0
Revision: 1

- ^b Calibration performed by carbon analyst, except for interlaboratory comparisons and external systems audits, which are conducted by the U.S. Environmental Protection Agency (EPA) National Air and Radiation Environmental Laboratory (NAREL).
- ^c Gas chromatography/mass spectrometer (Model 5975, Agilent Technology, Palo Alto, CA, USA).

7 REFERENCES

- Andreae, M.O.; Gelencser, A. (2006). Black carbon or brown carbon? The nature of light-absorbing carbonaceous aerosols. *Atmos. Chem. Phys.*, 6:3131-3148.
- Chen, L.-W.A.; Chow, J.C.; Watson, J.G.; Moosmüller, H.; Arnott, W.P. (2004). Modeling reflectance and transmittance of quartz-fiber filter samples containing elemental carbon particles: Implications for thermal/optical analysis. *J. Aerosol Sci.*, 35(6):765-780.
- Chen, L.-W.A.; Chow, J.C.; Watson, J.G.; Schichtel, B.A. (2012). Consistency of long-term elemental carbon trends from thermal and optical measurements in the IMPROVE network. *Atmos. Meas. Tech.*, 5:2329-2338.
- Chen, L.-W.A.; Chow, J.C.; Wang, X.L.; Robles, J.A.; Sumlin, B.J.; Lowenthal, D.H.; Watson, J.G. (2015). Multi-wavelength optical measurement to enhance thermal/optical analysis for carbonaceous aerosol. *Atmos. Meas. Tech.*, 8:451-461.
- Chow, J.C.; Watson, J.G.; Pritchett, L.C.; Pierson, W.R.; Frazier, C.A.; Purcell, R.G. (1993). The DRI Thermal/Optical Reflectance carbon analysis system: Description, evaluation and applications in U.S. air quality studies. *Atmos. Environ.*, 27A(8):1185-1201.
- Chow, J.C.; Watson, J.G. (1999). Ion chromatography in elemental analysis of airborne particles. In *Elemental Analysis of Airborne Particles, Vol. 1*, Landsberger, S., Creatchman, M., Eds.; Gordon and Breach Science: Amsterdam, 97-137
- Chow, J.C.; Watson, J.G.; Crow, D.; Lowenthal, D.H.; Merrifield, T.M. (2001). Comparison of IMPROVE and NIOSH carbon measurements. *Aerosol Sci. Technol.*, 34(1):23-34.
- Chow, J.C.; Watson, J.G. (2002). PM_{2.5} carbonate concentrations at regionally representative Interagency Monitoring of Protected Visual Environment sites. *J. Geophys. Res.*, 107(D21):ICC 6-1-ICC 6-9.
- Chow, J.C.; Watson, J.G.; Chen, L.-W.A.; Arnott, W.P.; Moosmüller, H.; Fung, K.K. (2004). Equivalence of elemental carbon by Thermal/Optical Reflectance and Transmittance with different temperature protocols. *Environ. Sci. Technol.*, 38(16):4414-4422.
- Chow, J.C.; Watson, J.G.; Chen, L.-W.A.; Paredes-Miranda, G.; Chang, M.-C.O.; Trimble, D.L.; Fung, K.K.; Zhang, H.; Yu, J.Z. (2005). Refining temperature measures in thermal/optical carbon analysis. *Atmos. Chem. Phys.*, 5(4):2961-2972.
- Chow, J.C.; Watson, J.G.; Chen, L.-W.A.; Chang, M.-C.O.; Robinson, N.F.; Trimble, D.L.; Kohl, S.D. (2007). The IMPROVE_A temperature protocol for thermal/optical carbon analysis: Maintaining consistency with a long-term database. *J. Air Waste Manage. Assoc.*, 57(9):1014-1023.
- Chow, J.C.; Watson, J.G.; Robles, J.; Wang, X.L.; Chen, L.-W.A.; Trimble, D.L.; Kohl, S.D.; Tropp, R.J.; Fung, K.K. (2011). Quality assurance and quality control for thermal/optical analysis of aerosol samples for organic and elemental carbon. *Anal. Bioanal. Chem.*, 401(10):3141-3152.

Title: DRI Model 2015 Multiwavelength Carbon Analysis
(TOR/TOT) of Aerosol Filter Samples - Method IMPROVE_A for CSN

-
- Chow, J.C.; Wang, X.L.; Sumlin, B.J.; Gronstal, S.B.; Chen, L.-W.A.; Trimble, D.L.; Kohl, S.D.; Mayorgal, S.R.; Riggio, G.M.; Hurbain, P.R.; Johnson, M.; Zimmermann, R.; Watson, J.G. (2015). Optical calibration and equivalence of a multiwavelength thermal/optical carbon analyzer. *AAQR*, 15(4):1145-1159.
- Heal, M.R.; Quincey, P.G. (2012). The relationship between black carbon concentration and black smoke: A more general approach. *Atmos. Environ.*, 54:538-544.
- Johnson, R.L. (1981). Development and evaluation of a thermal/optical method for the analysis of carbonaceous aerosol. Oregon Graduate Center.
- Johnson, R.L.; Shah, J.J.; Cary, R.A.; Huntzicker, J.J. (1981). An automated thermal-optical method for the analysis of carbonaceous aerosol. In *Atmospheric Aerosol: Source/Air Quality Relationships*, Macias, E. S., Hopke, P. K., Eds.; American Chemical Society: Washington, DC, 223-233
- Lin, C.I.; Friedlander, S.K. (1988). Soot oxidation in fibrous filters. 2. Effects of temperature, oxygen partial pressure, and sodium additives. *Langmuir*, 4(4):898-903.
- Moosmüller, H.; Chakrabarty, R.K.; Arnott, W.P. (2009). Aerosol light absorption and its measurement: A review. *J. Quant. Spectrosc. Radiat. Transfer*, 110:844-878.
- Novakov, T. (1981). Microchemical characterization of aerosols. In *Nature, Air and Methods of Microchemistry*, Malissa, H., Grasserbauer, M., Belcher, R., Eds.; Springer-Verlag, Wein: Graz, Austria, 141-165
- Novakov, T. (1982). Soot in the atmosphere. In *Particulate Carbon: Atmospheric Life Cycle*, Wolff, G. T., Klimisch, R. L., Eds.; Plenum Press: New York, NY, 19-41
- Rau, J.A. (1986). Residential wood combustion aerosol characterization as a function of size and source apportionment using chemical mass balance modeling. Oregon Graduate Center.
- Rosen, H.; Hansen, A.D.A.; Dod, R.L.; Gundel, L.A.; Novakov, T. (1982). Graphitic carbon in urban environments and the Arctic. In *Particulate Carbon: Atmospheric Life Cycle*, Wolff, G. T., Klimisch, R. L., Eds.; Plenum Press: New York, NY, 273-294
- Sandradewi, J.; Prevot, A.S.H.; Szidat, S.; Perron, N.; Alfarra, M.R.; Lanz, V.A.; Weingartner, E.; Baltensperger, U. (2008). Using aerosol light absorption measurements for the quantitative determination of wood burning and traffic emission contributions to particulate matter. *Environ. Sci. Technol.*, 42(9):3316-3323.
- Watson, J.G.; Chow, J.C.; Chen, L.-W.A. (2005). Summary of organic and elemental carbon/black carbon analysis methods and intercomparisons. *AAQR*, 5(1):65-102.

Title: DRI Model 2015 Multiwavelength Carbon Analysis
(TOR/TOT) of Aerosol Filter Samples - Method IMPROVE_A for CSN

8 CHANGE DOCUMENTATION

2/10/2017: New SOP 2-231r0 for the CSN Network (based on 2-226r1)

APPENDIX A: Abbreviations and Acronyms

°C	Degrees Celsius
µg/m ³	Micrograms per cubic meter
µl	Microliters
Cal Gas	Calibration Gas
Calibration Injection	The injection of calibration gases, either CO ₂ or CH ₄ , into the sample stream at the beginning and end of each work day to check instrument performance.
Calibration Peak	The NDIR peak resulting from the automatic injection of CO ₂ calibration gas at the end of each analysis run for each sample. All integrated peak areas are divided by the calibration peak area and multiplied by an instrument-specific calibration factor to obtain µg carbon per sample punch.

Chemicals Used:

HF	Hydrofluoric Acid
HCl	Hydrochloric Acid
He	Helium
CO ₂	Carbon Dioxide
CH ₄	Methane
O ₂	Oxygen
Na	Sodium
SiO ₂	Silicon Dioxide
K	Potassium
KHP	Potassium hydrogen phthalate
V	Vanadium
Cr	Chromium
Mn	Manganese
MnO ₂	Manganese Dioxide

DRI	Desert Research Institute
EC	Elemental Carbon
EC1	Carbon evolved from the filter punch in a 98% He/2% O ₂ atmosphere at 580 °C.
EC2	Carbon evolved from the filter punch in a 98% He/2% O ₂ atmosphere from 580 to 740 °C.
EC3	Carbon evolved from the filter punch in a 98% He/2% O ₂ atmosphere from 740 to 840 °C.
Elemental Carbon (EC)	Carbon evolved from the filter punch in a 98% He/2% O ₂ atmosphere at 580, 740, and 840 °C minus any pyrolyzed OC.
NDIR	NonDispersive Infra-Red Detector
NDIR Split Time	The time at which the laser split occurs plus the transit time required for thermally evolved carbon to travel from the sample punch to the NDIR.
GC	Gas Chromatography
GC/MS	Gas Chromatography/Mass Spectrometry

Title: DRI Model 2015 Multiwavelength Carbon Analysis
 (TOR/TOT) of Aerosol Filter Samples - Method IMPROVE_A for CSN

High Temperature EC	Carbon evolved from the filter punch in a 98% He/2% O ₂ atmosphere at 740 and 840 °C minus any pyrolyzed organic carbon present in these two peaks. This is EC minus the first EC peak (EC1).
High Temperature OC	Carbon evolved from the filter punch in a He-only atmosphere at 280, 480, and 580 °C plus pyrolyzed organic carbon. This is OC minus the first OC peak (OC1).
IMPROVE IMPROVE_A Thermal Protocol	Interagency Monitoring of PROtected Visual Environments A thermal protocol is used in carbon analyzers to quantify carbon fractions evolved at different temperature plateaus. The IMPROVE_A thermal protocol derives from the IMPROVE thermal protocol initiated in 1987 (Chow et al., 2005).
Laser Split	The separation between OC and EC, which depends on the laser-measured reflectance and/or transmittance of the filter punch returning to its initial value. At this point all pyrolyzed OC has been removed and EC is beginning to evolve.
Lower Split Time	The time at which the laser-measured reflectance and/or transmittance of the filter punch reaches its initial value minus the precision of the laser signal (currently defined as 10 counts).
LQL	Lower quantifiable limit
M	Mole
MDL	Minimum detection limit
NIST	National Institute of Science and Technology
OC	Organic Carbon
OC1	Carbon evolved from the filter punch in a He- only (>99.999%) atmosphere from ambient (~25 °C) to 140 °C.
OC2	Carbon evolved from the filter punch in a He- only (>99.999%) atmosphere from 140 to 280 °C.
OC3	Carbon evolved from the filter punch in a He- only (>99.999%) atmosphere from 280 to 480 °C.
OC4	Carbon evolved from the filter punch in a He- only (>99.999%) atmosphere from 480 to 580 °C.
OP	The carbon evolved from the time that the carrier gas flow is changed from He to 98% He/2% O ₂ at 580 °C to the time that the laser- measured filter reflectance (OPR) or transmittance (OPT) reaches its initial value. A negative sign is assigned if the laser split occurs before the introduction of O ₂ .
OPR	Pyrolyzed carbon measured by reflectance
OPT	Pyrolyzed carbon measured by transmittance
Organic Carbon (OC)	Carbon evolved from the filter punch in a He- only (>99.999%) atmosphere at 140, 280, 480 and 580 °C plus pyrolyzed organic carbon. This is the same as Volatile Organic Carbon (VOC) plus high- temperature OC.
psi	Pounds per square inch

Title: DRI Model 2015 Multiwavelength Carbon Analysis
(TOR/TOT) of Aerosol Filter Samples - Method IMPROVE_A for CSN

Pyrolysis	The conversion of OC compounds to EC due to thermal decomposition; this may be envisioned as "charring" during the organic portion of the analysis.
QA	Quality Assurance
QC	Quality Control
Regular Split Time	The time at which the laser-measured reflectance and/or transmittance of the filter punch reaches its initial value.
SiO ₂	Silicon Dioxide
STN	Speciation Trends Network
TC	Total Carbon
TOR	Thermal/Optical Reflectance
TOT	Thermal/Optical Transmittance
Total Carbon (TC)	All carbon evolved from the filter punch between ambient and 840 °C under He and 98% He /2% O ₂ atmospheres.
VOC	Volatile Organic Carbon
UHP	Ultra-High Purity
Upper Split Time	The time at which the laser-measured reflectance and/or transmittance of the filter punch reaches its initial value plus the precision of the laser signal (currently defined as 10 counts).
ΔT	Temperature Deviation

APPENDIX B: Basic Troubleshooting Guide

The following procedures describe fixes to address commonly observed issues during the operation of the Model 2015 Multiwavelength Carbon Analyzer

B.1 Persistent Leaks

Failure to pass leak check (Section 4.1.1) requires identifying the source of the leak using a helium leak detector. Procedures to address the leak depend on source. The following suggested procedures are based on the leak location:

- Reducing ferrule/thermocouple
 - Finger-tighten the nut that holds the reducing ferrule.
 - Retest for leaks. If tests show no leaks, resume analyzer operation. Persistent leak at this location requires reducing ferrule replacement. Consult installation/maintenance guide for instructions.
- Breech O-ring
 - In the Calibration Control screen (Figure 4-2), set the sample boat position to “Load”.
 - Detach the orange breech O-ring. Clean the area around the breech where the O-ring sits.
 - Install new breech O-ring. Set the sample boat position to “Analyze”. Test for leaks.
- Quartz oven outlet
 - Loosen the nut that connects the quartz oven to the stainless steel tubing.
 - Remove and replace the Teflon ferrules. Re-tighten the nut and check for leaks.

B.2 Laser Drift

- Set the sample boat position to the “Load” position.
- Remove any punch on the sample boat. Test the snugness of the sample boat on the holder. Remove boat, pinch boat holder wire, re-install boat if still loose.
- Set the sample boat position to “Analyze” position.
- Inspect the path of the laser beam through the quartz oven. Beam should pass through the center hole of the sample boat. Adjust the sample boat’s horizontal alignment by loosening the screws holding the pushrod thermocouple.
- Place a blank punch on the boat, and perform a laboratory blank check (Section 4.1.3) to test laser drift levels. Consult the installation/maintenance manual if drift still exceeds 5% of initial laser value.

B.3 Calibration Peak Area Inconsistent from Previous Values

- Check for leaks.

Title: DRI Model 2015 Multiwavelength Carbon Analysis
(TOR/TOT) of Aerosol Filter Samples - Method IMPROVE_A for CSN

- If leak-free, check if the flow rates of all gases are correct. Measure and adjust the CH₄ flow to be ~10 mL/min.
- Use a thermocouple to measure the temperature of the 6-port injection valve to make sure the temperature is close to 50 °C. Make sure the temperature sensor is tightly secured on the 6-port injection valve.
- Run an automated routine calibration (Section 3.3.1) to determine if the three CH₄ injections are comparable.
- Manually inject 1000 µL CH₄ and compare with the auto injection by the 6-port injection valve. If the manual injection results larger peak area than the auto injection, it's likely that there is a leak in connections around 6-port injection valve, or the temperature of the valve heater is too high.