

Lanier
also in
our AP5
Library

United States
Environmental Protection
Agency

Office of Water
Washington, DC 20460

840-B-92-002
January 1993



Guidance Specifying Management Measures For Sources Of Nonpoint Pollution In Coastal Waters

628.16
612
116

CONFIDENTIAL
CRIP 1111
Redding, CA

Issued Under the Authority of
Section 6217(g) of the Coastal Zone Act
Reauthorization Amendments of 1990

113

**Guidance Specifying Management Measures
For Sources Of Nonpoint Pollution
In Coastal Waters**

**Issued Under the Authority of Section 6217(g)
of the Coastal Zone Act Reauthorization
Amendments of 1990**

**United States Environmental Protection Agency
Office of Water
Washington, DC**

0162447 333

FOREWORD

This document contains guidance specifying management measures for sources of nonpoint pollution in coastal waters. Nonpoint pollution is the pollution of our nation's waters caused by rainfall or snowmelt moving over and through the ground. As the runoff moves, it picks up and carries away natural pollutants and pollutants resulting from human activity, finally depositing them into lakes, rivers, wetlands, coastal waters, and ground waters. In addition, hydrologic modification is a form of nonpoint source pollution that often adversely affects the biological and physical integrity of surface waters.

In the Coastal Zone Act Reauthorization Amendments of 1990 (CZARA), Congress recognized that nonpoint pollution is a key factor in the continuing degradation of many coastal waters and established a new program to address this pollution. Congress further recognized that the solution to nonpoint pollution lies in State and local action. Thus, in enacting the CZARA, Congress called upon States to develop and implement State Coastal Nonpoint Pollution Control Programs.

Congress assigned to the U.S. Environmental Protection Agency (EPA) the responsibility to develop this technical guidance to guide the States' development of Coastal Nonpoint Pollution Control Programs, which must be in conformity with the technical guidance. EPA developed this guidance by carefully surveying the technical literature, working with Federal and State agencies, and engaging in extensive dialogue with the public to identify the best economically achievable measures that are available to protect coastal waters from nonpoint pollution.

This "management measures" guidance addresses five source categories of nonpoint pollution: agriculture, silviculture, urban, marinas, and hydromodification. A suite of management measures is provided for each source category. In addition, we have included a chapter that provides management measures that provide other tools available to address many source categories of nonpoint pollution; these tools include the protection, restoration, and construction of wetlands, riparian areas, and vegetated treatment systems.

In addition to this "management measures" guidance, EPA and the National Oceanic and Atmospheric Administration (NOAA) have jointly published final guidance for the approval of State programs that implement management measures. That guidance explains more fully how the management measures guidance will be implemented in State programs.

We at EPA strongly believe that, working together, the States, EPA, NOAA, other Federal agencies, and local communities can achieve the goal of the Clean Water Act to make our waters fishable and swimmable. We hope that the enclosed guidance will help us all achieve our common goal.

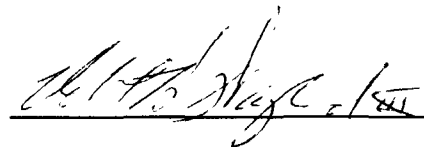

Robert H. Wayland III, Director
Office of Wetlands, Oceans, and
Watersheds

CONTENTS

Page

Chapter 1. Introduction	1-1
I. Background	1-1
A. Nonpoint Source Pollution	1-1
1. What Is Nonpoint Source Pollution?	1-1
2. National Efforts to Control Nonpoint Pollution	1-1
B. Coastal Zone Management	1-2
C. Coastal Zone Act Reauthorization Amendments of 1990	1-3
1. Background and Purpose of the Amendments	1-3
2. State Coastal Nonpoint Pollution Control Programs	1-4
3. Management Measures Guidance	1-5
D. Program Implementation Guidance	1-6
II. Development of the Management Measures Guidance	1-7
A. Process Used to Develop This Guidance	1-7
B. Scope and Contents of This Guidance	1-7
1. Categories of Nonpoint Sources Addressed	1-7
2. Relationship Between This Management Measures Guidance for Coastal Nonpoint Sources and NPDES Permit Requirements for Point Sources	1-8
3. Contents of This Guidance	1-10
III. Technical Approach Taken in Developing This Guidance	1-12
A. The Nonpoint Source Pollution Process	1-12
1. Source Control	1-12
2. Delivery Reduction	1-12
B. Management Measures as Systems	1-13
C. Economic Achievability of the Proposed Management Measures	1-13
Chapter 2. Management Measures for Agriculture Sources	2-1
I. Introduction	2-1
A. What "Management Measures" Are	2-1
B. What "Management Practices" Are	2-1
C. Scope of This Chapter	2-2

1-1-11

CONTENTS (Continued)

	Page
D. Relationship of This Chapter to Other Chapters and to Other EPA Documents	2-2
E. Coordination of Measures	2-3
F. Pollutants That Cause Agricultural Nonpoint Source Pollution	2-3
1. Nutrients	2-3
2. Sediment	2-6
3. Animal Wastes	2-7
4. Salts	2-8
5. Pesticides	2-9
6. Habitat Impacts	2-10
II. Management Measures for Agricultural Sources	2-12
A. Erosion and Sediment Control Management Measure	2-12
1. Applicability	2-12
2. Description	2-12
3. Management Measure Selection	2-14
4. Effectiveness Information	2-14
5. Erosion and Sediment Control Management Practices	2-16
6. Cost Information	2-27
B1. Management Measure for Facility Wastewater and Runoff from Confined Animal Facility Management (Large Units)	2-33
1. Applicability	2-33
2. Description	2-34
3. Management Measure Selection	2-36
4. Effectiveness Information	2-37
5. Confined Animal Facility Management Practices	2-38
6. Cost Information	2-41
B2. Management Measure for Facility Wastewater and Runoff from Confined Animal Facility Management (Small Units)	2-43
1. Applicability	2-43
2. Description	2-44
3. Management Measure Selection	2-46
4. Effectiveness Information	2-47
5. Confined Animal Facility Management Practices	2-48
6. Cost Information	2-51
C. Nutrient Management Measure	2-52
1. Applicability	2-53
2. Description	2-53

CONTENTS (Continued)

	Page
3. Management Measure Selection	2-53
4. Effectiveness Information	2-54
5. Nutrient Management Practices	2-56
6. Cost Information	2-60
D. Pesticide Management Measure	2-61
1. Applicability	2-61
2. Description	2-61
3. Management Measure Selection	2-63
4. Effectiveness Information	2-63
5. Pesticide Management Practices	2-68
6. Cost Information	2-70
7. Relationship of Pesticide Management Measure to Other Programs	2-71
E. Grazing Management Measure	2-73
1. Applicability	2-73
2. Description	2-74
3. Management Measure Selection	2-75
4. Effectiveness Information	2-75
5. Range and Pasture Management Practices	2-78
6. Cost Information	2-83
F. Irrigation Water Management Measure	2-88
1. Applicability	2-89
2. Description	2-89
3. Management Measure Selection	2-93
4. Effectiveness Information	2-94
5. Irrigation Water Management Practices	2-94
6. Cost Information	2-104
III. Glossary	2-107
IV. References	2-114
Appendix 2A	2-121
Appendix 2B	2-151

CONTENTS (Continued)

	Page
Chapter 3. Management Measures for Forestry	3-1
I. Introduction	3-1
A. What "Management Measures" Are	3-1
B. What "Management Practices" Are	3-1
C. Scope of This Chapter	3-1
D. Relationship of This Chapter to Other Chapters and to Other EPA Documents	3-2
E. Background	3-3
1. Pollutant Types and Impacts	3-4
2. Forestry Activities Affecting Water Quality	3-5
F. Other Federal, State, and Local Silviculture Programs	3-7
1. Federal Programs	3-7
2. State Forestry NPS Programs	3-8
3. Local Governments	3-8
II. Forestry Management Measures	3-10
A. Preharvest Planning	3-10
1. Applicability	3-11
2. Description	3-11
3. Management Measure Selection	3-14
4. Practices	3-17
B. Streamside Management Areas (SMAs)	3-26
1. Applicability	3-26
2. Description	3-26
3. Management Measure Selection	3-27
4. Practices	3-31
C. Road Construction/Reconstruction	3-38
1. Applicability	3-38
2. Description	3-38
3. Management Measure Selection	3-39
4. Practices	3-46
D. Road Management	3-53
1. Applicability	3-53
2. Description	3-53

CONTENTS (Continued)

	Page
3. Management Measure Selection	3-55
4. Practices	3-55
E. Timber Harvesting	3-59
1. Applicability	3-59
2. Description	3-60
3. Management Measure Selection	3-60
4. Practices	3-64
F. Site Preparation and Forest Regeneration	3-69
1. Applicability	3-69
2. Description	3-69
3. Management Measure Selection	3-70
4. Practices	3-75
G. Fire Management	3-78
1. Applicability	3-78
2. Description	3-78
3. Management Measure Selection	3-79
4. Practices	3-80
H. Revegetation of Disturbed Areas	3-82
1. Applicability	3-82
2. Description	3-82
3. Management Measure Selection	3-83
4. Practices	3-86
I. Forest Chemical Management	3-88
1. Applicability	3-88
2. Description	3-88
3. Management Measure Selection	3-89
4. Practices	3-93
5. Relationship of Management Measure Components for Pesticides to Other Programs	3-95
J. Wetlands Forest Management	3-97
1. Applicability	3-97
2. Description	3-97
3. Management Measure Selection	3-98
4. Practices	3-99

CONTENTS (Continued)

	Page
III. Glossary	3-104
IV. References	3-109
Appendix 3A	3-121
Chapter 4. Management Measures for Urban Areas	4-1
I. Introduction	4-1
A. What "Management Measures" Are	4-1
B. What "Management Practices" Are	4-1
C. Scope of This Chapter	4-1
D. Relationship of This Chapter to Other Chapters and to Other EPA Documents	4-2
E. Overlap Between This Management Measure Guidance for Control of Coastal Nonpoint Sources and Storm Water Permit Requirements for Point Sources	4-3
1. The Storm Water Permit Program	4-3
2. Coastal Nonpoint Pollution Control Programs	4-3
3. Scope and Coverage of This Guidance	4-3
F. Background	4-4
1. Urbanization and Its Impacts	4-5
2. Nonpoint Source Pollutants and Their Impacts	4-7
3. Opportunities	4-10
II. Urban Runoff	4-12
A. New Development Management Measure	4-12
1. Applicability	4-12
2. Description	4-13
3. Management Measure Selection	4-23
4. Practices	4-24
5. Effectiveness and Cost Information	4-35
B. Watershed Protection Management Measure	4-36
1. Applicability	4-36
2. Description	4-36
3. Management Measure Selection and Effectiveness Information	4-37
4. Watershed Protection Practices and Cost Information	4-42
5. Land or Development Rights Acquisition Practices and Cost Information	4-51

CONTENTS (Continued)

	Page
C. Site Development Management Measure	4-53
1. Applicability	4-53
2. Description	4-53
3. Management Measure Selection	4-55
4. Practices and Cost Information for Control of Erosion During Site Development	4-55
5. Site Planning Practices	4-60
III. Construction Activities	4-63
A. Construction Site Erosion and Sediment Control Management Measure	4-63
1. Applicability	4-63
2. Description	4-63
3. Management Measure Selection	4-66
4. Erosion Control Practices	4-66
5. Sediment Control Practices	4-72
6. Effectiveness and Cost Information	4-73
B. Construction Site Chemical Control Management Measure	4-83
1. Applicability	4-83
2. Description	4-83
3. Management Measure Selection	4-85
4. Practices	4-85
IV. Existing Development	4-88
A. Existing Development Management Measure	4-88
1. Applicability	4-88
2. Description	4-88
3. Management Measure Selection	4-90
4. Practices	4-90
5. Effectiveness Information and Cost Information	4-94
V. Onsite Disposal Systems	4-97
A. New Onsite Disposal System Management Measures	4-97
1. Applicability	4-97
2. Description	4-98
3. Management Measure Selection	4-98
4. Practices	4-99
5. Effectiveness Information and Cost Information	4-110

CONTENTS (Continued)

	Page
B. Operating Onsite Disposal Systems Management Measure	4-112
1. Applicability	4-112
2. Description	4-112
3. Management Measure Selection	4-114
4. Practices	4-114
VI. Pollution Prevention	4-119
A. Pollution Prevention Management Measure	4-119
1. Applicability	4-119
2. Description	4-119
3. Management Measure Selection	4-125
4. Practices, Effectiveness Information, and Cost Information	4-125
VII. Roads, Highways, and Bridges	4-136
A. Management Measure for Planning, Siting and Developing Roads and Highways	4-136
1. Applicability	4-136
2. Description	4-136
3. Management Measure Selection	4-137
4. Practices	4-137
5. Effectiveness Information and Cost Information	4-139
B. Management Measure for Bridges	4-140
1. Applicability	4-140
2. Description	4-140
3. Management Measure Selection	4-140
4. Practices	4-141
5. Effectiveness Information and Cost Information	4-141
C. Management Measure for Construction Projects	4-142
1. Applicability	4-142
2. Description	4-142
3. Management Measure Selection	4-143
4. Practices	4-143
5. Effectiveness Information and Cost Information	4-145
D. Management Measure for Construction Site Chemical Control	4-146
1. Applicability	4-146
2. Description	4-146

CONTENTS (Continued)

	Page
3. Management Measure Selection	4-146
4. Practices	4-147
5. Effectiveness Information and Cost Information	4-147
E. Management Measure for Operation and Maintenance	4-148
1. Applicability	4-148
2. Description	4-148
3. Management Measure Selection	4-148
4. Practices	4-149
5. Effectiveness Information and Cost Information	4-150
F. Management Measure for Road, Highway, and Bridge Runoff Systems	4-154
1. Applicability	4-154
2. Description	4-154
3. Management Measure Selection	4-155
4. Practices	4-155
5. Effectiveness Information and Cost Information	4-155
6. Pollutants of Concern	4-156
VIII. Glossary	4-158
IX. References	4-161
Chapter 5. Management Measures for Marinas and Recreational Boating	5-1
I. Introduction	5-1
A. What "Management Measures" Are	5-1
B. What "Management Practices" Are	5-1
C. Scope of This Chapter	5-1
D. Relationship of This Chapter to Other Chapters and to Other EPA Documents	5-2
E. Problem Statement	5-2
F. Pollutant Types and Impacts	5-3
1. Toxicity in the Water Column	5-3
2. Increased Pollutant Levels in Aquatic Organisms	5-4
3. Increased Pollutant Levels in Sediments	5-4
4. Increased Levels of Pathogen Indicators	5-6
5. Disruption of Sediment and Habitat	5-6
6. Shoaling and Shoreline Erosion	5-6

CONTENTS (Continued)

	Page
G. Other Federal and State Marina and Boating Programs	5-7
1. NPDES Storm Water Program	5-7
2. Other Regulatory Programs	5-8
H. Applicability of Management Measures	5-8
II. Siting and Design	5-10
A. Marina Flushing Management Measure	5-11
1. Applicability	5-11
2. Description	5-11
3. Management Measure Selection	5-12
4. Practices	5-12
B. Water Quality Assessment Management Measure	5-16
1. Applicability	5-16
2. Description	5-16
3. Management Measure Selection	5-17
4. Practices	5-17
C. Habitat Assessment Management Measure	5-21
1. Applicability	5-21
2. Description	5-21
3. Management Measure Selection	5-21
4. Practices	5-22
D. Shoreline Stabilization Management Measure	5-26
1. Applicability	5-26
2. Description	5-26
3. Management Measure Selection	5-27
4. Practices	5-27
E. Storm Water Runoff Management Measure	5-28
1. Applicability	5-28
2. Description	5-28
3. Management Measure Selection	5-29
4. Practices	5-29

CONTENTS (Continued)

	Page
F. Fueling Station Design Management Measure	5-40
1. Applicability	5-40
2. Description	5-40
3. Management Measure Selection	5-40
4. Practices	5-40
G. Sewage Facility Management Measure	5-42
1. Applicability	5-42
2. Description	5-42
3. Management Measure Selection	5-43
4. Practices	5-43
III. Marina and Boat Operation and Maintenance	5-46
A. Solid Waste Management Measure	5-47
1. Applicability	5-47
2. Description	5-47
3. Management Measure Selection	5-47
4. Practices	5-47
B. Fish Waste Management Measure	5-49
1. Applicability	5-49
2. Description	5-49
3. Management Measure Selection	5-49
4. Practices	5-49
C. Liquid Material Management Measure	5-51
1. Applicability	5-51
2. Description	5-51
3. Management Measure Selection	5-51
4. Practices	5-51
D. Petroleum Control Management Measure	5-53
1. Applicability	5-53
2. Description	5-53
3. Management Measure Selection	5-53
4. Practices	5-53

CONTENTS (Continued)

	Page
E. Boat Cleaning Management Measure	5-55
1. Applicability	5-55
2. Description	5-55
3. Management Measure Selection	5-55
4. Practices	5-55
F. Public Education Management Measure	5-57
1. Applicability	5-57
2. Description	5-57
3. Management Measure Selection	5-57
4. Practices	5-57
G. Maintenance of Sewage Facilities Management Measure	5-60
1. Applicability	5-60
2. Description	5-60
3. Management Measure Selection	5-60
4. Practices	5-60
H. Boat Operation Management Measure	5-62
1. Applicability	5-62
2. Description	5-62
3. Management Measure Selection	5-62
4. Practices	5-62
IV. Glossary	5-64
V. References	5-66
Appendix 5A	5-75
Chapter 6. Management Measures for Hydromodification: Channelization and Channel Modification, Dams, and Steambank and Shoreline Erosion	6-1
I. Introduction	6-1
A. What "Management Measures" Are	6-1
B. What "Management Practices" Are	6-1
C. Scope of This Chapter	6-2
D. Relationship of This Chapter to Other Chapters and to Other EPA Documents	6-2

CONTENTS (Continued)

	Page
II. Channelization and Channel Modification Management Measures	6-3
A. Management Measure for Physical and Chemical Characteristics of Surface Waters	6-8
1. Applicability	6-8
2. Description	6-8
3. Management Measure Selection	6-9
4. Practices	6-10
5. Costs for Modeling Practices	6-17
B. Instream and Riparian Habitat Restoration Management Measure	6-19
1. Applicability	6-19
2. Description	6-19
3. Management Measure Selection	6-20
4. Practices	6-20
III. Dams Management Measures	6-24
A. Management Measure for Erosion and Sediment Control	6-28
1. Applicability	6-28
2. Description	6-28
3. Management Measure Selection	6-29
4. Practices	6-29
5. Effectiveness for All Practices	6-30
6. Costs for All Practices	6-31
B. Management Measure for Chemical and Pollutant Control	6-32
1. Applicability	6-32
2. Description	6-32
3. Management Measure Selection	6-33
4. Practices	6-33
C. Management Measure for Protection of Surface Water Quality and Instream and Riparian Habitat	6-35
1. Applicability	6-35
2. Description	6-35
3. Management Measure Selection	6-37
4. Introduction to Practices	6-38
5. Practices for Aeration of Reservoir Waters and Releases	6-38
6. Practices to Improve Oxygen Levels in Tailwaters	6-41

CONTENTS (Continued)

	Page
7. Practices for Adjustments in the Operational Procedures of Dams for Improvements of Water Quality	6-44
8. Watershed Protection Practices	6-46
9. Practices to Restore or Maintain Aquatic and Riparian Habitat	6-47
10. Practices to Maintain Fish Passage	6-50
11. Costs for All Practices	6-55
IV. Streambank and Shoreline Erosion Management Measure	6-57
A. Management Measure for Eroding Streambanks and Shorelines	6-59
1. Applicability	6-59
2. Description	6-59
3. Management Measure Selection	6-60
4. Practices	6-60
5. Costs for All Practices	6-82
V. Glossary	6-85
VI. References	6-96
A. Channelization and Channel Modification	6-96
B. Dams	6-99
C. Streambank and Shoreline Erosion	6-105
Chapter 7. Management Measures for Wetlands, Riparian Areas, and Vegetated Treatment Systems	7-1
I. Introduction	7-1
A. What "Management Measures" Are	7-1
B. What "Management Practices" Are	7-1
C. Scope of This Chapter	7-2
D. Relationship of This Chapter to Other Chapters and to Other EPA Documents	7-3
E. Definitions and Background Information	7-3
1. Wetlands and Riparian Areas	7-4
2. Vegetated Buffers	7-6
3. Vegetated Treatment Systems	7-6
II. Management Measures	7-8
A. Management Measure for Protection of Wetlands and Riparian Areas	7-8
1. Applicability	7-8
2. Description	7-8

CONTENTS (Continued)

	Page
3. Management Measure Selection	7-9
4. Practices	7-18
5. Costs for All Practices	7-28
B. Management Measure for Restoration of Wetlands and Riparian Areas	7-33
1. Applicability	7-33
2. Description	7-33
3. Management Measure Selection	7-33
4. Practices	7-34
5. Costs for All Practices	7-43
C. Management Measure for Vegetated Treatment Systems	7-47
1. Applicability	7-47
2. Description	7-47
3. Management Measure Selection	7-48
4. Practices	7-50
5. Costs for All Practices	7-54
III. Glossary	7-57
IV. References	7-59
Chapter 8. Monitoring and Tracking Techniques to Accompany Management Measures	8-1
I. Introduction	8-1
II. Techniques for Assessing Water Quality and for Estimating Pollution Loads	8-3
A. Nature and Scope of Nonpoint Source Problems	8-3
B. Monitoring Objectives	8-3
1. Section 6217 Objectives	8-4
2. Formulating Monitoring Objectives	8-4
C. Monitoring Approaches	8-4
1. General	8-4
2. Understanding the System to Be Monitored	8-6
3. Experimental Design	8-10
4. Site Locations	8-12
5. Sampling Frequency and Interval	8-13
6. Load Versus Water Quality Status Monitoring	8-15
7. Parameter Selection	8-16

CONTENTS (Continued)

	Page
8. Sampling Techniques	8-17
9. Quality Assurance and Quality Control	8-20
D. Data Needs	8-21
E. Statistical Considerations	8-21
1. Variability and Uncertainty	8-21
2. Samples and Sampling	8-22
3. Estimation and Hypothesis Testing	8-26
F. Data Analysis	8-27
III. Techniques and Procedures for Assessing Implementation, Operation, and Maintenance of Management Measures	8-32
A. Overview	8-32
B. Techniques	8-32
1. Implementation	8-32
2. Operation and Maintenance	8-33
IV. References	8-61

FIGURES

Number		Page
2-1	Pathways through which substances are transported from agricultural land to become water pollutants	2-4
2-2	Sediment detachment and transport	2-7
2-3	Diversion	2-22
2-4	Strip-cropping and rotations	2-25
2-5	Gradient terraces with tile outlets	2-26
2-6	Gradient terraces with waterway outlet	2-26
2-7	Management Measure for Facility Wastewater and Runoff from Confined Animal Facilities (large units)	2-35
2-8	Example of manure and runoff storage system	2-35
2-9	Management Measure for Facility Wastewater and Runoff from Confined Animal Facilities (small units)	2-45
2-10	Typical barnyard runoff management system	2-46
2-11	Example of soil test report	2-57
2-12	Example of Penn State's quicktest form	2-58
2-13	Example of work sheet for applying manure to cropland	2-59
2-14	Factors affecting the transport and water quality impact of a pesticide	2-62
2-15	Source and fate of water added to a soil system	2-89
2-16	Variables influencing pollutant losses from irrigated fields	2-90
2-17	Diagram of a tensiometer	2-91
2-18	Schematic of an electrical resistance block and meter	2-91
2-19	Corn daily water use as influenced by stage of development	2-92
2-20	Basic components of a trickle irrigation system	2-99
2-21	Methods of distribution of irrigation water from (a) low-pressure underground pipe, (b) multiple-outlet risers, and (c) portable gated pipe	2-100
2-22	Backflow prevention device using check valve with vacuum relief and low pressure drain	2-104
3-1	Conceptual model of forest biogeochemistry, hydrology and stormflow	3-5
3-2	Comparison of forest land areas and mass erosion under various land uses	3-6
3-3	How to select the best road layout	3-20
3-4	Typical side-hill cross section illustrating how cut material, A, equals fill material, B	3-21
3-5	Alternative water crossing structures	3-23
3-6	Culvert conditions that block fish passage	3-23
3-7	Multiple culverts for fish passage in streams that have wide ranges of flows	3-23
3-8	Soil loss rates for roadbeds with five surfacing treatments	3-24
3-9	SMA pollutant removal processes	3-27
3-10	Florida's streamside management zone widths as defined by the Site Sensitivity Classification	3-33
3-11	Guide for calculating the average width of the RMZ	3-35
3-12	Washington State Forest Practices Board (1988) requirements for leave trees in the RMZ	3-36
3-13	Uniform harvesting in the riparian zone	3-37
3-14	Vegetative shading along a stream course	3-37
3-15	Illustration of road structure terms	3-39

FIGURES (Continued)

Number		Page
3-16	Mitigation techniques used for controlling erosion and sediment to protect water quality and fish habitat	3-40
3-17	Diagram of broad-based dip design for forest access roads	3-47
3-18	Design of pole culverts	3-48
3-19	Design and installation of pipe culverts	3-48
3-20	Brush barrier at toe of fill	3-49
3-21	Dimensions of typical rock riprap blanket	3-50
3-22	Culvert installation in streambed	3-51
3-23	Culvert installation using a diversion	3-52
3-24	Road maintenance examples	3-54
3-25	Hypothetical skid trail pattern for uphill and downhill logging	3-67
3-26	Relation of soil loss to good ground cover	3-83
3-27	Soil losses from a 35-foot long slope by mulch type	3-87
3-28	Impervious roadfill section placed on wetlands consisting of soft organic sediments with sand lenses	3-100
3-29	Pervious roadfill section on wetland allows movement of ground water through it and minimizes flow changes	3-100
3-30	Cross-section of a wetland road	3-100
4-1	Changes in runoff flow resulting from increased impervious area	4-6
4-2	Changes in stream hydrology as a result of urbanization	4-7
4-3	Removal efficiencies of selected urban runoff controls for TSS	4-35
4-4	Predicted total nitrogen and phosphorus loadings in surface water runoff from the Rhode River Critical Area under different land use scenarios	4-39
4-5	Water velocity reductions for different mulch treatments	4-70
4-6	Actual soil loss reductions for different mulch treatments	4-71
4-7	TSS concentrations from Maryland construction sites	4-81
4-8	Comparison of cost and effectiveness for erosion control practices	4-82
5-1	Example marina designs	5-13
5-2	Conceptual design of a sand filter system	5-32
5-3	Schematic design of an enhanced wet pond system	5-33
5-4	Schematic design of a conventional infiltration trench	5-34
5-5	Schematic design of an infiltration basin	5-34
5-6	Schematic design of a porous pavement system	5-37
5-7	Schematic design of a water quality inlet/oil grit separator	5-38
5-8	Examples of pumpout devices	5-44
5-9	Example signage advertising pumpout availability	5-45
6-1	A cross-sectional view of a thermally stratified reservoir in mid-summer	6-26
6-2	Influence of photosynthesis and respiration-decomposition processes and organic matter sedimentation on the distribution of nutrients and organic matter in a stratified reservoir	6-27
6-3	Air injection system for reservoir aeration-destratification	6-39
6-4	Compressed air diffusion system for reservoir aeration-destratification	6-40
6-5	Autoventing turbine and hub baffle system used in the autoventing turbines at Norris Dam (French Broad River), Tennessee	6-42

FIGURES (Continued)

Number		Page
6-6	Cross-section of a spillway with a "flip-lip" deflector	6-44
6-7	Three-bay labyrinth weir	6-45
6-8	Trap and haul system for fish by-pass of the Foster Dam, Oregon	6-53
6-9	Cross-section of a turbine bypass system used at Lower Granite and Little Goose Dams, Washington	6-54
6-10	The physical processes of bluff erosion in a coastal bay	6-58
6-11	Schematic cross section of a live stake installation showing important design elements	6-61
6-12	Schematic cross section of a live fascine showing important design elements	6-62
6-13	Schematic cross section of a branchpacking system showing important design elements	6-63
6-14	Schematic cross section of a joint planting system showing important design elements	6-64
6-15	Schematic cross section of a live cribwall showing important design elements	6-65
6-16	Continuous stone sill protecting a planted marsh	6-66
6-17	Headland breakwater system at Drummonds Field, Virginia	6-67
6-18	Vegetative stabilization site evaluation form	6-68
6-19	Schematic cross section of a timber bulkhead showing important design elements	6-73
6-20	Schematic cross section of a stone revetment showing important design elements	6-74
6-21	Schematic cross section of toe protection for a timber bulkhead showing important design elements	6-76
6-22	Example of return walls to prevent flanking in a bulkhead	6-77
6-23	Wakes from two different types of boat hulls	6-80
7-1	Cross section showing the general relationship between wetlands, uplands, riparian areas, and a stream channel	7-5
7-2	Schematic of vegetated treatment system, including a vegetated filter strip and constructed wetland	7-55
8-1	Factors contributing to lateral differences in lake quality	8-8
8-2	Scatter plot of nitrate concentration versus depth below water table	8-28
8-3	Paired regression lines of pre-BMP and post-BMP total phosphorus loads, LaPlatte River, Vermont	8-29
8-4	Results of analysis of clustered pre-BMP and post-BMP data from Conestoga Headwaters, Pennsylvania	8-30
8-5	Summary of fecal coliform at the beach on St. Albans Bay, Vermont	8-31
8-6	Trends in St. Albans Bay water quality, 1981-1990	8-31

TABLES

Number		Page
2-1	Relative Gross Effectiveness of Sediment Control Measures	2-15
2-2	Effects of Conservation Practices on Water Resource Parameters	2-17
2-3	Cost of Diversions	2-27
2-4	Cost of Terraces	2-28
2-5	Cost of Waterways	2-29
2-6	Cost of Permanent Vegetative Cover	2-30
2-7	Cost of Conservation Tillage	2-31
2-8	Annualized Cost Estimates for Selected Management Practices from Chesapeake Bay Installations	2-32
2-9	Relative Gross Effectiveness of Confined Livestock Control Measures	2-37
2-10	Effectiveness of Runoff Control Systems	2-38
2-11	Costs for Runoff Control Systems	2-42
2-12	Concentrated Reductions in Barnyard and Feedlot Runoff Treated with Solids Separation	2-47
2-13	Nutrient Reductions Achieved Under USDA's Water Quality Program	2-55
2-14	Relative Effectiveness of Nutrient Management	2-55
2-15	Results of IPM Evaluation Studies	2-64
2-16	Estimates of Potential Reductions in Field Losses of Pesticides for Cotton Compared to a Conventionally and/or Traditionally Cropped Field	2-66
2-17	Estimates of Potential Reductions in Field Losses of Pesticides for Corn Compared to a Conventionally and/or Traditionally Cropped Field	2-67
2-18	Estimated Scouting Costs by Coastal Region and Crop in the Coastal Zone in 1992	2-71
2-19	Grazing Management Influences on Two Brook Trout Streams in Wyoming	2-76
2-20	Streambank Characteristics for Grazed Versus Rested Riparian Areas	2-76
2-21	The Effects of Supplemental Feeding Location on Riparian Area Vegetation	2-77
2-22	Bacterial Water Quality Response to Four Grazing Strategies	2-77
2-23	Nitrogen Losses from Medium-Fertility, 12-Month Pasture Program	2-78
2-24	Cost of Water Development for Grazing Management	2-84
2-25	Cost of Livestock Exclusion for Grazing Management	2-85
2-26	Cost of Forage Improvement/Reestablishment for Grazing Management	2-85
2-27	Summary of ACP Grazing Management Practice Costs, 1989 and 1990	2-86
2-28	Summary of Pollutant Impacts of Selected Irrigation Practices	2-95
2-29	Sediment Removal Efficiencies and Comments on BMPs Evaluated	2-96
2-30	Expected Irrigation Efficiencies of Selected Irrigation Systems in California	2-97
2-31	Irrigation Efficiencies of Selected Irrigation Systems for Cotton	2-97
2-32	Cost of Soil Water Measuring Devices	2-105
2-33	Design Lifetime for Selected Salt Load Reduction Measures	2-106
3-1	State programs by region and frequency	3-9
3-2	Clearcutting Versus Selected Harvesting Methods	3-14
3-3	Effect of Four Harvesting and Road Design Methods on Water Quality	3-15
3-4	Comparison of the Effect of Conventional Logging System and Cable Miniyarder on Soil	3-16
3-5	The Relationship Between Slope Gradient and Annual Sediment Loss on an Established Forest Road	3-16

TABLES (Continued)

Number		Page
3-6	The Effect of Skid Road Grade and Length on Road Surface Erosion	3-17
3-7	Costs and Benefits of Proper Road Design (With Water Quality Considerations) Versus Reconstruction (Without Water Quality Considerations)	3-17
3-8	Characteristics and Road Location Costs of Four "Minimum-Standard" Forest Truck Roads Constructed in the Central Appalachians	3-18
3-9	Stable Back Slope and Fill Slope Angles for Different Soil Materials	3-21
3-10	Comparison of Effects of Two Methods of Harvesting on Water Quality	3-28
3-11	Water Quality Effects from Two Types of Logging Operations in the Aalsea Watershed	3-28
3-12	Summary of Major Physical Changes Within Streamside Treatment Areas	3-29
3-13	Storm Water Suspended Sediment Delivery for Different Treatments	3-29
3-14	Average Changes in Total Coarse and Fine Debris of a Stream Channel After Harvesting	3-30
3-15	Average Estimated Logging and Stream Protection Costs per MBF	3-30
3-16	Cost Estimates (and Cost as a Percent of Gross Revenues) for Streamside Management Areas	3-31
3-17	Cost Impacts of Three Alternative Buffer Strips: Case Study Results with 640-Acre Base	3-32
3-18	Recommended Minimum SMZ Widths	3-34
3-19	Recommendations for Filter Strip Widths	3-34
3-20	Stand Stocking in the Primary SMZ	3-36
3-21	Effects of Several Road Construction Treatments on Sediment Yield	3-41
3-22	Effectiveness of Road Surface Treatments in Controlling Soil Losses	3-42
3-23	Reduction in the Number of Sediment Deposits More Than 20 Feet Long by Grass and Forest Debris	3-43
3-24	Comparison of Downslope Movement of Sediment from Roads for Various Roadway and Slope Conditions	3-43
3-25	Effectiveness of Surface Erosion Control on Forest Roads	3-44
3-26	Cost Summary for Four "Minimum-Standard" Forest Truck Roads Constructed in the Central Appalachians	3-45
3-27	Unit Cost Data for Culverts	3-45
3-28	Cost Estimates (and Cost as a Percent of Gross Revenues) for Road Construction	3-45
3-29	Cost of Gravel and Grass Road Surfaces	3-46
3-30	Costs of Erosion Control Measures	3-46
3-31	Comparison of Road Repair Costs for a 20-Year Period With and Without BMPs	3-56
3-32	Analysis of Costs and Benefits of Watershed Treatments Associated with Roads	3-56
3-33	Comparative Costs of Reclamation of Roads and Removal of Stream Crossing Structures	3-57
3-34	Water Bar Spacing by Soil Type and Slope	3-58
3-35	Soil Disturbance from Roads for Alternative Methods of Timber Harvesting	3-61
3-36	Soil Disturbance from Logging by Alternative Harvesting Methods	3-62
3-37	Relative Impacts of Four Yarding Methods on Soil Disturbance and Compaction in Pacific Northwest Clearcuts	3-63
3-38	Percent of Land Area Affected by Logging Operations	3-63
3-39	Skidding/Yarding Method Comparison	3-63
3-40	Analysis of Costs and Benefits of Skid Trail Rehabilitation in the Management of Three Southern Timber Types in the Southeast	3-64

TABLES (Continued)

Number		Page
3-41	General Large Woody Debris Stability Guide Based on Salmon Creek, Washington	3-65
3-42	Deposited, Suspended, and Total Sediment Losses and Percentage of Exposed Soil in the Experimental Watersheds During Water Years 1976 and 1977 for Various Site Preparation Techniques	3-71
3-43	Predicted Erosion Rates Using Various Site Preparation Techniques for <i>Physiographic Regions in the Southeastern United States</i>	3-71
3-44	Erosion Rates for Site Preparation Practices in Selected Land Resource Areas in the Southeast	3-72
3-45	Effectiveness of Chemical and Mechanical Site Preparation in Controlling Water Flows and Sediment Losses	3-72
3-46	Sediment Loss (kg/ha) in Stormflow by Site Treatment from January 1 to August 31, 1981	3-73
3-47	Nutrient Loss (kg/ha) in Stormflow by Site Treatment from January 1 to August 31, 1981	3-73
3-48	Analysis of Two Management Schedules Comparing Cost and Site Productivity in the Southeast	3-74
3-49	Site Preparation Comparison	3-74
3-50	Comparison of Costs for Yarding Unmerchantable Material (YUM) vs. Broadcast Burning	3-75
3-51	Estimated Costs for Site Preparation	3-76
3-52	Estimated Costs for Regeneration	3-76
3-53	Cost-Share Information for Revegetation/Tree Planting	3-76
3-54	Comparison of the Effectiveness of Seed, Fertilizer, Mulch, and Netting in Controlling Cumulative Erosion from Treated Plots on a Steep Road Fill in Idaho	3-84
3-55	Costs of Erosion Control Measures	3-85
3-56	Economic Impact of Implementation of Proposed Management Measures on Road Construction and Maintenance	3-85
3-57	Cost Estimates (and Cost as a Percent of Gross Revenues) for Seed, Fertilizer, and Mulch	3-85
3-58	Estimated Costs for Revegetation	3-85
3-59	Concentrations of 2,4-D After Aerial Application in Two Treatment Areas	3-90
3-60	Peak Concentrations in Streamflow from Herbicide Application Methods	3-90
3-61	Peak Concentrations of Forest Chemicals in Soils, Lakes, and Streams After Application	3-91
3-62	Nitrogen Losses from Two Watersheds in Umpqua Experimental Watershed	3-93
3-63	Total Nitrogen and Phosphorus Concentrations in Soil Water and Sedimentation During Wet Season Flooding	3-99
3-64	Recommended Harvesting Systems by Forested Wetland Site	3-102
3-65	Recommended Regeneration Systems by Forested Wetland Type	3-103
4-1	Estimated Mean Concentrations for Land Uses, Based on Nationwide Urban Runoff Program	4-7
4-2	Sources of Urban Runoff Pollutants	4-8
4-3	Percent of Limited or Restricted Classified Shellfish Waters Affected by Types of Pollution	4-9
4-4	Example Effects of Increased Urbanization on Runoff Volumes	4-14
4-5	Advantages and Disadvantages of Management Practices	4-15

TABLES (Continued)

Number		Page
4-6	Regional, Site-Specific, and Maintenance Considerations for Structural Practices to Control Sediments in Stormwater Runoff	4-21
4-7	Effectiveness of Management Practices for Control of Runoff from Newly Developed Areas	4-25
4-8	Cost of Management Practices for Control of Runoff from Newly Developed Areas	4-29
4-9	Load Estimates for Six Land Uses in Alameda County, California	4-38
4-10	General Effectiveness of Various Nonstructural Control Practices	4-40
4-11	Watershed Management: A Step-by-Step Guide	4-43
4-12	Items to Consider in Developing an Erosion and Sediment Control Plan	4-56
4-13	State and Local Construction Site Erosion and Sediment Control Plan Requirements	4-58
4-14	Erosion and Sediment Problems Associated With Construction	4-64
4-15	ESC Quantitative Effectiveness and Cost Summary	4-75
4-16	ESC Quantitative Effectiveness and Cost Summary for Sediment Control Practices	4-78
4-17	Existing Development Management Practices Effectiveness Summary	4-91
4-18	States That Have Adopted Low-flow Plumbing Fixture Regulations	4-100
4-19	Daily Water Use and Pollutant Loadings by Source	4-100
4-20	Example Onsite Sewage Disposal System Siting Requirements	4-102
4-21	OSDS Effectiveness and Cost Summary	4-104
4-22	Reduction in Pollutant Loading by Elimination of Garbage Disposals	4-111
4-23	Phosphate Limits in Detergents	4-115
4-24	Suggested Septic Tank Pumping Frequency	4-117
4-25	Estimates of Improperly Disposed Used Oil and Household Hazardous Waste	4-120
4-26	Summary of Application Rates of Fertilizers from Various Studies	4-121
4-27	Recommended Fertilizer Application Rates	4-122
4-28	Watershed Chemical Control Standards	4-123
4-29	Waste Recycling Cost and Effectiveness Summary	4-127
4-30	Effectiveness and Cost Summary for Roads, Highways, and Bridges Operation and Maintenance Management Practices	4-153
4-31	Highway Runoff Constituents and Their Primary Sources	4-156
4-32	Pollutant Concentrations in Highway Runoff	4-157
4-33	Potential Environmental Impacts of Road Salts	4-157
5-1	Boatyard Pressure-washing Wastewater Contaminants and Regulatory Limits in the Puget Sound Area	5-5
5-2	Cost Summary of Selected Marina Siting Practices	5-20
5-3	Stormwater Management Practice Summary Information	5-30
5-4	Annual Per Slip Pumpout Costs for Three Collection Systems	5-45
5-5	Approximate Costs for Educational and Promotional Material	5-58
6-1	Models Applicable to Hydromodification Activities	6-12
6-2	Approximate Levels of Effort for Hydrodynamic and Surface Water Quality Modeling	6-13
6-3	Costs of Models for Various Applications	6-18

TABLES (Continued)

Number		Page
6-4	Sources for Proper Design of Shoreline and Streambank Erosion Control Structures	6-69
6-5	Froude Number for Combinations of Water Depth and Boat Speed	6-79
6-6	Examples of State Programs Defining Minimum Setbacks	6-81
7-1	Effectiveness of Wetlands and Riparian Areas for NPS Pollution Control	7-10
7-2	Range of Functions of Wetlands and Riparian Areas	7-19
7-3	Federal, State, and Federal/State Programs for Wetlands Identification, Technical Study, or Management of Wetlands Protection Efforts	7-21
7-4	Federal Programs Involved in the Protection and Restoration of Wetlands and Riparian Areas on Private Lands	7-25
7-5	Total Costs for Wetlands Assessment Project Examples	7-30
7-6	Costs for Wetlands Protection Programs	7-31
7-7	Review of Wetland Restoration Projects	7-36
7-8	Construction Cost Index	7-44
7-9	Effectiveness of Vegetated Filter Strips for Pollutant Removal	7-49
7-10	Effectiveness of Constructed Wetlands for Surface Water Runoff Treatment	7-50
8-1	Examples of Monitoring Parameters to Assess Impacts from Selected Sources	8-17
8-2	Applications of Six Probability Sampling Designs to Estimate Means and Totals	8-27
8-3	Typical Operation and Maintenance Procedures for Agricultural Management Measures	8-34
8-4	Typical Operation and Maintenance Procedures for Forestry Management Measures	8-40
8-5	Typical Operation and Maintenance for Urban Management Measures	8-45
8-6	Typical Operation and Maintenance Procedures for Marinas and Recreational Boating Management Measures	8-51
8-7	Typical Operation and Maintenance Procedures for Hydromodification Management Measures	8-54
8-8	Typical Operation and Maintenance Procedures for Management Measures for Dams	8-55
8-9	Typical Operation and Maintenance Procedures for Shoreline Erosion Management Measures	8-58
8-10	Typical Operation and Maintenance Procedures for Management Measure for Protection of Existing Wetlands and Riparian Areas	8-59
8-11	Typical Operation and Maintenance Procedures for Management Measure for Restoration of Wetlands and Riparian Areas	8-59
8-12	Typical Operation and Maintenance Procedures for Management Measure for Vegetated Treatment Systems	8-60

CHAPTER 1: Introduction

I. BACKGROUND

This guidance specifying management measures for sources of nonpoint pollution in coastal waters is required under section 6217 of the Coastal Zone Act Reauthorization Amendments of 1990 (CZARA). It provides guidance to States and Territories on the types of management measures that should be included in State and Territorial Coastal Nonpoint Pollution Control Programs. This chapter explains in detail the requirements of section 6217 and the approach used by the U.S. Environmental Protection Agency (EPA) to develop the management measures.

A. Nonpoint Source Pollution

1. What Is Nonpoint Source Pollution?

Nonpoint source pollution generally results from land runoff, precipitation, atmospheric deposition, drainage, seepage, or hydrologic modification. Technically, the term "nonpoint source" is defined to mean any source of water pollution that does not meet the legal definition of "point source" in section 502(14) of the Clean Water Act. That definition states:

The term "point source" means any discernible, confined and discrete conveyance, including but not limited to any pipe, ditch, channel, tunnel, conduit, well, discrete fissure, container, rolling stock, concentrated animal feeding operation, or vessel or other floating craft, from which pollutants are or may be discharged. This term does not include agricultural storm water discharges and return flows from irrigated agriculture.

Although diffuse runoff is generally treated as nonpoint source pollution, runoff that enters and is discharged from conveyances such as those described above is treated as a point source discharge and hence is subject to the permit requirements of the Clean Water Act. In contrast, nonpoint sources are not subject to Federal permit requirements. The distinction between nonpoint sources and diffuse point sources is sometimes unclear. Therefore, at several points in this document, EPA provides detailed discussions to help the reader discern whether a particular source is a point source or a nonpoint source. Refer to Chapter 2, Section II.B.1 (discussing applicability of management measures to confined animal facility management); Chapter 4, Section I.E (discussing overlaps between this program and the storm water permit program for point sources); and Chapter 5, Section I.G (discussing overlaps between this program and several other programs, including the point source permit program).

Nonpoint pollution is the pollution of our nation's waters caused by rainfall or snowmelt moving over and through the ground. As the runoff moves, it picks up and carries away natural pollutants and pollutants resulting from human activity, finally depositing them into lakes, rivers, wetlands, coastal waters, and ground waters. In addition, hydrologic modification is a form of nonpoint source pollution that often adversely affects the biological and physical integrity of surface waters. A more detailed discussion of the range of nonpoint sources and their effects on water quality and riparian habitats is provided in subsequent chapters of this guidance.

2. National Efforts to Control Nonpoint Pollution

a. Nonpoint Source Program

During the first 15 years of the national program to abate and control water pollution, EPA and the States have focused most of their water pollution control activities on traditional "point sources," such as discharges through pipes from sewage treatment plants and industrial facilities. These point sources have been regulated by EPA and the States through the National Pollutant Discharge Elimination System (NPDES) permit program established by

section 402 of the Clean Water Act. Discharges of dredged and fill materials into wetlands have also been regulated by the U.S. Army Corps of Engineers and EPA under section 404 of the Clean Water Act.

As a result of the above activities, the Nation has greatly reduced pollutant loads from point source discharges and has made considerable progress in restoring and maintaining water quality. However, the gains in controlling point sources have not solved all of the Nation's water quality problems. Recent studies and surveys by EPA and by State water quality agencies indicate that the majority of the remaining water quality impairments in our nation's rivers, streams, lakes, estuaries, coastal waters, and wetlands result from nonpoint source pollution and other nontraditional sources, such as urban storm water discharges and combined sewer overflows.

In 1987, in view of the progress achieved in controlling point sources and the growing national awareness of the increasingly dominant influence of nonpoint source pollution on water quality, Congress amended the Clean Water Act to focus greater national efforts on nonpoint sources. In the Water Quality Act of 1987, Congress amended section 101, "Declaration of Goals and Policy," to add the following fundamental principle:

It is the national policy that programs for the control of nonpoint sources of pollution be developed and implemented in an expeditious manner so as to enable the goals of this Act to be met through the control of both point and nonpoint sources of pollution.

More importantly, Congress enacted section 319 of the Clean Water Act, which established a national program to control nonpoint sources of water pollution. Under section 319, States address nonpoint pollution by assessing nonpoint source pollution problems and causes within the State, adopting management programs to control the nonpoint source pollution, and implementing the management programs. Section 319 authorizes EPA to issue grants to States to assist them in implementing those management programs or portions of management programs which have been approved by EPA.

b. National Estuary Program

EPA also administers the National Estuary Program under section 320 of the Clean Water Act. This program focuses on point and nonpoint pollution in geographically targeted, high-priority estuarine waters. In this program, EPA assists State, regional, and local governments in developing comprehensive conservation and management plans that recommend priority corrective actions to restore estuarine water quality, fish populations, and other designated uses of the waters.

c. Pesticides Program

Another program administered by EPA that controls some forms of nonpoint pollution is the pesticides program under the Federal Insecticide, Fungicide, and Rodenticide Act (FIFRA). Among other provisions, this program authorizes EPA to control pesticides that may threaten ground water and surface water. FIFRA provides for the registration of pesticides and enforceable label requirements, which may include maximum rates of application, restrictions on use practices, and classification of pesticides as "restricted use" pesticides (which restricts use to certified applicators trained to handle toxic chemicals). The requirements of FIFRA, and their relationship to this guidance, are discussed more fully in Chapter 2, Section II.D, of this guidance.

B. Coastal Zone Management

The Coastal Zone Management Act of 1972 (CZMA) established a program for States and Territories to voluntarily develop comprehensive programs to protect and manage coastal resources (including the Great Lakes). To receive Federal approval and implementation funding, States and Territories had to demonstrate that they had programs, including enforceable policies, that were sufficiently comprehensive and specific both to regulate land uses, water uses, and coastal development and to resolve conflicts between competing uses. In addition, they had to have the authorities to implement the enforceable policies.

There are 29 federally approved State and Territorial programs. Despite institutional differences, each program must protect and manage important coastal resources, including wetlands, estuaries, beaches, dunes, barrier islands, coral reefs, and fish and wildlife and their habitats. Resource management and protection are accomplished in a number of ways through State laws, regulations, permits, and local plans and zoning ordinances.

While water quality protection is integral to the management of many of these coastal resources, it was not specifically cited as a purpose or policy of the original statute. The Coastal Zone Act Reauthorization Amendments of 1990, described below, specifically charged State coastal programs, as well as State nonpoint source programs, with addressing nonpoint source pollution affecting coastal water quality.

C. Coastal Zone Act Reauthorization Amendments of 1990

1. Background and Purpose of the Amendments

On November 5, 1990, Congress enacted the Coastal Zone Act Reauthorization Amendments of 1990. These Amendments were intended to address several concerns, a major one of which is the impact of nonpoint source pollution on coastal waters. In section 6202(a) of the Amendments, Congress made a set of findings, which are quoted below in pertinent part.

"1. Our oceans, coastal waters, and estuaries constitute a unique resource. The condition of the water quality in and around the coastal areas is significantly declining. Growing human pressures on the coastal ecosystem will continue to degrade this resource until adequate actions and policies are implemented.

"2. Almost one-half of our total population now lives in coastal areas. By 2010, the coastal population will have grown from 80,000,000 in 1960 to 127,000,000 people, an increase of approximately 60 percent, and population density in coastal counties will be among the highest in the Nation.

"3. Marine resources contribute to the Nation's economic stability. Commercial and recreational fishery activities support an industry with an estimated value of \$12,000,000,000 a year.

"4. Wetlands play a vital role in sustaining the coastal economy and environment. Wetlands support and nourish fishery and marine resources. They also protect the Nation's shores from storm and wave damage. Coastal wetlands contribute an estimated \$5,000,000,000 to the production of fish and shellfish in the United States coastal waters. Yet, 50 percent of the Nation's coastal wetlands have been destroyed, and more are likely to decline in the near future.

"5. Nonpoint source pollution is increasingly recognized as a significant factor in coastal water degradation. In urban areas, storm water and combined sewer overflow are linked to major coastal problems, and in rural areas, runoff from agricultural activities may add to coastal pollution.

"6. Coastal planning and development control measures are essential to protect coastal water quality, which is subject to continued ongoing stresses. Currently, not enough is being done to manage and protect coastal resources.

. . . .

"8. There is a clear link between coastal water quality and land use activities along the shore. State management programs under the Coastal Zone Management Act of 1972 (16 U.S.C. 1451 et seq.) are among the best tools for protecting coastal resources and must play a larger role, particularly in improving coastal zone water quality."

Based upon these findings, Congress declared that:

"It is the purpose of Congress in this subtitle [the Coastal Zone Act Reauthorization Amendments of 1990] to enhance the effectiveness of the Coastal Zone Management Act of 1972 by increasing our understanding of the coastal environment and expanding the ability of State coastal zone management programs to address coastal environmental problems." (Section 6202(b))

2. State Coastal Nonpoint Pollution Control Programs

To address more specifically the impacts of nonpoint source pollution on coastal water quality, Congress enacted section 6217, "Protecting Coastal Waters," which was codified as 16 U.S.C. §1455b. This section provides that each State with an approved coastal zone management program must develop and submit to EPA and the National Oceanic and Atmospheric Administration (NOAA) for approval a Coastal Nonpoint Pollution Control Program. The purpose of the program "shall be to develop and implement management measures for nonpoint source pollution to restore and protect coastal waters, working in close conjunction with other State and local authorities."

Coastal Nonpoint Pollution Control Programs are not intended to supplant existing coastal zone management programs and nonpoint source management programs. Rather, they are to serve as an update and expansion of existing nonpoint source management programs and are to be coordinated closely with the existing coastal zone management programs. The legislative history indicates that the central purpose of section 6217 is to strengthen the links between Federal and State coastal zone management and water quality programs and to enhance State and local efforts to manage land use activities that degrade coastal waters and coastal habitats. The legislative history further indicates that State coastal zone and water quality agencies are to have coequal roles, analogous to the sharing of responsibility between NOAA and EPA at the Federal level.

Section 6217(b) states that each State program must "provide for the implementation, at a minimum, of management measures in conformity with the guidance published under subsection (g) to protect coastal waters generally," and also to:

- (1) Identify land uses which, individually or cumulatively, may cause or contribute significantly to a degradation of (a) coastal waters where there is a failure to attain or maintain applicable water quality standards or protect designated uses, or (b) coastal waters that are threatened by reasonably foreseeable increases in pollution loadings from new or expanding sources;
- (2) Identify critical coastal areas adjacent to coastal waters identified under the preceding paragraph;
- (3) Implement additional management measures applicable to land uses and areas identified under paragraphs (1) and (2) above that are necessary to achieve and maintain applicable water quality standards and protect designated uses;
- (4) Provide technical assistance to local governments and the public to implement the additional management measures;
- (5) Provide opportunities for public participation in all aspects of the program;
- (6) Establish mechanisms to improve coordination among State and local agencies and officials responsible for land use programs and permitting, water quality permitting and enforcement, habitat protection, and public health and safety; and
- (7) Propose to modify State coastal zone boundaries as necessary to implement NOAA's recommendations under section 6217(e), which are based on NOAA's findings that inland boundaries must be modified to more effectively manage land and water uses to protect coastal waters.

Congress required that, within 30 months of EPA's publication of final guidance, States must develop and obtain EPA and NOAA approval of their Coastal Nonpoint Pollution Control Programs. Failure to submit an approvable program (i.e., one that meets the requirements of section 6217(b)) will result in a reduction of Federal grant dollars under the nonpoint source and coastal zone management programs. The reductions will begin in Fiscal Year 1996 (FY 1996) as a 10 percent cut, increasing to 15 percent in FY 1997, 20 percent in FY 1998, and 30 percent in FY 1999 and thereafter.

3. Management Measures Guidance

Section 6217(g) of the Coastal Zone Act Reauthorization Amendments of 1990 requires EPA to publish (and periodically revise thereafter), in consultation with NOAA, the U.S. Fish and Wildlife Service, and other Federal agencies, "guidance for specifying management measures for sources of nonpoint pollution in coastal waters." "Management measures" are defined in section 6217(g)(5) as:

economically achievable measures for the control of the addition of pollutants from existing and new categories and classes of nonpoint sources of pollution, which reflect the greatest degree of pollutant reduction achievable through the application of the best available nonpoint pollution control practices, technologies, processes, siting criteria, operating methods, or other alternatives.

The management measures guidance is to include at a minimum six elements set forth in section 6217(g)(2):

"(A) a description of a range of methods, measures, or practices, including structural and nonstructural controls and operation and maintenance procedures, that constitute each measure;

"(B) a description of the categories and subcategories of activities and locations for which each measure may be suitable;

"(C) an identification of the individual pollutants or categories or classes of pollutants that may be controlled by the measures and the water quality effects of the measures;

"(D) quantitative estimates of the pollution reduction effects and costs of the measures;

"(E) a description of the factors which should be taken into account in adapting the measures to specific sites or locations; and

"(F) any necessary monitoring techniques to accompany the measures to assess over time the success of the measures in reducing pollution loads and improving water quality."

State Coastal Nonpoint Pollution Control programs must provide for the implementation of management measures that are in conformity with this management measures guidance.

The legislative history (floor statement of Rep. Gerry Studds, House sponsor of section 6217, as part of debate on Omnibus Reconciliation Bill, October 26, 1990) confirms that, as indicated by the statutory language, the "management measures" approach is technology-based rather than water-quality-based. That is, the management measures are to be based on technical and economic achievability, rather than on cause-and-effect linkages between particular land use activities and particular water quality problems. As the legislative history makes clear, implementation of these technology-based management measures will allow States to concentrate their resources initially on developing and implementing measures that experts agree will reduce pollution significantly. As explained more fully in a separate document, *Coastal Nonpoint Pollution Control Program: Program Development and Approval Guidance*, States will follow up the implementation of management measures with additional management measures to address any remaining coastal water quality problems.

The legislative history indicates that the range of management measures anticipated by Congress is broad and may include, among other measures, use of buffer strips, setbacks, techniques for identifying and protecting critical coastal areas and habitats, soil erosion and sedimentation controls, and siting and design criteria for water-related uses such as marinas. However, Congress has cautioned that the management measures should not unduly intrude upon the more intimate land use authorities properly exercised at the local level.

The legislative history also indicates that the management measures guidance, while patterned to a degree after the point source effluent guidelines' technology-based approach (see 40 CFR Parts 400-471 for examples of this approach), is not expected to have the same level of specificity as effluent guidelines. Congress has recognized that the effectiveness of a particular management measure at a particular site is subject to a variety of factors too complex to address in a single set of simple, mechanical prescriptions developed at the Federal level. Thus, the legislative history indicates that EPA's guidance should offer State officials a number of options and permit them considerable flexibility in selecting management measures that are appropriate for their State. Thus, the management measures in this document are written to allow such flexibility in implementation.

An additional major distinction drawn in the legislative history between effluent guidelines for point sources and this management measures guidance is that the management measures will not be directly or automatically applied to categories of nonpoint sources as a matter of Federal law. Instead, it is the State coastal nonpoint program, backed by the authority of State law, that must provide for the implementation of management measures in conformity with the management measures guidance. Under section 306(d)(16) of the CZMA, coastal zone programs must provide for enforceable policies and mechanisms to implement the applicable requirements of the State Coastal Nonpoint Pollution Control Program, including the management measures developed by the State "in conformity" with this guidance.

D. Program Implementation Guidance

In addition to this "management measures" guidance, EPA and NOAA have also jointly published *Coastal Nonpoint Pollution Control Program: Program Development and Approval Guidance*. That document provides guidance to States in interpreting and applying the various provisions of section 6217 of CZARA. It addresses issues such as the following: the basis and process for EPA/NOAA approval of State Coastal Nonpoint Pollution Control Programs; how EPA and NOAA expect State programs to implement management measures "in conformity" with this management measures guidance; how States may target sources in implementing their programs; changes in State coastal boundaries to implement their programs; and other aspects of State implementation of their programs.

II. DEVELOPMENT OF THE MANAGEMENT MEASURES GUIDANCE

A. Process Used to Develop This Guidance

Congress established a 6-month deadline (May 5, 1991) for publication of the proposed management measures guidance and an 18-month deadline (May 5, 1992) for publication of the final guidance.

EPA published the proposed guidance on June 14, 1991, and, in the interest of promoting the broadest possible consideration of the proposal by a wide variety of interested Federal and State agencies, affected industries, and citizens groups, provided a 6-month comment period. EPA received 477 public comments on the proposed guidance. In addition, EPA maintained an open process of consultation and discussion with many of the commenters and other experts. EPA's response to those comments, both written and oral, is reflected in the final guidance and is summarized in a separate document available from EPA entitled *Guidance Specifying Management Measures for Sources of Nonpoint Pollution in Coastal Waters: Response to Public Comments*.

In developing the final guidance, EPA continued to draw upon a diversity of knowledgeable sources of technical nonpoint source expertise by using a work group approach. Since the guidance addresses all nationally significant categories of nonpoint sources that impact or could impact coastal waters, EPA drew upon expertise covering the very wide range of subject areas addressed in this guidance.

Because experts in the field of nonpoint source pollution tend to specialize in particular source categories, EPA decided to form work groups on a category basis. Thus, in consultation with NOAA, the U.S. Fish and Wildlife Service, and other Federal and State agencies, EPA established five work groups to develop this guidance:

- (1) Urban, Construction, Highways, Airports/Bridges, and Septic Systems;
- (2) Agriculture;
- (3) Forestry;
- (4) Marinas and Recreational Boating; and
- (5) Hydromodification and Wetlands.

Each of these work groups held many 1- or 2-day meetings to discuss the technical issues related to the guidance. These meetings, which included State and Federal non-EPA participation, were very helpful to EPA in formulating the final guidance. EPA, however, made all decisions on the final contents of the guidance.

B. Scope and Contents of This Guidance

1. Categories of Nonpoint Sources Addressed

Many categories and subcategories of nonpoint sources could affect coastal waters and thus could potentially be addressed in this management measures guidance. Including all such sources in this guidance would have required more time than the tight statutory deadline allowed. For this reason, Congressman Studds stated in his floor statement, "The Conferees expect that EPA, in developing its guidance, will concentrate on the large nonpoint sources that are widely recognized as major contributors of water pollution."

This guidance thus focuses on five major categories of nonpoint sources that impair or threaten coastal waters nationally: (1) agricultural runoff; (2) urban runoff (including developing and developed areas); (3) silvicultural (forestry) runoff; (4) marinas and recreational boating; and (5) channelization and channel modification, dams, and streambank and shoreline erosion. EPA has also included management measures for wetlands, riparian areas, and vegetated treatment systems that apply generally to various categories of sources of nonpoint pollution.

2. Relationship Between This Management Measures Guidance for Coastal Nonpoint Sources and NPDES Permit Requirements for Point Sources

a. Urban Runoff

Historically, there have always been ambiguities in and overlaps between programs designed to control urban runoff nonpoint sources and those designed to control urban storm water point sources. For example, runoff may often originate from a nonpoint source but ultimately may be channelized and discharged through a point source. Potential confusion between these two programs has been heightened by Congressional enactment of two important pieces of legislation: section 402(p) of the Clean Water Act, which establishes permit requirements for certain municipal and industrial storm water discharges, and section 6217 of CZARA, which requires EPA to promulgate and States to provide for the implementation of management measures to control nonpoint pollution in coastal waters. The discussion below is intended to clarify the relationship between these two programs and describe the scope of the coastal nonpoint program and its applicability to urban runoff in coastal areas.

b. The Storm Water Permit Program

The storm water permit program is a two-phase program enacted by Congress in 1987 under section 402(p) of the Clean Water Act. Under Phase I, National Pollutant Discharge Elimination System (NPDES) permits are required to be issued for municipal separate storm sewers serving large or medium-sized populations (greater than 250,000 or 100,000 people, respectively) and for storm water discharges associated with industrial activity. Permits are also to be issued, on a case-by-case basis, if EPA or a State determines that a storm water discharge contributes to a violation of a water quality standard or is a significant contributor of pollutants to waters of the United States. EPA published a rule implementing Phase I on November 16, 1990.

Under Phase II, EPA is to prepare two reports to Congress that assess the remaining storm water discharges; determine, to the maximum extent practicable, the nature and extent of pollutants in such discharges; and establish procedures and methods to control storm water discharges to the extent necessary to mitigate impacts on water quality. Then, EPA is to issue regulations that designate storm water discharges, in addition to those addressed in Phase I, to be regulated to protect water quality, and EPA is to establish a comprehensive program to regulate those designated sources. The program is required to establish (1) priorities, (2) requirements for State storm water management programs, and (3) expeditious deadlines.

These regulations were to have been issued by EPA not later than October 1, 1992. Because of EPA's emphasis on Phase I, however, the Agency has not yet been able to complete the studies and issue appropriate regulations as required under section 402(p).

c. Coastal Nonpoint Pollution Control Programs

As discussed above, Congress enacted section 6217 of CZARA in late 1990 to require that States develop Coastal Nonpoint Pollution Control Programs that are in conformity with this management measures guidance published by EPA.

d. Scope and Coverage of This Guidance with Respect to Storm Water

EPA is excluding from coverage under this section 6217(g) guidance all storm water discharges that are covered by Phase I of the NPDES storm water permit program. Thus EPA is excluding any discharge from a municipal separate storm sewer system serving a population of 100,000 or more; any discharge of storm water associated with industrial activity; any discharge that has already been permitted; and any discharge for which EPA or the State makes a determination that the storm water discharge contributes to a violation of a water quality standard or is a significant contributor of pollutants to waters of the United States. All of these activities are clearly addressed by the storm water permit program and therefore are excluded from the coastal nonpoint pollution control program.

EPA is adopting a different approach with respect to other (non-Phase I) storm water discharges. At present, EPA has not yet promulgated regulations that would designate additional storm water discharges, beyond those regulated in Phase I, that will be required to be regulated in Phase II. It is thus not possible to determine at this point which additional storm water discharges will be regulated by the NPDES program and which will not. Furthermore, because of the great number of such discharges, it is likely that it would take many years to permit all of these discharges, even if EPA allows for relatively expeditious State permitting approaches such as the use of general permits.

Therefore, to give effect to the Congressional intent that coastal waters receive special and expeditious attention from EPA, NOAA, and the States, storm water runoff that potentially may be ultimately covered by Phase II of the storm water permit program is subject to this management measures guidance and will be addressed by the States' Coastal Nonpoint Pollution Control Programs. Any storm water runoff that ultimately is regulated under an NPDES permit will no longer be subject to this guidance once the permit is issued.

In addition, it should be noted that some other activities are not presently covered by NPDES permit application requirements and thus would be subject to a State's Coastal Nonpoint Pollution Control Program. Most importantly, construction activities on sites that result in the disturbance of less than 5 acres, which are not currently covered by Phase I storm water application requirements¹, are covered by the Coastal Nonpoint Pollution Control Program. Similarly, runoff from wholesale, retail, service, or commercial activities, including gas stations, which are not covered by Phase I of the NPDES storm water program, would be subject instead to a State's Coastal Nonpoint Pollution Control Program. Further, onsite disposal systems, which are generally not covered by the storm water permit program, would be subject to a State's Coastal Nonpoint Pollution Control Program.

Finally, EPA emphasizes that while different legal authorities may apply to different situations, the goals of the NPDES and CZARA programs are complementary. Many of the techniques and practices used to control urban runoff are equally applicable to both programs. Yet, the programs do not work identically. In the interest of consistency and comprehensiveness, States have the option to implement management measures in conformity with this guidance throughout the State's 6217 management area, as long as NPDES storm water requirements continue to be met by Phase I sources in that area. States are encouraged to develop consistent approaches to addressing urban runoff throughout their 6217 management areas.

e. Marinas

Another specific overlap between the storm water program and the coastal nonpoint source programs under CZARA occurs in the case of marinas (addressed in Chapter 5 of this guidance). In this guidance, EPA has attempted to avoid addressing marina activities that are clearly regulated point source discharges. Any storm water runoff at a marina that is ultimately regulated under an NPDES permit will no longer be subject to this guidance once the permit is issued. The introduction to Chapter 5 contains a detailed discussion of the scope of the NPDES program with respect to marinas and of the corresponding coverage of marinas by the CZARA program.

f. Other Point Sources

Overlapping areas between the point source and nonpoint source programs also occur with respect to concentrated animal feeding operations. Operations that meet particular size or other criteria are defined and regulated as point sources under the section 402 permit program, while other confined animal feeding operations are not currently regulated as point sources. Other overlaps may occur with respect to aspects of mining operations, oil and gas extraction, land disposal, and other activities.

¹ On May 27, 1992, the United States Court of Appeals for the Ninth Circuit invalidated EPA's exemption of construction sites smaller than 5 acres from the storm water permit program in *Natural Resources Defense Council v. EPA*, 965 F.2d 759 (9th Cir. 1992). EPA is conducting further rulemaking proceedings on this issue and will not require permit applications for construction activities under 5 acres until further rulemaking has been completed.

EPA intends that the Coastal Nonpoint Pollution Control Programs to be developed by the States, and the management measures they contain, apply only to sources that are not required under EPA's current regulations to obtain an NPDES permit. For any discharge ultimately covered by Phase II of the storm water permitting program, the management measures will continue to apply until an NPDES permit is issued for that discharge. In this guidance, EPA has attempted to avoid addressing activities that are regulated point source discharges.

3. Contents of This Guidance

a. General

Each category of sources (agriculture, forestry, etc.) is addressed in a separate chapter of this guidance. Each chapter is divided into sections, each of which contains (1) the management measure; (2) an applicability statement that describes, when appropriate, specific activities and locations for which the measure is suitable; (3) a description of the management measure's purpose; (4) the basis for the management measure's selection; (5) information on management practices that are suitable, either alone or in combination with other practices, to achieve the management measure; (6) information on the effectiveness of the management measure and/or of practices to achieve the measure; and (7) information on costs of the measure and/or practices to achieve the measure.

b. What "Management Measures" Are

Each section of this guidance begins with a succinct statement, set off in bold typeface in a box, that specifies a "management measure." As explained earlier, "management measures" are defined in CZARA as economically achievable measures to control the addition of pollutants to our coastal waters, which reflect the greatest degree of pollutant reduction achievable through the application of the best available nonpoint pollution control practices, technologies, processes, siting criteria, operating methods, or other alternatives.

These management measures will be incorporated by States into their coastal nonpoint programs, which under CZARA are to provide for the implementation of management measures that are "in conformity" with this guidance. Under CZARA, States are subject to a number of requirements as they develop and implement their Coastal Nonpoint Pollution Control Programs in conformity with this guidance and will have some flexibility in doing so. The application of these management measures by States to activities causing nonpoint pollution is described more fully in *Coastal Nonpoint Pollution Control Program: Program Development and Approval Guidance*, published jointly by EPA and NOAA.

c. What "Management Practices" Are

In addition to specifying management measures, this guidance also lists and describes management practices for illustrative purposes only. While State programs are required to specify management measures in conformity with this guidance, State programs need not specify or require the implementation of the particular management practices described in this document. As a practical matter, however, EPA anticipates that the management measures typically will be implemented by applying one or more management practices appropriate to the source, location, and climate. The practices listed in this document have been found by EPA to be representative of the types of practices that can be applied successfully to achieve the management measures. EPA has also used some of these practices, or appropriate combinations of these practices, as a basis for estimating the effectiveness, costs, and economic impacts of achieving the management measures. (Economic impacts of the management measures are addressed in a separate document entitled *Economic Impacts of EPA Guidance Specifying Management Measures for Sources of Nonpoint Pollution in Coastal Waters*.)

EPA recognizes that there is often site-specific, regional, and national variability in the selection of appropriate practices, as well as in the design constraints and pollution control effectiveness of practices. The list of practices for each management measure is not all-inclusive and does not preclude States or local agencies from using other technically sound practices. In all cases, however, the practice or set of practices chosen by a State needs to achieve the management measure.

EPA recognizes as well that many sources may already achieve the management measures, or that only one or two practices may need to be added to achieve the measures. Existing NPS progress should be recognized and appropriate credit given to those who have already made progress toward accomplishing our common goal to control NPS pollution. There is no need to spend additional resources for a practice that is already in existence and operational. Existing practices, plans, and systems should be viewed as building blocks for these management measures and may need no additional improvement.

III. TECHNICAL APPROACH TAKEN IN DEVELOPING THIS GUIDANCE

A. The Nonpoint Source Pollution Process

Nonpoint source pollutants are transported to surface water by a variety of means, including runoff, snowmelt, and ground-water infiltration. Ground water and surface water are both considered part of the same hydrologic cycle when designing management measures. Ground-water contributions of pollutant loadings to surface waters in coastal areas are often very significant. Hydrologic modification is another form of nonpoint source pollution that often adversely affects the biological and physical integrity of surface waters.

1. Source Control

Source control is the first opportunity in any nonpoint source control effort. Source control methods vary for different types of nonpoint source problems. Examples of source control include:

- (1) Reducing or eliminating the introduction of pollutants to a land area. Examples include reduced nutrient and pesticide application.
- (2) Preventing pollutants from leaving the site during land-disturbing activities. Examples include using conservation tillage, planning forest road construction to minimize erosion, siting marinas adjacent to deep waters to eliminate or minimize the need for dredging, and managing grazing to protect against overgrazing and the resulting increased soil erosion.
- (3) Preventing interaction between precipitation and introduced pollutants. Examples include installing gutters and diversions to keep clean rainfall away from barnyards, diverting rainfall runoff from areas of land disturbance at construction sites, and timing chemical applications or logging activities based on weather forecasts or seasonal weather patterns.
- (4) Protecting riparian habitat and other sensitive areas. Examples include protection and preservation of riparian zones, shorelines, wetlands, and highly erosive slopes.
- (5) Protecting natural hydrology. Examples include the maintenance of pervious surfaces in developing areas (conditioned based on ground-water considerations), riparian zone protection, and water management.

2. Delivery Reduction

Pollution prevention often involves delivery reduction in addition to appropriate source control measures. Delivery reduction practices intercept pollutants leaving the source prior to their delivery to the receiving water by capturing the runoff or infiltrate, followed either by treating and releasing the effluent or by permanently keeping the effluent from reaching a surface water or ground-water resource. Management measures in this guidance incorporate delivery reduction practices as appropriate to achieve the greatest degree of pollutant reduction economically achievable, as required by the statute.

By their nature, delivery reduction practices often bring with them side effects that must be accounted for. For example, management practices that intercept pollutants leaving the source may reduce runoff, but also may increase infiltration to ground water. For instance, infiltration basins trap runoff and allow for its percolation. These devices, although highly successful at controlling suspended solids, may not, because of their infiltration properties, be suitable for use in areas with high ground-water tables and nitrate or pesticide residue problems. Thus, the reader should select management practices with some care for the total water quality impact of the practices.

The performance of delivery reduction practices is to a large extent dependent on suitable designs, operational conditions, and proper maintenance. For example, filter strips may be effective for controlling particulate and soluble pollutants where sedimentation is not excessive, but may be overwhelmed by high sediment input. Thus, in many cases, filter strips are used as pretreatment or supplemental treatment for other practices within a management system, rather than as an entire solution to a sedimentation problem.

These examples illustrate that the combination of source control and delivery reduction practices, as well as the application of those practices as components of management measures, is dependent on site-specific conditions. Technical factors that may affect the suitability of management measures include, but are not limited to, land use, climate, size of drainage area, soil permeability, slopes, depth to water table, space requirements, type and condition of the water resource to be protected, depth to bedrock, and pollutants to be addressed. In this management measures guidance, many of these factors are discussed as they affect the suitability of particular measures.

B. Management Measures as Systems

Technical experts who design and implement effective nonpoint source control measures do so from a management systems approach as opposed to an approach that focuses on individual practices. That is, the pollutant control achievable from any given management system is viewed as the sum of the parts, taking into account the range of effectiveness associated with each single practice, the costs of each practice, and the resulting overall cost and effectiveness. Some individual practices may not be very effective alone but, in combination with others, may provide a key function in highly effective systems. This management measures guidance attempts to adopt an approach that encourages such system-building by stating the measures in general terms, followed by discussion of specific management practices, which combined encourage the use of appropriate situation-specific sets of practices that will achieve the management measure.

C. Economic Achievability of the Proposed Management Measures

EPA has determined that all of the management measures in this guidance are economically achievable, including, where limited data were available, cost-effective. Congress defined "management measures" to mean "*economically achievable* measures ... which reflect the greatest degree of pollutant reduction achievable through the application of the best available nonpoint pollution control practices, technologies, processes, siting criteria, operating methods, or other alternatives."

CHAPTER 2: Management Measures for Agriculture Sources

I. INTRODUCTION

A. What "Management Measures" Are

This chapter specifies management measures to protect coastal waters from agricultural sources of nonpoint pollution. "Management measures" are defined in section 6217 of the Coastal Zone Act Reauthorization Amendments of 1990 (CZARA) as economically achievable measures to control the addition of pollutants to our coastal waters, which reflect the greatest degree of pollutant reduction achievable through the application of the best available nonpoint pollution control practices, technologies, processes, siting criteria, operating methods, or other alternatives.

These management measures will be incorporated by States into their coastal nonpoint programs, which under CZARA are to provide for the implementation of management measures that are "in conformity" with this guidance. Under CZARA, States are subject to a number of requirements as they develop and implement their Coastal Nonpoint Pollution Control Programs in conformity with this guidance and will have some flexibility in doing so. The application of these management measures by States to activities causing nonpoint pollution is described more fully in *Coastal Nonpoint Pollution Control Program: Program Development and Approval Guidance*, published jointly by the U.S. Environmental Protection Agency (EPA) and the National Oceanic and Atmospheric Administration (NOAA).

B. What "Management Practices" Are

In addition to specifying management *measures*, this chapter also lists and describes management *practices* for illustrative purposes only. While State programs are required to specify management *measures* in conformity with this guidance, State programs need not specify or require the implementation of the particular management *practices* described in this document. However, as a practical matter, EPA anticipates that States the management measures generally will be implemented by applying one or more management practices appropriate to the source, location, and climate. The practices listed in this document have been found by EPA to be representative of the types of practices that can be applied successfully to achieve the management measures. EPA has also used some of these practices, or appropriate combinations of these practices, as a basis for estimating the effectiveness, costs, and economic impacts of achieving the management measures. (Economic impacts of the management measures are addressed in a separate document entitled *Economic Impacts of EPA Guidance Specifying Management Measures for Sources of Nonpoint Pollution in Coastal Waters*.)

EPA recognizes that there is often site-specific, regional and national variability in the selection of appropriate practices, as well as in the design constraints and pollution control effectiveness of practices. The list of practices for each management measure is not all-inclusive and does not preclude States or local agencies from using other technically sound practices. In all cases, however, the practice or set of practices chosen by a State needs to achieve the management measure.

C. Scope of This Chapter

This chapter addresses six categories of sources of agricultural nonpoint pollution that affect coastal waters:

- (1) Erosion from cropland;
- (2) Confined animal facilities;
- (3) The application of nutrients to cropland;
- (4) The application of pesticides to cropland;
- (5) Grazing management; and
- (6) Irrigation of cropland.

Each category of sources (with the exception of confined animal facilities, which has two management measures) is addressed in a separate section of this guidance. Each section contains (1) the management measure; (2) an applicability statement that describes, when appropriate, specific activities and locations for which the measure is suitable; (3) a description of the management measure's purpose; (4) the basis for the management measure's selection; (5) information on the effectiveness of the management measure and/or of practices to achieve the measure; (6) information on management practices that are suitable, either alone or in combination with other practices, to achieve the management measure; and (7) information on costs of the measure and/or practices to achieve the measure.

D. Relationship of This Chapter to Other Chapters and to Other EPA Documents

1. Chapter 1 of this document contains detailed information on the legislative background for this guidance, the process used by EPA to develop this guidance, and the technical approach used by EPA in the guidance.
2. Chapter 7 of this document contains management measures to protect wetlands and riparian areas that serve a nonpoint source abatement function. These measures apply to a broad variety of sources, including agricultural sources.
3. Chapter 8 of this document contains information on recommended monitoring techniques (1) to ensure proper implementation, operation, and maintenance of the management measures and (2) to assess over time the success of the measures in reducing pollution loads and improving water quality.
4. EPA has separately published a document entitled *Economic Impacts of EPA Guidance Specifying Management Measures for Sources of Nonpoint Pollution in Coastal Waters*.
5. NOAA and EPA have jointly published guidance entitled *Coastal Nonpoint Pollution Control Program: Program Development and Approval Guidance*. This guidance contains details on how State Coastal Nonpoint Pollution Control Programs are to be developed by States and approved by NOAA and EPA. It includes guidance on the following:
 - The basis and process for EPA/NOAA approval of state Coastal Nonpoint Pollution Control Programs;
 - How NOAA and EPA expect State programs to provide for the implementation of management measures "in conformity" with this management measures guidance;
 - How States may target sources in implementing their Coastal Nonpoint Pollution Control Programs;

- Changes in State coastal boundaries; and
- Requirements concerning how States are to implement the Coastal Nonpoint Pollution Control Programs.

E. Coordination of Measures

The management measures developed for agriculture are to be used as an overall system of measures to address nonpoint source (NPS) pollution sources on any given site. In most cases, not all of the measures will be needed to address the nonpoint sources at a specific site. For example, many farms or agriculture enterprises do not have animals as part of the enterprise and would not need to be concerned with the management measures that address confined animal facilities or grazing. By the same token, many enterprises do not use irrigation and would not need to use the irrigation water management measure.

Most enterprises will have more than one source to address and may need to employ two or more of the measures to address the multiple sources. Where more than one source exists, the application of the measures is to be coordinated to produce an overall system that adequately addresses all sources for the site in a cost-effective manner.

The agricultural management measures for CZMA are, for the most part, systems of practices that are commonly used and recommended by the U.S. Department of Agriculture (USDA) as components of Resource Management Systems, Water Quality Management Plans, and Agricultural Waste Management Systems. Practices and plans installed under State NPS programs are also included. Many farms and fields, therefore, may already be in compliance with the measures needed to address the nonpoint sources on them. For cases where existing source control is inadequate to achieve conformity with the needed management measures, it may be necessary to add only one or two more practices to achieve conformity. Existing NPS progress must be recognized and appropriate credit given to the accomplishment of our common goal to control NPS pollution. There is no need to spend additional resources for a practice that is already in existence and operational. Existing practices, plans, and systems should be viewed as building blocks for these management measures and may need no additional improvement.

F. Pollutants That Cause Agricultural Nonpoint Source Pollution¹

The primary agricultural nonpoint source pollutants are nutrients, sediment, animal wastes, salts, and pesticides. Agricultural activities also have the potential to directly impact the habitat of aquatic species through physical disturbances caused by livestock or equipment, or through the management of water. The general pathways for transport of pollutants from agricultural lands to water resources are shown in Figure 2-1 (USDA, 1991). The effects of these pollutants on water quality are discussed below.

1. Nutrients

Nitrogen (N) and phosphorus (P) are the two major nutrients from agricultural land that degrade water quality. Nutrients are applied to agricultural land in several different forms and come from various sources, including;

- Commercial fertilizer in a dry or fluid form, containing nitrogen (N), phosphorus (P), potassium (K), secondary nutrients, and micronutrients;
- Manure from animal production facilities including bedding and other wastes added to the manure, containing N,P,K, secondary nutrients, micronutrients, salts, some metals, and organics;

¹ This section on Pollutants That Cause Agricultural Nonpoint Source Pollution is adapted from USDA-SCS (1983).

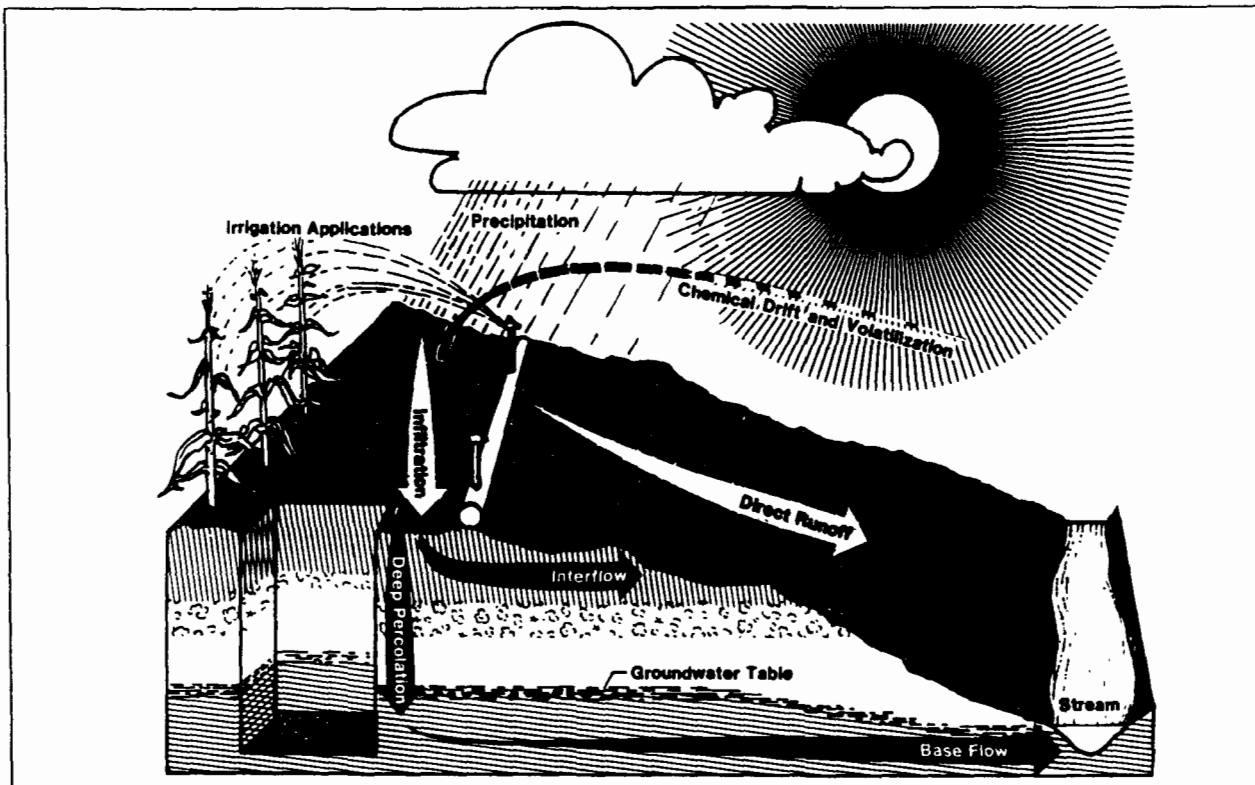

Figure 2-1. Pathways through which substances are transported from agricultural land to become water pollutants (USDA, 1991).

- Municipal and industrial treatment plant sludge, containing N,P,K, secondary nutrients, micronutrients, salts, metals, and organic solids;
- Municipal and industrial treatment plant effluent, containing N,P,K, secondary nutrients, micronutrients, salts, metals, and organics;
- Legumes and crop residues containing N, P, K, secondary nutrients, and micronutrients;
- Irrigation water; and
- Atmospheric deposition of nutrients such as nitrogen and sulphur.

Surface water runoff from agricultural lands to which nutrients have been applied may transport the following pollutants:

- Particulate-bound nutrients, chemicals, and metals, such as phosphorus, organic nitrogen, and metals applied with some organic wastes;
- Soluble nutrients and chemicals, such as nitrogen, phosphorus, metals, and many other major and minor nutrients;
- Sediment, particulate organic solids, and oxygen-demanding material;

- Salts; and
- Bacteria, viruses, and other microorganisms.

Ground-water infiltration from agricultural lands to which nutrients have been applied may transport the following pollutants: soluble nutrients and chemicals, such as nitrogen, phosphorus, metals, and many other major and minor nutrients, and salts.

Surface water and ground-water pollutants from organic matter and crop residue decomposition and from legumes growing on agricultural land may include nitrogen, phosphorus, and other essential nutrients found in the residue of growing crops.

All plants require nutrients for growth. In aquatic environments, nutrient availability usually limits plant growth. Nitrogen and phosphorus generally are present at background or natural levels below 0.3 and 0.05 mg/L, respectively. When these nutrients are introduced into a stream, lake, or estuary at higher rates, aquatic plant productivity may increase dramatically. This process, referred to as cultural eutrophication, may adversely affect the suitability of the water for other uses.

Increased aquatic plant productivity results in the addition to the system of more organic material, which eventually dies and decays. The decaying organic matter produces unpleasant odors and depletes the oxygen supply required by aquatic organisms. Excess plant growth may also interfere with recreational activities such as swimming and boating. Depleted oxygen levels, especially in colder bottom waters where dead organic matter tends to accumulate, can reduce the quality of fish habitat and encourage the propagation of fish that are adapted to less oxygen or to warmer surface waters. Highly enriched waters will stimulate algae production, with consequent increased turbidity and color. Algae growth is also believed to be harmful to coral reefs (e.g., Florida coast). Furthermore, the increased turbidity results in less sunlight penetration and availability to submerged aquatic vegetation (SAV). Since SAV provides habitat for small or juvenile fish, the loss of SAV has severe consequences for the food chain. Chesapeake Bay is an example in which nutrients are believed to have contributed to SAV loss.

a. Nitrogen

All forms of transported nitrogen are potential contributors to eutrophication in lakes, estuaries, and some coastal waters. In general, though not in all cases, nitrogen availability is the limiting factor for plant growth in marine ecosystems. Thus, the addition of nitrogen can have a significant effect on the natural functioning of marine ecosystems.

In addition to eutrophication, excessive nitrogen causes other water quality problems. Dissolved ammonia at concentrations above 0.2 mg/L may be toxic to fish, especially trout. Nitrates in drinking water are potentially dangerous, especially to newborn infants. Nitrate is converted to nitrite in the digestive tract, which reduces the oxygen-carrying capacity of the blood (methemoglobinemia), resulting in brain damage or even death. The U.S. Environmental Protection Agency has set a limit of 10 mg/L nitrate-nitrogen in water used for human consumption (USEPA, 1989).

Nitrogen is naturally present in soils but must be added to increase crop production. Nitrogen is added to the soil primarily by applying commercial fertilizers and manure, but also by growing legumes (biological nitrogen fixation) and incorporating crop residues. Not all nitrogen that is present in or on the soil is available for plant use at any one time. For example, in the eastern Corn Belt, it is normally assumed that about 50 percent of applied N is assimilated by crops during the year of application (Nelson, 1985). Organic nitrogen normally constitutes the majority of the soil nitrogen. It is slowly converted (2 to 3 percent per year) to the more readily plant-available inorganic ammonium or nitrate.

The chemical form of nitrogen affects its impact on water quality. The most biologically important inorganic forms of nitrogen are ammonium ($\text{NH}_4\text{-N}$), nitrate ($\text{NO}_3\text{-N}$), and nitrite ($\text{NO}_2\text{-N}$). Organic nitrogen occurs as particulate

matter, in living organisms, and as detritus. It occurs in dissolved form in compounds such as amino acids, amines, purines, and urea.

Nitrate-nitrogen is highly mobile and can move readily below the crop root zone, especially in sandy soils. It can also be transported with surface runoff, but not usually in large quantities. Ammonium, on the other hand, becomes adsorbed to the soil and is lost primarily with eroding sediment. Even if nitrogen is not in a readily available form as it leaves the field, it can be converted to an available form either during transport or after delivery to waterbodies.

b. Phosphorus

Phosphorus can also contribute to the eutrophication of both freshwater and estuarine systems. While phosphorus typically plays the controlling role in freshwater systems, in some estuarine systems both nitrogen and phosphorus can limit plant growth. Algae consume dissolved inorganic phosphorus and convert it to the organic form. Phosphorus is rarely found in concentrations high enough to be toxic to higher organisms.

Although the phosphorus content of most soils in their natural condition is low, between 0.01 and 0.2 percent by weight, recent soil test results show that the phosphorus content of most cropped soils in the Northeast have climbed to the high or very high range (Sims, 1992). Manure and fertilizers increase the level of available phosphorus in the soil to promote plant growth, but many soils now contain higher phosphorus levels than plants need (Killorn, 1980; Novais and Kamprath, 1978). Phosphorus can be found in the soil in dissolved, colloidal, or particulate forms.

Runoff and erosion can carry some of the applied phosphorus to nearby water bodies. Dissolved inorganic phosphorus (orthophosphate phosphorus) is probably the only form directly available to algae. Particulate and organic phosphorus delivered to waterbodies may later be released and made available to algae when the bottom sediment of a stream becomes anaerobic, causing water quality problems.

2. Sediment

Sediment affects the use of water in many ways. Suspended solids reduce the amount of sunlight available to aquatic plants, cover fish spawning areas and food supplies, smother coral reefs, clog the filtering capacity of filter feeders, and clog and harm the gills of fish. Turbidity interferes with the feeding habits of fish. These effects combine to reduce fish, shellfish, coral, and plant populations and decrease the overall productivity of lakes, streams, estuaries, and coastal waters. In addition, recreation is limited because of the decreased fish population and the water's unappealing, turbid appearance. Turbidity also reduces visibility, making swimming less safe.

Chemicals such as some pesticides, phosphorus, and ammonium are transported with sediment in an adsorbed state. Changes in the aquatic environment, such as a lower concentration in the overlying waters or the development of anaerobic conditions in the bottom sediments, can cause these chemicals to be released from the sediment. Adsorbed phosphorus transported by the sediment may not be immediately available for aquatic plant growth but does serve as a long-term contributor to eutrophication.

Sediment is the result of erosion. It is the solid material, both mineral and organic, that is in suspension, is being transported, or has been moved from its site of origin by air, water, gravity, or ice. The types of erosion associated with agriculture that produce sediment are (1) sheet and rill erosion and (2) gully erosion. Soil erosion can be characterized as the transport of particles that are detached by rainfall, flowing water, or wind (Figure 2-2). Eroded soil is either redeposited on the same field or transported from the field in runoff.

Sediments from different sources vary in the kinds and amounts of pollutants that are adsorbed to the particles. For example, sheet and rill erosion mainly move soil particles from the surface or plow layer of the soil. Sediment that originates from surface soil has a higher pollution potential than that from subsurface soils. The topsoil of a field is usually richer in nutrients and other chemicals because of past fertilizer and pesticide applications, as well as nutrient cycling and biological activity. Topsoil is also more likely to have a greater percentage of organic matter. Sediment from gullies and streambanks usually carries less adsorbed pollutants than sediment from surface soils.

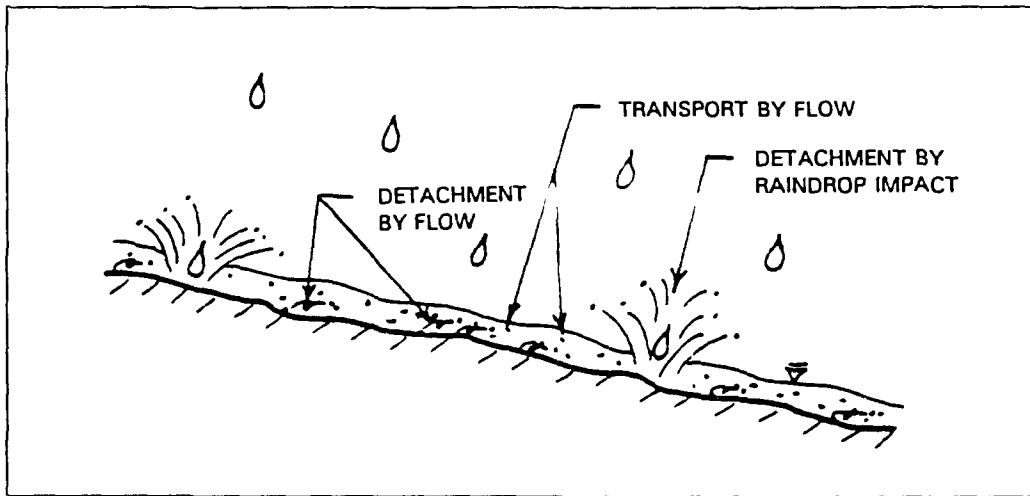

Figure 2-2. Sediment detachment and transport (USEPA, 1981).

Soil eroded and delivered from cropland as sediment usually contains a higher percentage of finer and less dense particles than the parent soil on the cropland. This change in composition of eroded soil is due to the selective nature of the erosion process. For example, larger particles are more readily detached from the soil surface because they are less cohesive, but they also settle out of suspension more quickly because of their size. Organic matter is not easily detached because of its cohesive properties, but once detached it is easily transported because of its low density. Clay particles and organic residues will remain suspended for longer periods and at slower flow velocities than will larger or more dense particles. This selective erosion can increase overall pollutant delivery per ton of sediment delivered because small particles have a much greater adsorption capacity than larger particles. As a result, eroding sediments generally contain higher concentrations of phosphorus, nitrogen, and pesticides than the parent soil (i.e., they are enriched).

3. Animal Wastes

Animal waste (manure) includes the fecal and urinary wastes of livestock and poultry; process water (such as from a milking parlor); and the feed, bedding, litter, and soil with which they become intermixed. The following pollutants may be contained in manure and associated bedding materials and could be transported by runoff water and process wastewater from confined animal facilities:

- Oxygen-demanding substances;
- Nitrogen, phosphorus, and many other major and minor nutrients or other deleterious materials;
- Organic solids;
- Salts;
- Bacteria, viruses, and other microorganisms; and
- Sediments.

Fish kills may result from runoff, wastewater, or manure entering surface waters, due to ammonia or dissolved oxygen depletion. The decomposition of organic materials can deplete dissolved oxygen supplies in water, resulting in anoxic or anaerobic conditions. Methane, amines, and sulfide are produced in anaerobic waters, causing the water to acquire an unpleasant odor, taste, and appearance. Such waters can be unsuitable for drinking, fishing, and other recreational uses.

Solids deposited in waterbodies can accelerate eutrophication through the release of nutrients over extended periods of time. Because of the high nutrient and salt content of manure and runoff from manure-covered areas, contamination of ground water can be a problem if storage structures are not built to minimize seepage.

Animal diseases can be transmitted to humans through contact with animal feces. Runoff from fields receiving manure will contain extremely high numbers of bacteria if the manure has not been incorporated or the bacteria have not been subject to stress. Shellfish closure and beach closure can result from high fecal coliform counts. Although not the only source of pathogens, animal waste has been responsible for shellfish contamination in some coastal waters.

The method, timing, and rate of manure application are significant factors in determining the likelihood that water quality contamination will result. Manure is generally more likely to be transported in runoff when applied to the soil surface than when incorporated into the soil. Spreading manure on frozen ground or snow can result in high concentrations of nutrients being transported from the field during rainfall or snowmelt, especially when the snowmelt or rainfall events occur soon after spreading (Robillard and Walter, 1986). The water quality problems associated with nitrogen and phosphorus are discussed under Section F.1.

When application rates of manure for crop production are based on N, the P and K rates normally exceed plant requirements (Westerman et al., 1985). The soil generally has the capacity to adsorb phosphorus leached from manure applied on land. As previously mentioned, however, nitrates are easily leached through soil into ground water or to return flows, and phosphorus can be transported by eroded soil.

Conditions that cause a rapid die-off of bacteria are low soil moisture, low pH, high temperatures, and direct solar radiation. Manure storage generally promotes die-off, although pathogens can remain dormant at certain temperatures. Composting the wastes can be quite effective in decreasing the number of pathogens.

4. Salts

Salts are a product of the natural weathering process of soil and geologic material. They are present in varying degrees in all soils and in fresh water, coastal waters, estuarine waters, and ground waters.

In soils that have poor subsurface drainage, high salt concentrations are created within the root zone where most water extraction occurs. The accumulation of soluble and exchangeable sodium leads to soil dispersion, structure breakdown, decreased infiltration, and possible toxicity; thus, salts often become a serious problem on irrigated land, both for continued agricultural production and for water quality considerations. High salt concentrations in streams can harm freshwater aquatic plants just as excess soil salinity damages agricultural crops. While salts are generally a more significant pollutant for freshwater ecosystems than for saline ecosystems, they may also adversely affect anadromous fish. Although they live in coastal and estuarine waters most of their lives, anadromous fish depend on freshwater systems near the coast for crucial portions of their life cycles.

The movement and deposition of salts depend on the amount and distribution of rainfall and irrigation, the soil and underlying strata, evapotranspiration rates, and other environmental factors. In humid areas, dissolved mineral salts have been naturally leached from the soil and substrata by rainfall. In arid and semi-arid regions, salts have not been removed by natural leaching and are concentrated in the soil. Soluble salts in saline and sodic soils consist of calcium, magnesium, sodium, potassium, carbonate, bicarbonate, sulfate, and chloride ions. They are fairly easily leached from the soil. Sparingly soluble gypsum and lime also occur in amounts ranging from traces to more than 50 percent of the soil mass.

Irrigation water, whether from ground or surface water sources, has a natural base load of dissolved mineral salts. As the water is consumed by plants or lost to the atmosphere by evaporation, the salts remain and become concentrated in the soil. This is referred to as the "concentrating effect."

The total salt load carried by irrigation return flow is the sum of the salt remaining in the applied water plus any salt picked up from the irrigated land. Irrigation return flows provide the means for conveying the salts to the receiving streams or ground-water reservoirs. If the amount of salt in the return flow is low in comparison to the total stream flow, water quality may not be degraded to the extent that use is impaired. However, if the process of

water diversion for irrigation and the return of saline drainage water is repeated many times along a stream or river, water quality will be progressively degraded for downstream irrigation use as well as for other uses.

5. Pesticides

The term *pesticide* includes any substance or mixture of substances intended for preventing, destroying, repelling, or mitigating any pest or intended for use as a plant regulator, defoliant, or desiccant. The principal pesticidal pollutants that may be detected in surface water and in ground water are the active and inert ingredients and any persistent degradation products. Pesticides and their degradation products may enter ground and surface water in solution, in emulsion, or bound to soil colloids. For simplicity, the term *pesticides* will be used to represent "pesticides and their degradation products" in the following sections.

Despite the documented benefits of using pesticides (insecticides, herbicides, fungicides, miticides, nematocides, etc.) to control plant pests and enhance production, these chemicals may, in some instances, cause impairments to the uses of surface water and ground water. Some types of pesticides are resistant to degradation and may persist and accumulate in aquatic ecosystems.

Pesticides may harm the environment by eliminating or reducing populations of desirable organisms, including endangered species. Sublethal effects include the behavioral and structural changes of an organism that jeopardize its survival. For example, certain pesticides have been found to inhibit bone development in young fish or to affect reproduction by inducing abortion.

Herbicides in the aquatic environment can destroy the food source for higher organisms, which may then starve. Herbicides can also reduce the amount of vegetation available for protective cover and the laying of eggs by aquatic species. Also, the decay of plant matter exposed to herbicide-containing water can cause reductions in dissolved oxygen concentration (North Carolina State University, 1984).

Sometimes a pesticide is not toxic by itself but is lethal in the presence of other pesticides. This is referred to as a *synergistic effect*, and it may be difficult to predict or evaluate. *Bioconcentration* is a phenomenon that occurs if an organism ingests more of a pesticide than it excretes. During its lifetime, the organism will accumulate a higher concentration of that pesticide than is present in the surrounding environment. When the organism is eaten by another animal higher in the food chain, the pesticide will then be passed to that animal, and on up the food chain to even higher level animals.

A major source of contamination from pesticide use is the result of normal application of pesticides. Other sources of pesticide contamination are atmospheric deposition, spray drift during the application process, misuse, and spills, leaks, and discharges that may be associated with pesticide storage, handling, and waste disposal.

The primary routes of pesticide transport to aquatic systems are (Maas et al., 1984):

- (1) Direct application;
- (2) In runoff;
- (3) Aerial drift;
- (4) Volatilization and subsequent atmospheric deposition; and
- (5) Uptake by biota and subsequent movement in the food web.

The amount of field-applied pesticide that leaves a field in the runoff and enters a stream primarily depends on:

- (1) The intensity and duration of rainfall or irrigation;
- (2) The length of time between pesticide application and rainfall occurrence;
- (3) The amount of pesticide applied and its soil/water partition coefficient;
- (4) The length and degree of slope and soil composition;
- (5) The extent of exposure to bare (vs. residue or crop-covered) soil;

- (6) Proximity to streams;
- (7) The method of application; and
- (8) The extent to which runoff and erosion are controlled with agronomic and structural practices.

Pesticide losses are generally greatest when rainfall is intense and occurs shortly after pesticide application, a condition for which water runoff and erosion losses are also greatest.

The rate of pesticide movement through the soil profile to ground water is inversely proportional to the pesticide adsorption partition coefficient or K_d (a measure of the degree to which a pesticide is partitioned between the soil and water phase). The larger the K_d , the slower the movement and the greater the quantity of water required to leach the pesticide to a given depth.

Pesticides can be transported to receiving waters either in dissolved form or attached to sediment. Dissolved pesticides may be leached to ground-water supplies. Both the degradation and adsorption characteristics of pesticides are highly variable.

6. Habitat Impacts

The functioning condition of riparian-wetland areas is a result of interaction among geology, soil, water, and vegetation. Riparian-wetland areas are functioning properly when adequate vegetation is present to (1) dissipate stream energy associated with high water flows, thereby reducing erosion and improving water quality; (2) filter sediment and aid floodplain development; (3) support denitrification of nitrate-contaminated ground water as it is discharged into streams; (4) improve floodwater retention and ground-water recharge; (5) develop root masses that stabilize banks against cutting action; (6) develop diverse ponding and channel characteristics to provide the habitat and the water depth, duration, and temperature necessary for fish production, waterfowl breeding, and other uses; and (7) support greater biodiversity.

Improper livestock grazing affects all four components of the water-riparian system: banks/shores, water column, channel, and aquatic and bordering vegetation (Platts, 1990). The potential effects of grazing include:

Shore/banks

- Shear or sloughing of streambank soils by hoof or head action.
- Water, ice, and wind erosion of exposed streambank and channel soils because of loss of vegetative cover.
- Elimination or loss of streambank vegetation.
- Reduction of the quality and quantity of streambank undercuts.
- Increasing streambank angle (laying back of streambanks), which increases water width, decreases stream depth, and alters or eliminates fish habitat.

Water Column

- Withdrawal from streams to irrigate grazing lands.
- Drainage of wet meadows or lowering of the ground-water table to facilitate grazing access.
- Pollutants (e.g., sediments) in return water from grazed lands, which are detrimental to the designated uses such as fisheries.

- Changes in magnitude and timing of organic and inorganic energy (i.e., solar radiation, debris, nutrients) inputs to the stream.
- Increase in fecal contamination.
- Changes in stream morphology, such as increases in stream width and decreases in stream depth, including reduction of stream shore water depth.
- Changes in timing and magnitude of stream flow events from changes in watershed vegetative cover.
- Increase in stream temperature.

Channel

- Changes in channel morphology.
- Altered sediment transport processes.

Riparian Vegetation

- Changes in plant species composition (e.g., shrubs to grass to forbs).
- Reduction of floodplain and streambank vegetation including vegetation hanging over or entering into the water column.
- Decrease in plant vigor.
- Changes in timing and amounts of organic energy leaving the riparian zone.
- Elimination of riparian plant communities (i.e., lowering of the water table allowing xeric plants to replace riparian plants).

II. MANAGEMENT MEASURES FOR AGRICULTURAL SOURCES

A. Erosion and Sediment Control Management Measure

Apply the erosion component of a Conservation Management System (CMS) as defined in the Field Office Technical Guide of the U.S. Department of Agriculture - Soil Conservation Service (see Appendix 2A of this chapter) to minimize the delivery of sediment from agricultural lands to surface waters, or

Design and install a combination of management and physical practices to settle the settleable solids and associated pollutants in runoff delivered from the contributing area for storms of up to and including a 10-year, 24-hour frequency.

1. Applicability

This management measure is intended to be applied by States to activities that cause erosion on agricultural land and on land that is converted from other land uses to agricultural lands. Agricultural lands include:

- Cropland;
- Irrigated cropland;
- Range and pasture;
- Orchards;
- Permanent hayland;
- Specialty crop production; and
- Nursery crop production.

Under the Coastal Zone Act Reauthorization Amendments of 1990, States are subject to a number of requirements as they develop coastal nonpoint programs in conformity with this measure and will have some flexibility in doing so. The application of management measures by States is described more fully in *Coastal Nonpoint Pollution Control Program: Program Development and Approval Guidance*, published jointly by the U.S. Environmental Protection Agency (EPA) and the National Oceanic and Atmospheric Administration (NOAA) of the U.S. Department of Commerce.

2. Description

The problems associated with soil erosion are the movement of sediment and associated pollutants by runoff into a waterbody. See Section I.F.2 of this chapter for additional information regarding problems.

Application of this management measure will reduce the mass load of sediment reaching a waterbody and improve water quality and the use of the water resource. The measure can be implemented by using one of two different strategies or a combination of both. The first, and most desirable, strategy would be to implement practices on the field that would prevent erosion and the transport of sediment from the field. Practices that could be used to accomplish this are conservation tillage, contour strip-cropping, terraces, and critical area planting.

The second strategy is to route runoff from fields through practices that remove sediment. Practices that could be used to accomplish this are filter strips, field borders, grade stabilization structures, sediment retention ponds, water and sediment control basins, and terraces. Site conditions will dictate the appropriate combination of practices for any given situation.

Conservation management systems (CMS) include any combination of conservation practices and management that achieves a level of treatment of the five natural resources (i.e., soil, water, air, plants, and animals) that satisfies criteria contained in the Soil Conservation Service (SCS) Field Office Technical Guide (FOTG), such as a resource management system (RMS) or an acceptable management system (AMS). These criteria are developed at the State level, with concurrence by the appropriate SCS National Technical Center (NTC). The criteria are then applied in the provision of field office technical assistance, under the direction of the District Conservationist of SCS. In-state coordination of FOTG use is provided by the Area Conservationist and State Conservationist of SCS.

The erosion component of a CMS addresses sheet and rill erosion, wind erosion, concentrated flow, streambank erosion, soil mass movements, road bank erosion, construction site erosion, and irrigation-induced erosion. National (minimum) criteria pertaining to erosion and sediment control under an RMS will be applied to prevent long-term soil degradation and to resolve existing or potential off-site deposition problems. National criteria pertaining to the water resource will be applied to control sediment movement to minimize contamination of receiving waters. The combined effects of these criteria will be to both reduce upland soil erosion and minimize sediment delivery to receiving waters.

The practical limits of resource protection under a CMS within any given area are determined through the application of national social, cultural, and economic criteria. With respect to economics, landowners will not be required to implement an RMS if the system is generally too costly for landowners. Instead, landowners may be required to implement a less costly, and less protective, AMS. In some cases, landowner constraints may be such that an RMS or AMS cannot be implemented quickly. In these situations, a "progressive planning approach" may be used to ultimately achieve planning and application of an RMS or AMS. Progressive planning is the incremental process of building a plan on part or all of the planning unit over a period of time. For additional details regarding CMS, RMS, and AMS, see Appendix 2A of this chapter.

It is recognized that implementation of this measure may increase the potential for movement of water and soluble pollutants through the soil profile to the ground water. It is not the intent of this measure to address a surface water problem at the expense of ground water. Erosion and sediment control systems can and should be designed to protect against the contamination of ground water. Ground-water protection will also be provided through implementation of the nutrient and pesticide management measures to reduce and control the application of nutrients and pesticides.

Operation and Maintenance

Continued performance of this measure will be ensured through supporting maintenance operations where appropriate. Since practices are designed to control a specific storm frequency, they may suffer damage when larger storms occur. It is expected that damage will be repaired after such storms and that practices will be inspected periodically. To ensure that practices selected to implement this measure will continue to function as designed and installed, some operational functions and maintenance will be necessary over the life of the practices.

Most structural practices for erosion and sediment control are designed to operate without human intervention. Management practices such as conservation tillage, however, do require "operation consideration" each time they are used. Field operations should be conducted with such practices in mind to ensure that they are not damaged or destroyed by the operations. For example, herbicides should not be applied to any practice that uses a permanent vegetative cover, such as waterways and filter strips.

Structural practices such as diversions, grassed waterways, and other practices that require grading and shaping may require repair to maintain the original design; reseeding may also be needed to maintain the original vegetative cover.

Trees and brush should not be allowed to grow on berms, dams, or other structural embankments. Cleaning of sediment retention basins will be needed to maintain their original design capacity and efficiency.

Filter strips and field borders must be maintained to prevent channelization of flow and the resulting short-circuiting of filtering mechanisms. Reseeding of filter strips may be required on a frequent basis.

3. Management Measure Selection

This management measure was selected based on an evaluation of available information that documents the beneficial effects of improved erosion and sediment control (see Section II.A.4 of this chapter). Specifically, the available information shows that erosion control practices can be used to greatly reduce the quantity of eroding soil on agricultural land, and that edge-of-field practices can effectively remove sediment from runoff before it leaves agricultural lands. The benefits of this management measure include significant reductions in the mass load of sediment and associated pollutants (e.g., phosphorus, some pesticides) entering waterbodies. By reducing the load of sediment leaving a field, downstream water uses can be maintained and improved.

Two options are provided under this management measure that represent best available technology for minimizing the delivery of sediment from agricultural lands to receiving waters. Different management strategies, are employed, however, with the options. The most desirable option is "(1)" since it not only minimizes the delivery of sediment to receiving waters, but also reduces erosion to provide an agronomic benefit. Option "(2)" minimizes the delivery of sediment to receiving waters, but does not necessarily provide the agronomic benefits of upland erosion control. By providing these two options, States are given the flexibility to address erosion and sediment problems in a manner that best reflects State and local needs and preferences.

By designing the measure to achieve contaminant load reduction objectives, the necessary mix of structural and management practices for a given site should not result in undue economic impact on the operator. Many of the practices that could be used to implement this measure may already be required by Federal, State, or local rules (e.g., filter strips or field borders along streams) or may otherwise be in use on agricultural fields. Since many producers may already be using systems that satisfy or partly satisfy the intent of this management measure, the only action that may be necessary will be to recognize the effectiveness of the existing practices and add additional practices, if needed. By building upon existing erosion and sediment control efforts, the time, effort, and cost of implementing this measure will be reduced.

4. Effectiveness Information

The effectiveness of management practices depends on several factors, including:

- The contaminant to be controlled;
- The types of practices or controls being considered; and
- Site-specific conditions.

Management practices or systems of practices must be designed for site-specific conditions to achieve desired effectiveness levels. Practice systems include combinations of practices that provide source control of the contaminant(s) as well as control or reductions in edge-of-field losses and delivery to receiving waters. Table 2-1 provides a gross estimate of practice effectiveness as reported in research literature. The actual effectiveness of a practice will depend exclusively on site-specific variables such as soil type, crop rotation, topography, tillage, and harvesting methods. Even within relatively small watersheds, extreme spatial and temporal variations are common. With this type of variation, the ranges of likely values associated with the reported observations in Table 2-1 are large.

**Table 2-1. Relative Gross Effectiveness^a of Sediment^b Control Measures
(Pennsylvania State University, 1992a)**

Practice Category ^c	Runoff ^d Volume	Total ^e Phosphorus (%)	Total ^e Nitrogen (%)	Sediment (%)
Reduced Tillage Systems ^f	—	45	55	75
Diversion Systems ^g	—	30	10	35
Terrace Systems ^h	—	70	20	85
Filter Strips ⁱ	—	75	70	65

^a Actual effectiveness depends on site-specific conditions. Values are not cumulative between practice categories.

^b Includes data where land application of manure has occurred.

^c Each category includes several specific types of practices.

^d - indicates reduction; + increase; 0 no change in surface runoff.

^e Total phosphorus includes total and dissolved phosphorus; total nitrogen includes organic-N, ammonia-N, and nitrate-N.

^f Includes practices such as conservation tillage, no-till, and crop residue use.

^g Includes practices such as grassed waterways and grade stabilization structures.

^h Includes several types of terraces with safe outlet structures where appropriate.

ⁱ Includes all practices that reduce contaminant losses using vegetative control methods.

The variability in the effectiveness of selected conservation practices that are frequently recommended by SCS in resource planning is illustrated in Table 2-2. This table can be used as a general guide for estimating the effects of these practices on water quality and quantity. The table references include additional site-specific information. Practice effects shown include changes in the water budget, sediment yield, and the movement of pesticides and nutrients. The impacts of variations in climate and soil conditions are accounted for to some extent through the presentation of effectiveness data for different soil-climate combinations. Data were not available for all soils and climates.

Data for the table were obtained from the research literature and include computer model simulation results. Values are reported as the percentage of change in the mass load of a given parameter that can be expected from installing the practice. Changes are determined versus a base condition of a rain-fed, nonleguminous, continuous, row crop (usually corn) that has been cultivated under conventional tillage.

Data from model studies are marked with an "M." For example, -27M indicates that the load reduction estimate of 27 percent is derived from a model simulation. Data obtained from plot studies using rainfall simulators are marked with an "S." For example, +15S indicates that the estimated load increase of 15 percent is based on a rainfall simulation study.

The range is reported in parentheses, followed by other reported values within the range, set off by commas. For example, (-32 to +10), -15, +5 denotes a range from a decrease of 32 percent to an increase of 10 percent, with intermediate reported changes of a 15 percent decrease and 5 percent increase. Some practices have a relatively wide range of values because of the variability in climate, soils, and management that occurs with these practices. Although some of the ranges are large, they can usually be attributed to small changes in very small quantities (thus the percentage change is great, yet the magnitude of change is small) or to the variability of site-specific conditions.

Table 2-2 contains the following information:

- Column (a) lists the practice and its SCS reporting code number.
- Column (b) lists the climate and a generalized soil classification for the site under consideration.
- Column (c) is the percentage change in surface runoff and deep percolation, components of the water budget, caused by the applied practice.
- Column (d) is the percentage change in sediment load caused by the applied practice.
- Column (e) is the percentage change in the phosphorus load. Two phases of phosphorus are considered: adsorbed and dissolved.
- Column (f) is the percentage change in the load of nitrogen in the adsorbed phase, nitrate in surface runoff, and nitrate in the leachate.
- Column (g) is the percentage change in the pesticide load. The phases of the pesticide listed are (1) strongly adsorbed in surface water, (2) weakly adsorbed in surface water, and (3) weakly adsorbed in the leachate.

5. Erosion and Sediment Control Management Practices

As discussed more fully at the beginning of this chapter and in Chapter 1, the following practices are described for illustrative purposes only. State programs need not require implementation of these practices. However, as a practical matter, EPA anticipates that the management measure set forth above generally will be implemented by applying one or more management practices appropriate to the source, location, and climate. The practices set forth below have been found by EPA to be representative of the types of practices that can be applied successfully to achieve the management measure described above.

Combinations of the following practices can be used to satisfy the requirements of this management measure. The SCS practice number and definition are provided for each management practice, where available. Also included in italics are SCS statements describing the effect each practice has on water quality (USDA-SCS, 1988).

- a. *Conservation cover (327): Establishing and maintaining perennial vegetative cover to protect soil and water resources on land retired from agricultural production.*

Agricultural chemicals are usually not applied to this cover in large quantities and surface and ground water quality may improve where these material are not used. Ground cover and crop residue will be increased with this practice. Erosion and yields of sediment and sediment related stream pollutants should decrease. Temperatures of the soil surface runoff and receiving water may be reduced. Effects will vary during the establishment period and include increases in runoff, erosion and sediment yield. Due to the reduction of deep percolation, the leaching of soluble material will be reduced, as will be the potential for causing saline seeps. Long-term effects of the practice would reduce agricultural nonpoint sources of pollution to all water resources.

- b. *Conservation cropping sequence (328): An adapted sequence of crops designed to provide adequate organic residue for maintenance or improvement of soil tilth.*

This practice reduces erosion by increasing organic matter, resulting in a reduction of sediment and associated pollutants to surface waters. Crop rotations that improve soil tilth may also disrupt disease, insect and weed reproduction cycles, reducing the need for pesticides. This removes or reduces the availability of some pollutants in the watershed. Deep percolation may carry soluble nutrients and pesticides to the ground water. Underlying soil

Table 2-2. Effects of Conservation Practices on Water Resource Parameters (USDA-SCS, 1988)

NOTE: Values in the tables are taken from published research, model simulations, and results of simulated rainfall plots. Both the range (in parentheses) and additional values within the range (after parentheses, separated by comma) are presented. The values describe the percentage change in mass loads caused by the use of the practice on a nonirrigated, nonlegume, continuous row crop that has been grown under conventional tillage. Values inside the range are shown behind the range values and are separated by commas (-30,-90), -76. Values from model simulation are marked by an M, e.g., -30M, and values from a rainfall simulator are marked with an S, e.g., -29S. Few data are available for arid conditions and that zone is not included in the table. Not all soil-climate combinations have available reference data. A minus is a decreased value; a plus is an increase.

(a) Practice and Number	(b) Climate and Soil	(c) Water Budget (% Change)		(d) Sediment Yield (% Change)	(e) Phosphorus (% Change)		(f) Nitrogen (% Change)			(g) Pesticides (% Change)		
		Surface Runoff	Deep Percolation		Sediment	Runoff	Nitrogen Adsorbed Phases	Nitrate in Surface Runoff	Nitrate in Percolate	Strongly Adsorbed SW ^b	Weakly Adsorbed Leachate	Weakly Adsorbed SW ^b
Contour Farming 330	H-S ^a											
	-											
	Sandy	(-65,-75)	#	(-20,-50)	-20	-10	-15	-5	#	#	#	#
	Silty	(-60,-40)	+10	(-65,-30)	(-60,-65)	(-60,-65)	(-45,-54)	(-25,-72),-	+10,+7	#	#	#
	Clayey	(-19,-20)	+5	(-29,-55)	-55	-20	-55	40	+10	#	#	#
								(-12,-25)				
	SA-S ^a											
	-											
	Silty	(-27,-59)	#	(-22,-59)	#	#	#	#	#	#	#	#
	Clayey	-54	#	-26	#	#	#	#	+10	#	#	#
	H ^a											
	-											
	Sandy	-30	+10	-60	-60	-30	-60	-35	+10	#	#	#
	Silty	-16	#	(-30,-48)	#	#	#	(-25,-41)	+6	#	#	#
	Clayey	(-17,-29)	#	#	#	#	#	-12	+7	#	#	#
SA ^a												
-												
Clayey	-15	#	#	#	#	#	#	#	#	#	#	
Strip- Cropping Contour 585	H-S ^a											
	-											
	Silty	-5M	+9M	(-37,90M),-49	-80M	-86M	-81M	-43M	+158M	#	#	0,+6
	Clayey	-28M	+366M ^a	-89M	-52M	-89M	-51M	-26M	+220M ^a	#	#	#
Sandy	No change	No change	-99M	-99M	-99M	-98M	-39M	+12M	#	#	#	

Table 2-2. (Continued)

(a) Practice and Number	(b) Climate and Soil	(c) Water Budget (% Change)		(d) Sediment Yield (% Change)	(e) Phosphorus (% Change)		(f) Nitrogen (% Change)			(g) Pesticides (% Change)		
		Surface Runoff	Deep Percolation		Sediment	Runoff	Nitrogen Adsorbed Phases	Nitrate in Surface Runoff	Nitrate in Percolate	Strongly Adsorbed SW ^b	Weakly Adsorbed Leachate	Weakly Adsorbed SW ^b
Cons. Tillage- No Till 329	H ^a - Clayey Silty	(-33,+48) ^u (-91,+36) ^u	# No change	(-73M,-82) (-75,-99)	-53M (-64,-95)	-30M (+900,-22) ^c	-53M (-60,-94)	-11 (-42,+800)	(-49M,+8) (8M,+16)	# -78	# (+5M,-50)	-51M
	Sandy ^d	(-26M,-88),- 61	#	(-66M,-99S)	(-51,-87S)	(0,+155)	(-69s,-90s)	(-67,-80)	1,+8 ^c 0	#	#	#
	SA-S ^a - Silty				^u -72s,-82		-72,-70	-42s,-45	^o			
	Silty	+36	#	-96	(-80,-90)	+138	(-50,-90),- 60	(0,+45)	+2	#	#	#
	H-S ^a - Silty	(-21,-90)	#	(-88,-99)	(-75,-90)	(+450,+160 0)	#	#	#	(-75,-90)	#	+500
Cons. Tillage (Other types) 329	H-S ^a - Silty	(-15,-73) -51,-20	+5	(-43,+95) -85,-55	-90,-84	+1850,+17 50 ^c	-91,-82	+1800,+95 0 ^c	#	#	#	#
	Clayey	-30	+10	-70	#	#	#	#	#	#	#	#
	SA-S ^a - Silty	-54	#	#	#	#	#	#	#	#	#	#
	Clayey	(-29,-89)	+10	(-70,-42)	#	#	#	#	#	#	#	#
	H ^a - Sandy	(-40,-89)	+5	(-40,-66)	-91	-3	-95	-88	#	#	#	#
	Silty	(-20,-26)	#	(-49,-61)	#	#	#	#	#	(-69,-51)	#	(+15,+27)
	Clayey	(-10,-61),- 20	+10	(-29,-86) -34,-41	#	#	#	#	#	(-33M,-2)	#	(+60M,-2)

Table 2-2. (Continued)

(a) Practice and Number	(b) Climate and Soil	(c) Water Budget (% Change)		(d) Sediment Yield (% Change)	(e) Phosphorus (% Change)		(f) Nitrogen (% Change)			(g) Pesticides (% Change)		
		Surface Runoff	Deep Percolation		Sediment	Runoff	Nitrogen Adsorbed Phases	Nitrate in Surface Runoff	Nitrate in Percolate	Strongly Adsorbed SW ^b	Weakly Adsorbed Leachate	Weakly Adsorbed SW ^b
SA ^a												
-												
Silty		(-16,-25),-	#	(-38,-92),-69	#	#	#	#	#	(-38,-81)	#	+63,+27
Sandy		20	#	-45	#	#	#	#	#	#	#	#
Clayey		-31 -88M	#	-90M	#	#	#	Not sig.	#	#	#	#
Terraces with Under-ground Outlets 600												
H-S ^a												
-												
Sandy		-14	#	(-95,-98)	#	#	#	#	#	#	#	#
Silty		(-24,-60)	(+12,+500) ^c	(-87,-95)	-95	-60	-95	(-70,+55) ^u	+15	#	#	#
Clayey		(-30,-36)	(+5,+380) ^c	(-90,-95)	#	-30	-95	-30	+10	#	#	#
SA-S ^a												
-												
Sandy		-14M	+67M	(-95,-98)	-99M	-42M	-99M	-42M	+20M	#	#	(-73,-91M)
Silty		(-73,+43M)	+162M	(-95,-92M)	-97M	-72M	-97M	-78M	+37M	#	#	(-84,-91M)
Clayey		(-15,-36M)	(+5,+293M) ^c	(-95,-91M)	-96M	-65M	-96M	-91M	(10 to high values)			(-69M,-78M)
WASCOB ^f H ^a												
638												
Sandy		-40	+15	(-95,-99)	#	-40	-95	-50	+15	#	#	#
Silty		(-88,-42)	#	(-95,-50),-86	#	-71	-95	(-86,-44)	+8	#	#	-4
Clayey		#	#	(-90,-95)	#	#	#	#	#	#	#	#
SA ^a												
-												
Sandy		#	#	(-95,-98)	#	#	#	#	#	#	#	#
Silty		-73	#	-95	-73	+58 ^c	#	-50	#	#	#	#
Clayey		-30	+5	(-90,-95)	#	#	#	#	#	#	#	#

^a Climatic conditions: H-S = Humid - Snow; H = Humid; SAS = Semi-Arid - Snow; and SA = Semi-Arid.

^b SW = Surface Water.

^c Measured values were small numbers; percentage change may have large values.

^d Data have scattered values.

^e Measured values were large numbers.

^f Water and Sediment Control Basin

^u = Unknown, site-dependent, or conflicting values.

= No reported value.

layers, rock and unconsolidated parent material may block, delay, or enhance the delivery of these pollutants to ground water. The fate of these pollutants will be site specific, depending on the crop management, the soil and geologic conditions.

- c. **Conservation tillage (329):** Any tillage or planting system that maintains at least 30 percent of the soil surface covered by residue after planting to reduce soil erosion by water; or, where soil erosion by wind is the primary concern, maintains at least 1,000 pounds of flat, small-grain residue equivalent on the surface during the critical erosion period.

This practice reduces soil erosion, detachment and sediment transport by providing soil cover during critical times in the cropping cycle. Surface residues reduce soil compaction from raindrops, preventing soil sealing and increasing infiltration. This action may increase the leaching of agricultural chemicals into the ground water.

In order to maintain the crop residue on the surface it is difficult to incorporate fertilizers and pesticides. This may increase the amount of these chemicals in the runoff and cause more surface water pollution.

The additional organic material on the surface may increase the bacterial action on and near the soil surface. This may tie-up and then breakdown many pesticides which are surface applied, resulting in less pesticide leaving the field. This practice is more effective in humid regions.

With a no-till operation the only soil disturbance is the planter shoe and the compaction from the wheels. The surface applied fertilizers and chemicals are not incorporated and often are not in direct contact with the soil surface. This condition may result in a high surface runoff of pollutants (nutrient and pesticides). Macropores develop under a no-till system. They permit deep percolation and the transmittal of pollutants, both soluble and insoluble to be carried into the deeper soil horizons and into the ground water.

Reduced tillage systems disrupt or break down the macropores, incidentally incorporate some of the materials applied to the soil surface, and reduce the effects of wheeltrack compaction. The results are less runoff and less pollutants in the runoff.

- d. **Contour farming (330):** Farming sloping land in such a way that preparing land, planting, and cultivating are done on the contour. This includes following established grades of terraces or diversions.

This practice reduces erosion and sediment production. Less sediment and related pollutants may be transported to the receiving waters.

Increased infiltration may increase the transportation potential for soluble substances to the ground water.

- e. **Contour orchard and other fruit area (331):** Planting orchards, vineyards, or small fruits so that all cultural operations are done on the contour.

Contour orchards and fruit areas may reduce erosion, sediment yield, and pesticide concentration in the water lost. Where inward sloping benches are used, the sediment and chemicals will be trapped against the slope. With annual events, the bench may provide 100 percent trap efficiency. Outward sloping benches may allow greater sediment and chemical loss. The amount of retention depends on the slope of the bench and the amount of cover. In addition, outward sloping benches are subject to erosion from runoff from benches immediately above them. Contouring allows better access to rills, permitting maintenance that reduces additional erosion. Immediately after establishment, contour orchards may be subject to erosion and sedimentation in excess of the now contoured orchard. Contour orchards require more fertilization and pesticide application than did the native grasses that frequently covered the slopes before orchards were started. Sediment leaving the site may carry more adsorbed nutrients and pesticides than did the sediment before the benches were established from uncultivated slopes. If contoured orchards

replace other crop or intensive land use, the increase or decrease in chemical transport from the site may be determined by examining the types and amounts of chemicals used on the prior land use as compared to the contour orchard condition.

Soluble pesticides and nutrients may be delivered to and possibly through the root zone in an amount proportional to the amount of soluble pesticides applied, the increase in infiltration, the chemistry of the pesticides, organic and clay content of the soil, and amounts of surface residues. Percolating water below the root zone may carry excess solutes or may dissolve potential pollutants as they move. In either case, these solutes could reach ground water supplies and/or surface downslope from the contour orchard area. The amount depends on soil type, surface water quality, and the availability of soluble material (natural or applied).

- f. **Cover and green manure crop (340):** A crop of close-growing grasses, legumes, or small grain grown primarily for seasonal protection and soil improvement. It usually is grown for 1 year or less, except where there is permanent cover as in orchards.

Erosion, sediment and adsorbed chemical yields could be decreased in conventional tillage systems because of the increased period of vegetal cover. Plants will take up available nitrogen and prevent its undesired movement. Organic nutrients may be added to the nutrient budget reducing the need to supply more soluble forms. Overall volume of chemical application may decrease because the vegetation will supply nutrients and there may be allelopathic effects of some of the types of cover vegetation on weeds. Temperatures of ground and surface waters could slightly decrease.

- g. **Critical area planting (342):** Planting vegetation, such as trees, shrubs, vines, grasses, or legumes, on highly erodible or critically eroding areas (does not include tree planting mainly for wood products).

This practice may reduce soil erosion and sediment delivery to surface waters. Plants may take up more of the nutrients in the soil, reducing the amount that can be washed into surface waters or leached into ground water.

During grading, seedbed preparation, seeding, and mulching, large quantities of sediment and associated chemicals may be washed into surface waters prior to plant establishment.

- h. **Crop residue use (344):** Using plant residues to protect cultivated fields during critical erosion periods.

When this practice is employed, raindrops are intercepted by the residue reducing detachment, soil dispersion, and soil compaction. Erosion may be reduced and the delivery of sediment and associated pollutants to surface water may be reduced. Reduced soil sealing, crusting and compaction allows more water to infiltrate, resulting in an increased potential for leaching of dissolved pollutants into the ground water.

Crop residues on the surface increase the microbial and bacterial action on or near the surface. Nitrates and surface-applied pesticides may be tied-up and less available to be delivered to surface and ground water. Residues trap sediment and reduce the amount carried to surface water. Crop residues promote soil aggregation and improve soil tilth.

- i. **Delayed seed bed preparation (354):** Any cropping system in which all of the crop residue and volunteer vegetation are maintained on the soil surface until approximately 3 weeks before the succeeding crop is planted, thus shortening the bare seedbed period on fields during critical erosion periods.

The purpose is to reduce soil erosion by maintaining soil cover as long as practical to minimize raindrop splash and runoff during the spring erosion period. Other purposes include moisture conservation, improved water quality, increased soil infiltration, improved soil tilth, and food and cover for wildlife.

- j. *Diversion (362): A channel constructed across the slope with a supporting ridge on the lower side (Figure 2-3).*

This practice will assist in the stabilization of a watershed, resulting in the reduction of sheet and rill erosion by reducing the length of slope. Sediment may be reduced by the elimination of ephemeral and large gullies. This may reduce the amount of sediment and related pollutants delivered to the surface waters.

- k. *Field border (386): A strip of perennial vegetation established at the edge of a field by planting or by converting it from trees to herbaceous vegetation or shrubs.*

This practice reduces erosion by having perennial vegetation on an area of the field. Field borders serve as "anchoring points" for contour rows, terraces, diversions, and contour strip cropping. By elimination of the practice of tilling and planting the ends up and down slopes, erosion from concentrated flow in furrows and long rows may be reduced. This use may reduce the quantity of sediment and related pollutants transported to the surface waters.

- l. *Filter strip (393): A strip or area of vegetation for removing sediment, organic matter, and other pollutants from runoff and wastewater.*

Filter strips for sediment and related pollutants meeting minimum requirements may trap the coarser grained sediment. They may not filter out soluble or suspended fine-grained materials. When a storm causes runoff in excess When the field borders are located such that runoff flows across them in sheet flow, they may cause the deposition of sediment and prevent it from entering the surface water. Where these practice are between cropland and a stream



Figure 2-3. Diversion (USDA-SCS, 1984).

or water body, the practice may reduce the amount of pesticide application drift from entering the surface water of the design runoff, the filter may be flooded and may cause large loads of pollutants to be released to the surface water. This type of filter requires high maintenance and has a relatively short service life and is effective only as long as the flow through the filter is shallow sheet flow.

Filter strips for runoff from concentrated livestock areas may trap organic material, solids, materials which become adsorbed to the vegetation or the soil within the filter. Often they will not filter out soluble materials. This type of filter is often wet and is difficult to maintain.

Filter strips for controlled overland flow treatment of liquid wastes may effectively filter out pollutants. The filter must be properly managed and maintained, including the proper resting time. Filter strips on forest land may trap coarse sediment, timbering debris, and other deleterious material being transported by runoff. This may improve the quality of surface water and has little effect on soluble material in runoff or on the quality of ground water.

All types of filters may reduce erosion on the area on which they are constructed.

Filter strips trap solids from the runoff flowing in sheet flow through the filter. Coarse-grained and fibrous materials are filtered more efficiently than fine-grained and soluble substances. Filter strips work for design conditions, but when flooded or overloaded they may release a slug load of pollutants into the surface water.

- m. **Grade stabilization structure (410):** A structure used to control the grade and head cutting in natural or artificial channels.

Where reduced stream velocities occur upstream and downstream from the structure, streambank and streambed erosion will be reduced. This will decrease the yield of sediment and sediment-attached substances. Structures that trap sediment will improve downstream water quality. The sediment yield change will be a function of the sediment yield to the structure, reservoir trap efficiency and of velocities of released water. Ground water recharge may affect aquifer quality depending on the quality of the recharging water. If the stored water contains only sediment and chemical with low water solubility, the ground water quality should not be affected.

- n. **Grassed waterway (412):** A natural or constructed channel that is shaped or graded to required dimensions and established in suitable vegetation for the stable conveyance of runoff.

This practice may reduce the erosion in a concentrated flow area, such as in a gully or in ephemeral gullies. This may result in the reduction of sediment and substances delivered to receiving waters. Vegetation may act as a filter in removing some of the sediment delivered to the waterway, although this is not the primary function of a grassed waterway.

Any chemicals applied to the waterway in the course of treatment of the adjacent cropland may wash directly into the surface waters in the case where there is a runoff event shortly after spraying.

When used as a stable outlet for another practice, waterways may increase the likelihood of dissolved and suspended pollutants being transported to surface waters when these pollutants are delivered to the waterway.

- o. **Grasses and legumes in rotation (411):** Establishing grasses and legumes or a mixture of them and maintaining the stand for a definite number of years as part of a conservation cropping system.

Reduced runoff and increased vegetation may lower erosion rates and subsequent yields of sediment and sediment-attached substances. Less applied nitrogen may be required to grow crops because grasses and legumes will supply organic nitrogen. During the period of the rotation when the grasses and legumes are growing, they will take up more phosphorus. Less pesticides may similarly be required with this practice. Downstream water temperatures may be lower depending on the season when this practice is applied. There will be a greater opportunity for animal

waste management on grasslands because manures and other wastes may be applied for a longer part of the crop year.

- p. **Sediment basins (350):** Basins constructed to collect and store debris or sediment.

Sediment basins will remove sediment, sediment associated materials and other debris from the water which is passed on downstream. Due to the detention of the runoff in the basin, there is an increased opportunity for soluble materials to be leached toward the ground water.

- q. **Contour stripcropping (585):** Growing crops in a systematic arrangement of strips or bands on the contour to reduce water erosion.

The crops are arranged so that a strip of grass or close-growing crop is alternated with a strip of clean-tilled crop or fallow or a strip of grass is alternated with a close-growing crop (Figure 2-4).

This practice may reduce erosion and the amount of sediment and related substances delivered to the surface waters. The practice may increase the amount of water which infiltrates into the root zone, and, at the time there is an overabundance of soil water, this water may percolate and leach soluble substances into the ground water.

- r. **Field strip-cropping (586):** Growing crops in a systematic arrangement of strips or bands across the general slope (not on the contour) to reduce water erosion.

The crops are arranged so that a strip of grass or a close-growing crop is alternated with a clean-tilled crop or fallow.

This practice may reduce erosion and the delivery of sediment and related substances to the surface waters. The practice may increase infiltration and, when there is sufficient water available, may increase the amount of leachable pollutants moved toward the ground water.

Since this practice is not on the contour there will be areas of concentrated flow, from which detached sediment, adsorbed chemicals and dissolved substances will be delivered more rapidly to the receiving waters. The sod strips will not be efficient filter areas in these areas of concentrated flow.

- s. **Terrace (600):** An earthen embankment, a channel, or combination ridge and channel constructed across the slope (Figures 2-5 and 2-6).

This practice reduces the slope length and the amount of surface runoff which passes over the area downslope from an individual terrace. This may reduce the erosion rate and production of sediment within the terrace interval. Terraces trap sediment and reduce the sediment and associated pollutant content in the runoff water which enhance surface water quality. Terraces may intercept and conduct surface runoff at a nonerosive velocity to stable outlets, thus, reducing the occurrence of ephemeral and classic gullies and the resulting sediment. Increases in infiltration can cause a greater amount of soluble nutrients and pesticides to be leached into the soil. Underground outlets may collect highly soluble nutrient and pesticide leachates and convey runoff and conveying it directly to an outlet, terraces may increase the delivery of pollutants to surface waters. Terraces increase the opportunity to leach salts below the root zone in the soil. Terraces may have a detrimental effect on water quality if they concentrate and accelerate delivery of dissolved or suspended nutrient, salt, and pesticide pollutants to surface or ground waters.

- t. **Water and sediment control basin (638):** An earthen embankment or a combination ridge and channel generally constructed across the slope and minor watercourses to form a sediment trap and water detention basin.

Contour strip cropping systems can involve up to 10 strips in a field. A strip cropping system could involve the following:

Corn (either for grain and/or silage)

Soybeans

1st year Meadow

Established Meadow (2-4 years)

Oats

Grassed waterway or diversion

Tillage systems may include two kinds in the same year such as chisel plowing for the for crop and moldboard plowing for the oats.

See the following figure showing typical patterns of stripcropping.

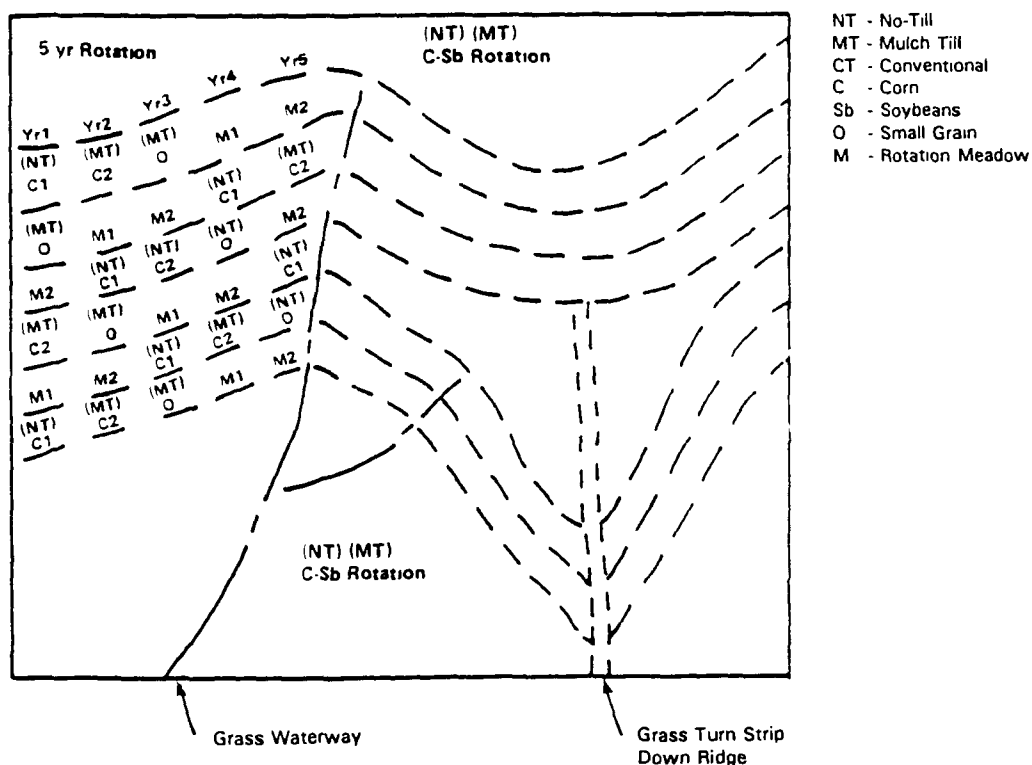

Figure 2-4. Strip-cropping and rotations (USDA-ARS, 1987).

The practice traps and removes sediment and sediment-attached substances from runoff. Trap control efficiencies for sediment and total phosphorus, that are transported by runoff, may exceed 90 percent in silt loam soils. Dissolved substances, such as nitrates, may be removed from discharge to downstream areas because of the increased infiltration. Where geologic condition permit, the practice will lead to increased loadings of dissolved substances toward ground water. Water temperatures of surface runoff, released through underground outlets, may increase slightly because of longer exposure to warming during its impoundment.

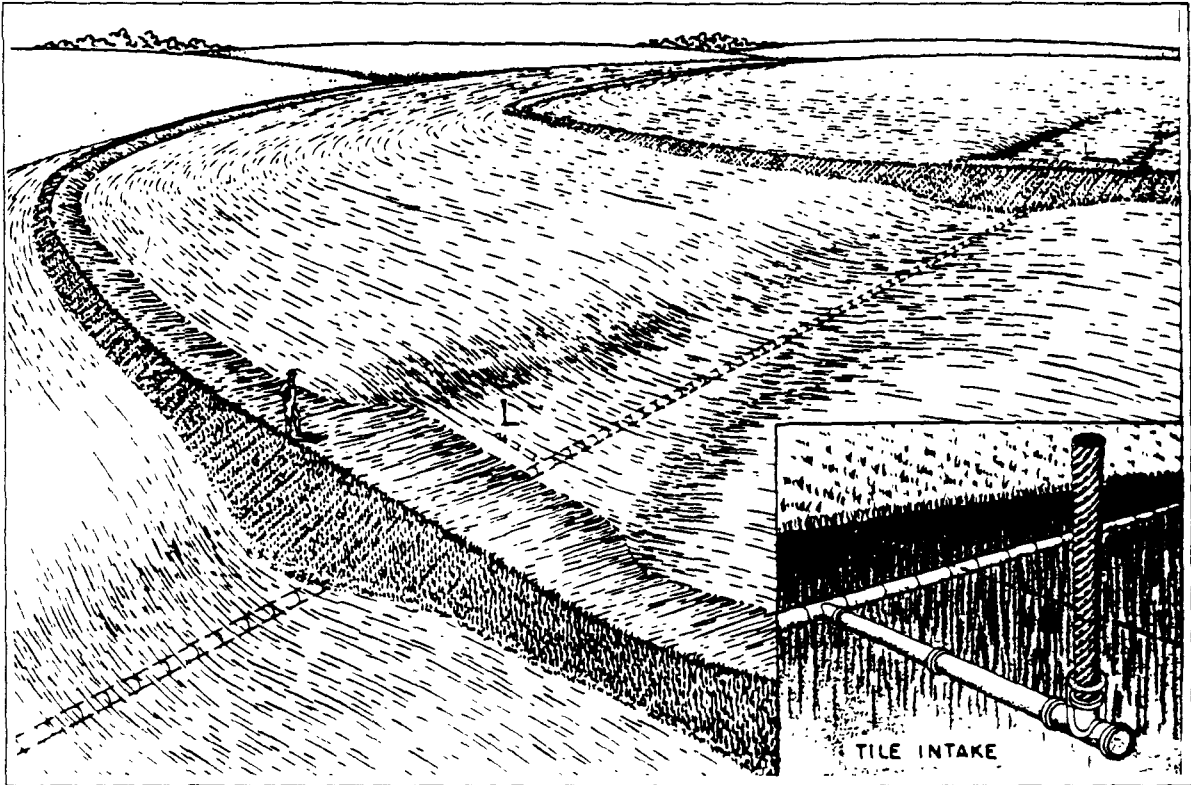

Figure 2-5. Gradient terraces with tile outlets (USDA-SCS, 1984).

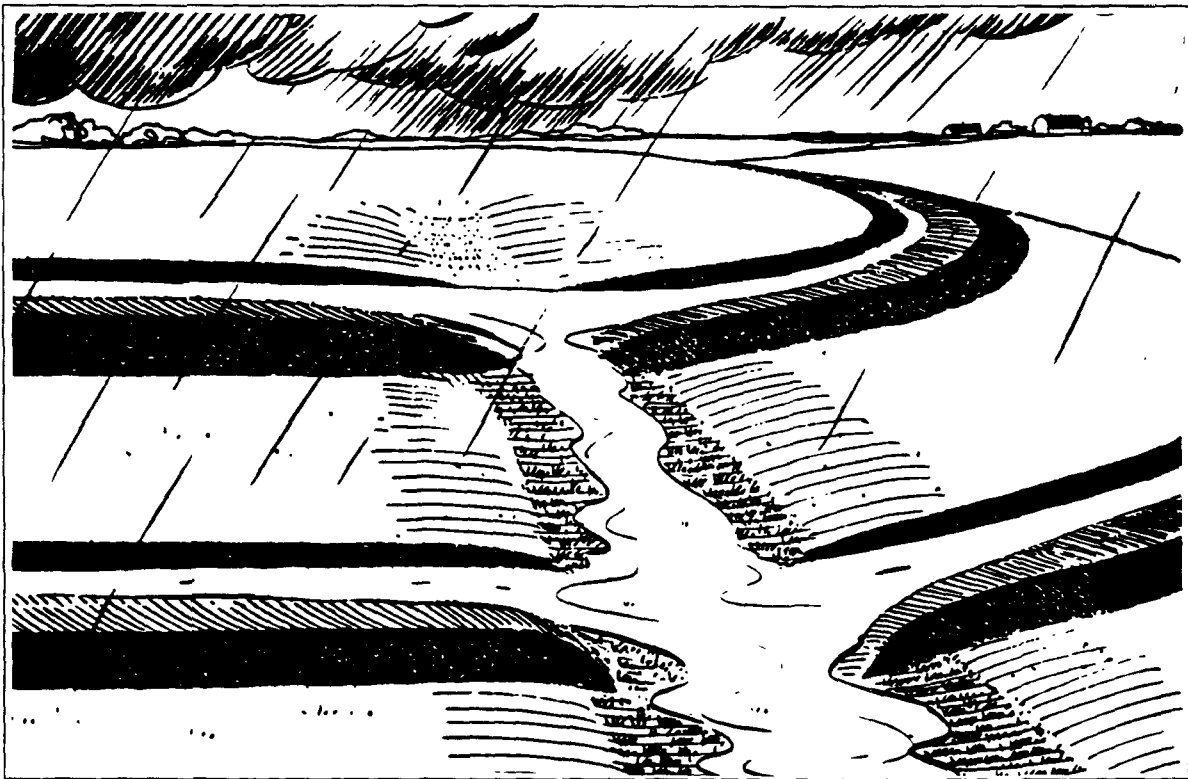

Figure 2-6. Gradient terraces with waterway outlet (USDA-SCS, 1984).

u. Wetland and riparian zone protection

Wetland and riparian zone protection practices are described in Chapter 7.

6. Cost Information

Both national and selected State costs for a number of common erosion control practices are presented in Tables 2-3 through 2-7. The variability in costs for practices can be accounted for primarily through differences in site-specific applications and costs, differences in the reporting units used, and differences in the interpretation of reporting units.

The cost estimates for control of erosion and sediment transport from agricultural lands in Table 2-8 are based on experiences in the Chesapeake Bay Program, but are illustrative of the costs that could be incurred in coastal areas across the Nation. It is important to note that for some practices, such as conservation tillage, the net costs often approach zero and in some cases can be negative because of the savings in labor and energy.

The annual cost of operation and maintenance is estimated to range from zero to 10 percent of the investment cost (USDA-SCS-Michigan, 1988).

Table 2-3. Cost of Diversions

Location	Year	Unit	Reported Capital Costs (\$/unit)	Constant Dollar Capital Costs (\$/unit) ^a	Reference
National	1985	ac	49.45	61.8	Barbarika, 1987.
North Carolina	1980	ac	120.00	164.35	NCAES, 1982
Maryland	1991	ft	3.12	3.12	Sanders et al., 1991.
Maryland	1987	ft	2.25	2.89	Smolen and Humenik, 1989.
Michigan	1981	ft	3.75	4.79	Smolen and Humenik, 1989.
Wisconsin	1987	ft	1.57	2.02	Smolen and Humenik, 1989.
Minnesota	1987	ft	1.43	1.84	Smolen and Humenik, 1989.
Virginia	1987	ft	1.33	1.71	Smolen and Humenik, 1989.

^a Reported costs inflated to 1991 dollars by the ratio of indices of prices paid by farmers for all production items, 1977=100. Diversion lifetime is expected to be 10 years, but costs are not annualized.

Table 2-4. Cost of Terraces

Location	Year	Unit	Reported Capital Costs (\$/unit)	Constant Dollar Capital Costs (\$/unit) ^a	Reference
National	1985	ac	91.43	114.44	Barbarika, 1987.
Alabama	1982	a.s.	45.00	55.58	Russell and Christensen, 1984.
Florida	1982	a.s.	40.00	49.41	Russell and Christensen, 1984.
Georgia	1982	a.s.	39.00	48.18	Russell and Christensen, 1984.
North Carolina	1982	a.s.	47.00	58.06	Russell and Christensen, 1984.
South Carolina	1982	a.s.	17.00	21.00	Russell and Christensen, 1984.
Virginia	1982	a.s.	39.00	48.18	Russell and Christensen, 1984.
Wisconsin	1987	ft	10.00	12.86	Smolen and Humenik, 1989.
Minnesota	1987	ft	2.25	2.89	Smolen and Humenik, 1989.

a.s. = acres served

^a Reported costs inflated to 1991 dollars by the ratio of indices of prices paid by farmers for all production items, 1977=100. Terrace lifetime is expected to be 10 years, but costs are not annualized.

Table 2-5. Cost of Waterways

Location	Year	Unit	Reported Capital Costs (\$/unit)	Constant Dollar Capital Costs (\$/unit) ^a	Reference
National	1985	ac	94.22	117.93	Barbarika, 1987.
Michigan	1981	ac	150.00	191.55	Smolen and Humenik, 1989.
Wisconsin	1987	ac	2880.00	3702.86	Smolen and Humenik, 1989.
North Carolina	1980	ac	72.00	98.61	NCAES, 1982.
Alabama	1982	a.e.	1088.00	1344.00	Russell and Christensen, 1984.
Florida	1982	a.e.	1026.00	1267.41	Russell and Christensen, 1984.
Georgia	1982	a.e.	880.00	1087.06	Russell and Christensen, 1984.
North Carolina	1982	a.e.	1232.00	1521.88	Russell and Christensen, 1984.
South Carolina	1982	a.e.	1442.00	1781.29	Russell and Christensen, 1984.
Virginia	1982	a.e.	1530.00	1890.00	Russell and Christensen, 1984.
Maryland	1991	ft	5.11	5.11	Sanders et al, 1991.
Maryland	1987	ft	6.00	7.71	Smolen and Humenik, 1989.

a.e. = acres established

^a Reported costs inflated to 1991 dollars by the ratio of indices of prices paid by farmers for all production items, 1977=100. Waterway lifetime is expected to be 10 years, but costs are not annualized.

Table 2-6. Cost of Permanent Vegetative Cover

Location	Year	Unit	Constant Dollar		Reference
			Reported Capital Costs (\$/unit)	Capital Costs (\$/unit) ^a	
National	1985	ac	48.10	60.20	Barbarika, 1987.
Maryland	1991	ac	235.48	235.48	Sanders et al., 1991.
Maryland	1987	ac	120.00	154.29	Smolen and Humenik, 1989.
Michigan	1981	ac	62.50	79.81	Smolen and Humenik, 1989.
Wisconsin	1987	ac	70.00	90.00	Smolen and Humenik, 1989.
Minnesota	1987	ac	233.00	299.57	Smolen and Humenik, 1989.
Virginia	1987	ac	133.00	171.00	Smolen and Humenik, 1989.
Alabama	1982	ac	98.78	122.02	Russell and Christensen, 1984.
Florida	1982	ac	98.24	121.36	Russell and Christensen, 1984.
Georgia	1982	ac	98.52	121.70	Russell and Christensen, 1984.
North Carolina	1982	ac	73.74	91.09	Russell and Christensen, 1984.
South Carolina	1982	ac	121.54	150.14	Russell and Christensen, 1984.
Virginia	1982	ac	101.36	125.21	Russell and Christensen, 1984.

^a Reported costs inflated to 1991 dollars by the ratio of indices of prices paid by farmers for all production items, 1977=100. Permanent vegetative cover lifetime is expected to be 10 years, but costs are not annualized.

Table 2-7. Cost of Conservation Tillage

Location	Year	Unit	Constant Dollar		Reference
			Reported Capital Costs (\$/unit)	Capital Costs (\$/unit) ^a	
Maryland	1987	ac	18.00	21.99	Smolen and Humenik, 1989.
Michigan	1987	ac	6.75	8.25	Smolen and Humenik, 1989.
Wisconsin	1981	ac	27.55	42.65	Smolen and Humenik, 1989.
Minnesota	1987	ac	13.40	16.37	Smolen and Humenik, 1989.
Virginia	1987	ac	29.30	35.79	Smolen and Humenik, 1989.
North Carolina	1980	ac	10.00	17.12	NCAES, 1982.
Alabama	1982	ac ^b	19.00	26.84	Russell and Christensen, 1984.
Florida	1982	ac ^b	39.00	55.09	Russell and Christensen, 1984.
Georgia	1982	ac ^b	33.00	46.61	Russell and Christensen, 1984.
North Carolina	1982	ac ^b	12.00	16.95	Russell and Christensen, 1984.
South Carolina	1982	ac ^b	27.00	38.14	Russell and Christensen, 1984.
Virginia	1982	ac ^b	16.00	22.60	Russell and Christensen, 1984.

^a Reported costs inflated to 1991 dollars by the ratio of indices of prices paid by farmers for other machinery, 1977=100. Conservation tillage lifetime is expected to be 10 years, but costs are not annualized.

^b Per acre of planting and herbicides.

Table 2-8. Annualized Cost Estimates for Selected Management Practices from Chesapeake Bay Installations^a (Camacho, 1991)

Practice	Practice Life Span (Years)	Median Annual Costs ^b (EAC ^c)/(\$/acre/yr)
Nutrient Management	3	2.40
Strip-cropping	5	11.60
Terraces	10	84.53
Diversions	10	52.09
Sediment Retention Water Control Structures	10	89.22
Grassed Filter Strips	5	7.31
Cover Crops	1	10.00
Permanent Vegetative Cover on Critical Areas	5	70.70
Conservation Tillage ^d	1	17.34
Reforestation of Crop and Pasture ^d	10	46.66
Grassed Waterways ^e	10	1.00/LF/yr
Animal Waste System ^f	10	3.76/ton/yr

^a Median costs (1990 dollars) obtained from the Chesapeake Bay Program Office (CBPO) BMP tracking data base and Chesapeake Bay Agreement Jurisdictions' unit data cost. Costs per acre are for acres benefited by the practice.

^b Annualized BMP total cost including O&M, planning, and technical assistance costs.

^c EAC = Equivalent annual cost: annualized total costs for the life span. Interest rate = 10%.

^d Government incentive costs.

^e Annualized unit cost per linear foot of constructed waterway.

^f Units for animal waste are given as \$/ton of manure treated.

B1. Management Measure for Facility Wastewater and Runoff from Confined Animal Facility Management (Large Units)

Limit the discharge from the confined animal facility to surface waters by:

- (1) Storing both the facility wastewater *and* the runoff from confined animal facilities that is caused by storms up to and including a 25-year, 24-hour frequency storm. Storage structures should:
 - (a) Have an earthen lining or plastic membrane lining, or
 - (b) Be constructed with concrete, or
 - (c) Be a storage tank;

and
- (2) Managing stored runoff and accumulated solids from the facility through an appropriate waste utilization system.

1. Applicability

This management measure is intended for application by States to all new facilities regardless of size and to all new or existing confined animal facilities that contain the following number of head or more:

	<u>Head</u>	<u>Animal Units²</u>
Beef Feedlots	300	300
Stables (horses)	200	400
Dairies	70	98
Layers	15,000	150 ³ 495 ⁴
Broilers	15,000	150 ³ 495 ⁴
Turkeys	13,750	2,475
Swine	200	80

except those facilities that are required by Federal regulation 40 CFR 122.23 to apply for and receive discharge permits. That section applies to "concentrated animal feeding operations," which are defined in 40 CFR Part 122, Appendix B. In addition, 40 CFR 122.23(c) provides that the Director of an NPDES discharge permit program may designate any animal feeding operation as a concentrated animal feeding operation (which has the effect of subjecting

² See *animal unit* in Glossary.

³ If facility has a liquid manure system, as used in 40 CFR Section 122, Appendix B.

⁴ If facility has continuous overflow watering, as used in 40 CFR Section 122, Appendix B.

the operation to the NPDES permit program requirements) upon determining that it is a significant contributor of water pollution. In such cases, upon issuance of a permit, the terms of the permit apply and this management measure ceases to apply.

Under the Coastal Zone Act Reauthorization Amendments, States are subject to a number of requirements as they develop coastal nonpoint programs in conformity with this measure and will have some flexibility in doing so. The application of management measures by States is described more fully in *Coastal Nonpoint Pollution Control Program: Program Development and Approval Guidance*, published jointly by the U.S. Environmental Protection Agency (EPA) and the National Oceanic and Atmospheric Administration (NOAA) of the U.S. Department of Commerce.

A *confined animal facility* is a lot or facility (other than an aquatic animal production facility) where the following conditions are met:

- Animals (other than aquatic animals) have been, are, or will be stabled or confined and fed or maintained for a total of 45 days or more in any 12-month period, and
- Crops, vegetation forage growth, or post-harvest residues are not sustained in the normal growing season over any portion of the lot or facility.

Two or more animal facilities under common ownership are considered, for the purposes of these guidelines, to be a single animal facility if they adjoin each other or if they use a common area or system for the disposal of wastes.

Confined animal facilities, as defined above, include areas used to grow or house the animals, areas used for processing and storage of product, manure and runoff storage areas, and silage storage areas.

Facility wastewater and runoff from confined animal facilities are to be controlled under this management measure (Figure 2-7). Runoff includes any precipitation (rain or snow) that comes into contact with any manure, litter, or bedding. Facility wastewater is water discharged in the operation of an animal facility as a result of any or all of the following: animal or poultry watering; washing, cleaning, or flushing pens, barns, manure pits, or other animal facilities; washing or spray cooling of animals; and dust control.

2. Description

The problems associated with animal facilities result from runoff, facility wastewater, and manure. For additional information regarding problems, see Section I.F.3 of this chapter.

Application of this management measure will greatly reduce the volume of runoff, manure, and facility wastewater reaching a waterbody, thereby improving water quality and the use of the water resource. The measure can be implemented by using practices that divert runoff water from upslope sites and roofs away from the facility, thereby minimizing the amount of water to be stored and managed. Runoff water and facility wastewater should be routed through a settling structure or debris basin to remove solids, and then stored in a pit, pond, or lagoon for application on agricultural land (Figure 2-8). If manure is managed as a liquid, all manure, runoff, and facility wastewater can be stored in the same structure and there is no need for a debris basin.

For new facilities and expansions to existing facilities, consideration should be given to siting the facility:

- Away from surface waters;
- Away from areas with high leaching potential; and
- In areas where adequate land is available to apply animal wastes in accordance with the nutrient management measure.

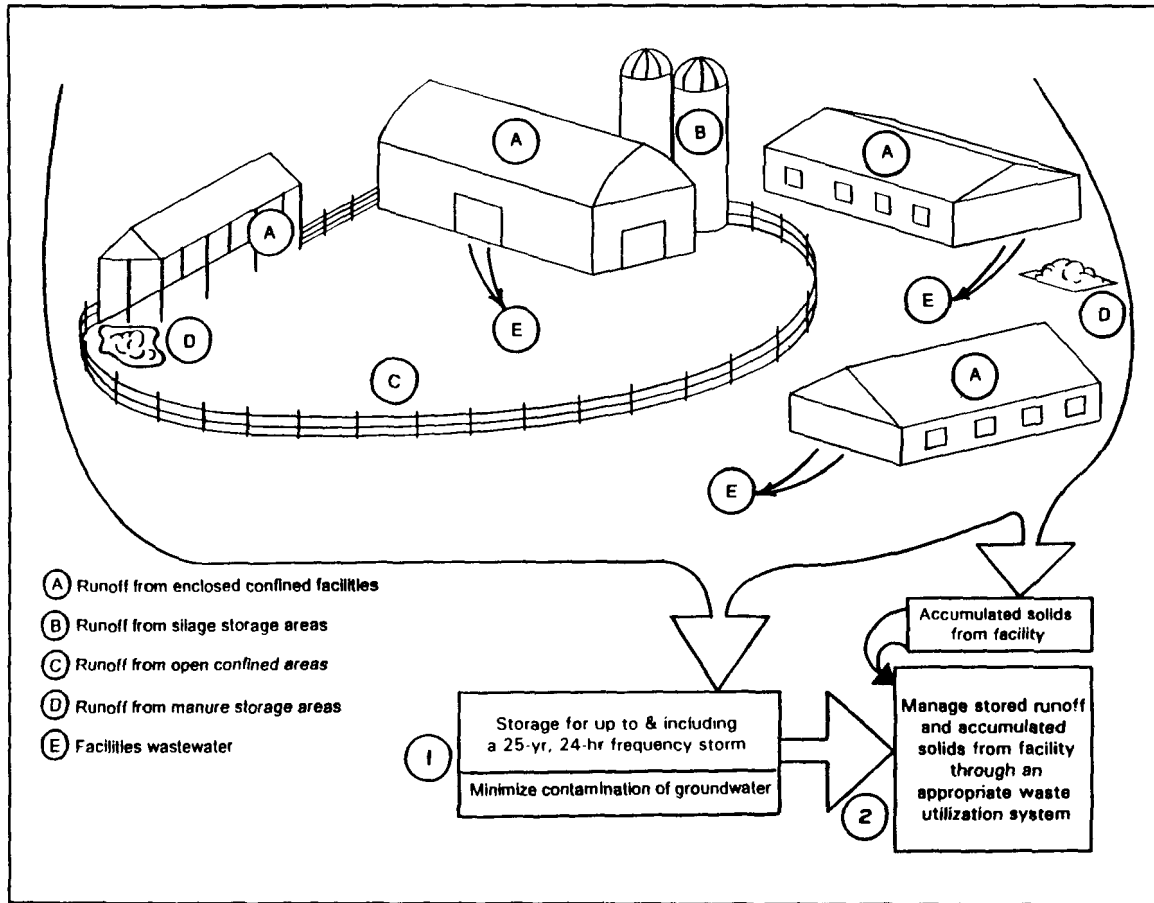

Figure 2-7. Management Measure for Facility Wastewater and Runoff from Confined Animal Facilities (Large Units).

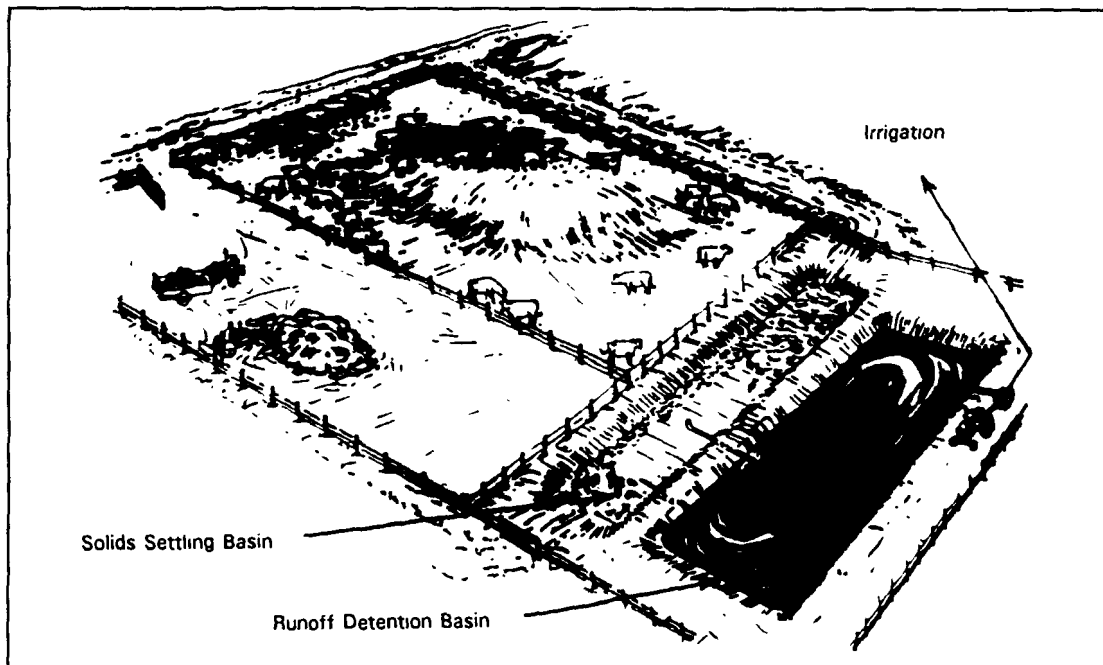

Figure 2-8. Example of manure and runoff storage system (Sutton, 1990).

This management measure does *not* require manure storage structures or areas, nor does it specify required manure management practices. This management measure does, however, address the management of *runoff* from manure storage areas. Manure may be stacked in the confined lot or other appropriate area as long as the storage and management of runoff from the confined lot are in accordance with this management measure. If manure is managed as a solid, any drainage from the storage area or structure area or structure should be routed to the runoff storage system.

When applied to agricultural lands, manure, stored runoff water, stored facility wastewater, and accumulated solids from the facility are to be applied in accordance with the nutrient management measure. An appropriate waste utilization system to minimize impacts to surface water and protect ground water may be achieved through implementation of the SCS Waste Utilization practice (633).

It is recognized that implementation of this measure may increase the potential for movement of water and soluble pollutants through the soil profile to the ground water. It is not the intent of this measure to address a surface water problem at the expense of ground water. Facility wastewater and runoff control systems can and should be designed to protect ground water. Ground-water protection will also be provided by minimizing seepage to ground water, if soil conditions require further protection, and by using the nutrient and pesticide management measures to reduce and control the application of nutrients and pesticides.

Seepage to ground water can be minimized by lining the runoff or manure storage structure with an earthen lining or plastic membrane lining, by constructing with concrete, or by constructing a storage tank. This is not difficult to accomplish and should be achieved in the initial design to reduce costs. For some soils and locations, movement of pollutants to the ground water is not a concern, but site evaluations are needed to determine the appropriate action to take to protect the resources at the site.

Operation and Maintenance of This Measure

Operation

Holding ponds and treatment lagoons should be operated such that the design storm volume is available for storage of runoff. Facilities filled to or near capacity should be drawn down as soon as all site conditions permit the safe removal and appropriate use of stored materials. Solids should be removed from solids separation basins as soon as possible following storm events to ensure that needed solids storage volume is available for subsequent storms.

Maintenance

Diversions will need periodic reshaping and should be free of trees and brush growth. Gutters and downspouts should be inspected annually and repaired when needed. Established grades for lot surfaces and conveyance channels are to be maintained at all times.

Channels should be free of trees and brush growth. Cleaning of debris basins, holding ponds, and lagoons will be needed to ensure that design volumes are maintained. Clean water should be excluded from the storage structure unless it is needed for further dilution in a liquid system.

3. Management Measure Selection

This management measure was selected for larger-sized animal production facilities because it can eliminate the pollutants leaving a facility by storing runoff from storms up to and including the 25-year, 24-hour frequency storm. It also uses practices that reduce the amount of water that comes into contact with animal waste materials. It requires that stored runoff and accumulated solids from the facility are managed through an appropriate waste utilization system. Any stored water, accumulated solids, processed dead animals, or manure are to be applied in accordance with the nutrient management measure.

The size limitations that define a large unit are based on EPA's analysis of the economic achievability of the management measure.

4. Effectiveness Information

The effectiveness of management practices to control contaminant losses from confined livestock facilities depends on several factors including:

- The contaminant(s) to be controlled and their likely pathways in surface, subsurface, and ground-water flows;
- The types of practices (section 5) and how these practices control surface, subsurface, and ground-water contaminant pathways; and
- Site-specific variables such as soil type, topography, precipitation characteristics, type of animal housing and waste storage facilities, method of waste collection, handling and disposal, and seasonal variations. The site-specific conditions must be considered in system design, thus having a large effect on practice effectiveness levels.

The gross effectiveness estimates reported in Table 2-9 simply indicate summary literature values. For specific cases, a wide range of effectiveness can be expected depending on the value and interaction of the site-specific variables cited above.

When runoff from storms up to and including the 24-hour, 25-year frequency storm is stored, there will be no release of pollutants from a confined animal facility via the surface runoff route. Rare storms of a greater magnitude or sequential storms of combined greater magnitude may produce runoff, however. Table 2-10 reflects the occurrence of such storms by indicating less than 100 percent control for runoff control systems.

Table 2-9. Relative Gross Effectiveness^a of Confined Livestock Control Measures (Pennsylvania State University, 1992a)

Practice ^b Category	Runoff ^c Volume	Total ^d Phosphorus (%)	Total ^d Nitrogen (%)	Sediment (%)	Fecal Coliform (%)
Animal Waste Systems ^e	-	90	80	60	85
Diversion Systems ^f	-	70	45	NA	NA
Filter Strips ^g	-	85	NA	60	55
Terrace System	-	85	55	80	NA
Containment Structures ^h	-	60	65	70	90

NA = not available.

^a Actual effectiveness depends on site-specific conditions. Values are not cumulative between practice categories.

^b Each category includes several specific types of practices.

^c - = reduction; + = increase; 0 = no change in surface runoff.

^d Total phosphorus includes total and dissolved phosphorus; total nitrogen includes organic-N, ammonia-N, and nitrate-N.

^e Includes methods for collecting, storing, and disposing of runoff and process-generated wastewater.

^f Specific practices include diversion of uncontaminated water from confinement facilities.

^g Includes all practices that reduce contaminant losses using vegetative control measures.

^h Includes such practices as waste storage ponds, waste storage structures, waste treatment lagoons.

Table 2-10. Effectiveness of Runoff Control Systems (DPRA, 1986)

Management Practice	Removal Efficiency (%)	
	Solids	Phosphorus
Runoff Control System	80 - 90	70 - 95

5. Confined Animal Facility Management Practices

As discussed more fully at the beginning of this chapter and in Chapter 1, the following practices are described for illustrative purposes only. State programs need not require implementation of these practices. However, as a practical matter, EPA anticipates that the management measure set forth above generally will be implemented by applying one or more management practices appropriate to the source, location, and climate. The practices set forth below have been found by EPA to be representative of the types of practices that can be applied successfully to achieve the management measure described above.

Combinations of the following practices can be used to satisfy the requirements of this management measure. The U.S. Soil Conservation Service (SCS) practice number and definition are provided for each management practice, where available. Also included in italics are SCS statements describing the effect each practice has on water quality (USDA-SCS, 1988).

- a. *Dikes (356): An embankment constructed of earth or other suitable materials to protect land against overflow or to regulate water.*

Where dikes are used to prevent water from flowing onto the floodplain, the pollution dispersion effect of the temporary wetlands and backwater are decreased. The sediment, sediment-attached, and soluble materials being transported by the water are carried farther downstream. The final fate of these materials must be investigated on site. Where dikes are used to retain runoff on the floodplain or in wetlands the pollution dispersion effects of these areas may be enhanced. Sediment and related materials may be deposited, and the quality of the water flowing into the stream from this area will be improved.

Dikes are used to prevent wetlands and to form wetlands. The formed areas may be fresh, brackish, or saltwater wetlands. In tidal areas dikes are used to stop saltwater intrusion, and to increase the hydraulic head of fresh water which will force intruded salt water out the aquifer. During construction there is a potential of heavy sediment loadings to the surface waters. When pesticides are used to control the brush on the dikes and fertilizers are used for the establishment and maintenance of vegetation there is the possibility for these materials to be washed into the surface waters.

- b. *Diversions (362): A channel constructed across the slope with a supporting ridge on the lower side.*

This practice will assist in the stabilization of a watershed, resulting in the reduction of sheet and rill erosion by reducing the length of slope. Sediment may be reduced by the elimination of ephemeral and large gullies. This may reduce the amount of sediment and related pollutants delivered to the surface waters.

- c. *Grassed waterway (412): A natural or constructed channel that is shaped or graded to required dimensions and established in suitable vegetation for the stable conveyance of runoff.*

This practice may reduce the erosion in a concentrated flow area, such as in a gully or in ephemeral gullies. This may result in the reduction of sediment and substances delivered to receiving waters. Vegetation may act as a filter

in removing some of the sediment delivered to the waterway, although this is not the primary function of a grassed waterway.

Any chemicals applied to the waterway in the course of treatment of the adjacent cropland may wash directly into the surface waters in the case where there is a runoff event shortly after spraying.

When used as a stable outlet for another practice, waterways may increase the likelihood of dissolved and suspended pollutants being transported to surface waters when these pollutants are delivered to the waterway.

- **d. Heavy use area protection (561):** *Protecting heavily used areas by establishing vegetative cover, by surfacing with suitable materials, or by installing needed structures.*

Protection may result in a general improvement of surface water quality through the reduction of erosion and the resulting sedimentation. Some increase in erosion may occur during and immediately after construction until the disturbed areas are fully stabilized.

Some increase in chemicals in surface water may occur due to the introduction of fertilizers for vegetated areas and oils and chemicals associated with paved areas. Fertilizers and pesticides used during operation and maintenance may be a source of water pollution.

Paved areas installed for livestock use will increase organic, bacteria, and nutrient loading to surface waters. Changes in ground water quality will be minor. Nitrate nitrogen applied as fertilizer in excess of vegetation needs may move with infiltrating waters. The extent of the problem, if any, may depend on the actual amount of water percolating below the root zone.

- **e. Lined waterway or outlet (468):** *A waterway or outlet having an erosion-resistant lining of concrete, stone, or other permanent material.*

The lined section extends up the side slopes to a designed depth. The earth above the permanent lining may be vegetated or otherwise protected.

This practice may reduce the erosion in concentrated flow areas resulting in the reduction of sediment and substances delivered to the receiving waters.

When used as a stable outlet for another practice, lined waterways may increase the likelihood of dissolved and suspended substances being transported to surface waters due to high flow velocities.

- **f. Roof runoff management (558):** *A facility for controlling and disposing of runoff water from roofs.*

This practice may reduce erosion and the delivery of sediment and related substances to surface waters. It will reduce the volume of water polluted by animal wastes. Loadings of organic waste, nutrients, bacteria, and salts to surface water are prevented from flowing across concentrated waste areas, barnyards, roads and alleys will be reduced. Pollution and erosion will be reduced. Flooding may be prevented and drainage may improve.

- **g. Terrace (600):** *An earthen embankment, a channel, or combination ridge and channel constructed across the slope.*

This practice reduces the slope length and the amount of surface runoff which passes over the area downslope from an individual terrace. This may reduce the erosion rate and production of sediment within the terrace interval. Terraces trap sediment and reduce the sediment and associated pollutant content in the runoff water which enhances surface water quality. Terraces may intercept and conduct surface runoff at a nonerosive velocity to stable outlets, thus reducing the occurrence of ephemeral and classic gullies and the resulting sediment. Increases in infiltration

can cause a greater amount of soluble nutrients and pesticides to be leached into the soil. Underground outlets may collect highly soluble nutrient and pesticide leachates and convey runoff and conveying it directly to an outlet, terraces may increase the delivery of pollutants to surface waters. Terraces increase the opportunity to leach salts below the root zone in the soil. Terraces may have a detrimental effect on water quality if they concentrate and accelerate delivery of dissolved or suspended nutrient, salt, and pesticide pollutants to surface or ground waters.

- h. **Waste storage pond (425):** An impoundment made by excavation or earth fill for temporary storage of animal or other agricultural wastes.

This practice reduces the direct delivery of polluted water, which is the runoff from manure stacking areas and feedlots and barnyards, to the surface waters. This practice may reduce the organic, pathogen, and nutrient loading to surface waters. This practice may increase the dissolved pollutant loading to ground water by leakage through the sidewalls and bottom.

- i. **Waste storage structure (313):** A fabricated structure for temporary storage of animal wastes or other organic agricultural wastes.

This practice may reduce the nutrient, pathogen, and organic loading to the surface waters. This is accomplished by intercepting and storing the polluted runoff from manure stacking areas, barnyards and feedlots. This practice will not eliminate the possibility of contaminating surface and ground water; however, it greatly reduces this possibility.

- j. **Waste treatment lagoon (359):** An impoundment made by excavation or earth fill for biological treatment of animal or other agricultural wastes.

This practice may reduce polluted surficial runoff and the loading of organics, pathogens, and nutrients into the surface waters. It decreases the nitrogen content of the surface runoff from feedlots by denitrification. Runoff is retained long enough that the solids and insoluble phosphorus settle and form a sludge in the bottom of the lagoon. There may be some seepage through the sidewalls and the bottom of the lagoon. Usually the long-term seepage rate is low enough, so that the concentration of substances transported into the ground water does not reach an unacceptable level.

- k. **Application of manure and/or runoff water to agricultural land**

Manure and runoff water are applied to agricultural lands and incorporated into the soil in accordance with the management measures for nutrients.

- l. **Waste utilization (633):** Using agricultural wastes or other wastes on land in an environmentally acceptable manner while maintaining or improving soil and plant resources.

Waste utilization helps reduce the transport of sediment and related pollutants to the surface water. Proper site selection, timing of application and rate of application may reduce the potential for degradation of surface and ground water. This practice may increase microbial action in the surface layers of the soil, causing a reaction which assists in controlling pesticides and other pollutants by keeping them in place in the field.

Mortality and other compost, when applied to agricultural land, will be applied in accordance with the nutrient management measure. The composting facility may be subject to State regulations and will have a written operation and management plan if SCS practice 317 (composting facility) is used.

■ *m. Composting facility (317): A facility for the biological stabilization of waste organic material.*

The purpose is to treat waste organic material biologically by producing a humus-like material that can be recycled as a soil amendment and fertilizer substitute or otherwise utilized in compliance with all laws, rules, and regulations.

■ *n. Commercial rendering or disposal services*

■ *o. Incineration*

■ *p. Approved burial sites*

6. Cost Information

Construction costs for control of runoff and manure from confined animal facilities are provided in Table 2-11. The annual operation and maintenance costs average 4 percent of construction costs for diversions, 3 percent of construction costs for settlement basins, and 5 percent of construction costs for retention ponds (DPRA, 1992). Annual costs for repairs, maintenance, taxes, and insurance are estimated to be 5 percent of investment costs for irrigation systems (DPRA, 1992).

Table 2-11. Costs for Runoff Control Systems (DPRA, 1992)

Practice ^a	Unit	Cost/Unit Construction (\$) ^b
Diversion	foot	2.00
Irrigation		
- Piping (4-inch)	foot	1.75
- Piping (6-inch)	foot	2.25
- Pumps (10 hp)	unit	1,750.00
- Pumps (15 hp)	unit	2,000.00
- Pumps (30 hp)	unit	3,000.00
- Pumps (45 hp)	unit	3,500.00
- Sprinkler/gun (150 gpm)	unit	875.00
- Sprinkler/gun (250 gpm)	unit	1,750.00
- Sprinkler/gun (400 gpm)	unit	3,200.00
- Contracted service to empty retention pond	1,000 gallon	3.00
Infiltration ^c	acre	2,500.00
Manure Hauling	mile per 4.5-ton load	2.15
Dead Animal Composting Facility	cubic foot	5.00
Retention Pond		
- 241 cubic feet in size	cubic foot	2.58
- 2,678 cubic feet in size	cubic foot	1.24
- 28,638 cubic feet in size	cubic foot	0.60
- 267,123 cubic feet in size	cubic foot	0.31
Settling Basin		
- 53 cubic feet in size	cubic foot	4.26
- 488 cubic feet in size	cubic foot	2.74
- 5,088 cubic feet in size	cubic foot	1.71
- 49,950 cubic feet in size	cubic foot	1.08

^a Expected lifetimes of practices are 20 years for diversions, settling basins, retention ponds, and infiltration areas and 15 years for irrigation equipment.

^b 1990 dollars. This table does not present annualized costs.

^c Does not include land costs.

B2. Management Measure for Facility Wastewater and Runoff from Confined Animal Facility Management (Small Units)

Design and implement systems that collect solids, reduce contaminant concentrations, and reduce runoff to minimize the discharge of contaminants in both facility wastewater and in runoff that is caused by storms up to and including a 25-year, 24-hour frequency storm. Implement these systems to substantially reduce significant increases in pollutant loadings to ground water.

Manage stored runoff and accumulated solids from the facility through an appropriate waste utilization system.

1. Applicability

This management measure is intended for application by States to all existing confined animal facilities that contain the following number of head:

	<u>Head</u>	<u>Animal Units</u> ⁵
Beef Feedlots	50-299	50-299
Stables (horses)	100-199	200-399
Dairies	20-69	28-97
Layers	5,000-14,999	50-149 ⁶ 165-494 ⁷
Broilers	5,000-14,999	50-149 ⁶ 165-494 ⁷
Turkeys	5,000-13,749	900-2,474
Swine	100-199	40-79

except those facilities that are required by Federal regulation 40 CFR 122.23(c) to apply for and receive discharge permits. 40 CFR 122.23(c) provides that the Director of an NPDES discharge permit program may designate any animal feeding operation as a concentrated animal feeding operation (which has the effect of subjecting the operation to the NPDES permit program requirements) upon determining that it is a significant contributor of water pollution. In such cases, upon issuance of a permit, the terms of the permit apply and this management measure ceases to apply.

Facilities containing fewer than the number of head listed above are not subject to the requirements of this management measure. Existing facilities that meet the requirements of Management Measure B1 for large units are in compliance with the requirements of this management measure. Existing and new facilities that already minimize

⁵ See *animal unit* in Glossary.

⁶ If facility has a liquid manure system, as used in 40 CFR Section 122, Appendix B.

⁷ If facility has continuous overflow watering, as used in 40 CFR Section 122, Appendix B.

the discharge of contaminants to surface waters, protect against contamination of ground water, and have an appropriate waste utilization system may already meet the requirements of this management measure. Such facilities may not need additional controls for the purposes of this management measure.

Under the Coastal Zone Act Reauthorization Amendments, States are subject to a number of requirements as they develop coastal nonpoint programs in conformity with this measure and will have some flexibility in doing so. The application of management measures by States is described more fully in *Coastal Nonpoint Pollution Control Program: Program Development and Approval Guidance*, published jointly by the U.S. Environmental Protection Agency (EPA) and the National Oceanic and Atmospheric Administration (NOAA) of the U.S. Department of Commerce.

A *confined animal facility* is a lot or facility (other than an aquatic animal production facility) where the following conditions are met:

- Animals (other than aquatic animals) have been, are, or will be stabled or confined and fed or maintained for a total of 45 days or more in any 12-month period, and
- Crops, vegetation forage growth, or post-harvest residues are not sustained in the normal growing season over any portion of the lot or facility.

Two or more animal facilities under common ownership are considered, for the purposes of these guidelines, to be a single animal facility if they adjoin each other or if they use a common area or system for the disposal of wastes.

Confined animal facilities, as defined above, include areas used to grow or house the animals, areas used for processing and storage of product, manure and runoff storage areas, and silage storage areas.

Facility wastewater and runoff from confined animal facilities are to be controlled under this management measure (Figure 2-9). Runoff includes any precipitation (rain or snow) that comes into contact with any manure, litter, or bedding. Facility wastewater is water discharged in the operation of an animal facility as a result of any or all of the following: animal or poultry watering; washing, cleaning, or flushing pens, barns, manure pits, or other animal facilities; washing or spray cooling of animals; and dust control.

2. Description

The goal of this management measure is to minimize the discharge of contaminants in both facility wastewater and in runoff that is caused by storms up to and including a 25-year, 24-hour frequency storm by using practices such as solids separation basins in combination with vegetative practices and other practices that reduce runoff and are also protective of ground water.

The problems associated with animal facilities are the control of runoff, facility wastewater, and manure. For additional information regarding problems, see Section I.F.3. of this chapter.

Application of this management measure will greatly reduce the volume of runoff, manure, and facility wastewater reaching a waterbody, thereby improving water quality and the use of the water resource. The measure can be implemented by using practices that divert runoff water from upslope sites and roofs away from the facility, thereby minimizing the amount of water that must be managed (Figure 2-10). Runoff water and facility wastewater from the facility should be routed through a settling structure or debris basin to remove solids. If manure is managed as a liquid, all manure, runoff, and facility wastewater can be stored in the same structure and there is no need for a debris basin.

This management measure does *not* require manure storage structures or areas, nor does it specify required manure management practices. This management measure does, however, address the management of *runoff* from manure

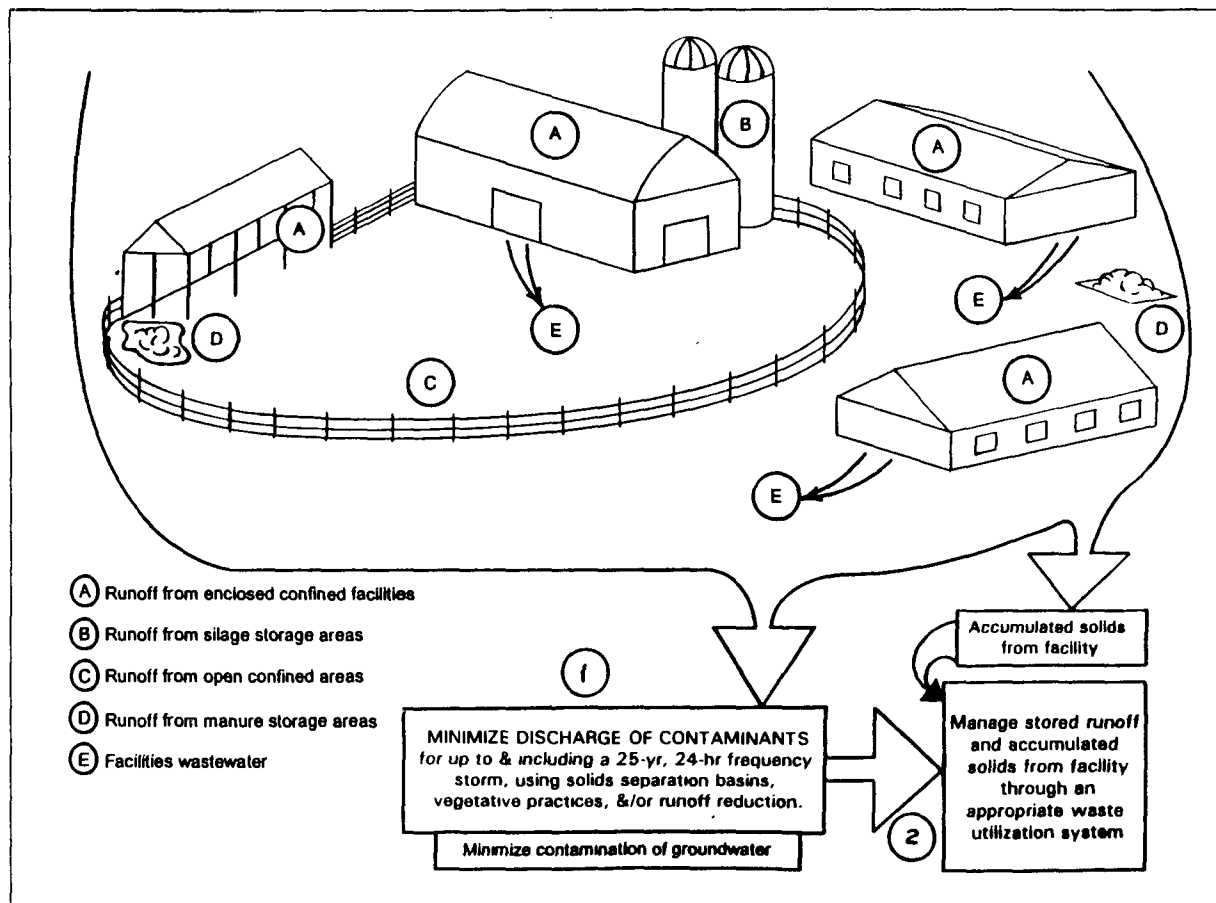

Figure 2-9. Management Measure for Facility Wastewater and Runoff from Confined Animal Facilities (Small Units).

storage areas. Manure may be stacked in the confined lot or other appropriate area as long as the discharge is minimized and any stored runoff is managed in accordance with this management measure. If manure is managed as a solid, any drainage from the storage area or structure should be routed to the runoff control practices.

When applied to agricultural lands, manure, stored runoff water, stored facility wastewater, and accumulated solids from the facility are to be applied in accordance with the nutrient management measure. An appropriate waste utilization system to minimize impacts to surface water and protect ground water may be achieved through implementation of the SCS Waste Utilization practice (633).

It is recognized that implementation of this measure may increase the potential for movement of water and soluble pollutants through the soil profile to the ground water. It is not the intent of this measure to address a surface water problem at the expense of ground water. Facility wastewater and runoff control systems can and should be designed to protect against the contamination of ground water. Ground-water protection will also be provided by minimizing seepage to ground water, if soil conditions require further protection, and by using the nutrient and pesticide management measures to reduce and control the application of nutrients and pesticides. While a nutrient management plan is not required to be implemented on the vegetative control practices themselves, ground water should be protected by taking extreme care to not exceed the capacity of the practices to assimilate nutrients.

When storage structures are used to meet the requirements of this management measure, seepage to ground water can be minimized by lining the runoff or manure storage structure with an earthen lining or plastic membrane lining, by constructing with concrete, or by constructing a storage tank. This is not difficult to accomplish and should be achieved in the initial design to reduce costs. For some soils and locations movement of pollutants to the ground

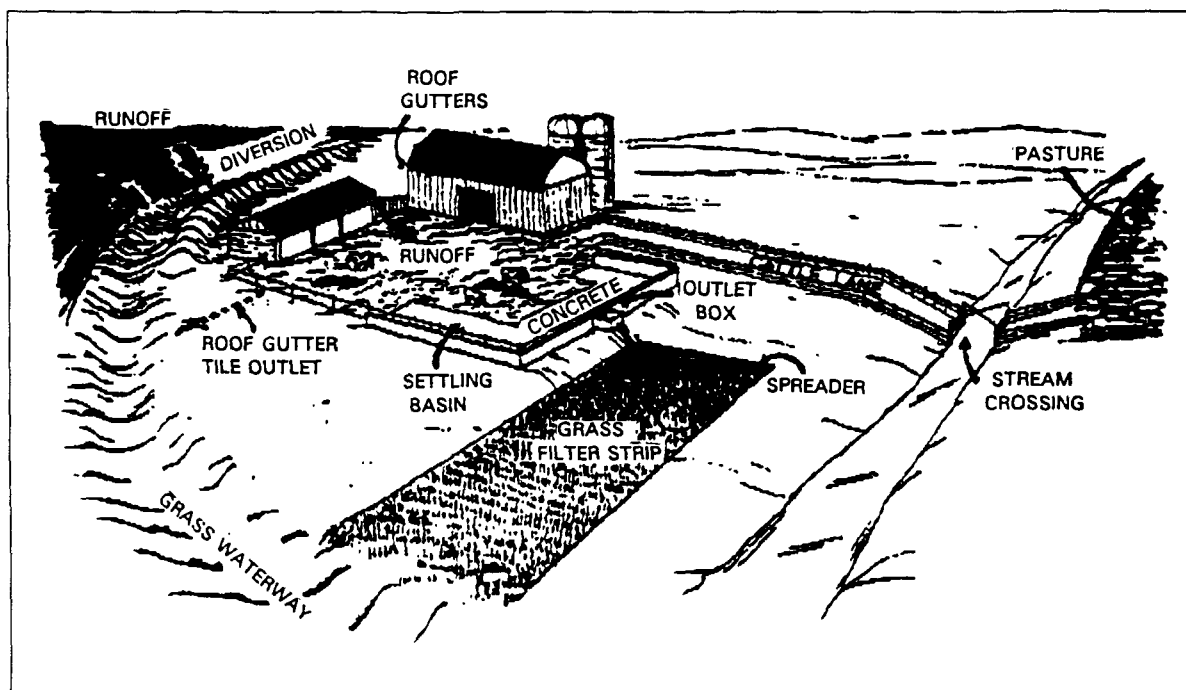

Figure 2-10. Typical barnyard runoff management system (Wisconsin Dept. of Agriculture, Trade and Consumer Protection, 1989).

water is not a concern, but each site must be evaluated and the appropriate action taken to protect the resources at the site.

Operation and Maintenance of This Measure

Operation

Holding ponds and treatment lagoons should be operated such that the design storm volume is available for storage of runoff. Facilities that have filled should be drawn down as soon as all site conditions permit the safe removal and appropriate use of stored materials. Solids should be removed from solids separation basins as soon as possible following storm events to ensure that needed solids storage volume is available for subsequent storms.

Maintenance

Diversions will need periodic reshaping and should be free of trees and brush growth. Gutters and downspouts should be inspected annually and repaired when needed. Established grades for lot surfaces and conveyance channels must be maintained at all times.

Channels must be free of trees and brush growth. Cleaning of debris basins, holding ponds, and lagoons will be needed to ensure that design volumes are maintained. Clean water should be excluded from the storage structure unless it is needed for further dilution in a liquid system.

3. Management Measure Selection

This management measure was selected for smaller-sized animal production facilities based on an evaluation of available information that documents the beneficial effects of improved management of confined livestock facilities. Specifically, the management measure reduces the amount of pollutants leaving a facility by using practices that reduce the amount of water that comes into contact with animal waste materials. It also uses solid removal and

filtration of runoff water to remove a significant amount of the pollutants contained in the runoff waters. This can be accomplished without the expense of constructing a runoff storage structure and purchasing the equipment necessary to apply the stored water to the land.

This management measure also requires that stored runoff and accumulated solids from the facility are managed through an appropriate waste utilization system. The size limitations that define a small unit are based on EPA's analysis of the economic achievability of the management measure.

4. Effectiveness Information

The effectiveness information presented for large units (Tables 2-9 and 2-10) also applies to this management measure.

Pollutant loads from runoff caused by storms up to and including the 25-year, 24-hour frequency storm can be reduced by decreasing the potential for runoff contamination (e.g., by keeping accumulations of manure off the open lots), and by removing the contaminants to the fullest extent practicable through vegetative and structural practices (e.g., solids separation devices, sediment basins, filter strips, and constructed wetlands). Pollutant loads can also be reduced by storing and applying the runoff to the land with any manure and facility wastewater in accordance with the nutrient management measure.

Table 2-12 shows reductions in pollutant concentrations that are achievable with solids separation basins that receive runoff from barnyards and feedlots. Concentration reductions may differ from the load reductions presented in Tables 2-9 and 2-10 since loads are determined by both concentration and discharge volume. Solids separation basins combined with drained infiltration beds and vegetated filter strips (VFS) provide additional reductions in contaminant concentrations. The effectiveness of solids separation basins is highly dependent on site variables. Solids separation; basin sizing and management (clean-out); characteristics of VFS areas such as soil type, land slope, length, vegetation type, vegetation quality; and storm amounts and intensities all play important roles in the performance of the system. Appropriate operation and maintenance are critical to success.

Table 2-12. Concentrated Reductions in Barnyard and Feedlot Runoff Treated with Solids Separation

Site Location	Constituent Reduction (%)			
	TS	COD	Nitrogen	TP
Ohio - basin only ^{a,b}	49-54	51-56	35	21-41
Ohio - basin combined w/infiltration bed ^a	82	85	—	80
VFS ^b	87	89	83	84
Canada - basin only ^c	56	38	14(TKN)	—
Canada - basin w/VFS ^c		(High 90's in fall and spring)		
Illinois - basin w/VFS ^d	73		80(TKN)	78

^a Edwards et al., 1986.

^b Edwards et al., 1983.

^c Adam et al., 1986.

^d Dickey, 1981.

5. Confined Animal Facility Management Practices

As discussed more fully at the beginning of this chapter and in Chapter 1, the following practices are described for illustrative purposes only. State programs need not require implementation of these practices. However, as a practical matter, EPA anticipates that the management measure set forth above generally will be implemented by applying one or more management practices appropriate to the source, location, and climate. The practices set forth below have been found by EPA to be representative of the types of practices that can be applied successfully to achieve the management measure described above.

Combinations of the following practices can be used to satisfy the requirements of this management measure. The U.S. Soil Conservation Service (SCS) practice number and definition are provided for each management practice, where available. Also included in italics are SCS statements describing the effect each practice has on water quality (USDA-SCS, 1988).

- a. **Waste storage pond (425):** *An impoundment made by excavation or earth fill for temporary storage of animal or other agricultural waste.*

This practice reduces the direct delivery of polluted water, which is the runoff from manure stacking areas and feedlots and barnyards, to the surface waters. This practice may reduce the organic, pathogen, and nutrient loading to surface waters. This practice may increase the dissolved pollutant loading to ground water by leakage through the sidewalls and bottom.

- b. **Waste storage structure (313):** *A fabricated structure for temporary storage of animal waste or other organic agricultural waste.*

This practice may reduce the nutrient, pathogen, and organic loading to the surface waters. This is accomplished by intercepting and storing the polluted runoff from manure stacking areas, barnyards and feedlots. This practice will not eliminate the possibility of contaminating surface and ground water; however, it greatly reduces this possibility.

- c. **Waste treatment lagoon (359):** *An impoundment made by excavation or earth fill for biological treatment of animal or other agricultural waste.*

This practice may reduce polluted surficial runoff and the loading of organics, pathogens, and nutrients into the surface waters. It decreases the nitrogen content of the surface runoff from feedlots by denitrification. Runoff is retained long enough that the solids and insoluble phosphorus settle and form a sludge in the bottom of the lagoon. There may be some seepage through the sidewalls and the bottom of the lagoon. Usually the long-term seepage rate is low enough, so that the concentration of substances transported into the ground water does not reach an unacceptable level.

- d. **Sediment basin (350):** *A basin constructed to collect and store debris or sediment.*

Sediment basins will remove sediment, sediment associated materials and other debris from the water which is passed on downstream. Due to the detention of the runoff in the basin, there is an increased opportunity for soluble materials to be leached toward the ground water.

- e. **Water and sediment control basin (638):** *An earth embankment or a combination ridge and channel generally constructed across the slope and minor water courses to form a sediment trap and a water detention basin.*

The practice traps and removes sediment and sediment-attached substances from runoff. Trap control efficiencies for sediment and total phosphorus, that are transported by runoff, may exceed 90 percent in silt loam soils. Dissolved substance, such as nitrates, may be removed from discharge to downstream areas because of the increased infiltration. Where geologic condition permit, the practice will lead to increased loadings of dissolved substances toward ground water. Water temperatures of surface runoff, released through underground outlets, may increase slightly because of longer exposure to warming during its impoundment.

- **f. Filter strip (393):** *A strip or area of vegetation for removing sediment, organic matter, and other contaminants from runoff and wastewater.*

Filter strips for sediment and related pollutants meeting minimum requirements may trap the coarser grained sediment. They may not filter out soluble or suspended fine-grained materials. When a storm caused runoff in excess of the design runoff, the filter may be flooded and may cause large loads of pollutants to be released to the surface water. This type of filter requires high maintenance and has a relatively short service life and is effective only as long as the flow through the filter is shallow sheet flow.

Filter strips for runoff from concentrated livestock areas may trap organic material, solids, materials which become adsorbed to the vegetation or the soil within the filter. Often they will not filter out soluble materials. This type of filter is often wet and is difficult to maintain.

Filter strips for controlled overland flow treatment of liquid wastes may effectively filter out pollutants. The filter must be properly managed and maintained, including the proper resting time. Filter strips on forest land may trap coarse sediment, timbering debris, and other deleterious material being transported by runoff. This may improve the quality of surface water and has little effect on soluble material in runoff or on the quality of ground water.

All types of filters may reduce erosion on the area on which they are constructed.

Filter strips trap solids from the runoff flowing in sheet flow through the filter. Coarse-grained and fibrous materials are filtered more efficiently than fine-grained and soluble substances. Filter strips work for design conditions, but when flooded or overloaded they may release a slug load of pollutants into the surface water.

- **g. Grassed waterway (412):** *A natural or constructed channel that is shaped or graded to required dimensions and established in a suitable vegetation for the stable conveyance of runoff.*

This practice may reduce the erosion in a concentrated flow area, such as in a gully or in ephemeral gullies. This may result in the reduction of sediment and substances delivered to receiving waters. Vegetation may act as a filter in removing some of the sediment delivered to the waterway, although this is not the primary function of a grassed waterway.

Any chemicals applied to the waterway in the course of treatment of the adjacent cropland may wash directly into the surface waters in the case where there is a runoff event shortly after spraying.

When used as a stable outlet for another practice, waterways may increase the likelihood of dissolved and suspended pollutants being transported to surface waters when these pollutants are delivered to the waterway.

- **h. Constructed wetland (ASCS-999):** *A constructed aquatic ecosystem with rooted emergent hydrophytes designed and managed to treat agricultural wastewater.*

This is a conservation practice for which SCS has developed technical requirements under a trial program leading to the development of a conservation practice standard.

- i. **Dikes (356):** An embankment constructed of earth or other suitable materials to protect land against overflow or to regulate water.

Where dikes are used to prevent water from flowing onto the floodplain, the pollution dispersion effects of the temporary wetlands and backwater are decreased. The sediment, sediment-attached, and soluble materials being transported by the water are carried farther downstream. The final fate of these materials must be investigated on site. Where dikes are used to retain runoff on the floodplain or in wetlands the pollution dispersion effects of these areas may be enhanced. Sediment and related materials may be deposited, and the quality of the water flowing into the stream from this area will be improved.

Dikes are used to prevent wetlands and to form wetlands. The formed areas may be fresh, brackish, or saltwater wetlands. In tidal areas dikes are used to stop saltwater intrusion, and to increase the hydraulic head of fresh water which will force intruded salt water out the aquifer. During construction there is a potential of heavy sediment loadings to the surface waters. When pesticides are used to control the brush on the dikes and fertilizers are used for the establishment and maintenance of vegetation there is the possibility for these materials to be washed into the surface waters.

- j. **Diversion (362):** A channel constructed across the slope with a supporting ridge on the lower side.

This practice will assist in the stabilization of a watershed, resulting in the reduction of sheet and rill erosion by reducing the length of slope. Sediment may be reduced by the elimination of ephemeral and large gullies. This may reduce the amount of sediment and related pollutants delivered to the surface waters.

- k. **Heavy use area protection (561):** Protecting heavily used areas by establishing vegetative cover, by surfacing with suitable materials, or by installing needed structures.

Protection may result in a general improvement of surface water quality through the reduction of erosion and the resulting sedimentation. Some increase in erosion may occur during and immediately after construction until the disturbed areas are fully stabilized.

Some increase in chemicals in surface water may occur due to the introduction of fertilizers for vegetated areas and oils and chemicals associated with paved areas. Fertilizers and pesticides used during operation and maintenance may be a source of water pollution.

Paved areas installed for livestock use will increase organic, bacteria, and nutrient loading to surface waters. Changes in ground water quality will be minor. Nitrate nitrogen applied as fertilizer in excess of vegetation needs may move with infiltrating waters. The extent of the problem, if any, may depend on the actual amount of water percolating below the root zone.

- l. **Lined waterway or outlet (468):** A waterway or outlet having an erosion-resistant lining of concrete, stone, or other permanent material.

The lined section extends up the side slopes to a designed depth. The earth above the permanent lining may be vegetated or otherwise protected.

This practice may reduce the erosion in concentrated flow areas resulting in the reduction of sediment and substances delivered to the receiving waters.

When used as a stable outlet for another practice, lined waterways may increase the likelihood of dissolved and suspended substances being transported to surface waters due to high flow velocities.

■ **m. Roof runoff management (558):** A facility for controlling and disposing of runoff water from roofs.

This practice may reduce erosion and the delivery of sediment and related substances to surface waters. It will reduce the volume of water polluted by animal wastes. Loadings of organic waste, nutrients, bacteria, and salts to surface water are prevented from flowing across concentrated waste areas, barnyards, roads and alleys. Pollution and erosion will be reduced. Flooding may be prevented and drainage may improve.

■ **n. Terrace (600):** An earthen embankment, a channel, or combination ridge and channel constructed across the slope.

This practice reduces the slope length and the amount of surface runoff which passes over the area downslope from an individual terrace. This may reduce the erosion rate and production of sediment within the terrace interval. Terraces trap sediment and reduce the sediment and associated pollutant content in the runoff water which enhance surface water quality. Terraces may intercept and conduct surface runoff at a nonerosive velocity to stable outlets, thus reducing the occurrence of ephemeral and classic gullies and the resulting sediment. Increases in infiltration can cause a greater amount of soluble nutrients and pesticides to be leached into the soil. Underground outlets may collect highly soluble nutrient and pesticide leachates and convey runoff and conveying it directly to an outlet, terraces may increase the delivery of pollutants to surface waters. Terraces increase the opportunity to leach salts below the root zone in the soil. Terraces may have a detrimental effect on water quality if they concentrate and accelerate delivery of dissolved or suspended nutrient, salt, and pesticide pollutants to surface or ground waters.

■ **o. Waste utilization (633):** Using agricultural wastes or other wastes on land in an environmentally acceptable manner while maintaining or improving soil and plant resources.

Waste utilization helps reduce the transport of sediment and related pollutants to the surface water. Proper site selection, timing of application and rate of application may reduce the potential for degradation of surface and ground water. This practice may increase microbial action in the surface layers of the soil, causing a reaction which assists in controlling pesticides and other pollutants by keeping them in place in the field.

Mortality and other compost, when applied to agricultural land, will be applied in accordance with the nutrient management measure. The composting facility may be subject to State regulations and will have a written operation and management plan if SCS practice 317 (composting facility) is used.

■ **p. Composting facility (317):** A facility for the biological stabilization of waste organic material.

The purpose is to treat waste organic material biologically by producing a humus-like material that can be recycled as a soil amendment and fertilizer substitute or otherwise used in compliance with all laws, rules, and regulations.

■ **q. Commercial rendering or disposal services**

■ **r. Incineration**

■ **s. Approved burial site**

6. Cost Information

The construction costs for large units (Table 2-11) also apply to this measure. The annual operation and maintenance costs average 4 percent of construction costs for diversions, 3 percent of construction costs for settlement basins, and 5 percent of construction costs for retention ponds (DPRA, 1992). Annual costs for repairs, maintenance, taxes, and insurance are estimated to be 5 percent of investment costs for irrigation systems (DPRA, 1992).

C. Nutrient Management Measure

Develop, implement, and periodically update a nutrient management plan to: (1) apply nutrients at rates necessary to achieve realistic crop yields, (2) improve the timing of nutrient application, and (3) use agronomic crop production technology to increase nutrient use efficiency. When the source of the nutrients is other than commercial fertilizer, determine the nutrient value and the rate of availability of the nutrients. Determine and credit the nitrogen contribution of any legume crop. Soil and plant tissue testing should be used routinely. Nutrient management plans contain the following core components:

- (1) Farm and field maps showing acreage, crops, soils, and waterbodies.
- (2) Realistic yield expectations for the crop(s) to be grown, based primarily on the producer's actual yield history, State Land Grant University yield expectations for the soil series, or SCS Soils-5 information for the soil series.
- (3) A summary of the nutrient resources available to the producer, which at a minimum include:
 - Soil test results for pH, phosphorus, nitrogen, and potassium;
 - Nutrient analysis of manure, sludge, mortality compost (birds, pigs, etc.), or effluent (if applicable);
 - Nitrogen contribution to the soil from legumes grown in the rotation (if applicable); and
 - Other significant nutrient sources (e.g., irrigation water).
- (4) An evaluation of field limitations based on environmental hazards or concerns, such as:
 - Sinkholes, shallow soils over fractured bedrock, and soils with high leaching potential,
 - Lands near surface water,
 - Highly erodible soils, and
 - Shallow aquifers.
- (5) Use of the limiting nutrient concept to establish the mix of nutrient sources and requirements for the crop based on a realistic yield expectation.
- (6) Identification of timing and application methods for nutrients to: provide nutrients at rates necessary to achieve realistic crop yields; reduce losses to the environment; and avoid applications as much as possible to frozen soil and during periods of leaching or runoff.
- (7) Provisions for the proper calibration and operation of nutrient application equipment.

1. Applicability

This management measure is intended to be applied by States to activities associated with the application of nutrients to agricultural lands. Under the Coastal Zone Act Reauthorization Amendments of 1990, States are subject to a number of requirements as they develop coastal nonpoint programs in conformity with this measure and will have some flexibility in doing so. The application of management measures by States is described more fully in *Coastal Nonpoint Pollution Control Program: Program Development and Approval Guidance*, published jointly by the U.S. Environmental Protection Agency (EPA) and the National Oceanic and Atmospheric Administration (NOAA) of the U.S. Department of Commerce.

2. Description

The goal of this management measure is to minimize edge-of-field delivery of nutrients and minimize leaching of nutrients from the root zone. Nutrient management is pollution prevention achieved by developing a nutrient budget for the crop, applying nutrients at the proper time, applying only the types and amounts of nutrients necessary to produce a crop, and considering the environmental hazards of the site. In cases where manure is used as a nutrient source, manure holding areas may be needed to provide capability to avoid application to frozen soil.

This measure may result in some reduction in the amount of nutrients being applied to the land, thereby reducing the cost of production as well as protecting both ground water and surface water quality. However, application of the measure may in some cases cause more nutrients to be applied where there has not been a balanced use of nutrients in the past. This will usually allow all the nutrients to be used more efficiently, thereby reducing the amount of nutrients that will be available for transport from the field during the non-growing season. While the use of nutrient management should reduce the amount of nutrients lost with surface runoff to some degree, the primary control for the transport of nutrients that are attached to soil particles will be accomplished through the implementation of erosion and sediment control practices (Section II.A of this chapter). For information regarding the potential problems caused by nutrients see Section I.F.1 of this chapter.

Operation and Maintenance for Nutrient Management

The use of a nutrient management plan requires accurate information on the nutrient resources available to the producer. Management practices typically used to obtain this information include periodic soil testing for each field; soil and/or tissue testing during the early growth stages of the crop; and testing of manure, sludge, and irrigation water if they are used. The plan may call for multiple applications of nutrients that require more than one field operation to apply the total nutrients needed by the crop.

A nutrient management plan should be reviewed and updated at least once every 3 years, or whenever the crop rotation is changed or the nutrient source is changed. Application equipment should be calibrated and inspected for wear and damage periodically, and repaired when necessary. Records of nutrient use and sources should be maintained along with other management records for each field. This information will be useful when it is necessary to update or modify the management plan.

3. Management Measure Selection

This management measure was selected as a method (1) to minimize the amount of nutrients entering ground water through root zone leaching and entering surface water from edge-of-field delivery and (2) to promote more efficient use of all sources of nutrients that are available to the producer. The practices and concepts that can be used to implement this measure on a given site are those commonly used and recommended by States and USDA for general use on agricultural lands. By implementing the measure using the necessary mix of practices for a given site there should not be a negative economic impact on the operator, and in most cases the impact will be positive. Many of the practices that can be used to implement this measure may already be required by Federal, State, or local rules (e.g., field borders along streams) or may otherwise be in use on agricultural fields. Since many producers may

already be using systems that satisfy or partly satisfy the intent of this management measure, the only action that may be necessary will be to determine the effectiveness of the existing practices and add additional practices, if needed. Use of existing practices will reduce the time, effort, and cost of implementing this measure.

4. Effectiveness Information

Following is a summary of information regarding pollution reductions that can be expected from installation of nutrient management practices.

The State of Maryland estimates that average reductions of 34 pounds of nitrogen and 41 pounds of phosphorus per acre can be achieved through the implementation of nutrient management plans (Maryland Department of Agriculture, 1990). These average reductions may be high because they apply mostly to farms that use animal wastes; average reductions for farms that use only commercial fertilizer may be lower. The reduction in the loading of these nutrients to coastal waters is difficult to measure or predict. Field-scale and watershed models, however, can be used to estimate the reduction in nutrients moving to the edges of fields and to ground water.

As of July 1990, the Chesapeake Bay drainage basin States of Pennsylvania, Maryland, and Virginia reported that approximately 114,300 acres (1.4 percent of eligible cropland in the basin) had nutrient management plans in place (USEPA, 1991a). The average nutrient reductions of total nitrogen and total phosphorus were 31.5 and 37.5 pounds per acre, respectively. The States initially focused nutrient management efforts on animal waste utilization. Because initial planning was focused on animal wastes (which have a relatively high total nitrogen and phosphorus loading factor), estimates of nutrient reductions attributed to nutrient management may decrease as more cropland using only commercial fertilizer is enrolled in the program.

In Iowa, average corn yields remained constant while nitrogen use dropped from 145 pounds per acre in 1985 to less than 130 pounds per acre in 1989 and 1990 as a result of improved nutrient management (Iowa State University, 1991b). In addition, data supplied from nitrate soil tests indicated that at least 32 percent of the soils sampled did not need additional nitrogen for optimal yields (Iowa State University, 1991b).

In a pilot program in Butler County, Iowa, 48 farms operating 25,000 acres reduced fertilizer nitrogen use by 240,000 pounds through setting realistic yield goals by soils, giving appropriate crop rotation and manure credits, and some use of the pre-sidedress soil nitrate test (Hallberg et al., 1991). Other data from Iowa showed that in some areas fields have enough potassium and phosphorus to last for at least another decade (Iowa State University, 1991b).

In Garvin Brook, Minnesota, fertilizer management on corn resulted in nitrogen savings of 29 to 49 pounds per acre from 1985 to 1988 (Wall et al., 1989). In this Rural Clean Water Program (RCWP) project, fertilizer management consisted of split applications and rates based upon previous yields, manure application, previous crops, and soil test results.

Berry and Hargett (1984) showed a 40 percent reduction in statewide nitrogen use over 8 years following introduction of improved fertilizer recommendations in Pennsylvania. Findings from the RCWP project in Pennsylvania indicate that, for 340 nutrient management plans, overall recommended reductions (corn, hay, and other crops) were 27 percent for nitrogen, 14 percent for phosphorus, and 12 percent for potash (USDA-ASCS, 1992a). Producers achieved 79 percent of the recommended nitrogen reductions and 45 percent of the recommended phosphorus reductions.

In Vermont, research suggests that a newly introduced, late spring soil test results in about a 50 percent reduction in the nitrogen recommendation compared to conventional technologies (Magdoff et al., 1984). Research in New York and other areas of the Nation documents fertilizer use reductions of 30 to 50 percent for late spring versus preplant and fall applications, with yields comparable to those of the preplant and fall applications (Bouldin et al., 1971).

USDA reports that improved nutrient management has resulted in nitrogen application reductions of 33.1 pounds/acre treated for surface water protection, 28.4 pounds/acre treated for ground water protection, and 62.1 pounds of phosphorus per acre treated for water quality protection in its 16 Water Quality Demonstration Projects and 74 Hydrologic Unit Areas (USDA, 1992). The Hydrologic Unit Areas begun in 1990 show the greatest reductions in fertilizer use per acre (Table 2-13).

A summary of the effectiveness of nutrient management in controlling nitrogen and phosphorus is given in Table 2-14. This summary is based on an extensive search of the published literature.

Table 2-13. Nutrient Reductions Achieved Under USDA's Water Quality Program (USDA, 1992)

Projects	Cumulative				Average Reduction in Pounds/Acre Treated
	Pounds Reduced		Acres Treated		
	N	P	N	P	
1990 Demos (8 projects)	284,339 SW 556,437 GW	178,204	5,980 SW 18,771 GW	5,184	47.5 N-SW 29.6 N-GW 34.4 P
1991 Demos (8 projects)	34,672 SW	38,060	788 SW	692	44 N-SW 55 P
1990 HUAs (37 areas)	656,374 SW 601,646 GW	1,344,260	13,761 SW 16,808 GW	15,962	47.7 N-SW 35.8 N-GW 84.2 P
1991 HUAs (37 areas)	156,552 SW 366,890 GW	118,037	13,658 SW 18,115 GW	5,188	11.5 N-SW 20.2 N-GW 22.8 P
1990/1991 Demo/HUA Overall	1,131,937 SW 1,524,973 GW	1,678,561	34,187 SW 53,694 GW	27,026	33.1 N-SW 28.4 N-GW 62.1 P

SW = surface water
GW = ground water

**Table 2-14. Relative Effectiveness^a of Nutrient Management
(Pennsylvania State University, 1992a)**

Practice	Percent Change in Total Phosphorus Loads	Percent Change in Total Nitrogen Loads
Nutrient Management ^b	-35	-15

^a Most observations from reported computer modeling studies.

^b An agronomic practice related to source management; actual change in contaminant load to surface and ground water is highly variable.

5. Nutrient Management Practices

As discussed more fully at the beginning of this chapter and in Chapter 1, the following practices are described for illustrative purposes only. State programs need not require implementation of these practices. However, as a practical matter, EPA anticipates that the management measure set forth above generally will be implemented by applying one or more management practices appropriate to the source, location, and climate. The practices set forth below have been found by EPA to be representative of the types of practices that can be applied successfully to achieve the management measure described above.

Following are practices, components, and sources of information that should be considered in the development of a nutrient management plan:

- (1) Use of soil surveys in determining soil productivity and identifying environmentally sensitive sites.
- (2) Use of producer-documented yield history and other relevant information to determine realistic crop yield expectations. Appropriate methods include averaging the three highest yields in five consecutive crop years for the planning site, or other methods based on criteria used in developing the State Land Grant University's nutrient recommendations. In lieu of producer yield histories, university recommendations based on interpretation of SCS Soils-5 data may be used. Increased yields due to the use of new and improved varieties and hybrids should be considered when yield goals are set for a specific site.
- (3) Soil testing for pH, phosphorus (Figure 2-11), potassium, and nitrogen (Figure 2-12).
- (4) Plant tissue testing.
- (5) Manure (Figure 2-13), sludge, mortality compost, and effluent testing.
- (6) Use of proper timing, formulation, and application methods for nutrients that maximize plant utilization of nutrients and minimize the loss to the environment, including split applications and banding of the nutrients, use of nitrification inhibitors and slow-release fertilizers, and incorporation or injection of fertilizers, manures, and other organic sources.
- (7) Use of small grain cover crops to scavenge nutrients remaining in the soil after harvest of the principal crop, particularly on highly leachable soils. Consideration should be given to establishing a cover crop on land receiving sludge or animal waste if there is a high leaching potential. Sludge and animal waste should be incorporated.
- (8) Use of buffer areas or intensive nutrient management practices to manage field limitations based on environmentally high risk areas such as:
 - Karst topographic areas containing sinkholes and shallow soils over fractured bedrock;
 - Lands near surface water;
 - High leaching index soils;
 - Irrigated land in humid regions;
 - Highly erodible soils;
 - Lands prone to surface loss of nutrients; and
 - Shallow aquifers.
- (9) Control of phosphorus losses from fields through a combination of the Erosion and Sediment Control Measure (Section II.A of this chapter) and the Nutrient Management Measure. Limit manure and sludge applications to phosphorus crop needs when possible, supplying any additional nitrogen needs with nitrogen fertilizers or legumes. If this is not practical, route excess phosphorus in manures or sludge to

07/31/84	0004	700234	SOMERSET	25	NPBUU1	READINGTON
DATE	LAB NO.	SERIAL NO.	COUNTY	ACRES	FIELD	SOIL

THE PENNSYLVANIA STATE UNIVERSITY
COLLEGE OF AGRICULTURE
MERKLE LABORATORY - SOIL & FORAGE TESTING
UNIVERSITY PARK, PA 16802

SOIL TEST REPORT FOR: P.A. PENN RD1 ANYTOWN, PA 10000

COPY SENT TO: ACME FERTILIZER CO. MAIN STREET ANYTOWN, PA 10000

SOIL NUTRIENT LEVELS:	LOW	OPTIMUM	HIGH	EXCESSIVE
Soil pH <u>6.2</u>	XXXXXXXXXXXXXXXX			
Phosphate (P ₂ O ₅) <u>114</u> lb/A	XXXXXXXXXXXXXXXX			
Potash (K ₂ O) <u>178</u> lb/A	XXXXXXXXXXXXXX			
Magnesium (MgO) <u>230</u> lb/A	XXXXXXXXXXXXXXXX			

RECOMMENDATIONS FOR: PLANTING CORN FOR GRAIN (For other crops see ST 2 column: 1)

YIELD GOAL 125.0 BUSHELS (PER ACRE)

LIMESTONE: 3400 lb/A Calcium Carbonate Equivalent

PLANT NUTRIENT NEEDS:

NITROGEN (N)	PHOSPHATE (P ₂ O ₅)	POTASH (K ₂ O)	MAGNESIUM (MgO)
130 lb/A	70 lb/A	90 lb/A	10 lb/A

MESSAGES:

- USE A STARTER FERTILIZER 6.7
- LIMESTONE RECOMMENDATION, IF ANY, IS TO BRING THE SOIL PH TO 6.0 - 6.5. MULTIPLY THE EXCHANGABLE ACIDITY BY 1000 TO ESTIMATE THE LIME REQUIREMENT FOR PH 6.5 - 7.0.
- RECOMMENDED LIMESTONE CONTAINING .2% MGO WILL MEET THE MG REQUIREMENT.
- IF MANURE WILL BE APPLIED, SEE ST-10 "USE OF MANURE" 9

LABORATORY RESULTS									
6.2	50	4.1	0.19	0.6	7.8	12.6	1.5	4.7	61.5
SOIL pH	P lb/A	ACIDITY	K	Mg	Ca	CEC	K	Mg	Ca
EXCHANGEABLE CATIONS (meq/100 g)							% SATURATION		

OTHER TESTS: ORGANIC MATTER - 2.2 %

Figure 2-11. Example of soil test report (Pennsylvania State University, 1992b).

PENNSTATE



**PRE-SIDEDRESS SOIL NITROGEN TEST FOR CORN
QUICKTEST EVALUATION PROJECT**

- SOIL TEST INFORMATION AND REPORT FORM -

GROWER (PLEASE PRINT) _____

↑ NAME ↑ _____

↑ STREET OR R. D. NO. ↑ _____

↑ CITY, STATE, AND ZIP ↑ _____

↑ COUNTY ↑ _____

DATE: _____

ANALYZED BY: _____

↑ AREA CODE ↑ _____ - ↑ TELEPHONE NO. ↑ _____

Best time to call (8 am - 4:30 pm): _____

Please answer all of the following questions about this field:

1. What is the field ID (name or number)? _____ Corn Height _____ in.
2. What is the expected yield of the corn crop (bu/A or ton/A) in this field? _____
3. What was the previous crop? _____
 If this was a forage legume what was the % stand?
 (check one): 0-25% 25-50 % 50-100%
4. Was manure applied to this field? Yes No If "yes" answer the following questions:
 When? Fall Spring Both Daily
 Type? Cattle Poultry Swine Horse Sheep
 Estimate manure rate: _____ tons/acre - OR - _____ gallons/acre
 If incorporated how many days were there between spreading and incorporation? _____
5. What is the tillage program on this field? Conventional Tillage Minimum Tillage No-till
6. What would be your normal N fertilizer application rate for this field? _____ lbs. N/acre

Do not write below this line (to be completed by the analyst)

Quicktest Analysis Result & Recommendation

Individual Meter Readings	Average meter reading	Conversion factor	Average standard reading	Soil Nitrate-N (ppm)							
<table border="1" style="width: 100px; height: 40px; border-collapse: collapse;"> <tr><td> </td></tr> <tr><td> </td></tr> <tr><td> </td></tr> </table>				<table border="1" style="width: 100px; height: 30px; border-collapse: collapse;"> <tr><td> </td></tr> </table>		<table border="1" style="width: 100px; height: 30px; border-collapse: collapse;"> <tr><td style="text-align: center;">20</td></tr> </table>	20	<table border="1" style="width: 100px; height: 30px; border-collapse: collapse;"> <tr><td> </td></tr> </table>		<table border="1" style="width: 100px; height: 30px; border-collapse: collapse;"> <tr><td> </td></tr> </table>	
20											
x		÷	=								

Sidedress N Fertilizer Recommendation **lbs. N/acre**

(See table and guidelines on back of form)

If you have any questions about this test contact your Penn State Cooperative Extension Office

White copy- Grower
 Yellow copy- Analyst
 Pink copy- Agronomy Extension

5/81

Figure 2-12. Example of Penn State's soil quicktest form (Pennsylvania State University, 1992b).

**WORKSHEET FOR CALCULATING
APPLICATION RATES OF
ANIMAL MANURE ON CROPLAND**

Prepared by:
JOE CONSULTANT
Nut. Mgt. Consult.
CECIL
County

Name..... *
Address..... * LIST FERTILIZER PRICES
..... *
Field Number..... G-1 *
Field Location... _____ *
Acres in Field... 14.0 * N.... \$0.25 /lb
Manure Source.... BROILER * P2O5. \$0.25 /lb
Date/Time..... 03/07/90 *** 04:08 PM * K2O.. \$0.12 /lb

ENTER MANURE ANALYSIS DATA AND SOIL TEST INFORMATION.

MANURE COMPOSITION		SOIL TEST INFORMATION	
Total N.....	3.70 % **	Texture.....	SILT
Ammonium N.....	0.43 % **	pH.....	5.8
P2O5.....	3.70 % **	Mg.....	278.0 lb/A
K2O.....	3.10 % **	P2O5.....	112.0 lb/A
Calcium.....	1.40 % **	K2O.....	123.0 lb/A
Magnesium.....	0.56 % **	Calcium.....	1328.0 lb/A
Sulfur.....	0.59 % **	Sulfur.....	6.8 lb/A
Manganese.....	361.50 ppm **	Manganese.....	18.0 lb/A
Zinc.....	380.60 ppm **	Zinc.....	4.4 lb/A
Copper.....	352.80 ppm **	Copper.....	1.3 lb/A
Moisture.....	13.10 % **	Org. Matter....	2.5 %
Liquid Wt.....	_____ lb/100gal	(Leave blank if not liquid.)	

IF MANURE WAS APPLIED PREVIOUSLY TO THIS FIELD, ENTER DATA REQUESTED FOR PRIOR YEARS. IF NONE APPLIED, LEAVE BLANK.

	Yr. 1-2	Yr. 2-3	Yr. 3-4
Total N.....	_____ %	_____ %	_____ %
Ammonium N.....	_____ %	_____ %	_____ %
Rate.....	_____ T/A	_____ T/A	_____ T/A

**** PHOSPHORUS NOTE ****

Soil tests indicate that phosphorus levels are NOT EXCESSIVE. Additional phosphorus may be applied in animal manure. For maximum economic and environmental benefits, phosphorus levels should be monitored regularly by soil test and manure applications made ONLY to fields less than VERY HIGH in PHOSPHATE.

Figure 2-13. Example of work sheet for applying manure to cropland (University of Maryland, 1990).

fields that will be rotated into legumes, to other fields that will not receive manure applications the following year, or to sites with low runoff and low soil erosion potential.

- (10) A narrative accounting of the nutrient management plan that explains the plan and its use.

6. Cost Information

In general, most of the costs are associated with providing additional technical assistance to landowners to develop nutrient management plans. In many instances landowners can actually save money by implementing nutrient management plans. For example, Maryland has estimated (based on the over 750 nutrient management plans that were completed prior to September 30, 1990) that if plan recommendations are followed, the landowners will save an average of \$23 per acre per year (Maryland Dept. of Agriculture, 1990). The average savings may be high because most plans were for farms using animal waste. Future savings may be reduced as more farms using commercial fertilizer are included in the program.

In the South Dakota RCWP project, the total cost (1982-1991) for implementing fertilizer management on 46,571 acres was \$50,109, or \$1.08 per acre (USDA-ASCS, 1991a). In the Minnesota RCWP project, the average cost for fertilizer management for 1982-1988 was \$20 per acre (Wall et al., 1989). Assuming a cost of \$0.15 per pound of nitrogen, the savings in fertilizer cost due to improved nutrient management on Iowa corn was about \$2.25 per acre as rates dropped from 145 pounds per acre in 1985 to about 130 pounds per acre in 1989 and 1990 (Iowa State University, 1991a).

D. Pesticide Management Measure

To reduce contamination of surface water and ground water from pesticides:

- (1) Evaluate the pest problems, previous pest control measures, and cropping history;**
- (2) Evaluate the soil and physical characteristics of the site including mixing, loading, and storage areas for potential leaching or runoff of pesticides. If leaching or runoff is found to occur, steps should be taken to prevent further contamination;**
- (3) Use integrated pest management (IPM) strategies that:**
 - (a) Apply pesticides only when an economic benefit to the producer will be achieved (i.e., applications based on economic thresholds); and**
 - (b) Apply pesticides efficiently and at times when runoff losses are unlikely;**
- (4) When pesticide applications are necessary and a choice of registered materials exists, consider the persistence, toxicity, runoff potential, and leaching potential of products in making a selection;**
- (5) Periodically calibrate pesticide spray equipment; and**
- (6) Use anti-backflow devices on hoses used for filling tank mixtures.**

1. Applicability

This management measure is intended to be applied by States to activities associated with the application of pesticides to agricultural lands. Under the Coastal Zone Act Reauthorization Amendments of 1990, States are subject to a number of requirements as they develop coastal nonpoint programs in conformity with this measure and will have some flexibility in doing so. The application of management measures by States is described more fully in *Coastal Nonpoint Pollution Control Program: Program Development and Approval Guidance*, published jointly by the U.S. Environmental Protection Agency (EPA) and the National Oceanic and Atmospheric Administration (NOAA) of the U.S. Department of Commerce.

2. Description

The goal of this management measure is to reduce contamination of surface water and ground water from pesticides. The basic concept of the pesticide management measure is to foster effective and safe use of pesticides without causing degradation to the environment. The most effective approach to reducing pesticide pollution of waters is, first, to release fewer pesticides and/or less toxic pesticides into the environment and, second, to use practices that minimize the movement of pesticides to surface water and ground water (Figure 2-14). In addition, pesticides should

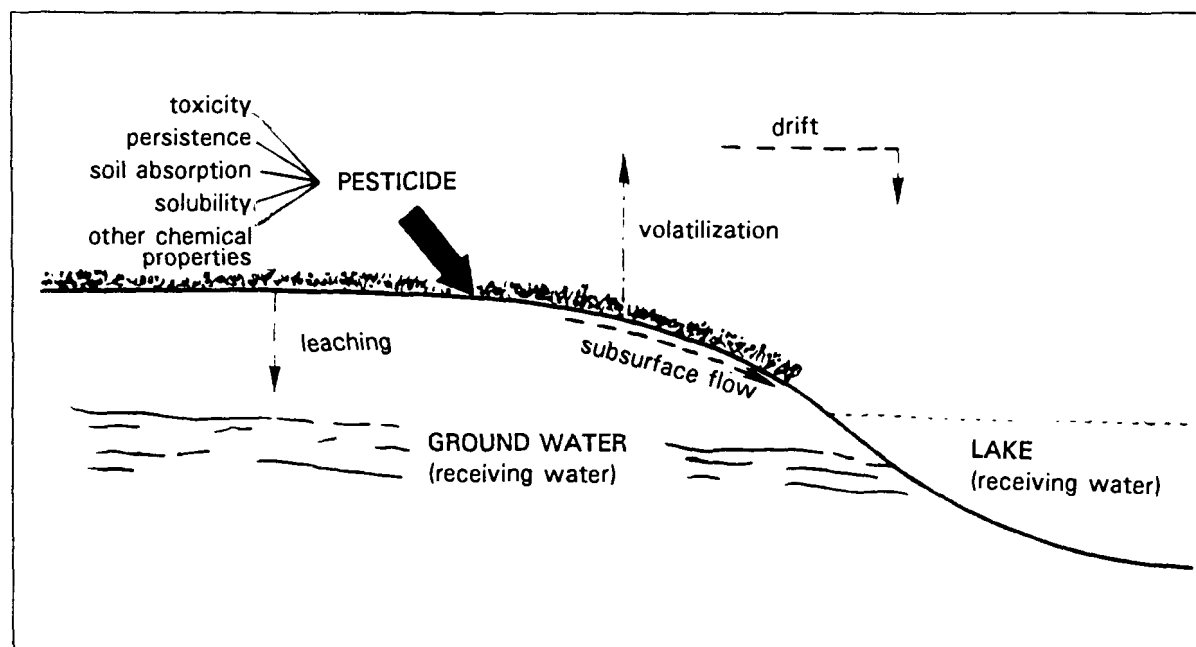

Figure 2-14. Factors affecting the transport and water quality impact of a pesticide (USEPA, 1982).

be applied only when an economic benefit to the producer will be achieved. Such an approach emphasizes using pesticides only when, and to the extent, necessary to control the target pest. This usually results in some reduction in the amount of pesticides being applied to the land, plants, or animals, thereby enhancing the protection of water quality and possibly reducing production costs as well.

The pesticide management measures identify a series of steps or thought processes that producers should use in managing pesticides. First, the pest problems, previous pest control measures, and cropping history should be evaluated. Then the physical characteristics of the soil and the site—including mixing, loading, and storage areas—should be evaluated for potential leaching and/or runoff potential. Integrated pest management (IPM) strategies should be used to minimize the amount of pesticides applied. It is understood that IPM practices are not available for some commodities or in certain regions. An effective IPM strategy should call for pesticide applications only when an economic benefit to the producer will be achieved. In addition, pesticides should be applied efficiently and at times when runoff losses are unlikely.

When pesticide applications are necessary and a choice of materials exists, producers are encouraged to choose the most environmentally benign pesticide products. Users must apply pesticides in accordance with the instructions on the label of each pesticide product. Labels include a number of requirements including allowable use rates; whether the pesticide is classified as "restricted use" for application only by certified and trained applicators; safe handling, storage, and disposal requirements; whether the pesticide can be used only under the provisions of an approved Pesticide State Management Plan; and other requirements. If label requirements include use only under an approved Pesticide State Management Plan, pesticide management measures and practices under the State Coastal Nonpoint Pollution Control Program should be consistent with and/or complement those in EPA-approved Pesticide State Management Plans.

Section 1491 of the 1990 Farm Bill requires users to maintain records of application of restricted use pesticides for a 2-year period after such use. Section 1491 of the 1990 Farm Bill also includes provisions for access to such pesticide records by Federal and State agency staff.

Operation and Maintenance for Pesticide Management

At a minimum, effective pest management requires evaluating past and current pest problems and cropping history; evaluating the physical characteristics of the site; applying pesticides only when an economic benefit to the producer will be achieved; applying pesticides efficiently and at times when runoff losses are unlikely; selecting pesticides (when a choice exists) that are the most environmentally benign; using anti-backflow devices on hoses used for filling tank mixtures; and providing suitable mixing, loading, and storage areas.

Pest management practices should be updated whenever the crop rotation is changed, pest problems change, or the type of pesticide used is changed. Application equipment should be calibrated and inspected for wear and damage each spray season, and repaired when necessary. Anti-backflow devices should also be inspected each spray season and repaired when necessary.

3. Management Measure Selection

This management measure was selected as a method to reduce the amount of pesticides entering ground water and surface water, and to foster effective and safe use of pesticides. The practices and concepts that can be used to implement this measure on a given site are those commonly used and recommended by States and USDA for general use on agricultural lands. When this measure is implemented by using the necessary mix of practices for a given site, there should be a relatively small negative economic impact on the operator's net costs and farm income, and in some cases the impact will be positive (U.S. Environmental Protection Agency, 1992). Many of the practices that can be used to implement this measure may already be required by Federal, State, or local rules, or may otherwise be in use on agricultural fields. Since many producers may already be using systems that satisfy or partly satisfy the intent of this management measure, the only action that may be necessary will be to determine the effectiveness of the existing practices and implement additional practices, if needed. Use of existing practices will reduce the time, effort, and cost of implementing this measure.

4. Effectiveness Information

Following is a summary of available information regarding pollution reductions that can be expected from using various pesticide management practices.

Use of IPM strategies is a key element of the pesticide management measures. Table 2-15 summarizes the findings of several empirical IPM studies on a variety of crops (Virginia Cooperative Extension Service et al., 1987). The summary table indicates that many studies have found IPM to reduce pesticide use. While all these studies indicate a reduction or no change in pesticide use, it is understood that in a small percentage of cases IPM can result in an increased use of pesticides as producers become more aware of what pests are present in the field and then take action to control problems.

Table 2-16 summarizes estimates of reductions in pesticide loss using various management practices and combinations of practices for cotton (North Carolina State University, 1984). These estimates are made at the field level as compared with a hypothetical field using cropping practices that were typical until the late 1970s. The uncertainty of the estimates is a function of the rapid transitions in production methods coupled with the variance among regions and seasons. Traditional sediment and erosion control practices are not as effective on cotton as on corn and soybeans because much cotton is grown on relatively flat land with little or no water erosion problem (Heimlich and Bills, 1984).

Table 2-17 summarizes the estimates of pesticide loss reductions from various management practices and combinations of practices for corn (North Carolina State University, 1984). These estimates are also made at the field level as compared with a hypothetical field using conventional, traditional, or typical cropping practices, realizing that these practices may vary considerably between geographic regions.

Banding of herbicide applications is one of the more recent and promising methods of reducing herbicide applications to corn (NRDC, 1991). Instead of applying herbicides to the entire row, herbicides are applied in a band near to the corn plant. One 3-year study conducted in Iowa on two fields of corn and one of soybeans monitored the effect of different herbicide treatments on yields and herbicide concentrations in tile-drainage water. Over the 3-year period, corn acreage with banded treatments produced equal or slightly higher yields than acreage receiving broadcast herbicides (Baker, 1988). Analysis of water samples for herbicide residues in water beneath herbicide-treated areas revealed that, during this 3-year period, atrazine was detected more often and at higher concentrations in the areas where atrazine was broadcast. Banding of herbicides means, however, that farmers have to rely more extensively on mechanical tillage and cultivation to control weeds.

Table 2-15. Results of IPM Evaluation Studies (Virginia Cooperative Extension Service et al., 1987)

Author	Study Object ^a	Pesticide Use and/or Cost of Production with IPM ^b	Yield with IPM ^c	Net Return with IPM ^d	Level of Risk with IPM ^e
Sprott et al., 1976	C	D	I	I	-
Condra et al., 1977	C	D	D	I	-
Lacewell et al., 1977	C	-	-	I	-
Clarke et al., 1980	C	-	I	I	-
Von Rumker et al., 1975	T	D	-	I	-
Von Rumker et al., 1975	P	D	I	I	-
Burrows, 1983	C,Ci	D,D	-,	-,	-,
Rajotte et al., 1984	S	D	-	I	-
Thompson et al., 1980	A	D	C	-	-
Larson et al., 1975	C	D	-	I	-
Masud et al., 1981	C	D	I	I	-
Huffaker and Croft, 1978	C,A	D,D	I,-	-,	-,
Teage and Schulstad, 1981	C	D	-	-	-
Weathers, 1979-1980	Co,S,P	D,D,D	I,I,D	I,I,I	-,,-
Lacewell et al., 1974	C	D	I	I	-
Lacewell et al., 1976	C	D	-	-	-
Casey et al., 1975	C	D	I	I	-
Allen and Roberts, 1974	S	D	-	I	-
Greene et al., 1985	S	D	-	-	-
Lindsey et al., 1976	C	-	-	I	-
Frisbie et al., 1974	C	D	I	I	-
Frisbie, 1976	C	D	-	I	-
Hoyt and Callagirone, 1971	M	D	-	-	-

Table 2-15. (Continued)

Author	Study Object ^a	Pesticide Use and/or Cost of Production with IPM ^b	Yield with IPM ^c	Net Return with IPM ^d	Level of Risk with IPM ^e
Croft et al., 1975	M	D	-	-	-
Howitt et al., 1966	A	D	-	-	-
Batiste et al., 1973	A	D	-	-	-
Eves et al., 1975	A	D	-	-	-
Hall, 1977	C	D	N	N	D
Prokopy et al., 1973	A	-	-	I	-
McGuckin, 1983	Al	D	-	I	D
King and O'Rourke, 1977	A	D	-	-	-
Cammell and Way, 1977	F	-	-	I	D
Liapis and Moffit, 1983	C	-	-	-	D
Miranowski, 1974	C	D	-	-	-
Huffaker, 1980	C	D	-	-	-
Reichelderfer, 1979	Pe	D	-	I	-
Carlson, 1969	Pc	-	-	-	D
Carlson, 1979	C	-	-	-	D
Lazarus and Swanson, 1983	Co,S	-,	-,	-,	I,I
Moffitt et al., 1982	S	-	-	-	D
Hatcher et al., 1984	C,P,S	-,,-	I,I,I	N,I,I	-,,-
White and Thompson, 1982	A	D	-	-	-

^a C = cotton; T = tobacco; P = peanut; Ci = citrus; S = soybean; A = apple; Co = corn; M = mite; Al = alfalfa; F = field bean; Pe = pecan; Pc = peach.

^{b,c,d,e} C = constant; D = decreased; I = increased; N = no impact; - = no information.

Table 2-16. Estimates of Potential Reductions in Field Losses of Pesticides for Cotton Compared to a Conventionally and/or Traditionally Cropped Field^a (North Carolina State University, 1984)

Management Practice	Transport Route(s)	Range of Pesticide Loss Reduction (%) ^b
SWCPs		
Terracing	SR and SL	0 - (20) ^c
Contouring	SR and SL	0 - (20) ^c
Reduced Tillage	SR and SL	-40 - +20 AB
Grassed Waterways	SR and SL	0 - 10 AB
Sediment Basins	SR	0 - 10 AB
Filter Strips	SR	0 - 10 A
Cover Crops	SR and SL	-20 - +10 B
Optimal Application Techniques ^d	All Routes ^e	40 - 80 A
Nonchemical Methods		
Scouting Economic Thresholds	All Routes	40 - 65 A 0 - 30 B
Crop Rotations	All Routes	0 - 20 A 10 - 30 B
Pest-Resistant Varieties	All Routes	0 - 60 A 0 - 30 B
Alternative Pesticides	All Routes	60 - 95 A 0 - 20 B

SR = surface runoff

SL = soil leaching

^a The hypothetical traditionally cropped comparison field uses the following management system:

- (1) conventional tillage without other soil and water conservation practices;
- (2) aerial application of all pesticides with timing based only on field operation convenience;
- (3) ten insecticide treatments annually with a total application of 12 kg/ha based on a prescribed schedule;
- (4) cotton grown in 3 out of 4 years; and
- (5) long-season cotton varieties.

^b Assumes field loss reductions are proportional to application rate reductions.

A = insecticides (toxaphene, methylparathion, synthetic pyrethroids).

B = herbicides (trifluralin, fluometron).

Ranges allow for variation in production region, climate, slope and soils.

^c Refers to estimated increases in movement through soil profile.

^d Defined for cotton as ground application using optimal droplet or granular size ranges with spraying restricted to calm periods in late afternoon or at night when precipitation is not imminent.

^e Particularly drift and volatilization.

Table 2-17. Estimates of Potential Reductions in Field Losses of Pesticides for Corn Compared to a Conventionally and/or Traditionally Cropped Field^a (North Carolina State University, 1984)

Management Practice	Transport Route(s) Affected	Range of Pesticide Loss Reduction (%) ^b
SWCPs	SR and/or SL(#)	
Terracing	SR and/or SL	40 - 75 AB (25°)
Contouring	SR and/or SL	15 - 55 AB (20°)
No-till	SR and/or SL	-10 - +40 B 60 - +10 A (10°)
Other Reduced Tillage	SR and/or SL	-10 - +60 B -40 - +20 A (15°)
Grassed Waterways	SR	-10 - 20 AB
Sediment Basins	SR	0 - 10 AB
Filter Strips	SR	0 - 10 AB
Cover Crops	SR and/or SL	0 - 20 B ^d
Optimal Application Techniques ^e	All Routes ^f	10 - 20 20 - 40 B
Nonchemical Methods	All Routes	
Adequate Monitoring	All Routes	40 - 65 A
Crop Rotations	All Routes	40 - 70 A 10 - 30 B

SR = surface runoff

SL = soil leaching

^a The hypothetical field used as the basis for comparison uses the following management system:

- (1) conventional tillage without other soil and water conservation practices;
- (2) ground application with timing based only on field operation convenience;
- (3) little or no pest monitoring; spraying on prescribed schedule; and
- (4) corn grown in 3 out of 4 years.

^b Assumes field loss reductions are proportional to application rate reductions.

A = insecticides (carbofuran and organophosphates)

B = herbicides (Triazine, Alachlor, Butylate, Parquat)

Ranges allow for variation in climate, slope, soils, and types of pesticides used. Ranges for no-till and reduced-till are derived from a combination of increased application rates and decreased runoff losses.

^c Refers to estimated increases in movement through soil profile.

^d Cover crops will affect runoff and leaching losses only for pesticides persistent enough to be available over the non-growing season. In the case of pesticides used on corn only the triazine and anilide herbicides will generally meet this criterion.

^e Defined here for corn as ground application using optimal droplet or granular size ranges, with spraying restricted to calm periods in late afternoon or evening.

^f Particularly drift and volatilization.

5. Pesticide Management Practices

As discussed more fully at the beginning of this chapter and in Chapter 1, the following practices are described for illustrative purposes only. State programs need not require implementation of these practices. However, as a practical matter, EPA anticipates that the management measure set forth above generally will be implemented by applying one or more management practices appropriate to the source, location, and climate. The practices set forth below have been found by EPA to be representative of the types of practices that can be applied successfully to achieve the management measure described above. The U.S. Soil Conservation Service practice number and definition are provided for management practices, where available.

- a. *Inventory current and historical pest problems, cropping patterns, and use of pesticides for each field.*

This can be accomplished by using a farm and field map, and by compiling the following information for each field:

- Crops to be grown and a history of crop production;
 - Information on soils types;
 - The exact number of acres within each field; and
 - Records on past pest problems, pesticide use, and other information for each field.
- b. *Consider the soil and physical characteristics of the site including mixing, loading and storage areas for potential for the leaching and/or runoff of pesticides.*

In situations where the potential for loss is high, emphasis should be given to practices and/or management practices that will minimize these potential losses. The physical characteristics to be considered should include limitations based on environmental hazards or concerns such as:

- Sinkholes, wells, and other areas of direct access to ground water such as karst topography;
 - Proximity to surface water;
 - Runoff potential;
 - Wind erosion and prevailing wind direction;
 - Highly erodible soils;
 - Soils with poor adsorptive capacity;
 - Highly permeable soils;
 - Shallow aquifers; and
 - Wellhead protection areas.
- c. *Use IPM strategies to minimize the amount of pesticides applied.*

Following is a list of IPM strategies:

- Use of biological controls:
 - introduction and fostering of natural enemies;
 - preservation of predator habitats; and
 - release of sterilized male insects;
- Use of pheromones:
 - for monitoring populations;
 - for mass trapping;
 - for disrupting mating or other behaviors of pests; and
 - to attract predators/parasites;
- Use of crop rotations to reduce pest problems;
- Use of improved tillage practices such as ridge tillage;

- Use of cover crops in the system to promote water use and reduce deep percolation of water that contributes to leaching of pesticides into ground water;
- Destruction of pest breeding, refuge, and overwintering sites (this may result in loss of crop residue cover and an increased potential for erosion);⁸
- Use of mechanical destruction of weed seed;⁸
- Habitat diversification;
- Use of allelopathy characteristics of crops;
- Use of resistant crop strains;
- Pesticide application based on economic thresholds, i.e., apply pesticides when an economic threshold level has been reached as opposed to applying pesticides in anticipation of pest problems;
- Use of periodic scouting to determine when pest problems reach the economic threshold on each field;
- Use of less environmentally persistent, toxic, and/or mobile pesticides;
- Use of timing of field operations (planting, cultivating, irrigation, and harvesting) to minimize application and/or runoff of pesticides; and
- Use of more efficient application methods, e.g., spot spraying and banding of pesticides.

■ d. *When pesticide applications are necessary and a choice of materials exists, consider the persistence, toxicity, and runoff and leaching potential of products along with other factors, including current label requirements, in making a selection.*

Users must apply pesticides in accordance with the instructions on the label of each pesticide product and, when required, must be trained and certified in the proper use of the pesticide. Labels include a number of requirements including allowable use rates; classification of pesticides as "restricted use" for application only by certified applicators; safe handling, storage, and disposal requirements; restrictions required by State Pesticide Management Plans to protect ground water; and other requirements. If label requirements include use only under an approved State Pesticide Management Plan, pesticide management measures and practices under the State Coastal Nonpoint Program should be consistent with and/or complement those in approved State Pesticide Management Plans.

■ e. *Maintain records of application of restricted use pesticides (product name, amount, approximate date of application, and location of application of each such pesticide used) for a 2-year period after such use, pursuant to the requirements in section 1491 of the 1990 Farm Bill.*

Section 1491 requires that such pesticide records shall be made available to any Federal or State agency that deals with pesticide use or any health or environmental issue related to the use of pesticides, on the request of such agency. Section 1491 also provides that Federal or State agencies may conduct surveys and record the data from individual applicators to facilitate statistical analysis for environmental and agronomic purposes, *but in no case may a government agency release data, including the location from which the data was derived, that would directly or indirectly reveal the identity of individual producers.* Section 1491 provides that in the case of Federal agencies, access to records maintained under section 1491 shall be through the Secretary of Agriculture, or the Secretary's designee. This section also provides that State agency requests for access to records maintained under section 1491 shall be through the lead State agency so designated by the State.

Section 1491 includes special access provisions for health care personnel. Specifically, when a health professional determines that pesticide information maintained under this section is necessary to provide medical treatment or first aid to an individual who may have been exposed to pesticides for which the information is maintained, upon request persons required to maintain records under section 1491 shall promptly provide record and available label information to that health professional. In the case of an emergency, such record information shall be provided immediately.

⁸ Several IPM strategies listed above emphasize the use of mechanical tillage and removal of crop residue cover. Such IPM strategies may result in some producers being out of compliance with the U.S. Department of Agriculture's requirements for highly erodible land, and such producers may need to consider other IPM strategies on such highly erodible land.

Operators may consider maintaining records beyond those required by section 1491 of the 1990 Farm Bill. For example, operators may want to maintain records of *all* pesticides used for each field, i.e., not just restricted use pesticides. In addition, operators may want to maintain records of other pesticide management activities such as scouting records or other IPM techniques used and procedures used for disposal of remaining pesticides after application.

- f. *Use lower pesticide application rates than those called for by the label when the pest problem can be adequately controlled using such lower rates.*
- g. *Consider the use of organic farming techniques that do not rely on the use of synthetically compounded pesticides.*
- h. *Recalibrate spray equipment each spray season and use anti-backflow devices on hoses used for filling tank mixtures.*

Purchase new, more precise application equipment and other related farm equipment (including improved nozzles, computer sensing to control flow rates, radar speed determination, electrostatic applicators, and precision equipment for banding and cultivating) as replacement equipment is needed.

- i. *Integrated crop management system (Pest Management 595): A total crop management system that promotes the efficient use of pesticide and nutrients in an environmentally sound and economically efficient manner.*

6. Cost Information

In general, most of the costs of implementing the pesticide management measure are program costs associated with providing additional educational programs and technical assistance to producers to evaluate pest management needs and for field scouting during the growing season. Producers may actually save money by implementing IPM strategies as indicated by the data in Table 2-15.

Table 2-15 summarizes the findings of several IPM studies on a variety of crops (Virginia Cooperative Extension Service et al., 1987). This summary table indicates that, in general, IPM reduces pesticide use, increases yields, increases net returns, and decreases economic risk.

Table 2-18 shows that IPM scouting costs vary by crop type and by region (USEPA, 1992). High and low scouting costs are given for major crops in each of the coastal regions. These costs reflect variations in the level of service provided by various crop consultants. For example, in the Great Lakes region, the relatively low cost of \$4.95 per acre is based on five visits per season at the request of the producer. Higher cost services include scouting and weekly written reports during the growing seasons. Cost differences may also reflect differences in the size of farms (i.e., number of acres) and distance between farms.

The variations in scouting costs between regions and within regions also occur because of differences in the provider of the service. For example, in some States the Cooperative Extension Service provides scouting services at no cost or for a nominal fee. In other areas of the coastal zone, farmer cooperatives have formed crop management associations to provide scouting and crop fertility/pest management recommendations.

Scouting costs also vary by crop type. For example, the data in Table 2-18 indicate that scouting costs for fresh market vegetables are higher than for all other crop types. Scouting services for high-value cash crops, such as fruits and vegetables, must be very intensive given that pest damage is permanent and may make the crop unmarketable.

Costs for erosion and sediment control and for irrigation management are discussed in Sections II.A and II.F, respectively, of this chapter.

Table 2-18. Estimated Scouting Costs (dollars/acre) by Coastal Region and Crop in the Coastal Zone in 1992 (USEPA, 1992)

Coastal Region	Crop						
	Corn	Soybean	Wheat	Rice	Cotton	Fresh Market Vegetables ^a	Hay ^b
Northeast							
Low	5.50	NA	3.75	—	—	25.00	2.50
High	6.25	NA	4.50	—	—	28.00	2.75
Southeast							
Low	5.00	3.25	3.00	8.00	6.00	30.00	2.00
High	6.00	4.00	3.50	12.00	8.00	35.00	3.00
Gulf Coast							
Low	6.00	4.50	—	5.00	6.00	35.00	—
High	8.00	6.50	—	9.00	9.00	40.00	—
Great Lakes							
Low	4.95	4.25	3.75	—	—	—	4.75
High	5.50	5.00	4.00	—	—	—	5.25
West Coast							
Low	NA	NA	3.50	NA	6.75	32.00	NA
High	NA	NA	5.50	NA	9.30	38.00	NA

NA = not available

— = not applicable

^a Most fresh market vegetables are produced under a regular spraying schedule.^b Scouting costs for hay are based on alfalfa insect inspection. The higher cost in the Great Lakes region includes pesticide and soil sampling.

7. Relationship of Pesticide Management Measure to Other Programs

Under the Federal Insecticide, Fungicide and Rodenticide Act (FIFRA), EPA registers pesticides on the basis of evaluation of test data showing whether a pesticide has the potential to cause unreasonable adverse effects on humans, animals, or the environment. Data requirements include environmental fate data showing how the pesticide behaves in the environment, which are used to determine whether the pesticide poses a threat to ground water or surface water. If the pesticide is registered, EPA imposes enforceable label requirements, which can include, among other things, maximum rates of application, classification of the pesticide as a "restricted use" pesticide (which restricts use to certified applicators trained to handle toxic chemicals), or restrictions on use practices, including requiring compliance with EPA-approved Pesticide State Management Plans (described below). EPA and the U.S. Department of Agriculture Cooperative Extension Service provide assistance for pesticide applicator and certification training in each State.

FIFRA allows States to develop more stringent pesticide requirements than those required under FIFRA, and some States have chosen to do this. At a minimum, management measures and practices under State Coastal Nonpoint Source Programs must not be less stringent than FIFRA label requirements or any applicable State requirements.

EPA's *Pesticides and Groundwater Strategy* (USEPA, 1991b) describes the policies and regulatory approaches EPA will use to protect the Nation's ground-water resources from risks of contamination by pesticides under FIFRA. The objective of the strategy is the prevention of ground-water contamination by regulating the use of certain pesticides

(i.e., use according to EPA-approved labeling) in order to reduce and, if necessary, eliminate releases of the pesticide in areas vulnerable to contamination. Priority for protection will be based on currently used and reasonably expected sources of drinking water supplies, and ground water that is closely hydrogeologically connected to surface waters. EPA will use Maximum Contaminant Levels (MCLs) under the Safe Drinking Water Act as "reference points" for water resource protection efforts when the ground water in question is a current or reasonably expected source of drinking water.

The Strategy describes a significant new role for States in managing the use of pesticides to protect ground water from pesticides. In certain cases, when there is sufficient evidence that a particular use of a pesticide has the potential for ground-water contamination to the extent that it might cause unreasonable adverse effects, EPA may (through the use of existing statutory authority and regulations) limit legal use of the product to those States with an acceptable Pesticide State

Management Plan, approved by EPA. Plans would tailor use to local hydrologic conditions and would address:

- State philosophy;
- Roles and responsibilities of State and local agencies;
- Legal and enforcement authority;
- Basis for assessment and planning;
- Prevention measures;
- Ground-water monitoring;
- Response to detections;
- Information dissemination; and
- Public participation.

In the absence of such an approved plan, affected pesticides could not be legally used in the State.

Since areas to be managed under Pesticide State Management Plans and Coastal Nonpoint Pollution Control Programs can overlap, State coastal zone and nonpoint source agencies should work with the State lead agency for pesticides (or the State agency that has a lead role in developing and implementing the Pesticide State Management Plan) in the development of pesticide management measures and practices under both programs. This is necessary to avoid duplication of effort and conflicting pesticide requirements between programs. Further, ongoing coordination will be necessary since both programs and management measures will evolve and change with increasing technology and data.

Section 1491 of the 1990 Farm Bill requires recordkeeping for restricted use pesticides for a 2-year period after such use. Specifically, records of pesticide applications are to include product name, amount, approximate date of application, and location of application of each pesticide used. Section 1491 also specifies the limitations on access to these records by governmental agencies and health care personnel (see practice "e" under "Pesticide Management Practices" for additional information regarding access to such records).

E. Grazing Management Measure

Protect range, pasture and other grazing lands:

(1) By implementing one or more of the following to protect sensitive areas (such as streambanks, wetlands, estuaries, ponds, lake shores, and riparian zones):

- (a) Exclude livestock,**
- (b) Provide stream crossings or hardened watering access for drinking,**
- (c) Provide alternative drinking water locations,**
- (d) Locate salt and additional shade, if needed, away from sensitive areas, or**
- (e) Use improved grazing management (e.g., herding)**

to reduce the physical disturbance and reduce direct loading of animal waste and sediment caused by livestock; and

(2) By achieving either of the following on all range, pasture, and other grazing lands not addressed under (1):

- (a) Implement the range and pasture components of a Conservation Management System (CMS) as defined in the Field Office Technical Guide of the USDA-SCS (see Appendix 2A of this chapter) by applying the progressive planning approach of the USDA-Soil Conservation Service (SCS) to reduce erosion, or**
- (b) Maintain range, pasture, and other grazing lands in accordance with activity plans established by either the Bureau of Land Management of the U.S. Department of the Interior or the Forest Service of USDA.**

1. Applicability

The management measure is intended to be applied by States to activities on range, irrigated and nonirrigated pasture, and other grazing lands used by domestic livestock. Under the Coastal Zone Act Reauthorization Amendments of 1990, States are subject to a number of requirements as they develop coastal nonpoint programs in conformity with this measure and will have some flexibility in doing so. The application of management measures by States is described more fully in *Coastal Nonpoint Pollution Control Program: Program Development and Approval Guidance*, published jointly by the U.S. Environmental Protection Agency (EPA) and the National Oceanic and Atmospheric Administration (NOAA) of the U.S. Department of Commerce.

Range is those lands on which the native vegetation (climax or natural potential plant community) is predominantly grasses, grasslike plants, forbs, or shrubs suitable for grazing or browsing use. Range includes natural grassland, savannas, many wetlands, some deserts, tundra, and certain forb and shrub communities. Pastures are those lands that are primarily used for the production of adapted, domesticated forage plants for livestock. Other grazing lands include woodlands, native pastures, and croplands producing forages.

The major differences between range and pasture are the kind of vegetation and level of management that each land area receives. In most cases, range supports native vegetation that is extensively managed through the control of livestock rather than by agronomy practices, such as fertilization, mowing, irrigation, etc. Range also includes areas that have been seeded to introduced species (e.g., crested wheatgrass), but which are extensively managed like native range. Pastures are represented by those lands that have been seeded, usually to introduced species (e.g., tall fescue) or in some cases to native plants (e.g., switchgrass), and which are intensively managed using agronomy practices and control of livestock.

2. Description

The focus of the grazing management measure is on the riparian zone, yet the control of erosion from range, pasture, and other grazing lands above the riparian zone is also encouraged. Application of this management measure will reduce the physical disturbance to sensitive areas and reduce the discharge of sediment, animal waste, nutrients, and chemicals to surface waters. For information regarding potential problems caused by grazing, see Sections I.F.2 and I.F.6 of this chapter.

The key options to consider (all are not required by this management measure) when developing a comprehensive grazing management approach at a particular location include the development of one or more of the following:

- Grazing management systems. These systems ensure proper grazing use through:
 - Grazing frequency (includes complete rest);
 - Livestock stocking rates;
 - Livestock distribution;
 - Timing (season of forage use) and duration of each rest and grazing period;
 - Livestock kind and class; and
 - Forage use allocation for livestock and wildlife.
- Proper water and salt supplement facilities.
- Livestock access control.
- Range or pasture rehabilitation.

For any grazing management system to work, it must be tailored to fit the needs of the vegetation, terrain, class or kind of livestock, and particular operation involved.

For both pasture and range, areas should be provided for livestock watering, salting, and shade that are located away from streambanks and riparian zones where necessary and practical. This will be accomplished by managing livestock grazing and providing facilities for water, salt, and shade as needed.

Special attention must be given to grazing management in riparian and wetland areas if management measure objectives are to be met. For purposes of this guidance, riparian areas are defined (Mitsch and Gosselink, 1986; Lowrance et al., 1988) as:

Vegetated ecosystems along a waterbody through which energy, materials, and water pass. Riparian areas characteristically have a high water table and are subject to periodic flooding and influence from the adjacent waterbody.

The health of the riparian system, and thus the quality of water, is dependent on the use, management, and condition of the related uplands. Therefore, the proper management of riparian and wetland ecosystems will involve the correct management of livestock grazing and other land uses in the total watershed.

Conservation management systems (CMS) include any combination of conservation practices and management that achieves a level of treatment of the five natural resources (i.e., soil, water, air, plants, and animals) that satisfies criteria contained in the Soil Conservation Service (SCS) Field Office Technical Guide (FOTG), such as a resource management system (RMS) or an acceptable management system (AMS). These criteria are developed at the State level, with concurrence by the appropriate SCS National Technical Center (NTC). The criteria are then applied in the provision of field office technical assistance, under the direction of the District Conservationist of SCS. In-state coordination of FOTG use is provided by the Area Conservationist and State Conservationist of SCS.

The range and pasture components of a CMS address erosion control, proper grazing, adequate pasture stand density, and range condition. National (minimum) criteria pertaining to range and pasture under an RMS are applied to achieve environmental objectives, conserve natural resources, and prevent soil degradation.

The practical limits of resource protection under a CMS within any given area are determined through the application of national social, cultural, and economic criteria. With respect to economics, landowners will not be required to implement an RMS if the system is generally too costly for landowners. Instead, landowners may be required to implement a less costly, and less protective, AMS. In some cases, landowner constraints may be such that an RMS or AMS cannot be implemented quickly. In these situations, a "progressive planning approach" may be used to ultimately achieve planning and application of an RMS or AMS. Progressive planning is the incremental process of building a plan on part or all of the planning unit over a period of time. For additional details regarding CMS, RMS, and AMS, see Appendix 2A of this chapter.

3. Management Measure Selection

This management measure was selected based on an evaluation of available information that documents the beneficial effects of improved grazing management (see "Effectiveness Information" below). Specifically, the available information shows that (1) aquatic habitat conditions are improved with proper livestock management; (2) pollution from livestock is decreased by reducing the amount of time spent in the stream through the provision of supplemental water; and (3) sediment delivery is reduced through the proper use of vegetation, streambank protection, planned grazing systems, and livestock management.

4. Effectiveness Information

Hubert et al. (1985) showed in plot studies in Wyoming that livestock exclusion and reductions in stocking rates can result in improved habitat conditions for brook trout (Table 2-19). In this study, the primary vegetation was willows, Pete Creek stocking density was 7.88 ac/AUM (acres per animal unit month), and Cherry Creek stocking density was 10 cows per acre.

Platts and Nelson (1989) used plot studies in Utah to evaluate the effects of livestock exclusion on riparian plant communities and streambanks. Several streambank characteristics that are related to the quality of fish habitat were measured, including bank stability, stream shore depth, streambank angle, undercut, overhang, and streambank alteration. The results clearly show better fish habitat in the areas where livestock were excluded (Table 2-20).

Kauffman et al. (1983) showed that fall cattle grazing decreases the standing phytomass of some riparian plant communities by as much as 21 percent versus areas where cattle are excluded, while causing increases for other plant communities. This study, conducted in Oregon from 1978 to 1980, incorporated stocking rates of 3.2 to 4.2 ac/AUM.

Eckert and Spencer (1987) studied the effects of a three-pasture, rest-rotation management plan on the growth and reproduction of heavily grazed native bunchgrasses in Wyoming. The results indicated that range improvement under this otherwise appropriate rotation grazing system is hindered by heavy grazing. Stocking rates on the study plots ranged from 525 to 742 cow-calf AUMs.

Table 2-19. Grazing Management Influences on Two Brook Trout Streams in Wyoming (Hubert et al., 1985)

Parameter	Pete Creek (n=3)		Cherry Creek (n=4)	
	Heavily Grazed (mean)	Lightly Grazed (mean)	Outside Exclosure (mean)	Inside Exclosure (mean)
Width	2.9	2.2 ^a	2.9	2.5 ^a
Depth	0.07	0.11 ^a	0.08	0.09 ^a
Width/depth ratio	43	21	37	28 ^a
Coefficient of variation in depth	47.3	66.6 ^a	57	71
Percent greater than 22 cm deep	9.0	22.3 ^b	6.7	21.0 ^a
Percent overhanging bank cover	2.7	30.0 ^a	24.0	15.3
Percent overhanging vegetation	0	11.7 ^a	8.5	18.0
Percent shaded area	0.7	18.3 ^a	23.5	28.0
Percent silt substrate	35	52	22	13 ^a
Percent bare soil along banks	19.7	13.3	22.8	12.3 ^a
Percent litter along banks	7.0	6.0	10.0	6.8 ^a

^a Indicates statistical significance at $p \leq 0.05$.

^b Indicates statistical significance at $p \leq 0.1$.

In a literature review, Van Poolen and Lacey (1979) showed that herbage production was greater for managed grazing versus continuous grazing, greater for moderate versus heavy intensity grazing, and greater for light- versus moderate-intensity grazing.

McDougald et al. (1989) tested the effects of moving supplemental feeding locations on riparian areas of hardwood range in California. With stocking rates of approximately 1 ac/AUM, they found that moving supplemental feeding locations away from water sources into areas with high amounts of forage greatly reduces the impacts of cattle on riparian areas (Table 2-21).

Table 2-20. Streambank Characteristics for Grazed Versus Rested Riparian Areas (Platts and Nelson, 1989)

Streambank Characteristic (unit)	Grazed	Rested
Extent (m)	4.1	2.5
Bank stability (%)	32.0	88.5
Stream-short depth (cm)	6.4	14.9
Bank angle (°)	127.0	81.0
Undercut (cm)	6.4	16.5
Overhang (cm)	1.8	18.3
Streambank alteration (%)	72.0	19.0

Table 2-21. The Effects of Supplemental Feeding Location on Riparian Area Vegetation (McDougald et al., 1989)

Practice	Percentage of riparian area with the following levels of residual dry matter in early October		
	Low	Moderate	High
Supplemental feeding located close to riparian areas:			
1982-85 Range Unit 1	48	39	13
1982-85 Range Unit 8	59	29	12
1986-87 Range Unit 8	54	33	13
Supplemental feeding moved away from riparian area:			
1986-87 Range Unit 1	1	27	72

Miner et al. (1991) showed that the provision of supplemental water facilities reduced the time each cow spent in the stream within 4 hours of feeding from 14.5 minutes to 0.17 minutes (8-day average). This pasture study in Oregon showed that the 90 cows without supplemental water spent a daily average of 25.6 minutes per cow in the stream. For the 60 cows that were provided a supplemental water tank, the average daily time in the stream was 1.6 minutes per cow, while 11.6 minutes were spent at the water tank. Based on this study, the authors expect that decreased time spent in the stream will decrease bacterial loading from the cows.

Tiedemann et al. (1988) studied the effects of four grazing strategies on bacteria levels in 13 Oregon watersheds in the summer of 1984. Results indicate that lower fecal coliform levels can be achieved at stocking rates of about 20 ac/AUM if management for livestock distribution, fencing, and water developments are used (Table 2-22). The study also indicates that, even with various management practices, the highest fecal coliform levels were associated with the higher stocking rates (6.9 ac/AUM) employed in strategy D.

Lugbill (1990) estimates that stream protection in the Potomac River Basin will reduce total nitrogen (TN) and total phosphorus (TP) loads by 15 percent, while grazing land protection and permanent vegetation improvement will reduce TN and TP loads by 60 percent. Owens et al. (1982) measured nitrogen losses from an Ohio pasture under a medium-fertility, 12-month pasture program from 1974 to 1979. The results included no measurable soil loss from three watersheds under summer grazing only, and increased average TN concentrations and total soluble N loads from watersheds under summer grazing and winter feeding versus watersheds under summer grazing only (Table 2-23).

Table 2-22. Bacterial Water Quality Response to Four Grazing Strategies (Tiedemann et al., 1988)

Practice	Geometric Mean Fecal Coliform Count
Strategy A: Ungrazed.	40/L
Strategy B: Grazing without management for livestock distribution; 20.3 ac/AUM.	150/L
Strategy C: Grazing with management for livestock distribution: fencing and water developments; 19.0 ac/AUM.	90/L
Strategy D: Intensive grazing management, including practices to attain uniform livestock distribution and improve forage production with cultural practices such as seeding, fertilizing, and forest thinning; 6.9 ac/AUM.	920/L

Table 2-23. Nitrogen Losses from Medium-Fertility, 12-Month Pasture Program (Owens et al., 1982)

Practice	Soil Loss (kg/ha)	Total Sediment N Transport (kg/ha)	Total N Concentration (mg/l) ^a	Total Soluble N Transport (kg/ha) ^a
Summer Grazing Only				
Growing season	—	—	3.7	0.4
Dormant season	—	—	1.8	0.1
Year	—	—	3.0	0.5
Summer Grazing - Winter Feeding				
Growing season	251	1.4	4.9	2.5
Dormant season	1,104	6.6	14.6	11.3
Year	1,355	8.0	10.7	13.8

^a Five-year average (1974-1979)

Data from a comparison of the expected effectiveness of various grazing and streambank practices in controlling sedimentation in the Molar Flats Pilot Study Area in Fresno County, California indicate that planned grazing systems are the most effective single practice for reducing sheet and rill erosion (Fresno Field Office, 1979). Streambank protection is expected to be the most effective single practice for reducing streambank erosion. Other practices evaluated are proper grazing use, deferred grazing, emergency seeding, and livestock exclusion.

5. Range and Pasture Management Practices

As discussed more fully at the beginning of this chapter and in Chapter 1, the following practices are described for illustrative purposes only. State programs need not require implementation of these practices. However, as a practical matter, EPA anticipates that the management measure set forth above generally will be implemented by applying one or more management practices appropriate to the source, location, and climate. The practices set forth below have been found by EPA to be representative of the types of practices that can be applied successfully to achieve the management measure described above.

The U.S. Soil Conservation Service practice number and definition are provided for each management practice, where available. Also included in italics are SCS statements describing the effect each practice has on water quality (USDA-SCS, 1988.)

Grazing Management System Practices

Appropriate grazing management systems ensure proper grazing use by adjusting grazing intensity and duration to reflect the availability of forage and feed designated for livestock uses, and by controlling animal movement through the operating unit of range or pasture. Proper grazing use will maintain enough live vegetation and litter cover to protect the soil from erosion; will achieve riparian and other resource objectives; and will maintain or improve the quality, quantity, and age distribution of desirable vegetation. Practices that accomplish this are:

- a. *Deferred grazing (352): Postponing grazing or resting grazing land for prescribed period.*

In areas with bare ground or low percent ground cover, deferred grazing will reduce sediment yield because of increased ground cover, less ground surface disturbance, improved soil bulk density characteristics, and greater infiltration rates. Areas mechanically treated will have less sediment yield when deferred to encourage re-vegetation. Animal waste would not be available to the area during the time of deferred grazing and there would be less opportunity for adverse runoff effects on surface or aquifer water quality. As vegetative cover increases, the filtering processes are enhanced, thus trapping more silt and nutrients as well as snow if climatic conditions for snow exist. Increased plant cover results in a greater uptake and utilization of plant nutrients.

- b. *Planned grazing system (556): A practice in which two or more grazing units are alternately rested and grazed in a planned sequence for a period of years, and rest periods may be throughout the year or during the growing season of key plants.*

Planned grazing systems normally reduce the system time livestock spend in each pasture. This increases quality and quantity of vegetation. As vegetation quality increases, fiber content in manure decreases which speeds manure decomposition and reduces pollution potential. Freeze-thaw, shrink-swell, and other natural soil mechanisms can reduce compacted layers during the absence of grazing animals. This increases infiltration, increases vegetative growth, slows runoff, and improves the nutrient and moisture filtering and trapping ability of the area.

Decreased runoff will reduce the rate of erosion and movement of sediment and dissolved and sediment-attached substances to downstream water courses. No increase in ground water pollution hazard would be anticipated from the use of this practice.

- c. *Proper grazing use (528): Grazing at an intensity that will maintain enough cover to protect the soil and maintain or improve the quantity and quality of desirable vegetation.*

Increased vegetation slows runoff and acts as a sediment filter for sediments and sediment attached substances, uses more nutrients, and reduces raindrop splash. Adverse chemical effects should not be anticipated from the use of this practice.

- d. *Proper woodland grazing (530): Grazing wooded areas at an intensity that will maintain adequate cover for soil protection and maintain or improve the quantity and quality of trees and forage vegetation.*

This practice is applicable on wooded areas producing a significant amount of forage that can be harvested without damage to other values. In these areas there should be no detrimental effects on the quality of surface and ground water. Any time this practice is applied there must be a detailed management and grazing plan.

- e. *Pasture and hayland management (510): Proper treatment and use of pasture or hayland.*

With the reduced runoff there will be less erosion, less sediment and substances transported to the surface waters. The increased infiltration increases the possibility of soluble substances leaching into the ground water.

Alternate Water Supply Practices

Providing water and salt supplement facilities away from streams will help keep livestock away from streambanks and riparian zones. The establishment of alternate water supplies for livestock is an essential component of this measure when problems related to the distribution of livestock occur in a grazing unit. In most western states, securing water rights may be necessary. Access to a developed or natural water supply that is protective of streambank and riparian zones can be provided by using the stream crossing (interim) technology to build a watering site. In some locations, artificial shade may be constructed to encourage use of upland sites for shading and loafing. Providing water can be accomplished through the following Soil Conservation Service practices and the stream crossing (interim) practice (practice "m") of the following section. Descriptions have been modified to meet CZM needs:

- f. *Pipeline (516): Pipeline installed for conveying water for livestock or for recreation.*

Pipelines may decrease sediment, nutrient, organic, and bacteria pollution from livestock. Pipelines may afford the opportunity for alternative water sources other than streams and lakes, possibly keeping the animals away from the stream or impoundment. This will prevent bank destruction with resulting sedimentation, and will reduce animal

waste deposition directly in the water. The reduction of concentrated livestock areas will reduce manure solids, nutrients, and bacteria that accompany surface runoff.

- g. **Pond (378):** A water impoundment made by constructing a dam or an embankment or by excavation of a pit or dugout.

Ponds may trap nutrients and sediment which wash into the basin. This removes these substances from downstream. Chemical concentrations in the pond may be higher during the summer months. By reducing the amount of water that flows in the channel downstream, the frequency of flushing of the stream is reduced and there is a collection of substances held temporarily within the channel. A pond may cause more leachable substance to be carried into the ground water.

- h. **Trough or tank (614):** A trough or tank, with needed devices for water control and waste water disposal, installed to provide drinking water for livestock.

By the installation of a trough or tank, livestock may be better distributed over the pasture, grazing can be better controlled, and surface runoff reduced, thus reducing erosion. By itself this practice will have only a minor effect on water quality; however when coupled with other conservation practices, the beneficial effects of the combined practices may be large. Each site and application should be evaluated on their own merits.

- i. **Well (642):** A well constructed or improved to provide water for irrigation, livestock, wildlife, or recreation.

When water is obtained, if it has poor quality because of dissolved substances, its use in the surface environment or its discharge to downstream water courses the surface water will be degraded. The location of the well must consider the natural water quality and the hazards of its use in the potential contamination of the environment. Hazard exists during well development and its operation and maintenance to prevent aquifer quality damage from the pollutants through the well itself by back flushing, or accident, or flow down the annular spacing between the well casing and the bore hole.

- j. **Spring development (574):** Improving springs and seeps by excavating, cleaning, capping, or providing collection and storage facilities.

There will be negligible long-term water quality impacts with spring developments. Erosion and sedimentation may occur from any disturbed areas during and immediately after construction, but should be short-lived. These sediments will have minor amounts of adsorbed nutrients from soil organic matter.

Livestock Access Limitation Practices

It may be necessary to minimize livestock access to streambanks, ponds or lakeshores, and riparian zones to protect these areas from physical disturbance. This could also be accomplished by establishing special use pastures to manage livestock in areas of concentration. Practices include:

- k. **Fencing (382):** Enclosing or dividing an area of land with a suitable permanent structure that acts as a barrier to livestock, big game, or people (does not include temporary fences).

Fencing is a practice that can be on the contour or up and down slope. Often a fence line has grass and some shrubs in it. When a fence is built across the slope it will slow down runoff, and cause deposition of coarser grained materials reducing the amount of sediment delivered downslope. Fencing may protect riparian areas which act as sediment traps and filters along water channels and impoundments.

Livestock have a tendency to walk along fences. The paths become bare channels which concentrate and accelerate runoff causing a greater amount of erosion within the path and where the path/channel outlets into another channel. This can deliver more sediment and associated pollutants to surface waters. Fencing can have the effect of concentrating livestock in small areas, causing a concentration of manure which may wash off into the stream, thus causing surface water pollution.

■ **l. Livestock exclusion (472): Excluding livestock from an area not intended for grazing.**

Livestock exclusion may improve water quality by preventing livestock from being in the water or walking down the banks, and by preventing manure deposition in the stream. The amount of sediment and manure may be reduced in the surface water. This practice prevents compaction of the soil by livestock and prevents losses of vegetation and undergrowth. This may maintain or increase evapotranspiration. Increased permeability may reduce erosion and lower sediment and substance transportation to the surface waters. Shading along streams and channels resulting from the application of this practice may reduce surface water temperature.

■ **m. Stream crossing (interim): A stabilized area to provide access across a stream for livestock and farm machinery.**

The purpose is to provide a controlled crossing or watering access point for livestock along with access for farm equipment, control bank and streambed erosion, reduce sediment and enhance water quality, and maintain or improve wildlife habitat.

Vegetative Stabilization Practices

It may be necessary to improve or reestablish the vegetative cover on range and pastures to reduce erosion rates. The following practices can be used to reestablish vegetation:

■ **n. Pasture and hayland planting (512): Establishing and reestablishing long-term stands of adapted species of perennial, biannual, or reseeding forage plants. (Includes pasture and hayland renovation. Does not include grassed waterways or outlets or cropland.)**

The long-term effect will be an increase in the quality of the surface water due to reduced erosion and sediment delivery. Increased infiltration and subsequent percolation may cause more soluble substances to be carried to ground water.

■ **o. Range seeding (550): Establishing adapted plants by seeding on native grazing land. (Range does not include pasture and hayland planting.)**

Increased erosion and sediment yield may occur during the establishment of this practice. This is a temporary situation and sediment yields decrease when reseeded area becomes established. If chemicals are used in the reestablishment process, chances of chemical runoff into downstream water courses are reduced if application is applied according to label instructions. After establishment of the grass cover, grass sod slows runoff, acts as a filter to trap sediment, sediment attached substances, increases infiltration, and decreases sediment yields.

■ **p. Critical area planting (342): Planting vegetation, such as trees, shrubs, vines, grasses, or legumes, on highly erodible or critically eroding areas. (Does not include tree planting mainly for wood products.)**

This practice may reduce soil erosion and sediment delivery to surface waters. Plants may take up more of the nutrients in the soil, reducing the amount that can be washed into surface waters or leached into ground water.

During grading, seedbed preparation, seeding, and mulching, large quantities of sediment and associated chemicals may be washed into surface waters prior to plant establishment.

- **q. Brush (and weed) management (314):** *Managing and manipulating stands of brush (and weeds) on range, pasture, and recreation and wildlife areas by mechanical, chemical, or biological means or by prescribed burning. (Includes reducing excess brush (and weeds) to restore natural plant community balance and manipulating stands of undesirable plants through selective and patterned treatments to meet specific needs of the land and objectives of the land user.)*

Improved vegetation quality and the decrease in runoff from the practice will reduce the amount of erosion and sediment yield. Improved vegetative cover acts as a filter strip to trap the movement of dissolved and sediment attached substances, such as nutrients and chemicals from entering downstream water courses. Mechanical brush management may initially increase sediment yields because of soil disturbances and reduced vegetative cover. This is temporary until revegetation occurs.

- **r. Prescribed burning (338):** *Applying fire to predetermined areas under conditions under which the intensity and spread of the fire are controlled.*

When the area is burned in accordance with the specifications of this practice the nitrates with the burned vegetation will be released to the atmosphere. The ash will contain phosphorous and potassium which will be in a relatively highly soluble form. If a runoff event occurs soon after the burn there is a probability that these two materials may be transported into the ground water or into the surface water. When in a soluble state the phosphorous and potassium will be more difficult to trap and hold in place. When done on range grasses the growth of the grasses is increased and there will be an increased tie-up of plant nutrients as the grasses' growth is accelerated.

Selection of Practices

The selection of management practices for this measure should be based on an evaluation of current conditions, problems identified, quality criteria, and management goals. Successful resource management on range and pasture includes appropriate application of a combination of practices that will meet the needs of the range and pasture ecosystem (i.e., the soil, water, air, plant, and animal (including fish and shellfish) resources) and the objectives of the land user.

For a sound grazing land management system to function properly and to provide for a sustained level of productivity, the following should be considered:

- Know the key factors of plant species management, their growth habits, and their response to different seasons and degrees of use by various kinds and classes of livestock.
- Know the demand for, and seasons of use of, forage and browse by wildlife species.
- Know the amount of plant residue or grazing height that should be left to protect grazing land soils from wind and water erosion, provide for plant regrowth, and provide the riparian vegetation height desired to trap sediment or other pollutants.
- Know the range site production capabilities and the pasture suitability group capabilities so an initial stocking rate can be established.
- Know how to use livestock as a tool in the management of the range ecosystems and pastures to ensure the health and vigor of the plants, soil tilth, proper nutrient cycling, erosion control, and riparian area management, while at the same time meeting livestock nutritional requirements.

- Establish grazing unit sizes, watering, shade and salt locations, etc. to secure optimum livestock distribution and proper vegetation use.
- Provide for livestock herding, as needed, to protect sensitive areas from excessive use at critical times.
- Encourage proper wildlife harvesting to ensure proper population densities and forage balances.
- Know the livestock diet requirements in terms of quantity and quality to ensure that there are enough grazing units to provide adequate livestock nutrition for the season and the kind and classes of animals on the farm/ranch.
- Maintain a flexible grazing system to adjust for unexpected environmentally and economically generated problems.
- Special requirements to protect threatened or endangered species.

6. Cost Information

Much of the cost associated with implementing grazing management practices is due to fencing installation, water development, and system maintenance. Costs vary according to region and type of practice. Generally, the more components or structures a practice requires, the more expensive it is. However, cost-share is usually available from the USDA and other Federal agencies for most of these practices.

a. Grazing Facilities

Principal direct costs of providing grazing facilities vary from relatively low variable costs of dispersed salt blocks to higher capital and maintenance costs of supplementary water supply improvements. Improving the distribution of grazing pressure by herding or strategically locating grazing facilities to draw cattle away from streamside areas can result in improved utilization of existing forage.

The availability and feasibility of supplementary water development varies considerably between arid western areas and humid eastern areas, but costs for water development, including spring development and pipeline watering, are similar (Table 2-24).

b. Livestock Exclusion

Principal direct costs of livestock exclusion are the capital and maintenance costs for fencing to restrict access to streamside areas or the cost of herders to achieve the same results. In addition, there may be an indirect cost of the forage that is removed from grazing by exclusion.

There is considerable difference between multistrand barbed wire, chiefly used for perimeter fencing and permanent stream exclusion and diversions, and single- or double-strand smoothwire electrified fencing used for stream exclusion and temporary divisions within permanent pastures. The latter may be all that is needed to accomplish most livestock exclusion in smaller, managed pastures in the East (Table 2-25).

c. Improvement/Reestablishment

Principal direct costs of improving or reestablishing grazing land include the costs of seed, fertilizer, and herbicides needed to establish the new forage stand and the labor and machinery costs required for preparation, planting, cultivation, and weed control (Table 2-26). An indirect cost may be the forage that is removed from grazing during the reestablishment work and rest for seeding establishment.

Table 2-24. Cost of Water Development for Grazing Management

Location	Year	Type	Unit	Reported Capital Costs \$/Unit	Constant Dollar ^a	
					Capital Costs 1991 \$/Unit	Annualized Costs 1991 \$/Unit
California ^b	1979	pipeline	foot	0.28	0.35	0.05
Kansas ^c	1989	spring	each	1,239.00	1,282.94	191.20
		spring	each	1,389.00	1,438.26	214.34
Maine ^d	1988	pipeline	each	831.00	879.17	131.02
Alabama ^e	1990	spring	each	1,500.00	1,520.83	226.65
		pipeline	foot	1.60	1.62	0.24
		trough	each	1,000.00	1,013.89	151.10
Nebraska ^f	1991	pipeline	foot	1.31	1.31	0.20
		tank	each	370.00	370.00	55.14
Utah ^g	1968	spring	each	200.00	389.33	58.02
Oregon ^h	1991	pipeline	foot	0.20	0.20	0.03
		tank	each	183.00	183.00	27.27

^a Reported costs inflated to 1991 constant dollars by the ratio of indices of prices paid by farmers for building and fencing, 1977=100. Capital costs are annualized at 8 percent interest for 10 years.

^b Fresno Field Office, 1979.

^c Northup et al., 1989.

^d Cumberland County Soil and Water Conservation District, undated.

^e Alabama Soil Conservation Service, 1990.

^f Hermsmeyer, 1991.

^g Workman and Hooper, 1968.

^h ASCS/SCS, 1991.

d. Overall Costs of the Grazing Management Measure

Since the exact combination of practices needed to implement the management measure depends on site-specific conditions that are highly variable, the overall cost of the measure is best estimated from similar combinations of practices applied under the Agricultural Conservation Program (ACP), Rural Clean Water Program (RCWP), and similar activities. Cost data from the ACP programs are summarized in Table 2-27.

Table 2-25. Cost of Livestock Exclusion for Grazing Management

Location	Year	Type	Unit	Reported Capital Costs \$/Unit	Constant Dollar ^a	
					Capital Costs 1991 \$/Unit	Annualized Costs 1991 \$/Unit
California ^b	1979	permanent	mile	2,000	2,474.58	368.78
Alabama ^c	1990	permanent	mile	3,960	4,015.00	598.35
		net wire	mile	5,808	5,888.67	877.58
		electric	mile	2,640	2,676.67	398.90
Nebraska ^d	1991	permanent	mile	2,478	2,478.00	369.30
Great Lakes ^e	1989	permanent	mile	2,100 -	2,174.47 -	324.06 -
				2,400	2,485.11	370.35
Oregon ^f	1991	permanent	mile	2,640	2,640.00	393.44

^a Reported costs inflated to 1991 constant dollars by the ratio of indices of prices paid by farmers for building and fencing, 1977=100. Capital costs are annualized at 8 percent interest for 10 years.

^b Fresno Field Office, 1979.

^c Alabama Soil Conservation Service, 1990.

^d Hermsmeyer, 1991.

^e DPRA, 1989.

^f ASCS/SCS, 1991.

Table 2-26. Cost of Forage Improvement/Reestablishment for Grazing Management

Location	Year	Type	Unit	Reported Capital Costs \$/Unit	Constant Dollar ^a	
					Capital Costs 1991 \$/Unit	Annualized Costs 1991 \$/Unit
Alabama ^b	1990	planting (seed, lime & fertilizer)	acre	84 - 197	83 - 195	12.37 - 29.00
Nebraska ^c	1991	establishment	acre	47	47	7.00
		seeding	acre	45	45	6.71
Oregon ^d	1991	establishment	acre	27	27	4.02

^a Reported costs inflated to 1991 constant dollars by the ratio of indices of prices paid by farmers for seed, 1977=100. Capital costs are annualized at 8 percent interest for 10 years.

^b Alabama Soil Conservation Service, 1990.

^c Hermsmeyer, 1991.

^d ASCS/SCS, 1991.

Table 2-27. Summary of ACP Grazing Management Practice Costs, 1989 (US and 1990 (USDA-ASCS, 1990; USDA-ASCS, 1991)^a

Region ^b	ASCS Practice Code ^c	Adjusted Cost/Acre Treated ^d (\$/acre)		
		Average	Low	High
GL	SL1	17.34	13.01	49.80
GL	SL2	16.18	11.53	24.82
GL	SL6	27.76	17.32	37.92
GL	SL11	31.63	11.95	66.50
GL	SP10	19.13	13.50	52.03
GL	WP2	31.78	16.09	165.37
Gulf	SL1	12.67	9.95	19.19
Gulf	SL2	4.44	4.26	13.43
Gulf	SL6-range	1.81	0.81	12.55
Gulf	SL6-pasture	24.00	9.68	219.45
Gulf	SL11	47.92	27.53	109.98
Gulf	WC3	0.78	0.69	0.98
Gulf	WP2	58.44	38.14	72.84
NE	SL1	23.92	17.18	45.76
NE	SL2	21.06	5.08	45.98
NE	SL6	34.70	19.38	42.20
NE	SL11	109.11	17.62	374.48
NE	SP10	106.53	52.03	1,023.61
NE	WP2	72.75	31.08	1,543.97
Pacific	SL1	9.75	7.92	24.39
Pacific	SL2	3.62	0.61	7.32
Pacific	SL6	1.06	0.51	2.22
Pacific	SL11	12.61	7.20	20.86
Pacific	SP10	100.19	19.59	132.36
Pacific	WP2	14.22	7.53	190.51
SE	SL1	19.54	15.49	24.05
SE	SL2	10.68	5.20	15.81
SE	SL6	10.14	9.49	262.77
SE	SL11	55.20	15.70	116.40
SE	WP2	75.90	13.21	224.73

Table 2-27 Notes:

^a Acreage-weighted average of 1989 and 1990 costs.

^b GL=Great Lakes Region (IL, IN, MI, NY, OH, WI)

GULF=Gulf States Region (AL, FL, LA, MS, TX)

NE=Northeast Region (CT, DE, MA, MD, ME, NH, NY, PA, RI)

Pacific=Pacific Region (CA, OR, WA)

SE=Southeast Region (FL, GA, NC, SC, VA)

^c ASCS practices with description title and technical practice code:

SL1 - Permanent vegetative cover establishment

Conservation tillage	329
Pasture and hayland planting	512
Range seeding	550
Cover and green manure crop (orchard and vineyard only)	340
Field borders	386
Filter strips	393

SL2 - Permanent vegetative cover improvement

Conservation tillage	329
Pasture and hayland management	510
Pasture and hayland Planting	512
Fencing	382
Range seeding	550
Deferred grazing	352
Firebreak	394
Brush management	314

SL6 - Grazing land protection

Critical area planting	342
Pond	378
Fencing	382
Pipeline	516
Spring development	574
Stock trails and walkways	575
Trough or tank	614
Water-harvesting catchment	636
Wells	642

SL11 - Permanent vegetative cover on critical areas

Cover and green manure crop	340
Critical area planting	342
Fencing	382
Field borders	386
Filter strip	393
Forest land erosion control system	408
Mulching	484
Streambank and shoreline protection	580
Tree planting	612

SP10 - Streambank stabilization

Critical area planting	342
Livestock exclusion	472
Mulching	484
Streambank and shoreline protection	580
Tree planting	612

WC3 - Rangeland moisture conservation

Grazing land mechanical treatment	548
-----------------------------------	-----

WP2 - Stream protection

Filter strip	393
Channel vegetation	322
Fencing	382
Pipeline	516
Streambank and shoreline protection	580
Field border	386
Tree planting	612
Trough or tank	614
Stock trails or walkways	575

^d Average annual cost, adjusted to 1990 constant dollars using ratio of index of prices paid for production items 1989 to 1990 (171/165). Source: USDA-ERS, 1991.

F. Irrigation Water Management

To reduce nonpoint source pollution of surface waters caused by irrigation:

- (1) Operate the irrigation system so that the timing and amount of irrigation water applied match crop water needs. This will require, as a minimum: (a) the accurate measurement of soil-water depletion volume and the volume of irrigation water applied, and (b) uniform application of water.
- (2) When chemigation is used, include backflow preventers for wells, minimize the harmful amounts of chemigated waters that discharge from the edge of the field, and control deep percolation. In cases where chemigation is performed with furrow irrigation systems, a tailwater management system may be needed.

The following limitations and special conditions apply:

- (1) In some locations, irrigation return flows are subject to other water rights or are required to maintain stream flow. In these special cases, on-site reuse could be precluded and would not be considered part of the management measure for such locations.
- (2) By increasing the water use efficiency, the discharge volume from the system will usually be reduced. While the total pollutant load may be reduced somewhat, there is the potential for an increase in the concentration of pollutants in the discharge. In these special cases, where living resources or human health may be adversely affected and where other management measures (nutrients and pesticides) do not reduce concentrations in the discharge, increasing water use efficiency would not be considered part of the management measure.
- (3) In some irrigation districts, the time interval between the order for and the delivery of irrigation water to the farm may limit the irrigator's ability to achieve the maximum on-farm application efficiencies that are otherwise possible.
- (4) In some locations, leaching is necessary to control salt in the soil profile. Leaching for salt control should be limited to the leaching requirement for the root zone.
- (5) Where leakage from delivery systems or return flows supports wetlands or wildlife refuges, it may be preferable to modify the system to achieve a high level of efficiency and then divert the "saved water" to the wetland or wildlife refuge. This will improve the quality of water delivered to wetlands or wildlife refuges by preventing the introduction of pollutants from irrigated lands to such diverted water.
- (6) In some locations, sprinkler irrigation is used for frost or freeze protection, or for crop cooling. In these special cases, applications should be limited to the amount necessary for crop protection, and applied water should remain on-site.

1. Applicability

This management measure is intended to be applied by States to activities on irrigated lands, including agricultural crop and pasture land (except for isolated fields of less than 10 acres in size that are not contiguous to other irrigated lands); orchard land; specialty cropland; and nursery cropland. Those landowners already practicing effective irrigation management in conformity with the irrigation water management measure may not need to purchase additional devices to measure soil-water depletion or the volume of irrigation water applied, and may not need to expend additional labor resources to manage the irrigation system. Under the Coastal Zone Act Reauthorization Amendments of 1990, States are subject to a number of requirements as they develop coastal nonpoint programs in conformity with this measure and will have some flexibility in doing so. The application of management measures by States is described more fully in *Coastal Nonpoint Pollution Control Program: Program Development and Approval Guidance*, published jointly by the U.S. Environmental Protection Agency (EPA) and the National Oceanic and Atmospheric Administration (NOAA) of the U.S. Department of Commerce.

2. Description

The goal of this management measure is to reduce nonpoint source pollution of surface waters caused by irrigation. For the purposes of this management measure, "harmful amounts" are those amounts that pose a significant risk to aquatic plant or animal life, ecosystem health, human health, or agricultural or industrial uses of the water.

A problem associated with irrigation is the movement of pollutants from the land into ground or surface water. This movement of pollutants is affected by the pathways taken by applied water and precipitation (Figure 2-15); the physical, chemical, and biological characteristics of the irrigated land; the type of irrigation system used; crop type; the degree to which erosion and sediment control, nutrient management, and pesticide management are employed; and the management of the irrigation system (Figure 2-16).

Return flows, runoff, and leachate from irrigated lands may transport the following types of pollutants:

- Sediment and particulate organic solids;
- Particulate-bound nutrients, chemicals, and metals, such as phosphorus, organic nitrogen, a portion of applied pesticides, and a portion of the metals applied with some organic wastes;
- Soluble nutrients, such as nitrogen, soluble phosphorus, a portion of the applied pesticides, soluble metals, salts, and many other major and minor nutrients; and
- Bacteria, viruses, and other microorganisms.

Transport of irrigation water from the source of supply to the irrigated field via open canals and laterals can be a source of water loss if the canals and laterals are not lined. Water is also transported through the lower ends of canals and laterals because of the flow-through requirements to maintain water levels in them. In many soils, unlined canals and laterals lose water via seepage in bottom and side walls. Seepage water either moves into the ground water through infiltration or forms wet areas near the canal or lateral. This water

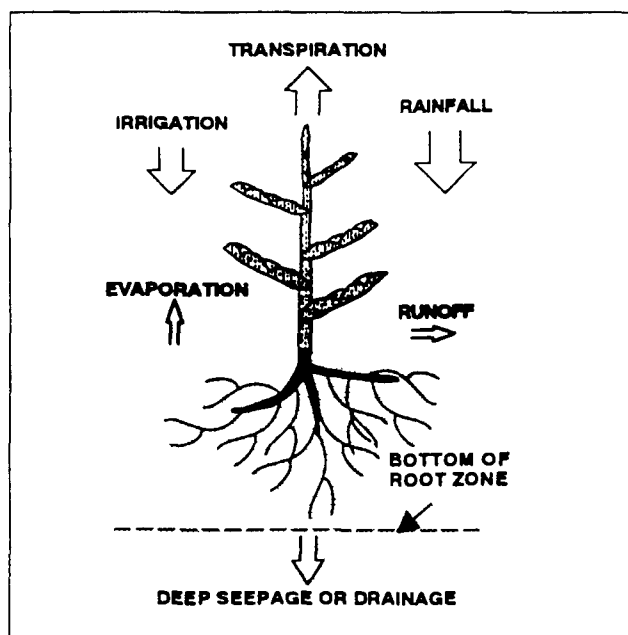

Figure 2-15. Source and fate of water added to a soil system (Evans et al., 1991c).

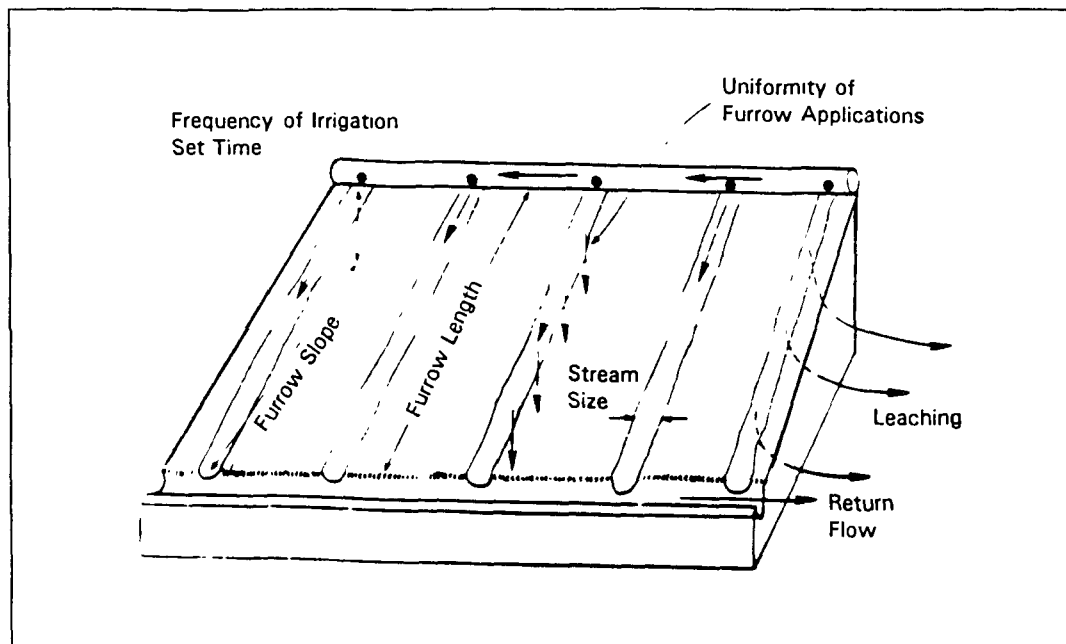

Figure 2-16. Variables influencing pollutant losses from irrigated fields (USEPA, 1982).

will carry with it any soluble pollutants in the soil, thereby creating the potential for pollution of ground or surface water.

Since irrigation is a consumptive use of water, any pollutants in the source waters that are not consumed by the crop (e.g., salts, pesticides, nutrients) can be concentrated in the soil, concentrated in the leachate or seepage, or concentrated in the runoff or return flow from the system. Salts that concentrate in the soil profile must be removed for sustained crop production.

For additional information regarding the problems caused by these pollutants, see Section I.F of this chapter.

Application of this management measure will reduce the waste of irrigation water, improve the water use efficiency, and reduce the total pollutant discharge from an irrigation system. It is not the intent of this management measure to require the replacement of major components of an irrigation system. Instead, the expectation is that components to manage the timing and amount of water applied will be provided where needed, and that special precautions (i.e., backflow preventers, prevent tailwater, and control deep percolation) will be taken when chemigation is used.

Irrigation scheduling is the use of water management strategies to prevent over-application of water while minimizing yield loss due to water shortage or drought stress (Evans et al., 1991d). Irrigation scheduling will ensure that water is applied to the crop when needed and in the amount needed. Effective scheduling requires knowledge of the following factors (Evans et al., 1991c; Evans et al., 1991d):

- Soil properties;
- Soil-water relationships and status;
- Type of crop and its sensitivity to drought stress;
- The stage of crop development;
- The status of crop stress;
- The potential yield reduction if the crop remains in a stressed condition;
- Availability of a water supply; and
- Climatic factors such as rainfall and temperature.

Much of the above information can be found in Soil Conservation Service soil surveys and Extension Service literature. However, all information should be site-specific and verified in the field.

There are three ways to determine when irrigation is needed (Evans et al., 1991d):

- Measuring soil water;
- Estimating soil water using an accounting approach; and
- Measuring crop stress.

Soil water can be measured using a range of devices (Evans et al., 1991b), including tensiometers, which measure soil water suction (Figure 2-17); electrical resistance blocks (also called gypsum blocks or moisture blocks), which measure electrical resistance that is related to soil water by a calibration curve (Figure 2-18); neutron probes, which directly measure soil water; Phene cells, which are used to estimate soil water based on the relationship of heat conductance to soil water content; and time domain reflectometers, which can be used to estimate soil water based on the time it takes for an electromagnetic pulse to pass through the soil. The appropriate device for any given situation is a function of the acreage of irrigated land, soils, cost, and other site-specific factors.

Accounting approaches estimate the quantity of soil water remaining in the effective root zone and can be simple or complex. In essence, daily water inputs and outputs are measured or estimated to determine the depletion volume. Irrigation is typically scheduled when the allowable depletion volume is nearly reached.

Once the decision to irrigate has been made, it is important to determine the amount of water to apply. Irrigation needs are a function of the soil water depletion volume in the effective root zone, the rate at which the crop uses water (Figure 2-19), and climatic factors. Accurate measurements of the amount of water applied are essential to maximizing irrigation efficiency. The quantity of water applied

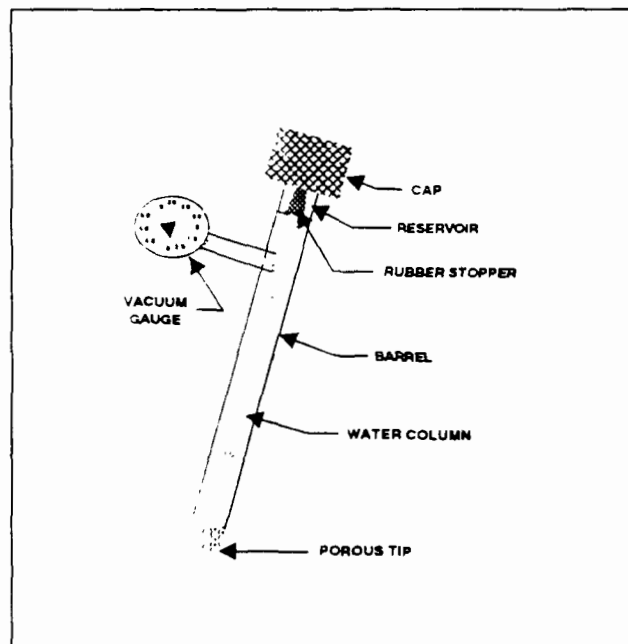

Figure 2-17. Diagram of a tensiometer (Evans et al., 1991b).

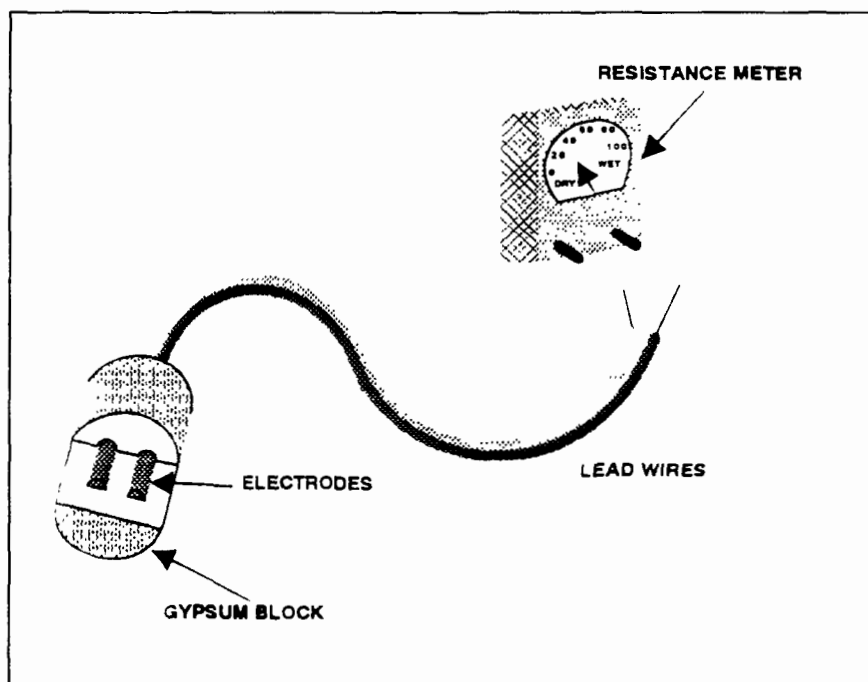

Figure 2-18. Schematic of an electrical resistance block and meter (Evans et al., 1991b).

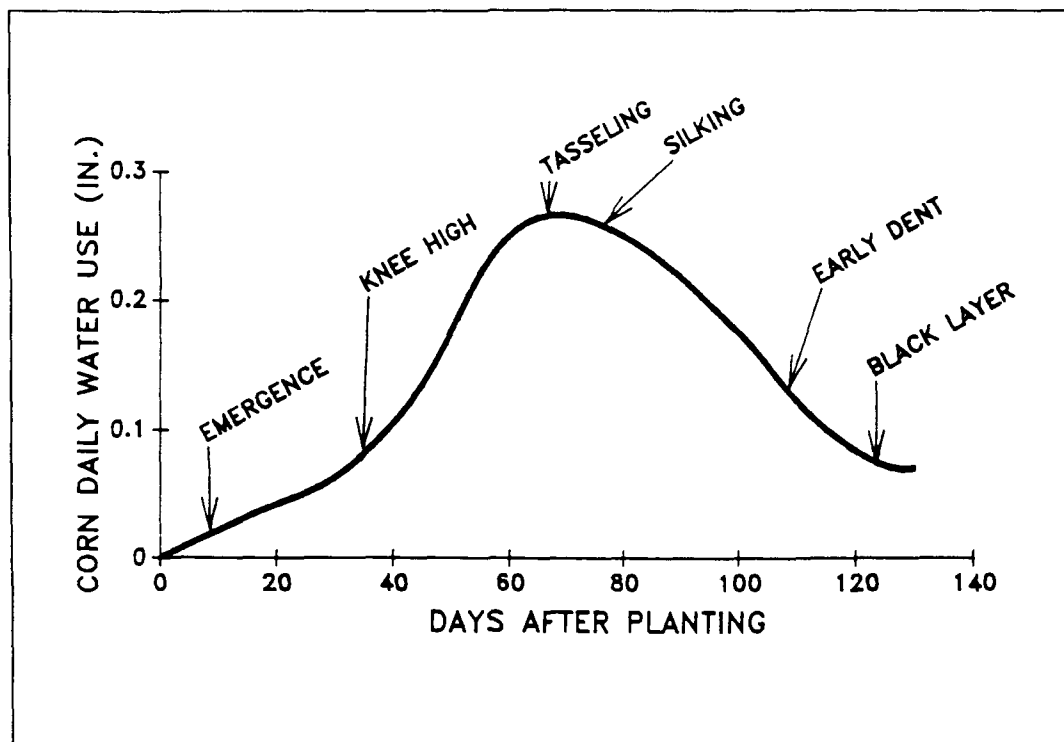

Figure 2-19. Corn daily water use as influenced by stage of development (Evans et al., 1991c).

can be measured by such devices as a totalizing flow meter that is installed in the delivery pipe. If water is supplied by ditch or canal, weirs or flumes in the ditch can be used to measure the rate of flow.

Deep percolation can be greatly reduced by limiting the amount of applied water to the amount that can be stored in the plant root zone. The deep percolation that is necessary for salt management can be accomplished with a sprinkler system by using longer sets or very slow pivot speeds or by applying water during the non-growing season.

Reducing overall water use in irrigation will allow more water for stream flow control and will increase flow for diversion to marshes, wetlands, or other environmental uses. If the source is ground water, reducing overall use will maintain higher ground-water levels, which could be important for maintaining base flow in nearby streams. Reduced water diversion will reduce the salt or pollutant load brought into the irrigation system, thereby reducing the volume of these pollutants that must be managed or discharged from the system.

Although this management measure does not require the replacement of major components of an irrigation system, such changes can sometimes result in greater pollution prevention. Consequently, the following is a broader discussion of the types of design and operational aspects of the overall irrigation system that could be addressed to provide additional control of nonpoint source pollution beyond that which is required by this management measure. Overall, five basic aspects of the irrigation system can be addressed:

- (1) Irrigation scheduling;
- (2) Efficient application of irrigation water;
- (3) Efficient transport of irrigation water;
- (4) Use of runoff or tailwater; and
- (5) Management of drainage water.

This management measure addresses irrigation scheduling, efficient application, and the control of tailwater when chemigation is used. The efficient transport of irrigation water, the use of runoff or tailwater, and the management of drainage water are additional considerations.

Although not a required element of this management measure, the seepage losses associated with canals and laterals can be reduced by lining the canals and laterals, or can be eliminated by conversion from open canals and laterals to pipelines. Flow-through losses will not be changed by canal or lateral lining, but can be eliminated or greatly reduced by conversion to pipelines.

Surface irrigation systems are usually designed to have a percentage (up to 30 percent) of the applied water lost as tailwater. This tailwater should be managed with a tailwater recovery system, but such a system is not required as a component of this management measure unless chemigation is practiced. Tailwater recovery systems usually include a system of ditches or berms to direct water from the end of the field to a small storage structure. Tailwater is stored until it can be either pumped back to the head end of the field and reused or delivered to additional irrigated land. In some locations, there may be downstream water rights that are dependent upon tailwater, or tailwater may be used to maintain flow in streams. These requirements may take legal precedence over the reuse of tailwater.

Well-designed and managed irrigation systems remove runoff and leachate efficiently; control deep percolation; and minimize erosion from applied water, thereby reducing adverse impacts on surface water and ground water. If a tailwater recovery system is used, it should be designed to allow storm runoff to flow through the system without damage. Additional surface drainage structures such as filter strips, field drainage ditches, subsurface drains, and water table control may also be used to control runoff and leachate if site conditions warrant their use. Sprinkler systems will usually require design and installation of a system to remove and manage storm runoff.

A properly designed and operated sprinkler irrigation system should have a uniform distribution pattern. The volume of water applied can be changed by changing the total time the sprinkler runs; by changing the pressure at which the sprinkler operates; or, in the case of a center pivot, by adjusting the speed of travel of the system. There should be no irrigation runoff or tailwater from most well-designed and well-operated sprinkler systems.

The type of irrigation system used will dictate which practices can be employed to improve water use efficiency and to obtain the most benefit from scheduling. Flood systems will generally infiltrate more water at the upper end of the field than at the lower end because water is applied to the upper end of the field first and remains on that portion of the field longer. This will cause the upper end of the field to have greater deep percolation losses than the lower end. Although not required as a component of this management measure, this situation can sometimes be improved by changing slope throughout the length of the field. This type of change may not be practical or affordable in many cases. For example, furrow length can be reduced by cutting the field in half and applying water in the middle of the field. This will require more pipe or ditches to distribute the water across the middle of the field.

3. Management Measure Selection

This management measure was selected based on an evaluation of available information that documents the beneficial effects of improved irrigation management (see Section II.F.4 of this chapter). Specifically, the available information shows that irrigation efficiencies can be improved with scheduling that is based on knowledge of water needs and measurement of applied water. Improved irrigation efficiency can result in the reduction or elimination of runoff and return flows, as well as the control of deep percolation. Secondly, backflow preventers can be used to protect wells from chemicals used in chemigation. In addition, tailwater prevention, or tailwater management where necessary, is effective in reducing the discharge of soluble and particulate pollutants to receiving waters.

By reducing the volume of water applied to agricultural lands, pollutant loads are also reduced. Less interaction between irrigation water and agricultural land will generally result in less pollutant transport from the land and less leaching of pollutants to ground water.

The practices that can be used to implement this measure on a given site are commonly used and are recommended by SCS for general use on irrigated lands. By designing the measure using the appropriate mix of structural and management practices for a given site, there is no undue economic impact on the operator. Many of the practices that can be used to implement this measure (e.g., water-measuring devices, tailwater recovery systems, and backflow preventers) may already be required by State or local rules or may otherwise be in use on irrigated fields. Since

many irrigators may already be using systems that satisfy or partly satisfy the intent of the management measure, the only action that may be necessary will be to determine the effectiveness of the existing practices and add additional practices, if needed.

4. Effectiveness Information

Following is information on pollution reductions that can be expected from installation of the management practices outlined within this management measure.

In a review of a wide range of agricultural control practices, EPA (1982) determined that increased use of call periods, on-demand water ordering, irrigation scheduling, and flow measurement and control would all result in decreased losses of salts, sediment, and nutrients (Table 2-28). Various alterations to existing furrow irrigation systems were also determined to be beneficial to water quality, as were tailwater management and seepage control.

Logan (1990) reported that chemical backsiphon devices are highly effective at preventing the introduction of pesticides and nitrogen to ground water. The American Society of Agricultural Engineers (ASAE) specifies safety devices for chemigation that will prevent the pollution of a water supply used solely for irrigation (ASAE, 1989).

Properly designed sprinkler irrigation systems will have little runoff (Boyle Engineering Corp., 1986). Furrow irrigation and border check or border strip irrigation systems typically produce tailwater, and tailwater recovery systems may be needed to manage tailwater losses (Boyle Engineering Corp., 1986). Tailwater can be managed by applying the water to additional fields, by treating and releasing the tailwater, or by reapplying the tailwater to upslope cropland.

The Rock Creek Rural Clean Water Program (RCWP) project in Idaho is the source of much information regarding the benefits of irrigation water management (USDA, 1991). All crops in the Rock Creek watershed are irrigated with water diverted from the Snake River and delivered through a network of canals and laterals. The combined implementation of irrigation management practices, sediment control practices, and conservation tillage has resulted in measured reductions in suspended sediment loadings ranging from 61 percent to 95 percent at six stations in Rock Creek (1981-1988). Similarly, 8 of 10 sub-basins showed reductions in suspended sediment loadings over the same time period. The sediment removal efficiencies of selected practices used in the project are given in Table 2-29.

In California it is expected that drip irrigation will have the greatest irrigation efficiency of those irrigation systems evaluated, whereas conventional furrow irrigation will have the lowest irrigation efficiency and greatest runoff fraction (Table 2-30). Tailwater recovery irrigation systems are expected to have the greatest percolation rate. Plot studies in California have shown that in-season irrigation efficiencies for drip irrigation and Low Energy Precision Application (LEPA) are greater than those for improved furrow and conventional furrow systems (Table 2-31). LEPA is a linear move sprinkler system in which the sprinkler heads have been removed and replaced with tubes that supply water to individual furrows (Univ. Calif., 1988). Dikes are placed in the furrows to prevent water flow and reduce soil effects on infiltrated water uniformity.

Mielke et al. (1981) studied the effects of tillage practice and type of center pivot irrigation on herbicide (atrazine and alachlor) losses in runoff and sediment. Study results clearly show that, for each of three tillage practices studied, low-pressure spray nozzles result in much greater herbicide loss in runoff than either high-pressure or low-pressure impact heads.

5. Irrigation Water Management Practices

As discussed more fully at the beginning of this chapter and in Chapter 1, the following practices are described for illustrative purposes only. State programs need not require implementation of these practices. However, as a practical matter, EPA anticipates that the management measure set forth above generally will be implemented by applying one or more management practices appropriate to the source, location, and climate. The practices set forth below have been found by EPA to be representative of the types of practices that can be applied successfully apply to achieve the management measure described above.

Table 2-28. Summary of Pollutant Impacts of Selected Irrigation Practices^a (USEPA, 1982)

Practice	Description	T- P ^b	NA- P ^c	T- N ^d	NA- N ^e	A- Pes ^f	NA- Pes ^g	Salts ^h	Sed ⁱ
Call Period	A minimum length of time allowed to place an order.	-	-	-	-	-	-	-	-
On-Demand Water Ordering	Maximizes scheduling flexibility; however, this encourages less planning.	-/0	-/0	-/0	-/0	-/0	-/0	-/0	-/0
Irrigation Scheduling	Uses meteorological information with soil moisture levels to forecast future irrigations.		-	-	-	-	-	-	-
Conveyance Channel Improvements and Maintenance	Keep canals free of silt deposits and vegetation to maintain capacity. Repair damaged canal banks.	-	-	-	-	-	-	-	-
Improved Management of System Storage	System water storage provides flexibility and efficiency, but it should be minimized to reduce seepage and evaporation.	-	-	-	-	-	-	-	-
Improved Management of Return Flows	Canals should not be operated at capacity at all times with unneeded water spilled into return flows.				-			-	
Seepage Control	Lining canals, ditches, laterals, and watercourses that have high seepage losses with some impermeable material.				-			-	
Flow Measurement and Control	Measure and control flow to ensure adequate application of water while preventing unnecessary and wasteful diversions. To control the flow of water in canals and ditches, structures such as checks, drops, culverts, and field inlet devices are used. Notched weirs or small fiberglass flumes are used to measure the flow of water.	-	-	-	-	-	-	-	-
Cutback Irrigation	Flow volume is adjusted by using a head ditch or delivery pipe, which is adjusted so that a flow is quickly introduced to the end of the furrow and then "cut back" to a "soaking" flow rate. Increases uniformity of application and reduces tailwater, but is only applicable if there is sufficient cross slope.	-	-	-	-	-	-	-	-
Gated Pipe System	Combines features of improved furrow and cutback systems, and can be automatically controlled and coupled with on-demand water availability.	-	-	-	-	-	-	-	-

Table 2-28. (continued)

Practice	Description	T-P ^b	NA-P ^c	T-N ^d	NA-N ^e	A-Pes ^f	NA-Pes ^g	Salts ^h	Sed ⁱ
Multi-set Irrigation System	Combines features of improved furrow with a shorter length of run by using lateral supply pipes across each field.	-	-	-	-	-	-	-	-
Tailwater Reuse System/Subsurface Drainage	Tile drainage allows collection of surface flows into a water drainage system for control.	-	-	-	-	-	-	-	-
Sprinkler Irrigation	This system includes side-roll, center-pivot, tow-line, and solid-set sprinklers. Sprinkler systems are more efficient than surface irrigation.	-	-	-	-	-	-	-	-
Trickle Irrigation	Water is delivered to individual plants through lines or emitters in order to provide crop plants with nearly optimal soil moisture.	-	-	-	-	-	-	-	-

^a + = increases in application of control will increase pollutant losses; - = increases in application of control will decrease pollutant losses; 0 = no appreciable effect. Blanks indicate no information presented.

^b Absorbed phosphorus (total and labile).

^c Nonabsorbed phosphorus (soluble forms).

^d Absorbed nitrogen (total N and ammonium).

^e Nonabsorbed nitrogen (nitrate).

^f Absorbed pesticide.

^g Nonabsorbed pesticide.

^h Salts.

ⁱ Sediment.

Table 2-29. Sediment Removal Efficiencies and Comments on BMPs Evaluated (USDA, 1991)

Practice	Sediment Removal Efficiency (%)		Comment
	Average	Range	
Sediment basins: field, farm, subbasin	87	75-95	Cleaning costly.
Mini-basins	86 ^a	0-95	Controlled outlets essential. Many failed. Careful management required.
Buried pipe systems (incorporating mini-basins with individual outlets into a buried drain)	83	75-95	High installation cost. Potential for increased production to offset costs. Eliminates tailwater ditch. Good control of tailwater.
Vegetative filters	50 ^a	35-70	Simple. Proper installation and management needed.
Placing straw in furrows	50	40-80	Labor-intensive without special equipment. Careful management required.

^a Mean of those that did not fail.

Table 2-30. Expected Irrigation Efficiencies of Selected Irrigation Systems in California (California SWRCB, 1987)

Irrigation System	Irrigation Efficiency (%)	Percolation Fraction (%)	Runoff Fraction (%)
Conventional Furrow	60	17.5	22.5
Gated Pipe	67.5	14.2	18.3
Shorter Run	70	13.3	16.7
Tail Water Recovery	73.2	21.3	5.5
Hand Move Sprinkler	80	8.75	11.3
Lateral Move Sprinkler	87.5	5.5	7.0
Drip	95	4.0	1.0

Table 2-31. Irrigation Efficiencies of Selected Irrigation Systems for Cotton (California SWRCB, 1991)

System	Year	Seasonal Irrigation (in.)	In-Season Distribution Uniformity (%)	In-Season Irrigation Efficiency (%)	In-Season Deep Percolation (in.)
Drip Irrigation	1989	17.82	87	99	2.43
	1990	19.24	81	82	3.98
LEPA (Low Energy Precision Application)	1989	14.21	92	97	2.88
	1990	23.19	92	78.6	6.13
Improved Furrow	1989	20.89	57.5	36	18.9
	1990	16.35	86.5	75.3	6.15
Conventional Furrow	1989	21.26	59.3	36	19.4
	1990	20.00	74	74	9.85

The U.S. Soil Conservation Service practice number and definition are provided for each management practice, where available. Also included in italics are SCS statements describing the effect each practice has on water quality (USDA-SCS, 1988).

Irrigation Scheduling Practices

Proper irrigation scheduling is a key element in irrigation water management. Irrigation scheduling should be based on knowing the daily water use of the crop, the water-holding capacity of the soil, and the lower limit of soil moisture for each crop and soil, and measuring the amount of water applied to the field. Also, natural precipitation should be considered and adjustments made in the scheduled irrigations.

Practices that may be used to accomplish proper irrigation scheduling are:

- a. *Irrigation water management (449): Determining and controlling the rate, amount, and timing of irrigation water in a planned and efficient manner.*

Management of the irrigation system should provide the control needed to minimize losses of water, and yields of sediment and sediment attached and dissolved substances, such as plant nutrients and herbicides, from the system. Poor management may allow the loss of dissolved substances from the irrigation system to surface or ground water. Good management may reduce saline percolation from geologic origins. Returns to the surface water system would increase downstream water temperature.

The purpose is to effectively use available irrigation water supply in managing and controlling the moisture environment of crops to promote the desired crop response, to minimize soil erosion and loss of plant nutrients, to control undesirable water loss, and to protect water quality.

To achieve this purpose the irrigator must have knowledge of (1) how to determine when irrigation water should be applied, based on the rate of water used by crops and on the stages of plant growth; (2) how to measure or estimate the amount of water required for each irrigation, including the leaching needs; (3) the normal time needed for the soil to absorb the required amount of water and how to detect changes in intake rate; (4) how to adjust water stream size, application rate, or irrigation time to compensate for changes in such factors as intake rate or the amount of irrigation runoff from an area; (5) how to recognize erosion caused by irrigation; (6) how to estimate the amount of irrigation runoff from an area; and (7) how to evaluate the uniformity of water application.

Tools to assist in achieving proper irrigation scheduling:

- *b. Water-measuring device: An irrigation water meter, flume, weir, or other water-measuring device installed in a pipeline or ditch.*

The measuring device must be installed between the point of diversion and water distribution system used on the field. The device should provide a means to measure the rate of flow. Total water volume used may then be calculated using rate of flow and time, or read directly, if a totalizing meter is used.

The purpose is to provide the irrigator the rate of flow and/or application of water, and the total amount of water applied to the field with each irrigation.

- *c. Soil and crop water use data: From soils information the available water-holding capacity of the soil can be determined along with the amount of water that the plant can extract from the soil before additional irrigation is needed.*

Water use information for various crops can be obtained from various USDA publications.

The purpose is to allow the water user to estimate the amount of available water remaining in the root zone at any time, thereby indicating when the next irrigation should be scheduled and the amount of water needed. Methods to measure or estimate the soil moisture should be employed, especially for high-value crops or where the water-holding capacity of the soil is low.

Practices for Efficient Irrigation Water Application

Irrigation water should be applied in a manner that ensures efficient use and distribution, minimizes runoff or deep percolation, and eliminates soil erosion.

The method of irrigation employed will vary with the type of crop grown, the topography, and soils. There are several systems that, when properly designed and operated, can be used as follows:

- *d. Irrigation system, drip or trickle (441): A planned irrigation system in which all necessary facilities are installed for efficiently applying water directly to the root zone of plants by means of applicators*

(orifices, emitters, porous tubing, or perforated pipe) operated under low pressure (Figure 2-20). The applicators can be placed on or below the surface of the ground (Figure 2-21).

Surface water quality may not be significantly affected by transported substances because runoff is largely controlled by the system components (practices). Chemical applications may be applied through the system. Reduction of runoff will result in less sediment and chemical losses from the field during irrigation. If excessive, local, deep percolation should occur, a chemical hazard may exist to shallow ground water or to areas where geologic materials provide easy access to the aquifer.

- e. *Irrigation system, sprinkler (442): A planned irrigation system in which all necessary facilities are installed for efficiently applying water by means of perforated pipes or nozzles operated under pressure.*

Proper irrigation management controls runoff and prevents downstream surface water deterioration from sediment and sediment attached substances. Over irrigation through poor management can produce impaired water quality in runoff as well as ground water through increased percolation. Chemigation with this system allows the operator the opportunity to manage nutrients, wastewater and pesticides. For example, nutrients applied in several incremental applications based on the plant needs may reduce ground water contamination considerably, compared to one application during planting. Poor management may cause pollution of surface and ground water. Pesticide drift from chemigation may also be hazardous to vegetation, animals, and surface water resources. Appropriate safety equipment, operation and maintenance of the system is needed with chemigation to prevent accidental environmental pollution or backflows to water sources.

- f. *Irrigation system, surface and subsurface (443): A planned irrigation system in which all necessary water control structures have been installed for efficient distribution of irrigation water by surface means, such as furrows, borders, contour levees, or contour ditches, or by subsurface means.*

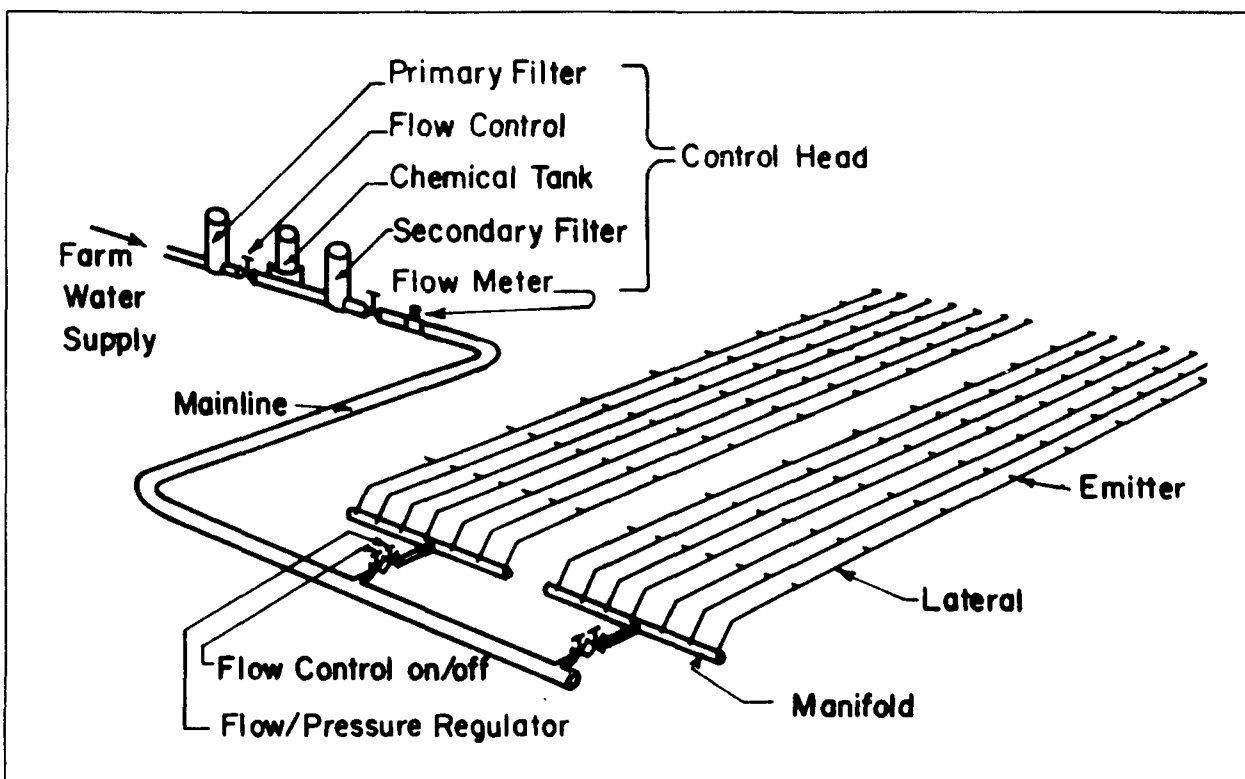

Figure 2-20. Basic components of a trickle irrigation system (USDA-SCS, 1984).

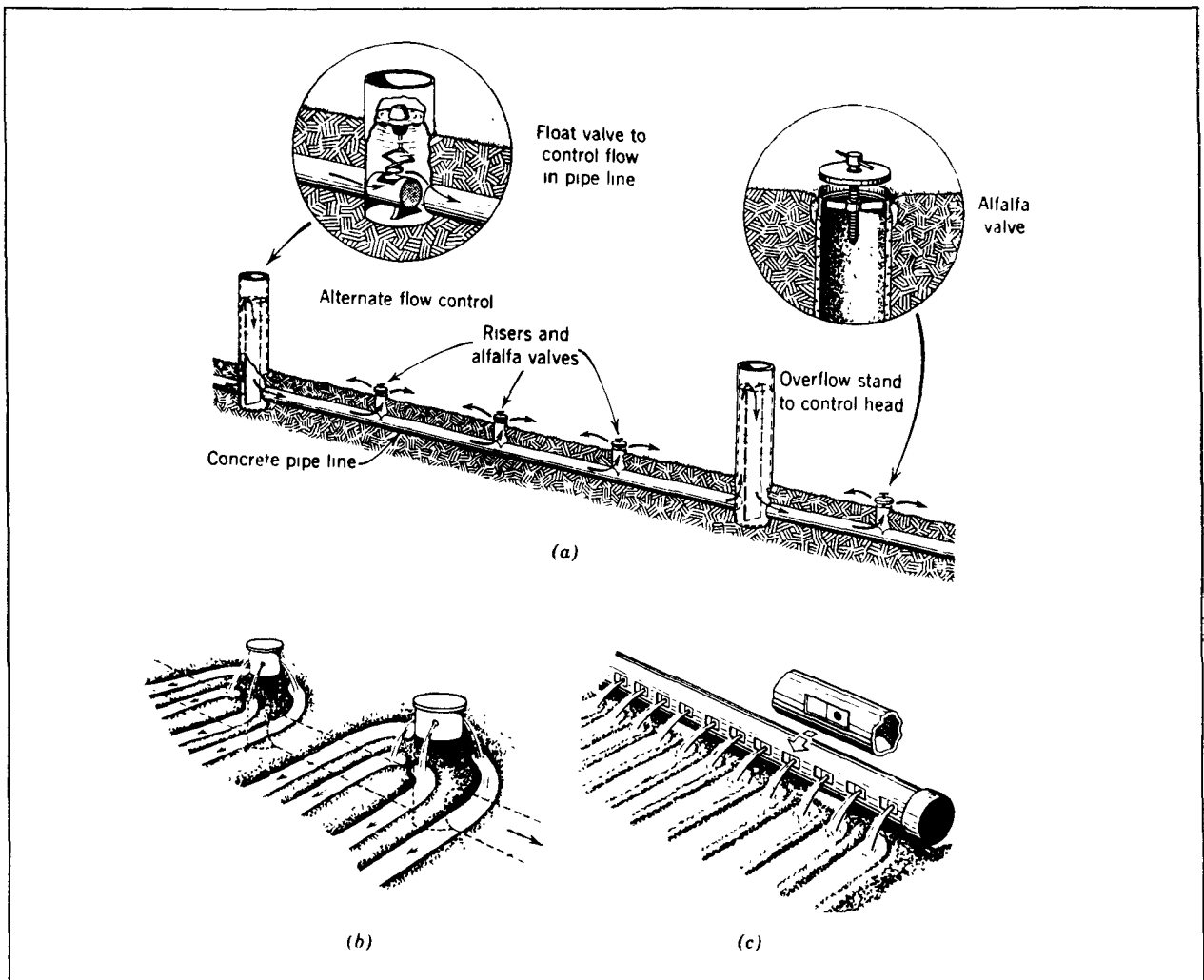

Figure 2-21. Methods of distribution of irrigation water from (a) low-pressure underground pipe, (b) multiple-outlet risers, and (c) portable gated pipe (Schwab et al., 1981).

Operation and management of the irrigation system in a manner which allows little or no runoff may allow small yields of sediment or sediment-attached substances to downstream waters. Pollutants may increase if irrigation water management is not adequate. Ground water quality from mobile, dissolved chemicals may also be a hazard if irrigation water management does not prevent deep percolation. Subsurface irrigation that requires the drainage and removal of excess water from the field may discharge increased amounts of dissolved substances such as nutrients or other salts to surface water. Temperatures of downstream water courses that receive runoff waters may be increased. Temperatures of downstream waters might be decreased with subsurface systems when excess water is being pumped from the field to lower the water table. Downstream temperatures should not be affected by subsurface irrigation during summer months if lowering the water table is not required. Improved aquatic habitat may occur if runoff or seepage occurs from surface systems or from pumping to lower the water table in subsurface systems.

- **g. Irrigation field ditch (388):** A permanent irrigation ditch constructed to convey water from the source of supply to a field or fields in a farm distribution system.

The standard for this practice applies to open channels and elevated ditches of 25 ft³/second or less capacity formed in and with earth materials.

Irrigation field ditches typically carry irrigation water from the source of supplying to a field or fields. Salinity changes may occur in both the soil and water. This will depend on the irrigation water quality, the level of water management, and the geologic materials of the area. The quality of ground and surface water may be altered depending on environmental conditions. Water lost from the irrigation system to downstream runoff may contain dissolved substances, sediment, and sediment-attached substances that may degrade water quality and increase water temperature. This practice may make water available for wildlife, but may not significantly increase habitat.

■ h. **Irrigation land leveling (464):** Reshaping the surface of land to be irrigated to planned grades.

The effects of this practice depend on the level of irrigation water management. If plant root zone soil water is properly managed, then quality decreases of surface and ground water may be avoided. Under poor management, ground and surface water quality may deteriorate. Deep percolation and recharge with poor quality water may lower aquifer quality. Land leveling may minimize erosion and when runoff occurs concurrent sediment yield reduction. Poor management may cause an increase in salinity of soil, ground and surface waters. High efficiency surface irrigation is more probable when earth moving elevations are laser controlled.

Practices for Efficient Irrigation Water Transport

Irrigation water transportation systems that move water from the source of supply to the irrigation system should be designed and managed in a manner that minimizes evaporation, seepage, and flow-through water losses from canals and ditches. Delivery and timing need to be flexible enough to meet varying plant water needs throughout the growing season.

Transporting irrigation water from the source of supply to the field irrigation system can be a significant source of water loss and cause of degradation of both surface water and ground water. Losses during transmission include seepage from canals and ditches, evaporation from canals and ditches, and flow-through water.⁹ The primary water quality concern is the development of saline seeps below the canals and ditches and the discharge of saline waters. Another water quality concern is the potential for erosion caused by the discharge of flow-through water. Practices that are used to ensure proper transportation of irrigation water from the source of supply to the field irrigation system can be found in the *USDA-SCS Handbook of Practices*, and include: irrigation water conveyance, ditch and canal lining (428); irrigation water conveyance, pipeline (430); and structure for water control (587).

Practices for Utilization of Runoff Water or Tailwater

The utilization of runoff water to provide additional irrigation or to reduce the amount of water diverted increases the efficiency of use of irrigation water. For surface irrigation systems that require runoff or tailwater as part of the design and operation, a tailwater management practice needs to be installed and used. The practice is described as follows:

■ i. **Irrigation system, tailwater recovery (447):** A facility to collect, store, and transport irrigation tailwater for reuse in the farm irrigation distribution system.

The reservoir will trap sediment and sediment attached substances from runoff waters. Sediment and chemicals will accumulate in the collection facility by entrapping which would decrease downstream yields of these substances.

⁹ Flow-through water is water that is never applied to the land but is needed to maintain hydraulic head in the ditch. Flow-through water is also water transported in excess of delivery requirements, carried to reduce the level of management necessary to adjust flows in the ditch for changed delivery locations and amounts. Typically this water (10 - 35 percent of delivery requirements) is applied to fields as excess flow above the requested or billed amount, or returned to the supply stream as delivery system tailwater. Often credit is given by the regulatory agency for this returned water.

Salts, soluble nutrients, and soluble pesticides will be collected with the runoff and will not be released to surface waters. Recovered irrigation water with high salt and/or metal content will ultimately have to be disposed of in an environmentally safe manner and location. Disposal of these waters should be part of the overall management plan. Although some ground water recharge may occur, little if any pollution hazard is usually expected.

Practices for Drainage Water Management

Drainage water from an irrigation system should be managed to reduce deep percolation, move tailwater to the reuse system, reduce erosion, and help control adverse impacts on surface water and groundwater. A total drainage system should be an integral part of the planning and design of an efficient irrigation system. This may not be necessary for those soils that have sufficient natural drainage abilities.

There are several practices to accomplish this:

- j. **Filter strip (393):** A strip or area of vegetation for removing sediment, organic matter, and other pollutants from runoff and waste water.

Filter strips for sediment and related pollutants meeting minimum requirements may trap the coarser grained sediment. They may not filter out soluble or suspended fine-grained materials. When a storm causes runoff in excess of the design runoff, the filter may be flooded and may cause large loads of pollutants to be released to the surface water. This type of filter requires high maintenance and has a relative short service life and is effective only as long as the flow through the filter is shallow sheet flow.

Filter strips for runoff from concentrated livestock areas may trap organic material, solids, materials which become adsorbed to the vegetation or the soil within the filter. Often they will not filter out soluble materials. This type of filter is often wet and is difficult to maintain.

Filter strips for controlled overland flow treatment of liquid wastes may effectively filter out pollutants. The filter must be properly managed and maintained, including the proper resting time. Filter strips on forest land may trap coarse sediment, timbering debris, and other deleterious material being transported by runoff. This may improve the quality of surface water and has little effect on soluble material in runoff or on the quality of ground water.

All types of filters may reduce erosion on the area on which they are constructed. Filter strips trap solids from the runoff flowing in sheet flow through the filter. Coarse-grained and fibrous materials are filtered more efficiently than fine-grained and soluble substances. Filter strips work for design conditions, but when flooded or overloaded they may release a slug load of pollutants into the surface water.

- k. **Surface drainage field ditch (607):** A graded ditch for collecting excess water in a field.

From erosive fields, this practice may increase the yields of sediment and sediment-attached substances to downstream water courses because of an increase in runoff. In other fields, the location of the ditches may cause a reduction in sheet and rill erosion and ephemeral gully erosion. Drainage of high salinity areas may raise salinity levels temporarily in receiving waters. Areas of soils with high salinity that are drained by the ditches may increase receiving waters. Phosphorus loads, resulting from this practice may increase eutrophication problems in ponded receiving waters. Water temperature changes will probably not be significant. Upland wildlife habitat may be improved or increased although the habitat formed by standing water and wet areas may be decreased.

- l. **Subsurface drain (606):** A conduit, such as corrugated plastic tile, or pipe, installed beneath the ground surface to collect and/or convey drainage water.

Soil water outletted to surface water courses by this practice may be low in concentrations of sediment and sediment-adsorbed substances and that may improve stream water quality. Sometimes the drained soil water is high in the

concentration of nitrates and other dissolved substances and drinking water standards may be exceeded. If drainage water that is high in dissolved substances is able to recharge ground water, the aquifer quality may become impaired. Stream water temperatures may be reduced by water drainage discharge. Aquatic habitat may be altered or enhanced with the increased cooler water temperatures.

- m. **Water table control (641):** Water table control through proper use of subsurface drains, water control structures, and water conveyance facilities for the efficient removal of drainage water and distribution of irrigation water.

The water table control practice reduces runoff, therefore downstream sediment and sediment-attached substances yields will be reduced. When drainage is increased, the dissolved substances in the soil water will be discharged to receiving water and the quality of water reduced. Maintaining a high water table, especially during the nongrowing season, will allow denitrification to occur and reduce the nitrate content of surface and ground by as much as 75 percent. The use of this practice for salinity control can increase the dissolved substance loading of downstream waters while decreasing the salinity of the soil. Installation of this practice may create temporary erosion and sediment yield hazards but the completed practice will lower erosion and sedimentation levels. The effect of the water table control of this practice on downstream wildlife communities may vary with the purpose and management of the water in the system.

- n. **Controlled drainage (335):** Control of surface and subsurface water through use of drainage facilities and water control structures.

The purpose is to conserve water and maintain optimum soil moisture to (1) store and manage infiltrated rainfall for more efficient crop production; (2) improve surface water quality by increasing infiltration, thereby reducing runoff, which may carry sediment and undesirable chemicals; (3) reduce nitrates in the drainage water by enhancing conditions for denitrification; (4) reduce subsidence and wind erosion of organic soils; (5) hold water in channels in forest areas to act as ground fire breaks; and (6) provide water for wildlife and a resting and feeding place for waterfowl.

Practices for Backflow Prevention

- o. **The American Society of Agricultural Engineers recommends, in standard EP409, safety devices to prevent backflow when injecting liquid chemicals into irrigation systems (ASAE Standards, 1989).**

The process of supplying fertilizers, herbicides, insecticides, fungicides, nematicides, and other chemicals through irrigation systems is known as chemigation. A backflow prevention system will "prevent chemical backflow to the water source" in cases when the irrigation pump shuts down (ASAE, 1989).

Three factors an operator must take into account when selecting a backflow prevention system are the characteristics of the chemical that can backflow, the water source, and the geometry of the irrigation system. Areas of concern include whether injected material is toxic and whether there can be backpressure or backsiphonage (ASAE, 1989; USEPA, 1989b).

Several different systems used as backflow preventers are:

- (1) **Air gap.** A physical separation in the pipeline resulting in a loss of water pressure. Effective at end of line service where reservoirs or storage tanks are desired.
- (2) **Check valve with vacuum relief and low pressure drain.** Primarily used as an antisiphon device (Figure 2-22).

- (3) **Double check valve.** Consists of two single check valves coupled within one body and can handle both backsiphonage and backpressure.
- (4) **Reduced pressure principle backflow preventer.** This device can be used for both backsiphonage and backpressure. It consists of a pressure differential relief valve located between two independently acting check valves.
- (5) **Atmospheric vacuum breaker.** Used mainly in lawn and turf irrigation systems that are connected to potable water supplies. This system cannot be installed where backpressure persists and can be used only to prevent backsiphonage.

6. Cost Information

A cost of \$10 per irrigated acre is estimated to cover investments in flow meters, tensiometers, and soil moisture probes (USEPA, 1992; Evans, 1992). Information from North Carolina indicates that the cost of devices to measure soil water ranges from \$3 to \$4,500 (Table 2-32). Gypsum blocks and tensiometers are the two most commonly used devices.

For quarter-section center pivot systems, backflow prevention devices cost about \$416 per well (Stolzenburg, 1992). This cost (1992 dollars) is for (1) an 8-inch, 2-foot-long unit with a check valve inside (\$386) and (2) a one-way injection point valve (\$30). Assuming that each well will provide about 800-1,000 gallons per minute, approximately 130 acres will be served by each well. The cost for backflow prevention for center pivot systems then becomes approximately \$3.20 per acre. In South Dakota, the cost for an 8-inch standard check valve is about \$300, while an 8-inch check valve with inspection points and vacuum release costs about \$800 (Goodman, 1992). The latter are required by State law. For quarter-section center pivot systems, the cost for standard check valves ranges from about \$1.88 per acre (corners irrigated, covering 160 acres) to \$2.31 per acre (circular pattern, covering about 130 acres).

Tailwater can be prevented in sprinkler irrigation systems through effective irrigation scheduling, but may need to be managed in furrow systems. The reuse of tailwater downslope on adjacent fields is a low-cost alternative to tailwater recovery and upslope reuse (Boyle Engineering Corp., 1986). Tailwater recovery systems require a suitable

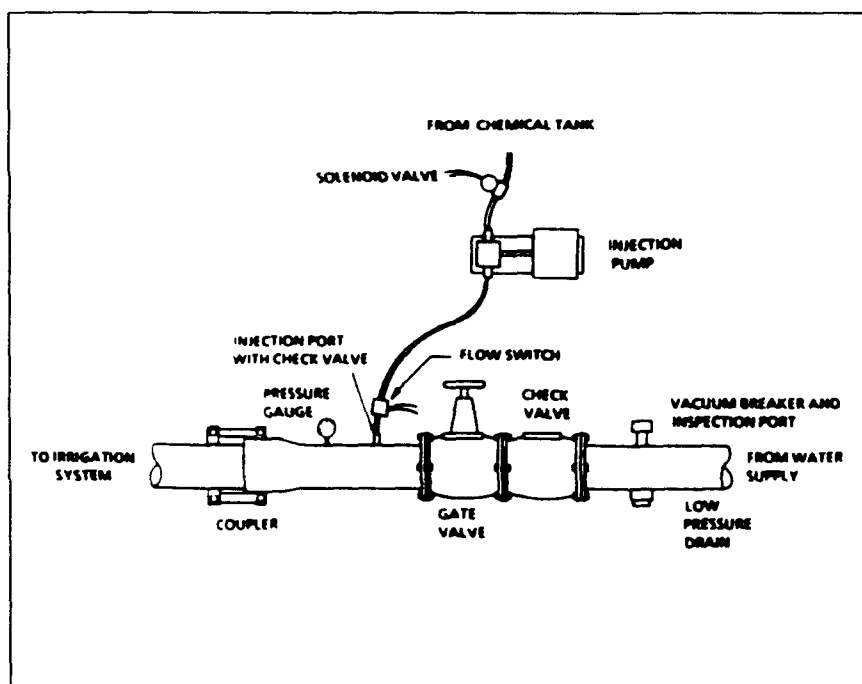

Figure 2-22. Backflow prevention device using check valve with vacuum relief and low pressure drain (ASAE, 1989).

Table 2-32. Cost of Soil Water Measuring Devices

Device	Approximate Cost
Flow meters ^a	\$35 to \$300, depending on size
Tensiometers ^a	\$35 and up, depending on size
Gypsum blocks ^a	\$3-4, \$200-400 for meter
Neutron Probe ^a	\$4,000-4,500
Phene Cell ^a	\$4,000-4,500
Flow meters, tensiometers, and soil moisture probes ^b	\$10 per irrigated acre

^a Sneed, 1992.

^b Evans, 1992.

drainage water receiving facility such as a sump or a holding pond, and a pump and pipelines to return the tailwater for reapplication (Boyle Engineering Corp., 1986). The cost to install a tailwater recovery system was about \$125/acre in California (California State Water Resources Control Board, 1987) and \$97.00/acre in the Long Pine Creek, Nebraska, RCWP (Hermesmyer, 1991).

The cost to install irrigation water conservation systems (ASCS practice WC4) for the primary purpose of water conservation in the 33 States that used the practice was about \$86.00 per acre served in 1991 (USDA-ASCS, 1992b). Practice WC4 increased the average irrigation system efficiency from 48 percent to 64 percent at an amortized cost of \$9.47 per acre foot of water conserved. The components of practice WC4 are critical area planting, canal or lateral, structure for water control, field ditch, sediment basin, grassed waterway or outlet, land leveling, water conveyance ditch and canal lining, water conveyance pipeline, trickle (drip) system, sprinkler system, surface and subsurface system, tailwater recovery, land smoothing, pit or regulation reservoir, subsurface drainage for salinity, and toxic salt reduction. When installed for the primary purpose of water quality, the average installation cost for WC4 was about \$52 per acre served. For erosion control, practice WC4 averaged approximately \$57 per acre served. Specific cost data for each component of WC4 are not available.

Water management systems for pollution control, practice SP35, cost about \$26 per acre served when installed for the primary purpose of water quality (USDA-ASCS, 1992b). When installed for erosion control, SP35 costs about \$19 per acre served. The components of SP35 are grass and legumes in rotation, underground outlets, land smoothing, structures for water control, subsurface drains, field ditches, mains or laterals, and toxic salt reduction.

The design lifetimes for a range of salt load reduction measures are presented in Table 2-33 (USDA-ASCS, 1988).

**Table 2-33. Design Lifetime for Selected Salt Load Reduction Measures
(USDA-ASCS, 1988)**

Practice/Structure	Design Life (years)
Irrigation Land Leveling	10
Irrigation Pipelines - Aluminum Pipe	20
Irrigation Pipelines - Rigid Gated Pipe	15
Irrigation Canal and Ditch Lining	20
Irrigation Field Ditches	1
Water Control Structure	20
Trickle Irrigation System	10
Sprinkler Irrigation System	15
Surface Irrigation System	15
Irrigation Pit or Regulation Reservoir	20
Subsurface Drain	20
Toxic Salt Reduction	1
Irrigation Tailwater Recovery System	20
Irrigation Water Management	1
Underground Outlet	20
Pump Plant for Water Control	15

III. GLOSSARY

10-year, 24-hour storm: A rainfall event of 24-hour duration and 10-year frequency that is used to calculate the runoff volume and peak discharge rate to a BMP.

25-year, 24-hour storm: A rainfall event of 24-hour duration and 25-year frequency that is used to calculate the runoff volume and peak discharge rate to a BMP.

Acceptable Management System (AMS): A combination of conservation practices and management that meets resource quality criteria established in the FOTG by the State Conservationist that is feasible within the social, cultural, or economic constraints identified for the resource conditions. It is expected that some degradation may continue to occur for the resource after the AMS is applied (Part 506, Glossary, SCS General Manual).

Adsorption: The adhesion of one substance to the surface of another.

Agronomic practices: Soil and crop activities employed in the production of farm crops, such as selecting seed, seedbed preparation, fertilizing, liming, manuring, seeding, cultivation, harvesting, curing, crop sequence, crop rotations, cover crops, strip-cropping, pasture development, and others (Soil Conservation Society of America, 1982).

Aquifer: A geologic formation or structure that transmits water in sufficient quantity to supply the needs for a water development; usually saturated sands, gravel, fractures, and cavernous and vesicular rock (Soil Conservation Society of America, 1982).

ASCS: Agricultural Stabilization and Conservation Service of USDA.

Animal unit: A unit of measurement for any animal feeding operation calculated by adding the following numbers: the number of slaughter and feeder cattle multiplied by 1.0, plus the number of mature dairy cattle multiplied by 1.4, plus the number of swine weighing over 25 kilograms (approximately 55 pounds) multiplied by 0.4, plus the number of sheep multiplied by 0.1, plus the number of horses multiplied by 2.0 (40 CFR Part 122, Appendix B).

AUM: Animal unit month. A measure of average monthly stocking rate that is the tenure of one animal unit for a period of 1 month. With respect to the literature reviewed for the grazing management measure, an animal unit is a mature, 1,000-pound cow or the equivalent based on average daily forage consumption of 26 pounds of dry matter per day (Platts, 1990). Alternatively, an AUM is the amount of forage that is required to maintain a mature, 1,000-pound cow or the equivalent for a one-month period. See *animal unit* for the NPDES definition.

Backflow prevention device: A safety device used to prevent water pollution or contamination by preventing flow of water and/or chemicals in the opposite direction of that intended (ASAE, 1989).

Best Management Practice (BMP): A practice or combination of practices that are determined to be the most effective and practicable (including technological, economic, and institutional considerations) means of controlling point and nonpoint pollutants at levels compatible with environmental quality goals (Soil Conservation Society of America, 1982).

Broiler: Bird that is raised for its meat production; usually produced in a 7-week period.

Center pivot: Automated sprinkler irrigation achieved by automatically rotating the sprinkler pipe or boom, supplying water to the sprinkler head or nozzle, as a radius from the center of the field to be irrigated (Soil Conservation Society of America, 1982).

Chemigation: The addition of one or more chemicals to the irrigation water.

Chemigated water: Water to which fertilizers or pesticides have been added.

Check valve: A device to provide positive closure that effectively prohibits the flow of material in the opposite direction of normal flow when operation of the irrigation system pumping plant or injection unit fails or is shut down (ASAE, 1989).

Composting: A controlled process of degrading organic matter by microorganisms (Soil Conservation Society of America, 1982).

Conservation management system (CMS): A generic term that includes any combination of conservation practices and management that achieves a level of treatment of the five natural resources that satisfies criteria contained in the Field Office Training Guide (FOTG), such as a resource management system or an acceptable management system (Part 506, Glossary, SCS General Manual).

Cover crop: A close-growing crop grown primarily for the purpose of protecting and improving soil between periods of regular crop production or between trees and vines in orchards and vineyards (Soil Conservation Society of America, 1982).

Crop residue: The portion of a plant or crop left in the field after harvest (Soil Conservation Society of America, 1982).

Crop rotation: The growing of different crops in recurring succession on the same land (Soil Conservation Society of America, 1982).

Defoliant: A herbicide that removes leaves from trees and growing plants (USEPA, 1989a).

Denitrification: The chemical or biochemical reduction of nitrate or nitrite to gaseous nitrogen, either as molecular nitrogen or as an oxide of nitrogen (Soil Conservation Society of America, 1982).

Deposition: The accumulation of material dropped because of a slackening movement of the transporting material—water or wind (Soil Conservation Society of America, 1982).

Desiccant: A chemical agent used to remove moisture from a material or object (Soil Conservation Society of America, 1982).

Dike: An embankment to confine or control water, especially one built along the banks of a river to prevent overflow of lowlands; a levee (Soil Conservation Society of America, 1982).

Diversion: A channel, embankment, or other man-made structure constructed to divert water from one area to another (Soil Conservation Society of America, 1982).

Effluent: Solid, liquid, or gaseous wastes that enter the environment as a by-product of man-oriented processes (Soil Conservation Society of America, 1982).

Empirical: Originating in or relying or based on factual information, observation, or direct sense experience.

EPA: United States Environmental Protection Agency.

Erosion: Wearing away of the land surface by running water, glaciers, winds, and waves. The term erosion is usually preceded by a definitive term denoting the type or source of erosion such as gully erosion, sheet erosion, or bank erosion (Brakensiek et al., 1979).

ES: Extension Service of USDA.

Evaporation: The process by which a liquid is changed to a vapor or gas (Soil Conservation Society of America, 1982).

Fallow: Allowing cropland to lie idle, either tilled or untilled, during the whole or greater portion of the growing season (Soil Conservation Society of America, 1982).

Fertilizer: Any organic or inorganic material of natural or synthetic origin that is added to a soil to supply elements essential to plant growth (Soil Conservation Society of America, 1982).

Field capacity: The soil-water content after the force of gravity has drained or removed all the water it can, usually 1 to 3 days after rainfall (Evans et al., 1991c).

Flume: An open conduit on a prepared grade, trestle, or bridge for the purpose of carrying water across creeks, gullies, ravines, or other obstructions; also used in reference to calibrated devices used to measure the flow of water in open conduits (Soil Conservation Society of America, 1982).

Forb: A broad-leaf herbaceous plant that is not a grass, sedge, or rush.

FOTG: USDA-SCS's Field Office Technical Guide.

Grade: (1) The slope of a road, channel, or natural ground. (2) To finish the surface of a canal bed, roadbed, top of embankment, or bottom of excavation (Soil Conservation Society of America).

Grazing unit: An area of public or private pasture, range, grazed woodland, or other land that is grazed as an entity.

Herbaceous: A vascular plant that does not develop woody tissue (Soil Conservation Society of America, 1982).

Herbicide: A chemical substance designed to kill or inhibit the growth of plants, especially weeds (Soil Conservation Society of America, 1982).

Herding: The guiding of a livestock herd to desired areas or density of distribution.

Holding pond: A reservoir, pit, or pond, usually made of earth, used to retain polluted runoff water for disposal on land (Soil Conservation Society of America, 1982).

Hybrid: A plant resulting from a cross between parents of different species, subspecies, or cultivar (Soil Conservation Society of America, 1982).

Hydrophyte: A plant that grows in water or in wet or saturated soils (Soil Conservation Society of America, 1982).

Incineration: The controlled process by which solids, liquid, or gaseous combustible wastes are burned and changed into gases; the residue produced contains little or no combustible material (Soil Conservation Society of America, 1982).

Inert: A substance that does not react with other substances under ordinary conditions.

Infiltration: The penetration of water through the ground surface into subsurface soil or the penetration of water from the soil into sewer or other pipes through defective joints, connections, or manhole walls (USEPA, 1989a).

Insecticide: A pesticide compound specifically used to kill or control the growth of insects (USEPA, 1989a).

Integrated Pest Management (IPM): A pest population management system that anticipates and prevents pests from reaching damaging levels by using all suitable tactics including natural enemies, pest-resistant plants, cultural

management, and the judicious use of pesticides, leading to an economically sound and environmentally safe agriculture.

Irrigation: Application of water to lands for agricultural purposes (Soil Conservation Society of America, 1982).

Irrigation scheduling: The time and amount of irrigation water to be applied to an area.

Karst: A type of topography characterized by closed depressions, sinkholes, underground caverns, and solution channels. See *sinkhole* (Soil Conservation Society of America, 1982).

Lagoon: A reservoir or pond built to contain water and animal wastes until they can be decomposed either by aerobic or anaerobic action (Soil Conservation Society of America, 1982).

Lateral: Secondary or side channel, ditch, or conduit (Soil Conservation Society of America, 1982).

Layer: Bird that is used to produce eggs for broilers, new layers, or consumption.

Leachate: Liquids that have percolated through a soil and that contain substances in solution or suspension (Soil Conservation Society of America, 1982).

Leaching: The removal from the soil in solution of the more soluble materials by percolating waters (Soil Conservation Society of America, 1982).

Legume: A member of a large family that includes many valuable food and forage species, such as peas, beans, peanuts, clovers, alfalfas, sweet clovers, lespedezas, vetches, and kudzu (Soil Conservation Society of America, 1982).

Levee: See *dike*.

Limiting nutrient concept: The application of nutrient sources such that no nutrient (e.g., N, P, K) is applied at greater than the recommended rate.

Livestock: Domestic animals.

Load: The quantity (i.e., mass) of a material that enters a waterbody over a given time interval (Soil Conservation Society of America, 1982).

Manure: The fecal and urinary defecations of livestock and poultry; may include spilled feed, bedding litter, or soil (Soil Conservation Society of America, 1982).

Micronutrient: A chemical element necessary in only extremely small amounts (less than 1 part per million) for the growth of plants (Soil Conservation Society of America, 1982).

NOAA: United States Department of Commerce, National Oceanic and Atmospheric Administration.

Nutrients: Elements, or compounds, essential as raw materials for organism growth and development, such as carbon, nitrogen, phosphorus, etc. (Soil Conservation Society of America, 1982).

Parasites: An organism that lives on or in a host organism during all or part of its existence. Nourishment is obtained at the expense of the host (Soil Conservation Society of America, 1982).

Pasture: Grazing lands planted primarily to introduced or domesticated native forage species that receives periodic renovation and/or cultural treatments such as tillage, fertilization, mowing, weed control, and irrigation. Not in rotation with crops.

Percolation: The downward movement of water through the soil (Soil Conservation Society of America, 1982).

Perennial plant: A plant that has a life span of 3 or more years (Soil Conservation Society of America, 1982).

Permanent wilting point: The soil water content at which healthy plants can no longer extract water from the soil at a rate fast enough to recover from wilting. The permanent wilting point is considered the lower limit of plant-available water (Evans et al., 1991c).

Permeability: The quality of a soil horizon that enables water or air to move through it; may be limited by the presence of one nearly impermeable horizon even though the others are permeable (Soil Conservation Society of America, 1982).

Pesticide: Any chemical agent used for control of plant or animal pests. Pesticides include insecticides, herbicides, fungicides, nematocides, and rodenticides.

Pheromone: A substance secreted by an insect or an animal that influences the behavior or morphological development, or both, of other insects or animals of the same species (Soil Conservation Society of America, 1982).

Plant-available water: The amount of water held in the soil that is available to plants; the difference between field capacity and the permanent wilting point (Evans et al., 1991c).

Pollutant: Dredged spoil, solid waste, incinerator residue, sewage, garbage, sewage sludge, munitions, chemical wastes, biological materials, radioactive materials, heat, wrecked or discarded equipment, rock, sand, cellar dirt, and industrial, municipal, and agricultural waste discharged into water (Section 502(6) of The Clean Water Act as amended by the Water Quality Act of 1987, Pub. L. 100-4).

Range: Land on which the native vegetation (climax or natural potential) is predominantly grasses, grass-like plants, forbs, or shrubs. Includes lands revegetated naturally or artificially when routine management of that vegetation is accomplished mainly through manipulation of grazing. Range includes natural grasslands, savannas, shrublands, most deserts, tundra, alpine communities, coastal marshes, wet meadows, and riparian areas.

Reduced-till: A system in which the primary tillage operation is performed in conjunction with special planting procedures to reduce or eliminate secondary tillage operations (Soil Conservation Society of America, 1982).

Residue: See *crop residue*.

Resource Management System (RMS): A combination of conservation practices and management identified by land or water uses that, when installed, will prevent resource degradation and permit sustained use by meeting criteria established in the FOTG for treatment of soil, water, air, plant, and animal resources (Part 506, Glossary, SCS General Manual).

Return flow: That portion of the water diverted from a stream that finds its way back to the stream channel either as surface or underground flow (Soil Conservation Society of America, 1982).

Riparian area: Vegetated ecosystems along a waterbody through which energy, materials, and water pass. Riparian areas characteristically have a high water table and are subject to periodic flooding and influence from the adjacent waterbody.

Root zone: The part of the soil that is, or can be, penetrated by plant roots (Soil Conservation Society of America, 1982).

Runoff: That part of precipitation, snow melt, or irrigation water that runs off the land into streams or other surface water. It can carry pollutants from the air and land into the receiving waters (USEPA, 1989a).

Salinity: The concentration of dissolved solids or salt in water (Soil Conservation Society of America, 1982).

Savannas: A grassland with scattered trees, either as individuals or clumps; often a transitional type between true grasslands and woodland.

SCS: Soil Conservation Service of USDA.

SCS Soils-5 Information: SCS Soil Interpretation Records data base, which contains a wide variety of soil characteristics and interpretations. Available through the Statistical Laboratory, Iowa State University, Ames, Iowa.

Sediment: The product of erosion processes; the solid material, both mineral and organic, that is in suspension, is being transported, or has been moved from its site of origin by air, water, gravity, or ice (USDA-SCS, 1991).

Sedimentation: The process or act of depositing sediment (Soil Conservation Society of America, 1982).

Seepage: Water escaping through or emerging from the ground along an extensive line or surface as contrasted with a spring, where the water emerges from a localized spot (Soil Conservation Society of America, 1982).

Settleable solids: Solids in a liquid that can be removed by stilling a liquid. Settling times of 1 hour (APHA/AWWA/WPFC, 1975) or more are generally used (Soil Conservation Society of America, 1982).

Sheet flow: Water, usually storm runoff, flowing in a thin layer over the ground surface (Soil Conservation Society of America, 1982).

Silage: A fodder crop that has been preserved in a moist, succulent condition by partial fermentation; such crops include corn, sorghums, legumes, and grasses (Soil Conservation Society of America, 1982).

Sinkhole: A depression in the earth's surface caused by dissolving of underlying limestone, salt, or gypsum; drainage is through underground channels; may be enlarged by collapse of a cavern roof (Soil Conservation Society of America, 1982).

Slope: The degree of deviation of a surface from horizontal, measured as a percentage, as a numerical ratio, or in degrees (Soil Conservation Society of America, 1982).

Sludge: The material resulting from chemical treatment of water, coagulation, or sedimentation (Soil Conservation Society of America, 1982).

Soil profile: A vertical section of the soil from the surface through all its horizons, including C horizons (Soil Conservation Society of America, 1982).

Soil survey: A general term for the systematic examination of soils in the field and in laboratories; their description and classification; the mapping of kinds of soil; the interpretation of soils according to their adaptability for various crops, grasses, and trees; their behavior under use or treatment for plant production or for other purposes; and their productivity under different management systems (Soil Conservation Society of America, 1982).

Soil water depletion volume: The amount of plant-available water removed from the soil by plants and evaporation from the soil surface (Evans et al., 1991c).

Surface water: All water whose surface is exposed to the atmosphere (Soil Conservation Society of America, 1982).

Suspended sediment: The very fine soil particles that remain in suspension in water for a considerable period of time (Soil Conservation Society of America, 1982).

Tailwater: Irrigation water that reaches the lower end of a field (Soil Conservation Society of America, 1982).

Tillage: The operation of implements through the soil to prepare seedbeds and rootbeds, control weeds and brush, aerate the soil, and cause faster breakdown of organic matter and minerals to release plant foods (Soil Conservation Society of America, 1982).

Tilth: The physical condition of the soil as related to its ease of tillage, its fitness as a seedbed, and its impedance to seedling emergence and root penetration (Soil Conservation Society of America, 1982).

Topography: The relative positions and elevations of the natural or man-made features of an area that describe the configuration of its surface (Soil Conservation Society of America, 1982).

USDA: United States Department of Agriculture.

Waste: Material that has no original value or no value for the ordinary or main purpose of manufacture or use; damaged or defective articles of manufacture; or superfluous or rejected matter or refuse (Soil Conservation Society of America, 1982).

Watershed: A drainage area or basin in which all land and water areas drain or flow toward a central collector such as a stream, river, or lake at a lower elevation.

Water table: The upper surface of the ground water or that level below which the soil is saturated with water; locus of points in soil water at which the hydraulic pressure is equal to atmospheric pressure (Soil Conservation Society of America, 1982).

Weir: Device for measuring or regulating the flow of water (Soil Conservation Society of America, 1982).

IV. REFERENCES

Adam, Real, et al. 1986. *Evaluation of Beef Feedlot Runoff Treatment by a Vegetative Filter Strip*. ASAE North Atlantic Regional Meeting. Paper No. NAR 86-208.

USDA. 1990. Soil and Water Conservation Practices: Special ACP Water Quality Project, Sand Mountain/Lake Guntersville. In *USDA Technical Guide, Section V*. U.S. Department of Agriculture, Alabama Soil Conservation Service.

APHA, AWWA, and WPCF. 1975. *Standard Methods for the Examination of Water and Wastewater*. American Public Health Association, American Water Works Association, and Water Pollution Control Federation, Washington, DC, pp. 95-96.

ASAE. 1989. *Standards, Engineering Practices and Data Developed and Adopted by the American Society of Agricultural Engineers*. Standard EP409. American Society of Agricultural Engineers, St. Joseph, MI.

USDA, ASCS/SCS, Oregon Dept. of Environmental Quality, and Oregon State University. 1991. *Tillamook Bay Rural Clean Water Project, 10-year Progress Report*. U.S. Department of Agriculture; Agricultural Stabilization and Conservation Service, and Soil Conservation Service, Washington, DC.

Baker, J.L. 1988. Potential Water Quality and Production Efficiency Benefits from Reduced Herbicide Inputs through Banding. In *Integrated Farm Management Demonstration Program: 1988 progress report*. Iowa State University, Ames.

Barbarika, A. Jr. 1987. Costs of Soil Conservation Practices. In *Optimum Erosion Control at Least Cost: Proceedings of the National Symposium on Conservation Systems*. American Society of Agricultural Engineers St. Joseph, MI, pp. 187-195.

Berry, J.T., and N. Hargett. 1984. *Fertilizer Summary Data*. Tennessee Valley Authority, National Fertilizer Development Center, Mussel Shoals, AL.

Bouldin, D., W. Reid, and D. Lathwell. 1971. Fertilizer Practices Which Minimize Nutrient Loss. In *Proceedings of Cornell University Conference on Agricultural Waste Management Agricultural Wastes: Principles and Guidelines for Practical Solutions*, Syracuse, NY.

Boyle Engineering Corp. 1986. *Evaluation of On-Farm Management Alternatives*. Prepared for the San Joaquin Valley Drainage Program, Sacramento, CA.

Brakensiek, D.L., H.B. Osborn, and W.J. Rawls. 1979. *Field Manual for Research in Agricultural Hydrology*. Agriculture Handbook No. 224. U.S. Department of Agriculture, Science and Education Administration, Beltsville, MD.

California SWRCB 1987. *Regulation of Agricultural Drainage to the San Joaquin River: Executive Summary*. California State Water Resources Control Board. Doc. No. WQ-85-1.

California State Water Resources Control Board. 1991. *Demonstration of Emerging Technologies*. California State Water Resources Control Board. Doc. No. 91-20-WQ.

Camacho, R. 1991. *Financial Cost Effectiveness of Point and Nonpoint Source Nutrient Reduction Technologies in the Chesapeake Bay Basin*. Interstate Commission on the Potomac River Basin, Rockville, Maryland. Unpublished draft.

- Cumberland County (Maine) Soil and Water Conservation District. undated. *Innovative Livestock Watering System and Improving Pasture Profits*.
- Dickey, E.C. 1981. Performance and Design of Vegetative Filters for Feedlot Runoff Treatment. In *Proceedings of the Fourth International Symposium on Livestock Wastes, Livestock Waste: A Renewable Resource*.
- DPRA. 1986. *An Evaluation of the Cost Effectiveness of Agricultural Best Management Practices and Publicly Owned Treatment Works in Controlling Phosphorus Pollution in the Great Lakes Basin*. Prepared by DPRA Inc. for U.S. Environmental Protection Agency, Washington, DC.
- DPRA. 1989. *Evaluation of the Cost Effectiveness of Agricultural Best Management Practices and Publicly Owned Treatment Works in Controlling Phosphorus Pollution in the Great Lakes Basin*. Prepared by DPRA Inc. for U.S. Environmental Protection Agency under contract no. 68-01-7947, Manhattan, KS.
- DPRA. 1992. *Draft Economic Impact Analysis of Coastal Zone Management Measures Affecting Confined Animal Facilities*. Prepared by DPRA Inc. for U.S. Environmental Protection Agency under contract no. 68-C99-0009, Manhattan, KS.
- Eckert, R.E., and J.S. Spencer. 1987. Growth and Reproduction of Grasses Heavily Grazed under Rest-Rotation Management. *Journal of Range Management*, 40(2):156-159.
- Edwards, W.M., L.B. Owens, R.K. White, and N.R. Fausey. 1986. Managing Feedlot Runoff with a Settling Basin Plus Tiled Infiltration Bed. *Transactions of the ASAE*, 29(1):243-247.
- Edwards, W.M., L.B. Owens, and R.K. White. 1983. Managing Runoff from a Small, Paved Beef Feedlot. *Journal of Environmental Quality*, 12(2).
- Evans, R.O. 1992. Biological and Agricultural Engineering Department, North Carolina State University, Raleigh, NC, personal communication.
- Evans, R.O., D.K. Cassel, and R.E. Sneed. 1991a. *Calibrating Soil-Water Measuring Devices*. North Carolina Cooperative Extension Service, Raleigh, NC. AG-452-3.
- Evans, R.O., D.K. Cassel, and R.E. Sneed. 1991b. *Measuring Soil Water for Irrigation Scheduling: Monitoring Methods and Devices*. North Carolina Cooperative Extension Service, Raleigh, NC. AG-452-2.
- Evans, R.O., D.K. Cassel, and R.E. Sneed. 1991c. *Soil, Water and Crop Characteristics Important to Irrigation Scheduling*. North Carolina Cooperative Extension Service, Raleigh, NC. AG-452-1.
- Evans, R.O., R.E. Sneed, and D.K. Cassel. 1991d. *Irrigation Scheduling to Improve Water- and Energy-Use Efficiencies*. North Carolina Cooperative Extension Service, Raleigh, NC. AG-452-4.
- Fresno Field Office and River Basin Planning Staff. 1979. *Comparison of Alternative Management Practices, Molar Flats Pilot Study Area, Fresno County, California*, Mini-Report. U.S. Department of Agriculture, Soil Conservation Service, Davis, CA.
- Goodman, J. 1992. South Dakota Department of Environment and Natural Resources, Pierre, SD, personal communication.
- Hallberg, G.R., et al. 1991. *A Progress Review of Iowa's Agricultural-Energy-Environmental Initiatives: Nitrogen Management in Iowa*, Technical Information Series 22, Iowa Department of Natural Resources, Iowa City, IA.

- Heimlich, R.E., and N.L. Bills. 1984. An improved soil erosion classification for conservation policy. *Journal of Soil and Water Conservation*, 39(4):261-267.
- Hermesmeyer, B. 1991a. *Nebraska Long Pine Creek Rural Clean Water Program 10-year Report 1981-1991*. Brown County Agricultural Stabilization and Conservation Service, Ainsworth, NE.
- Hermesmeyer, B. 1991b. *Pre-publication Charts for the Long Pine RCWP 10-year Report*. Agricultural Stabilization and Conservation Service, Ainsworth, NE.
- Hubert, W.A., R.P. Lanka, T.A. Wesch, and F. Stabler. 1985. Grazing Management Influences on Two Brook Trout Streams in Wyoming. In *Riparian Ecosystems and Their Management: Reconciling Conflicting Uses*. U.S. Department of Agriculture, Forest Service, Rocky Mountain Forest and Range Experiment Station. General Technical Report RM-120, pp.290-294.
- Iowa State University. 1991a. Ag Programs Bring Economic, Environmental Benefits. In *Extension News*. Extension Communications, Ames, IA.
- Iowa State University. 1991b. *Nitrogen Use in Iowa*. Prepared for the nitrogen use press conference Dec. 5, 1991, University Extension, Ames, IA.
- Kauffman, J.B., W.C. Krueger, and M. Vavra. 1983. Effects of Late Season Cattle Grazing on Riparian Plant Communities. *Journal of Range Management*, 36(6):685-691.
- Killorn, R. 1990. *Trends in Soil Test P and K in Iowa*, Paper Presented at the 20th North Central Extension-Industry Soil Fertility Workshop, 14-15 November, Bridgeton, MO.
- Logan, T.J. 1990. Agricultural Best Management Practices and Groundwater Protection. *Journal of Soil and Water Conservation*. 45(2):201-206.
- Lowrance, R.R., S. McIntyre, and C. Lance. 1988. Erosion and Deposition in a Field/Forest System Estimated Using Cesium-137 Activity, *Journal of Soil and Water Conservation*, 43(2):195-199.
- Lugbill, J. 1990. *Potomac River Basin Nutrient Inventory*. Metropolitan Washington Council of Governments, Washington, DC.
- Magdoff, F.R., D. Ross, and J. Amadon. 1984. A Soil Test for Nitrogen Availability to Corn. *Soil Science Society of America Journal*, 48:1301-1304.
- Maryland Department of Agriculture. 1990. *Nutrient Management Program*. Maryland Department of Agriculture, Annapolis, MD.
- McDougald, N.K., W.E. Frost, and D.E. Jones. 1989. *Use of Supplemental Feeding Locations to Manage Cattle Use on Riparian Areas of Hardwood Rangelands*. U.S. Department of Agriculture Forest Service. General Technical Report PSW-110, pp 124-126.
- Mielke, L.N., and J.R.C. Leavitt. 1981. *Herbicide Loss in Runoff Water and Sediment as Affected by Center Pivot Irrigation and Tillage Treatments*. U.S. Department of the Interior, Office of Water Research and Technology. Report A-062-NEB.
- Miner, J.R., J.C. Buckhouse, and J.A. Moore. 1991. Evaluation of Off-Stream Water Source to Reduce Impact of Winter Fed Range Cattle on Stream Water Quality. In *Nonpoint Source Pollution: The Unfinished Agenda for the Protection of Our Water Quality*, 20-21 March, 1991, Tacoma, WA. Washington Water Research Center, Report 78, pp. 65-75.

- Mitsch, W.J., and J.G. Gosselink. 1986. *Wetlands*. Van Nostrand Reinhold, New York.
- NRDC. 1991. *Harvest of Hope: The Potential for Alternative Agriculture to Reduce Pesticide Use*. Natural Resources Defense Council, New York.
- Nelson, D. 1985. Minimizing Nitrogen Losses in Non-irrigated Eastern Areas. In *Proceedings of the Plant Nutrient Use and the Environment Symposium, Plant Nutrient Use and the Environment*, 21-23 October, 1985, Kansas City, MO, pp. 173-209. The Fertilizer Institute.
- North Carolina State University. 1984. *Best Management Practices for Agricultural Nonpoint Source Control: IV. Pesticides*. North Carolina State University, National Water Quality Evaluation Project, Raleigh, NC.
- North Carolina Agricultural Extension Service. 1982. *Best Management Practices for Agricultural Nonpoint Source Control III: Sediment*. In cooperation with USEPA and USDA. Raleigh, North Carolina.
- Northup, B.K., D.T. Goerend, D.M. Hays, and R.A. Nicholson. 1989. Low Volume Spring Developments. *Rangelands*, 11(1):39-41.
- Novais, R., and E.J. Kamprath. 1978. Phosphorus Supplying Capacities of Previously Heavily Fertilized Soils. *Soil Science Society of America Journal*, 42:931-935.
- Owens, L.B., R.W. Van Keuren, and W.M. Edwards. 1982. Environmental Effects of a Medium-Fertility 12-Month Pasture Program: II. Nitrogen. *Journal of Environmental Quality*, 11(2):241-246.
- Pennsylvania State University. 1992a. Nonpoint Source Database. Pennsylvania State University, Dept. of Agricultural and Biological Engineering, University Park, PA. (see Appendix 2-B for list of references.)
- Pennsylvania State University. 1992b. College of Agriculture, Merkle Laboratory - Soil & Forage Testing, University Park, PA.
- Platts, W.S. 1990. *Managing Fisheries and Wildlife on Rangelands Grazed by Livestock, A Guidance and Reference Document for Biologists*. Nevada Department of Wildlife, Reno, NV.
- Platts, W.S., and R.L. Nelson. 1989. Characteristics of Riparian Plant Communities and Streambanks with Respect to Grazing in Northeastern Utah. In *Practical Approaches to Riparian Resource Management - An Educational Workshop*, ed. R.E. Gressell, B.A. Barton, and J.L. Kershner, pp.73-81. U.S. Department of the Interior, Bureau of Land Management.
- Reed, A.D., J.L. Meyer, F.K. Aljibury, and A.W. Marsh. 1980. *Irrigation Costs*. University of California, Division of Agricultural Sciences, Leaflet 2875 (as reported by Boyle Engineering Corp., 1986).
- Robillard, P.D., and M.F. Walter. 1986. *Nonpoint Source Control of Phosphorus - A Watershed Evaluation. Vol. 2. Development of Manure Spreading Schedules to Decrease Delivery of Phosphorus to Surface Waters*. U.S. Environmental Protection Agency, Robert S. Kerr Environmental Research Laboratory, Ada, OK. Internal report.
- Russell, J.R., and L. A. Christensen. 1984. *Use and Cost of Soil Conservation and Water Quality Practices in the Southeast*. U.S. Dept. of Agriculture, Economic Research Service, Washington, DC.
- Sanders, J.H., D. Valentine, E. Schaeffer, D. Greene, and J. McCoy. 1991. *Double Pipe Creek RCWP: Ten Year Report*. U.S. Department of Agriculture, University of Maryland Cooperative Extension Service, Maryland Department of the Environment, and Carroll County Soil Conservation District.

- Schwab, G.O., R.K. Frevert, T.W. Edminster and K.K. Barnes. 1981. *Soil and Water Conservation Engineering*. 3rd ed. John Wiley & Sons, New York.
- Sims, J.T. 1992. Environmental management of phosphorus in agricultural and municipal wastes. In *Future Directions for Agricultural Pollution Research*, ed. F.J. Sikora. Tennessee Valley Authority, Muscle Shoals, AL. Bulletin Y-224.
- Smolen, M.D., and F.J. Humenik. 1989. *National Water Quality Evaluation Project 1988 Annual Report: Status of Agricultural Nonpoint Source Projects*. U.S. Environmental Protection Agency and U.S. Department of Agriculture, Washington, DC. EPA-506/9-89/002.
- Sneed, R. 1992. Biological and Agricultural Engineering Department, North Carolina State University, Raleigh, NC, personal communication.
- Soil Conservation Society of America. 1982. *Resource Conservation Glossary*, 3rd ed.
- Stolzenburg, B. 1992. University of Nebraska, Cherry County Cooperative Extension Service, Valentine, NE, personal communication.
- Sutton, A.L. 1990. *Animal Agriculture's Effect on Water Quality: Pastures & Feedlots*. Purdue University Cooperative Extension Service, West Lafayette, IN. Doc. No. WQ7.
- Tiedemann, A.R., D.A. Higgins, T.M. Quigley, H.R. Sanderson, and C.C. Bohn. 1988. *Bacterial Water Quality Responses to Four Grazing Strategies - Comparison with Oregon Standards*.
- USDA. 1991. *An Interagency Report: Rock Creek Rural Clean Water Program Final Report 1981-1991*. U.S. Department of Agriculture, Twin Falls, ID.
- USDA. 1992. *Educational, Technical, and Financial Assistance for Water Quality, Report of Fiscal Year 1991 Operations*. U.S. Department of Agriculture, Agricultural Stabilization and Conservation Service, Extension Service, and Soil Conservation Service. Washington, DC.
- USDA-ARS. 1987. *User Requirements. USDA-Water Erosion Prediction Project (WEPP). Draft 6.3*. U.S. Department of Agriculture, Agricultural Research Service, Beltsville, MD.
- USDA-ASCS. 1988. *Moapa Valley, Colorado River Salinity Control Program, Project Implementation Plan (PIP)*. U.S. Department of Agriculture, Agricultural Stabilization and Conservation Service, Washington, DC.
- USDA-ASCS. 1990. *Agricultural Conservation Program - 1989 Fiscal Year Statistical Summary*. U.S. Department of Agriculture, Agricultural Stabilization and Conservation Service, Washington, DC.
- USDA-ASCS. 1991a. *Oakwood Lakes-Poinsett Project 20 Rural Clean Water Program Ten Year Report*. U.S. Department of Agriculture, Agricultural Stabilization and Conservation Service, Brookings, SD.
- USDA-ASCS. 1991b. *Agricultural Conservation Program - 1990 Fiscal Year Statistical Summary*. U.S. Department of Agriculture, Agricultural Stabilization and Conservation Service, Washington, DC.
- USDA-ASCS. 1992a. *Conestoga Headwaters Project Pennsylvania Rural Clean Water Program 10-Year Report 1981-1991*. U.S. Department of Agriculture, Agricultural Stabilization and Conservation Service, Harrisburg, PA.
- USDA-ASCS. 1992b. *Agricultural Conservation Program - 1991 Fiscal Year Statistical Summary*. U.S. Department of Agriculture, Agricultural Stabilization and Conservation Service, Washington, DC.

- USDA-ERS. 1991. *Agricultural Outlook*, AO-183, March 1991. U.S. Department of Agriculture, Economic Research Service, Washington, DC.
- USDA-SCS. 1983. *Water Quality Field Guide*. U.S. Department of Agriculture, Soil Conservation Service, Washington, DC. SCS-TP-160.
- USDA-SCS. 1984. *Engineering Field Manual*. U.S. Department of Agriculture, Soil Conservation Service, Washington, DC.
- USDA-SCS. 1988. I-4 Effects of Conservation Practices on Water Quantity and Quality. In *Water Quality Workshop, Integrating Water Quality and Quantity into Conservation Planning*. U.S. Department of Agriculture, Soil Conservation Service, Washington, DC.
- USDA-SCS, Michigan. 1988. Flat Rate Schedule - Costs of Conservation Practices. In *Technical Guide Section V-A-3*. U.S. Department of Agriculture, Soil Conservation Service, MI.
- USDA-SCS. 1991. *Water Quality Field Guide*. U.S. Department of Agriculture, Soil Conservation Service, Washington, DC. SCS-TP-160.
- USEPA. 1981. *ANSWERS - Users Manual*. U.S. Environmental Protection Agency, Great Lakes National Program Office, Chicago, IL. EPA-905/9-82-001.
- USEPA. 1982. *Planning Guide for Evaluating Agricultural Nonpoint Source Water Quality Controls*. U.S. Environmental Protection Agency, Office of Research and Development, Environmental Research Laboratory, Athens, GA. EPA-600/3-82-021.
- USEPA. 1989a. U.S. Environmental Protection Agency. National Primary and Secondary Drinking Water Standards; Proposed Rule. 40 CFR Parts 141, 142, and 143.
- USEPA. 1989b. *Glossary of Environmental Terms And Acronym List*. U.S. Environmental Protection Agency, Office of Communications and Public Policy. Washington, DC. 19K-1002.
- USEPA. 1989c. *Cross-Connection Control Manual*. U.S. Environmental Protection Agency, Office of Water. Washington, DC.
- USEPA. 1991a. *1990 Annual Progress Report for the Baywide Nutrient Reduction Strategy*. U.S. Environmental Protection Agency, Chesapeake Bay Program, Annapolis, MD.
- USEPA. 1991b. *Pesticides and Groundwater Strategy*. U.S. Environmental Protection Agency, Office of Prevention, Pesticides and Toxic Substances, Washington, DC.
- USEPA. 1992. *Preliminary Economic Achievability Analysis: Agricultural Management Measures*. U.S. Environmental Protection Agency, Office of Policy, Planning and Evaluation, Washington, DC.
- University of California Committee of Consultants on Drainage Water Reduction. 1988. *Associated Costs of Drainage Water Reduction*.
- University of Maryland. 1990. *Example Nutrient Management Plan*. University of Maryland, Cooperative Extension Service, University Park, MD.
- Van Poollen, H.W., and J.R. Lacey. 1979. Herbage Response to Grazing Systems and Stocking Intensities. *Journal of Range Management*, 32(4):250-253.

Virginia Cooperative Extension Service, Virginia Tech Virginia State, and U.S. Department of Agriculture - Extension Service. 1987. *The National Evaluation of Extension's Integrated Pest Management (IPM) Programs*. Virginia Cooperative Extension Service, Virginia Tech, Virginia State University, and U.S. Department of Agriculture, Cooperative Extension Service. Virginia Cooperative Extension Publication 491-010.

Wall, D.B., S.A. McGuire, and J.A. Magner. 1989. *Water Quality Monitoring and Assessment in the Garvin Brook Rural Clean Water Project Area*. Minnesota Pollution Control Agency, St. Paul, MN.

Westerman, P.W., L.M. Safley, J.C. Barker, and G.M. Chescheir. 1985. Available Nutrients in Livestock Waste. In *Proceedings of the Fifth International Symposium on Agricultural Wastes, Agricultural Waste Utilization and Management*, American Society of Agricultural Engineers, St. Joseph, MI, pp. 295-307.

Wisconsin Department of Agriculture, Trade and Consumer Protection. 1989. *Nutrient and Pesticide Best Management Practices for Wisconsin Farms*. Prepared by University of Wisconsin-Extension and Wisconsin Department of Agriculture, Trade and Consumer Protection.

Workman, J.P., and J.F. Hooper. 1968. Preliminary Economic Evaluation of Cattle Distribution Practices on Mountain Rangelands. *Journal of Range Management*, 21(3):301-304.



Appendix 2A
SCS Field Office Technical Guide Policy



February 12, 1990

GENERAL MANUAL
450-TCH
AMENDMENT - 4 (PART 401)

SUBJECT: TCH - SCS TECHNICAL GUIDE POLICY

Purpose. To transmit revised Soil Conservation Service (SCS) Field Office Technical Guide (FOTG) policy.

Effective Date. This policy is effective when received.

Background. SCS Field Office Technical Guide policy was revised by 450-GM, Amendment 3, February 1987. As a result of numerous comments received on that policy, the National Technical Guide Committee (NTGC) prepared a draft revision for review by selected states and by technical guide committees at the National Technical Centers. Amendment 4 is the result of comments on the draft.

Explanation. Policy transmitted by this amendment contains guidance by which FOTG are established, changed and maintained. Following are the more important changes from Amendment 3:

1. State and NTC responsibilities in Section 401.01 for maintaining up-to-date information in technical guides have been amplified.
2. The descriptions of the six resource concerns in Section 401.03(b)(3)(iii) have been replaced with descriptions of the five resources: soil, water, air, plants, and animals.
3. Criteria for treatment required to achieve an RMS for each of the five resources have been clearly stated in Section 401.03(b)(iv).
4. The process for developing criteria for treatment required to achieve an Acceptable Management System (AMS), a new concept, has been stated in section 401.03(b)(3)(v).
5. Explanation of the content of the National Handbook for Conservation Practices (NHCP) in Subpart B has been revised to remove redundant statements and clearly states responsibilities for changes in NHCP and for issuance and review of interim standards.
6. Section V of the FOTG, described in section 401.03(b)(5), has been totally revised and is now named "Conservation Effects." Guidance on effects is provided to aid in conservation planning activities.

DIST: GM



Filing Instructions:

1. Remove and discard existing GM 450, Part 401, dated February 1987. (Amendment 3)
2. Replace with the enclosed GM 450, Part 401, dated January 1990.

Directives Cancelled:

1. Remove and discard National Instruction No. 450-301, dated October 5, 1979.



WILSON SCALING
Chief

Enclosures

PART 401 - TECHNICAL GUIDES

SUBPART A - POLICY AND RESPONSIBILITIES

401.00(d)(5)

401.00 General.

(a) This part states policy for establishing, changing, and maintaining technical guides. It also establishes supporting committees for maintaining those guides.

(b) The Soil Conservation Service (SCS) is responsible for providing national leadership and administration of programs to conserve soil, water, and related resources on the private lands of the Nation. A primary goal is to provide technical assistance to decision-makers for the planning and implementation of a system of conservation practices and management which achieves a level of natural resource protection that prevents degradation and permits sustainable use. In cases where degradation has already occurred, the goal is to restore the resource to the degree practical to permit sustainable use. Technical guides provide procedures and criteria for the formulation and evaluation of resource management systems which achieve these goals and, when needed, for the formulation and evaluation of acceptable management systems which achieve these goals to the extent feasible.

(c) Technical guides are primary technical references for SCS. They contain technical information about conservation of soil, water, air, and related plant and animal resources. Technical guides used in any office are to be localized so that they apply specifically to the geographic area for which they are prepared. These documents are referred to as Field Office Technical Guides (FOTGs). Appropriate parts of FOTG will be systematically automated as data bases, computer programs, and other electronic-based materials compatible with the Computer Assisted Management and Planning System (CAMPS) are developed.

(d) Technical guides provide:

- (1) Soil interpretations and potential productivity within alternative levels of management intensity and conservation treatment;
- (2) Technical information for achieving SCS's and the decisionmaker's objectives;
- (3) Information for interdisciplinary planning for the conservation of soil, water, and related resources;
- (4) A basis for identifying resource management system (RMS) options and, when needed, acceptable management system (AMS) options and components thereof;
- (5) Information on effects of resource management systems, acceptable management

Part 401-Technical Guides

401.00(d)(6)

systems, and their component practices;

(6) Criteria to evaluate the quality of RMS options, AMS options, and components thereof;

(7) Standards and specifications for conservation practices;

(8) Information for evaluating the economic feasibility of conservation practices and resource management system options;

(9) Information for locating and identifying cultural resources and methods to account for their significance; and

(10) Technical material for training employees.

401.01 Responsibilities.

(a) National Headquarters (NHQ).

(1) The Deputy Chief for Technology has national leadership for policy and procedures for developing and using the FOTG.

(2) The Director, Ecological Sciences Division (ECS), chairs the National Technical Guide Committee (NTGC).

(3) The NTGC makes recommendations to the Deputy Chief for Technology regarding technical guide policy and procedure.

(b) National Technical Centers (NTCs).

(1) NTC directors are responsible for establishing a Technical Guide Committee (TGC) at each NTC.

(2) The TGC provides guidance to states in developing FOTGs.

(3) NTC directors establish procedures to coordinate NTC technical review and concurrence of state developed material that affect either policy or technical aspects in all sections of the FOTG.

(4) The TGC coordinates NTC technical review and concurrence of state developed material as described in (3). The NTC director will inform the state conservationist (STC) of NTC action and comments.

(5) The TGC refers proposed changes in the National Handbook of Conservation Practices (NHCP) to NTGC for action.

Subpart A - Policy and Responsibilities

401.01(d)(1)(i)

(6) NTC provide states with examples of guidance documents for RMS and AMS options, displays of conservation effects, and guidance documents developed to meet specific program requirements. NTC has primary technical oversight.

(7) NTC directors are responsible for coordination and consistency among NTC regions.

(c) State offices.

(1) The state conservationist (STC) is responsible for the development, quality, coordination, use, and maintenance of FOTG in his/her state.

(2) The STC will:

(i) Coordinate FOTG contents across state lines where Major Land Resource Areas are shared to achieve reasonable uniformity between and among states;

(ii) Request appropriate assistance from the NTC director to prepare, revise, and maintain the FOTG and to correlate FOTG contents with adjoining states;

(iii) Submit to the NTC for review and concurrence all state developed materials that affect either policy or technical aspects in all FOTG sections prior to issuance;

(iv) Propose interim standards, variances, or changes in national standards to the NTC director for action;

(v) Establish a state TGC and appoint membership;

(vi) Establish criteria for RMS and AMS with concurrence by the NTC; and

(vii) Establish procedures for maintaining up-to-date data in FOTG. All FOTG material is to be reviewed by the designated state discipline specialist at least once every two years. Material is to be updated as necessary to maintain technical adequacy. Each technical guide subsection described in section 401.03(b) is to contain a table of contents showing the issue date and the date of the last review.

(d) Area offices.

(1) The area conservationist (AC) will:

(i) Coordinate the development, use, and maintenance of FOTG in the field offices supervised;

Part 401-Technical Guides

401.01(d)(1)(ii)

- (ii) Work with the specialists in the state offices to achieve high-quality FOTG; and
- (iii) Establish an area-level TGC if necessary.

(e) Field offices.

(1) District conservationists (DC) will:

- (i) Take the lead to develop and assemble the FOTG;
- (ii) Use and maintain the FOTG in the office(s) they supervise;
- (iii) Ensure that all field office technical assistance is based on FOTG contents;
- (iv) Identify needed changes and/or additions; and
- (v) Request specialist help to make improvements.

(2) All field office employees are responsible for identifying the need for improvements and for informing the DC of those needs.

401.02 National Technical Guide Committee (NTGC).

(a) Membership. The members of the NTGC are:

- (1) Director, Ecological Sciences Division (chairperson);
- (2) Director, Engineering Division;
- (3) Director, Economics and Social Sciences Division;
- (4) Director, Soil Survey Division;
- (5) Director, Land Treatment Program Division;
- (6) Director, Conservation Planning Division;
- (7) Director, Watershed Projects Division;
- (8) Director, Basin and Area Planning Division;
- (9) Director of an NTC (on a 1-year rotation);
- (10) Executive Secretary (appointed by the chairperson); and
- (11) Chair of National Conservation Practice Standards Subcommittee (NCPSS) (appointed by the NTGC chairperson).
- (12) A representative from the Extension Service will be invited to participate in all NTGC meetings.

(b) Responsibilities.

- (1) Keep national FOTG policy and procedures current by recommending policy changes to the Deputy Chief for Technology.

Subpart A - Policy and Responsibilities

401.03(b)(1)(i)

- (2) Respond to requests for FOTG policy and procedure clarification.
- (3) Designate members of the National Conservation Practice Standards Subcommittee.
- (4) Act upon recommendations from NCPSS.
- (5) Coordinate policy and procedures established to automate FOTG contents and functions in SCS operations.
- (6) Create ad hoc subcommittees as necessary.
- (7) Receive and act upon requests, recommendations, referrals, and suggestions from the NTC TGC.

(c) NTGC operation.

- (1) NTGC will meet quarterly and otherwise as convened by the chairperson.
- (2) Materials for consideration by the NTGC will be sent to the chairperson.
- (3) Minutes of each meeting will be sent to each member, the Deputy Chiefs for Technology and Programs, and NTC directors.
- (4) Matters requiring action will be acted upon within 45 days of receipt.

401.03 Content of technical guides.

(a) Technical guides contain Sections I through V and appropriate subsections. Those sections are:

- (1) Section I - General Resource References;
- (2) Section II - Soil and Site Information;
- (3) Section III - Conservation Management Systems;
- (4) Section IV - Practice Standards and Specifications; and
- (5) Section V - Conservation Effects.

(b) The following are descriptions of technical guide sections and subsections:

(1) Section I - General Resource References.

This section lists references and other information for use in understanding the field office working area or in making decisions about resource use and management systems. The actual references listed are to be filed to the extent possible in the same location as the FOTG. References kept in other locations will be cross-referenced. The following are subsections of Section I of the FOTG.

(i) **Reference lists.** These include handbooks, manuals, and reports commonly used in resource conservation planning and implementation activities such as irrigation and drainage guides; the *National List of Scientific Plant Names* (NLSPN); the *National Register of*

Part 401-Technical Guides

401.03(b)(1)(i)

Historic Places; published soil surveys; basic water resources information on ground water quality, surface water quality, and water quantity; recreation potential appraisals; natural resource inventories; reports that identify such items as areas susceptible to flooding; river basin reports; seismic zones; and documentation of useful computer models.

(ii) **Cost data.** General reference data on costs, such as cost lists for practice components.

(iii) **Maps.** The SCS National Planning Manual (NPM), Part 507, Exhibits 507.09, contains a list of resource maps that should be included. Water quality problem areas and areas with a potential water quality problem are to be included here.

(iv) **Erosion prediction.** Guidance, data, and SCS approved techniques for predicting soil erosion are to be included here, or appropriately referenced.

(v) **Climatic data.** This subsection contains local climatic data needed for planning conservation management systems and installing conservation practices, such as record low and high temperatures; averages for such items as rainfall, length of growing season, temperatures, wind velocities, hail incidence, and snowfall; water supply data; probability of receiving selected amounts of precipitation by months; and frost-free periods. References should be made to other climatic data in other field office documents.

(vi) **Cultural (archaeological and historic) resource information.** This subsection contains general locational data and documentation suitable for inventory, checking and recording, and conservation planning. The law states that specific locational information, such as site maps, is not to be available to the general public; therefore they should only be referenced in this subsection.

(vii) **Threatened and endangered species list.** This subsection contains information on species of plants and animals that are threatened and endangered and are to be accounted for in conservation planning.

(viii) **Laws.** List of state and local laws, ordinances, or regulations that impact Conservation Management System development and other technical applications such as conservation practice application.

(2) Section II - Soil and Site Information.

Information from the State Soil Survey Database (3SD) will be used as the basis of this section. The 3SD contains current information on soils and their basic interpretations as tailored from the Soil Interpretations Records (SCS-SOI-5). Detailed interpretations of soils will be provided in Section II by state and area specialists.

Interpretations are specific to the soils identified and mapped in the area. Map units to which the

Subpart A - Policy and Responsibilities

401.03(b)(2)(iii)(A)

interpretations apply are clearly identified by name, symbol(s), or both. New map unit names and symbols resulting from reclassification of soils are cross-referenced to old names and symbols and shown on a list.

Soils are to be described and interpreted to help make decisions about use and management of land. Soil characteristics that limit or affect land use and management are to be identified, and soils are to be rated according to limitations, capability, suitability, and/or potential.

This information may be available in published soil surveys or in the State Soil Survey Database (3SD). A copy of the appropriate sections of soil surveys can be included in the applicable subsections, or reference can be made to the source document maintained in the field office.

The following are subsections of Section II of the FOTG.

(i) Soils legend. This list includes the names of the soil map units and, for each unit, the identification of interpretive groups (if any) of importance in the field office. For map units having two or more soils in their name, interpretive groups are identified for each soil. Where appropriate, the map unit is placed in a group that generally controls the use and management of the area.

If soil surveys of more than one vintage are used, the symbols used in each are to be identified along with appropriate interpretive groups. For remapped areas, only the legend for the most recent mapping is to be used.

(ii) Soil descriptions.

(A) Nontechnical soil descriptions for use with individuals, groups, and units of government are included. Brief references to major limitations e.g., erosion or wetness, and soil potential are a part of each description. Basic information needed to develop these descriptions is in the soil map unit descriptions and in the State Soil Survey Database (3SD).

(B) Technical descriptions of each soil series and of each soil map unit are provided in this section or available in the field office. If such descriptions are maintained as separate material, the source document should be listed here as a reference.

(iii) Detailed soil interpretations. These will be supplied by appropriate technical specialists for all land uses in the field office area. Examples follow:

(A) Cropland interpretations. These include soil interpretive information needed for plant adaptations, yield estimates, and the lists of soil map units that meet the soil requirements for prime farmland and highly erodible land. Interpretations are presented by land capability units, erodibility index, and soil map units in narrative or tabular form as appropriate. Where land capability unit or erodibility index is used, a list of all soil map units in each capability unit or erodibility index is included.

Part 401-Technical Guides

401.03(b)(2)(iii)(B)

(B) Rangeland, grazed forest land, and native pasture interpretations. The required content of range and native pasture interpretive groupings is outlined in the National Range Handbook. All soils used as rangeland are to be placed in appropriate range sites. Range site descriptions and condition guides for rangeland are included. Grazed forest land and native pasture groupings include references to individual soils, grazing groups, or woodland suitability groups. Interpretations may be presented by individual soil map units or by groups of soil map units.

(C) Forest land interpretations. These are presented by individual soils or by woodland suitability groups (WSG). These interpretations include the woodland class symbol that denotes potential productivity for the indicator species in wood per cubic meters per hectare. Site index and annual productivity estimates in cubic feet per acre, board feet per acre, and/or cords per acre may also be provided for important tree species. The subclass indicates the primary soil or physiographic characteristic that contributes to important hazards or limitations in management. Site index information is also provided for important tree species.

(D) Nonagricultural interpretations. Nonagricultural uses include commercial development, subdivision development, industrial related development, roads and other transportation and transmission systems, and other land uses important to the area.

(E) Recreation interpretations. These include the ratings of soils for recreation uses.

(F) Wildlife interpretations. These are presented by wildlife habitat elements with descriptions of each element.

(G) Pastureland and hayland interpretations. These are arranged by pastureland and hayland suitability groups, capability units, other groupings, or soil map units.

(H) Mined land interpretations. These include interpretations which dictate the limitation to reclamation, revegetation, and maintenance for the different types of mined land.

(I) Windbreak interpretations. These interpretations are made by individual soils or by windbreak suitability groups (WISG). Interpretations provided by the WISG include the soil-adapted species recommended, the predicted height growth in 20 years, and the soil-related limitations.

(J) Engineering interpretations. These include engineering properties, indices, and soil interpretations for engineering uses and practices.

(K) Waste disposal interpretations. These are interpretations related to the suitability of soils for disposal of organic and inorganic wastes.

(L) Water quality and quantity interpretations. These are interpretations related to soil properties affecting water quantity and quality problems and treatments. Included are soil-pesticide interactive ratings and soil ratings for nitrates and soluble nutrients.

Subpart A - Policy and Responsibilities

401.03(b)(3)(iii)(A)[1]

(M) Hydric soils interpretations. These are interpretations related to the identification and use of wetlands.

(3) Section III - Conservation Management Systems.

The function of SCS is to provide technical assistance to decisionmakers to protect, maintain, and improve soil, water, air, and related plant and animal resources. This section provides guidance for developing resource management systems (RMS) and acceptable management systems (AMS) for a resource area to prevent or treat problems and take advantage of opportunities associated with these resources. This section includes a description of considerations important in conservation planning of soil, water, air, and related plant and animal resources.

(i) An RMS achieves the goal of preventing resource degradation and permitting sustainable use as stated in 401.00 (b). An RMS is achieved if criteria for soil, water, air, and related plant and animal resources are met as defined in Section 401.03(b)(3)(iv). This section describes either national criteria or considerations that must be addressed in developing state criteria for achieving an RMS that solve identified onsite and offsite resource problems using best available technology. The concept and use of RMS is defined in the SCS National Planning Manual (NPM). RMS are not to be confused with "conservation systems," as defined in 7 CFR Section 12.2 for treatment of highly erodible land. A conservation system for Food Security Act purposes is an erosion reduction component of an RMS for cropland.

(ii) SCS helps decisionmakers plan and apply conservation management systems to prevent and/or solve identified onsite and offsite resource problems or conditions and to achieve the decisionmaker's and public objectives. SCS identifies and documents decisionmaker's objectives, consistent with land capability and sound environmental principles, as part of element 3 (Determining objectives) of the planning process (reference: National Planning Manual). SCS identifies and documents resource problems or conditions as part of element 4 (Providing resource inventory data) of the planning process. As part of element 6 (Developing and evaluating conservation alternatives), information on conservation effects is used to provide suitable options for addressing the decisionmaker's and public objectives.

(iii) The five resources are soil, water, air, plants, and animals. Each resource has several considerations important in conservation planning. Additional considerations in a specific state may need to be added to account for wide variations in soils, climate, or topography. A description of the main considerations for each resource follows:

(A) Soil. Considerations for the soil resource are erosion, condition, and deposition.

[1] Erosion. This consideration deals with one or more of the following types or locations of erosion: sheet and rill, wind, concentrated flow (ephemeral gully and classic gully), streambank, soil mass movement (land slips or slides), road bank, construction site, and irrigation-induced. All of these forms of erosion that are identified on the site to be planned need to be dealt with in developing treatment options.

Part 401-Technical Guides

401.03(b)(3)(iii)(A)[1]

[2] Condition. This consideration deals with the chemical and physical characteristics of soil as related to its ease of tillage, fitness as a seedbed, and ability to absorb, store, and release water and nutrients for plants. Aspects of this consideration will improve soil tilth, which reduces soil crusting and compacting; optimize water infiltration; optimize soil organic material; enhance beneficial soil organisms and biological activity; reduce subsidence; and minimize effects of excess natural and applied chemicals and elements such as salt, selenium, boron, and heavy metals. This consideration also deals with the proper and safe land application and utilization of animal wastes, other organics, nutrients, and pesticides.

[3] Deposition. This consideration deals with onsite or offsite deposition of products of erosion, which includes sediment causing damages to land, crops, and property, such as structures and machinery. This consideration also deals with safety hazards and decreased long-term productivity.

(B) Water. Considerations for the water resource are quantity and quality.

[1] Quantity includes:

- proper disposal of water from overland flows or seeps, both natural and man-made;
- management of water accumulations on soil surfaces or in soil profiles and vadose zones;
- optimization of irrigation and precipitation water use;
- dealing with other problems relating to irrigation — water mounding, water supply and distribution, increasing or decreasing water tables;
- management of deep percolation, runoff, and evaporation;
- water storage;
- management of water for wetland protection; and
- sediment deposition in lakes, ponds, streams and reservoirs, and restricted water conveyance capacity.

[2] Quality includes:

- reducing the effects of salinity and sodicity;
- minimizing deep percolation of contaminated water which will lead to unacceptable levels of pollutants in the underlying ground water;
- maintaining acceptable water quality;
- minimizing offsite effects including ground water contamination by pesticides, nutrients, salts, organics, metals and other inorganics, and pathogens; contamination of surface water (streams and lakes) by sediment, pesticides, nutrients, salts, organics, metals and other inorganics; pathogens; fecal coliform; and high temperature;
- reducing the quantity of sediment;
- improving the quality of sediment;
- ensuring that all waters will be free from substances attributable to man-caused nonpoint source discharges in concentrations that:
 - *settle to form objectionable deposits;
 - *float as debris, scum, oil or other matter to form nuisances;

Subpart A - Policy and Responsibilities

401.03(b)(3)(iv)(A)

- *produce objectionable color, odor, taste, or turbidity;
- *injure, are toxic to, or produce adverse physiological or behavior responses in humans, animals, or plants; or
- *produce undesirable aquatic life or result in the dominance of nuisance species.

(C) Air. This resource deals with onsite and offsite airborne effects of undesirable odors, windblown particulates, chemical drift, temperature, and wind.

(D) Plants. The considerations for the plant resource are suitability, condition, and management.

[1] Suitability includes:

- plant adaptation to site; and
- plant suitability for intended use.

[2] Condition includes:

- productivity, kinds, amounts, and distribution of plants; and
- health and vigor of plants.

[3] Management includes:

- establishment, growth, and harvest (including grazing) of plants;
- agricultural chemical management (pesticides and nutrients); and
- pest management (brush, weeds, insects, and diseases).

(E) Animals. This includes wild and domestic animals, both terrestrial and aquatic. The considerations for the animal resource are habitat and management.

[1] Habitat includes:

- food;
- cover or shelter; and
- water.

[2] Management includes:

- population and resource balance; and
- animal health.

(iv) Criteria for treatment required to achieve an RMS will be established by SCS. They are to be stated in either qualitative or quantitative terms for each resource consideration. Where national criteria have not been established, the state conservationist will establish criteria with concurrence by the NTC. Where state and/or local regulations establish more restrictive criteria, these must be used in developing criteria for state and local programs. For example, some state and/or local regulations have established criteria for offsite control of water quality.

(A) Soil. Following are the criteria for this resource:

Part 401-Technical Guides

401.03(b)(3)(iv)(A)[1]

[1] Erosion.

- Estimated sheet and rill or wind erosion rates are reduced to the level that long term soil degradation is prevented and a high level of crop productivity can be sustained economically and indefinitely.
- Erosion from ephemeral or similar gullies is reduced to a level which permits efficient farming operations and sustains long term productivity.
- Irrigation-induced erosion is reduced to a level that sustains long term productivity.
- Other forms of erosion, such as classic gullies, streambank, roadbank, and landslides, that are identified as needing treatment (and are within the ability of the decisionmaker to treat), are reduced to the degree necessary to protect the resources or threatened man-made improvements.

[2] Condition.

- Soil tilth is maintained or improved;
- Crop production practices return adequate residue within the rotation cycle;
- Soil compaction by machinery, livestock, or other traffic is minimized;
- Water infiltration is optimized so as not to increase sheet and rill erosion;
- Wind forces and soil blowing are controlled below the crop tolerance level of young seedlings;
- Toxic chemicals affecting soil and plants are controlled to levels sufficient to prevent soil degradation and are below the tolerance of adapted crops;
- Application and utilization of animal wastes and other organics are at a rate that the soil, soil microbes and bacteria, and the plant community can assimilate, degrade, or retain the various materials.

[3] Deposition.

- Where existing or potential onsite or offsite deposition problem(s) are identified, the practices applied to the contributing land resolve the identified deposition problem(s).
- State and/or local governments may establish criteria in response to identified deposition problems. These criteria will be used to determine the adequacy of an RMS with regard to offsite effects. This may require the establishment of more

Subpart A - Policy and Responsibilities

401.03(b)(3)(iv)(B)[2]

restrictive criteria for one or more of the resources to alleviate the problem. Local public perception of an acceptable level could be used where no standards have been established.

- When disposal of animal wastes and other organics is needed, it shall be done in a manner that maintains or enhances the natural resources.

(B) Water. In developing criteria for this resource, the state conservationist is to address:

[1] Quantity.

- Overland flows and subsurface water conveyed by conservation practices are safely conducted and disposed of through acceptable outlets.
- Water system discharges going from one ownership to another ownership are not changed from natural flow pathways unless needed land and/or water rights have been obtained consistent with local, state, and Federal regulations.
- Water quality aspects associated with outlets are accounted for.
- Appropriate water storage requirements are in accordance with the needs of the planned use.
- Drainage activities are consistent with SCS policy regarding wetland protection.
- For irrigated land, a minimum percentage level of efficiency is achieved or exceeded for each type of irrigation system and management, as stated in the SCS state irrigation guide.
- For land under supplemental irrigation where adequate water supplies exist, or for land under partial irrigation because of water deficiency or lack of seasonal availability or frequency of availability of water, water is applied in the most effective manner, so that the infiltration rate of the soil, the plant needs, and the soil water-holding capacity are not exceeded.
- Vegetation, cropping sequences, and cultural operations are managed for efficient use of precipitation by minimizing water losses to runoff and evaporation, thereby inducing positive effects on the plant-soil moisture relationship, on ground water recharge, and on water yield downstream.

[2] Quality.

- Sediment movement is controlled to minimize contamination of receiving waters.

Part 401-Technical Guides

401.03(b)(3)(iv)(B)[2]

- Percolation below the root zone is managed to minimize contamination of the percolating water and to minimize the negative effects on production.
- Water used for salt leaching and plant temperature modification is applied to minimize adverse effects.
- Acceptable water temperature is maintained.
- Irrigation water and natural precipitation are managed to minimize the movement of nutrients, pesticides, sediment, salts, and animal wastes to offsite surface and ground water.
- Water-based uses, such as aquaculture enterprises and water-based recreation facilities maintain or improve environmental quality.
- Where surface or ground water nutrient and/or pesticide problems or potential problems exist, the selection of appropriate nutrients or pesticides and the timing, chemical forms, and rate and method of application reduce adverse effects. The use of pesticides and nutrients with high potential for polluting water are avoided where site limitations, such as slope, depth to ground water, soil, and material in the vadose zone or aquifer could allow that potential to be realized. Soil-pesticide interactive ratings to identify potential problem situations from surface runoff and/or leaching are used according to FOTG guidelines. Alternative practices or other pest control methods (mechanical, cultural, or biological) or integrated methods are recommended where site limitations exist that increase the probability of degrading water supplies, either below the surface or downstream.
- Agricultural chemical containers and chemicals (including waste oil, fuel, and detergents) are used, handled, and disposed of in compliance with Federal, state, and local laws.

(C) Air. Criteria established by the state conservationist are to address the following onsite and offsite considerations:

- Airborne particulates from agricultural sources do not cause safety, health, machinery, vehicular, or structure problems.
- Local and state regulations are followed in minimizing undesirable odors from agricultural sources.
- Air movement and temperatures are modified when necessary using appropriate vegetative or mechanical means.
- Chemical drift from the application of agricultural chemicals is controlled by adherence to local and state application recommendations and product labels.

Subpart A - Policy and Responsibilities

401.03(b)(3)(iv)(D)

(D) Plants. Criteria established by the state conservationist are to address the following considerations:

- Plants on all land uses are used, maintained and improved to achieve acceptable production levels to meet conservation, environmental, decisionmaker, and public objectives.
- Nutrient applications for any land use are based on plant nutrient requirements, production requirements, soil test recommendations, soil fertility, soil potential limitations, water budget, and the types of practices planned. Nutrients from all sources (animal waste, crop residue, soil residual, commercial fertilizer, atmospheric-fixed) are considered when calculating the amount of nutrients to apply. Timing, method, and rate of application, and chemical forms of nutrients to be applied are taken into consideration in planning practices.
- Pesticide applications for any land use are applied according to the label recommendation and federal, state, and local regulations.
- On Cropland, crops are grown in a planned sequence that meets conservation, production, and decisionmaker objectives; and weeds, insects, other pests, and diseases are adequately treated.
- On Hayland, dominant native or introduced plant species are appropriate for the forage, agronomic, or commercial use; well adapted to the site; and their stand density is maintained or improved.
- On Native Pasture, herbaceous plants are properly grazed, forage value rating is medium or better, vigor is strong and is commensurate with overstory canopy.
- On Pastureland, dominant plant species are appropriate for the use, adapted to the site, and their stand density is adequate and productivity is maintained or improved.
- On Rangeland, the plant community is managed to meet the needs of the plants and animals in a manner to conserve the natural resources and meet the objectives of the decisionmaker. As a general rule, rangeland in poor or fair ecological range condition is managed for an upward range trend, and rangeland in good or excellent ecological range condition will be managed for a static or upward range trend. In some special situations, poor or fair ecological range condition could be managed for a static range trend to meet special objectives of the decisionmaker as long as there is no degradation of the soil resource.
- On Forest Land, trees are well distributed, vigorous, relatively free of insects, disease, and other damage, and the density of the stand is within 25% of forest stand density guide spacing on a stems-per-acre basis for the particular forest types. Forest Land shall be protected from wildfires and erosion. Forest Land that is grazed shall

Part 401-Technical Guides

401.03(b)(3)(iv)(D)

also be managed to meet the needs of the forage plants, the animals, and the objectives of the decisionmaker.

- On Wildlife Land, Recreation Land, and Other Land, adapted or native plants are of sufficient quantity and quality to improve or protect the defined resource.
- On Urban Land uses, soil cover is maintained using suitable plants or other cover to keep soil erosion within acceptable limits, minimize runoff, and manage infiltration.

(E) Animals. Criteria established by the state conservationist are to address the following considerations:

- The adaptation, kinds, amounts, distribution, health, and vigor of livestock and wildlife are appropriate for the site.
- Adequate quality, quantity and distribution of food are provided for the species of concern.
- Adequate quantity, quality and distribution of wildlife cover for the species of concern are provided. Domestic animals are provided adequate shelter as needed.
- Adequate quantity, quality and distribution of water are provided for the species of concern.
- The decisionmaker's enterprise and the balance between forage production and livestock needs are appropriate.
- Domestic livestock are managed in a manner that meets the needs of the ecosystem, the animal, and that accomplishes the goals and objectives of the decisionmaker.
- Animal wastes and other organic wastes are managed according to an animal waste management plan developed according to SCS standards. Minimum quality criteria are met when the animal waste management plan is applied. Where surface and ground water problems exist from organic waste, bacteria, pathogens, microorganisms, or nutrients, special design considerations for each component will be necessary to eliminate further contamination of runoff or leachates.

(v) An AMS will be established for a resource area in the event that social, cultural, or economic characteristics of the area prevent the feasible achievement of an RMS. An AMS is achieved when soil, water, air, and related plant and animal criteria for the related resource use are established at the level which is achievable in view of the social, cultural, and economic characteristics of the resource area involved.

(A) Social, cultural, and economic considerations are used to establish the level of natural resource protection obtainable and may constrain the resource criteria used in formulating an

Subpart A - Policy and Responsibilities

401.03(b)(3)(vii)(A)

RMS. Criteria for treatment required to achieve an AMS will be established by SCS. They are to be stated in either qualitative or quantitative terms for each resource consideration. The state conservationist will establish criteria with concurrence by the NTC. Some of these criteria are prescribed by law or statute; e.g., the National Historic Preservation Act. Others are developed through an onsite assessment of social, cultural, and economic factors which define the reasonable and practical degree to which the resource criteria can be achieved. Where regional, state and/or local regulations establish more restrictive criteria, these must be used.

(B) The following criteria are applied to determine the practical limits of resource protection within a resource area and temper the resource criteria to be used in the formulation of an AMS.

(1) Social

- Public health is maintained or improved.
- Treatment level is compatible with community characteristics.
- Treatment level is compatible with clientele characteristics.

(2) Cultural

- Protection of cultural resources is consistent with GM 420, Part 401.

(3) Economic

- Treatment level reflects the ability to pay that is representative of the area.
- Inputs required for conservation treatment are readily available.
- Conservation treatment is consistent with government program participation.

(vi) Additional considerations useful in the planning process to screen or select suitable conservation treatments for individual decisionmakers may include legal, social, cultural, economic, aesthetic, management, and other factors. These are integral to the planning process and are discussed in the National Planning Manual and are displayed in Section V.

(vii) Applications of RMS and AMS Criteria

(A) Several factors may affect the actual level or degree of treatment achieved at a point in time or that is required to be achieved by the decisionmaker. Without legal constraints, the differing cultural, social or economic situation of a decisionmaker usually determines the degree of treatment planned or attained at any point in time. Where an RMS or AMS is not attainable during the present planning effort, the progressive planning approach in NPM 501.04 (d) may be used to ultimately achieve planning and application of an RMS or AMS. Progressive planning is the incremental process of building a plan on part or all of the planning unit consistent with the decisionmaker's ability to make decisions over a period of time. The progression on individual planning units is always toward the planning and implementation of an RMS.

Part 401-Technical Guides

401.03(b)(3)(vii)(B)

(B) Legislated programs usually have varying authorities and qualifying criteria that may require more or less treatment than RMS or AMS criteria. An example is legislated practices for improving water quality. In this case, the related program manual will establish the criteria to be achieved. These applications must be coordinated across county and state lines and should be for the period of time specified in the law or in the related policies and procedures.

(C) The opportunity for establishing an RMS to achieve the non-degradation and sustainable use goal should be evaluated when ownership, land use, or cropping system changes, or when new technology becomes available.

(D) Decisionmakers may desire to plan treatment in addition to that required to meet RMS or AMS criteria to enhance resource conditions or to serve secondary or tertiary uses or objectives. This additional treatment may include conservation practices or management that contribute to further improvement of water quality; increased production, drainage, or irrigation; enhancement of cultural and environmental values, wildlife habitat, or aesthetics; or improved health and safety.

(viii) RMS, AMS, or other guidance documents will be developed by major land use in the field office area and placed in Section III of each FOTG.

(A) Only enough guidance documents to show examples of the RMS and AMS options to treat the most common identified resource problems for each locally applicable major land use will be developed. NTC will provide specific examples of format for guidance to states in the preparation of guidance documents. Guidance documents are to be developed by states for each FOTG using the NTC format. Guidance documents are to have concurrence of the NTC. NTC directors are to coordinate formats across NTC boundaries.

(B) Guidance documents will present a reasonable number of alternative combinations of practices and management that will meet the criteria for solving resource problems common to that land use.

(C) In developing guidance documents, the effects that alternative practices and combinations of practices and management have on the five resources and on the social, economic, and cultural considerations are to be used. For each guidance document developed, a display of effects of the conservation system should be included in Section V. Guidance on the development and display of effects is provided in Section 401.03(b)(5).

(D) Guidance documents may need to be developed to meet specific program requirements, in which case they are to be clearly labeled to show the program(s) or provision(s) of law to which they apply. These guidance documents may describe management actions in addition to conservation practices that can be carried out to achieve these program purposes.

(ix) Conservation practices are to be installed according to SCS practice standards and specifications. Practice standards and specifications are the same for both RMS and AMS.

Subpart A - Policy and Responsibilities

401.03(b)(5)(ii)

(4) Section IV - Practice Standards and Specifications

- (i) This section of FOTG contains conservation practice standards and specifications.
- (ii) The first item of Section IV is an alphabetical list of conservation practices used by the field office, followed by the practice standards and specifications in the same order. This list will include the date of preparation or revision of each standard, supplement, specification, and interim standard in effect. This list will also show the date of the last review. This list will be revised and reissued each time a change is made in a conservation practice standard, supplement, or specification. See section 401.01(c)(2)(vii).
- (iii) Practice standards establish the minimum level of acceptable quality for planning, designing, installing, operating, and maintaining conservation practices. Standards from the National Handbook of Conservation Practices (NHCP) and interim standards are to be used, and will be supplemented by states as needed.
- (iv) Practice specifications describe requirements necessary to install a conservation practice so that it functions properly. For most practices in the NHCP, it is necessary to prepare state specifications to fit local soil and climatic conditions. Specifications include some or all of the following: major elements of work to be done; kind, quality, and quantity of materials to be used; essential details of installation; and other technical instructions necessary for installing and maintaining the practice.
- (v) See **Part 401 - Subpart B** for policy and procedural details for standards and specifications.

(5) Section V - Conservation Effects

- (i) The purpose of this section is twofold:
 - (A) The first purpose is to provide a repository of data on the effects of conservation activities. Such data are an important part of technical reference material used by SCS and decisionmakers in planning conservation actions. SCS determines the effects of conservation treatments in order to help formulate and facilitate the identification of suitable conservation management systems to protect the resource base and to address the decisionmaker's and society's social, cultural, and economic objectives. The concept of using conservation effects in the decisionmaking process (CED) is elaborated in the National Planning Manual.
 - (B) The second purpose of this section is to serve as a source of appropriate procedures and methods for collecting, analyzing, and displaying conservation effects data.
- (ii) Conservation effects information will typically include the resource setting (i.e., soil, slope, etc.), the specific conservation treatments applied, the kinds, amounts, and timing of actions undertaken by decisionmakers in their operations, and the expected outcome in terms of solving resource problems and meeting social, cultural, and economic objectives.

Part 401-Technical Guides

401.03(b)(5)(ii)(A)

(A) Effects of conservation may be expressed in either narrative or quantitative terms that represent factual data on experienced or expected results of the specified conservation treatment as applied to the resource setting. Effects of conservation will normally be expressed as a condition or stage of the factors associated with a specified conservation action. For example, typical effects could be: a corn yield of 110 bushels per acre; a USLE erosion rate of 4 tons per acre; irrigation efficiency of 60%; or “a significant reduction in ephemeral gully erosion will occur with this treatment.” “Impacts” is a closely related term. An impact is a measure of the change between the stage or condition of one treatment alternative to another. Guidance on the use of effects information in the conservation planning process is contained in the National Planning Manual.

(B) To the extent possible, conservation effects information will include conservation treatments on the five resources and their considerations as described in Section III above.

[1] Examples of effects of conservation treatment on the five resources include but are not limited to:

- Expected effect on sheet and rill, wind, or ephemeral gully erosion.
- Indicators or measures of soil conditions, such as tilth, compaction, and infiltration.
- Where applicable, indicators of soil deposition.
- Measures or indicators of effects on quality and quantity of surface or subsurface waters, such as chemical runoff as influenced by the conservation system.
- Effects on plant conditions and management, such as expected status of range conditions with the indicated range conservation actions.
- Measures of conservation effects on wild and domestic animals, including animal waste uses and effects on the resource base.
- Indicators of effects on air, such as airborne particulates, odors, and chemical drift.

[2] Effects information will also include management, social, cultural, and economic information. Factors such as cost, client acceptability, and physical changes to cultural resource sites associated with the specific conservation treatment component are to be identified. Included, for example, would be:

- Tillage requirements, labor inputs, quantity and costs of inputs, net economic returns, experienced yields, risk management requirements, operation and maintenance requirements, time requirements, cultural resources (archaeological and historic properties), length of life of practices, health and safety, aesthetics, and community effects.

Subpart A - Policy and Responsibilities

401.03(b)(5)(iv)(B)

(C) Information developed on conservation effects will vary significantly in scope and detail depending on the resource conditions in the local area as well as upon the needs for technical reference materials to carry out conservation activities in that location.

(iii) Section V of the FOTG should contain summaries of effects data relevant to the field office area. As a minimum, Section V should contain a display of the important effects for decisionmaking for each of the RMS and AMS developed and inserted in Section III. The display should be cross referenced with cropping system, soil map units, and other descriptions of the resource setting and conditions (e.g., precipitation, slope, etc.) that the RMS or AMS was formulated to address in that field office. The format of the display should be easily understandable so as to make the information valuable as ready reference material for the conservation planner and decisionmaker to facilitate *planning and decisionmaking*. The display will show the degree of resource protection achieved.

(A) Options may be evaluated by simply comparing the differences in the effects of the options.

(B) NTC will provide specific examples of format guidance to states for recording and displaying conservation effects data.

(C) Collection of data on conservation effects is a long term effort to be undertaken as part of the followup element in the planning process. Initial efforts may provide effect information for only the most common situations. Over time, additional resource situations and treatment alternatives will be examined to add depth and breadth to the available conservation effect information.

(D) Information on conservation effects may be refined or updated over time as needed in the local area. The data on conservation effects should be useful to field office personnel in identifying suitable conservation treatment applicable to the area, and serves as technical reference materials when working with decisionmakers in the conservation planning process. (See National Planning Manual Section 508.01).

(iv) Data on conservation effects may be developed by following two general approaches:

(A) The observation and documentation of the experiences of cooperators. Typically, conservationists will make observations of conservation treatments applied by one or more decisionmakers in the first or second year following the application and record the effects experienced. This data can be recorded in conservation field notes and be entered into CAMPS databases. Effects information may also be available from conservation field trials, university research plots, or other trials in the area.

(B) Models of processes impacted by conservation actions can be used to simulate the physical, agronomic, or other effects of treatment systems. Actual results or graphs summarizing results could be developed by state staffs and provided to field offices for inclusion in FOTG. Appropriate models or references to the appropriate models may be stored in FOTG Section V to facilitate use in collecting and analyzing conservation effects data.

Part 401-Technical Guides

401.03(b)(5)(v)

(v) Data relating effects of conservation practices on the five resources may be displayed in tabular, narrative, or matrix form. This will be useful in developing RMS or AMS for inclusion in FOTG Section III.

SUBPART B — NATIONAL HANDBOOK OF CONSERVATION PRACTICES

401.10 Purpose.

401.12

This subpart sets forth SCS policy for establishing and maintaining a National Handbook of Conservation Practices (NHCP). It also includes directions for variances, changes, interim standards, and adaptations of standards to state and local conditions.

401.11 Content.

(a) The NHCP establishes a national standard for each conservation practice, including:

- (1) The official name, definition, code identity, and unit of measurement for the practice;
- (2) A concise statement of the scope, purposes (including secondary purposes), conditions where the practice applies, and planning considerations for the practice; and
- (3) Criteria for the practice.

(b) For some conservation practices, the NHCP also establishes items for inclusion in state-developed specifications.

(c) The NHCP contains an index of national standards, including:

- (1) The practice name and unit.
- (2) The SCS technical discipline leader responsible for each practice.
- (3) The date of the current standard.
- (4) The code number of the standard.

401.12 National Conservation Practice Standards Subcommittee (NCPSS) of National Technical Guide Committee (NTGC).

The National Conservation Practice Standards Subcommittee (NCPSS) of NTGC coordinates and updates the NHCP. The NTGC designates subcommittee members and acts on recommendations from NCPSS.

Part 401-Technical Guides

401.13(a)(1)

401.13 Practice standards and specifications.

(a) Practice standards establish the minimum level of acceptable quality of planning, designing, installing, operating and maintaining conservation practices.

(1) NHCP standards are to be used directly within a state, or state supplements can be added as necessary. Because of wide variations in soils, climate, and topography, state conservationists may need to add special provisions or provide more detail in the standards. State laws and local ordinances or regulations may dictate more stringent criteria.

(2) The official practice name, definition, code identity, and unit of measurement are established nationally and are not to be changed. Generally, the statement of scope, purpose, and conditions where a practice applies can be used directly.

(b) Practice specifications establish the technical details and workmanship for the various operations required to install the practice and the quality and extent of the materials to be used.

(1) Specifications enumerate items that apply when adapting the standard to site specific locations, such as considerations of site preparation and protection; instructions for use of materials described in the standard; or guidance for performing installation operations not directly addressed in the standard. Statements in the specifications are not to conflict with the requirements of the standard.

(2) Items to be included in state-developed specifications for a limited number of conservation practices are contained in the NHCP. Specifications for practices are to be developed by states or NTCs and are to consider the wide variations in soils, climate, and topography present in the various states. State developed specifications must be approved by the appropriate discipline specialist and the state conservationist. Specifications are to meet the requirements of state laws and local ordinances or regulations.

(c) National Technical Centers (NTCs) review and concur in supplements to NHCP standards and specifications prepared by a state for use within that state to ensure conformance with NHCP and consistency among states.

401.14 Variances.

Only the directors of the Engineering and/or Ecological Sciences Divisions can approve variances from requirements stated in the NHCP except that approval authority for variations in channel stability requirements has been delegated to the heads of engineering staffs at the NTC (see NEM 210 Section 501.32). Any other request for a variance is to be submitted to the NTGC and is to include recommendations of the appropriate NTC Director. The NTGC will refer the request to the appropriate division for action. Variances, when granted, are for a specific period of time or until the practice standard to which they pertain is revised, whichever is shorter. Variances will include any requirements for monitoring, evaluation, and reporting needed to determine whether or not changes in practice standards are necessary.

401.15 Changes in the National Handbook of Conservation Practices (NHCP).

(a) The NTGC will consider and recommend proposed changes in the NHCP to the Deputy Chief for Technology. Changes will be made by numbered handbook notices issued by the Deputy Chief for Technology.

(b) Each NHCP standard is to be formally reviewed by the NCPSS at least once every five years from the date of issuance or revision to determine if the standard is needed and up-to-date. If revisions are needed, the revised standard will establish the current minimum level of acceptable quality for planning, designing, installing, operating, and maintaining conservation practices.

(c) The NTC reviews all state proposed changes to NHCP and sends recommendations for approval or disapproval to NTGC. Review and approval of technical content of proposed changes is to be made by the Director, Engineering Division, or the Director, Ecological Sciences Division. Review and approval of format with respect to inclusion of items listed in Section 401.11 are to be performed by NTGC.

401.16 Interim standards.

(a) Interim standards are prepared by states or NTC to address problems for which there is no existing standard.

(b) Interim standards are to be approved by the NTC Director.

(c) Interim standards are to be issued for a period not to exceed 3 years. The NTC director can extend the period for further evaluation at the end of this period, and after an analysis of practice performance using the interim standard.

Part 401-Technical Guides

401.16(d)

(d) Interim standards will be evaluated by NTC Technical Guide Committees at the end of the 3-year period and, if appropriate, recommendations made to the NTGC for inclusion in the National Handbook of Conservation Practices.

(e) The notice of approval of each interim standard will provide instructions to states regarding evaluation of practice performance.

(f) NTC directors are to send information copies of all interim standards and evaluation reports to NTGC.

Appendix 2B

**List of References for Nonpoint Source Database -
Pennsylvania State University**

Articles Entered into NPSDB Listed in Order by SAN

Current as of 05/27/92

SAN	Applic. Class	First Authors	Article Title
2	Confined Livestock	Dickey, E.C.	Performance and Design of Vegetable Filters for Feedlot Runoff Treatment, Livestock Waste, A Renewable Resource
3	Confined Livestock		Livestock in Confinement - Section 10.0
10	Confined Livestock Manure Spreading	Westerman, P.W., et al.	Swine Manure and Lagoon Effluent Applied to a Temperate Forage Mixture: II Rainfall Runoff and Soil Chemical Properties, Journal of Environmental Quality, Vol. 16, No. 2, 1987
13	Conf. Livstk Manure Spreading.	Quisenberry, V.L., et al.	Management Aspects of Applying Poultry or Dairy Manures to Grassland in the Piedmont Region, Livestock Waste, A Renewable Resource
15	Manure Spreading	Doyle, R.C., et al	Effectiveness of Forest Buffer Strip in Improving the Water Quality of Manure Polluted Runoff
16	Manure Spreading	Mueller, D.H., et al.	Phosphorus Losses as Affected by Tillage and Manure Application, Soil Science Society Journal, Vol. 48, 1984
21	Manure Spreading	Gerhart, James M.,	Ground Water Recharge and Its Effects on Nitrate Concentration Beneath a Manured Field Site in Pennsylvania, Ground Water, Vol. 24, No. 4, 1986
22	Manure Spreading	Hubbard, R.K., et al.	Surface Runoff and Shallow Ground Water Quality as Affects by Center Pivot Applied Dairy Cattle Wastes, Transactions of the ASAE, 1987
23	Manure Spreading	Watters, S.P.	Water Quality Impacts on Animal Waste Application in a Northeastern Oklahoma Watershed
25	Manure Spreading	Clausen, John C.	Water Quality Achievable with Agricultural Best Management Practices, Journal of Soil and Water Conservation, 1989
26	Manure Spreading	Deiyman, Marcia M., Saied Mostaghimi	A Model for Evaluating the Impact of Land Application of Organic Wastes on Runoff Water Quality, Research Journal of the Water Pollution Control Federation, 1991
30	Cropland Erosion	Naderman, George C.	Surface Water Management for Crop Production on Highly Erodible Land
32	Cropland Erosion		Impact of Land Treatment on the Restoration of Skinner Lake Noble County Indiana

34	Cropland Erosion	McGregor, K.C., et al.	Effects of Tillage with Different Crop Residues on Runoff and Soil Loss
36	Cropland Erosion	Spomer, R.G. (duplicate)	Concentrated Flow Erosion on Conventional and Conservation Tilled Watershed
41	Cropland Erosion	Smith, S.J.	Water Quality Impacts Associated with Wheat Culture in the Southern Plains Journal of Environmental Quality, Vol. 20, No. 1, 1991
42	Cropland Erosion	Rayavian, Daryoush	Hydrologic Responses of an Agricultural Watershed to Various Hydrologic and Management Conditions
45	Cropland Erosion	Baldwin, P.L., et al.	Effects of Tillage on Quality of Runoff Water
46	Cropland Erosion	Mutchler, C.K., et al.	Erosion from Reduced-Till Cotton
51	Cropland Erosion	Unger, P.W.	Conservation Tillage Systems
53	Cropland Erosion	Mostaghimi, S., et al.	Influence of Tillage Systems and Residue Levels on Runoff, Sediment and Phosphorus Losses Transactions of the ASAE, Vol. 31, No. 1, 1988
54	Cropland Erosion	McDowell, L. L.	Nitrogen and Phosphorus Losses in Runoff from No-Till Soybeans
56	Cropland Erosion	Meek, B.D.	Infiltration Rate as Affected by an Alfalfa and No-Till Cotton Cropping System
58	Cropland Erosion	Cogo, N.P.	Soil Loss Reductions from Conservation Tillage Practices
59	Cropland Erosion	Zhu, J.C.	Runoff Soil and Dissolved Nutrients Losses from No-Till Soybeans with Winter Cover Crops
60	Cropland Erosion	Berg, W.A.	Management Effects on Runoff, Soil and Nutrient Losses from Highly Erodible Soils in the Southern Plains
62	Cropland Erosion	Dick, W.A., et al.	Surface Hydrologic Response of Soils to No-Till
63	Cropland Erosion	Beasley, D.B., et al.	Using Simulation to Assess the Impacts of Conservation Tillage on Movement of Sediment and Phosphorus into Lake Erie, Winter Meeting of the ASAE, 1986
64	Cropland Erosion	Baker, J.L.	Water Quality Consequences of Conservation Tillage
67	Confined Livestock	Lorimor, J.C., et al.	Nitrate Concentration in Groundwater Beneath a Beef Cattle Feedlot Water Resource Bulletin, Vol. 8, No. 5, 1972
68	Cropland Erosion	Rousseau, A., et al.	Evaluation of Best Management Practices to Control Phosphorus Nonpoint Source Pollution
69	Cropland Erosion	Scott, R., Alfredo B. Granillo	Sediment and Water Yields from Managed Forests on Flat Coastal Plain Sites

70	Cropland Erosion	Landale, G.W.	Conservation Practice Effects on Phosphorus Losses from Southern Piedmont Watersheds, Journal of Soil and Water Conservation, 1985
84	Cropland Erosion	Dillaha, T.A., et al.	Vegetative Filter Strips for Agricultural Nonpoint Source Pollution Control, Transactions of the ASAE, Vol. 32, No. 2, 1989
93	Nutrient Management	Gold, Arthur J., et al.	Runoff Water Quality from Conservation and Conventional Tillage
94	Nutrient Management	Staver, K. Set al.	Nitrogen Export from Atlantic Coastal Plain Soils, International Summer Meeting of the ASAE, 1988
96	Nutrient Management	Baker, J.L. et al	Effect of Tillage on Infiltration and Anion Leaching, Winter Meeting of the ASAE, 1986
98	Nutrient Management	Mueller, D.H., et al.	Effect of Conservation Tillage on Runoff Water Quality: Total, Dissolved and Algal-Available Phosphorus Losses, Winter Meeting of the ASAE, 1983
100	Nutrient Management	Alberts, E.E., R.G. Spomer	Dissolved Nitrogen and Phosphorus in Runoff from Watersheds in Conservation and Conventional Tillage, Journal of Soil and Water Conservaun, 1985
106	Nutrient Management	Angle, J.S., et al.	Nutrient Losses in Runoff from Conventuonal and No-Till Corn Watersheds, Journal of Environmental Quality, Vol. 13, No. 3
107	Nutrient Management	Mostaghimi, Saied, et al.	Phosphorus Losses from Cropland as Affected by Tillage System and Fertilizer Application Method, Water Resources Bulletin, Vol. 24, No. 4, 1988
110	Nutrient Management	Kanwar, R.S., et al.	Tillage and N-Fertilizer Management Effects on Groundwater Quality, Summer Meeting of the ASAE, 1987
167	Cropland Erosion	Edwards, W.M., et al.	Contribution of Macroporosity to Infiltration into a Continuous Corn No-Till Watershed: Implications for Contaminant Movement
183	Cropland Erosion	Deizman, M.M., et al.	Size Distribution of Eroded Sediment from Two Tillage Systems
184	Cropland Erosion	Khan, M.J., et al.	Mulch Cover and Canopy Effect of Soil Loss
185	Cropland Erosion	McGregor, K.C., et al.	Effect of Incorporating Straw Residues on Interrill Soil Erosion
212	Cropland Erosion	Mostaghimi, S., T.A. Dillaha, V.O. Shanholtz	Runoff, Sediment and Phosphorus Losses from Agricultural Lands as Affected by Tillage and Residue Levels

221	Cropland Erosion	Logan, Terry J.	Overview of Conservation Tillage, from Effects of Conservation Tillage on Groundwater Quality Nitrates and Pesticides -
226	Conf. Lvstk.	Texas Tech Univ.	Characteristics of Water from Southeastern Cattle Feedlots
235	Confined Livestock		Livestock Waste Management with Pollution Control North Central Regional Research Publication 222, June 1975
236	Manure Spreading	Gilbertson, C.B., et al.	Animal Waste Utilization on Cropland and Pastureland A Manual for Evaluating Agronomic and Environmental Effects, USDA, USEPA; EPA-600/2-79-059, 1979
238	Manure Spreading	Klausner, S.D., et al.	Nitrogen and Phosphorus Losses from Winter Disposal of Dairy Manure Journal of Environmental Quality, V. 5, No. 1, 1976
239	Manure Spreading	Fleming, R.J.	Impact of Agricultural Practices on Tile Water Quality ASAE Summer Meeting, 1990
240	Confined Livestock	Elliot, L.F., et al.	Ammonia, Nitrate, and Total Nitrogen in the Soil Water of Feedlot and Field Soil Profiles Applied Microbiology, April 1972, V. 28, No. 9
242	Confined Livestock	Coote, D.R. F.R. Hore	Runoff from Feedlots and Manure Storage in Southern Ohio Canadian Agricultural Engineering, V. 19, No. 2 1977
243	Confined Livestock	Gilbertson, C.B., et al.	Physical and Chemical Properties of Outdoor Beef Cattle Feedlot Runoff,
245	Confined Livestock	Westerman, Philip W., Michael R. Overcash	Dairy Open Lot and Lagoon Irrigation Pasture Runoff Quantity and Quality Transactions of the ASAE, Vol. 23, No. 5, 1980
246	Manure Spreading	Phillips, P.A., et al.	Pollution Potential and Corn Yields from Selected Rates and Timing of Liquid Manure Application 1979 Summer Meeting of ASAE and CSAE
248	Manure Spreading Confined Livestock	Adam, Real, et al.	Evaluation of Beef Feedlot Runoff Treatment by a Vegetative Filter Strip ASAE North Atlantic Regional Meeting, 1986
249	Confined Livestock Manure Spreading	Evans, R.O., et al.	Drainage Water Quality from Land Application of Swine Lagoon Effluent ASAE Summer Meeting, 1981
250	Manure Spreading	Mueller, D.H., et al.	Soil and Water Loss as Affected by Tillage and Manure Application Soil Science Society of America Journal, Vol 48, 1984

252	Manure Spreading	Long, F.L., et al.	Effects of Soil Incorporated Dairy Cattle Manure on Runoff Water Quality and Soil Properties Journal of Environmental Quality, Vol. 4, No. 2, 1975
253	Confined Livestock	Koelliker, J.K., et al.	Performance of Feedlot Runoff Control Facilities in Kansas ASAE Summer Meeting, 1974
254	Confined Livestock	Larson, C.L., et al.	Performance of Feedlot Runoff Control Systems in Minnesota ASAE Summer Meeting, 1974
255	Manure Spreading	Mather, A.C., et al.	Manure Effect on Water Intake and Runoff Quality from Irrigated Grain Sorghum Plots Soil Science Society of America Journal, Vol. 41, 1977
257	Manure Spreading	Walter, Jack N.	Phosphate and Nitrate Removal by a Grass Filtration System for Final Treatment of Municipal Waste M.S. Thesis, Agricultural Engineering Dept, The Pennsylvania State University, 1974
258	Manure Spreading	Converse, J.C., et al.	Nutrient Losses in Surface Runoff from Winter Spread Manure Transactions of the ASAE, 1976
259	Manure Spreading Confined Livestock	Thompson, D.B., et al.	Winter and Spring Runoff from Manure Application Plots ASAE Summer Meeting, 1978
260	Manure Spreading	McCaskey, T.A.	Water Quality of Runoff from Grassland Applied with Liquid, Semi Liquid, and Dry Dairy Waste Livestock Waste Management, 1971
261	Manure Spreading	Steenhuis, T., et al.	Winter Spread Manure Nitrogen Loss ASAE Summer Meeting, 1979
262	Manure Spreading	Keeney, D.R., L.W. Walsh	Sources and Fate of Available Nitrogen in Rural Ecosystems
263	Manure Spreading	Westerman, P.W., et al.	Erosion of Soil and Manure After Surface Application of Manure North Carolina Agricultural Research Service, 1980
264	Irrigation	Stewart, B.A., et al.	Yield and Water Use Efficiency of Grain Sorghum in a Limited Irrigation Dairyland Farming System Agronomy Journal, 1983
266	Irrigation	Michelson, R.H., et al.	Till-Plant Systems for Reducing Runoff under Low-Pressure, Center Pivot Irrigation Journal of Soil and Water Conservation, 1987
268	Irrigation	DeBoer, D.W., et al.	Primary and Secondary Tillage for Surface Runoff Control Under Sprinkler Irrigation ASAE, 1987

292	Irrigation	King, J. Phillip, Julie Wright	Interim Report: Irrigation Water Management Systems, Draft, November 15, 1991 Department of Civil, Agricultural and Geological Engineering, New Mexico State University Prepared for USEPA, NPSCB, Contract No. 68-C9-0013
293	Cropland Erosion	King, J. Phillip, Julie Wright	Interim Report: Sediment Delivery Estimation Methods, Draft, November 15, 1991, Department of Civil, Agricultural and Geological Engineering, New Mexico State University Prepared for USEPA, NPSCB, Contract No. 68-C9-0013
294	Manure Spreading	Steenhuis, T.S., et al.	Ammonia Volatilization of Winter Spread Manure Transactions of the ASAE, Vol. 22, No. 1, pp. 152-157, 1979
310	Cropland Erosion	Arcieri, W.R., et al.	Tillage and Winter Cover Effects on Runoff and Soil Loss in Silage Corn Atlantic Regional Meeting of the ASAE, August, 1986
311	Nutrient Managemtn	Romkens, M.J.M., et al.	Nitrogen and Phosphorus Composition of Surface Runoff as Affected by Tillage Method Journal of Environmental Quality, Vol.2, No. 2, 1973
313	Manure Spreading	Long, F. Leslie,	Runoff Water Quality as Affected by Surface-applied Dairy Cattle Manure Journal of Environmental Quality, Vol. 8, No. 2, 1979
330	Cropland Erosion	Mueller, Dwight H.	Effect of Selected Conservation Tillage Pracuces on The Quality of Runoff Water M.S. Thesis, University of Wisconsin, 1979
331	Cropland Erosion	Schwab, G.O., et al.	Sediment and Chemical Content of Drainage Water Joint Meeting of ASAE and CSAE, 1979
333	Cropland Erosion	Yoo, K.H., et al.	Surface Runoff and its Quality from Conservauon Tillage Systems of Cotton
335	Cropland Erosion	Spomer, R.G., et al.	Soil and Water Conservation with Western Iowa Tillage Systems Transactions of the ASAE, Vol. 19, No. 1, 1976
340	Nutrient Management	Spooner, J., et al.	Nonpoint Sources: NPS Policy, Economics, and Planning Research Journal WPCF, Vol. 62, No. 4, June 1990
347	Irrigation	Yonts, C.D., et al.	Furrow Irrigation Performance in Reduced-Tillage Systems Transactions of the ASAE, Vol. 34, No. 1, 1991
348	Cropland Erosion	Roy, B.L., A. R. Jarreet	The Role of Coarse Fragments and Surface Compaction in Reducing Interrill Erosion Transactions of the ASAE, Vol. 34, No. 1, 1991
352	Cropland Erosion	Younos, T.M., et al.	Fate and Effects of Pollutants: Nonpoint Sources (literature review), Journal WPCF, Vol. 59, No. 6, 1987
353	Cropland Erosion	JHayes, .C., J.E. Hairston	Modeling Long-Term Effectiveness of Vegetative Filters as On- Site Sediment Controls ASAE Paper No. 83-2081, 1983

CHAPTER 3: Management Measures for Forestry

I. INTRODUCTION

A. What "Management Measures" Are

This chapter specifies management measures to protect coastal waters from silvicultural sources of nonpoint pollution. "Management measures" are defined in section 6217 of the Coastal Zone Act Reauthorization Amendments of 1990 (CZARA) as economically achievable measures to control the addition of pollutants to our coastal waters, which reflect the greatest degree of pollutant reduction achievable through the application of the best available nonpoint pollution control practices, technologies, processes, siting criteria, operating methods, or other alternatives.

These management measures will be incorporated by States into their coastal nonpoint programs, which under CZARA are to provide for the implementation of management measures that are "in conformity" with this guidance. Under CZARA, States are subject to a number of requirements as they develop and implement their Coastal Nonpoint Pollution Control Programs in conformity with this guidance and will have some flexibility in doing so. The application of these management measures by States to activities causing nonpoint pollution is described more fully in *Coastal Nonpoint Pollution Control Program: Program Development and Approval Guidance*, published jointly by the U.S. Environmental Protection Agency (EPA) and the National Oceanic and Atmospheric Administration (NOAA).

B. What "Management Practices" Are

In addition to specifying management *measures*, this chapter also lists and describes management *practices* for illustrative purposes only. While State programs are required to specify management *measures* in conformity with this guidance, States programs need not specify or require implementation of the particular management *practices* described in this document. However, as a practical matter, EPA anticipates that the management measures generally will be implemented by applying one or more management practices appropriate to the site, location, type of operation, and climate. The practices listed in this document have been found by EPA to be representative of the types of practices that can be applied successfully to achieve the management measures. EPA has also used some of these practices, or appropriate combinations of these practices, as a basis for estimating the effectiveness, costs, and economic impacts of achieving the management measures. (Economic impacts of the management measures are addressed in a separate document entitled *Economic Impacts of EPA Guidance Specifying Management Measures for Sources of Nonpoint Pollution in Coastal Waters*.)

EPA recognizes that there is often site-specific, regional, and national variability in the selection of appropriate practices, as well as in the design constraints and pollution control effectiveness of practices. The list of practices for each management measure is not all-inclusive and does not preclude States or local agencies from using other technically sound practices. In all cases, however, the practice or set of practices chosen by a State needs to achieve the management measure.

C. Scope of This Chapter

This chapter contains 10 management measures that address various phases of forestry operations relevant to the control of sources of silvicultural nonpoint pollution that affect coastal waters. A separate measure for forestry operations in forested wetlands is included. These measures are:

- (1) Preharvest planning
- (2) Streamside management areas
- (3) Road construction/reconstruction
- (4) Road management
- (5) Timber harvesting
- (6) Site preparation and forest regeneration
- (7) Fire management
- (8) Revegetation of disturbed areas
- (9) Forest chemical management
- (10) Wetland forest management

Each of these topics is addressed in a separate section of this chapter. Each section contains (1) the management measure; (2) an applicability statement that describes, when appropriate, specific activities and locations for which the measure is suitable; (3) a description of the management measure's purpose; (4) the rationale for the management measure's selection; (5) information on the effectiveness of the management measure and/or of practices to achieve the measure; (6) information on management practices that are suitable, either alone or in combination with other practices, to achieve the management measure; and (7) information on costs of the measure and/or of practices to achieve the measure.

Coordination of Measures

The management measures developed for silviculture are to be used as an overall system of measures to address nonpoint source (NPS) pollution sources on any given site. In most cases, not all the measures will be needed to address the NPS sources of a specific site. For example, many silvicultural systems do not require road construction as part of the operation and would not need to be concerned with the management measure that addresses road construction. By the same token, many silvicultural systems do not use prescribed fire and would not need to use the fire management measure.

Most forestry operations will have more than one phase of operation that needs to be addressed and will need to employ two or more of the measures to address the multiple sources. Where more than one phase exists, the application of the measures needs to be coordinated to produce an overall system that adequately addresses all sources for the site and does not cause unnecessary expenditure of resources on the site.

Since the silvicultural management measures developed for the CZARA are, for the most part, a system of practices that are commonly used and recommended by States and the U.S. Forest Service in guidance or rules for forestry-related nonpoint source pollution, there are many forestry operations for which practices or systems of practices have already been implemented. Many of these operations may already achieve the measures needed for the nonpoint sources on them. For cases where existing source control is inadequate, it may be necessary to add only one or two more practices to achieve the measure. Existing NPS progress must be recognized and appropriate credit given to the accomplishment of our common goal to control NPS pollution. There is no need to spend additional resources for a practice that is already in existence and operational. Existing practices, plans, and systems should be viewed as building blocks for these management measures and may need no additional improvement.

D. Relationship of This Chapter to Other Chapters and to Other EPA Documents

1. Chapter 1 of this document contains detailed information on the legislative background for this guidance, the process used by EPA to develop this guidance, and the technical approach used by EPA in the guidance.
2. Chapter 7 of this document contains management measures to protect wetlands and riparian areas that serve a nonpoint source pollution abatement function. These measures apply to a broad variety of nonpoint sources; however, the measures for wetlands described in Chapter 7 are not intended to address silvicultural sources.

Practices for normal silvicultural operations in forested wetlands are covered in Management Measure J of Chapter 3.

3. Chapter 8 of this document contains information on recommended monitoring techniques to (1) ensure proper implementation, operation, and maintenance of the management measures and (2) assess over time the success of the measures in reducing pollution loads and improving water quality.
4. EPA has separately published a document entitled *Economic Impacts of EPA Guidance Specifying Management Measures for Sources of Nonpoint Pollution in Coastal Waters*.
5. NOAA and EPA have jointly published guidance entitled *Coastal Nonpoint Pollution Control Program: Program Development and Approval Guidance*. This guidance contains details on how State coastal nonpoint pollution control programs are to be developed by States and approved by NOAA and EPA. It includes guidance on:
 - The basis and process for EPA/NOAA approval of State Coastal Nonpoint Pollution Control Programs;
 - How NOAA and EPA expect State programs to specify management measures "in conformity" with this management measures guidance;
 - How States may target sources in implementing their Coastal Nonpoint Pollution Control Programs;
 - Changes in State coastal boundaries; and
 - Requirements concerning how States are to implement Coastal Nonpoint Pollution Control Programs.

E. Background

The effects of forestry activities on water quality have been widely studied, and the need for management measures and practices to prevent silvicultural contributions to water pollution has been recognized by all States with significant forestry activities. Silvicultural activities have been identified as nonpoint sources in coastal area water quality assessments and control programs. Water quality concerns related to forestry were addressed in the 1972 Federal Water Pollution Control Act Amendments and later, more comprehensively, as nonpoint sources under section 208 of the 1977 Clean Water Act and section 319 of the 1987 Water Quality Act. On a national level, silviculture contributes approximately 3 to 9 percent of nonpoint source pollution to the Nation's waters (Neary et al., 1989; USEPA, 1992a). Local impacts of timber harvesting and road construction on water quality can be severe, especially in smaller headwater streams (Brown, 1985; Coats and Miller, 1981; Pardo, 1980). Megahan (1986) reviewed several studies on forest land erosion and concluded that surface erosion rates on roads often equaled or exceeded erosion reported for severely eroding agricultural lands. These effects are of greatest concern where silvicultural activity occurs in high-quality watershed areas that provide municipal water supplies or support cold-water fisheries (Whitman, 1989; Neary et al., 1989; USEPA, 1984; Coats and Miller, 1981).

Twenty-four States have identified silviculture as a problem source contributing to NPS pollution in their 1990 section 305(b) assessments (USEPA, 1992b). Silviculture was the pollution source for 9 percent of NPS pollution to rivers in the 42 States reporting NPS pollution figures in section 305(b) assessments (USEPA, 1992b). States have reported up to 19 percent of their river miles to be impacted by silviculture. On Federal lands, such as national forests, many water quality problems can be attributed to the effects of timber harvesting and related activities (Whitman, 1989). In response to these impacts, many States have developed programs to address NPS pollution from forestry activities.

1. Pollutant Types and Impacts

Without adequate controls, forestry operations may degrade several water quality characteristics in waterbodies receiving drainage from forest lands. Sediment concentrations can increase due to accelerated erosion; water temperatures can increase due to removal of overstory riparian shade; slash and other organic debris can accumulate in waterbodies, depleting dissolved oxygen; and organic and inorganic chemical concentrations can increase due to harvesting and fertilizer and pesticide applications (Brown, 1985). These potential increases in water quality contaminants are usually proportional to the severity of site disturbance (Riekerk, 1983, 1985; Riekerk et al., 1989). Silvicultural NPS pollution impacts depend on site characteristics, climatic conditions, and the forest practices employed. Figure 3-1 presents a model of forest biogeochemistry, hydrology, and stormflow interactions.

Sediment. Sediment is often the primary pollutant associated with forestry activities (Pardo, 1980). Sediment is often defined as mineral or organic solid material that is eroded from the land surface by water, ice, wind, or other processes and is then transported or deposited away from its original location.

Sediment transported from forest lands into waterbodies can be particularly detrimental to benthic organisms and many fish species. When it settles, sediment fills interstitial spaces in lake bottoms or streambeds. This can eliminate essential habitat, covering food sources and spawning sites and smothering bottom-dwelling organisms and periphyton. Sediment deposition also reduces the capacity of stream channels to carry water and of reservoirs to hold water. This decreased flow and storage capacity can lead to increased flooding and decreased water supplies (Golden, et al., 1984).

Suspended sediments increase water turbidity, thereby limiting the depth to which light can penetrate and adversely affecting aquatic vegetation photosynthesis. Suspended sediments can also damage the gills of some fish species, causing them to suffocate, and can limit the ability of sight-feeding fish to find and obtain food.

Turbid waters tend to have higher temperatures and lower dissolved oxygen concentrations. A decrease in dissolved oxygen levels can kill aquatic vegetation, fish, and benthic invertebrates. Increases (or decreases) in water temperature outside the tolerance limits of aquatic organisms, especially cold-water fish such as trout and salmon, can also be lethal (Brown, 1974).

Nutrients. Nutrients from forest fertilizers, such as nitrogen and phosphorus adsorbed to sediments, in solution, or transported by aerial deposition, can cause harmful effects in receiving waters. Sudden removal of large quantities of vegetation through harvesting can also increase leaching of nutrients from the soil system into surface waters and ground waters by disrupting the nitrogen cycle (Likens et al., 1970). Excessive amounts of nutrients may cause enrichment of waterbodies, stimulating algal blooms. Large blooms limit light penetration into the water column, increase turbidity, and increase biological oxygen demand, resulting in reduced dissolved oxygen levels. This process, termed eutrophication, drastically affects aquatic organisms by depleting the dissolved oxygen these organisms need to survive.

Forest Chemicals. Herbicides, insecticides, and fungicides (collectively termed pesticides) used to control forest pests and undesirable plant species, can be toxic to aquatic organisms. Pesticides that are applied to foliage or soils, or are applied by aerial means, are most readily transported to surface waters and ground waters (Norris and Moore, 1971). Some pesticides with high solubilities can be extremely harmful, causing either acute or chronic effects in aquatic organisms, including reduced growth or reproduction, cancer, and organ malfunction or failure (Brown, 1974). Persistent pesticides that tend to sorb onto particulates are also of environmental concern since these relatively nonpolar compounds have the tendency to bioaccumulate. Other "chemicals" that may be released during forestry operations include fuel, oil, and coolants used in equipment for harvesting and road-building operations.

Organic Debris Resulting from Forestry Activities. Organic debris includes residual logs, slash, litter, and soil organic matter generated by forestry activities. Organic debris can adversely affect water quality by causing increased biochemical oxygen demand, resulting in decreased dissolved oxygen levels in watercourses. Logging slash and debris deposited in streams can alter streamflows by forming debris dams or rerouting streams, and can also

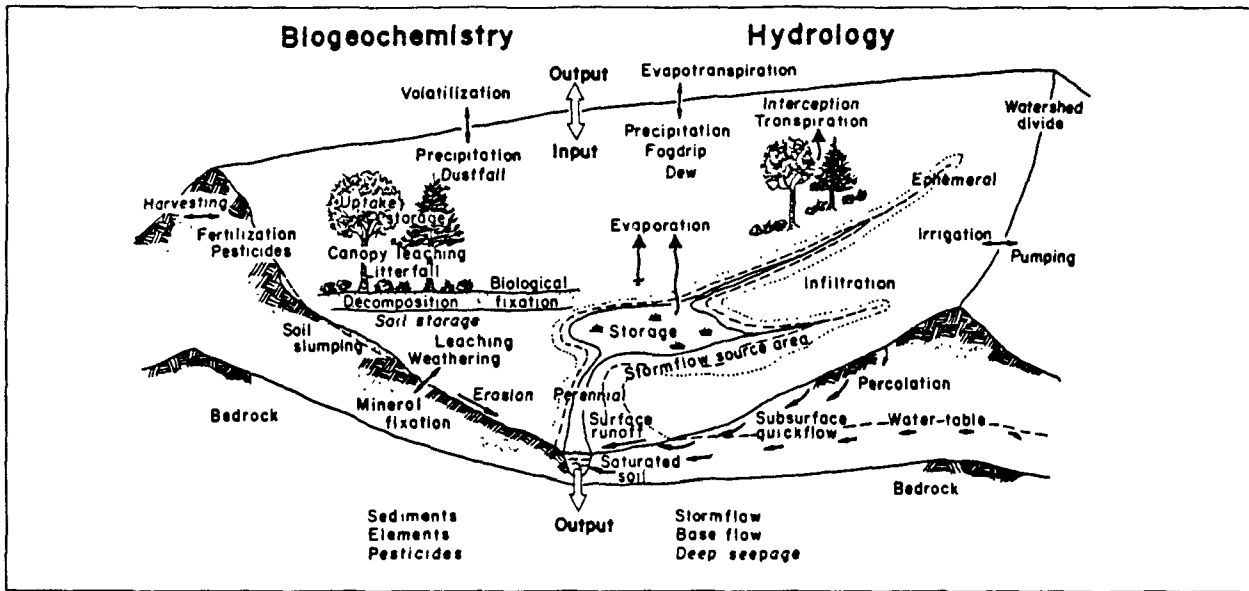

Figure 3-1. Conceptual model of forest biogeochemistry, hydrology and stormflow (Riekerk et al., 1989).

redirect flow in the channel, increasing bank cutting and resulting sedimentation (Dunford, 1962; Everest and Meehan, 1981). In some ecosystems, small amounts of naturally occurring organic material can be beneficial to fish production. Small streams in the Pacific Northwest may be largely dependent on the external energy source provided by organic materials such as leaves and small twigs. Naturally occurring large woody debris in streams can also create physical habitat diversity for rearing salmonids and can stabilize streambeds and banks (Everest and Meehan, 1981; Murphy et al., 1986).

Temperature. Increased temperatures in streams and waterbodies can result from vegetation removal in the riparian zone from either harvesting or herbicide use. These temperature increases can be dramatic in smaller (lower order) streams, adversely affecting aquatic species and habitat (Brown, 1972; Megahan, 1980; Curtis et al., 1990). Increased water temperatures can also decrease the dissolved oxygen holding capacity of a waterbody, increasing biological oxygen demand levels and accelerating chemical processes (Curtis et al., 1990).

Streamflow. Increased streamflow often results from vegetation removal (Likens et al., 1970; Eschner and Larmoyeux, 1963; Blackburn et al., 1982). Tree removal reduces evapotranspiration, which increases water availability to stream systems. The amount of streamflow increase is related to the total area harvested, topography, soil type, and harvesting practices (Curtis et al., 1990). Increased streamflows can scour channels, erode streambanks, increase sedimentation, and increase peak flows.

2. Forestry Activities Affecting Water Quality

The types of forestry activities affecting NPS pollution include road construction and use, timber harvesting, mechanical equipment operation, burning, and fertilizer and pesticide application (Neary et al., 1989).

Road Construction and Use. Roads are considered to be the major source of erosion from forested lands, contributing up to 90 percent of the total sediment production from forestry operations (Rothwell, 1983; Megahan, 1980; Patric, 1976). (See Figure 3-2.) Erosion potential from roads is accelerated by increasing slope gradients on cut-and-fill slopes, intercepting subsurface water flow, and concentrating overland flow on the road surface and in channels (Megahan, 1980). Roads with steep gradients, deep cut-and-fill sections, poor drainage, erodible soils, and road-stream crossings contribute to most of this sediment load, with road-stream crossings being the most frequent

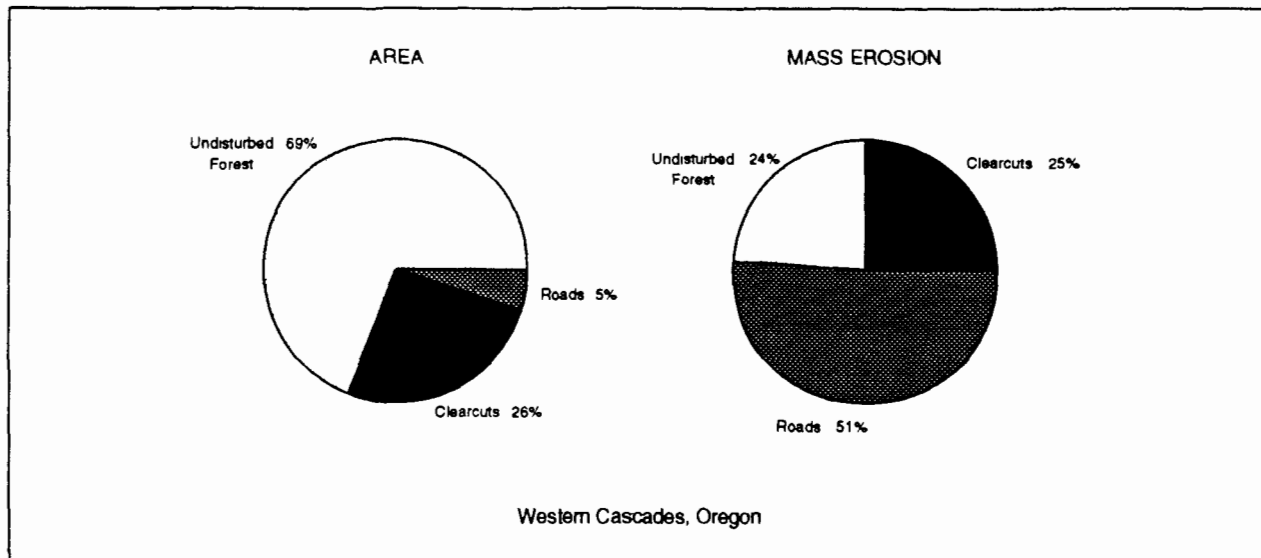

Figure 3-2. Comparison of forest land areas and mass erosion under various land uses (adapted from Sidle, 1989).

sources of erosion and sediment (Rothwell, 1983). Soil loss tends to be greatest during and immediately after road construction because of the unstabilized road prism and disturbance by passage of heavy trucks and equipment (Swift, 1984).

Brown and Krygier (1971) found that sediment production doubled after road construction on three small watersheds in the Oregon Coast Range. Dyness (1967) observed the loss of 680 cubic yards of soil per acre from the H.J. Andrews Experimental Forest in Oregon due to soil erosion from roads on steep topography. Landslides were observed on all slopes and were most pronounced where forest roads crossed stream channels on steep drainage headwalls. Another example of severe erosion resulting from forestry practices occurred in the South Fork of the Salmon River in Idaho in the winter of 1965, following 15 years of intensive logging and road construction. Heavy rains triggered a series of landslides that deposited sediment on spawning beds in the river channel, destroying salmon spawning grounds (Megahan, 1981). Careful planning and proper road layout and design, however, can minimize erosion and prevent stream sedimentation (Larse, 1971).

Timber Harvesting. Most detrimental effects of harvesting are related to the access and movement of vehicles and machinery, and the skidding and loading of trees or logs. These effects include soil disturbance, soil compaction, and direct disturbance of stream channels. Logging operation planning, soil and cover type, and slope are the most important factors influencing harvesting impacts on water quality (Yoho, 1980). The construction and use of haul roads, skid trails, and landings for access to and movement of logs are the harvesting activities that have the greatest erosion potential.

Surveys of soil disturbance from logging were performed by Hornbeck and others (1986) in Maine, New Hampshire, and Connecticut. They found 18 percent of the mineral soil exposed by logging practices in Maine, 11 percent in New Hampshire, and 8 percent in Connecticut. Megahan (1986) reviewed several studies on forest land erosion and concluded that surface erosion rates on roads often equaled or exceeded erosion reported for severely eroding agricultural lands. Megahan (1986) found that in some cases erosion rates from harvest operations may approach erosion rates from roads and that prescribed burning can accelerate erosion beyond that from logging alone.

Another adverse impact of harvesting is the increase in stream water temperatures resulting from removal of streamside vegetation, with the greatest potential impacts occurring in small streams. However, streamside buffer strips have been shown to minimize the increase in stream temperatures (Brazier and Brown, 1973; Brown and Krygier, 1970).

Regeneration Methods. Regeneration methods can be divided into two general types: (1) regeneration from seedlings, either planted seedlings or existing seedlings released by harvesting, and (2) regeneration from seed, which can be seed from existing trees on or near the site or the broadcast application of seeds of the desired species. In some areas, regeneration with seedlings by mechanical tree planting is often conducted because it is faster and more consistent. Planting approaches relying on seeding generally require a certain amount of mineral soil to be exposed for seed establishment. For this reason, a site preparation technique is usually needed for regeneration by seeding.

Site Preparation. Mechanical site preparation by large tractors that shear, disk, drum-chop, or root-rake a site may result in considerable soil disturbance over large areas and has a high potential to deteriorate water quality (Beasley, 1979). Site preparation techniques that result in the removal of vegetation and litter cover, soil compaction, exposure or disturbance of the mineral soil, and increased stormflows due to decreased infiltration and percolation, all can contribute to increases in stream sediment loads (Golden et al., 1984). However, erosion rates decrease over time as vegetative cover grows back.

Prescribed burning and herbicides are other methods used to prepare sites that may also have potential negative effects on water quality. These activities are discussed below.

Prescribed Burning. Prescribed burning of slash can increase erosion by eliminating protective cover and altering soil properties (Megahan, 1980). The degree of erosion following a prescribed burn depends on soil erodibility, slope, precipitation timing, volume and intensity, fire severity, cover remaining on the soil, and speed of revegetation. Burning may also increase stormflow in areas where all vegetation is killed. Such increases are partially attributable to decreased evapotranspiration rates and reduced canopy interception of precipitation. Erosion resulting from prescribed burning is generally less than that resulting from roads and skid trails and from site preparation that causes intense soil disturbance (Golden et al., 1984). However, significant erosion can occur during prescribed burning if the slash being burned is collected or piled, causing soil to be moved and incorporated into the slash.

Application of Forest Chemicals. Adverse effects on water quality due to forest chemical application typically result from improper chemical application, such as failure to establish buffers around watercourses (Norris and Moore, 1971). Aerial application of forest chemicals has a greater potential to adversely affect water quality, especially if chemicals are applied under improper conditions, such as high winds (Riekerk et al., 1989), or are applied directly to watercourses.

F. Other Federal, State, and Local Silviculture Programs

1. Federal Programs

Forestry activities on Federal lands are predominantly controlled by the U.S. Department of Agriculture (USDA) Forest Service and Department of the Interior (DOI) Bureau of Land Management (BLM). Private entities operating on Federal lands are regulated by timber sales contracts. The Forest Service has developed preventive land management practices and project performance standards (USEPA, 1991). The Agricultural Stabilization and Conservation Service (ASCS) administers the Forestry Incentives Program (FIP) and Stewardship Incentives Program (SIP). Under FIP, ASCS provides cost-share funds to develop, manage, and protect eligible forest land, with emphasis on enhancing water quality, wildlife habitat, and recreational resources, and producing softwood timber. In addition, the Clean Water Act section 404 regulatory program may be applicable to some forestry activities (such as stream crossings) that involve the discharge of dredged or fill material into waters of the United States. However, section 404(f) of the Act exempts most forestry activities from permitting requirements. Regulations describing 404(f) exemptions, as well as applicable best management practices for section 404, have been published by EPA and the U.S. Army Corps of Engineers (40 CFR 232.3). The management measures in this guidance apply only to nonpoint source silvicultural activities. Clean Water Act section 402 regulations for point source permits exempt these nonpoint silvicultural activities (40 CFR 122.27) except for the section 404 requirements discussed above.

2. State Forestry NPS Programs

Most States with significant forestry activities have developed Best Management Practices (BMPs) to control silviculturally-related NPS water quality problems. Often, water quality problems are not due to ineffectiveness of the practices themselves, but to the failure to implement them appropriately (Whitman, 1989; Pardo, 1980).

There are currently two basic types of State forestry NPS programs, voluntary and regulatory. Thirty-five States currently implement voluntary programs, with 6 of these States having the authority to make the voluntary programs regulatory and 10 States backing the voluntary program with a regulatory program for non-compliers (see Table 3-1 for more specific types of programs). Nine States have developed regulatory programs (Essig, 1991).

Voluntary programs rely on a set of BMPs as guidelines to operators (Cubbage et al., 1989). Operator education and technology transfer are also a responsibility of State Forestry Departments. Workshops, brochures, and field tours are used to educate and to demonstrate to operators the latest water quality management techniques. Landowners are encouraged to hire operators who have a working knowledge of State forestry BMPs (Dissmeyer and Miller, 1991). Transfer of information on State NPS controls to landowners is also an important element of these programs.

Regulatory programs involve mandatory controls and enforcement strategies defined in Forest Practice Rules based on a State's Forest Practices Act or local government regulations. These programs usually require the implementation of BMPs based on site-specific conditions and water quality goals, and they have enforceable requirements (Ice, 1985). Often streams are classified based on their most sensitive designated use, such as importance for municipal water supply or propagation of aquatic life. Many water quality BMPs also improve harvesting operation efficiency and therefore can be applied in the normal course of forest harvest operations with few significant added costs (Ontario Ministry of Natural Resources, 1988; Dissmeyer and Miller, 1991). Harvest operation plans or applications to perform a timber harvest are frequently reviewed by the responsible State agency. Erosion and sedimentation control BMPs are also used in these programs to minimize erosion from road construction and harvesting activities.

Present State Coastal Zone Management (CZM) and section 319 programs may already include specific BMP regulations or guidelines for forestry activities. In some States, CZM programs have adopted State forestry regulations and BMPs through reference or as part of a linked program.

3. Local Governments

Counties, municipalities, and local soil and water conservation management districts may also impose additional requirements on landowners and operators conducting forestry activities. In urbanizing areas, these requirements often relate to concerns regarding the conversion of forested lands to urban uses or changes in private property values due to aesthetic changes resulting from forestry practices. In rural areas additional requirements for forestry activities may be implemented to protect public property (roads and municipal water supplies). Local forestry regulations tend to be stricter in response to residents' complaints (Salazar and Cubbage, 1990).

Table 3-1. State Programs by Region and Frequency (Henly and Ellefson, 1987)

Major Forestry Activity and Program Type	Frequency of States in Region Having Program Type									Total
	New England	Middle Atlantic	Lake States	Central States	South Atlantic	Southern States	Pacific States	N. Rocky Mountain	S. Rocky Mountain	
Water Quality Protection										
Tax Incentives	0	0	1	0	0	0	0	0	0	1
Financial Incentives	0	1	1	0	1	1	1	0	0	5
Educational Programs	5	2	3	5	3	8	3	3	3	35
Technical Assistance	6	5	3	6	3	6	2	4	5	40
Voluntary Guidelines	3	4	1	3	3	9	2	3	2	30
Legal Regulations	5	4	3	1	0	0	5	3	3	24
Reforestation and Timber Management										
Tax Incentives	1	2	3	5	1	2	0	2	0	16
Financial Incentives	1	3	3	4	3	4	2	1	1	22
Educational Programs	5	4	3	6	3	8	3	3	2	37
Technical Assistance	6	5	3	7	3	8	4	5	5	46
Voluntary Guidelines	0	2	2	2	3	3	1	1	2	16
Legal Regulations	1	3	1	1	0	0	4	1	3	14
Forest Protection										
Tax Incentives	0	1	0	0	0	0	0	0	0	1
Financial Programs	0	1	1	0	0	1	1	0	0	4
Educational Programs	5	5	3	6	3	9	1	3	3	38
Technical Assistance	6	5	3	7	3	9	4	4	5	46
Voluntary Guidelines	1	1	1	2	3	3	1	3	2	17
Legal Regulations	6	4	2	6	3	8	5	4	4	42
Wildlife and Aesthetic Management										
Tax Incentives	0	1	1	1	0	0	0	0	0	3
Financial Incentives	0	1	1	3	0	0	1	0	0	6
Educational Programs	4	3	3	5	3	7	1	4	2	32
Technical Assistance	5	5	3	6	3	7	4	4	4	41
Voluntary Guidelines	1	1	1	2	2	3	1	1	1	13
Legal Regulations	2	2	1	2	0	1	5	1	0	14

NOTE: Water Quality Protection focuses on nonpoint silvicultural sources of pollutants, vegetative buffer strips along waters, road and skid trail design and construction. Reforestation and Timber Management focuses on seed trees and other reforestation forms, timber harvesting system, clearcut size and design. Forest Protection focuses on slash treatment, other wildfire-related treatments, prescribed burn smoke management, herbicide and pesticide application, disease and insect management. Wildlife and Aesthetic Management focuses on wildlife habitat, scenic buffers along roadways, coastal zone management requirements.

Regional Groupings of States: New England-Connecticut, Maine, Massachusetts, New Hampshire, Rhode Island and Vermont; Middle Atlantic-Delaware, Maryland, New Jersey, New York, Pennsylvania and West Virginia; Lake States-Michigan, Minnesota, and Wisconsin; Central States-Illinois, Indiana, Iowa, Kansas, Kentucky, Missouri, Nebraska and Ohio; South Atlantic-North Carolina, South Carolina and Virginia; Southern States-Florida, Georgia, Alabama, Mississippi, Tennessee, Arkansas, Louisiana, Oklahoma and Texas; Pacific States-Alaska, California, Hawaii, Oregon and Washington; N. Rocky Mountain-Idaho, Montana, North Dakota, South Dakota and Wyoming; S. Rocky Mountain-Arizona, Colorado, Nevada, New Mexico and Utah.

II. FORESTRY MANAGEMENT MEASURES

A. Preharvest Planning

Perform advance planning for forest harvesting that includes the following elements where appropriate:

- (1) Identify the area to be harvested including location of waterbodies and sensitive areas such as wetlands, threatened or endangered aquatic species habitat areas, or high-erosion-hazard areas (landslide-prone areas) within the harvest unit.
- (2) Time the activity for the season or moisture conditions when the least impact occurs.
- (3) Consider potential water quality impacts and erosion and sedimentation control in the selection of silvicultural and regeneration systems, especially for harvesting and site preparation.
- (4) Reduce the risk of occurrence of landslides and severe erosion by identifying high-erosion-hazard areas and avoiding harvesting in such areas to the extent practicable.
- (5) Consider additional contributions from harvesting or roads to any known existing water quality impairments or problems in watersheds of concern.

Perform advance planning for forest road systems that includes the following elements where appropriate:

- (1) Locate and design road systems to minimize, to the extent practicable, potential sediment generation and delivery to surface waters. Key components are:
 - locate roads, landings, and skid trails to avoid to the extent practicable steep grades and steep hillslope areas, and to decrease the number of stream crossings;
 - avoid to the extent practicable locating new roads and landings in Streamside Management Areas (SMAs); and
 - determine road usage and select the appropriate road standard.
- (2) Locate and design temporary and permanent stream crossings to prevent failure and control impacts from the road system. Key components are:
 - size and site crossing structures to prevent failure;
 - for fish-bearing streams, design crossings to facilitate fish passage.
- (3) Ensure that the design of road prism and the road surface drainage are appropriate to the terrain and that road surface design is consistent with the road drainage structures.
- (4) Use suitable materials to surface roads planned for all-weather use to support truck traffic.
- (5) Design road systems to avoid high erosion or landslide hazard areas. Identify these areas and consult a qualified specialist for design of any roads that must be constructed through these areas.

Each State should develop a process (or utilize an existing process) that ensures that the management measures in this chapter are implemented. Such a process should include appropriate notification, compliance audits, or other mechanisms for forestry activities with the potential for significant adverse nonpoint source effects based on the type and size of operation and the presence of stream crossings or SMAs.

1. Applicability

This management measure pertains to lands where silvicultural or forestry operations are planned or conducted. The planning process components of this management measure are intended to apply to commercial harvesting on areas greater than 5 acres and any associated road system construction or reconstruction conducted as part of normal silvicultural activities. The component for ensuring implementation of this management measure applies to harvesting and road construction activities that are determined by the State agency to be of a sufficient size to potentially impact the receiving water or that involve SMAs or stream crossings. On Federal lands, where notification of forestry activities is provided to the Federal land management agency, the provisions of the final paragraph of this measure may be implemented through a formal agreement between the State agency and the Federal land management agency. This measure does not apply to harvesting conducted for precommercial thinning or noncommercial firewood cutting.

Under the Coastal Zone Act Reauthorization Amendments of 1990, States are subject to a number of requirements as they develop coastal nonpoint source programs in conformity with this measure and will have some flexibility in doing so. The application of this management measure by States is described more fully in *Coastal Nonpoint Pollution Control Program: Program Development and Approval Guidance*, published jointly by the U.S. Environmental Protection Agency (EPA) and the National Oceanic and Atmospheric Administration (NOAA) of the U.S. Department of Commerce.

2. Description

The objective of this management measure is to ensure that silvicultural activities, including timber harvesting, site preparation, and associated road construction, are conducted without significant nonpoint source pollutant delivery to streams and coastal areas. Road system planning is an essential part of this management measure since roads have consistently been shown to be the largest cause of sedimentation resulting from forestry activities. Good road location and design can greatly reduce the sources and transport of sediment. Road systems should generally be designed to minimize the number of road miles/acres, the size and number of landings, the number of skid trail miles, and the number of watercourse crossings, especially in sensitive watersheds. Timing operations to take advantage of favorable seasons or conditions, avoiding wet seasons prone to severe erosion or spawning periods for fish, is effective in reducing impacts to water quality and aquatic organisms (Hynson et al., 1982). For example, timber harvesting might be timed to avoid periods of runoff, saturated soil conditions, and fish migration and spawning periods.

Preharvest planning should include provisions to identify unsuitable areas, which may have merchantable trees but pose unacceptable risks for landslides or high erosion hazard. These concerns are greatest for steep slopes in areas with high rainfall or snowpack or sensitive rock types. Decomposed granite, highly weathered sedimentary rocks, and fault zones in metamorphic rocks are potential rock types of concern for landslides. Deep soils derived from these rocks, colluvial hollows, and fine-textured clay soils are soil conditions that may also cause potential problems. Such areas usually have a history of landslides, either occurring naturally or related to earlier land-disturbing activities.

Potential water quality and habitat impacts should also be considered when planning silvicultural harvest systems as even-aged (e.g., clearcut, seedtree, shelterwood) or uneven-aged (e.g., group selection or individual tree selection) and planning the type of yarding system. While it may appear to be more beneficial to water quality to use uneven-aged silvicultural stand management because less ground disturbance and loss of canopy cover occur, these factors should also be weighed against the possible effects of harvesting more acres selectively to yield equivalent timber volumes. Such harvesting may require more miles of road construction, which can increase sediment generation and increase levels of road management.

In addition, for uneven-aged systems, yarding in moderately sloping areas is usually done with groundskidding equipment, which can cause much more soil disturbance than cable yarding. For even-aged systems, cable yarding may be used in sloping areas; cable yarding is not widely used for uneven-aged harvesting. Whichever silvicultural

system is selected, planning will be required to minimize erosion and sediment delivery to waterbodies. Preharvest planning should address how harvested areas will be replanted or regenerated to prevent erosion and potential impact to waterbodies.

Cumulative effects to water quality from forest practices are related to several processes within a watershed (onsite mass erosion, onsite surface erosion, pollutant transport and routing, and receiving water effects) (Sidle, 1989). Cumulative effects are influenced by forest management activities, natural ecosystem processes, and the distribution of other land uses. Forestry operations such as timber harvesting, road construction, and chemical use may directly affect onsite delivery of nonpoint source pollutants as well as contribute to existing cumulative impairments of water quality.

In areas where existing cumulative effects problems *have already been assessed* for a watershed of concern, the potential for additional contributions to known water quality impairments or problems should be taken into account during preharvest planning. This does not imply that a separate cumulative effects assessment will be needed for each planned forestry activity. Instead, it points to the need to consider the potential for additional contributions to known water quality impairments based on information from previously conducted watershed or cumulative effects assessments. These types of water quality assessments, generally conducted by State or Federal agencies, may indicate water quality impairments in watersheds of concern caused by types of pollutants unrelated to forestry activities. In this case, there would be no potential for additional contributions of those pollutants from the planned forestry activity. However, if existing assessments attribute a water quality problem to the types of pollutants potentially generated by the planned forestry activity, then it is appropriate to consider this during the planning process. If additional contributions to this impairment are likely to occur as a result of the planned activity, this may necessitate adjustments in planned activities or implementation of additional measures. This may include selection of harvest units with low sedimentation risk, such as flat ridges or broad valleys; postponement of harvesting until existing erosion sources are stabilized; and selection of limited harvest areas using existing roads. The need for additional measures, as well as the appropriate type and extent, is best considered and addressed during the preharvest planning process.

Some important sediment sources related to roads are stream crossings, road fills on steep slopes, poorly designed road drainage structures, and road locations in close proximity to streams. Roads through high-erosion-hazard areas can also lead to serious water quality degradation. Some geographical areas have a high potential for serious erosion problems (landslides, major gullies, etc.) after road construction. Factors such as slope steepness, soil and rock characteristics, and local hydrology influence this potential. High-erosion-hazard areas may include badlands, loess deposits, steep and dissected terrain, and areas with existing landslides and are generally recognizable on the ground by trained personnel. Indications of hazard locations may include landslides, gullies, weak soils, unusually high ground water levels, very steep slopes, unvegetated shorelines and streambanks, and major geomorphic changes. Road system planning should identify and avoid these areas.

In most States, high-erosion-hazard areas are limited in extent. In the Pacific Coast States, however, road-related landslides are often the major source of sediment associated with forest management. Erosion hazard areas are often mapped, and these maps are one tool to use in identifying high-erosion-hazard sites. The U.S. Geological Survey has produced geologic hazard maps for some areas. The USDA Soil Conservation Service (SCS) and Agricultural Stabilization and Conservation Service (ASCS), as well as State and local agencies, may also have erosion-hazard-area maps.

Preplanning the timber harvest operation to ensure water quality protection will minimize NPS pollution generation and increase operation efficiency (Maine Forest Service, 1991; Connecticut RC&D Forestry Committee, 1990; Golden et al., 1984). The planning of streamside management area width and extent is also crucial because of SMAs' potential to reduce pollutant delivery. Identification and avoidance of high-hazard areas can greatly reduce the risk of landslides and mass erosion (Golden et al., 1984). Careful planning of road and skid trail system locations will reduce the amount of land disturbance by minimizing the area in roads and trails, thereby reducing erosion and sedimentation (Rothwell, 1978). Studies at Fernow Experimental Forest, West Virginia, demonstrated that good planning reduced skid road area by as much as 40 percent (Kochenderfer, 1970).

Designing road systems prior to construction to minimize road widths, slopes, and slope lengths will also significantly reduce erosion and sedimentation (Larse, 1971). The most effective road system results from planning conducted to serve an entire basin, rather than arbitrarily constructing individual road projects to serve short-term needs (Swift, 1985). The key environmental factors involved in road design and location are soil texture, slope, aspect, climate, vegetation, and geology (Gardner, 1967).

Proper design of drainage systems and stream crossings can prevent system destruction by storms, thereby preventing severe erosion, sedimentation, and channel scouring (Swift, 1984). Removal of excess water from roads will also reduce the potential for grade weakening, surface erosion, and landslides. Drainage problems can be minimized when locating roads by avoiding clay beds, seeps, springs, concave slopes, muskegs, ravines, draws, and stream bottoms (Rothwell, 1978).

Developing a process, or utilizing an existing process, to ensure that the management measures in this chapter are implemented is an important component for forestry nonpoint source control programs. While silvicultural management of forests may extend over long stand rotation periods of 20 to 120 years and cover extensive areas of forestland, the forestry operations that generate nonpoint source pollution, like harvesting and road building, are of relatively short duration and occur in dispersed, often isolated locations in forested areas. Forest harvesting or road building operations are usually operational on a given site only for a period of weeks or months. These operational phases are then followed by the much longer period of regrowth of the stand or the rotation period. Since forestry operations are relatively dispersed and move from site to site within forested areas, it is essential to have some process to ensure implementation of management measures. For example, it is not possible to track the implementation of management measures or determine their effectiveness if there is no way of knowing where or when they might be applied. In the case of monitoring or water quality assessments, correlation of water quality conditions to forestry activities is not possible absent some ability to determine where and to what extent forestry operations are being conducted and whether management measures are being implemented. Because of the dispersed and episodic nature of forestry operations, many States have implemented programs that currently incorporate a process such as notification to ensure implementation and to facilitate evaluation of program implementation and assessment of water quality conditions.

This process has been shown to be a beneficial device for ensuring the implementation of water quality best management practices, particularly for forestry activities. In contrast to the typical forestry situation, nonpoint pollution from urban and agricultural sources is generated from areas and activities that are relatively stationary and repetitive. Because of this, these sources of nonpoint pollution are more apparent and readily addressed than more isolated and episodic forestry operations. Given the unique nature of forestry operations, it is necessary for States to have some mechanism for being apprised of forestry activities in order to uniformly address sources of nonpoint pollution.

This Forestry Management Measure component allows considerable flexibility to States for determining how this provision should be carried out in the coastal zone. For the purposes of this management measure, such a process should include appropriate notification mechanisms for forestry activities with the potential for nonpoint source impacts. It is important to point out that for the purposes of this management measure such a notification process might be either verbal or written and does *not* necessarily require submittal and approval of written preharvest plans (although those States that currently require submittal of a preharvest plan would also fulfill this management measure component for the coastal zone program). States also have flexibility in determining what information should be provided and how this should occur for notification mechanisms. Timing and location of the planned forestry operation are common elements of existing notification requirements and may serve as an acceptable minimum. Existing programs for forestry have found some type of notification of the planned activity to the appropriate State agency to be a very beneficial device for ensuring the implementation of water quality best management practices for silvicultural activities. At least 12 Coastal Zone Management Program States currently require some type of notification, associated with Forest Practices Acts, CWA section 404 requirements, tax incentive or cost share programs, State Forester technical assistance, severance tax filings, stream crossing permits, labor permits, erosion control permits, or land management agency agreements.

3. Management Measure Selection

The rationale for this measure is based on information on the effects of various harvesting practices and the effectiveness and costs of planning, design, and location components addressed in this measure. This measure is also based in part on the experience of some States in using preharvest planning as part of implementation of best management practices.

a. Effectiveness Information

Preharvest planning has been demonstrated to play an important role in the control of nonpoint source pollution and efficient forest management operations. A fundamental component to be considered in timber harvest planning is the selection of the silvicultural system. Research conducted by Beasley and Granillo (1985) demonstrated that selective cutting generated lower water yields and sediment yields than did clearcutting. This is important not only because of the sediment loss, but also because higher stormflows can undercut streambanks and scour channels, reducing channel stability. The data in Table 3-2 show that selective cutting results in sediment yields 2.5 to 20 times less and water yields 1.3 to 2.6 times less than those resulting from clearcutting. As stated previously, the amount and potential water quality impacts of roads needed for each system must also be taken into account.

Methods used for harvesting are closely related to the silvicultural system. Four harvesting methods combined with varying types of management practices to protect water quality, including road location, were compared in a study conducted by Eschner and Larmoyeux (1963) (Table 3-3). Harvesting effects on water quality, as measured by turbidity, were shown to be clearly related to the care taken in logging and planning skid roads. The extensive

**Table 3-2. Clearcutting Versus Selected Harvesting Methods (AR)
(Beasley and Granillo, 1985)**

Water Year	Treatment	Mean Annual Water Yield (cm)	Mean Annual Sediment Losses (kg/ha)
1981 (Preharvest)	Clearcut	6.4	41
	Selection	7.4	52
	Control	6.8	52
1982	Clearcut	13.2	264
	Selection	5.1	13
	Control	1.0	4
1983	Clearcut	44.7	63
	Selection	33.8	26
	Control	31.0	19
1984	Clearcut	32.8	83
	Selection	14.5	15
	Control	17.5	46
1985	Clearcut	27.9	73
	Selection	12.3	12
	Control	15.9	17

selection method, combined with some NPS controls (20 percent road grade limits, no skidding in streams, water bars on skid roads), produced higher maximum levels of turbidity than did intensive selection with additional control practices (10 percent road grade limits; skid trails located away from streams). Harvesting by the diameter limit practice without any restrictions on road grades or stream restrictions increased maximum turbidity by 200 times over intensive selection, and commercial clearcutting with no controls increased maximum turbidity by over three orders of magnitude. This study concluded that care taken in preharvest planning of skid roads and logging operations can prevent most potential impairment to water quality.

McMinn (1984) compared a skidder logging system and a cable yarder for their relative effects on soil disturbance (Table 3-4). With the cable yarder, 99 percent of the soil remained undisturbed (the original litter still covered the mineral soil), while the amount of soil remaining undisturbed after logging by skidder was only 63 percent. Beasley, Miller, and Gough (1984) related sediment loss associated with forest roads to the average slope gradient of road segments (Table 3-5). The greater the average slope gradient, the greater the soil loss, ranging from a total of 6.8 tons/acre lost when the slope gradient was 1 percent, to 19.4 tons/acre at 4 percent, to 32.3 tons/acre at 6 percent, to 33.7 tons/acre at 7 percent.

Sidle (1980) found that the impacts of tractor skidding can be lessened through the use of preplanned skid roads and landings designed so that the area disturbed by road construction and the overall extent of sediment compaction at the site are minimized. Sidle (1980) described a study in North Carolina that showed that preplanning roads could result in a threefold decrease in soil compaction at the logging area.

**Table 3-3. Effect of Four Harvesting and Road Design Methods on Water Quality (WV, PA)
(Eschner and Larmoyeux, 1963)**

Watershed Number	Practice	Maximum Turbidity (Turbidity units)	Frequency Distribution of Samples Turbidity Unit Classes				Total
			0 to 10	11 to 99	100 to 999	1000+	
1	Commercial clearcut ^a	56,000	126	40	24	13	203
2	Diameter limit ^b	5,200	171	17	8	7	203
5	Extensive selection ^d	210 ^c	195	8	0	0	203
3	Intensive selection ^e	25	201	2	0	0	203
4	Control	15	202	1	0	0	203

Note: Includes regularly scheduled samples and special samples in storm periods.

^a Skid roads were not planned but were "logger's choice."

^b Trees over 17 inches DBH were cut. Water bars placed at 2-chain intervals along skid roads.

^c Not included in frequency distribution. This sample was taken at a time when the other watersheds were not sampled.

^d Trees over 11 inches DBH were cut. Maximum skid road grade was 20 percent, with water bars installed as needed. Skidding was prohibited in streams.

^e With intensive selection, trees over 5 inches DBH were cut. Maximum skid road grade was 10 percent. Skidding was prohibited in streams, and roads were located away from streams. Water bars were used as needed, and disturbed areas were stabilized with grass seeding.

Table 3-4. Comparison of the Effect of Conventional Logging System and Cable Miniyarder on Soil (GA) (McMinn, 1984)

Disturbance Class ^a	Cable Skidder (percent)	Miniyarder (percent)
Undisturbed	63	99
Soil exposed	12	1
Soil disturbed	25	0

^a Undisturbed = original duff or litter still covering the mineral soil.
Exposed = litter and duff scraped away, exposing mineral soil, but no scarification.
Disturbed = Mineral soil exposed and scarified or dislocated.

Table 3-5. Relationship Between Slope Gradient and Annual Sediment Loss on an Established Forest Road^a (AR) (Beasley, Miller, and Gough, 1984)

Average Slope Gradient of Road Segment (percent)	Soil Deposited ^b		Suspended Solids		Total	
	tons per acre	tons per mile	tons per acre	tons per mile	tons per acre	tons per mile
7	21.6	54.0	12.0	30.0	33.7	84.0
6	10.2	26.7	22.1	57.8	32.3	84.5
4	5.0	11.3	14.4	32.6	19.4	43.8
1	0.2	0.3	6.6	12.4	6.8	12.7

^a The length of the road segments averaged 330 feet, ranging from 308 to 357 feet. Most of the other physical characteristics of the road were consistent, except the variation in the proportion of backslope to total area. Fill slopes below the road segments were well vegetated. Cut slopes were steep, bare, and actively eroding.

^b Measured in upslope, inside ditches.

Several researchers have emphasized that prevention is the most effective approach to erosion control for road activities (Megahan, 1980; Golden et al., 1984). Because roads are the greatest source of surface erosion from forestry operations, reducing road surface area while maintaining efficient access is a primary component of proper road design. Careful planning of road layout and design can minimize erosion by as much as 50 percent (Yoho, 1980; Weitzman and Trimble, 1952). This practice has the added benefits of reducing construction, maintenance, and transport costs and increasing forested area for production. Rice et al. (1972) found no increase in sedimentation from a well-designed logging road on gently sloping, stable soils in Oregon except for during the construction period.

Locating roads on low gradients is another planning component that can reduce the impacts of sedimentation. Trimble and Weitzman (1953) presented data showing that lower gradients and shorter road lengths reduce erosion. The same authors, in a 1952 journal article, also presented data showing that reduced gradients in conjunction with water bars can significantly reduce erosion from roads. The data from these two studies are presented in Table 3-6.

b. Cost Information

A cost-benefit analysis by Dissmeyer and others (USDA, 1987) reveals the dramatic, immediate savings from considering water quality during the design phase of a road reconstruction project (Table 3-7). Expertise on soil and water protection provided by a hydrologist resulted in 50 percent of the savings alone. Other long-term economic benefits of careful planning such as longer road life and reduced maintenance costs were not quantified in this analysis.

Table 3-6. The Effect of Skid Road Grade and Length on Road Surface Erosion (WV, PA) (Trimble and Weitzman, 1953)

Skid Road Type (Grade and Length of Slope)	Erosion from Skid Road Surface After Logging		
	Erosion (in)	Average Grade (%)	Average Length (ft)
0-20% grade/0-132 feet	0.4	10	46
21-40% grade/0-132 feet	0.7	29	55
133-264 feet	1.0	35	211

Table 3-7. Costs and Benefits of Proper Road Design (With Water Quality Considerations) Versus Reconstruction (Without Water Quality Considerations) (USDA Forest Service, 1987)

	Without Soil/ Water Input ^a	With Soil/Water Input ^a
Miles of road	3.0	3.0
Reconstruction costs	\$796,000	\$372,044
Soil/water input costs	--	\$800
Immediate benefit (savings) of soil/water input	--	\$211,978

^a Soil/water inputs are design adjustments made by a hydrologist and include narrower road width and steeper road bank cuts in soils of low erodibility and low revegetation potential.

Kochenderfer, Wendel, and Smith (1984) determined the costs for locating four minimum standard roads in the Central Appalachians (Table 3-8). Road location costs increased as the terrain became more difficult (e.g., had a large number of rock outcrops or steep slopes) or required several location changes. Typically, road location costs accounted for approximately 8 percent of total costs.

Ellefson and Miles (1984) performed an economic evaluation of forest practices to curb nonpoint source water pollutants. They presented the cumulative decline in net revenue of 1.2 percent for the practices of skid trail and landing design for a sale with initial net revenue of \$124,340.

4. Practices

As discussed more fully at the beginning of this chapter and in Chapter 1, the following practices are described for illustrative purposes only. State programs need not require implementation of these practices. However, as a practical matter, EPA anticipates that the management measure set forth above generally will be implemented by applying one or more management practices appropriate to the source, location, and climate. The practices set forth below have been found by EPA to be representative of the types of practices that can be applied successfully to achieve the management measure discussed above.

a. Harvesting Practices

■ Consider potential water quality and habitat impacts when selecting the silvicultural system as even-aged (clearcut, seedtree, or shelterwood) or uneven-aged (group or individual selection). The yarding system, site preparation method, and any pesticides that will be used should also be addressed in

Table 3-8. Characteristics and Road Location^a Costs of Four "Minimum-Standard" Forest Truck Roads Constructed in the Central Appalachians (Kochenderfer, Wendel, and Smith, 1984)

Road Number	Road Length (miles)	Road Grade (%)	Number of Dips ^b	Culvert			Location Costs (\$/miles)
				Number	Size (in)	Length (ft)	
1	0.81	6.9	22	1	18	39	585
6	0.78	2.7	15	5	15	135	615
7	0.34	3.7	5	2	15	64	720
8	1.25	2.6	30	0			585

^a Road location includes the cost to plan, reconnoiter, and lay out 1 mile of road.

^b Includes natural grade breaks where dozer work is required for outcropping.

preharvest planning. As part of this practice the potential impacts from and extent of roads needed for each silvicultural system should be considered.

- *In warmer regions, schedule harvest and construction operations during dry periods/seasons. In temperate regions, harvest and construction operations may be scheduled during the winter to take advantage of snow cover and frozen ground conditions.*
- *To minimize soil disturbance and road damage, limit operations to periods when soils are not highly saturated (Rothwell, 1978). Damage to forested slopes can also be minimized by not operating logging equipment when soils are saturated, during wet weather, or in periods of ground thawing.*
- *Planned harvest activities or chemical use should not contribute to problems of cumulative effects in watersheds of concern.*
- *Use topographic maps, aerial photography, soil surveys, geologic maps, and rainfall intensity charts to augment site reconnaissance to lay out and map harvest unit; identify and mark, as needed:*
 - *Any sensitive habitat areas needing special protection such as threatened and endangered species nesting areas,*
 - *Streamside management areas,*
 - *Steep slopes, high-erosion-hazard areas, or landslide prone areas,*
 - *Wetlands.*
- *In high-erosion-hazard areas, trained specialists (geologist, soil scientist, geotechnical engineer, wildland hydrologist) should identify sites that have high risk of landslides or that may become unstable after harvest and should recommend specific practices to control harvesting and protect water quality.*
- *Lay out harvest units to minimize the number of stream crossings.*
- *States are encouraged to adopt notification mechanisms that integrate and avoid duplicating existing requirements for notification including severance taxes, stream crossing permits, erosion control permits, labor permits, forest practice acts plans, etc. For example, States may require one preharvest*

plan that the landowner could submit to just one State or local office. The appropriate State agency might encourage forest landowners to develop a preharvest plan. The plan would address the components of this management measure including the area to be harvested, any forest roads to be constructed, and the timing of the activity.

b. Road System Practices

■ *Preplan skid trail and landing location on stable soils and avoid steep gradients, landslide-prone areas, high-erosion-hazard areas, and poor-drainage areas.*

- Landings should not be located in SMAs.
- New roads and skid trails should not be located in SMAs, except at crossings. Existing roads and landings in the SMA will be closed unless the construction of new roads and landings to access an area will cause greater water quality impacts than the use of existing roads.
- Roads should not be located along stream channels where road fill extends within 50-100 horizontal feet of the *annual* high water level. (Bankfull stage is also used as reference point for this.)

■ *Systematically design transportation systems to minimize total mileage.*

- Weigh skid trail length and number against haul road length and number.
- Locate landings to minimize skid trail and haul road mileage (Rothwell, 1978).

■ *Utilize natural log landing areas to reduce the potential for soil disturbance (Larse, 1971; Yee and Roelofs, 1980).*

■ *Plot feasible routes and locations on an aerial photograph or topographic map to assist in the final determination of road locations.*

Proper design will reduce the area of soil exposed by construction activities. Figure 3-3 presents a comparison of road systems.

■ *In moderately sloping terrain, plan for road grades of less than 10 percent, with an optimal grade between 3 percent and 5 percent. In steep terrain, short sections of road at steeper grades may be used if the grade is broken at regular intervals. Vary road grades frequently to reduce culvert and road drainage ditch flows, road surface erosion, and concentrated culvert discharges (Larse, 1971).*

Gentle grades are desirable for proper drainage and economical construction (Ontario Ministry of Natural Resources, 1988). Steeper grades are acceptable for short distances (200-300 feet), but an increased number of drainage structures may be needed above, on, and below the steeper grade to reduce runoff potential and minimize erosion. In sloping terrain, no-grade road sections are difficult to drain properly and should be avoided when possible.

■ *Design skid trail grades to be 15 percent or less, with steeper grades only for short distances.*

■ *Design roads and skid trails to follow the natural topography and contour, minimizing alteration of natural features.*

This practice will reduce the amount of cut and fill required and will consequently reduce road failure potential. Ridge routes and hillside routes are good locations for ensuring stream protection because they are removed from stream channels and the intervening undisturbed vegetation acts as a sediment barrier. Wide valley bottoms are good routes if stream crossings are few and roads are located outside of SMAs (Rothwell, 1978).

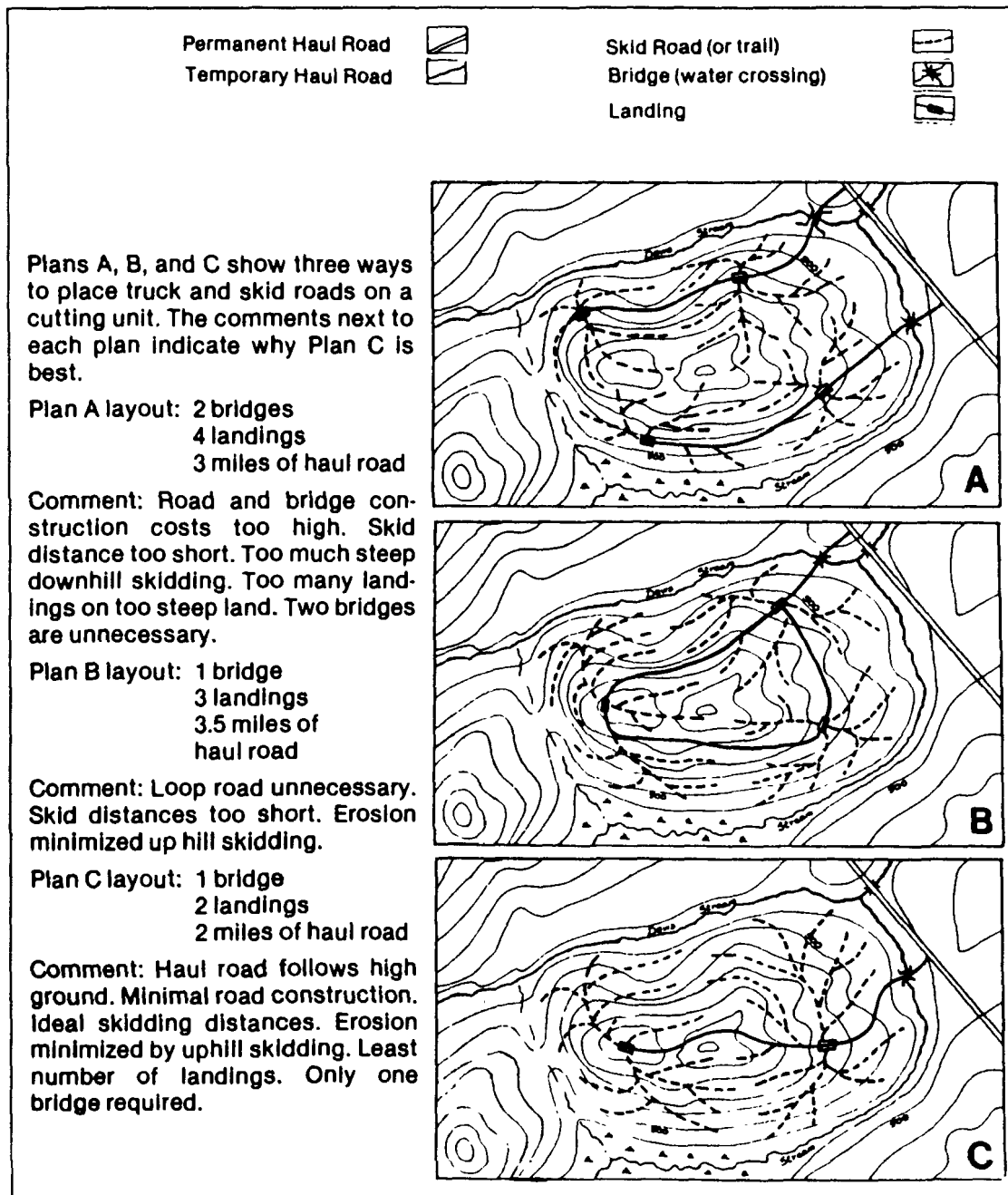

Figure 3-3. How to select the best road layout (Hynson et al., 1982).

■ Roads in steep terrain should avoid the use of switchbacks through the use of more favorable locations. Avoid stacking roads above one another in steep terrain by using longer span cable harvest techniques.

■ Design roads crossing low-lying areas so that water does not pond on the upslope side of the road.

- Use overlay construction techniques with suitable nonhazardous materials for roads crossing muskegs.
- Provide cross drains to allow free drainage and avoid ponding, especially in sloping areas.

- Do not locate and construct roads with fills on slopes greater than 60 percent. When necessary to construct roads across slopes that exceed the angle of repose, use full-bench construction and/or engineered bin walls or other stabilizing techniques.
- Use full-bench construction and removal of fill material to a suitable location when constructing road prisms on sideslopes greater than 60 percent.
- Design cut-and-fill slopes to be at stable angles, or less than the normal angle of repose, to minimize erosion and slope failure potential.

The degree of steepness that can be obtained is determined by the stability of the soil (Rothwell, 1978). Figure 3-4 depicts proper cut-and-fill construction. Table 3-9 presents an example of stable backslope and fill slope angles for different soil materials.

- Use retaining walls, with properly designed drainage, to reduce and contain excavation and embankment quantities (Larse, 1971). Vertical banks may be used without retaining walls if the soil is stable and water control structures are adequate.
- Balance excavation and embankments to minimize the need for supplemental building material and to maximize road stability.
- Do not use road fills at drainage crossings as water impoundments unless they have been designed as an earthfill dam that may be subject to section 404 requirements. These earthfill embankments should have outlet controls to allow draining prior to runoff periods and should be designed to pass flood flows.

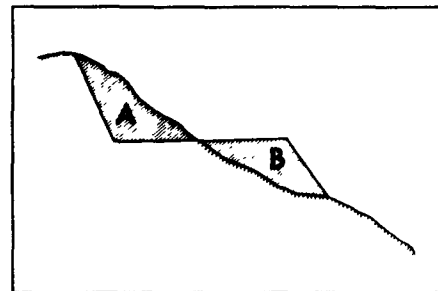

Figure 3-4. Typical side-hill cross section illustrating how cut material, A, equals fill material, B (Rothwell, 1978).

- Allow time after construction for disturbed soil and fill material to stabilize prior to use (Huff and Deal, 1982). Roads should be compacted and stabilized prior to use. This will reduce the amount of maintenance needed during and after harvesting activities (Kochenderfer, 1970).

Table 3-9. Stable Back Slope and Fill Slope Angles for Different Soil Materials (Rothwell, 1978)

Back Slopes		Fill Slopes	
Flat ground cuts under 0.9 m	2:1	Common for most soil types	1½:1
Most soil types with ground slopes <55%	1:1	Alluvial soils	2:1
Most soil types with ground slopes >55%	¾:1	Ballast	1:1
Hardpan or soft rock	½:1	Clay	4-1:1
Solid rock	¼:1	Rock, crushed	1-¼:1
		Gravel	1:1
		Sand, moist	1½-1:1
		Sand, saturated	2:1
		Shale	1½:1

■ *Use existing roads, whenever practical, to minimize the total amount of construction necessary.*

Do not plan and construct a road when access to an existing road is available on the opposite side of the drainage. This practice will minimize the amount of new road construction disturbance. However, avoid using existing or past road locations if they do not meet needed road standards (Swift, 1985).

■ *Minimize the number of stream crossings for roads and skid trails. Stream crossings should be designed and sited to cross drainages at 90° to the streamflow.*

■ *Locate stream crossings to minimize channel changes and the amount of excavation or fill needed at the crossing (Furniss et al., 1991). Apply the following criteria to determine the locations of stream crossings (Hynson et al., 1982):*

- Use a streambed with a straight and uniform profile above, at, and below the crossing;
- Locate crossing so the stream and road alignment are straight in all four directions;
- Cross where the stream is relatively narrow with low banks and firm, rocky soil; and
- Avoid deeply cut streambanks and soft, muddy soil.

■ *Choose stream-crossing structures (bridges, culverts, or fords) with the structural capacity to safely handle expected vehicle loads with the least disturbance to the watercourse. Consider stream size, storm frequency and flow rates, intensity of use (permanent or temporary), water quality, and habitat value, and provide for fish passage.*

■ *Select the waterway opening size to minimize the risk of washout during the expected life of the structure.*

Bridges or arch culverts, which retain the natural stream bottom and slope, are preferred over pipe culverts for streams that are used for fish migrating or spawning areas (Figures 3-5 and 3-6). Fish passage may be provided in streams that have wide ranges of flow by providing multiple culverts (Figure 3-7).

■ *Design culverts and bridges for minimal impact on water quality. Size small culverts to pass the 25-year flood, and size major culverts to pass the 50-year flood. Design major bridges to pass the 100-year flood.*

■ *The use of fords should be limited to areas where the streambed has a firm rock or gravel bottom (or where the bottom has been armored with stable material), where the approaches are both low and stable enough to support traffic, where fish are not present during low flow, and where the water depth is no more than 3 feet (Ontario Ministry of Natural Resources, 1988; Hynson et al., 1982).*

■ *For small stream crossings on temporary roads, the use of temporary bridges is recommended.*

Temporary bridges usually consist of logs bound together and suspended above the stream, with no part in contact with the stream itself. This prevents streambank erosion, disturbance of stream bottoms, and excessive turbidity (Hynson et al., 1982). Provide additional capacity to accommodate debris loading that may lodge in the structure opening and reduce its capacity.

■ *When temporary stream crossings are used, remove culverts and log crossings upon completion of operations.*

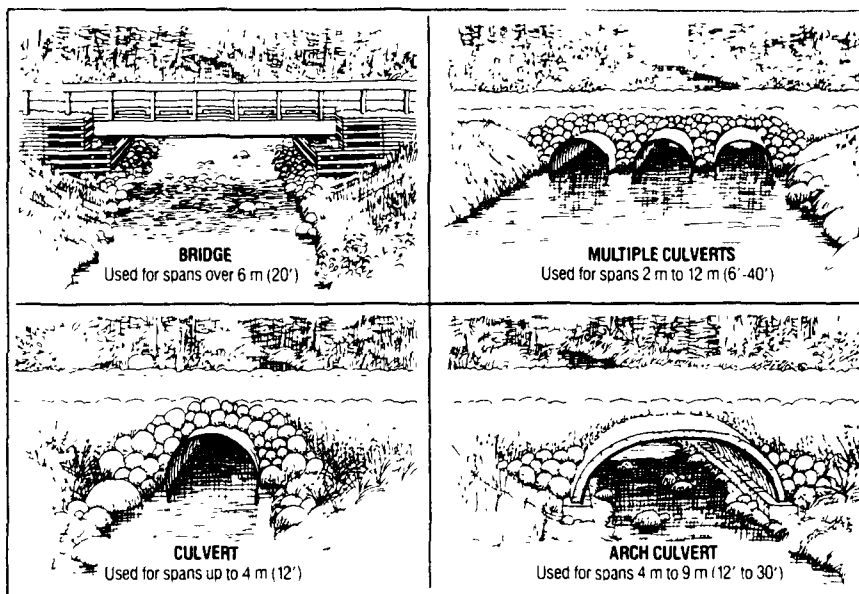

Figure 3-5. Alternative water crossing structures (Ontario Ministry of Natural Resources, 1988).

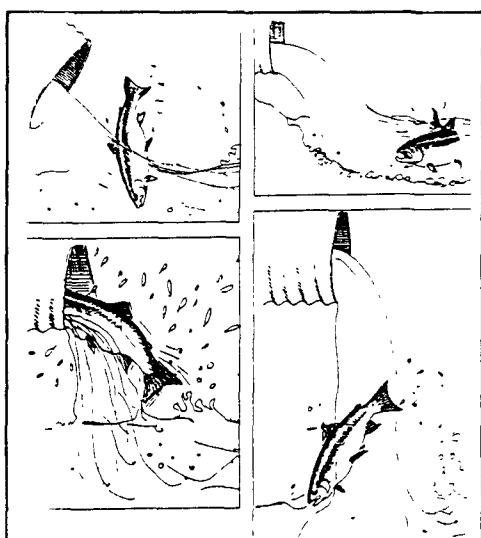

Figure 3-6. Culvert conditions that block fish passage (Yee and Roelofs, 1980).

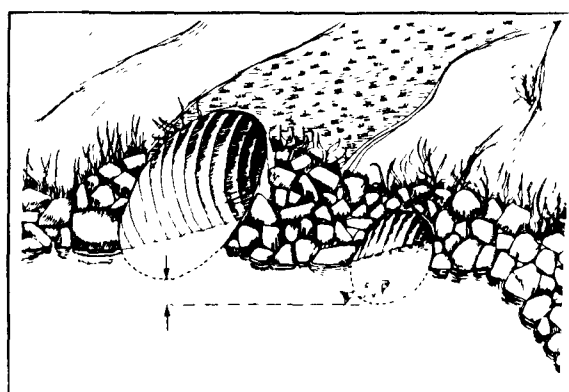

Figure 3-7. Multiple culverts for fish passage in streams that have wide ranges of flows (Hynson et al., 1982).

■ Springs flowing continuously for more than 1 month should have drainage structures rather than allowing road ditches to carry the flow to a drainage culvert.

■ Most forest roads should be surfaced, and the type of road surface will usually be determined by the volume and composition of traffic, the maintenance objectives, the desired service life, and the stability and strength of the road foundation (subgrade) material (Larse, 1971).

Figure 3-8 compares roadbed erosion rates for different surfacing materials.

- Surface roads (with gravel, grass, wood chips, or crushed rocks) where grades increase the potential for surface erosion.
- Use appropriately sized aggregate, appropriate percent fines, and suitable particle hardness to protect road surfaces from rutting and erosion under heavy truck traffic during wet periods. Ditch runoff should not be visibly turbid during these conditions. Do not use aggregate containing hazardous materials or high sulfide ores.
- Plan water source developments, used for wetting and compacting roadbeds and surfaces, to prevent channel bank and streambed impacts. Access roads should not provide sediment to the water source.
- Many States currently utilize some process to ensure implementation of management practices. These processes are typically related to the planning phase of forestry operations and commonly involve some type of notification process. Some States have one or more processes in place which serve as notification mechanisms used to ensure implementation. These State processes are usually associated with either Forest Practices Acts, Erosion Control Acts, State Dredge and Fill or CWA Section 404 requirements, timber tax requirements, or State and Federal incentive and cost share programs. The examples of existing State processes below illustrate some of these which might also be used as mechanisms to ensure implementation of management measures.

Florida Water Management Districts require notification prior to conducting forestry operations that involve stream crossings. This is required in order to meet the requirements of a State Dredge and Fill general permit, comparable to a CWA section 404 requirement. This notification is usually done by mail, but at least one water management district also allows verbal notification for some types of operations by telephoning an answering machine. In Florida, notification is required for any crossing of "Waters of the State," including wetlands, intermittent streams and creeks, lakes, and ponds. If any of these waters in the State are to be crossed during forestry operations, either by haul roads or by groundskidding, then notification is needed and State BMPs are required by reference in the general permit. Notification is usually provided by mailing in a notification sheet, which says who will conduct the operation and where it will be conducted (see Appendix 3A, Example 3A-1). In addition, information on what type of operation will be conducted, the name of a contact person, and a sketch of the site are included. Use of pesticides for forestry applications in Florida also requires licensing by the State Bureau of Pesticides.

The Oregon Forest Practice Rules require that the landowner or operator notify the State Forester at least 15 days prior to commencement of the following activities: (1) harvesting of forest tree species; (2) construction, reconstruction and improvement of roads; (3) application of pesticides and fertilizers; (4) site preparation for reforestation involving clearing or use of heavy machinery; (5) clearing forest land for conversion to any non-forest use; (6) disposal or treatment of slash; (7) pre-commercial thinning; and (8) cutting of firewood, when the firewood will be sold or used for

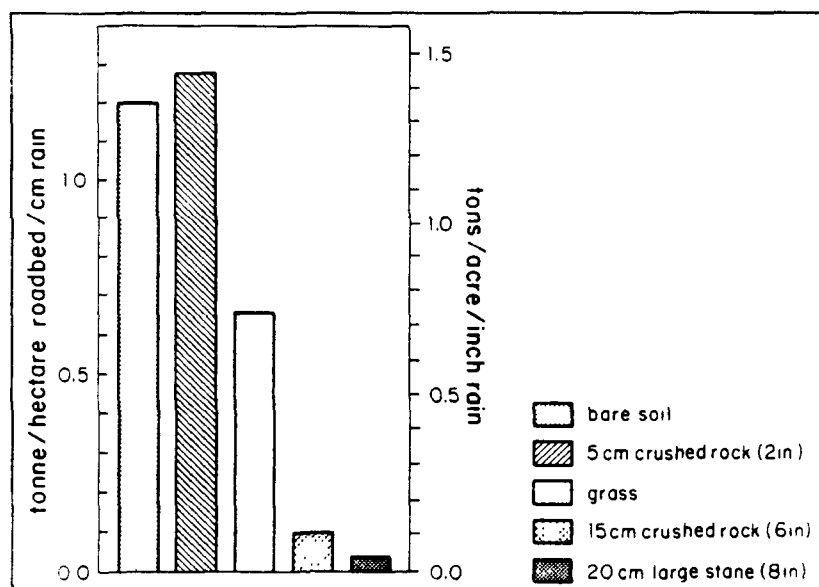

Figure 3-8. Soil loss rates for roadbeds with five surfacing treatments. Roads constructed of sandy loam saprolite (Swift, 1988).

barter. The State must approve the activity within 15 days and may require the submittal of a written plan. In addition, the preparation and submittal of a written plan is required for all operation within 100 feet of Class I waters, which are waters that support game fish or domestic uses, or within 300 feet of wetlands and sensitive wildlife habitat areas. Appendix 3A, Example 3A-2 contains a copy of Oregon's Notification of Operation/Application for Permit form. Oregon has developed a system of prioritization for the review and approval of these written plans. In Oregon, notification of intent to harvest is provided to the Department of Revenue through the Department of Forestry for purposes of tax collection. Additional permits for operation of power-driven machinery and to clear rights-of-way for road systems are also required.

New Hampshire does not have a Forest Practices Act, but does have a number of other State processes that serve as notification mechanisms for forestry activities. Prior to conducting forest harvesting, an Intent to Cut Application must be submitted to the Department of Revenue Administration (see Appendix 3A, Example 3A-3). This is required for the timber yield tax, and is filed in order to get a certificate for intent to cut. The Intent to Cut Application must be accompanied by an application for Filling, Dredging or Construction of Structures for those operations that involve the crossing of any freshwater wetland, intermittent or perennial stream, or other surface water. If the activity is not considered a minimum impact, a written plan must be submitted and approved before work may begin. Signature of these applications by the owner or operator adopts by reference the provisions of the State Best Management Practice Handbook. The State Erosion Control Act also requires notification for obtaining a permit for ground-disturbing activities greater than 100,000 square feet. This permit is required prior to commencement of operations. Another State process that entails notification is the provisions for the prevention of pollution from terrain alteration. These provisions require the submission of a plan 30 days before conducting the transport of forest products in or on the border of the surface waters of the State or before significantly altering the characteristics of the terrain in such a manner as to impede the natural runoff or create an unnatural runoff. The State must grant written permission before operations of this type may take place. Each of these existing State mechanisms entails the notification of the State prior to conducting forestry operations. Pesticides licensing is also necessary if the forestry operation involves the application of herbicides or insecticides.

B. Streamside Management Areas (SMAs)

Establish and maintain a streamside management area along surface waters, which is sufficiently wide and which includes a sufficient number of canopy species to buffer against detrimental changes in the temperature regime of the waterbody, to provide bank stability, and to withstand wind damage. Manage the SMA in such a way as to protect against soil disturbance in the SMA and delivery to the stream of sediments and nutrients generated by forestry activities, including harvesting. Manage the SMA canopy species to provide a sustainable source of large woody debris needed for instream channel structure and aquatic species habitat.

1. Applicability

This management measure pertains to lands where silvicultural or forestry operations are planned or conducted. It is intended to apply to surface waters bordering or within the area of operations. SMAs should be established for perennial waterbodies as well as for intermittent streams that are flowing during the time of operation. For winter logging, SMAs are also needed for intermittent streams since spring breakup is both the time of maximum transport of sediments from the harvest unit and the time when highest flows are present in intermittent streams.

Under the Coastal Zone Act Reauthorization Amendments of 1990, States are subject to a number of requirements as they develop coastal nonpoint source programs in conformity with this measure and will have some flexibility in doing so. The application of this management measure by States is described more fully in *Coastal Nonpoint Pollution Control Program: Program Development and Approval Guidance*, published jointly by the U.S. Environmental Protection Agency (EPA) and the National Oceanic and Atmospheric Administration (NOAA) of the U.S. Department of Commerce.

2. Description

The streamside management area (SMA) is also commonly referred to as a streamside management zone (SMZ) or as a riparian management area or zone. SMAs are widely recognized to be highly beneficial to water quality and aquatic habitat. Vegetation in SMAs reduces runoff and traps sediments generated from upslope activities, and reduces nutrients in runoff before it reaches surface waters (Figure 3-9, Kundt and Hall, 1988). Canopy species provide shading to surface waters, which moderates water temperature and provides the detritus that serves as an energy source for stream ecosystems. Trees in the SMA also provide a source of large woody debris to surface waters. SMAs provide important habitat for aquatic organisms (and terrestrial species) while preventing excessive logging-generated slash and debris from reaching waterbodies (Corbett and Lynch, 1985).

SMAs need to be of sufficient width to prevent delivery of sediments and nutrients generated from forestry activities (harvest, site preparation, or roads) in upland areas to the waterbody being protected. Widths for SMAs are established by considering the slope, soil type, precipitation, canopy, and waterbody characteristics. To avoid failure of SMAs, zones of preferential drainage such as intermittent channels, ephemeral channels and depressions need to be addressed when determining widths and laying out SMAs. SMAs should be designed to withstand wind damage or blowdown. For example, a single rank of canopy trees is not likely to withstand blowdown and maintain the functions of the SMA.

SMA should be managed to maintain a sufficient number of large trees to provide for bank stability and a sustainable source of large woody debris. Large woody debris is naturally occurring dead and down woody materials and should not be confused with logging slash or debris. Trees to be maintained or managed in the SMA should provide for large woody debris recruitment to the stream at a rate that maintains beneficial uses associated with fish habitat and stream structure at the site and downstream. This should be sustainable over a time period that is equivalent to that needed for the tree species in the SMA to grow to the size needed to provide large woody debris.

A sufficient number of canopy species should also be maintained to provide shading to the stream water surface needed to prevent changes in temperature regime for the waterbody and to prevent deleterious temperature- or sunlight-related impacts on the aquatic biota. If the existing shading conditions for the waterbody prior to activity are known to be less than optimal for the stream, then SMAs should be managed to increase shading of the waterbody.

To preserve SMA integrity for water quality protection, some States limit the type of harvesting, timing of operations, amount harvested, or reforestation methods used. SMAs are managed to use only harvest and silvicultural methods that will prevent soil disturbance within the SMA. Additional operational considerations for SMAs are addressed in subsequent management measures. Practices for SMA applications to wetlands are described in Management Measure J.

3. Management Measure Selection

a. Effectiveness Information

The effectiveness of SMAs in protecting streams from temperature increases, large increases in sediment load, and reduced dissolved oxygen was demonstrated by Hall and others (1987) (Table 3-10). Lantz (1971) (Table 3-11) also showed the protection that streamside vegetation and selective cutting gave to both water quality and the cutthroat trout population. A comparison of physical changes associated with logging using three streamside treatments was made by Hartman and others (1987) (Table 3-12). This study was performed to observe the impact of these SMAs on the supply of woody debris essential to the fish population and channel structure. The volume and stability of large woody debris decreased immediately in the most intensive treatment area, decreased a few years after logging in the careful treatment area, and remained stable where streamside trees and other vegetation remained.

Other experimental forest studies have found that average monthly maximum water temperature increases from 3.3 to 10.5 °C following clearcutting (Lynch et. al., 1985). Increases in stream temperature result from increased direct solar radiation to the water surface from the removal of vegetative cover or shading in the streamside area. Stream temperature change depends on the height and density of trees, the width of the waterbody, and the volume of water (stream discharge), with small streams heating up faster than large streams per unit of increased solar radiation (Megahan, 1980). Increased direct solar radiation also shifts the energy sources for stream ecosystems from outside the stream sources, allochthonous organic matter, to instream producers, autochthonous aquatic plants such as algae.

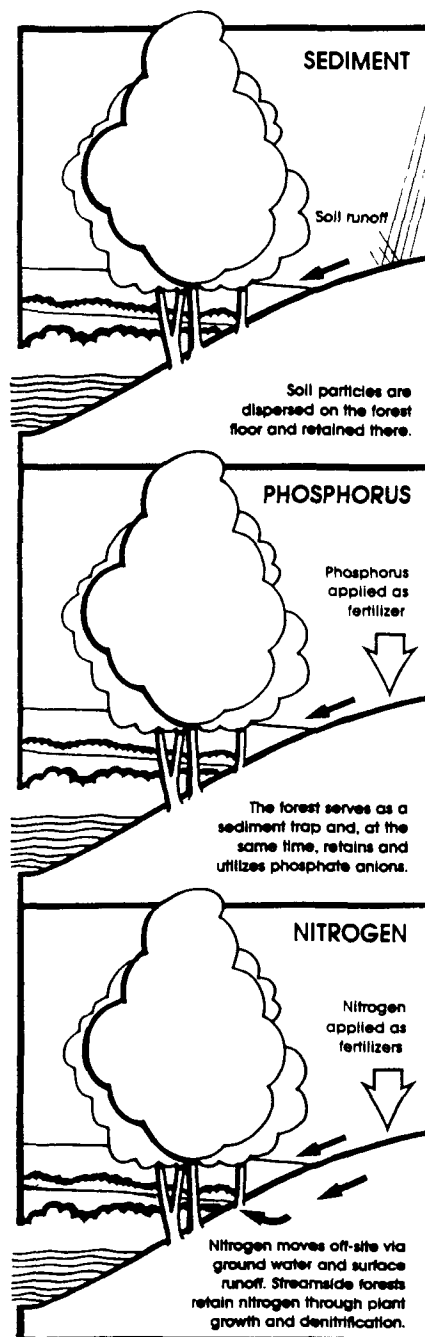

Figure 3-9. SMA pollutant removal processes (Kundt and Hall, 1988).

Table 3-10. Comparison of Effects of Two Methods of Harvesting on Water Quality (OR) (Hall et al., 1987)

Watershed	Method	Streamflow	Water Temp.	Sediment	Dissolved Oxygen
Deer Creek	Patch cut with buffer strips (750 acres)	No increase in peak flow	No change	Increases for one year due to periodic road failure	No change
Needle Branch	Clearcut with no stream protection (175 acres)	Small increases	Large changes, daily maximum increase by 30°F, returning to pre-log temp. within 7 years	Five-fold increase during first winter, returning to near normal the fourth year after harvest	Reduced by logging slash to near zero in some reaches; returned to normal when slash removed

Brown and Krygier (1970) report the greatest long-term average temperature response following clearcutting and slash disposal on a small watershed in Oregon. The average monthly temperature increased 14 °F compared to no increase on an adjacent, larger watershed that was clearcut in patches with 50- to 100-foot-wide buffer strips between the logging units and the perennial streams. Lynch and Corbett (1990) report less than a 3 °F mean temperature increase following harvesting, with 100-foot buffer strips along perennial streams. They attribute the increase to an intermittent stream with no protective vegetation that became perennial after harvesting due to increased flow. As a result of this BMP evaluation study, Pennsylvania modified its BMPs to require SMAs along both perennial and intermittent streams.

Another benefit of streamside management areas is control of suspended sediment and turbidity levels. Lynch and others (1985) documented the effectiveness of SMAs in controlling these pollutants (Table 3-13). A combination of practices was applied, including buffer strips and prohibitions for skidding, slash disposal, and road layout in or near streams. Average stormwater-suspended sediment and turbidity levels for the treatment without these practices increased significantly compared to the control and SMA/BMP sites.

Table 3-11. Water Quality Effects from Two Types of Logging Operations in the Aalsea Watershed (OR) (Lantz, 1971)

Watershed and Logging Method	Acreage	Oxygen Content	Temperature	Suspended Sediment	Cutthroat Trout Population
Needle Branch; clearcut, streamside vegetation removed	175	Decrease during summer due to debris in water	Increase of maximum from 61°F to 85°F	Increase (largest contribution from roads)	Decrease from 265 to 65 fish in stream ½ mile
Deer Creek; selection cut, streamside vegetation retained	750 30% harvested	Only minor changes, if any			
Flynn Creek; control	500	No changes			

**Table 3-12. Summary of Major Physical Changes Within Streamside Treatment Areas (BC)
(Hartman et al., 1987)**

	Streamside Treatment						
	Leave Strip ^a			Careful ^b	Intensive ^c		
	II	III	IV	VIII	V	VI	VII
Large Debris							
Mean volume (m ³ /30 m)							
Prelogging	29.6	34.2	37.4	14.3	25.4	26.0	78.2
Postlogging	29.5	50.4	36.4	14.7	23.2	20.0	19.5
Mean number of pieces							
Prelogging	34.0	27.3	32.0	14.2	25.0	25.3	19.8
Postlogging	36.5	27.0	30.0	20.9	27.5	36.2	23.0
Means of stability indices							
Prelogging							
Postlogging	54.7	53.0	84.4	82.0	80.2	93.1	98.9
	63.3	61.7	61.2	39.0	35.7	43.9	56.2
Small Debris							
Volume					Volume not		
Prelogging	--	--	--	--	measured but low.		--
Postlogging	--	--	--	--	Volume increased		--
					after logging and		
					reduced by 90%		
					after 1978 freshet.		

Sources: All results except those on substrate change are from Schultz International (1981) and Toews and Moore (1982). The results on substrate change are from Scrivener and Brownlee (1986).

^a Leave strip treatment included leaving a variable-width strip of vegetation along the stream.

^b Careful treatment involved clearcutting to the margin of the stream and felling of streambank alder, with virtually no in-channel activity.

^c Intensive treatment involved clearcutting to the streambank, felling of streambank alder, some yarding of felled trees, and merchantable blowdown from the stream.

**Table 3-13. Storm Water Suspended Sediment Delivery for Different Treatments (PA)
(Lynch, Corbett, and Mussallem, 1985)**

Water Year and Treatment	Annual Average Suspended Sediment in mg/l (Range)
1977	
Forested control	1.7(0.2 - 8.6)
Clearcut-herbicide	10.4(2.3 - 30.5)
Commercial clearcut with BMPs ^a	5.9(0.3 - 20.9)
1978	
Forested control	5.1(0.3 - 33.5)
Clearcut-herbicide	-- ^b (1.8 - 38.0)
Commercial clearcut with BMPs ^a	9.3(0.2 - 76.0)

^a Buffer strips, skidding in streams prohibited, slash disposal away from streams, skid trail and road layout away from streams.

^b Data not available.

Table 3-14. Average Changes in Total Coarse and Fine Debris of a Stream Channel After Harvesting (OR) (Froehlich, 1973)

Cutting Practice	Natural Debris	Material Added in Felling	% Increase
	(tons per hundred feet of channel)		
Conventional tree-felling	8.1	47	570
Cable-assisted directional felling	16	14	112
Conventional tree-felling with buffer strip ^a	12	1.3	14

^a Buffer strips ranged from 20 to 130 feet wide for different channel segments.

Practices such as directional felling are designed to minimize stream and streambank damage associated with increased logging debris in SMAs. Froehlich (1973) provides data on how effective different cutting practices and buffer strips are in preventing debris from entering the stream channel (Table 3-14). Buffer strips were the most effective debris barriers. Narver (1971) investigated the impacts of logging debris in streams on salmonid production and describes threats to fish embryo survival from low dissolved oxygen concentrations and decreased flow velocities in intragravel waters. Erman and others (1977) studied the effectiveness of buffer strips in protecting aquatic organisms and found significant differences in benthic invertebrate communities when logging occurred with buffer strips less than 30 meters wide.

b. Cost Information

In 4 of the 10 areas in Oregon studied by Dykstra and Froelich (1976a), the 55-foot buffer strip was the least costly alternative, yet these researchers concluded that no single alternative is preferable for all sites in terms of costs and that cost analysis alone cannot resolve the question of best stream protection method (Table 3-15).

Dykstra and Froehlich (1976b) also found that increased cable-assisted directional felling costs (68 to 108 percent increase) were offset by savings in channel clean-up costs (only 27 percent as much large debris and 39 percent small debris accumulated in the stream for cable-assisted felling), increased yield from reduced breakage, and reduced yarding costs. They also estimated costs for debris removal from streams to be \$300 to clean 5 tons of debris from a 100-foot segment, or about \$60 per ton of residue removed.

Table 3-15. Average Estimated Logging and Stream Protection Costs per MBF^a (OR) (Dykstra and Froehlich, 1976a)

Cutting Practice	Total Cost		Volume Foregone
	Average	Range	
Conventional felling	\$24.78	\$21.90 - 29.93	None
Cable-assisted directional felling (1.43% breakage saved within 200-foot stream)	\$26.05	\$21.36 - 31.24	--
Cable-assisted felling (10% breakage saved)	\$24.64	\$19.55 - 29.82	--
Buffer strip (55 feet wide)	\$23.34	\$19.84 - 27.77	0 to 6 percent
Buffer strip (150 feet wide)	\$27.15	\$24.33 - 30.28	6 to 17 percent

^a Cost estimates for each of 10 areas studied by Dykstra and Froehlich were averaged for this table.

Lickwar (1989) examined the costs of SMAs as determined by varying slope steepness (Table 3-16) in different regions in the Southeast and compared them to road construction and revegetation practice costs. He found SMAs to be the least expensive practice, in general, and to cost roughly the same independent of slope.

The costs associated with use of alternative buffer and filter strips were also analyzed in an Oregon case study (Olsen, 1987) (Table 3-17) and by Ellefson and Weible (1980). In the Oregon case study, increasing the buffer width from 35 feet on each side of a stream to 50 feet was shown to reduce the value per acre by \$103 undiscounted and \$75 discounted costs, approximately a 2 percent increase on a harvesting cost per acre of \$5,163 undiscounted and \$3,237 discounted. Doubling the buffer width from 35 to 70 feet on each side reduced the dollar value per acre by approximately 3 times more, adding approximately 8 percent to the discounted harvesting costs. Ellefson and Weible also analyzed the added cost and rate of return associated with various filter and buffer strip widths. Doubling the width of a filter strip from 30 to 60 feet increases the cost from \$12 to \$44 per sale and reduces the rate of return by 0.4 percent. Doubling the width of the buffer strip from 30 to 60 feet doubles the cost and reduces the rate of return by 1 percent. Increasing the width of the buffer strip from 30 to 100 feet triples the cost and reduces the rate of return by 2.3 percent.

4. Practices

As discussed more fully at the beginning of this chapter and in Chapter 1, the following practices are described for illustrative purposes only. State programs need not require implementation of these practices. However, as a practical matter, EPA anticipates that the management measure set forth above generally will be implemented by applying one or more management practices appropriate to the source, location, and climate. The practices set forth below have been found by EPA to be representative of the types of practices that can be applied successfully to achieve the management measure discussed above.

■ Generally, SMAs should have a minimum width of 35 to 50 feet. SMA width should also increase according to site-specific factors. The primary factors that determine the extension of SMA width are slope, class of watercourse, depth to water table, soil type, type of vegetation, and intensity of management.

Many States use SMAs. Examples of SMA designation strategies from Florida, North Carolina, Maine, and Washington are presented. Figure 3-10 depicts Florida's streamside management zone (SMZ) designations. Florida's SMZs are divided into a fixed-width primary zone and a variable secondary zone, each of which has its own special management criteria. Table 3-18 presents North Carolina's recommendations for SMZ widths for various types of waterbodies dependent on adjacent upland slope. Maine's recommended filter strip widths are dependent on the land

Table 3-16. Cost Estimates (and Cost as a Percent of Gross Revenues) for Streamside Management Areas (1987 Dollars) (Lickwar, 1989)

Practice Component	Steep Sites ^a		Moderate Sites ^b		Flat Sites ^c	
Streamside Management Zones	\$2,061.77	(0.52%)	\$2,397.80	(0.51%)	\$2,344.08	(0.26%)

^a Based on a 1,148-acre forest and gross harvest revenues of \$399,68. Slopes average over 9 percent.

^b Based on a 1,104-acre forest and gross harvest revenues of \$473,18. Slopes ranged from 4 percent to 8 percent.

^c Based on a 1,832-acre forest and gross harvest revenues of \$899,49. Slopes ranged from 0 percent to 3 percent.

**Table 3-17. Cost Impacts of Three Alternative Buffer Strips (OR)^a:
Case Study Results with 640-Acre Base (36 mbf/acre) (Olsen, 1987)**

	Scenario		
	I	II	III
Average buffer width (feet on each side)	35	50	70
Percent conifers removed	100	60	25
Percent reclassified Class II streams ^b	0	20	80
Harvesting restrictions	Current	New	New
<u>Road Construction</u>			
New miles	2.09	2.14	3.06
Road and landing acres	10.9	11.1	15.9
Cost total (1000's)	\$96.00	\$102.00	\$197.00
Cost/acre	\$149.00	\$160.00	\$307.00
<u>Harvesting Activities^c</u>			
mmbf harvested	22.681	22.265	20.277
Acres harvested	638.3	635.5	633.1
Cost total (1000's)	\$3,104.00	\$3,101.00	\$2,842.00
Cost/acre	\$4,841.00	\$4,835.00	\$4,432.00
Cost/mbf	\$136.87	\$139.26	\$140.17
<u>Inaccessible Area and Volume</u>			
Percent area in buffers	1.3	3.9	14.0
mmbf left in buffers	0.000	0.313	2.214
Acres unloggable	1.44	4.32	6.72
mmbf lost to roads and landings	0.202	0.205	0.295
<u>Undiscounted Costs (1000's)</u>			
Road cost	\$96.00	\$102.00	\$197.00
Harvesting cost	\$3,104.00	\$3,101.00	\$2,842.00
Value of volume foregone ^d	\$38.00	\$101.00	\$413.00
Total	\$3,238.00	\$3,304.00	\$3,451.00
Cost/acre	\$5,060.00	\$5,163.00	\$5,393.00
Reduced dollar value/acre	—	\$103.00	\$323.00
<u>Discounted Costs</u>			
Cost with 4% discount rate (1000's)	\$2,023.00	\$2,071.00	\$2,195.00
Cost/acre	\$3,162.00	\$3,237.00	\$3,431.00
Reduced value/acre	—	\$75.00	\$269.00

mmbf = million board feet; mbf = thousand board feet

^a 1986 dollars.

^b Generally, only Class I streams are buffered.

^c Includes felling, landing construction and setup, yarding, loading, and hauling.

^d Volume foregone x net revenue (\$150/mbf).

slope between the road and waterbody (Table 3-19). Washington State requires a riparian management zone (RMZ) around all Type 1, 2, and 3 waters where the adjacent harvest cutting is a regeneration cut or a clearcut. A guide for calculating the average width of the RMZ is provided in the Forest Practices Board manual (Washington State Forest Practices Board, 1988)(Figure 3-11).

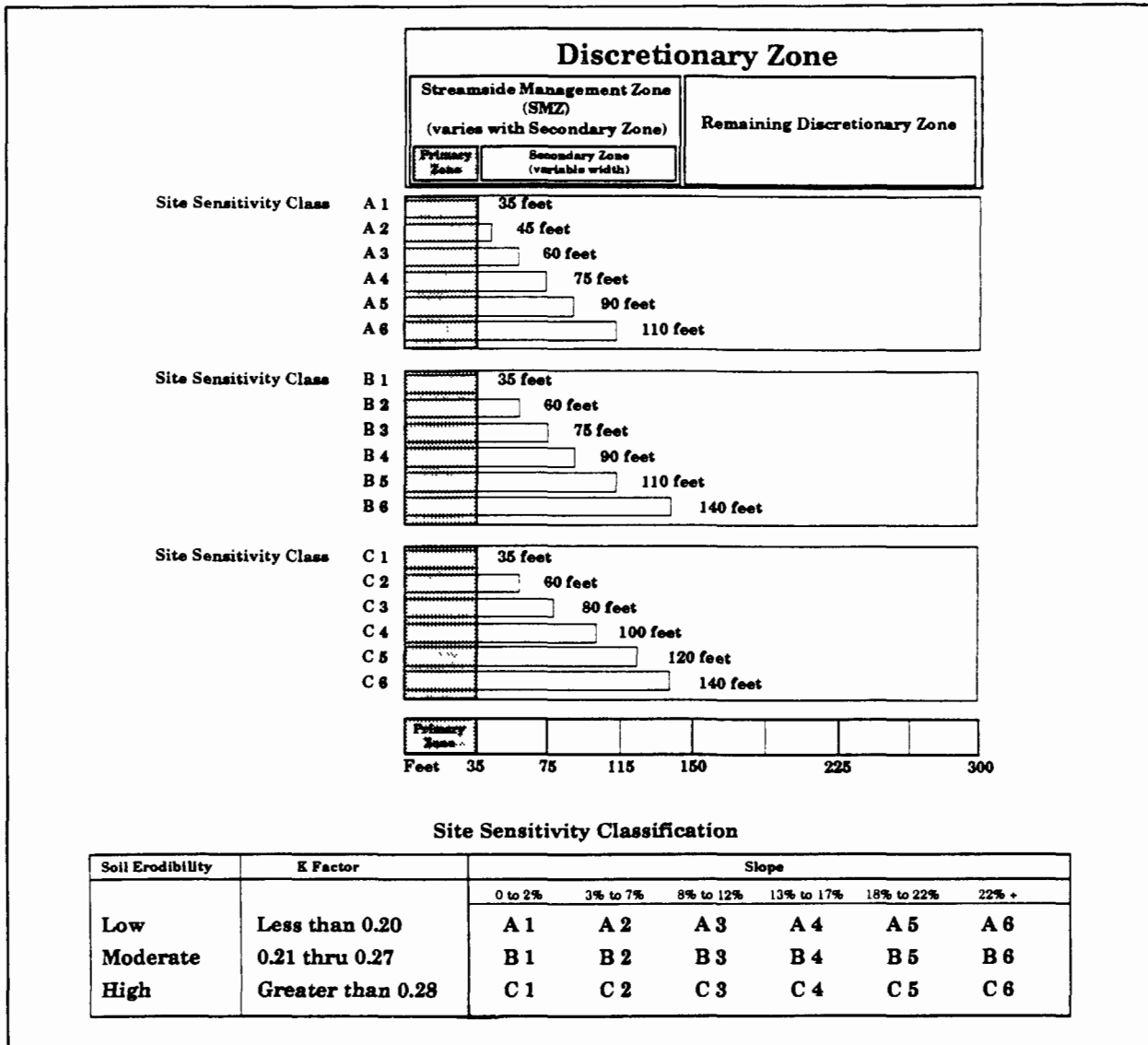

Figure 3-10. Florida's streamside management zone widths as defined by the Site Sensitivity Classification (Florida Department of Agriculture and Consumer Services, Division of Forestry, 1991).

- Minimize disturbances that would expose the mineral soil of the SMA forest floor. Do not operate skidders or other heavy machinery in the SMA.
- Locate all landings, portable sawmills, and roads outside the SMA.
- Restrict mechanical site preparation in the SMA, and encourage natural revegetation, seeding, and handplanting.
- Limit pesticide and fertilizer usage in the SMA. Buffers for pesticide application should be established for all flowing streams.

**Table 3-18. Recommended Minimum SMZ Widths
(North Carolina Division of Forest Resources, 1989)**

Type of Stream or Waterbody	Percent Slope of Adjacent Lands				
	0-5	6-10	11-20	21-45	46+
	SMZ Width Each Side (feet)				
Intermittent	50	50	50	50	50
Perennial	50	50	50	50	50
Perennial Trout Waters	50	66	75	100	125
Public Water Supplies (Streams and Reservoirs)	50	100	150	150	200

■ *Directionally fell trees away from streams to prevent logging slash and organic debris from entering the waterbody.*

■ *Apply harvesting restrictions in the SMA to maintain its integrity.*

Enough trees should be left to maintain shading and bank stability and to provide woody debris. This provision for leaving residual trees can be accomplished in a variety of ways. For example, the Maine Forestry Service (1991) specifies that no more than 40 percent of the total volume of timber 6 inches DBH and greater should be removed in a 10-year period, and the trees removed should be reasonably distributed within the SMA. Florida (1991) recommends leaving a volume equal to or exceeding one-half the volume of a fully stocked stand. The number of residual trees varies inversely with their average diameter (Table 3-20). A shading requirement independent of the volume of timber may be necessary for streams where temperature changes could alter aquatic habitat.

Studies by Brazier and Brown (1973) demonstrated that the effectiveness of the SMA in controlling temperature changes is independent of timber volume; it is a complex interrelationship between canopy density, canopy height, stream width, and stream discharge. The Washington State Forest Practices Board (1988) incorporates leave tree and shade requirements in its regulations (Figure 3-12). Shade requirements within the SMA are to leave all nonmerchantable timber that provides midsummer and midday shade to the water surface, and to leave sufficient merchantable timber necessary to retain 50 percent of the summer midday shade. Shade cover is preferably left distributed evenly within the SMA (Figure 3-13). If a threat of blowdown exists, then clumping and clustering of leave trees may be used as long as the shade requirement is met (Figure 3-14).

Table 3-19. Recommendations for Filter Strip Widths (Maine Forest Service, 1991)

Slope of Land (%)	Width of Strip (ft along ground)
0	25
10	45
20	65
30	85
40	105
50	125
60	145
70	165

Guidelines for Calculating Average Width of Riparian Management Zones (RMZ)

Use the following procedures to calculate average width of Eastern Washington riparian management zone (RMZ) when the adjacent harvest cutting is a regeneration cut or clearcut. Average RMZ width is also used to calculate the acreage and number of trees/acre. (See WAC 222-16-010(33) Partial Cut.)

Procedures

1. RMZs are measured separately on each side of streams. Begin at the ordinary high water mark of Type 1, 2 and 3 Waters and measure the horizontal distance to the line where vegetation changes from wetland to upland type, EXCEPT where the distance is less than the minimum or greater than the maximum widths in the rules. (See 7 below and Figure 14.)
2. Width measurements (horizontal distance) are taken at right angles to the stream reach. See WAC 222-30-020(6) for description of Eastern Washington RMZ. Western Washington RMZ is described in WAC 222-30-020(5).
3. Measure width of RMZ at 5 or more similarly spaced intervals.
4. Use 50 feet or greater distance between width measurements. Sample the entire stream reach within the harvest unit.
5. On each end of the stream reach being measured, begin and end width measurements at one-half the interval used for the other measurements. This helps to reduce sampling errors.
6. If the RMZ width varies more than 30 feet in a set of measurements, increase the number of measurements. Try for uniform sampling. Use enough measurements to adequately sample natural variations in width. (See Figure 14.)
7. On Eastern Washington PARTIAL CUTS, a width of less than 30 feet is noted as 30 feet and a width of more than 50 feet is noted as 50 feet when calculating the average RMZ width for leave trees/acre because these distances are specified in the rules. The natural riparian area may be wider or narrower than stated in the rules.

For other types of cuts, minimum width is measured in the same way as for partial cuts. But the actual width of more than 30 feet is noted up to a maximum of 300 feet. If the riparian area is wider than 300 feet, it is noted as 300 feet.
8. Calculate average width by totaling the widths in feet and dividing by the number of measurements.
9. In Eastern Washington where the adjacent harvest is a regeneration cut, RMZs must AVERAGE 50 feet in width.
10. Multiply average RMZ width by its length within the cutting unit to calculate square feet of RMZ. Measure length approximately parallel to stream reach and near outer edge of RMZ.
11. Multiply square feet by 0.000023 to calculate acres or see Acreage Table 6. (Figure 15 describes leave trees and snags for Eastern Washington RMZ.)

Figure 14. Eastern Washington Riparian Management Zone (RMZ)

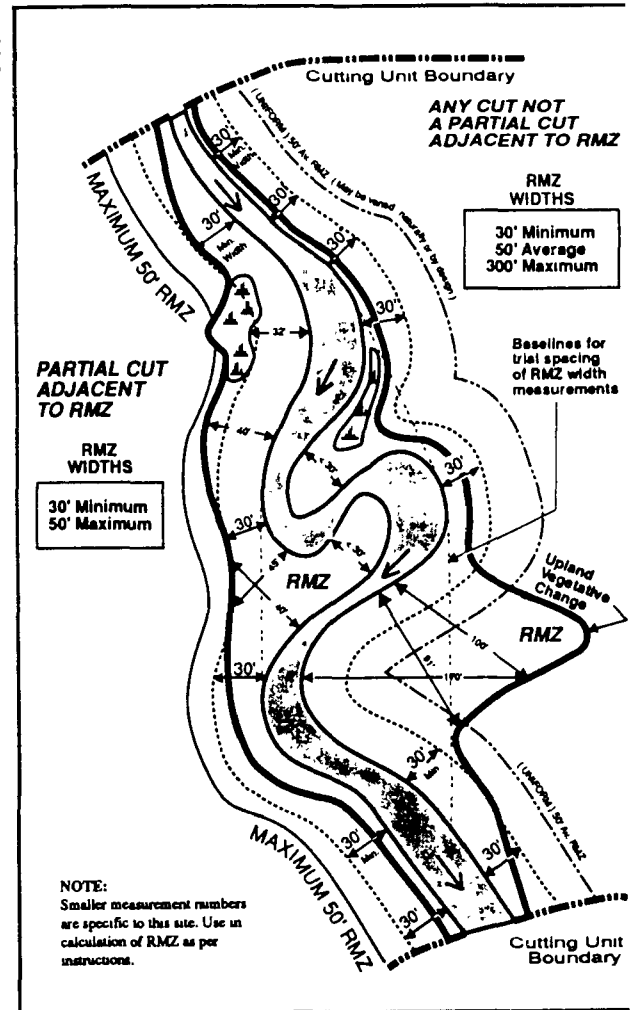

Figure 3-11. Guide for calculating the average width of the RMZ (Washington State Forest Practices Board, 1988).

Table 3-20. Stand Stocking in the Primary SMZ (Florida Department of Agriculture and Consumer Services, Division of Forestry, 1991)

Average Tree Size (DBH)	Minimum Number of Trees per 100 feet	Average Tree Spacing (feet)
Small (2" to 6")	18	14
Medium (8" to 12")	7	23
Large (14"+)	3	34

Design for Leave Trees and Snags/Acre - Type 1, 2 and 3 Water
(50 percent of ALL leave trees are to be live at completion of harvest.)

#/Ac.	Cond.	Species	Size by dbh	Other Design Criteria
All	Live	Trees	12" or less,	AND
All*	Dead	Snags	All, *(exc. those in viol. L & I Rules)	
			AND	
16	Live	Conifers	12 - 20" distr. x size repr. of stand,	
			AND	
3	Live	Conifers	20" or larger,	AND
[2	Live	Deciduous	Largest trees 16" & larger,	EXCEPT
[Where 2 Live Deciduous Trees 16" dbh & larger do NOT exist,	AND
[2 Dead Snags 20" dbh & larger do not exist,	
[SUBSTITUTE	
[2	Live	Conifers	20" or larger, IF these do NOT exist,	
[SUBSTITUTE	
[5	Live	Conifers	Largest available,	
[AND	
3	Live	Deciduous	12 - 16", IF they exist in the RMZ, AND	

ADDITIONAL Trees to Total the Minimum Number of Leave Trees:

Minimum Total Number of Leave Trees/Acre
(Includes Design Trees)

Adjacent Type of Cut*	Measured 1 Side Width of RMZ			Number of Trees/Acre by Type of Bed	
	Min.	Max.	AV.	Gravel/Cobble (<10" diameter)	Boulder/Bedrock (& lake & pond)
Partial	30'	50'	DNA**	135, 4" dbh & >	75, 4" dbh & >
Other	30'	300'	50'	135, 4" dbh & >	75, 4" dbh & >

*(See definition, regeneration cuts of any type are NOT Partial.)
**Does not apply.

Figure 3-12. Washington State Forest Practices Board (1988) requirements for leave trees in the RMZ.

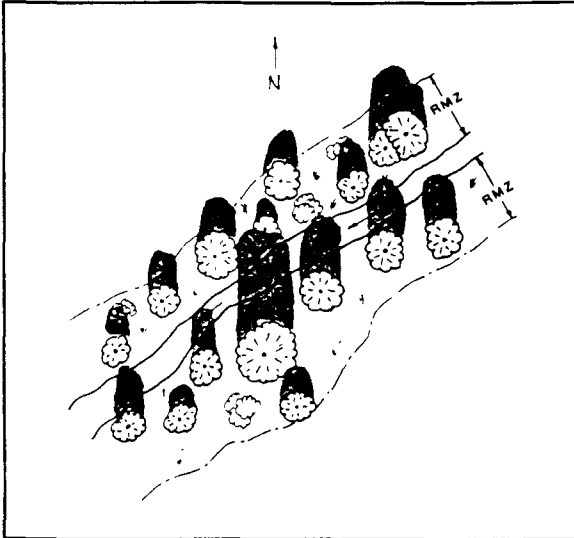

Figure 3-13. Uniform harvesting in the riparian zone (Washington State Forest Practices Board, 1988).

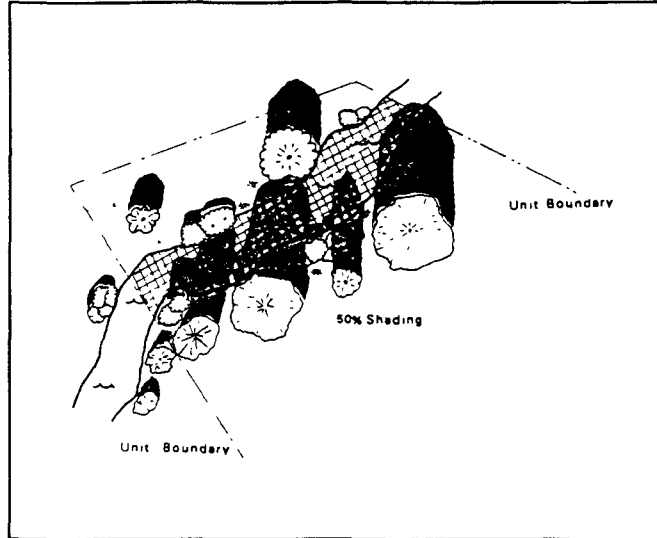

Figure 3-14. Vegetative shading along a stream course (Washington State Forest Practices Board, 1988).

C. Road Construction/Reconstruction

- (1) Follow preharvest planning (as described under Management Measure A) when constructing or reconstructing the roadway.
- (2) Follow designs planned under Management Measure A for road surfacing and shaping.
- (3) Install road drainage structures according to designs planned under Management Measure A and regional storm return period and installation specifications. Match these drainage structures with terrain features and with road surface and prism designs.
- (4) Guard against the production of sediment when installing stream crossings.
- (5) Protect surface waters from slash and debris material from roadway clearing.
- (6) Use straw bales, silt fences, mulching, or other favorable practices on disturbed soils on unstable cuts, fills, etc.
- (7) Avoid constructing new roads in SMAs to the extent practicable.

1. Applicability

This management measure is intended for application by States on lands where silvicultural or forestry operations are planned or conducted. It is intended to apply to road construction/reconstruction operations for silvicultural purposes, including:

- The clearing phase: clearing to remove trees and woody vegetation from the road right-of-way;
- The pioneering phase: excavating and filling the slope to establish the road centerline and approximate grade;
- The construction phase: final grade and road prism construction and bridge, culvert, and road drainage installation; and
- The surfacing phase: placement and compaction of the roadbed, road fill compaction, and surface placement and compaction (if applicable).

Under the Coastal Zone Act Reauthorization Amendments of 1990, States are subject to a number of requirements as they develop coastal nonpoint source programs in conformity with this measure and will have some flexibility in doing so. The application of this management measure by States is described more fully in *Coastal Nonpoint Pollution Control Program: Program Development and Approval Guidance*, published jointly by the U.S. Environmental Protection Agency (EPA) and the National Oceanic and Atmospheric Administration (NOAA) of the U.S. Department of Commerce.

2. Description

The goal of this management measure is to minimize delivery of sediment to surface waters during road construction/reconstruction projects. Figure 3-15 depicts various road structures addressed by this management measure. Disturbance of soil and rock during road construction/reconstruction creates a significant potential for erosion and sedimentation of nearby streams and coastal waters. Some roads are temporary or seasonal-use roads,

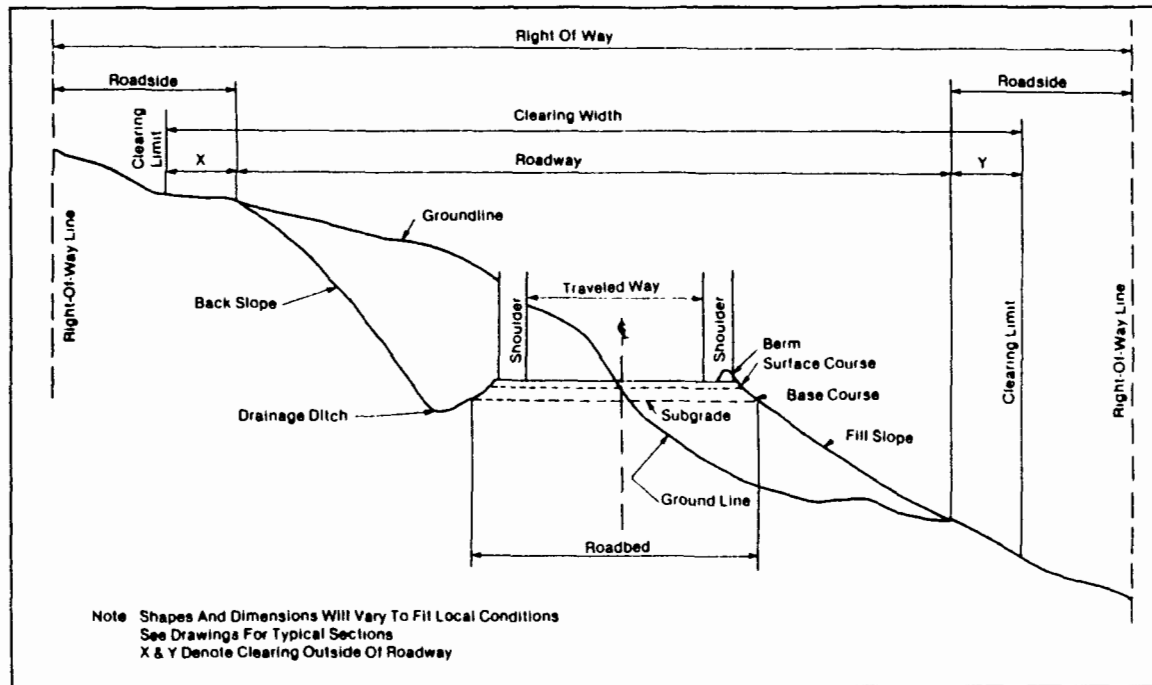

Figure 3-15. Illustration of road structure terms (Hynson et al., 1982).

and their construction does not involve the high level of disturbance generated by permanent, high-standard roads. However, temporary or low-standard roads still need to be constructed in such a way as to prevent disturbance and sedimentation. Brown (1972) stated that road construction is the largest source of silviculture-produced sediment in the Pacific Northwest. It is also a significant source in other regions of the country. Therefore, proper road and drainage crossing construction practices are necessary to minimize sediment delivery to surface waters. Proper road design and construction can prevent road fill and road backslope failure, which can result in mass movements and severe sedimentation. Proper road drainage prevents concentration of water on road surfaces, thereby preventing road saturation that can lead to rutting, road slumping, and channel washout (Dyrness, 1967; Golden et al., 1984). Proper road drainage during logging operations is especially important because that is the time when erosion is greatly accelerated by continuous road use (Kochenderfer, 1970). Figure 3-16 presents various erosion and sediment control practices.

Surface protection of the roadbed and cut-and-fill slopes can:

- Minimize soil losses during storms;
- Reduce frost heave erosion production;
- Restrain downslope movement of soil slumps; and
- Minimize erosion from softened roadbeds (Swift, 1984).

Although there are many commonly practiced techniques to minimize erosion during the construction process, the most meaningful are related to how well the work is planned, scheduled, and controlled by the road builder and those responsible for determining that work satisfies design requirements and land management resource objectives (Larse, 1971).

3. Management Measure Selection

Most erosion from road construction occurs within a few years of disturbance (Megahan, 1980). Therefore, erosion control practices that provide immediate results (such as mulching or hay bales) should be applied as soon as possible to minimize potential erosion (Megahan, 1980). King (1984) found that the amount of sediment produced by road construction was directly related to the percent of the area taken by roads, the amount of protection given to the seeded slopes, and whether the road is given a protective surface (Table 3-21).

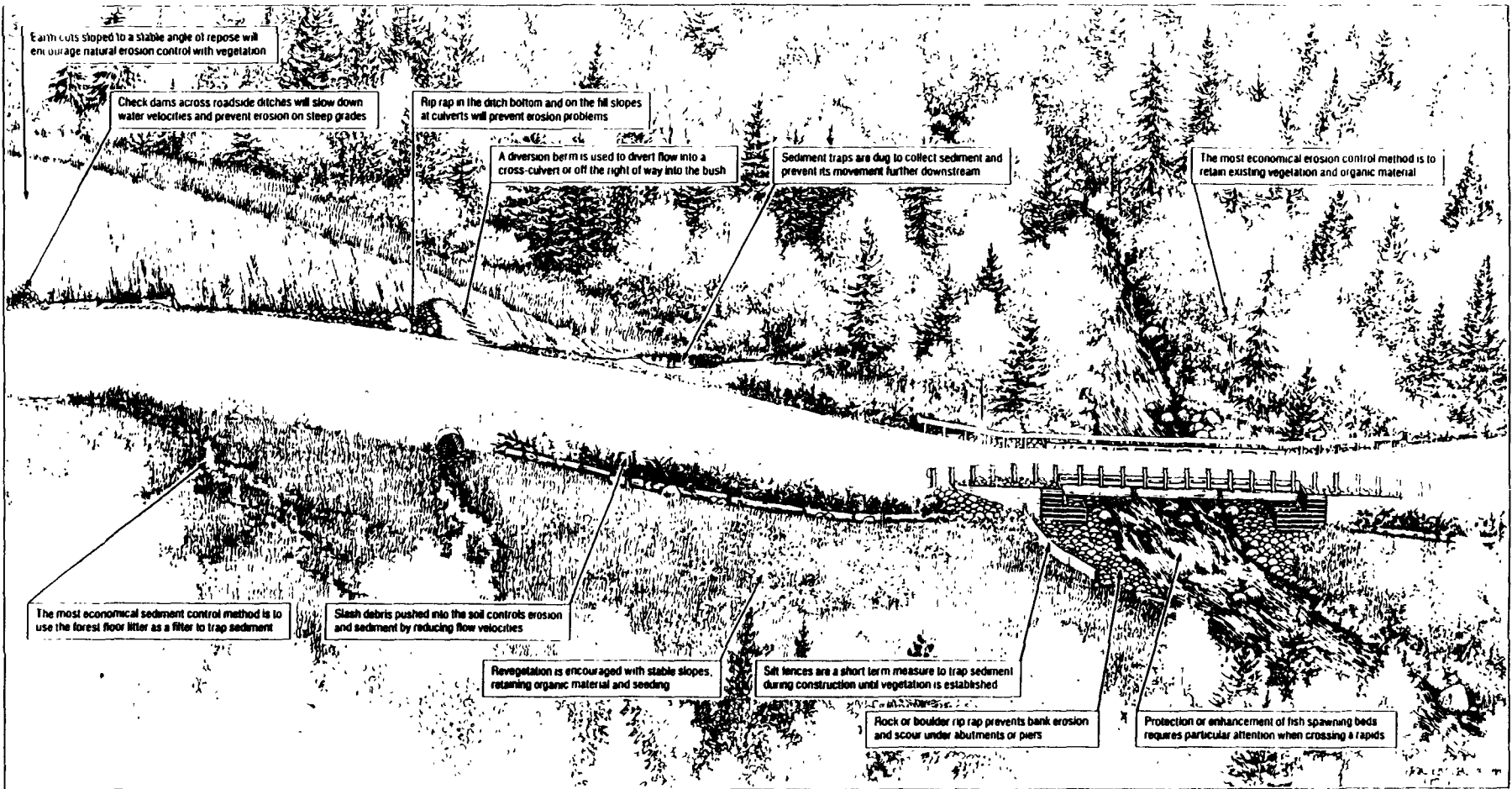

Figure 3-16. Mitigation techniques used for controlling erosion and sediment to protect water quality and fish habitat (Ontario Ministry of Natural Resources, 1988).

Table 3-21. Effects of Several Road Construction Treatments on Sediment Yield (ID) King (1984)

Watershed Area (acres)	Area in Roads (percent)	Treatment	Increase of Annual Sediment Yield ^a (percent)
207	3.9	Unsurfaced roads; Untreated cut slope; Untreated fill slope	156
161	2.6	Unsurfaced roads; Untreated cut slope dry seeded	130
364	3.7	Surfaced roads; Cut and fill slopes straw mulched and seeded	93
154	1.8	Surfaced roads; Filter windrowed; Cut and fill slopes straw mulched and seeded	53
70	3.0	Surfaced roads; Filter windrowed; Cut and fill slopes hydro-mulched and seeded	25
213	4.3	Surfaced roads; Filter windrowed; Cut and fill slopes hydro-mulched and seeded	19

^a Measured in debris basins.

a. Effectiveness Information

The effectiveness of road surfacing in controlling erosion was demonstrated by Kochenderfer and Helvey (1984)(Table 3-22). The data show that using 1-inch crusher-run gravel or 3-inch clean gravel can reduce erosion to less than one-half that of using 3-inch crusher run gravel and to 12 percent that of an ungraveled road surface.

According to Swift (1984b), road cuts and fills are the largest source of sediment once a logging road is constructed. His research showed that planting grass on cut-and-fill slopes of new roads effectively reduced erosion in the southern Appalachians. The combined effectiveness of grass establishment and roadbed graveling was a 97-99 percent reduction in soil loss.

Swift (1986) measured the extent of downslope soil movement for various categories of roadway and slope conditions (Tables 3-23 and 3-24). He found that grassed fill was more effective than mulched fill or bare fill in reducing the downslope movement of soil from newly constructed roads. The author determined grass, forest floor litter, and brush barriers to be effective management practices for reducing downslope sediment.

Megahan (1980, 1987) summarized the results of several studies that echo Swift's conclusions (Table 3-25). The combination of straw mulch with some type of netting to hold it in place reduces erosion by more than 90 percent and has the added benefits of providing immediate erosion control and promoting revegetation. Treating the road surface reduced erosion 70 to 99 percent. Grass seeding alone can control erosion in moist climates, as confirmed by Swift (1984b).

Table 3-22. Effectiveness of Road Surface Treatments in Controlling Soil Losses (WV) (Kochenderfer and Helvey, 1984)

Surface Treatment	Average Annual Soil Losses (tons/acre) ^a
3-inch clean gravel	5.4
Ungraveled	44.4
3-inch crusher-run gravel	11.4
1-inch crusher-run gravel	5.5

^a Six measurements taken over a 2-year time period.

b. Cost Information

The costs associated with construction of rolling dips on roads were estimated by Dubensky (1991) as \$19.75 each, with more dips needed as the slope of the road increases.

Ellefson and Miles (1984) determined the decline in net revenue associated with culvert construction, water bar construction, and construction of broad-based dips to be 3.8 percent, 2.3 percent, and 2.4 percent, respectively, for a timber sale with net revenue of \$124,340 without these practices. Kochenderfer and Wendel (1980) examined road costs, including bulldozing, construction of drainage dips, culvert installation, and graveling. They concluded that:

- (1) Cost to reconstruct a road (including 600 tons of 3-inch clean stone surfacing at \$5.74/ton) = \$5,855 *per mile*. Cost also included 20.5 hours (25 hours/mile) of D-6 tractor time (for road construction and construction of broad-based drainage dips), 23 hours (28 hours/mile) of JD 450 tractor time to spread gravel and do final dip shaping, and installation of two culverts. Road construction without the stone would have cost \$1,061/mile.
- (2) Cost for a newly constructed road was \$3,673 *per mile*, including 200 tons of gravel. Costs included 46.5 hours (57 hours/mile) of D-6 tractor time to bulldoze the road and construct 22 drainage dips. Spreading gravel and final dip shaping required 7.5 hours of JD tractor time. This road, constructed without stone, would have cost \$2,078 *per mile*.

The study concluded that road construction costs in terrain similar to the West Virginia mountain area would range from about \$2,000/mile with no gravel and few culverts to about \$10,000/mile with complete graveling and more frequent use of culverts.

Kochenderfer, Wendel, and Smith (1984) examined the costs associated with road construction of four minimum standard roads in the Appalachians (Table 3-8 gives road characteristics). Excavation costs varied according to site-specific factors (soil type, rock outcrop extent, topography) and increased as the amount of rock needing blasting and the number of large trees to be removed increased. Culvert costs varied according to the size and type of culvert used (Tables 3-26 and 3-27).

Lickwar (1989) studied the costs of various forestry practices in the Southeast. He determined that practices associated with road construction were generally the most expensive, regardless of terrain. The costs for broad-based dips and water bars increased as the terrain steepened, indicating increased implementation of erosion and runoff control practices as slopes increased (Table 3-28). Steeper areas also required additional (nonspecified) road costs that were not necessary in moderate to flat areas.

Table 3-23. Reduction in the Number of Sediment Deposits More Than 20 Feet Long by Grass and Forest Debris (Swift, 1986)

Degree of Soil Protection	Number of Deposits Per 1,000 Feet of Road
Grassed fill, litter and brush burned	13.9
Bare fill, forest litter	9.9
Mulched fill, forest litter	8.1
Grassed fill, forest litter, no brush barrier	6.9
Grassed fill, forest litter, brush barrier	4.5

Table 3-24. Comparison of Downslope Movement of Sediment from Roads for Various Roadway and Slope Conditions (Swift, 1986)

Comparisons	Sites (no.)	Mean Slope (%)	Distance (feet)		
			Mean	Max	Min
All sites	88	46	71	314	2
Barrier ^a					
Brush barriers	26	46	47	156	3
No brush barrier	62	47	81	314	2
Drainage ^b					
Culvert	21	40	80	314	30
Outsloped without culvert	56	47	63	287	2
Unfinished roadbed with berm	11	57	95	310	25
Grass fill and forest litter ^c	46	40	45	148	2
With brush barrier	16	39	34	78	3
With culvert	4	20	37	43	30
Without culvert	12	45	32	78	3
Without brush barrier	30	41	51	148	2
With culvert	7	37	58	87	30
Without culvert	23	42	49	148	2

^a Examined the effectiveness of leaving brush barriers in place below road fills, rather than removing brush barriers.

^b Compared roads where storm water was concentrated at a culvert pipe to outsloped roads without a culvert. The berm was constructed on an unfinished roadbed to prevent downslope drainage.

^c Compared effectiveness of brush barriers versus drainage (i.e., culvert) systems.

Table 3-25. Effectiveness of Surface Erosion Control on Forest Roads (Megahan, 1987, 1980)

Stabilization Measure	Portion of Road Treated	Percent Decrease in Erosion ^a	Reference
Tree planting	Fill slope	50	Megahan, 1974b
Hydromulch, straw mulch, and dry seeding ^b	Fill slope	24 to 58	King, 1984
Grass and legume seeding	Road cuts	71	Dyrness, 1970
Straw mulch	Fill slope	72	Bethlahmy and Kidd, 1966
Straw mulch	Road fills	72	Ohlander, 1964
Wood chip mulch	Road fills	61	Bethlahmy and Kidd, 1966
Wood chip mulch	Fill slope	61	Ohlander, 1964
Excelsior mulch	Fill slope	92	Burroughs and King, 1985
Paper netting	Fill slope	93	Ohlander, 1964
Asphalt-straw mulch	Fill slope	97	Ohlander, 1964
Straw mulch, netting, and planted trees	Fill slope	98	Megahan, 1974b
Straw mulch and netting	Fill slope	99	Bethlahmy and Kidd, 1966
Gravel surface	Road tread	70	Burroughs and King, 1985
Dust oil	Road tread	85	Burroughs and King, 1985
Bituminous surfacing	Road treated	99	Burroughs and King, 1985
Terracing	Cut slope	86	Unpublished data ^c
Straw mulch	Cut slope	32 to 47	King, 1984
Straw mulch	Cut slope	97	Dyrness, 1970

^a Percent decrease in erosion compared to similar, untreated sites.

^b No difference in erosion reduction between these three treatments.

^c Intermountain Forest and Range Experiment Station, Forestry Sciences Laboratory, Boise, ID.

Unit cost comparisons for surfacing practices (Swift, 1984a) reveal that grass is the least expensive alternative, at \$174 per kilometer of road (Table 3-29). Five-centimeter crushed rock cost almost \$2000 per kilometer, 15-centimeter gravel cost about \$6000, and 20-centimeter gravel cost almost \$9000. The author cautions, however, that material costs alone are misleading because an adequate road surface might endure several years of use, whereas a grassed or thinly-graveled surface would need replenishing. Even so, multiple grass plantings may be cheaper and more effective than gravel spread thinly over the roadbed, depending on climate, growing conditions, soil type, and road use (Swift, 1984b). Megahan (1987) found that dry seeding alone cost significantly less than seeding in conjunction with plastic netting (Table 3-30).

Table 3-26. Cost Summary for Four "Minimum-Standard" Forest Truck Roads Constructed in the Central Appalachians^a (1984 Dollars) (Kochenderfer, Wendel, and Smith, 1984)

Road No.	Costs (dollars/mile)			
	Excavation	Culvert	Labor & Vehicle	Total
1	2,900	371	1,092	5,048
6	4,200	1,043	1,947	7,805
7	5,650	1,143	2,116	9,629
8	3,950	0	722	5,457

^a Costs and time rounded to nearest whole number.

Table 3-27. Unit Cost Data for Culverts (Kochenderfer, Wendel, and Smith, 1984)

Culvert Type	Cost
15-inch gasline pipe (30-foot sections)	\$7.50/ft
15-inch galvanized	\$6.00/ft
18-inch galvanized	\$7.75/ft
36-inch galvanized	\$19.00/ft

Table 3-28. Cost Estimates (and Cost as a Percent of Gross Revenues) for Road Construction (1987 Dollars) (Lickwar, 1989)

Practice Component	Location					
	Steep Sites ^a		Moderate Sites ^b		Flat Sites ^c	
Stream crossings	\$31.74	(0.01%)	\$128.74	(0.03%)	\$2,998.74	(0.33%)
Broad-based dips	\$11,520	(2.88%)	\$7,040.00	(1.49%)	\$3,240.00	(0.36%)
Water bars	\$8,520	(2.13%)	\$4,440.00	(0.94%)	\$2,160	(0.24%)
Added road costs	\$3,990	(1.00%)	Not Provided		Not Provided	

^a Based on a 1,148-acre forest and gross harvest revenues of \$399,685. Slopes average over 9 percent.

^b Based on a 1,104-acre forest and gross harvest revenues of \$473,182. Slopes ranged from 4 percent to 8 percent.

^c Based on a 1,832-acre forest and gross harvest revenues of \$899,491. Slopes ranged from 0 percent to 3 percent.

Table 3-29. Cost of Gravel and Grass Road Surfaces (NC, WV) (Swift, 1984a)

Surface	Requirements/km	Unit Cost	Total Cost/km
Grass	28 kg Ky-31	\$0.840/kg	\$23.52
	14 kg rye	\$0.660/kg	\$9.24
	405 kg 10-10-10	\$0.121/kg	\$49.01
	900 kg lime	\$0.033/kg	\$29.70
	Labor and equipment	\$62.14/km	\$62.14
Crushed rock (5 cm) ^a	425 ton	\$4.680/ton	\$1,989
Crushed rock (15 cm) ^a	1,275 ton	\$4.680/ton	\$5,967
Large stone (20 cm) ^a	1,690 ton	\$5.240/ton	\$8,856

^a Values in parentheses are thickness or depth of surfacing material.

Table 3-30. Costs of Erosion Control Measures (ID) (Megahan, 1987)

Measure	Cost (\$/acre)
Dry seeding	124
Plastic netting placed over seeded area	5,662

Source: Haber, D.F., and T. Kadoch, 1982. Costs of Erosion Control Measures Used on a Forest Road in the Silver Creek watershed in Idaho, University of Idaho, Dept. of Civil Engineering.

4. Practices

As discussed more fully at the beginning of this chapter and in Chapter 1, the following practices are described for illustrative purposes only. State programs need not require implementation of these practices. However, as a practical matter, EPA anticipates that the management measure set forth above generally will be implemented by applying one or more management practices appropriate to the source, location, and climate. The practices set forth below have been found by EPA to be representative of the types of practices that can be applied successfully to achieve the management measure described above.

- *Follow the design developed during preharvest planning to minimize erosion by properly timing and limiting ground disturbance operations.*
- *Construct bridges and install culverts during periods when streamflow is low.*
- *Avoid construction during egg incubation periods on streams with important spawning areas.*
- *Practice careful equipment operation during road construction to minimize the movement of excavated material downslope as unintentional sidecast.*
- *Compact the road base at the proper moisture content, surfacing, and grading to give the designed road surface drainage shaping.*

■ Use straw bales, straw mulch, grass-seeding, hydromulch, and other erosion control and revegetation techniques to complete the construction project. These methods are used to protect freshly disturbed soils until vegetation can be established.

■ Prevent slash from entering streams or promptly remove slash that accidentally enters streams to prevent problems related to slash accumulations.

Slash can be useful if placed as windrows along the base of the fill slope. Right-of-way material that is merchantable can also be used by the operator.

■ Use turnouts, wing ditches, and dips to disperse runoff and reduce road surface drainage from flowing directly into watercourses.

■ Install surface drainage controls to remove stormwater from the roadbed before the flow gains enough volume and velocity to erode the surface. Route discharge from drainage structures onto the forest floor so that water will disperse and infiltrate (Swift, 1985). Methods of road surface drainage include:

- **Broad-based Dip Construction.** A broad-based dip is a gentle roll in the centerline profile of a road that is designed to be a relatively permanent and self-maintaining water diversion structure and can be traversed by any vehicle (Swift, 1985, 1988) (See Figure 3-17). The dip should be outsloped 3 percent to divert stormwater off the roadbed and onto the forest floor, where transported soil can be trapped by forest litter (Swift, 1988). Broad-based dips should be used on roads having a gradient of 10 percent or less. Proper construction requires an experienced bulldozer operator (Kochenderfer, 1970).
- **Installation of Pole Culverts and/or Ditch Relief Culverts.** Culverts are placed at varying intervals in a road to safely conduct water from the ditch to the outside portion of the road. Figures 3-18 and 3-19 highlight the design and installation of pole and pipe culverts, respectively. Culverts often need outlet and inlet protection to keep water from scouring away supporting material and to keep debris from plugging the culvert. Energy dissipators, such as riprap and slash, should be installed at culvert outlets (Rothwell, 1978). Culvert spacing depends on rainfall intensity, soil type, and road grade. Culvert size selection should be based on drainage area size and should be able to handle large flows. Open-top or pole culverts are temporary drainage structures that are most useful for intercepting runoff flowing down road surfaces (Kochenderfer, 1970). They can also be used as a substitute for pipe culverts on roads of smaller operations, if properly built and maintained, but they should not be used for handling intermittent or live streams. Open-top culverts should be placed at angles across a road to provide gradient to the culvert and to ensure that no two wheels of a vehicle hit the ditch at once.
- **Road Outsloping and Grading.** Grade and outslope roadbeds to minimize water accumulation on road surfaces (Kochenderfer, 1970). This practice minimizes erosion and road failure potential. Outsloping involves grading the road so that it slopes downward from the toe of the road cut to the shoulder. The

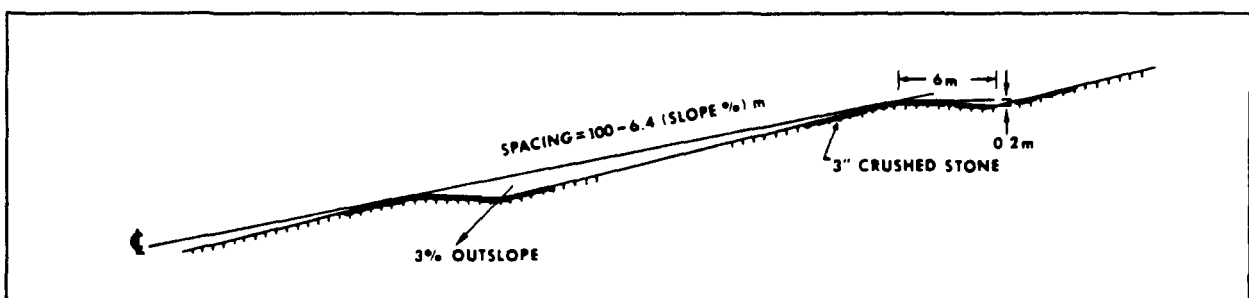

Figure 3-17. Diagram of broad-based dip design for forest access roads (Swift, 1985).

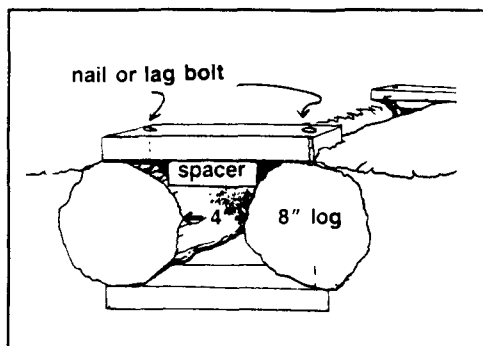

Figure 3-18. Design of pole culverts (Vermont Department of Forests, Parks and Recreation, 1987).

slope should be about 3-4 percent (Rothwell, 1978). Outsloping the roadbed keeps water from flowing next to and undermining the cut bank, and is intended to spill water off the road in small volumes at many random sites. In addition to outsloping the roadbed, a short reverse grade should be constructed to turn water off the surface. Providing a berm on the outside edge of an outsloped road during construction, and until loose fill material is protected by vegetation, can eliminate fill erosion (Swift, 1985). The effectiveness of outsloping is limited by roadbed rutting during wet conditions. Also, berms may form along the edge of older roadbeds and block drainage (Swift, 1985). Therefore, proper maintenance of these structures is necessary.

- **Ditch and Turnout Construction.** Ditches should be used only where necessary and should discharge water into vegetated areas through the use of turnouts. The less water ditches carry and the more frequently water is discharged, the better. Construct wide, gently sloping ditches, especially in areas with highly erodible soils. Ditches should be stabilized with rock and/or vegetation (Yoho, 1980) and outfalls protected with rock, brush barriers, live vegetation, or other means. Roadside ditches should be large enough to carry runoff from moderate storms. A standard ditch used on secondary logging roads is a triangular section 45 cm deep, 90 cm wide on the roadway side, and 30 cm wide on the cut bank side. Minimum ditch gradient should be 0.5 percent, but 2 percent is preferred to ensure good drainage. Runoff should be frequently diverted into culverts to prevent erosion or overflow (Rothwell, 1978).

■ *Install appropriate sediment control structures to trap suspended sediment transported by runoff and prevent its discharge into the aquatic environment.*

Methods to trap sediment include:

- **Brush Barriers.** Brush barriers are slash materials piled at the toe slope of a road or at the outlets of culverts, turnouts, dips, and water bars. Brush barriers should be installed at the toe of fills if the fills are located within 150 feet of a defined stream channel (Swift, 1988). Figure 3-20 shows the use of a brush barrier at the toe of fill. Proper installation is important because if the brush barrier is not firmly anchored and embedded in the slope, brush material may be ineffective for sediment removal and may detach to block ditches or culverts (Ontario Ministry of Natural Resources, 1988). In addition to use as brush barriers, slash can be spread over exposed mineral soils to reduce the impact of precipitation events and surface flow.
- **Silt Fences.** Silt fences are temporary barriers used to intercept sediment-laden runoff from small areas. They act as a strainer: silt and sand are trapped on the surface of the fence while water passes through.

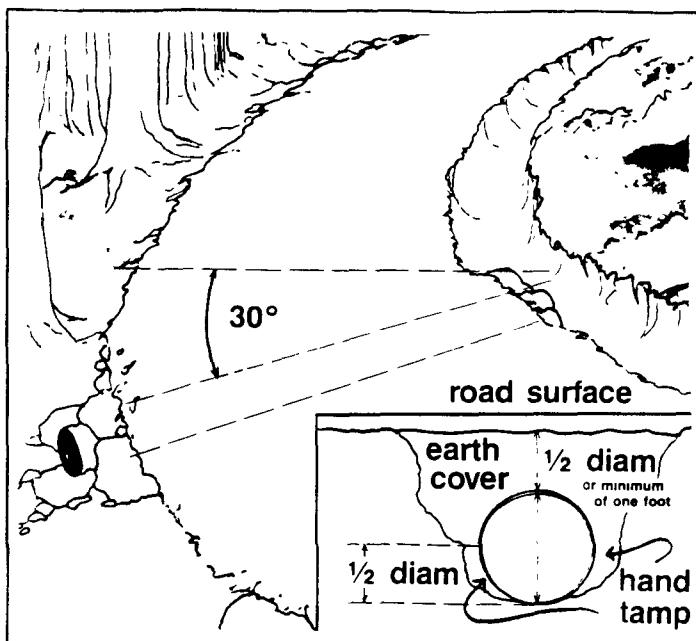

Figure 3-19. Design and installation of pipe culverts (Vermont Department of Forests, Parks and Recreation, 1987).

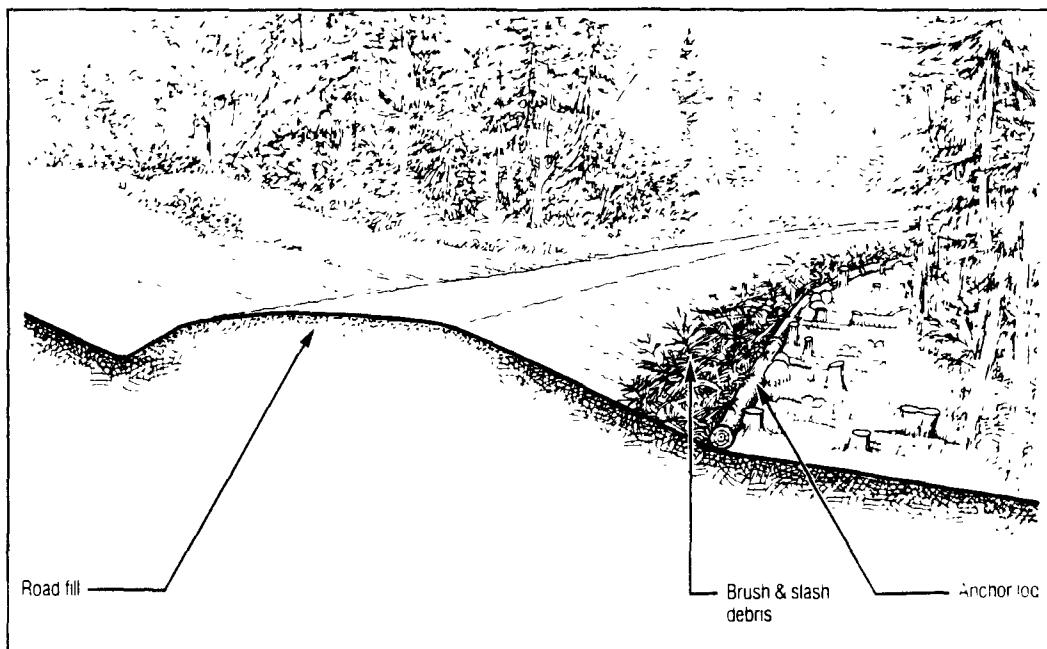

Figure 3-20. Brush barrier at toe of fill (Ontario Ministry of Natural Resources, 1988).

They may consist of woven geotextile filter fabric or straw bales. Silt fences should be installed prior to earthmoving operations and should be placed as close to the contour as possible.

- **Riprap.** Riprap is a layer of rocks or rock fragments placed over exposed soil to protect it from erosive forces. Riprap is generally used only in areas where the velocity of water flow, seriousness of erosion, steepness of slope, or material type prevents satisfactory establishment of vegetation. Stones of suitable size are fitted and implanted in the slope to form a contiguous cover (Figure 3-21). When used near streams, riprap should be extended below the stream channel scour depth and above the high water line. Commonly, a filter cloth or graded filter blanket of small gravel is laid beneath the riprap. Riprap should not be used on slopes that are naturally subject to deep-seated or avalanche-type slide failure. Riprap should be used in conjunction with other slope stabilization techniques and then only if these techniques are ineffective alone. Riprap is not recommended for very steep slopes or fine-grained soils (Hynson et al., 1982).
- **Filter Strips.** Sediment control is achieved by providing a filter or buffer strip between streams and construction activities in order to use the natural filtering capabilities of the forest floor and litter. The Streamside Management Area management measure requires the presence of a filter or buffer strip around all waterbodies.

■ **Revegetate or stabilize disturbed areas, especially at stream crossings.**

Cutbanks and fillslopes along forest roads are often difficult to revegetate (Berglund, 1978). Properly condition slopes to provide a seedbed, including rolling of embankments and scarifying of cut slopes. The rough soil surfaces will provide niches for seeds to lodge and germinate. Seed as soon as possible after disturbance, preferably during road construction or immediately following completion and within the same season (Larse, 1971). Early grassing and spreading of brush or erosion-resisting fabrics on exposed soils at stream crossings are imperative (Swift, 1985). See the Revegetation of Disturbed Areas management measure for a more detailed discussion.

■ **Protect access points to the site that lead from a paved public right-of-way with stone, wood chips, corduroy logs, wooden mats, or other material to prevent soil or mud from being tracked onto the paved road.**

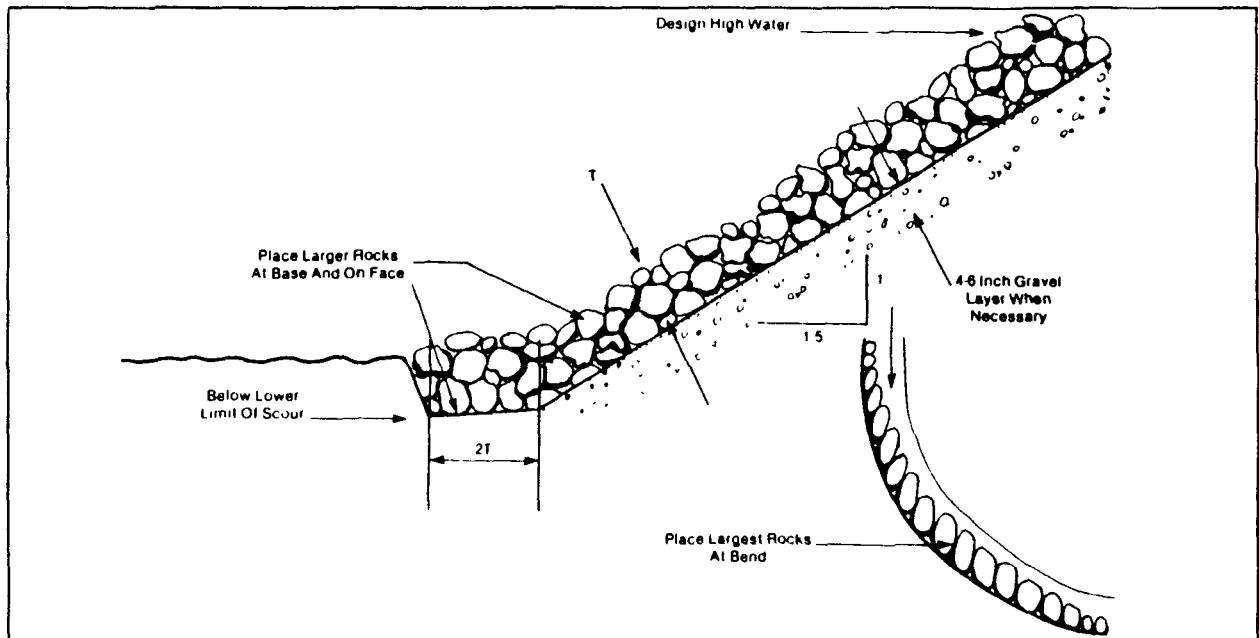

Figure 3-21. Dimensions of typical rock riprap blanket. T equals 1.5 times the diameter of the average size rock. When rock is spherical cobbles, or when machine-placed, $T=1.9D$ (Hynson et al., 1982).

This will prevent tracking of sediment onto roadways, thereby preventing the subsequent washoff of that sediment during storm events. When necessary, clean truck wheels to remove sediment prior to entering a public right-of-way.

■ **Construct stream crossings to minimize erosion and sedimentation.**

Avoid operating machinery in waterbodies. Work within or adjacent to live streams and water channels should not be attempted during periods of high streamflow, intense rainfall, or migratory fish spawning. Avoid channel changes and protect embankments with riprap, masonry headwalls, or other retaining structures (Larse, 1971).

If possible, culverts should be installed within the natural streambeds. The inlet should be on or below the streambed to minimize flooding upstream and to facilitate fish passage. Culverts should be firmly anchored and the earth compacted at least halfway up the side of the pipe to prevent water from leaking around it (Figure 3-22). Both ends of the culvert should protrude at least 1 foot beyond the fill (Hynson et al., 1982). Large culverts should be aligned with the natural course and gradient of the stream unless the inlet condition can be improved and the erosion potential reduced with some channel improvement (Larse, 1971). Use energy dissipators at the downstream end of the culverts to reduce the erosion energy of emerging water. Armor inlets to prevent undercutting and armor outlets to prevent erosion of fill or cut slopes.

■ **Excavation for a bridge or a large culvert should not be performed in flowing water. The water should be diverted around the work site during construction with a cofferdam or stream diversion.**

Isolating the work site from the flow of water is necessary to minimize the release of soil into the watercourse and to ensure a satisfactory installation in a dry environment. Limit the duration of construction to minimize environmental impacts by establishing disturbance limits, equipment limitations, the operational time period when disturbance can most easily be limited, and the use of erosion and sediment controls, such as silt fences and sediment catch basins. Diversions should be used only where constructing the stream crossing structure without diverting the stream would result in instream disturbance greater than the disturbance from diverting the stream. Figure 3-23 portrays a procedure for installing a large culvert when excavation in the channel of the stream would cause sedimentation and increase turbidity.

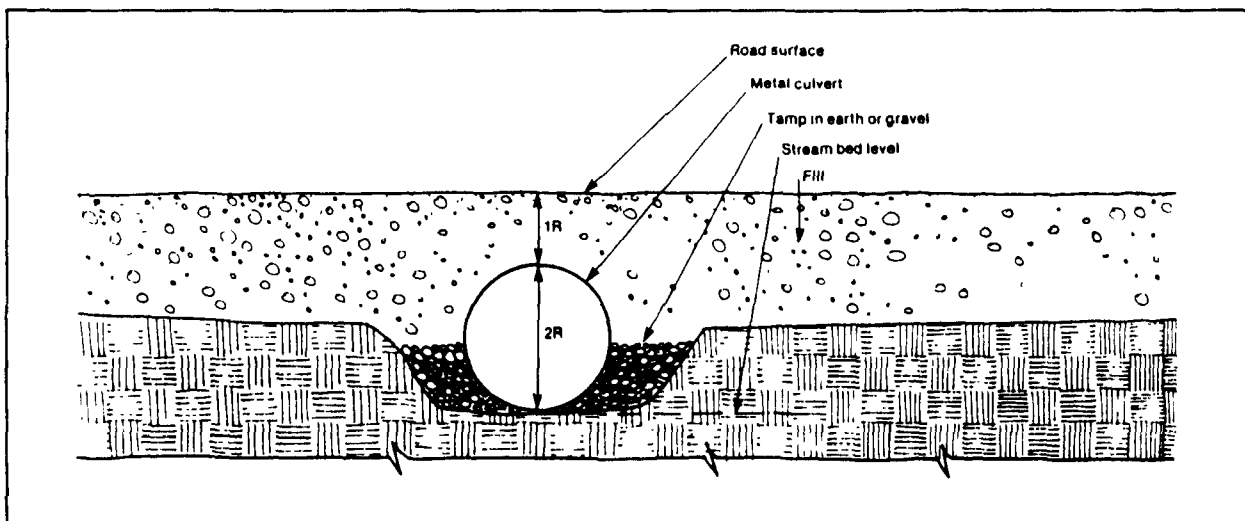

Figure 3-22. Culvert installation in streambed (Hynson et al., 1982).

■ **Compact the fill to minimize erosion and ensure road stability (Hynson et al., 1982).**

During construction, fills or embankments are built up by gradual layering. Compact the entire surface of each layer with a tractor or other construction equipment. If the road is to be grassed, the final layer should not be compacted in order to provide an acceptable seedbed.

■ **Properly dispose of organic debris generated during road construction (Hynson et al., 1982).**

- Stack usable materials such as timber, pulpwood, and firewood in suitable locations and use them to the extent possible. Alternatives for use of other materials include piling and burning, chipping, scattering, windrowing, and removal to designated sites.
- Organic debris should not be used as fill material for road construction since the organic material would eventually decompose and cause fill failure (Hynson et al., 1982; Larse, 1971).
- Debris that is accidentally deposited in streams during road construction should be removed before work is terminated.
- All work within the stream channel should be accomplished by hand to avoid the use of machinery in the stream and riparian zone (Hynson et al., 1982).

■ **Use pioneer roads to reduce the amount of area disturbed and ensure stability of the area involved.**

Pioneer roads are temporary access ways used to facilitate construction equipment access when building permanent roads.

- Confine pioneer roads to the construction limits of the surveyed permanent roadway.
- Fit the pioneer road with temporary drainage structures (Hynson et al., 1982).

■ **When soil moisture conditions are excessive, promptly suspend earthwork operations and take measures to weatherproof the partially completed work (Larse, 1971; Hynson et al., 1982).**

Regulating traffic on logging roads during unfavorable weather is an important phase of erosion control. Construction and logging under these conditions destroy drainage structures, plug up culverts, and cause excessive rutting, thereby increasing the amount and the cost of required maintenance (Kochenderfer, 1970).

- Locate burn bays away from water and drainage courses.
- If the use of borrow or gravel pits is needed during forest road construction, locate rock quarries, gravel pits, and borrow pits outside SMAs and above the 50-year flood level of any waters to minimize the adverse impacts caused by the resulting sedimentation. Excavation should not occur below the water table.

Gravel mining directly from streams causes a multitude of impacts including destruction of fish spawning sites, turbidity, and sedimentation (Hynson et al., 1982). During the construction and use of rock quarries, gravel pits, or borrow pits, runoff water should be diverted onto the forest floor or should be passed through one or more settling basins. Rock quarries, gravel pits, spoil disposal areas, and borrow pits should be revegetated and reclaimed upon abandonment.

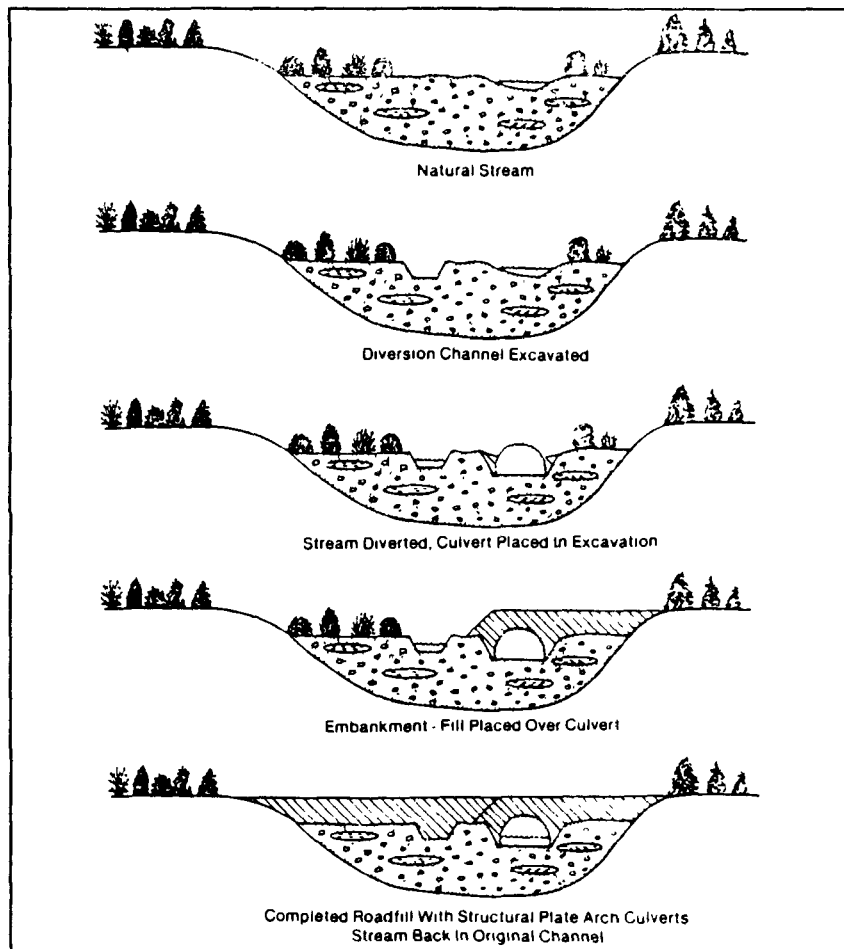

Figure 3-23. Culvert installation using a diversion (Hynson et al., 1982).

D. Road Management

- (1) Avoid using roads where possible for timber hauling or heavy traffic during wet or thaw periods on roads not designed and constructed for these conditions.
- (2) Evaluate the future need for a road and close roads that will not be needed. Leave closed roads and drainage channels in a stable condition to withstand storms.
- (3) Remove drainage crossings and culverts if there is a reasonable risk of plugging or failure from lack of maintenance.
- (4) Following completion of harvesting, close and stabilize temporary spur roads and seasonal roads to control and direct water away from the roadway. Remove all temporary stream crossings.
- (5) Inspect roads to determine the need for structural maintenance. Conduct maintenance practices, when conditions warrant, including cleaning and replacement of deteriorated structures and erosion controls, grading or seeding of road surfaces, and, in extreme cases, slope stabilization or removal of road fills where necessary to maintain structural integrity.
- (6) Conduct maintenance activities, such as dust abatement, so that chemical contaminants or pollutants are not introduced into surface waters to the extent practicable.
- (7) Properly maintain permanent stream crossings and associated fills and approaches to reduce the likelihood (a) that stream overflow will divert onto roads, and (b) that fill erosion will occur if the drainage structures become obstructed.

1. Applicability

This management measure pertains to lands where silvicultural or forestry operations are planned or conducted. It is intended to apply to active and inactive roads constructed or used for silvicultural activities.

Under the Coastal Zone Act Reauthorization Amendments of 1990, States are subject to a number of requirements as they develop coastal nonpoint source programs in conformity with this measure and will have some flexibility in doing so. The application of this management measure by States is described more fully in *Coastal Nonpoint Pollution Control Program: Program Development and Approval Guidance*, published jointly by the U.S. Environmental Protection Agency (EPA) and the National Oceanic and Atmospheric Administration (NOAA) of the U.S. Department of Commerce.

2. Description

The objective of this management measure is to manage existing roads to maintain stability and utility and to minimize sedimentation and pollution from runoff-transported materials. Roads that are actively eroding and providing significant sediment to waterbodies, whether in use or not, must be managed. If roads are no longer in use or needed in the foreseeable future, an effective treatment is to remove drainage crossings and culverts if there is a risk of plugging or failure from lack of maintenance. In other cases (e.g., roads in use), it may be more economically viable to periodically maintain crossing and drainage structures.

Sound planning, design, and construction measures often reduce the future levels of necessary road maintenance. Roads constructed with a minimum width in stable terrain, and with frequent grade reversals or dips, require minimum maintenance. However, older roads remain one of the greatest sources of sediment from forest land management. In some locations, problems associated with altered surface drainage and diversion of water from natural channels can result in serious gully erosion or landslides. After harvesting is complete, roads are often forgotten. Erosion problems may go unnoticed until after there is severe resource damage. In western Oregon, 41 out of the 104 landslides reported on private and State forest lands during the winter of 1989-90 were associated with older (built before 1984) forest roads. These landslides were related to both road drainage and original construction problems. Smaller erosion features, such as gullies and deep ruts, are far more common than landslides and very often are related to road drainage.

Drainage of the road prism, road fills in stream channels, and road fills on steep slopes are the elements of greatest concern in road management. Roads used for active timber hauling usually require the most maintenance, and mainline roads typically require more maintenance than spur roads. Use of roads during wet or thaw periods can result in a badly rutted surface, impaired drainage, and excessive sediment leading to waterbodies. Inactive roads, not being used for timber hauling, are often overlooked and receive little maintenance. Many forest roads that have been abandoned may be completely overgrown with vegetation, which makes maintenance very difficult.

Figure 3-24 illustrates some differences between a road with a well-maintained surface, good revegetation, and open drainage structures, and a poorly maintained road.

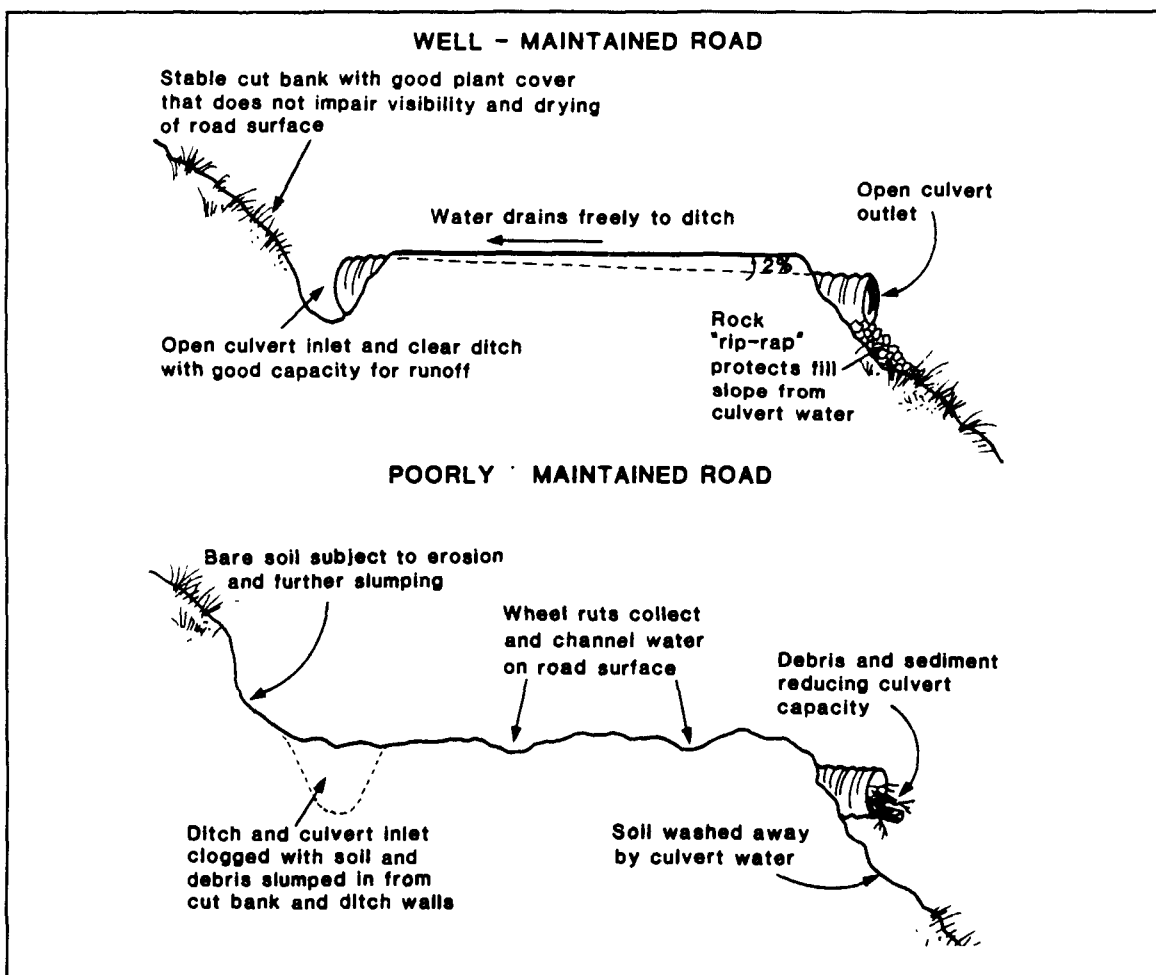

Figure 3-24. Road maintenance examples (Adams, 1991).

3. Management Measure Selection

a. Effectiveness Information

Drainage structures must be maintained to function properly. Culverts and ditches must be kept free of debris that can restrict water flow. Routine clearing can minimize clogging and prevent flooding, gullyng, and washout (Kochenderfer, 1970). Routine maintenance of road dips and surfaces and quick response to problems can significantly reduce road-caused slumps and slides and prevent the creation of berms that could channelize runoff (Oregon Department of Forestry 1981; Ontario Ministry of Natural Resources, 1988).

Proper road/trail closure is essential in preventing future erosion and sedimentation from abandoned roads and skid trails. Proper closure incorporates removal of temporary structures in watercourses, returning stream crossing approaches to their original grades, revegetating disturbed areas, and preventing future access (Kochenderfer, 1970; Rothwell, 1978) Revegetation of disturbed areas protects the soil from raindrop impact and aids soil aggregation, and therefore reduces erosion and sedimentation (Rothwell, 1978).

b. Cost Information

Benefits of proper road maintenance were effectively shown by Dissmeyer and Frandsen (1988). Maintenance costs for road repair were 44 percent greater without implementation of control measures than for installation of BMPs (Table 3-31).

Dissmeyer and Foster (1987) presented an analysis of the economic benefits of various watershed treatments associated with roads (Table 3-32). Specifically, they examined the cost of revegetating cut-and-fill slopes and the costs of various planning and management technical services (e.g., preparing soil and water prescriptions, compiling soils data, and reviewing the project in the field). These costs were compared to savings in construction and maintenance costs resulting from the watershed treatments. Specifically, savings were realized from avoiding problem soils, wet areas, and unstable slopes. The economic analysis showed that the inclusion of soil and water resource management (i.e., revegetating and technical services) in the location and construction of forest roads resulted in an estimated savings of \$311 per kilometer in construction costs and \$186 per kilometer in maintenance costs.

As part of the Fisher Creek Watershed Improvement Project, Rygh (1990) examined the various costs of ripping and scarification using different techniques. The major crux of Rygh's work was to compare the relative advantages of using a track hoe for ripping and scarification versus the use of large tractor-mounted rippers. He found track hoes to be preferable to tractor-mounted rippers for a variety of reasons, including the following:

- A reduction in furrows and resulting concentrated runoff caused by tractors;
- Improved control over the extent of scarification;
- Increased versatility and maneuverability of track hoes; and
- Cost savings.

Rygh estimated that the cost of ripping with a track hoe ranged from \$220 to \$406 per mile compared to a cost of \$550 per mile for ripping with a D7 or D8 tractor (Table 3-33).

4. Practices

As discussed more fully at the beginning of this chapter and in Chapter 1, the following practices are described for illustrative purposes only. State programs need not require implementation of these practices. However, as a practical matter, EPA anticipates that the management measure set forth above generally will be implemented by applying one or more management practices appropriate to the source, location, and climate. The practices set forth below have been found by EPA to be representative of the types of practices that can be applied successfully to achieve the management measure described above.

Table 3-31. Comparison of Road Repair Costs for a 20-Year Period With and Without BMPs^a (Dissmeyer and Frandsen, 1988)

Maintenance Costs Without BMPs		Costs of BMP Installation	
Equipment	\$365	Labor to construct terraces and water diversions	\$ 780
Materials (gravel)	122	Materials to revegetate	120
Work supervision	40	Cost of technical assistance	300
Repair cost per 3 years	527	Total cost over 20 years	\$1,200
Total cost over 20 years ^b	\$2,137		

IRR: 11.2%
 PNV: \$937
 B/C ratio: 1.78 to 1.00 for road BMP installation versus reconstruction/repair.

^a BMPs include construction of terraces and water diversions, and seeding.

^b Discounted @ 4%.

Table 3-32. Analysis of Costs and Benefits of Watershed Treatments Associated with Roads (SE U.S.) (Dissmeyer and Foster, 1987)

	Treatment ^a		
	Seed Without Mulch	Seed With Mulch	Hydroseed With Mulch
Costs			
Cost per kilometer (\$)	356	569	701
Cost per kilometer for soil and water technical services (\$)	62	62	62
Total cost of watershed treatment (\$)	418	631	763
Benefits^b			
Savings in construction costs (\$/km)	311	311	311
Savings in annual maintenance costs (\$/km)	186	186	186
Benefit/cost (10-year period)	4.4:1	2.9:1	2.4:1

Adapted from West, S., and B.R. Thomas, 1982. Effects of Skid Roads on Diameter, Height, and Volume Growth in Douglas-Fir. *Soil Sci. Soc. Am. J.*, 45:629-632.

^a Treatments included fertilization and liming where needed.

^b Cost savings were associated with soil and water resource management in the location and construction of forest roads by avoiding problem soils, wet areas, and unstable slopes. Maintenance cost savings were derived from revegetating cut and fill slopes, which reduced erosion, prolonging the time taken to fill ditch lines with sediment and reducing the frequency of ditch line reconstruction.

■ **Blade and reshape the road to conserve existing surface material; to retain the original, crowned, self-draining cross section; and to prevent or remove berms (except those designed for slope protection) and other irregularities that retard normal surface runoff (Larse, 1971).**

Ruts and potholes can weaken road subgrade materials by channeling runoff and allowing standing water to persist (Rothwell, 1978). Periodic grading of the road surface is necessary to fill in wheel ruts and to reshape the road (Haussman and Pruett, 1978). Maintenance practices must be modified for roads with broad-based dips (Swift, 1985). Maintenance by a motor grader is difficult because scraping tends to fill in the dips, the blade cannot be

Table 3-33. Comparative Costs of Reclamation of Roads and Removal of Stream Crossing Structures (ID) (Rygh, 1990)

Method	Cost (dollar/mile)
Ripping/scarification	
Ripping with D7 or D8 tractor	\$550
Scarifying with D8-mounted brush blade	\$844
Scarification to 6-inch depth and installation of water bars with track hoe	\$1,673
Ripping and slash scattering with track hoe	\$440 - \$660
Ripping, slash scattering, and water bar installation with track hoe	\$812
Ripping with track hoe	\$220 - \$406

maneuvered to clean the dip outlet, and cut banks are destabilized when the blade undercuts the toe of the slope. Small bulldozers or front-end loaders appear to be more suitable for periodic maintenance of intermittent-use forest roads (Swift, 1988).

■ *Clear road inlet and outlet ditches, catch basins, culverts, and road-crossing structures of obstructions (Larse, 1971).*

Avoid undercutting backslopes when cleaning silt and debris from roadside ditches (Rothwell, 1978). Minimize machine cleaning of ditches during wet weather. Do not disturb vegetation when removing debris or slide blockage from ditches (Larse, 1971; Rothwell, 1978). The outlet edges of broad-based dips need to be cleaned of trapped sediment to eliminate mudholes and prevent the bypass of stormwaters. The frequency of cleaning depends on traffic load (Swift, 1988). Clear stream-crossing structures and their inlets of debris, slides, rocks, and other materials prior to and following any heavy runoff period (Hynson et al., 1982).

■ *Maintain road surfaces by mowing, patching, or resurfacing as necessary.*

Grassed roadbeds carrying fewer than 20-30 vehicle trips per month usually require only annual roadbed mowing and periodic trimming of encroaching vegetation (Swift, 1988).

■ *Remove temporary stream crossings to maintain adequate streamflow (Hynson et al., 1982).*

Failure or plugging of abandoned temporary crossing structures can result in greatly increased sedimentation and turbidity in the stream, and channel blowout.

■ *Wherever possible, completely close the road to travel and restrict access by unauthorized persons by using gates or other barriers (Hausman and Pruett, 1978).*

Where such restrictions are not feasible, traffic should be regulated (Rothwell, 1978).

■ *Install or regrade water bars on roads that will be closed to vehicle traffic and that lack an adequate system of broad-based dips (Kochenderfer, 1970).*

Water bars will help to minimize the volume of water flowing over exposed areas and remove water to areas where it will not cause erosion. Water bar spacing depends on soil type and slope. Table 3-34 contains suggested guidelines for water bar spacing. Water should flow off the water bar onto rocks, slash, vegetation, duff, or other less erodible material and should never be diverted directly to streams or bare areas (Oregon Department of Forestry, 1979a). Outslope closed road surfaces to disperse runoff and prevent closed roads from routing water to streams.

■ *Revegetate to provide erosion control and stabilize the road surface and banks.*

Refer to Revegetation of Disturbed Areas management measure for a more detailed discussion.

■ *Replace open-top culverts with cross drains (water bars, dips, or ditches) to control and divert runoff from road surfaces (Rothwell, 1978; Haussman and Pruett, 1978).*

Open-top culverts are for temporary drainage of ongoing operations. It is important to replace them with more permanent drainage structures to ensure adequate drainage and reduce erosion potential prior to establishment of vegetation on the roadbed.

■ *Periodically inspect closed roads to ensure that vegetational stabilization measures are operating as planned and that drainage structures are operational (Hynson et al., 1982; Rothwell, 1978). Conduct reseeding and drainage structure maintenance as needed.*

Table 3-34. Water Bar Spacing by Soil Type and Slope (Oregon Department of Forestry, 1979a)

Road Grade (percent)	Soil Type		
	Granitic or Sandy	Shale or Gravel	Clay
2	900	1000	1000
4	600	1000	800
6	500	1000	600
8	400	900	500
10	300	800	400
12	200	700	400
15	150	500	300
20	150	300	200
25+	100	200	150

Note: Distances are approximate and should be varied to take advantage of natural features.

E. Timber Harvesting

The timber harvesting management measure consists of implementing the following:

- (1) Timber harvesting operations with skid trails or cable yarding follow layouts determined under Management Measure A.
- (2) Install landing drainage structures to avoid sedimentation to the extent practicable. Disperse landing drainage over sideslopes.
- (3) Construct landings away from steep slopes and reduce the likelihood of fill slope failures. Protect landing surfaces used during wet periods. Locate landings outside of SMAs.
- (4) Protect stream channels and significant ephemeral drainages from logging debris and slash material.
- (5) Use appropriate areas for petroleum storage, draining, dispensing. Establish procedures to contain and treat spills. Recycle or properly dispose of all waste materials.

For cable yarding:

- (1) Limit yarding corridor gouge or soil plowing by properly locating cable yarding landings.
- (2) Locate corridors for SMAs following Management Measure B.

For groundskidding:

- (1) Within SMAs, operate groundskidding equipment only at stream crossings to the extent practicable. In SMAs, fell and endline trees to avoid sedimentation.
- (2) Use improved stream crossings for skid trails which cross flowing drainages. Construct skid trails to disperse runoff and with adequate drainage structures.
- (3) On steep slopes, use cable systems rather than groundskidding where groundskidding may cause excessive sedimentation.

1. Applicability

This management measure pertains to lands where silvicultural or forestry operations are planned or conducted. It is intended to apply to all harvesting, yarding, and hauling conducted as part of normal silvicultural activities on harvest units larger than 5 acres. This measure does not apply to harvesting conducted for precommercial thinnings or noncommercial firewood cutting.

Under the Coastal Zone Act Reauthorization Amendments of 1990, States are subject to a number of requirements as they develop coastal nonpoint source programs in conformity with this measure and will have some flexibility in doing so. The application of this management measure by States is described more fully in *Coastal Nonpoint Pollution Control Program: Program Development and Approval Guidance*, published jointly by the U.S. Environmental Protection Agency (EPA) and the National Oceanic and Atmospheric Administration (NOAA) of the U.S. Department of Commerce.

2. Description

The goal of this management measure is to minimize sedimentation resulting from the siting and operation of timber harvesting, and to manage petroleum products properly.

Logging practices that protect water quality and soil productivity can also reduce total mileage of roads and skid trails, lower equipment maintenance costs, and provide better road protection and lower road maintenance. Careful logging can disturb soil surfaces as little as 8 percent, while careless logging practices can disturb soils as much as 40 percent (Golden et al., 1984). In the Appalachians, skid roads perpendicular to the contour, instead of along the contour, yielded 40 tons of sediment per acre of skid road surface (Hornbeck and Reinhart, 1964). Higher bulk densities and lower porosity of skid road soils due to compaction by rubber-tired skidders result in reduced soil infiltration capacity and corresponding increases in runoff and erosion (Dickerson, 1975). Douglass and Swank (1975) found that poor logging techniques increased sediment production during storms by 10 to 20 times more than sediment production from the undisturbed control watershed. A properly logged watershed experienced only slightly increased sedimentation compared to the undisturbed control watershed.

Locating landings for both groundskidding and cable yarding harvesting systems according to preharvest planning minimizes erosion and sediment delivery to surface waters. However, final siting of landings may need to be adjusted in the field based on site characteristics.

Landings and loading decks can become very compacted and puddled and are therefore a source of runoff and erosion (Golden et al., 1984). Practices that prevent or disperse runoff from these areas before the runoff reaches watercourses will minimize sediment delivery to surface waters. Also, any chemicals or petroleum products spilled in harvest areas can be highly mobile, adversely affecting the water quality of nearby surface waters. Correct spill prevention and containment procedures are therefore necessary to prevent petroleum products from entering surface waters. Designation of appropriate areas for petroleum storage will also minimize water quality impacts due to spills or leakage.

3. Management Measure Selection

This management measure is based on the experience and information gained from studies and from States using similar harvesting practices. Many studies have evaluated and compared the effects of different timber harvest techniques on sediment loss (erosion), soil compaction, and overall ground disturbance associated with various harvesting techniques. The data presented in Tables 3-35 through 3-40 were compiled from many different studies conducted throughout the United States and Canada. Many local factors such as climatic conditions, soil type, and topography affected the results of each study. The studies also examined harvesting techniques under a variety of conditions, including clearcuts, selective cuts, and fire-salvaged areas. However, the major conclusions from the studies on the relative impacts of different timber harvesting techniques on soil erosion and the causes and consequences of ground disturbance remain fairly constant between the studies and enable cross-geographic comparison.

Some of the most significant water quality impacts from logging operations (especially increased sedimentation) result from the actual yarding operations and activities on landings. The critical factors that affect the degree of soil disturbance associated with a particular yarding technique include the amount of disturbance caused by the yarding machinery itself and the amount of road construction needed to support each system. Stone (1973) presented information suggesting that roads may contribute greater than 90 percent of the sedimentation problems associated with logging operations. Therefore, since road areas represent potential erosion sites, it is important to recognize and consider the amount of land used for roads by various logging systems (Sidle, 1980).

a. Effectiveness Information

The amount of total soil disturbance varies considerably between the different yarding techniques. Megahan (1980) presented the most comprehensive survey of the available information on these impacts, presenting the data in two

ways: soil disturbance associated with the actual yarding operation and soil disturbance associated with the construction of roads needed for the practice (Tables 3-35 and 3-36). The results of his investigation echoed other studies presented in this section and clearly show that aerial and skyline cable techniques are far less damaging than other yarding techniques.

The amount of soil disturbance by yarding depends on the slope of the area, volume yarded, size of logs, and the logging system. Table 3-36 presents data on the extent of soil disturbance associated with particular yarding systems. Megahan's ranking of yarding techniques (from greatest impact to lowest impact) based on percent area disturbed is summarized as follows: tractor (21 percent average), ground cable (21 percent, one study), high-lead (16 percent

Table 3-35. Soil Disturbance from Roads for Alternative Methods of Timber Harvesting (Megahan, 1980)

Logging System (State)	Percent of Logged Area Bared			Reference
	Roads	Skid Roads and Landings	Total	
Tractor:				
Tractor — clearcut (BC)	30.0	—	30.0	Smith, 1979
Tractor — selection (CA)	2.7	5.7	8.4	Rice, 1961
Tractor — selection (ID)	2.2	6.8	9.0	Haupt and Kidd, 1965
Tractor — group selection (ID)	1.0	6.7	7.7	Haupt and Kidd, 1965
Tractor and helicopter — fire salvage (WA)	4.5	0.4	4.9	Klock, 1975
Tractor and cable — fire salvage (WA)	16.9	—	16.9	Klock, 1975
Ground Cable:				
Jammer — group selection (ID)	25-30	—	25-30	Megahan and Kidd, 1972
Jammer — clearcut (BC)	8.0	—	8.0	Smith, 1979
High-lead — clearcut (BC)	14.0	—	14.0	Smith, 1979
High-lead — clearcut (OR)	6.2	3.6	9.8	Silen and Gratkowski, 1953
High-lead — clearcut (OR)	3.0	1.0	4.0	Brown and Krygier, 1971
High-lead — clearcut (OR)	6.0	1.0	7.0	Brown and Krygier, 1971
High-lead — clearcut (OR)	6.0	—	6.0	Fredriksen, 1970
Skyline:				
Skyline — clearcut (OR)	2.0	—	2.0	Binkley, 1965
Skyline — clearcut (BC)	1.0	—	1.0	Smith, 1979
Aerial:				
Helicopter — clearcut	1.2	—	1.2	Binkley ^a

^a Estimated by Virgil W. Binkley, Pacific Northwest Region, USDA Forest Service, Portland, OR.

Table 3-36. Soil Disturbance from Logging by Alternative Harvesting Methods (Megahan, 1980)

Method of Harvest	Location	Disturbance (%)	Reference
Tractor:			
Tractor — clearcut	E. WA	29.4	Wooldridge, 1960
Tractor — clearcut	W. WA	26.1	Steinbrenner and Gessel, 1955
Tractor — fire salvage	E. WA	36.2	Klock ^a , 1975
Tractor on snow — fire salvage	E. WA	9.9	Klock ^a , 1975
Tractor — clearcut	BC	7.0	Smith, 1979
Tractor — selection	E. WA, OR	15.5	Garrison and Rummel, 1951
Ground Cable:			
Cable - selection	E. WA, OR	20.9	Garrison and Rummel, 1951
High-lead — fire salvage	E. WA	32.0	Klock ^a , 1975
High-lead — clearcut	W. OR	14.1	Dyrness, 1965
High-lead — clearcut	W. OR	12.1	Ruth, 1967
High-lead — clearcut	BC	6.0	Smith, 1979
Jammer — clearcut	BC	5.0	Smith, 1979
Grapple — clearcut	BC	1.0	Smith, 1979
Skyline:			
Skyline — clearcut	W. OR	12.1	Dyrness, 1965
Skyline — clearcut	E. WA	11.1	Wooldridge, 1960
Skyline — clearcut	BC	7.0	Smith, 1979
Skyline — clearcut	W. OR	6.4	Ruth, 1967
Skyline — fire salvage	E. WA	2.8	Klock ^a , 1975
Balloon — clearcut	W. OR	6.0	Dyrness ^b
Aerial:			
Helicopter — fire salvage	E. WA	0.7	Klock ^a , 1975
Helicopter — clearcut	ID	5.0	Clayton (in press)

^a Disturbance shown is classified as severe.

^b Dyrness, C.T., unpublished data on file, Pacific Northwest Forest and Range Experiment Station, Corvallis, OR.

average), skyline (8 percent average), jammer in clearcut (5 percent, one study), and aerial techniques (4 percent average).

The amount of road required for different yarding techniques varies considerably. Sidle (1980) defined the amount of land used for haul roads by various logging methods. Skyline techniques require the least amount of road area, with only 2-3.5 percent of the land area in roads. Tractor and single-drum jammer techniques require the greatest amount of road area (10-15 and 18-24 percent of total area, respectively). High-lead cable techniques fall in the

middle, with 6-10 percent of the land used for roads. Megahan (1980) concluded that tractor, jammer, and high-lead cable methods result in significantly higher amounts of disturbed soil than do the skyline and aerial techniques.

Side (1980) also presented data showing that tractors cause the greatest amount of soil disturbance (35 percent of land area) and soil compaction (26 percent of land area). Side (1980) concluded that skyline and aerial balloon techniques created the least disturbance (12 and 6 percent, respectively) and compaction (3 and 2 percent, respectively) (Table 3-37).

Miller and Sirois (1986) compared the land area disturbed by cable, skyline, and groundskidding systems (Table 3-38). They found groundskidding operations to affect 31 percent of the total land area, whereas cable yarding only affected 16 percent of the total land area. Similarly, Patric (1980) found skidders to serve the smallest area per mile of road (20 acres), with skyline yarding serving the largest area per mile of road (80 acres) (Table 3-39).

Table 3-37. Relative Impacts of Four Yarding Methods on Soil Disturbance and Compaction in Pacific Northwest Clearcuts (OR, WA, ID) (Side, 1980)

Yarding Method	Bare Soil (%)	Compacted Soil (%)
Tractor	35	26
High-lead	15	9
Skyline	12	3
Balloon	6	2

Table 3-38. Percent of Land Area Affected by Logging Operations (Southwest MS) (Miller and Sirois, 1986)

Operational Area	Cable Skyline	Groundskidding
Landings	4.1	6.4
Spur roads	2.6	3.5
Cable corridors or skid trails	<u>9.2</u>	<u>21.4</u>
Total	15.9	31.3

Table 3-39. Skidding/Yarding Method Comparison (Patric, 1980)^a

Harvesting System	Acres Served per Mile of Road
Wheeled skidder	20
Jammer	31
High-lead	40
Skyline	80

^a Adapted from Kochenderfer and Wendel (1978) and unpublished work by Thorsen.

b. Cost Information

The costs and benefits of rehabilitation of skid trails by planting hardwood, hardwood pine, and shortleaf pine in the southeastern United States were studied by Dissmeyer and Foster (1986). The average rehabilitation cost per acre was \$360 and included water barring, ripping or disking, seeding, fertilizing, and mulching where needed (Table 3-40). The benefit/cost ratio of the rehabilitation cost was 1.33 for hardwood, 2.82 for hardwood pine, and 5.07 for shortleaf pine. The real rate of return over inflation ranged from 2.4 to 4.8 percent.

4. Practices

As discussed more fully at the beginning of this chapter and in Chapter 1, the following practices are described for illustrative purposes only. State programs need not require implementation of these practices. However, as a

Table 3-40. Analysis of Costs and Benefits of Skid Trail Rehabilitation in the Management of Three Southern Timber Types in the Southeast (Dissmeyer and Foster, 1986)

	Units	Timber Type		
		Hardwood	Hardwood Pine	Shortleaf Pine
Rotation	Years	70	60	60
Harvest volume per hectare	m ³	301	350	420
Value per cubic meter	\$ ^b	28.57	42.86	64.29
Total value of timber per hectare for uncompacted soil	\$ ^b	8,600	15,001	27,002
Timber volume per acre on skid trails (26% of uncompacted soil)	m ³	78	91	109
Timber volume lost per acre	m ³	223	259	311
Cost per hectare for skid trail rehabilitation ^a	\$ ^b	900	900	900
Timber volume recovered (75% of loss)	m ³	167	194	233
Value of timber volume recovered	\$ ^b	4,771	8,315	14,980
Internal rate of return based upon timber volume recovered	% ^c	2.4	3.8	4.8
Net present value of timber volume recovered (@ 2%)	\$ ^b	1,193	2,538	4,568
B/C ratio of rehab. cost	Ratio	1.33:1	2.82:1	5.07:1

Note: Skid trail rehabilitation reduces sediment yields.

m³: cubic meters.

^a Average cost for skid trail rehabilitation includes water barring, ripping or disking, seeding, fertilizing, and mulching where needed (\$900/ha = \$360/ac).

^b 1986 dollars.

^c Percentage points over inflation.

practical matter, EPA anticipates that the management measure set forth above generally will be implemented by applying one or more management practices appropriate to the source, location, and climate. The practices set forth below have been found by EPA to be representative of the types of practices that can be applied successfully to achieve the management measure described above.

a. Harvesting Practices

- *Fell trees away from watercourses, whenever possible, keeping logging debris from the channel, except where debris placement is specifically prescribed for fish or wildlife habitat (Megahan, 1983).*
- *Any tree accidentally felled in a waterway should be immediately removed (Huff and Deal, 1982).*
- *Remove slash from the waterbody and place it out of the SMA.*

This will allow unrestricted water flow and protection of the stream's nutrient balance. Remove only logging-generated debris. Leave pieces of large woody debris in place during stream cleaning to preserve channel integrity and maintain stream productivity. Bilby (1984) concluded that indiscriminate removal of large woody debris can adversely affect channel stability. Table 3-41 presents a possible way to determine debris stability.

b. Practices for Landings

- *Landings should be no larger than necessary to safely and efficiently store logs and load trucks.*
- *Install drainage and erosion control structures as necessary.*

Diversion ditches placed around the uphill side of landings minimize accumulation of water on the landing. Landings should have a slight slope to facilitate drainage. Also, adequate drainage on approach roads will prevent road drainage water from entering the landing area.

- *The slope of the landing surface should not exceed 5 percent and should be shaped to promote efficient drainage.*

Table 3-41. General Large Woody Debris Stability Guide Based on Salmon Creek, Washington (Bilby, 1984)

-
- 1.a. If debris is anchored or buried in the streambed or bank at one or both ends or along the upstream face - LEAVE.
 - 1.b. If debris is not anchored, go to 2.
 - 2.a. If debris is longer than 10.0 m - LEAVE.
 - 2.b. If debris is shorter than 10.0 m - go to 3.
 - 3.a. If debris is greater than 50 cm in diameter - go to 4.
 - 3.b. If debris is less than 50 cm in diameter - go to 5.
 - 4.a. If debris is longer than 5.0 m - LEAVE.
 - 4.b. If debris is shorter than 5.0 m - go to 5.
 - 5.a. If debris is braced on the downstream side by boulders, bedrock outcrops, or stable pieces of debris - LEAVE.
 - 5.a. If debris is not braced on the downstream side - REMOVE.
-

- *The slope of landing fills should not exceed 40 percent, and woody or organic debris should not be incorporated into fills.*
- *If landings are to be used during wet periods, protect the surface with a suitable material such as wooden matting or gravel surfacing.*
- *Install drainage structures for the landings such as water bars, culverts, and ditches to avoid sedimentation. Disperse landing drainage over sideslopes. Provide filtration or settling if water is concentrated in a ditch.*
- *Upon completion of harvest, clean up landing, regrade, and revegetate (Rothwell, 1978).*
 - *Upon abandonment, minimize erosion on landings by adequately ditching or mulching with forest litter.*
 - *Establish a herbaceous cover on areas that will be used again in repeated cutting cycles, and restock landings that will not be reused (Megahan, 1983).*
 - *If necessary, install water bars for drainage control.*
- *Locate landings for cable yarding where slope profiles provide favorable deflection conditions so that the yarding equipment used does not cause yarding corridor gouge or soil plowing, which concentrates drainage or causes slope instability.*
- *Locate cable yarding corridors for streamside management areas following Management Measure B components. Yarded logs should not cause disturbance of the major channel banks of the watercourse of the SMA.*

c. Groundskidding Practices

- *Skid uphill to log landings whenever possible. Skid with ends of logs raised to reduce rutting and gouging.*

This practice will disperse water on skid trails away from the landing. Skidding uphill lets water from trails flow onto progressively less-disturbed areas as it moves downslope, reducing erosion hazard. Skidding downhill concentrates surface runoff on lower slopes along skid trails, resulting in significant erosion and sedimentation hazard (Figure 3-25). If skidding downhill, provide adequate drainage on approach trails so that drainage does not enter landing.

- *Skid perpendicular to the slope (along the contour), and avoid skidding on slopes greater than 40 percent.*

Following the contour will reduce soil erosion and encourage revegetation. If skidding must be done parallel to the slope, then skid uphill, taking care to break the grade periodically.

- *Avoid skid trail layouts that concentrate runoff into draws, ephemeral drainages, or watercourses. Use endlining to winch logs out of SMAs or directionally fell trees so tops extend out of SMAs and trees can be skidded without operating equipment in SMAs. In SMAs, trees should be carefully endlined to avoid soil plowing or gouge.*

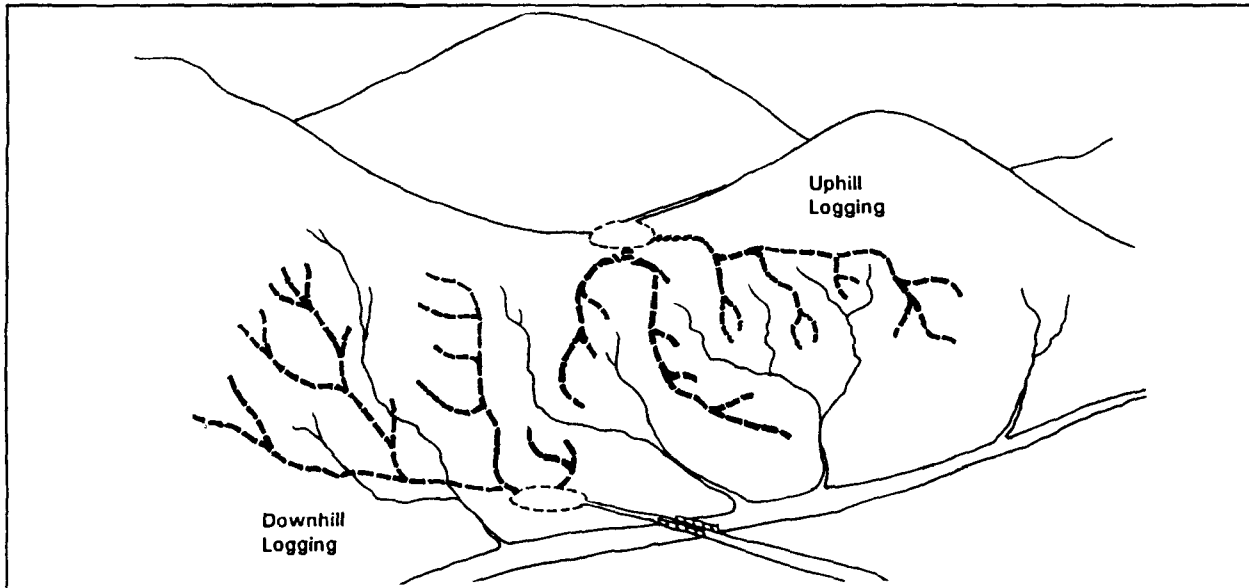

Figure 3-25. Hypothetical skid trail pattern for uphill and downhill logging (Megahan, 1983).

■ Suspend groundskidding during wet periods, when excessive rutting and churning of the soil begins, or when runoff from skid trails is turbid and no longer infiltrates within a short distance from the skid trail. Further limitation of groundskidding of logs, or use of cable yarding, may be needed on slopes where there are sensitive soils and/or during wet periods.

■ Retire skid trails by installing water bars or other erosion control and drainage devices, removing culverts, and revegetating (Rothwell, 1978; Lynch et al, 1985).

- After logging, obliterate and stabilize all skid trails by mulching and reseeding.
- Build cross drains on abandoned skid trails to protect stream channels or side slopes in addition to mulching and seeding.
- Restore stream channels by removing temporary skid trail crossings (Megahan, 1983).
- Scatter logging slash to supplement water bars and seeding to reduce erosion on skid trails (Lynch et al., 1985).

d. Cable Yarding Practices

■ Use cabling systems or other systems when groundskidding would expose excess mineral soil and induce erosion and sedimentation.

- Use high-lead cable or skyline cable systems on slopes greater than 40 percent.
- To avoid soil disturbance from sidewash, use high-lead cable yarding on average-profile slopes of less than 15 percent.

■ Avoid cable yarding in or across watercourses.

When cable yarding across streams cannot be avoided, use full suspension to minimize damage to channel banks and vegetation in the SMA.

■ Yard logs uphill rather than downhill.

In uphill yarding, log decks are placed on ridge or hill tops rather than in low-lying areas (Megahan, 1983). This creates less soil disturbance because the lift imparted to the logs reduces frictional resistance and the outward radiation of yard trails downhill from the landing disperses runoff evenly over the slope and reduces erosion potential. Downhill yarding should be avoided because it concentrates surface erosion.

e. Petroleum Management Practices

■ *Service equipment where spilled fuel and oil cannot reach watercourses, and drain all petroleum products and radiator water into containers. Dispose of wastes and containers in accordance with proper waste disposal procedures.¹ Waste oil, filters, grease cartridges, and other petroleum-contaminated materials should not be left as refuse in the forest.*

■ *Take precautions to prevent leakage and spills. Fuel trucks and pickup-mounted fuel tanks must not have leaks.*

- Use and maintain seepage pits or other confinement measures to prevent diesel oil, fuel oil, or other liquids from running into streams or important aquifers.
- Use drip collectors on oil-transporting vehicles (Hynson et al., 1982).

■ *Develop a spill contingency plan that provides for immediate spill containment and cleanup, and notification of proper authorities.*

- Provide materials for adsorbing spills, and collect wastes for proper disposal.

¹ The Resource Conservation and Recovery Act (RCRA) regulates the transportation, handling, storage, and disposal of hazardous materials, including petroleum products and by-products.

F. Site Preparation and Forest Regeneration

Confine on-site potential NPS pollution and erosion resulting from site preparation and the regeneration of forest stands. The components of the management measure for site preparation and regeneration are:

- (1) Select a method of site preparation and regeneration suitable for the site conditions.
- (2) Conduct mechanical tree planting and ground-disturbing site preparation activities on the contour of sloping terrain.
- (3) Do not conduct mechanical site preparation and mechanical tree planting in streamside management areas.
- (4) Protect surface waters from logging debris and slash material.
- (5) Suspend operations during wet periods if equipment used begins to cause excessive soil disturbance that will increase erosion.
- (6) Locate windrows at a safe distance from drainages and SMAs to control movement of the material during high runoff conditions.
- (7) Conduct bedding operations in high-water-table areas during dry periods of the year. Conduct bedding in sloping areas on the contour.
- (8) Protect small ephemeral drainages when conducting mechanical tree planting.

1. Applicability

This management measure pertains to lands where silvicultural or forestry operations are planned or conducted. It is intended to apply to all site preparation and regeneration activities conducted as part of normal silvicultural activities on harvested units larger than 5 acres.

Under the Coastal Zone Act Reauthorization Amendments of 1990, States are subject to a number of requirements as they develop coastal nonpoint source programs in conformity with this measure and will have some flexibility in doing so. The application of this management measure by States is described more fully in *Coastal Nonpoint Pollution Control Program: Program Development and Approval Guidance*, published jointly by the U.S. Environmental Protection Agency (EPA) and the National Oceanic and Atmospheric Administration (NOAA) of the U.S. Department of Commerce.

2. Description

Regeneration of harvested forest lands not only is important in terms of restocking a valuable resource, but also is important to provide water quality protection from disturbed soils. Tree roots stabilize disturbed soils by holding the soil in place and aiding soil aggregation, decreasing slope failure potential. The presence of vegetation on disturbed soils also slows storm runoff, which in turn decreases erosion.

Leaving the forest floor litter layer intact during site preparation operations for regeneration minimizes mineral soil disturbance and detachment, thereby minimizing erosion and sedimentation (Golden et al., 1984). Maintenance of an unbroken litter layer prevents raindrop detachment, maintains infiltration, and slows runoff (McClurkin et al.,

1987). Mechanical site preparation can potentially impact water quality in areas that have steep slopes and erodible soils, and where the prepared site is located near a waterbody. Use of mechanical site preparation treatments that expose mineral soils on steep slopes can greatly increase erosion and landslide potential. Alternative methods, such as drum chopping, herbicide application, or prescribed burning, disturb the soil surface less than mechanical practices (Golden et al., 1984).

Mechanical planting using machines that scrape or plow the soil surface can produce erosion rills, increasing surface runoff and erosion. Natural regeneration, hand planting, and direct seeding minimize soil disturbance, especially on steep slopes with erodible soils (Golden et al., 1984).

3. Management Measure Selection

This measure is based in part on information and experience gained from studies and from the use of similar management practices by States. The information summarized provides comparisons and relative levels of effects and costs for site preparation and regeneration. The majority of the data in Tables 3-42 through 3-46 compare sediment loss or erosion rates for shearing, chopping, root-raking and disking. Many of the data are site-specific, and site characteristics and experimental conditions are provided (when available) in the text below. Regional differences in effects are summarized by Dissmeyer and Stump (1978); however, most of the experimental information is from the Southeast and Texas.

a. Effectiveness Information

Effects of different site preparation techniques depend greatly on care of application and site conditions. Beasley (1979) studied the relative soil disturbance effects of site preparation following clearcutting on three small watersheds in the hilly northern Mississippi Coastal Plain. Slopes were mostly 30 percent or greater. One site was single drum-chopped and burned; one was sheared and windrowed (windrows were burned); and the third was sheared, windrowed, and bedded to contour. The control watershed was instrumented and left uncut. The treatments exposed soil on approximately 40-70 percent of the three watersheds (Table 3-42). A temporary cover crop of clover was sown after site preparation to protect the soil from rainfall impact and erosion. Similar increases in sediment production were measured for the three treatments in the first year after site preparation, with amounts decreasing during the second year except for the bedded site, which was attributed to gully formation from increased stormflow. During the second year, the clover and other vegetation covered 85-95 percent of the surface, effectively decreasing sediment production.

A summary of work on erosion from site preparation by Dissmeyer and Stump is presented in Golden et al. (1984)(Table 3-43). These erosion rates were compiled from the Erosion Data Bank of the U.S. Forest Service and are based on observations throughout the Southeast. The rates reflect soil movement measured at the bottom of the slope, not sediment actually reaching a stream. Therefore, the numbers estimate the worst-case erosion if the stream is located directly at the toe of the slope with no intervening vegetation. Rates are given as tons per acre per year average for 3- to 4-year recovery periods.

The degree of erosion produced by site preparation practices is directly related to the amount of soil disturbed and the percentage of good ground cover remaining. Dissmeyer (1980) showed that disking produced more than twice the erosion rate of any other method (Table 3-44). Bulldozing, shearing, and sometimes grazing were associated with relatively high rates of erosion. Chopping or chopping and burning produced moderate erosion rates. Logging also produced moderate erosion rates in this study when it included the impact of skid and spin roads. The lowest rate of erosion is associated with burning.

Beasley and Granillo (1985) compared stormflow and sediment losses from mechanically and chemically prepared sites in southwest Arkansas (Table 3-45). Mechanical preparation (clearcutting followed by shearing, windrowing, and replanting with pine seedlings) significantly increased sediment losses in the first 2 years after treatment. A subsequent decline in sediment losses in the mechanically prepared watersheds was attributed to rapid growth of ground cover. Windrowing brush into ephemeral drainages and leaving it unburned effectively minimized soil losses

Table 3-42. Deposited, Suspended, and Total Sediment Losses and Percentage of Exposed Soil in the Experimental Watersheds During Water Years 1976 and 1977 for Various Site Preparation Techniques (MS, AR) (Beasley, 1979)

Treatment	Percent of Exposed Soil					
Chopped	37					
Sheared and windrowed	53					
Bedded	69					

Treatment	1976 (tons/ha)			1977 (tons/ha)		
	Deposited	Suspended	Total	Deposited	Suspended	Total
Control	--	--	0.62	--	--	0.11
Chopped	2.19	10.34	12.54	0.74	1.58	2.31
Sheared	2.14	10.65	12.80	0.81	1.41	2.22
Bedded	3.26	10.98	14.25	2.18	3.36	5.54

by trapping sediment on-site and reducing channel scouring. Chemical site preparation (herbicides) had no significant effect on sediment losses.

Water quality changes associated with two site preparation methods were studied by Blackburn, DeHaven, and Knight (1982). Table 3-46 shows that shearing and windrowing (which exposed 59 percent of the soil) can produce 400 times more sediment loadings than chopping (which exposed 16 percent of the soil) during site preparation. Total

Table 3-43. Predicted Erosion Rates^a Using Various Site Preparation Techniques for Physiographic Regions in the Southeastern United States (Golden et al., 1984)

Physiographic Regions	Treatment	Average Erosion Rate (tons/acre/year)
Ridge and Valley	Bulldozing	13.70
Sand Mountain	KG-blade	4.00
Southern Piedmont	Chopping	0.22
	Chop and burn	0.38
	KG-blade	1.80
	Disking	4.10
	Bulldozing	1.90
Southern Coastal Plain	Chopping	0.24
	Chop and burn	0.41
	KG-blade	0.65
	Disking	2.46
	Bulldozing	0.66
Blackland Prairies, AL and MS	KG-blade	1.20
	Disking	3.30

^a Rates are averages for the recovery period.

Table 3-44. Erosion Rates for Site Preparation Practices in Selected Land Resource Areas in the Southeast (Dissmeyer, 1980)

Condition or Activity	Recovery Period (Years)	Erosion Rates by Land Resource Area (Tons/Acre/Year)						
		Ouachita Mtns	Southern Appalachians	Southern Coastal Plains	Southern MS Valley Silty Uplands	Southern Piedmont	Carolina & GA Sand Hills	Atlanta & Gulf Coast Flatwoods
Natural	--	0.00	0.00	0.00	0.05	0.00	0.00	0.00
Logged ^a	3	2.3	1.7	0.48	0.27	0.48	0.20	0.13
Burned	2	0.23	0.16	0.17	0.7	0.14	0.06	0.05
Chopped	3	0.60	--	0.24	--	0.22	0.36	0.05
Chopped and burned	3-4	1.7	--	0.41	--	0.38	--	0.15
Sheared	4	3.6	--	0.65	2.4	1.8	1.0	0.20
Disked	4	--	--	2.46	9.8	4.1	--	--
Bulldozed	4	--	--	0.89	--	1.9	--	--
Grazed	--	0.80	--	0.18	1.0	0.95	--	0.01

^a Includes the impact of skid and spur roads.

Table 3-45. Effectiveness of Chemical and Mechanical Site Preparation in Controlling Water Flows and Sediment Losses (AR) (Beasley and Granillo, 1985)

Water Year	Treatment	Annual Stormflow (in)		Annual Sediment Losses (lb/ac)	
		Mean	Std Dev	Mean	Std Dev
1981 (Pretreatment)	Clearcut - Mechanical ^a	5.7	5.0	56	56
	Clearcut - Chemical ^b	4.7	5.5	39	50
	Control	7.9	7.5	28	26
1982	Clearcut - Mechanical	12.8	10.7	477	460
	Clearcut - Chemical	6.2	5.8	224	196
	Control	6.3	5.4	64	79
1983	Clearcut - Mechanical	24.0	19.3	897	949
	Clearcut - Chemical	15.6	15.8	183	157
	Control	8.7	7.3	131	196
1984	Clearcut - Mechanical	19.7	16.6	275	160
	Clearcut - Chemical	10.2	8.0	80	80
	Control	10.3	7.2	41	59

^a Clearcutting followed by shearing, windrowing, and replanting with pine seedlings.

^b Clearcutting followed by chemical treatments (injection of residual trees and foliar and/or aerial spraying).

Table 3-46. Sediment Loss (kg/ha) in Stormflow by Site Treatment from January 1 to August 31, 1981 (TX) (Blackburn, DeHaven, and Knight, 1982)

Treatment	Watershed	Sediment Loss (kg/ha)		
		Suspended	Bedload	Total
Sheared and windrowed	1	815.2	643.5	1,458.7
	2	1,217.0	920.4	2,137.4
	3	<u>736.7</u>	<u>2,270.8</u>	<u>3,007.5</u>
	Mean	923.0	1,278.2	2,201.2
Chopped	5	5.3	0	5.3
	7	10.7	0	10.7
	9	<u>23.2</u>	<u>0</u>	<u>23.2</u>
	Mean	13.1	0	13.1
Undisturbed	4	1.1	0	1.1
	6	7.2	0	7.2
	8	<u>0.8</u>	<u>0</u>	<u>0.8</u>
	Mean	3.0	0	3.0

nitrogen losses were nearly 20 times greater from sheared than from undisturbed watersheds, and three times greater from sheared than from chopped (Table 3-47).

b. Cost Information

The way a site is prepared for reforestation can make a 3- to 14-foot difference in site index for pine in the Southeast (Dissmeyer and Foster, 1987). In an analysis of different site preparation techniques, Dissmeyer and Foster concluded that maintaining site quality yields larger trees and more valuable products (Table 3-48). The heavy site preparation methods required a greater initial investment than did the light site preparation methods, but did not yield a greater harvest. The cost-benefit for light site preparation was a 2.3 percent greater internal rate of return than that for heavy site preparation. Dissmeyer (1986) evaluated the economic benefits of erosion control with respect to different site preparation techniques. Increased timber production and savings in site preparation costs are returns the landowner can enjoy if care is taken to reduce soil exposure, displacement, and compaction (Table 3-49). Using light site preparation techniques such as chopping and light burn reduces erosion, increases the site index and the value of timber, and costs less per unit area treated. Heavy site preparation techniques such as shearing and windrowing remove nutrients, compact soil, increase erosion and site preparation costs, and result in a lower present net value for timber.

Table 3-47. Nutrient Loss (kg/ha) in Stormflow by Site Treatment from January 1 to August 31, 1981 (TX) (Blackburn, DeHaven, and Knight, 1982)

Treatment	Nitrates	Ammonia	Total-N	Ortho-P	Total-P	K	Ca	Mg	Na
Sheared and windrowed	0.227	0.114	2.145	0.033	0.197	4.40	0.72	1.45	1.36
Chopped	0.066	0.042	0.759	0.010	0.012	2.48	1.19	0.71	0.79
Undisturbed	0.001	0.007	0.115	0.001	0.002	0.29	0.19	0.21	0.18

Table 3-48. Analysis of Two Management Schedules Comparing Cost and Site Productivity in the Southeast (Dissmeyer and Foster, 1987)

Year	Silviculture Treatment	Light Site Preparation ^a		Heavy Site Preparation ^b	
		Investment Per Hectare ^c	Wood Produced M ³ /ha	Investment Per Hectare ^c	Wood Produced M ³ /ha
1984	Site Prep/Tree Planting	\$297		\$420	
1999	Thinning	\$252	64.2 pulpwood	\$180	46.0 pulpwood
2010	Thinning	\$256	22.3 saw timber 33.3 pulpwood	\$331	5.3 saw timber 22.0 pulpwood
2020	Final Harvest	\$2,422	133.5 saw timber 15.2 pulpwood	\$2,071	112.3 saw timber 22.0 pulpwood
Present Net Value (@ 4%)		\$623		\$304	
Internal Rate of Return		12.4% ^d		10.1%	

Adapted from Patterson, T. 1984. Dollars in Your Dirt. *Alabama's Treasured Forests*. Spring: 20-21.

^a Light site preparation includes chop and light burn or chop with herbicides, and reduces soil exposure and erosion.

^b Heavy site preparation includes bulldozing or windrowing or shearing and windrowing, and increases erosion and sediment yields over those for light site preparation.

^c 1984 dollars.

^d Based on 4% inflation rate assumed.

The U.S. Forest Service (1987) examined the costs of three alternatives to slash treatment: broadcast burn and protection of streamside management zones, yarding of unmerchantable material (YUM) of 15 inches in diameter or more, and YUM of 8 inches in diameter or more (Table 3-50). YUM alternatives cost approximately \$435-\$820/acre, in comparison to broadcast burning at \$900/acre. In addition, the YUM alternatives protect highly erodible soils from direct rainfall and runoff impacts, reduce fire hazards, meet air and water quality standards, and allow for the rapid establishment of seedlings on clearcuts.

Table 3-49. Site Preparation Comparison (VA, SC, NC) (Dissmeyer, 1986)

Treatment	Treatment Cost (\$/acre)	Erosion Index ^a
No site preparation	\$40	1.0
Burn only	\$45	1.1
Single chop and burn	\$80	2.3
Double chop and burn	\$120	3.0
Single shear and burn	\$145	4.3
Shear twice and burn	\$170	5.1
Rootrake and disk and burn	\$170	16.0
Rootrake and burn	\$170	16.0

^a The index is an expression of relative erosion potential resulting from each treatment.

Table 3-50. Comparison of Costs for Yarding Unmerchantable Material (YUM) vs. Broadcast Burning (OR) (USDA, 1987)

Activity	Broadcast Burn and Protect SMA	YUM 15" in Diameter and No Burn	YUM 8" in Diameter and No Burn
Broadcast burn	\$350/acre	N/A	N/A
SMA protection	\$450/acre	N/A	N/A
YUM, fell hardwood, lop and scatter	N/A	\$305/acre	\$700/acre
Planting cost	\$100/acre	\$130/acre	\$120/acre
Totals	\$900/acre	\$435/acre	\$820/acre

Tables 3-51 and 3-52 present comparisons of estimated total costs for different site preparation and regeneration practices, respectively, for which cost-share assistance is provided by the State of Minnesota through its Stewardship Incentives Program (SIP) (Minnesota Department of Natural Resources, 1991). Table 3-53 presents total costs of forest regeneration by various methods, along with the cost-share amount provided by the State of Illinois' SIP.

4. Practices

As discussed more fully at the beginning of this chapter and in Chapter 1, the following practices are described for illustrative purposes only. State programs need not require implementation of these practices. However, as a practical matter, EPA anticipates that the management measure set forth above generally will be implemented by applying one or more management practices appropriate to the source, location, and climate. The practices set forth below have been found by EPA to be representative of the types of practices that can be applied successfully to achieve the management measure described above.

a. Site Preparation Practices

■ *Mechanical site preparation should not be applied on slopes greater than 30 percent.*

On sloping terrain greater than 10 percent, or on highly erosive soils, operate mechanical site preparation equipment on the contour.

■ *Mechanical site preparation should not be conducted in SMAs.*

■ *Construct beds along the contour (Huff and Deal, 1982). Avoid connecting beds to drainage ditches or other waterways.*

■ *Use haystack piling where possible instead of windrows.*

Leave sufficient slash and duff on the site to provide good ground cover and minimize erosion from the harvest site. If the soil Basic Erosion Rate (BER) is low, leave at least 40 percent good ground cover; if the BER is medium, leave at least 50 percent good ground cover; if the BER is high, leave at least 60 percent good ground cover.

■ *Minimize incorporation of soil material into windrows and piles during their construction.*

**Table 3-51. Estimated Costs for Site Preparation (1991 Costs)
(Minnesota Department of Natural Resources, 1991)**

Site Preparation Practice	Total Cost ^a
Chemical	\$67.00/acre
Mechanical	
Light (includes hand site preparation)	\$47.00/acre
Heavy ^b	\$107.00/acre
Chemical-Mechanical ^b	\$113.00/acre

^a The costs shown represent the total cost of the practice. Calculations were made by dividing the maximum Federal cost share by 0.75 to get the total cost.

^b Where slope exceeds 20 percent or primary cover is standing hardwoods greater than 12 inches in diameter, the above may be increased by \$40.00 per acre.

**Table 3-52. Estimated Costs for Regeneration (1991 Costs)
(Minnesota Department of Natural Resources, 1991)**

Regeneration Practice	Total Cost ^a
Planting ^b	
Softwoods (when purchased from State nurseries)	\$21.00/100 seedlings planted
Hardwoods (when purchased from State nurseries)	\$29.00/100 seedlings planted
Softwoods (when purchased from private nurseries)	\$28.00/100 seedlings planted
Hardwoods (when purchased from private nurseries)	\$41.00/100 seedlings planted
Shrubs	\$40.00/100 seedlings planted
Seeding (includes both purchase of seed and seeding)	
Aerial seeding	\$23.00/acre
Cyclone seeding	\$40.00/acre
Hand or hot cap seeding	\$53.00/acre

^a The costs shown represent the total cost of the practice. Calculations were made by dividing the maximum Federal cost share by 0.75 to get the total cost.

^b Where planting is to be done on areas of heavy slash from recent harvesting operations or on areas with slopes over 30 percent or on sites having other particularly difficult planting conditions, the limits may be increased an additional \$10.00 per 100 seedlings planted and, where the planting has a guaranteed end result, the above rates may be increased by \$5.00 per 100 trees planted.

**Table 3-53. Cost-Share Information for Revegetation/Tree Planting (Illinois
Administrative Code, 1990)**

Practice Description	Cost-Share Amount ^a	Total Cost
Tree planting (trees and labor)		
No-cost planting stock	NTE \$70.00/acre	\$87.50/acre
Purchased planting stock	NTE \$170.00/acre	\$212.50/acre
Direct seeding (including seed collected or purchased plus labor and any machinery use)	NTE \$40.00/acre	\$50.00/acre

NTE = not to exceed.

^a Cost-share amounts represent 80 percent of the actual cost.

This can be accomplished by using a rake or, if use of a blade is unavoidable, keeping the blade above the soil surface and removing only the slash. Rapid site recovery and tree growth are promoted by the retention of nutrient-rich topsoil, and the effectiveness of the windrow in minimizing sedimentation is increased.

■ *Locate windrows and piles away from drainages to prevent movement of materials during high-runoff conditions.*

■ *Avoid mechanical site preparation operations during periods of saturated soil conditions that may cause rutting or accelerate soil erosion.*

■ *Do not place slash in natural drainages, and remove any slash that accidentally enters drainages.*

Slash can clog the channel and cause alterations in drainage configuration and increases in sedimentation. Extra organic material can lower the dissolved oxygen content of the stream. Slash also allows silt to accumulate in the drainage and to be carried into the stream during storm events.

■ *Provide filter strips of sufficient width to protect drainages that do not have SMAs from sedimentation by the 10-year storm.*

b. Practices for Regeneration

■ *Distribute seedlings evenly across the site.*

■ *Order seedlings well in advance of planting time to ensure their availability.*

■ *Hand plant highly erodible sites, steep slopes, and lands adjacent to stream channels (SMAs)(Yoho, 1980).*

■ *Operate planting machines along the contour to avoid ditch formation.*

- Soil conditions (slope, moisture conditions, etc.) should be suitable for adequate machine operation.
- Slits should be closed periodically to avoid channeling flow.

G. Fire Management

Prescribe fire for site preparation and control or suppress wildfire in a manner which reduces potential nonpoint source pollution of surface waters:

- (1) Intense prescribed fire should not cause excessive sedimentation due to the combined effect of removal of canopy species and the loss of soil-binding ability of subcanopy and herbaceous vegetation roots, especially in SMAs, in streamside vegetation for small ephemeral drainages, or on very steep slopes.
- (2) Prescriptions for prescribed fire should protect against excessive erosion or sedimentation to the extent practicable.
- (3) All bladed firelines, for prescribed fire and wildfire, should be plowed on contour or stabilized with water bars and/or other appropriate techniques if needed to control excessive sedimentation or erosion of the fireline.
- (4) Wildfire suppression and rehabilitation should consider possible NPS pollution of watercourses, while recognizing the safety and operational priorities of fighting wildfires.

1. Applicability

This management measure pertains to lands where silvicultural or forestry operations are planned or conducted. It is intended to apply to all prescribed burning conducted as part of normal silvicultural activities on harvested units larger than 5 acres and for wildfire suppression and rehabilitation on forest lands.

Under the Coastal Zone Act Reauthorization Amendments of 1990, States are subject to a number of requirements as they develop coastal nonpoint source programs in conformity with this measure and will have some flexibility in doing so. The application of this management measure by States is described more fully in *Coastal Nonpoint Pollution Control Program: Program Development and Approval Guidance*, published jointly by the U.S. Environmental Protection Agency (EPA) and the National Oceanic and Atmospheric Administration (NOAA) of the U.S. Department of Commerce.

2. Description

The goal of this management measure is to minimize potential NPS pollution and erosion resulting from prescribed fire for site preparation and from the methods used for wildfire control or suppression.

Prescribed burning is aimed at reducing slash and competition for nutrients among seedlings and protecting against wildfire. Slash burning destroys vegetation that reduces nitrogen-nitrate loadings. If uncontrolled, the burn may reach SMAs or highly erodible soils, causing increased sedimentation and erosion. Prescribed burning causes changes in the chemical cycling of elements by influencing biological and microclimate changes, volatilization, and mineralization processes.

The intensity and severity of burning and the proportion of the watershed burned are the major factors affecting the influence of prescribed burning on streamflow and water quality (Baker, 1990). Fires that burn intensely on steep slopes close to streams and that remove most of the forest floor and litter down to the mineral soil are most likely

to adversely affect water quality (Golden et al., 1984). The amount of erosion following a fire depends on the following:

- Amount of ground cover remaining on the soil;
- Steepness of slope;
- Time, amount, and intensity of rainfall;
- Intensity of fire;
- Inherent erodibility of the soil; and
- Rapidity of revegetation.

Mersereau and Dyrness (1972) found slash burning on steep slopes to contribute to surface soil movement by removing litter and vegetation, and baring 55 percent of the mineral soil. Richter and others (1982), however, found that periodic, low-intensity prescribed fires had little effect on water quality in the Atlantic and Gulf coastal plain. Revegetation of burned areas also drastically reduces sediment yield from prescribed burning and wildfires (Baker, 1990).

3. Management Measure Selection

This measure is based in part on information and experience gained from studies and from the use of similar management practices by States. To avoid many of the negative impacts from prescribed burning, Pope (1978) recommends that those in charge of managing the fire construct water diversions on firelines in steep terrain to drain the water away from the burn, leave an adequate strip of undisturbed surface between the prescribed burn area and water sources, and avoid intense fires on soils that are uncohesive and highly erodible.

Dyrness (1963) studied the effects of slash burning in the Pacific Northwest, finding that severe burning decreases soil porosity and infiltration capacity, thus increasing the potential for soil erosion. Clayton (1981) found that after the helicopter logging and broadcast burning of slash in the Idaho batholith, erosion increased approximately 10 times the natural rate for a short period of time as the result of to a high-intensity rain storm and then decreased substantially within the following year.

Feller (1981) examined the effects of (1) clearcutting and (2) clearcutting and slash burning on stream temperatures in southwestern British Columbia. Both treatments resulted in increased summer temperatures as well as daily temperature fluctuations. These effects lasted for 7 years in the case of the clearcut stream but longer in the case of the clearcut and slash-burned stream. Clearcutting increased winter temperatures, while slash burning decreased temperatures. The study concluded that clearcutting and slash burning had a greater impact on stream temperatures than did clearcutting alone.

Biswell and Schultz (1957) found that surface runoff and erosion in northern California ponderosa pine forests are not attributable to prescribed burning. While conducting observations during heavy rains, the authors found that the duff and debris left after burning were effective in maintaining high infiltration and percolation capacity, and they traced surface runoff to bare soil areas caused by human activity. A study by Page and Lindenmuth (1971) examined the effects of prescribed fire on vegetation and sediment on a watershed in the oak-mountain mahogany chaparral of central Arizona. The study found that the average sediment movement from the treated drainages during the 5-year period was 0.30 acre-feet per square mile per year, which is substantially less than the sediment loss of 3.2 acre-feet per square mile per year for the first 5 years following a wildfire in a comparable area in Arizona.

Stednick and others (1982) found increased concentrations of suspended sediments, phosphorus, and potassium in streamflows below the burned area after the slash burning of coastal hemlock-spruce forests of southeastern Alaska. Stream monitoring indicated an immediate flush of elements, followed by a slower release of these elements into surface water. No reduction in the nitrogen content or depth of the soil organic horizon was found, but there were significant reductions in the potassium and magnesium contents of the soil.

Minnesota's Landowner Forest Stewardship Plan (1991) estimates the cost for prescribed burning to be \$27/acre.

4. Practices

As discussed more fully at the beginning of this chapter and in Chapter 1, the following practices are described for illustrative purposes only. State programs need not require implementation of these practices. However, as a practical matter, EPA anticipates that the management measure set forth above generally will be implemented by applying one or more management practices appropriate to the source, location, and climate. The practices set forth below have been found by EPA to be representative of the types of practices that can be applied successfully to achieve the management measure described above.

a. Prescribed Fire Practices

■ *Carefully plan burning to adhere to weather, time of year, and fuel conditions that will help achieve the desired results and minimize impacts on water quality.*

Evaluate ground conditions to control the pattern and timing of the burn.

■ *Intense prescribed fire for site preparation should not be conducted in the SMA.*

■ *Piling and burning for slash removal purposes should not be conducted in the SMA.*

■ *Avoid construction of firelines in the SMA.*

■ *In prescriptions for burns, avoid conditions requiring extensive blading of firelines by heavy equipment.*

Use handlines, firebreaks, and hose lays to minimize blading of firelines.

■ *Use natural or in-place barriers (e.g., roads, streams, lakes, wetlands) as an acceptable way to minimize the need for fireline construction in situations where artificial construction of firelines will result in excessive erosion and sedimentation.*

■ *Construct firelines in a manner that minimizes erosion and sedimentation and prevents runoff from directly entering watercourses.*

- Locate firelines on the contour whenever possible, and avoid straight uphill-downhill placement.
- Install grades, ditches, and water bars while the line is being constructed.
- Install water bars on any fireline running up and down the slope, and direct runoff onto a filter strip or sideslope, not into a drainage (Huff and Deal, 1982).
- Construct firelines at a grade of 10 percent or less where possible.
- Adequately cross-ditch all firelines at the time of construction (Megahan, 1983).
- Construct simple diversion ditches or turnouts at intervals as needed to direct surface water off the plowed line and onto undisturbed forest cover for dispersion of water and soil particles.
- Construct firelines only as deep and wide as necessary to control the spread of the fire.

■ *Maintain the erosion control measures on firelines after the burn.*

■ *Revegetate firelines with adapted herbaceous species (Megahan, 1983).*

Refer to the Revegetation of Disturbed Areas management measure for more detailed information.

■ *Execute the burn with a trained crew and avoid intense burning.*

Intense burning can accelerate erosion by consuming the organic cover.

■ *Avoid burning on steep slopes with high-erosion-hazard areas or highly erodible soils.*

b. Wildfire Practices

■ *Whenever possible avoid using fire-retardant chemicals in SMAs and over watercourses, and prevent their runoff into watercourses. Do not clean application equipment in watercourses or locations that drain into watercourses.*

■ *Close water wells excavated for wildfire-suppression activities as soon as practical following fire control.*

■ *Provide advance planning and training for firefighters that considers water quality impacts when fighting wildfires. This can include increasing awareness so direct application of fire retardants to waterbodies is avoided and firelines are placed in the least detrimental position.*

H. Revegetation of Disturbed Areas

Reduce erosion and sedimentation by rapid revegetation of areas disturbed by harvesting operations or road construction:

- (1) Revegetate disturbed areas (using seeding or planting) promptly after completion of the earth-disturbing activity. Local growing conditions will dictate the timing for establishment of vegetative cover.
- (2) Use mixes of species and treatments developed and tailored for successful vegetation establishment for the region or area.
- (3) Concentrate revegetation efforts initially on priority areas such as disturbed areas in SMAs or the steepest areas of disturbance near drainages.

1. Applicability

This management measure pertains to lands where silvicultural or forestry operations are planned or conducted. It is intended to apply to all disturbed areas resulting from harvesting, road building, and site preparation conducted as part of normal silvicultural activities. Disturbed areas are those localized areas within harvest units or road systems where mineral soil is exposed or agitated (e.g., road cuts, fill slopes, landing surfaces, cable corridors, or skid trail ruts).

Under the Coastal Zone Act Reauthorization Amendments of 1990, States are subject to a number of requirements as they develop coastal nonpoint source programs in conformity with this measure and will have some flexibility in doing so. The application of this management measure by States is described more fully in *Coastal Nonpoint Pollution Control Program: Program Development and Approval Guidance*, published jointly by the U.S. Environmental Protection Agency (EPA) and the National Oceanic and Atmospheric Administration (NOAA) of the U.S. Department of Commerce.

2. Description

Revegetation of areas of disturbed soil can successfully prevent sediment and pollutants associated with the sediment (such as phosphorus and nitrogen) from entering nearby surface waters. The vegetation controls soil erosion by dissipating the erosive forces of raindrops, reducing the velocity of surface runoff, stabilizing soil particles with roots, and contributing organic matter to the soil, which increases soil infiltration rates. In areas such as the Pacific Northwest, the construction of forest roads without revegetation has led to significant increases in stream sedimentation. According to Carr and Ballard (1980), studies have found that stream sedimentation increased 250 times during the first rainfalls following construction of a 2.5-km logging road within a 100-hectare watershed and remained higher than an undisturbed companion watershed for the next 2 years.

Vegetation can trap and prevent dry ravel from moving further downslope, and it produces organic matter that is incorporated into the soil, increasing infiltration rates (Berghlund, 1978). Nutrient and soil losses to streams and lakes also can be reduced by revegetating burned, cut over, or otherwise disturbed areas (Crumrine, 1977). In some cases, double plantings are used: an early planting to establish erosion protection quickly and a later planting to provide more permanent protection (Hynson et al., 1982).

3. Management Measure Selection

a. Effectiveness Information

This measure is based in part on information and experience gained from studies and from the use of similar management practices by States. Significant reductions in soil erosion have been achieved by revegetating bare cut-and-fill slopes alongside forest roads. A study of forest roadside slopes at two sites on Vancouver Island, Canada, by Carr and Ballard (1980) found revegetation to be an effective management practice in preventing soil erosion. At the control sites where no plant cover was present, the soil eroded to an average depth of 2-3 cm over 7 months, amounting to an estimated soil loss of 345 cubic meters per kilometer of road. In contrast, sites with hydroseeding had a net accumulation of soil material. In terms of practices, a single hydroseeding application of both seed and fertilizer was as effective as sequential hydroseeding application of seed and fertilizer in terms of preventing soil erosion. The practice of mulching on non-gully-prone soils, as a supplement to hydroseeding, was found to be unnecessary because mulch is incorporated into the hydromulch.

Kuehn and Cobourn (1989) studied the Basic Erosion Rate (BER) for soils on commercial forest land in the Eldorado National Forest and concluded that good ground cover is key to reducing erosion. Figure 3-26 demonstrates the relationship between percent ground cover and slope, and the resulting soil loss. Good ground cover is defined as "living plants within 5 feet of the ground and litter or duff with a depth of 2 inches or more."

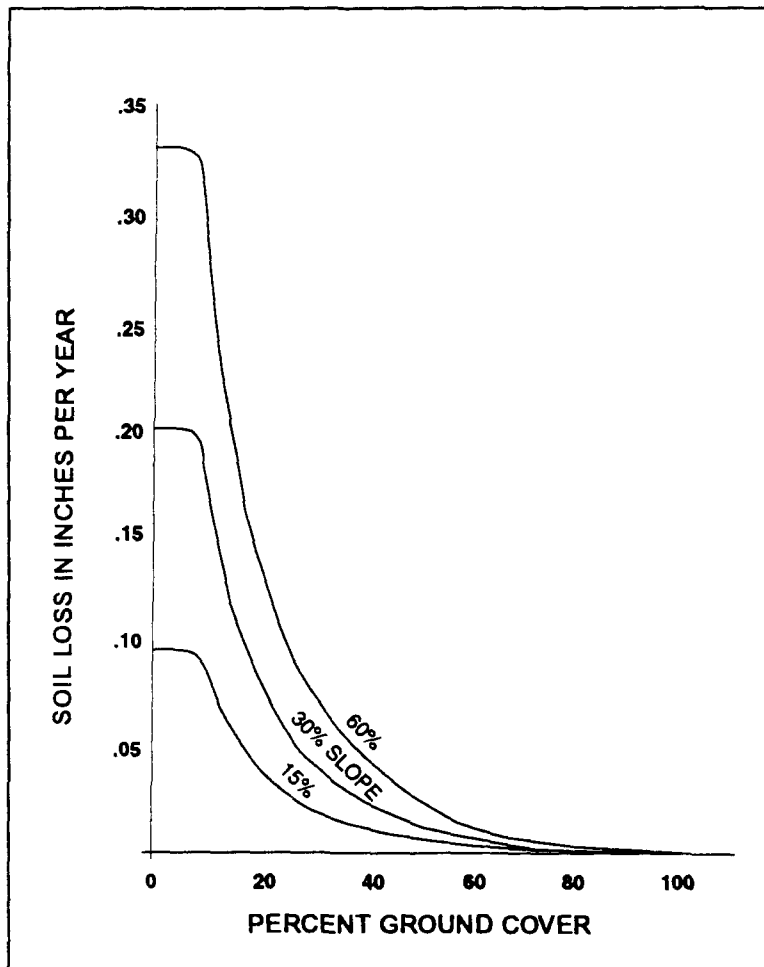

Figure 3-26. Relation of soil loss to good ground cover (Kuehn and Cobourn, 1989).

Seeding was also cited by Berglund (1978) as a successful management practice for controlling erosion along forest roads in Oregon. When establishing a revegetation erosion control program, the author suggested that the program address criteria for seed selection, site preparation guidelines, timing of seeding, application methods, fertilization, and mulching. Several guidelines for seed cover, fertilization, and mulching rates were also presented. For example, Berglund suggests that a vegetative cover of 40 percent or more is necessary to significantly reduce soil erosion from disturbed areas.

Bethlahmy and Kidd (1966) described the extent to which revegetation controls erosion from steep road fills as dependent upon the amount of protection given to the seeded slopes (Table 3-54). Seed and fertilizer alone did not control erosion, but the addition of straw mulch reduced erosion by one-eighth to one-half. Adding more protection, netting as well as mulch, reduced erosion by almost 100 percent to nearly negligible levels.

b. Cost Information

Megahan (1987) found the costs of seeding with plastic netting placed over the seeded area to be almost 50 times more than the costs of dry seeding alone (Table 3-55). The economic impacts of other revegetation management measures were estimated by Dubensky (1991)(Table 3-56). Seeding firelines or rough logging roads adds \$19.75 per 100 feet of road or fireline. Ripping, shaping, and seeding log decks costs about 178.50 per log deck. Fiber for road and landing maintenance adds \$4 per ton used, and water bars add \$12.50 each for construction and seeding.

Lickwar (1989) compared the costs for revegetation of disturbed areas for various slope gradients in the Southeast. He found that revegetation costs decreased slightly as slope decreased; however, costs remained fairly high (Table 3-57). Minnesota's Stewardship Incentives Program (SIP) estimated the costs of reestablishment of permanent vegetation to vary from \$80.00/acre to \$147.00/acre of disturbed area, depending on type of vegetation (Table 3-58).

Table 3-54. Comparison of the Effectiveness of Seed, Fertilizer, Mulch, and Netting in Controlling Cumulative Erosion from Treated Plots on a Steep Road Fill in Idaho (Bethlahmy and Kidd, 1966)

Cumulative Elapsed Time (days)	Cumulative Precipitation (inches)	Control Plot ^a	Erosion (in 1,000 lb/ac) by Plot Number ^b								
			Group A (seed, fertilizer)		Group B (seed, mulch, fertilizer)		Group C (seed, fertilizer, mulch, netting)				
			2	4	3	8	5	6	7		
17	1.41	31.9	38.7	38.0	0.1	32.6	0	0	0		
80	4.71	70.0	99.2	85.7	7.4	34.6	0.9	0	0.3		
157	12.46	72.2	100.2	86.9	11.1	35.1	1.1	0	0.4		
200	15.25	79.1	101.0	87.6	11.4	35.7	1.1	0	0.4		
255	17.02	82.3	102.8	88.8	11.5	35.8	1.1	0	0.4		
322	20.40	84.2	104.7	89.4	11.9	36.0	1.1	0	0.4		

^a The control plot received no treatment at all.
^b Plot 2 had contour furrows, seed, fertilizer, holes.
 Plot 3 had contour furrows, straw mulch, seed, fertilizer, holes.
 Plot 4 had polymer emulsion, seed, fertilizer.
 Plot 5 had straw mulch, paper netting, seed, fertilizer.
 Plot 6 had straw mulch, jute netting, seed, fertilizer.
 Plot 7 had seed, fertilizer, straw mulch, chicken wire netting.
 Plot 8 had seed, fertilizer, straw mulch with asphalt emulsion.

Table 3-55. Costs of Erosion Control Measures (Megahan, 1987)

Measure ^a	Cost (\$/acre)
Dry seeding	124
Plastic netting placed over seeded area	5,662

^a Haber, D.F., and T. Kadoch. 1982. Costs of Erosion Control Measures Used on a Forest Road in the Silver Creek Watershed in Idaho, University of Idaho, Dept. of Civil Engineering.

Table 3-56. Economic Impact of Implementation of Proposed Management Measures on Road Construction and Maintenance (Dubensky, 1991)^a

Management Practice	Increased Cost
Fiber for road and landing construction/maintenance	\$4.00/ton
Ripping, shaping, and seeding log decks	\$178.50/deck
Seeding firelines or rough logging roads	\$19.75/100 ft
Construction and seeding of water bars	\$12.50 each
Construction of rolling dips on roads	\$19.75 each

^a Public comment information provided by the American Paper Institute and the National Forest Products Association.

Table 3-57. Cost Estimates (and Cost as a Percent of Gross Revenues) for Seed, Fertilizer, and Mulch (1987 Dollars) (Lickwar, 1989)

Practice Component	Steep Sites ^a	Moderate Sites ^b	Flat Sites ^c
Seed, fertilizer, and mulch	\$13,625.00 (3.41%)	\$12,849.95 (2.72%)	\$12,258.70 (1.36%)

^a Based on a 1,148-acre forest and gross harvest revenues of \$399,685. Slopes average over 9 percent.

^b Based on a 1,104-acre forest and gross harvest revenues of \$473,182. Slopes ranged from 4 percent to 8 percent.

^c Based on a 1,832-acre forest and gross harvest revenues of \$899,491. Slopes ranged from 0 percent to 3 percent.

Table 3-58. Estimated Costs for Revegetation (1991 Costs) (Minnesota Department of Natural Resources, 1991)

Practice	Total Cost ^a
Establishment of permanent vegetative cover (includes seedbed preparation, fertilizer, chemicals and application, seed, and seeding as prescribed in the plan)	
Introduced grasses	\$80.00/acre
Native grasses	\$147.00/acre

^a The costs shown represent the total cost of the practice. Calculations were made by dividing the maximum Federal cost share by 0.75 to obtain the total cost.

4. Practices

As described more fully at the beginning of this chapter and in Chapter 1, the following practices are described for illustrative purposes only. State programs need not require implementation of these practices. However, as a practical matter, EPA anticipates that the management measure set forth above generally will be implemented by applying one or more management practices appropriate to the source, location, and climate. The practices set forth below have been found by EPA to be representative of the types of practices that can be applied successfully to achieve the management measure described above.

- *Use seed mixtures adapted to the site, and avoid the use of exotic species (Larse, 1971). Species should consist primarily of annuals to allow natural revegetation of native understory plants, and they should have adequate soil-binding properties.*

The selection of appropriate grasses and legumes is important for vegetation establishment. Grasses vary as to climatic adaptability, soil chemistry, and plant growth characteristics (Berglund, 1978). USDA Soil Service technical guides at the State-wide level are excellent sources of information for seeding mixtures and planting prescriptions (Hynson et al., 1982). The U.S. Forest Service, State foresters, and County Extension agents can also provide helpful suggestions (Kochenderfer, 1970). The use of native species is important and practical. Because non-native species can take over and destroy native vegetation, use of non-native species often results in increased maintenance activities and expense, and plenty of hardy native species are usually available (Hynson et al., 1982). In addition to selecting a seeding mixture, the seeding rate must be determined so that adequate soil protection can be achieved without the excess cost of overseeding. Berglund (1978) describes how to determine seeding rates in *Seeding to Control Erosion Along Forest Roads*.

- *On steep slopes, use native woody plants planted in rows, cordons, or wattles.*

These species may be established more effectively than grass and are preferable for binding soils.

- *Seed during optimum periods for establishment, preferably just prior to fall rains (Larse, 1971).*

Timing will depend on the species to be planted and the schedule of operations, which determines when protection is needed (Hynson et al., 1982).

- *Mulch as needed to hold seed, retard rainfall impact, and preserve soil moisture (Larse, 1971).*

Critical, first-year mulch applications provide the necessary ground cover to curb erosion and aid plant establishment (Berglund, 1978). Many different kinds of mulches can be used to improve conditions for germination (Rothwell, 1978). Various materials, including straw, bark, and wood chips, can be used to temporarily stabilize fill slopes and other disturbed areas immediately after construction. In most cases, mulching is used in combination with seeding and planting to establish stable banks. Both the type and the amount of mulch applied vary considerably between regions and depend on the extent of the erosion potential and the available materials (Hynson et al., 1982). Figure 3-27 is a summary of mulching effectiveness in reducing erosion.

- *Fertilize according to site-specific conditions.*

Fertilization is often necessary for successful grass establishment because road construction commonly results in the removal or burial of fertile topsoil (Berglund, 1978). To determine fertilizer formulations, it is best to compare available nitrogen, phosphorus, potassium, and sulphur in the soils to be treated with the requirements of the species to be sown (Rothwell, 1978). It may be necessary to refertilize periodically after vegetation establishment to maintain growth and erosion control capabilities (Larse, 1971; Berglund, 1978).

■ *Protect seeded areas from grazing and vehicle damage until plants are well established.*

If the stand is over 60 percent damaged, reestablish it following the original specifications.

■ *Inspect all seeded areas for failures, and make necessary repairs and reseed within the planting season.*

■ *During non-growing seasons, apply interim surface stabilization methods to control surface erosion.*

Possible methods include mulching (without seeding) and installation of commercially produced matting and blankets. Alternative methods for planting and seeding include hand operations, the use of a wide variety of mechanical seeders, and hydroseeding (Hynson et al., 1982).

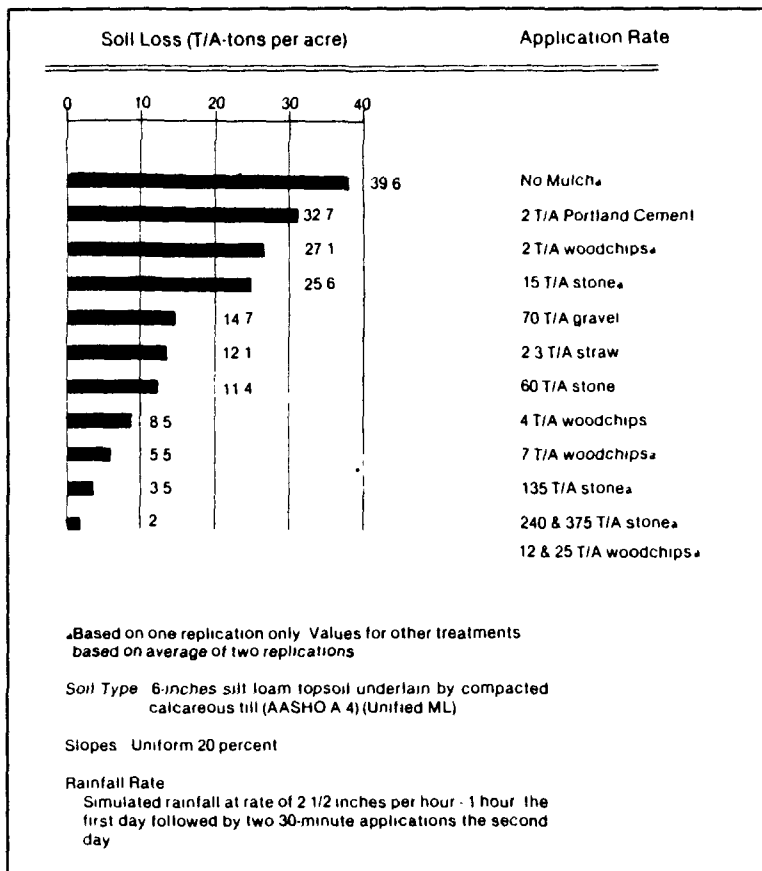

Figure 3-27. Soil losses from a 35-foot long slope by mulch type (Hynson et al., 1982).

I. Forest Chemical Management

Use chemicals when necessary for forest management in accordance with the following to reduce nonpoint source pollution impacts due to the movement of forest chemicals off-site during and after application:

- (1) Conduct applications by skilled and, where required, licensed applicators according to the registered use, with special consideration given to impacts to nearby surface waters.
- (2) Carefully prescribe the type and amount of pesticides appropriate for the insect, fungus, or herbaceous species.
- (3) Prior to applications of pesticides and fertilizers, inspect the mixing and loading process and the calibration of equipment, and identify the appropriate weather conditions, the spray area, and buffer areas for surface waters.
- (4) Establish and identify buffer areas for surface waters. (This is especially important for aerial applications.)
- (5) Immediately report accidental spills of pesticides or fertilizers into surface waters to the appropriate State agency. Develop an effective spill contingency plan to contain spills.

1. Applicability

This management measure pertains to lands where silvicultural or forestry operations are planned or conducted. It is intended to apply to all fertilizer and pesticide applications (including biological agents) conducted as part of normal silvicultural activities.

Under the Coastal Zone Act Reauthorization Amendments of 1990, States are subject to a number of requirements as they develop coastal nonpoint source programs in conformity with this measure and will have some flexibility in doing so. The application of this management measure by States is described more fully in *Coastal Nonpoint Pollution Control Program: Program Development and Approval Guidance*, published jointly by the U.S. Environmental Protection Agency (EPA) and the National Oceanic and Atmospheric Administration (NOAA) of the U.S. Department of Commerce.

2. Description

Chemicals used in forest management are generally pesticides (insecticides, herbicides, and fungicides) and fertilizers. Since pesticides may be toxic, they must be mixed, transported, loaded, and applied properly and their containers disposed of properly in order to prevent potential nonpoint source pollution. Since fertilizers may also be toxic or may shift the ecosystem energy dynamics, depending on the exposure and concentration, they must also be properly handled and applied.

Pesticides and fertilizers are occasionally introduced into forests to reduce mortality of desired tree species, improve forest production, and favor particular plant species. Many forest stands or sites never receive chemical treatment, and of those that do receive treatment, typically no more than two or three applications are made during an entire

tree rotation (40 to 120 years) (Megahan, 1980). Despite the low rate of applications in an area, pesticides can still accumulate within a watershed because there may be many forest sites that receive applications.

Although pesticides and fertilizers are used infrequently in forest operations, they can still pose a risk to the aquatic environment depending on the application technique used (Feller, 1989; Neary, 1985). These chemicals can directly enter surface waters through five major pathways: direct application, drift, mobilization in ephemeral streams, overland flow, and leaching. The input from direct application is the most important source of increased chemical concentrations and is also one of the most easily prevented.

Most adverse water quality effects related to the application of pesticides and fertilizers result from direct application of chemicals to surface waters or from chemical spills (Golden et al., 1984; Fredriksen et al., 1973; Norris and Moore, 1971). Hand application of herbicides generally poses little or no threat to water quality in areas where there is no potential for herbicides to wash into watercourses through gullies (Golden et al., 1984). Norris and Moore (1971) also found that providing buffer areas around streams and waterbodies effectively eliminated adverse water quality effects from forestry chemicals.

3. Management Measure Selection

This measure is based in part on information and experience gained from studies and from use of similar management practices by States. Information on the effects of various pesticide application and fertilization techniques on water quality are summarized in Tables 3-59 through 3-62. Many of the data presented are site-specific or lack clearly specified experimental conditions. However, general trends can be discerned among the studies, and general conclusions on the effectiveness of stream protection practices can be drawn.

a. Pesticide Effects

Most data show that the delivery of pesticides to surface waters from forestry operations is variable, depending on application technique, the presence or absence of buffers, and pesticide characteristics. The studies suggest that negative effects can be greatly reduced by taking precautions to avoid drift or direct application of chemicals to streams and other waterbodies. Norris and Moore (1971) noted that the concentration of 2,4-D in streams after aerial application was one to two orders of magnitude greater in forestry operations without buffers than in areas with buffers (Table 3-59). The elevated concentrations in the nonbuffered area returned to levels comparable to the buffered area after roughly 81 hours from the time of application. Fredriksen and others (1973) noted that in 8 years of monitoring Northwest forest streams for pesticide effects, no herbicide residues were detected in water column samples more than 1 month after aerial application. However, neither aquatic organisms nor sediments were sampled. Herbicide-induced changes in vegetation density and composition may cause indirect effects on streams such as increases in water temperature or nutrient concentration after desiccation of streamside vegetation. Use of unsprayed buffer strips should minimize these effects (Fredriksen et al., 1973).

Riekerk and others (1989) also found that the greatest risk to water quality from pesticide application in forestry operations occurs from aerial applications because of drift, wash-off, and erosion processes. As shown in Table 3-60, they found that aerial applications of herbicides resulted in a surface runoff concentration roughly 3.5 times greater than that of applications to the ground. They suggested that tree injection application methods would be considered the least hazardous for water pollution, but would also be the most labor-intensive.

Norris and others (1991) compiled information from multiple studies that evaluated the peak concentrations of herbicides, insecticides, and fertilizers in soils, lakes, and streams (Table 3-61). These studies were conducted from 1967 to 1987. Norris (1967) found that application of 2,4-D to marshy areas lead to higher-than-normal levels of stream contamination. When ephemeral streams were treated, residue levels of hexazinone and picloram greatly increased with storm-generated flow. Glyphosate was aerially applied (3.3 kg/hectare) to an 8-hectare forest ecosystem in the Oregon Coast Range. The study area contained two ponds and a small perennial stream. All were unbuffered and received direct application of the herbicide. Glyphosate residues were detected for 55 days after application with peak stream concentrations of 0.27 mg/L. It was demonstrated that the concentration of insecticides

Table 3-59. Concentrations of 2,4-D After Aerial Application in Two Treatment Areas (OR) (Norris and Moore, 1971)

Treatment Without Buffers		Treatment With Buffers	
Time After Spraying (hr)	2,4-D (mg/l)	Time After Spraying (hr)	2,4-D (mg/l)
4.7	0.085	5.4	0.001
6.0	0.010	8.7	0.001
7.0	0.026	84.5	0.003
8.0	0.075	168.0	0
9.0	0.059		
13.9	0.051		
26.9	0.003		
37.9	0.009		
78.0	0.008		
80.8	0.001		
168.0	0		

in streams was significantly greater when the chemicals were applied without a buffer strip to protect the watercourse. When streams were unbuffered, the peak concentrations of malathion ranged from 0.037-0.042 mg/L. However, when buffers were provided, the concentrations of malathion were reduced to levels that ranged from undetectable to 0.017 mg/L. The peak concentrations of carbaryl ranged from 0.000-0.0008 mg/L when watercourses were protected with a buffer, but increased to 0.016 mg/L when watercourses were unbuffered.

Another study concluded that the effects of a pellet formulation of picloram applied to an Appalachian mountain forest did not produce any adverse effect on water quality within the 2-year study period (Neary et al., 1985). Similar results were found for a study on the application of sulfometuron methyl in Coastal Plain flatwoods (Neary et al., 1989). These researchers concluded that chemical application should not pose a threat to water quality when chemicals are applied at rates established on the product label and well away from flowing streams.

b. Fertilizer Effects

Moore (1971), as cited in Norris et al. (1991), compared nitrogen loss from a watershed treated with 224 kg urea-N per hectare to nitrogen loss from an untreated watershed. The study demonstrated that the loss of nitrogen from the fertilized watershed was 28.02 kg per hectare while the loss of nitrogen from the unfertilized watershed was only 2.15 kg per hectare (Table 3-62).

Table 3-60. Peak Concentrations in Streamflow from Herbicide Application Methods (Southeastern United States) (Riekerk et. al., 1989)

Method	Residue Levels in Surface Runoff (µg/l)
Ground	< 36
Aerial	< 130

Table 3-61. Peak Concentrations of Forest Chemicals in Soils, Lakes, and Streams After Application (Norris et al., 1991)

Chemicals ^a and System ^b	Application Rate (kg/hectare)	Concentration (mg/L or mg/kg [*])		Time Interval ^c	Time to Non-detection	Source ^d
		Peak	Subsequent			
Herbicides						
2,4-D	2.24	0.001-0.13			1-168 h ^e	17
Marsh	2.24	0.09				17,18
2,4-D BE						
Built pond	23.0					1
Water		3.0	1.0	85 d		
				180 d		
Sediment		8.0 [*]	4.0 [*]	13+ d		
				82-182 d		
Aquatic plants			206 [*]	7 d		
			8 [*]	82 d	182 d	
2,4-D AS						
Reservoir		3.6	0	13 d		7
Picloram						
Runoff		0.078				19
Runoff		0.038				23
Ephemeral stream	2.8	0.32		157 d	915 d	9
Stream	0.37					3
Hexazinone						
Stream (GA)	1.68	0.044		3-4 m		11
Forest (GA)	1.68					14
Liter		0.177 [*]	<0.01 [*]	60+ d		
Soil		0.108 [*]	<0.01 [*]	90 d		
Ephemeral stream		0.514		3 d		
Perennial stream		0.442		3 d		
Atrazine						
Stream	3.0	0.42	0.02	17 d		16
Built ponds						10
Water		0.50	0.05	14 d		
			0.005	56 d		
Sediments		0.50 [*]	0.9 [*]	4 d		
		0.50 [*]	0.25 [*]	56 d		
Triclopyr						
Pasture (OR)	3.34	0.095 [*]				20
Glyphosate						
Water	3.3	0.27	0.09	5.5 h		15
			<0.01	3 d		
Dalapon						
Field irrigation water		0.023-3.65	<0.01	Sev h		5

Table 3-61. (Continued)

Chemicals ^a and System ^b	Application Rate (kg/hectare)	Concentration (mg/L or mg/kg [*])		Time Interval ^c	Time to Non-detection	Source ^d
		Peak	Subsequent			
Insecticides						
Malathion						
Streams	0.91					24
Unbuffered		0.037-0.042				
Buffered		0-0.017				
Carbaryl						
Streams & ponds (E)		0-0.03				24
Streams, unbuffered (PNW)		0.005-0.011			48 h	24
Water	0.84	0.026-0.042				8
Brooks with buffer	0.84	0.001-0.008				22
Rivers with buffer	0.84	0.000-0.002				22
Streams, unbuffered	0.84	0.016				22
Ponds	0.84					6
Water		0.254			100-400 d	
Sediment		<0.01-5.0 [†]				
Acephate						
Streams		0.003-0.961				4
Streams	0.56	0.113-0.135	0.013-0.065	1 d		21
Pond sediment & fish				14 d		2
Fertilizers						
Urea	224					
Urea-N						
Forest stream (OR)		0.39	0.39	48 h		12
Dollar Cr (WA)		44.4				13
NH ₄ ⁺ -N						
Forest stream (OR)		<0.10				12
Tahuya Cr (WA)		1.4				13
NO ₃ ⁺ -N						
Forest stream (OR)		0.168				12
Elochoman R (WA)		4.0				13

^a 2,4-D BE = 2,4-D butoxyethanol ester; 2,4-D AS = 2,4-D amine salt + ester.

^b E = eastern USA; Cr = Creek; GA = Georgia; PNW = Pacific Northwest; OR = Oregon; R = River; WA = Washington; buffer = wooded riparian strip.

^c d = day; h = hours; m = months; sev h = several hours. Intervals are times from application to measurement of peak or subsequent concentration, whichever is the last measurement indicated.

^d 1 = Birmingham and Colman (1985); 2 = Bocsor and O'Connor (1975); 3 = Davis et al. (1968); 4 = Flavell et al. (1977); 5 = Frank et al. (1970); 6 = Gibbs et al. (1984); 7 = Hoeppe and Westerdahl (1983); 8 = Hulbert (1978); 9 = Johnsen (1980); 10 = Maier-Bode (1972); 11 = Mayack et al. (1982); 12 = Moore (1970); 13 = Moore (1975b); 14 = Neary et al. (1983); 15 = Newton et al. (1984); 16 = M. Newton (Oregon State University, personal communication, 1967); 17 = Norris (1967); 18 = Norris (1968); 19 = Norris (1969); 20 = Norris et al. (1987); 21 = Rabeni and Stanley (1979); 22 = Stanley and Trial (1980); 23 = Suffling et al. (1974); 24 = Tracy et al. (1977).

^e Normally less than 48 h.

[†] One extreme case: 23.8 mg/kg peak concentration, 16 months to nondetection.

Studies by Moore (Table 3-61) indicated that the concentrations of urea-N in runoff varied greatly, but that the greatest opportunity for water quality damage from fertilizer application occurred when the chemical directly entered

Table 3-62. Nitrogen Losses from Two Watersheds in Umpqua Experimental Watershed (OR) (Norris et al., 1991)

Loss Locus or Statistic	Urea-N	NH ₃ -N	NO ₃ -N	Total
Absolute loss (kg/hectare)				
Watershed 2 (treated)	0.65	0.28	27.09	28.02
Watershed 4 (untreated)	0.02	0.06	2.07	2.15
Net loss (2-4)	0.63	0.22	25.02	25.87
Proportional loss				
Percent of total	2.44	0.85	96.71	100.00

the waterbody. The peak concentrations were directly proportional to the amount of open surface water within the treated areas, and increases resulted almost entirely from direct applications to surface water. Megahan (1980) summarized data from Moore (1975), who examined changes in water quality following the fertilization of various forest stands with urea. The major observations from this research are summarized as follows (Megahan, 1980):

- Increases in the concentration of urea-N ranged from very low to a maximum of 44 ppm, with the highest concentrations attributed to direct application to water surfaces.
- Higher concentrations occurred in areas where buffer strips were not left beside streambanks.
- Chemical concentrations of urea and its by-products tended to be relatively short-lived due to transport downstream, assimilation by aquatic organisms, or adsorption by stream sediments.

Based on his literature review, Megahan (1980) concluded that the impacts of fertilizer application in forested areas could be significantly reduced by avoiding application techniques that could result in direct deposition into the waterbody and by maintaining a buffer area along the streambank. Malueg and others (1972) and Hetherington (1985) also presented information in support of Megahan's conclusions.

4. Practices

As discussed more fully at the beginning of this chapter and in Chapter 1, the following practices are described for illustrative purposes only. State programs need not require implementation of these practices. However, as a practical matter, EPA anticipates that the management measure set forth above generally will be implemented by applying one or more management practices appropriate to the source, location, and climate. The practices set forth below have been found by EPA to be representative of the types of practices that can be applied successfully to achieve the management measure described above.

■ *For aerial spray applications maintain and mark a buffer area of at least 50 feet around all watercourses and waterbodies to avoid drift or accidental application of chemicals directly to surface water.*

A wider buffer may be needed for major streams and lakes and for application of pesticides with high toxicity to aquatic life. A 100-foot buffer should be used for aerial applications and a 25-foot buffer used for ground spray. Aerial application methods require careful and precise marking of application areas to avoid accidental contamination of open waters (Riekerk, 1989). For specific applications such as hypo hatchet or wick applicator, buffer area widths used for spray applications may be reduced.

■ Apply pesticides and fertilizers during favorable atmospheric conditions.

- Do not apply pesticides when wind conditions increase the likelihood of significant drift.
- Avoid pesticide application when temperatures are high or relative humidity is low because these conditions influence the rate of evaporation and enhance losses of volatile pesticides.

■ Users must abide by the current pesticide label which may specify: whether users must be trained and certified in the proper use of the pesticide; allowable use rates; safe handling, storage, and disposal requirements; and whether the pesticide can only be used under the provision of an approved Pesticide State Management Plan, management measures and practices for pesticides should be consistent with and/or complement those in the approved Pesticide State Management Plans.**■ Locate mixing and loading areas, and clean all mixing and loading equipment thoroughly after each use, in a location where pesticide residues will not enter streams or other waterbodies.****■ Dispose of pesticide wastes and containers according to State and Federal laws.****■ Take precautions to prevent leaks and/or spills.****■ Develop a spill contingency plan that provides for immediate spill containment and cleanup, and notification of proper authorities.**

An adequate spill and cleaning kit that includes the following should be maintained:

- Detergent or soap;
- Hand cleaner and water;
- Activated charcoal, adsorptive clay, vermiculite, kitty litter, sawdust, or other adsorptive materials;
- Lime or bleach to neutralize pesticides in emergency situations;
- Tools such as a shovel, broom, and dustpan and containers for disposal; and
- Proper protective clothing.

■ Apply slow-release fertilizers, when possible.

This practice will reduce potential nutrient leaching to ground water, and it will increase the availability of nutrients for plant uptake.

■ Apply fertilizers during maximum plant uptake periods to minimize leaching.**■ Base fertilizer type and application rate on soil and/or foliar analysis.**

To determine fertilizer formulations, it is best to compare available nitrogen, phosphorus, potassium, and sulphur in the soils to be treated with the requirements of the species to be sown (Rothwell, 1978).

■ Consider the use of pesticides as part of an overall program to control pest problems.

Integrated Pest Management (IPM) strategies have been developed to control forest pests without total reliance on chemical pesticides. The IPM approach uses all available techniques, including chemical and nonchemical. An extensive knowledge of both the pest and the ecology of the affected environment is required for IPM to be effective.

A more in-depth discussion of IPM strategies and components can be found in the Pesticide management measure section of the Agriculture chapter of this guidance.

■ *Base selection of pesticide on site factors and pesticide characteristics.*

These factors include vegetation height, target pest, adsorption to soil organic matter, persistence or half-life, toxicity, and type of formulation.

■ *Check all application equipment carefully, particularly for leaking hoses and connections and plugged or worn nozzles. Calibrate spray equipment periodically to achieve uniform pesticide distribution and rate.*

■ *Always use pesticides in accordance with label instructions, and adhere to all Federal and State policies and regulations governing pesticide use.²*

5. Relationship of Management Measure Components for Pesticides to Other Programs

Under the Federal Insecticide, Fungicide and Rodenticide Act (FIFRA), EPA registers pesticides on the basis of evaluation of test data showing whether a pesticide has the potential to cause unreasonable adverse effects on humans, animals, or the environment. Data requirements include environmental fate data showing how the pesticide behaves in the environment, which are used to determine whether the pesticide poses a threat to ground water or surface water. If the pesticide is registered, EPA imposes enforceable label requirements, which can include, among other things, maximum rates of application, classification of the pesticide as a "restricted use" pesticide (which restricts use to certified applicators trained to handle toxic chemicals), or restrictions on use practices, including requiring compliance with EPA-approved Pesticide State Management Plans (described below). EPA and the U.S. Department of Agriculture Cooperative Extension Service provide assistance for pesticide applicator and certification training in each State.

FIFRA allows States to develop more stringent pesticide requirements than those required under FIFRA, and some States have chosen to do this. At a minimum, management measures and practices under State Coastal Nonpoint Source Programs must not be less stringent than FIFRA label requirements or any applicable State requirements.

EPA's *Pesticides and Groundwater Strategy* (USEPA, 1991) describes the policies and regulatory approaches EPA will use to protect the Nation's ground-water resources from risks of contamination by pesticides under FIFRA. The objective of the strategy is the prevention of ground-water contamination by regulating the use of certain pesticides (i.e., use according to EPA-approved labeling) in order to reduce and, if necessary, eliminate releases of the pesticide in areas vulnerable to contamination. Priority for protection will be based on currently used and reasonably expected sources of drinking water supplies, and ground water that is closely hydrogeologically connected to surface waters. EPA will use Maximum Contaminant Levels (MCLs) under the Safe Drinking Water Act as "reference points" for water resource protection efforts when the ground water in question is a current or reasonably expected source of drinking water.

The Strategy describes a significant new role for States in managing the use of pesticides to protect ground water from pesticides. In certain cases, when there is sufficient evidence that a particular use of a pesticide has the potential for ground-water contamination to the extent that it might cause unreasonable adverse effects, EPA may (through the use of existing statutory authority and regulations) limit legal use of the product to those States with an acceptable Pesticide State Management Plan, approved by EPA. Plans would tailor use to local hydrologic conditions and would address:

² The Federal Insecticide, Fungicide and Rodenticide Act governs the storage and application of pesticides.

- State philosophy;
- Roles and responsibilities of State and local agencies;
- Legal and enforcement authority;
- Basis for assessment and planning;
- Prevention measures;
- Ground-water monitoring;
- Response to detections;
- Information dissemination; and
- Public participation.

In the absence of such an approved Plan, affected pesticides could not be legally used in the State.

Since areas to be managed under Pesticide State Management Plans and Coastal Nonpoint Source Programs can overlap, State coastal zone and nonpoint source agencies should work with the State lead agency for pesticides (or the State agency that has a lead role in developing and implementing the Pesticide State Management Plan) in the development of pesticide management measure components and practices under both programs. This is necessary to avoid duplication of effort and conflicting pesticide requirements between programs. Further, ongoing coordination will be necessary since both programs and management measures will evolve and change with increasing technology and data.

J. Wetlands Forest

Plan, operate, and manage normal, ongoing forestry activities (including harvesting, road design and construction, site preparation and regeneration, and chemical management) to adequately protect the aquatic functions of forested wetlands.

1. Applicability

This management measure is intended for forested wetlands where silvicultural or forestry operations are planned or conducted. It is intended to apply specifically to forest management activities in forested wetlands and to supplement the previous management measures by addressing the operational circumstances and management practices appropriate for forested wetlands. Chapter 7 provides additional information on wetlands and wetland management measures for other, nonforestry source categories and activities.

Under the Coastal Zone Act Reauthorization Amendments of 1990, States are subject to a number of requirements as they develop coastal nonpoint source programs in conformity with this measure and will have some flexibility in doing so. The application of this management measure by States is described more fully in *Coastal Nonpoint Pollution Control Program: Program Development and Approval Guidance*, published jointly by the U.S. Environmental Protection Agency (EPA) and the National Oceanic and Atmospheric Administration (NOAA) of the U.S. Department of Commerce.

This management measure applies specifically to forest management activities in forested wetlands, including those currently undertaken under the exemptions of section 404(f) (40 CFR, Part 232). Many normal, ongoing forestry activities are exempt under section 404(f)(1) unless recaptured under the provisions of section 404(f)(2). This management measure is not intended to prohibit these silvicultural activities but to reduce incidental or indirect effects on aquatic functions as a result of these activities. Chapter 7 provides additional information on wetlands and wetland management measures for other, nonforestry source categories and activities.

2. Description

Forested wetlands provide many beneficial functions that need to be protected. Among these are floodflow alteration, sediment trapping, nutrient retention and removal, provision of important habitat for fish and wildlife, and provision of timber products (Clairain and Kleiss, 1989). The extent of palustrine (forested) wetlands in the continental United States has declined greatly in the past 40 years due to conversion to other land uses, with a net annual loss of 300,000 acres occurring between 1950 and 1970 (Frayer et al., 1983). Forested wetland productivity is dependent upon hydrologic conditions and nutrient cycling, and alteration of a wetland's hydrologic or nutrient-cycling processes can adversely affect wetland functions (Conner and Day, 1989). Refer to Chapter 7 for a wetland definition and a more complete description of the values and functions of wetlands.

The primary difference between forestry activities on wetland sites as compared to activities on upland sites is the result of flooding that occurs in most wetlands during some or most of the year. Potential impacts of forestry operations in wetlands include:

- Sediment production as a result of road construction and use and equipment operation;

- Drainage alteration as a result of improper road construction;
- Stream obstruction caused by failure to remove logging debris;
- Soil compaction caused by operation of logging vehicles during flooding periods or wet weather (skid trails, haul roads, and log landings are areas where compaction is most severe); and
- Contamination from improper application and/or use of pesticides.

The primary adverse impacts associated with road construction in forested wetlands are alteration of drainage and flow patterns, increased erosion and sedimentation, habitat degradation, and damage to existing timber stands. In an effort to prevent these adverse effects, section 404 of the Federal Water Pollution Control Act requires usage of appropriate BMPs for road construction and maintenance in wetlands so that flow and circulation patterns and chemical and biological characteristics are not impaired. Additional section 404(f) BMPs specific to forestry can be found at 40 CFR 232.3.

Harvest planning and selection of the right harvest system are essential in achieving the management objectives of timber production, ensuring stand establishment, and avoiding adverse impacts to water quality and wetland habitat.

The potential impacts of reproduction methods and cutting practices on wetlands include changes in water quality, temperature, nutrient cycling, and aquatic habitat (Toliver and Jackson, 1989). Streams can also become blocked with logging debris if SMAs are not properly maintained or if appropriate practices are not employed in SMAs.

Site preparation includes but is not limited to the use of prescribed fire, chemical, or mechanical site preparation. Extensive site preparation on bottoms where frequent flooding occurs can cause excessive erosion and stream siltation. The degree of acceptable site preparation is governed by the amount and frequency of flooding, soil type, and species suitability, and is dependent upon the regeneration method used.

Clean Water Act section 404 establishes a permit program that regulates the discharge of dredged or fill material into waters of the United States, including certain forested areas that meet the criteria for wetlands. Section 404(f)(1) of the Act provides an exemption from the permitting requirement for discharges in waters of the United States associated with normal, ongoing silviculture operations, including such practices as placement of bedding, cultivation, seeding, timber harvesting, and minor drainage. Section 404(f)(2) clarifies that discharges associated with silviculture activities identified at 404(f)(1) as exempt, are not eligible for the exemption if the proposed discharge involves toxic materials or if they would have the effect of converting waters of the United States, including wetlands, to dry land. Regulations implementing section 404(f), as well as describing applicable best management practices for avoiding impairment of the physical, chemical, and biological characteristics of the waters of the United States, were promulgated by EPA at 40 CFR Part 232.

3. Management Measure Selection

Mader and others (1989) assessed the relative impacts of various timber harvesting methods on different parameters in a forested wetland. On-site ecological responses on a clearcut site following timber harvesting with helicopter and rubber-tired skidder systems were compared to a clearcut, harvested, herbicide-treated area and an undisturbed stand in southwest Alabama. They found total nitrogen concentrations in soil water to be significantly lower for the skidder treatment when compared with all other treatments (Table 3-63). Total phosphorus concentrations were also significantly different for the helicopter treatment as compared to the control stand. Sediment accumulation was greatest for the helicopter treatment and least for the herbicide treatment, and all differences between treatments were significant.

Table 3-63. Total Nitrogen and Phosphorus Concentrations in Soil Water, and Sedimentation During Wet Season Flooding^a (Mader et al., 1989)

Treatment	n ^b	Nutrient Concentration (parts per million)		n	Sediment Accumulation (millimeters)
		TN ^c	TP ^d		
Herbicide	36	11.1 (2.1)	9.8 (2.6)	81	0.7 (0.3)
Skidder	36	7.4 (1.0)	10.1 (2.1)	81	1.2 (0.5)
Helicopter	36	10.6 (1.4)	11.4 (2.0)	81	2.2 (0.6)
Undisturbed	36	11.0 (1.6)	8.8 (2.0)	81	1.1 (0.1)

^a Values are treatment means (\pm SE) of nine replications.

^b n = Number of samples.

^c TN = Total nitrogen in soil water.

^d TP = Total phosphorus in soil water.

4. Practices

As discussed more fully at the beginning of this chapter and in Chapter 1, the following practices are described for illustrative purposes only. State programs need not require implementation of these practices. However, as a practical matter, EPA anticipates that the management measure set forth above generally will be implemented by applying one or more management practices appropriate to the source, location, and climate. The practices set forth below have been found by EPA to be representative of the types of practices that can be applied successfully to achieve the management measure described above.

a. Road Design and Construction Practices

■ *Locate and construct forest roads according to preharvest planning.*

Improperly constructed and located forest roads may cause changes in hydrology, accelerate erosion, reduce or degrade fisheries habitat, and destroy or damage existing stands of timber.

■ *Utilize temporary roads in forested wetlands.*

Permanent roads should be constructed only to serve large and frequently used areas, as approaches to watercourse crossings, or as access for fire protection. Use the minimum design standard necessary for reasonable safety and the anticipated traffic volume.

■ *Construct fill roads only when absolutely necessary for access since fill roads have the potential to restrict natural flow patterns.*

Where construction of fill roads is necessary, use a permeable fill material (such as gravel or crushed rock) for at least the first layer of fill. The use of pervious materials maintains the natural flow regimes of subsurface water. Figures 3-28 and 3-29 demonstrate the impact of impervious and pervious road fills on wetland hydrology. Permeable fill material is not a substitute for using bridges where needed, or for installation of adequately spaced culverts present at all natural drainageways. This practice should be used in conjunction with cross drainage structures to ensure that natural wetland flows are maintained (i.e., so that fill does not become clogged by sediment and obstruct flows (Hynson et al., 1982).

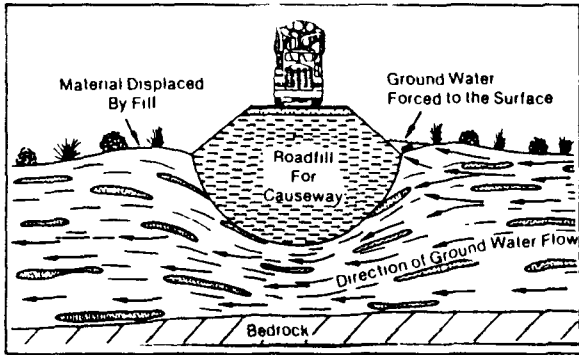

Figure 3-28. Impervious roadfill section placed on wetlands consisting of soft organic sediments with sand lenses. The natural material consolidates and restricts ground-water flow (Hynson et al., 1982).

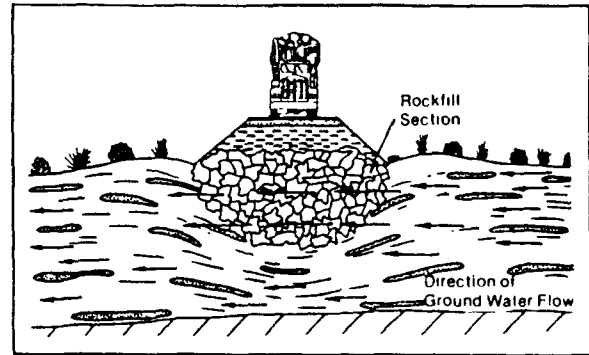

Figure 3-29. Pervious roadfill section on wetland allows movement of ground water through it and minimizes flow changes (Hynson et al., 1982).

■ Provide adequate cross drainage to maintain the natural surface and subsurface flow of the wetland.

This can be accomplished through adequate sizing and spacing of water crossing structures, proper choice of the type of crossing structure, and installation of drainage structures at a depth adequate to pass subsurface flow. Bridges, culverts, and other structures should not perceptibly diminish or increase the duration, direction, or magnitude of minimum, peak, or mean flow of water on either side of the structure (Hynson et al., 1982).

■ Construct roads at natural ground level to minimize the potential to restrict flowing water.

Float the access road fill on the natural root mat. If the consequences of the natural root mat failing are serious, use reinforcement materials such as geotextile fabric, geo-grid mats, or log corduroy. Figure 3-30 depicts a cross section

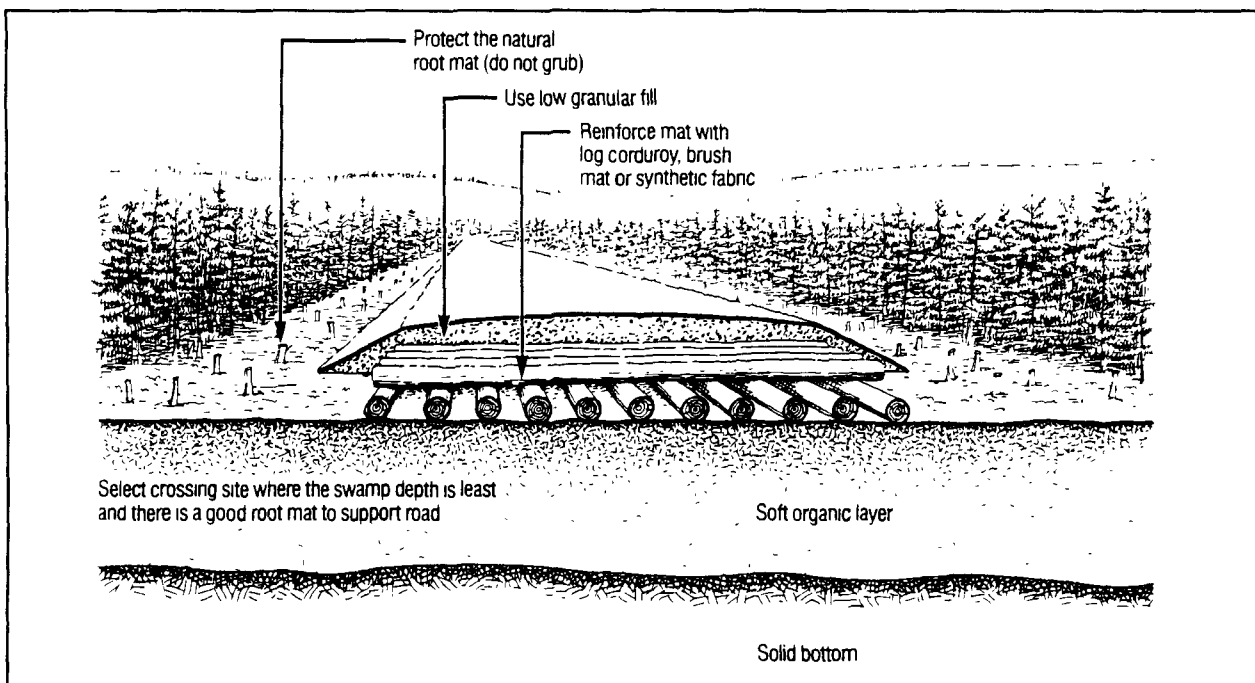

Figure 3-30. Cross section of a wetland road (Ontario Ministry of Natural Resources, 1988).

of the "floating the road" practice. Protect the root mat beneath the roadway from equipment damage. This can be facilitated by diverting through traffic to the edge of the right-of-way, shear-blading stumps instead of grubbing, and using special wide-pad equipment. Also, protect the root mat from damage or puncture by using fill material that does not contain large rocks or boulders.

b. Harvesting Practices

- *Conduct forest harvesting according to preharvest planning designs and locations.*

Planning and close supervision of harvesting operations are needed to protect site integrity and enhance regeneration. Harvesting without regard to season, soil type, or type of equipment can damage the site productivity; retard regeneration; cause excessive rutting, churning, and puddling of saturated soils; and increase erosion and siltation of streams.

- *Establish a streamside management area adjacent to natural perennial streams, lakes, ponds, and other standing water in the forested wetland following the components of the SMA management measure.*

- *Ensure that planned harvest activities or chemical use do not contribute to problems of cumulative effects in watersheds of concern.*

- *Select the harvesting method to minimize soil disturbance and hydrologic impacts to the wetland.*

In seasonally flooded wetlands, a guideline is to use conventional skidder logging that employs equipment with low-ground-pressure tires, cable logging, or aerial logging (Doolittle, 1990). Willingham (1989) compared cable logging to helicopter logging and concluded that helicopter operations caused less site disturbance, were more economical, and provided greater yield. Table 3-64 depicts harvesting systems recommended by the Florida Division of Forestry by type of forested wetland. These recommendations are based on both water quality and economic considerations. Another alternative is to conduct harvesting during winter months when the ground is frozen.

- *When groundskidding, use low-ground-pressure tires or tracked machines and concentrate skidding to a few primary skid trails to minimize site disturbance, soil compaction, and rutting.*

- *When soils become saturated, suspend groundskidding harvesting operations. Use of groundskidding equipment during excessively wet periods may result in unnecessary site disturbance and equipment damage.*

c. Site Preparation and Regeneration Practices

- *Select a regeneration method that meets the site characteristics and management objectives.*

Choice of regeneration method has a major influence on the stand composition and structure and on the silvicultural practices that will be applied over the life of the stand (Toliver and Jackson, 1989). Natural regeneration may be achieved by clearcutting the existing stand and relying on regeneration from seed from adjacent stands, the cut trees, or stumps and from root sprouts (coppice). Successful regeneration depends on recognizing the site type and its characteristics; evaluating the stocking and species composition in relation to stand age and site capability; planning regeneration options; and using sound harvesting methods. Schedule harvest during the dormant season to take advantage of seed sources and to favor coppice regeneration. Harvest trees at a stump height of 12 inches or less when practical to encourage vigorous coppice regeneration. Artificial regeneration may be accomplished by planting seedlings or direct seeding. Table 3-65 contains the regeneration system recommendations of the Georgia Forestry Association.

Table 3-64. Recommended Harvesting Systems by Forested Wetland Site^a
(Florida Department of Agriculture and Consumer Services, 1988)

Site Type	Conventional	Conventional with Controlled Access ^b	Cable or Aerial	Barge or High Flotation Boom
Flowing Water				
<i>Mineral Soil</i>				
Alluvial River Bottom	B	A	C	C
<i>Organic Soil</i>				
Black River Bottom	B	A	C	C
Branch Bottom	A ^c	B	C	C
Cypress Strand	B	A	A	A
Muck Swamp	C	A	A	A
Nonflowing Water				
<i>Mineral Soil</i>				
Wet Hammock	B	A	C	C
<i>Organic Soil</i>				
Cypress Dome	B	A	A	A
Peat Swamp	C	A	A	A

A = recommended; B = recommended when dry; C = not recommended.

^a Recommendations include cost considerations

^b Preplanned and designated skid trails and access roads.

^c Log from the hill (high ground).

■ *Conduct mechanized site preparation and planting sloping areas on the contour.*

■ *To reduce disturbance, conduct bedding operations in high-water-table areas during dry periods of the year.*

The degree of acceptable site preparation depends on the amount and frequency of flooding, the soil type, and the species suitability.

Minimize soil degradation by limiting operations on saturated soils.

d. Chemical Management Practices

■ *Apply herbicides by injection or application in pellet form to individual stems.*

■ *For chemical and aerial fertilizer applications, maintain and mark a buffer area of at least 50 feet around all surface water to avoid drift or accidental direct application.*

Avoid application of pesticides with high toxicity to aquatic life, especially aerial applications.

**Table 3-65. Recommended Regeneration Systems by Forested Wetland Type
(Georgia Forestry Association, 1990)**

Type	Natural Regeneration				Artificial Regeneration		
	Clearcut	Group Selection	Shelter Wood	Seed ^a Tree	Mechanical Site Prep.	Plant	Direct Seed
Flood Plains, Terraces, Bottomland							
Black River	A	B	B	C	D	C	C
Red River	A	B	B	C	D	B	B
Branch Bottoms	A	B	B	C	D	C	C
Piedmont Bottoms	A	B	B	C	D	B	B
Muck Swamps	A	C	C	C	D	C	C
Wet Flats							
Pine Hammocks & Savannahs	A	B	B	B	A	A	B
Pocosins or Bays	A	C	B	B	B	B	B
Cypress Strands	A	C	C	C	D	C	C
Cypress Domes: Peat Swamps							
Peat Swamps	A	C	C	C	C	C	C
Cypress Domes	A	C	C	C	D	C	C
Gulfs, Coves, Lower Slopes	A	B	B	C	C	B	C

A = highly effective; B = effective; C = less effective; D = not recommended.

^a Seed tree cuts are not recommended on first terraces of flood plains, terraces, and bottomland.

■ *Apply slow-release fertilizers, when possible.*

This practice will reduce the potential of the nutrients leaching to ground water, and it will increase the availability of nutrients for plant uptake.

■ *Apply fertilizers during maximum plant uptake periods to minimize leaching.*

■ *Base fertilizer type and application rate on soil and/or foliar analysis.*

To determine fertilizer formulations, it is best to compare available nitrogen, phosphorus, potassium, and sulphur in the soils to be treated with the requirements of the species to be sown.

III. GLOSSARY

Access road: A temporary or permanent road over which timber is transported from a loading site to a public road. Also known as a haul road.

Alignment: The horizontal route or direction of an access road.

Allochthonous: Derived from outside a system, such as leaves of terrestrial plants that fall into a stream.

Angle of repose: The maximum slope or angle at which a material, such as soil or loose rock, remains stable (stable angle).

Apron: Erosion protection placed below the streambed in an area of high flow velocity, such as downstream from a culvert.

Autochthonous: Derived from within a system, such as organic matter in a stream resulting from photosynthesis by aquatic plants.

Bedding: A site preparation technique whereby a small ridge of surface soil is formed to provide an elevated planting or seed bed. It is used primarily in wet areas to improve drainage and aeration for seeding.

Berm: A low earth fill constructed in the path of flowing water to divert its direction, or constructed to act as a counterweight beside the road fill to reduce the risk of foundation failure (buttress).

Borrow pit: An excavation site outside the limits of construction that provides necessary material, such as fill material for embankments.

Broad-based dip: A surface drainage structure specifically designed to drain water from an access road while vehicles maintain normal travel speeds.

Brush barrier: A sediment control structure created of slash materials piled at the toe slope of a road or at the outlets of culverts, turnouts, dips, and water bars.

Buck: To saw felled trees into predetermined lengths.

Buffer area: A designated area around a stream or waterbody of sufficient width to minimize entrance of forestry chemicals (fertilizers, pesticides, and fire retardants) into the waterbody.

Cable logging: A system of transporting logs from stump to landing by means of steel cables and winch. This method is usually preferred on steep slopes, wet areas, and erodible soils where tractor logging cannot be carried out effectively.

Check dam: A small dam constructed in a gully to decrease the flow velocity, minimize channel scour, and promote deposition of sediment.

Chopping: A mechanical treatment whereby vegetation is concentrated near the ground and incorporated into the soil to facilitate burning or seedling establishment.

Clearcutting: A silvicultural system in which all merchantable trees are harvested within a specified area in one operation to create an even-aged stand.

Contour: An imaginary line on the surface of the earth connecting points of the same elevation. A line drawn on a map connecting the points of the same elevation.

Crown: A convex road surface that allows runoff to drain to either side of the road prism.

Culvert: A metal, wooden, plastic, or concrete conduit through which surface water can flow under or across roads.

Cumulative effect: The impact on the environment that results from the incremental impact of an action when added to other past, present, and reasonably foreseeable future actions regardless of what agency or person undertakes such action.

Cut-and-fill: Earth-moving process that entails excavating part of an area and using the excavated material for adjacent embankments or fill areas.

DBH: Diameter at breast height; the average diameter (outside the bark) of a tree 4.5 feet above mean ground level.

Disking (harrowing): A mechanical method of scarifying the soil to reduce competing vegetation and to prepare a site to be seeded or planted.

Diversion: A channel with a supporting ridge on the lower side constructed across or at the bottom of a slope for the purpose of intercepting surface runoff.

Drainage structure: Any device or land form constructed to intercept and/or aid surface water drainage.

Duff: The accumulation of needles, leaves, and decaying matter on the forest floor.

Ephemeral stream: A channel that carries water only during and immediately following rainstorms. Sometimes referred to as a dry wash.

Felling: The process of cutting down standing trees.

Fill slope: The surface formed where earth is deposited to build a road or trail.

Firebreak: Naturally occurring or man-made barrier to the spread of fire.

Fireline: A barrier used to stop the spread of fire constructed by removing fuel or rendering fuel inflammable by use of fire retardants.

Ford: Submerged stream crossing where tread is reinforced to bear intended traffic.

Forest filter strip: Area between a stream and construction activities that achieves sediment control by using the natural filtering capabilities of the forest floor and litter.

Forwarding: The operation of moving timber products from the stump to a landing for further transport.

Geotextile: A product used as a soil reinforcement agent and as a filter medium. It is made of synthetic fibers manufactured in a woven or loose nonwoven manner to form a blanket-like product.

Grade (gradient): The slope of a road or trail expressed as a percentage of change in elevation per unit of distance traveled.

Harvesting: The felling, skidding, processing, loading, and transporting of forest products.

Haul road: See *access road*.

Intermittent stream: A watercourse that flows in a well-defined channel only in direct response to a precipitation event. It is dry for a large part of the year.

Landing (log deck): A place in or near the forest where logs are gathered for further processing or transport.

Leaching: Downward movement of a soluble material through the soil as a result of water movement.

Logging debris (slash): The unwanted, unutilized, and generally unmerchantable accumulation of woody material, such as large limbs, tops, cull logs, and stumps, that remains as forest residue after timber harvesting.

Merchantable: Forest products suitable for marketing under local economic conditions. With respect to a single tree, it means the parts of the bole or stem suitable for sale.

Mineral soil: Organic-free soil that contains rock less than 2 inches in maximum dimension.

Mulch: A natural or artificial layer of plant residue or other materials covering the land surface that conserves moisture, holds soil in place, aids in establishing plant cover, and minimizes temperature fluctuations.

Mulching: Providing any loose covering for exposed forest soils, such as grass, straw, bark, or wood fibers, to help control erosion and protect exposed soil.

Muskeg: A type of bog that has developed over thousands of years in depressions, on flat areas, and on gentle to steep slopes. These bogs have poorly drained, acidic, organic soils supporting vegetation that can be (1) predominantly sphagnum moss; (2) herbaceous plants, sedges, and rushes; (3) predominantly sedges and rushes; or (4) a combination of sphagnum moss and herbaceous plants. These bogs may have some shrub and stunted conifers, but not enough to classify them as forested lands.

Ordinary high water mark: An elevation that marks the boundary of a lake, marsh, or streambed. It is the highest level at which the water has remained long enough to leave its mark on the landscape. Typically, it is the point where the natural vegetation changes from predominantly aquatic to predominantly terrestrial.

Organic debris: Particles of vegetation or other biological material that can degrade water quality by decreasing dissolved oxygen and by releasing organic solutes during leaching.

Outslope: To shape the road surface to cause drainage to flow toward the outside shoulder.

Patch cutting method: A silvicultural system in which all merchantable trees are harvested over a specified area at one time.

Perennial stream: A watercourse that flows throughout a majority of the year in a well-defined channel.

Persistence: The relative ability of a pesticide to remain active over a period of time.

Pioneer roads: Temporary access ways used to facilitate construction equipment access when building permanent roads.

Prescribed burning: Skillful application of fire to natural fuels that allows confinement of the fire to a predetermined area and at the same time produces certain planned benefits.

Raking: A mechanical method of removing stumps, roots, and slash from a future planting site.

Regeneration: The process of replacing older trees removed by harvest or disaster with young trees.

Residual trees: Live trees left standing after the completion of harvesting.

Right-of-way: The cleared area along the road alignment that contains the roadbed, ditches, road slopes, and back slopes.

Riprap: Rock or other large aggregate that is placed to protect streambanks, bridge abutments, or other erodible sites from runoff or wave action.

Rut: A depression in access roads made by continuous passage of logging vehicles.

Salvage harvest: Removal of trees that are dead, damaged, or imminently threatened with death or damage in order to use the wood before it is rendered valueless by natural decay agents.

Sanitation harvest: Removal of trees that are under attack by or highly susceptible to insect and disease agents in order to check the spread of such agents.

Scarification: The process of removing the forest floor or mixing it with the mineral soil by mechanical action preparatory to natural or direct seeding or the planting of tree seedlings.

Scour: Soil erosion when it occurs underwater, as in the case of a streambed.

Seed bed: The soil prepared by natural or artificial means to promote the germination of seeds and the growth of seedlings.

Seed tree method: Removal of the mature timber in one cutting, except for a limited number of seed trees left singly or in small groups.

Selection method: An uneven-aged silvicultural system in which mature trees are removed, individually or in small groups, from a given tract of forestland over regular intervals of time.

Shearing: A site preparation method that involves the cutting of brush, trees, or other vegetation at ground level using tractors equipped with angles or V-shaped cutting blades.

Shelterwood method: Removal of the mature timber in a series of cuttings that extend over a relatively short portion of the rotation in order to encourage the establishment of essentially even-aged reproduction under the partial shelter of seed trees.

Silt fence: A temporary barrier used to intercept sediment-laden runoff from small areas.

Silvicultural system: A process, following accepted silvicultural principles, whereby the tree species constituting forests are tended, harvested, and replaced. Usually defined by, but not limited to, the method of regeneration.

Site preparation: A silvicultural activity to remove unwanted vegetation and other material, and to cultivate or prepare the soil for regeneration.

Skid: Short-distance moving of logs or felled trees from the stump to a point of loading.

Skid trail: A temporary, nonstructural pathway over forest soil used to drag felled trees or logs to the landing.

Slash: See *logging debris*.

Slope: Degree of deviation of a surface from the horizontal, measured as a numerical ratio, as a percent, or in degrees. Expressed as a ratio, the first number is the horizontal distance (run) and the second number is the vertical

distance (rise), as 2:1. A 2:1 slope is a 50 percent slope. Expressed in degrees, the slope is the angle from the horizontal plane, with a 90 degree slope being vertical (maximum) and a 45 degree slope being a 1:1 slope.

Stand: A contiguous group of trees sufficiently uniform in species composition, arrangement of age classes, and condition to be a homogeneous and distinguishable unit.

Streamside management area (SMA): A designated area that consists of the stream itself and an adjacent area of varying width where management practices that might affect water quality, fish, or other aquatic resources are modified. The SMA is not an area of exclusion, but an area of closely managed activity. It is an area that acts as an effective filter and absorptive zone for sediments; maintains shade; protects aquatic and terrestrial riparian habitats; protects channels and streambanks; and promotes floodplain stability.

Tread: Load-bearing surface of a trail or road.

Turnout: A drainage ditch that drains water away from roads and road ditches.

Water bar: A diversion ditch and/or hump installed across a trail or road to divert runoff from the surface before the flow gains enough volume and velocity to cause soil movement and erosion, and deposit the runoff into a dispersion area. Water bars are most frequently used on retired roads, trails, and landings.

Watercourse: A definite channel with bed and banks within which concentrated water flows continuously, frequently or infrequently.

Windrow: Logging debris and unmerchantable woody vegetation that has been piled in rows to decompose or to be burned; or the act of constructing these piles.

Yarding: Method of transport from harvest area to storage landing.

IV. REFERENCES

- Adams, P.W. 1991. Maintaining Woodland Roads. *The Woodland Workbook*. Oregon State University Extension Service, Extension Circular 1139.
- Alabama Forestry Commission. 1989. *Water Quality Management Guidelines and Best Management Practices for Alabama Wetlands*.
- Baker, M.B. 1990. *Hydrologic and Water Quality Effects of Fire*. USDA Forest Service, Rocky Mountain Forest and Range Experiment Station. General Technical Report RM-191, pp. 31-42.
- Beasley, R.S. 1979. Intensive Site Preparation and Sediment Loss on Steep Watersheds in the Gulf Coast Plain. *Soil Science Society of America Journal*, 43(3):412-417.
- Beasley, R.S., and A.B. Granillo. 1985. Water Yields and Sediment Losses from Chemical and Mechanical Site Preparation. In *Forestry and Water Quality - A Mid-South Symposium*, Arkansas Cooperative Extension Service, pp.106-116.
- Beasley, R.S., and A.B. Granillo. 1988. Sediment and Water Yields from Managed Forests on Flat Coastal Plain Soils. *Water Resources Bulletin*, 24(2):361-366.
- Beasley, R.S., E.L. Miller, and S.C. Gough. 1984. Forest Road Erosion in the Ouachita Mountains. In *Mountain Logging Symposium Proceeding, June 5-7, 1984*, ed. P.A. Peters and J. Luckok, pp.203-213. West Virginia University.
- Berglund, E.R. 1978. *Seeding to Control Erosion Along Forest Roads*. Oregon State University Extension Service, Extension Circular 885.
- Bethlahmy, N., and W.J. Kidd, Jr. 1966. *Controlling Soil Movement from Steep Road Fills*. USDA Forest Service Research Note INT-45.
- Bilby, R.E. 1984. Removal of Woody Debris May Affect Stream Channel Stability. *Journal of Forestry*, 609-613.
- Biswell, H.H., and A.M. Schultz. 1957. Surface Runoff and Erosion as Related to Prescribed Burning. *Journal of Forestry*, 55:372-374.
- Blackburn, W.H., M.G. DeHaven, and R.W. Knight. 1982. Forest Site Preparation and Water Quality in Texas. In *Proceedings of the Specialty Conference on Environmentally Sound Water and Soil Management*, ASCE, Orlando, Florida, July 20-23, 1982, ed. E.G. Kruse, C.R. Burdick, and Y.A. Yousef, pp. 57-66.
- Brazier, J.R., and G.W. Brown. 1973. *Buffer Strips for Stream Temperature Control*. Oregon State University School of Forestry, Forest Research Laboratory, Corvallis, OR, Research Paper 15.
- Brown, G.W. 1972. Logging and Water Quality in the Pacific Northwest. In *Watersheds in Transition Symposium Proceedings, Urbana, IL*, pp. 330-334. American Water Resources Association.
- Brown, G.W. 1974. *Fish Habitat*. USDA Forest Service. General Technical Report PNW-24, pp. E1-E15.
- Brown, G.W. 1985. Controlling Nonpoint Source Pollution from Silvicultural Operations: What We Know and Don't Know. In *Perspectives on Nonpoint Source Pollution*, pp. 332-333. U.S. Environmental Protection Agency.
- Brown, G.W., and J.T. Krygier. 1970. Effects of Clearcutting on Stream Temperature. *Water Resources Research*, 6(4):1133-1140.

- Brown, G.W., and J.T. Krygier. 1971. Clear-cut Logging and Sediment Production in the Oregon Coast Range. *Water Resources Research*, 7(5):1189-1199.
- California Department of Forestry and Fire Protection. 1991. *California Forest Practice Rules*.
- Carr, W.W., and T.M. Ballard. 1980. Hydroseeding Forest Roadsides in British Columbia for Erosion Control. *Journal of Soil and Water Conservation*, 35(1):33-35.
- Clairain, E.J., and B.A. Kleiss. 1989. Functions and Values of Bottomland Hardwood Forests Along the Cache River, Arkansas: Implications for Management. In *Proceedings of the Symposium: The Forested Wetlands of the Southern United States, Orlando, Florida, July 12-14, 1988*. USDA Forest Service General Technical Report SE-50, pp. 27-33.
- Clayton, J.L. 1981. *Soil Disturbance Caused by Clearcutting and Helicopter Yarding in the Idaho Batholith*. USDA Forest Service Research Note INT-305.
- Coats, R.N., and T.O. Miller. 1981. Cumulative Silvicultural Impacts on Watersheds: A Hydrologic and Regulatory Dilemma. *Environmental Management*, 5(2):147-160.
- Connecticut Resource Conservation and Development Forestry Committee. 1990. *A Practical Guide for Protecting Water Quality While Harvesting Forest Products*.
- Conner, W.H., and J.W. Day, Jr. 1989. Response of Coastal Wetland Forests to Human and Natural Changes in the Environment With Emphasis on Hydrology. In *Proceedings of the Symposium: The Forested Wetlands of the Southern United States, Orlando, Florida, July 12-14, 1988*. USDA Forest Service General Technical Report SE-50, pp. 34-43.
- Corbett, E.S., and J.A. Lynch. 1985. Management of Streamside Zones on Municipal Watersheds. In *Conference on Riparian Ecosystems and their Management: Reconciling Conflicting Uses, April 16-18, Tucson, Arizona*, pp. 187-190.
- Crumrine, J.P. 1977. Best Management Practices for the Production of Forest Products and Water Quality. In *"208" Symposium on Non-Point Sources of Pollution from Forested Land*, ed. G.M. Aubertin, Southern Illinois University, Carbondale, IL, pp. 267-274.
- Cubbage, F.W., W.C. Siegel, and P.M. Lickwar. 1989. State Water Quality Laws and Programs to Control Nonpoint Source Pollution from Forest Lands in the South. In *Water: Laws and Management*, ed. F.E. Davis, pp. 8A-29 to 8A-37. American Water Resources Association.
- Cullen, J.B. Undated. *Best Management Practices for Erosion Control on Timber Harvesting Operations in New Hampshire, Resource Manual*. New Hampshire Department of Resources and Economic Development, Division of Forests and Lands, Forest Information and Planning Bureau.
- Curtis, J.G., D.W. Pelren, D.B. George, V.D. Adams, and J.B. Layzer. 1990. *Effectiveness of Best Management Practices in Preventing Degradation of Streams Caused by Silvicultural Activities in Pickett State Forest, Tennessee*. Tennessee Technological University, Center for the Management, Utilization and Protection of Water Resources.
- Delaware Forestry Association. 1982. *Forestry Best Management Practices for Delaware*.
- Dickerson, B.P. 1975. Stormflows and Erosion after Tree-Length Skidding on Coastal Plains Soils. *Transactions of the ASAE*, 18:867-868,872.

- Dissmeyer, G.E. 1980. Predicted Erosion Rates for Forest Management Activities and Conditions in the Southeast. In *U.S. Forestry and Water Quality: What Course in the 80s? Proceedings*, Richmond, VA, June 19-20, 1980, pp. 42-49. Water Pollution Control Federation.
- Dissmeyer, G.E. 1986. Economic impacts of erosion control in forests. In *Proceedings of the Southern Forestry Symposium, November 19-21, 1985, Atlanta, GA*, ed. S. Carpenter, Oklahoma State University Agricultural Conference Series, pp. 262-287.
- Dissmeyer, G.E., and B. Foster. 1987. Some Economic Benefits of Protecting Water Quality. In *Managing Southern Forests for Wildlife and Fish: A Proceedings*. USDA Forest Service General Technical Report SO-65, pp. 6-11.
- Dissmeyer, G.E. and E. Frandsen. 1988. *The Economics of Silvicultural Best Management Practices*. American Water Resources Association, Bethesda, MD. pp. 77-86.
- Dissmeyer, G.E., and R. Miller. 1991. *A Status Report on the Implementation of the Silvicultural Nonpoint Source Program in the Southern States*.
- Dissmeyer, G.E. and R.F. Stump. 1978. *Predicted Erosion Rates for Forest Management Activities in the Southeast*. USDA Forest Service.
- Doolittle, G.B. 1990. The Use of Expert Assessment in Developing Management Plans for Environmentally Sensitive Wetlands: Updating A Case Study in Champion International's Western Florida Region. *Best Management Practices for Forested Wetlands: Concerns, Assessment, Regulation and Research*. NCASI Technical Bulletin No. 583, pp. 66-70.
- Douglass, J.E., and W.T. Swank. 1975. Effects of Management Practices on Water Quality and Quantity: Coweeta Hydrologic Laboratory, North Carolina. In: *Municipal Watershed Management Symposium Proceedings*. USDA Forestry Service. General Technical Report NE-13, pp. 1-13.
- Dubensky, M.M. 1991. Public comment information provided by the American Paper Institute and National Forest Products Association.
- Dunford, E.G. 1962. Logging Methods in Relation to Stream Flow and Erosion. In *Fifth World Forestry Congress 1960 Proceedings*, 3:1703-1708.
- Dykstra, D.P., and Froehlich, H.A. 1976a. Costs of Stream Protection During Timber Harvest. *Journal of Forestry*, 74(10):684-687.
- Dykstra, D.P., and H.A. Froehlich. 1976b. Stream protection: What does it cost? In *Loggers Handbook*, Pacific Logging Congress, Portland, OR.
- Dymess, C.T. 1963. Effects of Burning on Soil. In *Symposium on Forest Watershed Management*, Society of American Foresters and Oregon State University, March 25-28, 1963, pp. 291-304.
- Dymess, C.T. 1967. *Mass Soil Movements in the H.J. Andrews Experimental Forest*. USDA Forest Service, Pacific Northwest Forest and Range Experiment Station. Research Paper PNW-42.
- Dymess, C.T. 1970. *Stabilization of Newly Constructed Road Backslopes by Mulch and Grass-Legume Treatments*. USDA Forest Service, Pacific Northwest Forest and Range Experiment Station. PNW-123.
- Ellefson, P.V., and P.D. Miles. 1984. Economic Implications of Managing Nonpoint Forest Sources of Water Pollutants: A Midwestern Perspective. In *Mountain Logging Symposium Proceedings*, June 5-7, 1984, West Virginia University, ed. P.A. Peters and J. Luchok, pp. 107-119.

- Ellefson, P.V., and R.E. Weible. 1980. Economic Impact of Prescribing Forest Practices to Improve Water Quality: A Minnesota Case Study Minnesota. *Forestry Research Notes*.
- Erman, D.C., J.D. Newbold, and K.B. Roby. 1977. *Evaluation of Streamside Buffer Strips for Protecting Aquatic Organisms*. California Water Resources Center, University of California, Davis, CA.
- Eschner, A.R., and J. Larmoyeux. 1963. Logging and Trout: Four Experimental Forest Practices and their Effect on Water Quality. *Progress in Fish Culture*, 25:59-67.
- Essig, D.A. 1991. *Implementation of Silvicultural Nonpoint Source Programs in the United States, Report of Survey Results*. National Association of State Foresters.
- Everst, F.H., and W.R. Meehan. 1981. Forest Management and Anadromous Fish Habitat Productivity. In *Transactions of the 46th North American Wildlife and Natural Resources Conference*, pp. 521-530. Wildlife Management Institute, Washington, DC.
- Feller, M.C. 1981. Effects of Clearcutting and Slash Burning on Stream Temperature in Southwestern British Columbia. *Water Resources Bulletin*, 17(5):863-866.
- Feller, M.C. 1989. Effects of Forest Herbicide Applications on Streamwater Chemistry in Southwestern British Columbia. *Water Resources Bulletin*, 25(3):607-616.
- Florida Department of Agriculture and Consumer Services, Division of Forestry and Florida Forestry Association. 1988. *Management Guidelines for Forested Wetlands in Florida*.
- Florida Department of Agriculture and Consumer Services, Division of Forestry. 1991. *Silviculture Best Management Practices*.
- Framer, W.E., T.J. Monahan, D.C. Bowden, and F.A. Graybill. 1983. *Status and Trends of Wetlands and Deepwater Habitats in the Conterminous United States, 1950's to 1970's*. Colorado State University Department of Forest and Wood Sciences, Fort Collins, CO.
- Fredriksen, R.L., and R.N. Ross. 1974. Timber Production and Water Quality — Progress in Planning for the Bull Run, Portland Oregon's Municipal Watershed. In *Proceedings of the Society of American Foresters*, pp. 168-186.
- Fredriksen, R.L., D.G. Moore, and L.A. Norris. 1973. The Impact of Timber Harvest, Fertilization, and Herbicide Treatment on Streamwater Quality in Western Oregon and Washington. In *Forest Soils and Forest Land Management, Proceedings of the Fourth North American Forest Soils Conference*, ed. B. Bernier and C.H. Winget, pp. 283-313.
- Froehlich, H.A. 1973. Natural and man-caused slash in headwater streams. *Loggers Handbook*, Pacific Logging Congress, Vol. XXXIII.
- Furniss, M.J., T.D. Roelofs, and C.S. Yee. 1991. Road Construction and Maintenance. *Influences of Forest and Rangeland Management on Salmonid Fishes and Their Habitats*. American Fisheries Society Special Publication 19, pp. 297-324.
- Gardner, R.B. 1967. Major Environmental Factors That Affect the Location, Design, and Construction of Stabilized Forest Roads. *Loggers Handbook*, vol. 27. Pacific Logging Congress, Portland, OR.
- Georgia Forestry Association, Wetlands Committee. 1990. *Best Management Practices for Forested Wetlands in Georgia*.

- Georgia Forestry Commission. 1988. *Recommended Best Management Practices for Forestry in Georgia*.
- Gibson, H.E., and C.J. Biller. 1975. A Second Look at Cable Logging in the Appalachians. *Journal of Forestry*, 73(10):649-653.
- Golden, M.S., C.L. Tuttle, J.S. Kush, and J.M. Bradley. 1984. *Forestry Activities and Water Quality in Alabama: Effects, Recommended Practices, and an Erosion-Classified System*. Auburn University Agricultural Experiment Station, Bulletin 555.
- Hall, J.D., G.W. Brown, and R.L. Lantz. 1987. The Alsea Watershed Study - A Retrospective. In *Managing Oregon's Riparian Zone for Timber, Fish and Wildlife*, NCASI Technical Bulletin No. 514, pp. 35-40.
- Hartman, G., J.C. Scrivener, L.B. Holtby, and L. Powell. 1987. Some Effects of Different Streamside Treatments on Physical Conditions and Fish Population Processes in Carnation Creek, A Coastal Rain Forest Stream in British Columbia. In *Streamside Management: Forestry and Fishery Interactions*, ed. E.O. Salo and T.W. Cundy. College of Forest Resources, University of Washington, Seattle, WA, pp. 330-372.
- Hausman, R.F., and E.W. Pruett. 1978. *Permanent Logging Roads for Better Woodlot Management*. USDA Forest Service, State and Private Forestry, Eastern Region.
- Henly, R.K., and P.V. Ellefson. 1987. State-administered Forestry Programs: Current Status and Prospects for Expansion. *Renewable Resources Journal*, 5(4):19.
- Hetherington, E.D. 1985. Streamflow Nitrogen Loss Following Forest Fertilization in a Southern Vancouver Island Watershed. *Canadian Journal of Forestry Research*, 15(1):34-41.
- Hornbeck, J.W., and K.G. Reinhart. 1964. Water Quality and Soil Erosion as Affected by Logging in Steep Terrain. *Journal of Soil and Water Conservation*, 19(1):23-27.
- Hornbeck, J.W., C.W. Martin, and C.T. Smith. 1986. Protecting Forest Streams During Whole-Tree Harvesting. *Northern Journal of Applied Forestry*, 3:97-100.
- Huff, J.L., and E.L. Deal. 1982. *Forestry and Water Quality in North Carolina*. North Carolina Agricultural Extension Service, North Carolina State University.
- Hynson, J., P. Adamus, S. Tibbetts, and R. Darnell. 1982. *Handbook for Protection of Fish and Wildlife from Construction of Farm and Forest Roads*. U.S. Fish and Wildlife Service. FWS/OBS-82/18.
- Ice, G. 1985. The Status of Silvicultural Nonpoint Source Programs. In *Perspectives on Nonpoint Source Pollution*. U.S. Environmental Protection Agency, pp. 223-226.
- Illinois Department of Conservation. 1990. *Forestry Development Cost-Share Program*. Illinois Administrative Code, Title 17, Chapter I, subchapter d, Part 1536.
- King, J.G. 1984. *Ongoing Studies in Horse Creek on Water Quality and Water Yield*. NCASI Technical Bulletin 435, pp. 28-35.
- Kochenderfer, J.N. 1970. *Erosion Control on Logging Roads in the Appalachians*. USDA Forest Service, Northeastern Forest Experiment Station, Research Paper NE-158.
- Kochenderfer, J.N. and Helvey, J.D. 1984. Soil Losses from a "Minimum-Standard" Truck Road Constructed in the Appalachians. In *Mountain Logging Symposium Proceedings, June 5-7*, ed. P.A. Peters and J. Luckok, West Virginia University.

- Kochenderfer, J.N. and G.W. Wendel. 1980. *Costs and Environmental Impacts of Harvesting Timber in Appalachia with a Truck-mounted Crane*. USDA Forest Service Research Paper NE-456.
- Kochenderfer, J.N., G.W. Wendel, and H.C. Smith. 1984. *Cost of and Soil Loss on "Minimum-Standard" Forest Truck Roads Constructed in the Central Appalachians*. USDA Forest Service Northeastern Forest Experiment Station, Research Paper NE-544.
- Kuehn, M.H., and J. Cobourn. 1989. *Summary Report for the 1988 Cumulative Watershed Effects Analyses on the Eldorado National Forest - Final Draft*.
- Kundt, J.F., and T. Hall. 1988. *Streamside Forests: The Vital Beneficial Resource*. University of Maryland Cooperative Extension Service and U.S. Fish and Wildlife Service.
- Lantz, R.L. 1971. *Guidelines for Stream Protection in Logging Operations*. Oregon State Game Commission.
- Larse, R.W. 1971. Prevention and Control of Erosion and Stream Sedimentation from Forest Roads. In *Proceedings of the Symposium of Forest Land Uses and the Stream Environment*, pp. 76-83. Oregon State University.
- Lickwar, P.M. 1989. *Estimating the Costs of Water Quality Protection on Private Forestlands in the South*. Master's thesis submitted to the University of Georgia.
- Likens, G.E., F.H. Bormann, N.M. Johnson, D.W. Fisher, and R.S. Pierce. 1970. Effects of Forest Cutting and Herbicide Treatment on Nutrient Budgets in the Hubbard Brook Watershed-Ecosystem. *Ecological Monographs*, 40(1):23-47.
- Louisiana Forestry Association. 1988. *Recommended Forestry Best Management Practices for Louisiana*. Louisiana Department of Agriculture and Forestry.
- Lynch, J.A., E.S. Corbett, and K. Mussallem. 1985. Best Management Practices for Controlling Nonpoint-Source Pollution on Forested Watersheds. *Journal of Soil and Water Conservation*, 41(1):164-167.
- Lynch, J.A., and E.S. Corbett. 1990. Evaluation of Best Management Practices for Controlling Nonpoint Pollution from Silvicultural Operations. *Water Resources Bulletin*, 26(1):41-52.
- Mader, S.F., W.M. Aust, and R. Lea. 1989. Changes in Functional Values of a Forested Wetland Following Timber Harvesting Practices. In *Proceedings of the Symposium: The Forested Wetlands of the Southern United States, Orlando, Florida, July 12-14, 1988*. USDA Forest Service General Technical Report SE-50, pp. 149-154.
- Maine Forest Service, Department of Conservation. 1991. *Erosion and Sediment Control Handbook for Maine Timber Harvesting Operations: Best Management Practices*.
- Malueg, K.W., C.F. Powers, and D.F. Krawczyk. 1972. Effects of Aerial Forest Fertilization with Urea Pellets on Nitrogen Levels in a Mountain Stream. *Northwest Science*, 46:52-58.
- Maryland Department of the Environment. Undated. *Soil Erosion and Sediment Control Guidelines for Forest Harvest Operations in Maryland*.
- McClurkin, D.C., P.D. Duffy, and N.S. Nelson. 1987. Changes in Forest Floor and Water Quality Following Thinning and Clearcutting of 20-year-old Pine. *Journal of Environmental Quality*, 16(3):237-291.
- McMinn, J.W. 1984. Soil Disturbance by Fuelwood Harvesting with a Conventional Ground System and a Cable Miniyarder in Mountain Hardwood Stands. In *Mountain Logging Symposium Proceedings*, ed. P.A. Peters and J. Luchok, June 5-7, 1984. West Virginia University, pp. 93-98.

- Megahan, W.F. 1980. Nonpoint Source Pollution from Forestry Activities in the Western United States: Results of Recent Research and Research Needs. In *U.S. Forestry and Water Quality: What Course in the 80s?*, Proceedings of the Water Pollution Control Federation Seminar, Richmond, VA, June 19, 1980, pp. 92-151.
- Megahan, W.F. 1981. Effects of Silvicultural Practices on Erosion and Sedimentation in the Interior West—A Case for Sediment Budgeting. In *Interior West Watershed Management Symposium Proceedings*, ed. D.M Baumgartner. Washington State University, Cooperative Extension, pp. 169-182.
- Megahan, W.F. 1983. Appendix C: Guidelines for Reducing Negative Impacts of Logging. In: *Tropical Watersheds: Hydrologic and Soils Response to Major Uses or Conversions*, ed. L.S. Hamilton and P.N. King. Westview Press, Boulder, CO, pp. 143-154.
- Megahan, W.F. 1986. Recent Studies on Erosion and Its Control on Forest Lands in the United States. In: , pp. 178-189.
- Megahan, W.F. 1987. Effects of Forest Roads on Watershed Function in Mountainous Areas. In *Environmental Geotechnics and Problematic Soils and Rocks*, ed. Balasubramaniam et al. pp. 335-348.
- Mersereau, R.C., and C.T. Dyrness. 1972. Accelerated Mass Wasting after Logging and Slash Burning in Western Oregon. *Journal of Soil and Water Conservation*, 27:112-114.
- Miller, J.H., and D.L. Sirois. 1986. Soil Disturbance by Skyline Yarding vs. Skidding in a Loamy Hill Forest. *Soil Science Society of America Journal*, 50(6):1579-1583.
- Minnesota Department of Natural Resources, Division of Forestry. 1989. *Water Quality in Forest Management, "Best Management Practices in Minnesota."*
- Minnesota Department of Natural Resources, Division of Forestry. 1991. *Minnesota Forest Stewardship Program.*
- Mississippi Forestry Commission. 1989. *Mississippi's Best Management Practices Handbook.*
- Moore, D.G. 1975. Impact of Forest Fertilization on Water Quality in the Douglass Fir Region—A Summary of Monitoring Studies. In *Proceeding Forestry Issues in Urban America, New York, NY, September 22-26, 1974.* Society of American Foresters.
- Murphy, M.L., K.V. Koski, J. Heifetz, S.W. Johnson, D. Kirchhofer, and J.F. Thedinga. 1984. Role of Large Organic Debris as Winter Habitat for Juvenile Salmonids in Alaska Streams. In *Western Proceedings of the 64th Annual Conference of the Western Association of Fish and Wildlife Agencies, Victoria, British Columbia, July 16-19, 1984,* pp. 251-262.
- Narver, D.W. 1971. Effects of Logging Debris on Fish Production. In *Forest Land Uses and Stream Environment*, ed. J.T. Krygier and J.D. Hall, School of Forestry and Department of Fisheries and Wildlife, Oregon State University, October 19-21, pp. 100-111.
- Neary, D.G. 1985. Fate of Pesticides in Florida's Forests: An Overview of Potential Impacts in Water Quality. In *Proceedings Soil and Crop Science Society of Florida*, pp. 18-24.
- Neary, D.G., P.B. Bush, J.E. Douglass, and R.L. Todd. 1985. Picloram Movement in an Appalachian Hardwood Forest Watershed. *Journal of Environmental Quality*, 14(4):585-591.
- Neary, D.G., W.T. Swank, and H. Riekerk. 1989. An Overview of Nonpoint Source Pollution in the Southern United States. In *Proceedings of the Symposium: Forested Wetlands of the Southern United States, July 12-14, 1988, Orlando, FL.* USDA Forest Service. General Technical Report SE-50, pp. 1-7.

- Norris, L.A., and D.G. Moore. 1971. The Entry and Fate of Forest Chemicals in Streams. In *Forest Land Uses and Stream Environment - Symposium Proceedings*, ed. J.T. Krygier and J.D. Hall, Oregon State University, Corvallis, OR, pp. 138-158.
- Norris, L.A., H.W. Lorz, and S.V. Gregory. 1991. Forest Chemicals. *Influences of Forest and Rangeland Management on Salmonid Fishes and Their Habitats*. American Fisheries Society Special Publication 19, pp. 207-296.
- North Carolina Division of Forest Resources. 1989. *Forestry Best Management Practices Manual*. Department of Environment, Health and Natural Resources.
- Nutter, W.L., and J.W. Gaskin. 1989. Role of Streamside Management Zones in Controlling Discharges to Wetlands. In *Proceedings of the Symposium: The Forested Wetlands of the Southern United States, July, 12-14, 1988, Orlando, Florida*. USDA Forest Service. General Technical Report SE-50, pp. 81-84.
- Ohio Department of Natural Resources. *BMPs for Erosion Control on Logging Jobs*. Silvicultural Nonpoint Source Pollution Technical Advisory Committee.
- Olsen, E.D. 1987. A Case Study of the Economic Impact of Proposed Forest Practices Rules Regarding Stream Buffer Strips on Private Lands in the Oregon Coast Range. In *Managing Oregon's Riparian Zone for Timber, Fish and Wildlife*, NCASI Technical Bulletin No. 514, pp. 52-57.
- Ontario Ministry of Natural Resources. 1988. *Environmental Guidelines for Access Roads and Water Crossings*. Queen's Printer for Ontario, Ontario, Canada.
- Oregon Department of Forestry. 1979a. *Waterbars*. Forest Practices Notes No. 1. Oregon Department of Forestry, Forest Practices Section, Salem, OR.
- Oregon Department of Forestry. 1979b. *Reforestation*. Forest Practices Notes No. 2. Oregon Department of Forestry, Forest Practices Section, Salem, OR.
- Oregon Department of Forestry. 1981. *Road Maintenance*. Forest Practices Notes No. 4. Oregon Department of Forestry, Forest Practices Section, Salem, OR.
- Oregon Department of Forestry. 1982. *Ditch Relief Culverts*. Forest Practices Notes No. 5. Oregon Department of Forestry, Forest Practices Section, Salem, OR.
- Oregon Department of Forestry. 1991. *Forest Practices Rules, Eastern Oregon Region*. Oregon Department of Forestry, Forestry Practices Section, Salem, OR.
- Page, C.P., and A.W. Lindenmuth, Jr. 1971. Effects of Prescribed Fire on Vegetation and Sediment in Oak-Mountain Mahogany Chaparral. *Journal of Forestry*, 69:800-805.
- Pardo, R. 1980. What is Forestry's Contribution to Nonpoint Source Pollution? In *U.S. Forestry and Water Quality: What Course in the 80s? Proceedings of the Water Pollution Control Federation Seminar, Richmond, VA, June 19, 1980*, pp. 31-41.
- Patric, J.H. 1976. Soil Erosion in the Eastern Forest. *Journal of Forestry*, 74(10):671-677.
- Patric, J.H. 1980. Effects of Wood Products Harvest on Forest Soil and Water Relations. *Journal of Environmental Quality*, 9(1):73-80.

- Patric, J.H. 1984. Some Environmental Effects of Cable Logging in the Eastern Hardwoods. In *Mountain Logging Symposium Proceedings*, ed. P.A. Peters and J. Luchok, June 5-7, 1984, West Virginia University, pp. 99-106.
- Pennsylvania Bureau of Soil and Water Conservation. 1990. *Erosion and Sediment Pollution Control Program Manual*. Pennsylvania Department of Environmental Resources.
- Pope, P.E. 1978. *Forestry and Water Quality: Pollution Control Practices*. Forestry and Natural Resources, FNR 88, Purdue University Cooperative Extension Services.
- Rice, R.M., J.S. Rothacher, and W.F. Megahan. 1972. Erosional Consequences of Timber Harvesting: An Appraisal. In *Watersheds in Transition Symposium Proceedings*, AWRA, Urbana, IL, pp. 321-329.
- Richter, D.D., C.W. Ralston, and W.R. Harms. 1982. Prescribed Fire: Effects on Water Quality and Forest Nutrient Cycling (Hydraulic Systems, Pine Litter, USA). *Science*, 215:661-663.
- Riekerk, H. 1983. Environmental Impacts of Intensive Silviculture in Florida. In *I.U.F.R.O. Symposium on Forest Site and Continuous Productivity*. USDA Forest Service, Pacific Northwest Forest and Range Experiment Station. General Technical Report PNW-163, pp. 264-271.
- Riekerk, H. 1983. Impacts of Silviculture on Flatwoods Runoff, Water Quality, and Nutrient Budgets. *Water Resources Bulletin*, 19(1):73-80.
- Riekerk, H. 1985. Water Quality Effects of Pine Flatwoods Silviculture. *Journal of Soil and Water Conservation*, 40(3):306-309.
- Riekerk, H. 1989. Forest Fertilizer and Runoff-Water Quality. In *Soil and Crop Science Society of Florida Proceedings, September 20-22, 1988, Marco Island, FL*, Vol. 48, pp. 99-102.
- Riekerk, H., D.G. Neary, and W.J. Swank. 1989. The Magnitude of Upland Silviculture Nonpoint Source Pollution in the South. In *Proceedings of the Symposium: Forested Wetlands of the Southern United States, July 12-14, Orlando, FL*, pp. 8-18.
- Rothwell, R.L. 1978. *Watershed Management Guidelines for Logging and Road Construction in Alberta*. Canadian Forestry Service, Northern Forest Research Centre, Alberta, Canada. Information Report NOR-X-208.
- Rothwell, R.L. 1983. Erosion and Sediment Control at Road-Stream Crossings (Forestry). *The Forestry Chronicle*, 59(2):62-66.
- Rygh, J. 1990. *Fisher Creek Watershed Improvement Project Final Report*. Payette National Forest.
- Salazar, D.J. and F.W. Cabbage. 1990. Regulating Private Forestry in the West and South. *Journal of Forestry*, 88(1):14-19.
- Sidle, R.C. 1980. *Impacts of Forest Practices on Surface Erosion*. Pacific Northwest Extension Publication PNW-195, Oregon State Univ. Extension Service.
- Sidle, R.C. 1989. Cumulative Effects of Forest Practices on Erosion and Sedimentation. In *Forestry on the Frontier Proceedings of the 1989 Society of American Foresters, September 24-27, Spokane, WA*, pp. 108-112.
- Stednick, J.D., L.N. Tripp, and R.J. McDonald. 1982. Slash Burning Effects on Soil and Water Chemistry in Southeastern Alaska. *Journal of Soil and Water Conservation*, 37(2):126-128.

- Stone, E. 1973. *The Impact of Timber Harvest on Soils and Water*. Report of the President's Advisory Panel on Timber and the Environment, Arlington, VA, pp. 427-467.
- Swank, W.T., L.W. Swift, Jr., and J.E. Douglass. 1988. Streamflow Changes Associated with Forest Cutting, Species Conversions and Natural Disturbances. In *Forest Hydrology and Ecology at Coweeta*, Chapter 22, ed. W.T. Swank and D.A. Crossley, Jr., pp.297-312. Springer-Verlag, New York, NY.
- Swift, L.W., Jr. 1984a. Gravel and Grass Surfacing Reduces Soil Loss from Mountain Roads. *Forest Science*, 30(3):657-670.
- Swift, L.W., Jr. 1984b. Soil Losses from Roadbeds and Cut and Fill Slopes in the Southern Appalachian Mountains. *Southern Journal of Applied Forestry*, 8(4):209-215.
- Swift, L.W., Jr. 1985. Forest Road Design to Minimize Erosion in the Southern Appalachians. In *Forestry and Water Quality: A Mid-South Symposium, May 8-9, 1985, Little Rock, AR*, ed. B.G. Blackmon, pp. 141-151. University of Arkansas Cooperative Extension.
- Swift, L.W., Jr. 1986. Filter Strip Widths for Forest Roads in the Southern Appalachians. *Southern Journal of Applied Forestry*, 10(1):27-34.
- Swift, L.W., Jr. 1988. Forest Access Roads: Design, Maintenance, and Soil Loss. In *Forest Hydrology and Ecology at Coweeta*, Chapter 23, ed. W.T. Swank and D.A. Crossley, Jr., pp. 313-324. Springer-Verlag, New York, NY.
- Tennessee Department of Conservation, Division of Forestry. 1990. *Best Management Practices for Protection of the Forested Wetlands of Tennessee*.
- Texas Forestry Association. 1989. *Texas Best Management Practices for Silviculture*.
- Toliver, J.R., and B.D. Jackson. 1989. Recommended Silvicultural Practices in Southern Wetland Forests. In *Proceedings of the Symposium: The Forested Wetlands of the Southern United States, Orlando, Florida, July 12-14, 1988*. USDA Forest Service General Technical Report SE-50, pp. 72-77.
- Trimble, G.R., and S. Weitzman. 1953. Soil Erosion on Logging Roads. *Soil Science Society of America Proceedings*, 17:152-154.
- USDA, Forest Service. 1987. *Soil and Water Resource Management: A Cost or a Benefit? Approaches to Watershed Economics through Example*.
- USEPA. 1984. *Report to Congress: Nonpoint Source Pollution in the U.S.*, U.S. Environmental Protection Agency, Office of Water Program Operations, Washington, DC.
- USEPA. 1991. *Pesticides and Groundwater Strategy*. U.S. Environmental Protection Agency, Office of Prevention, Pesticides, and Toxic Substances, Washington, DC.
- USEPA. 1992a. *Managing Nonpoint Source Pollution, Final Report to Congress on Section 319 of the Clean Water Act (1989)*. U.S. Environmental Protection Agency, Office of Water, Washington, DC. EPA-506/9-90.
- USEPA. 1992b. *National Water Quality Inventory: 1990 Report to Congress*. U.S. Environmental Protection Agency, Office of Water, Washington, DC.
- Vermont Department of Forests, Parks, and Recreation. 1987. *Acceptable Management Practices for Maintaining Water Quality on Logging Jobs in Vermont*.

- Virginia Department of Forestry. *Forestry Best Management Practices for Water Quality in Virginia*.
- Washington State Forest Practices Board. 1988. *Washington Forest Practices Rules and Regulations. Washington Annotated Code, Title 222; Forest Practices Board Manual, and Forest Practices Act*.
- Weitzman, S., and G.R. Trimble, Jr. 1952. Skid-road Erosion Can Be Reduced. *Journal of Soil and Water Conservation*, 7:122-124.
- Whitman, R. 1989. Clean Water or Multiple Use? Best Management Practices for Water Quality Control in the National Forests. *Ecology Law Quarterly*, 16:909-966.
- Willingham, P.W. 1989. Wetlands Harvesting Scott Paper Company. *Proceedings of the Symposium: The Forested Wetlands of the Southern United States, Orlando, Florida, July 12-14, 1988*. USDA Forest Service General Technical Report SE-50, pp. 63-66.
- Wisconsin Department of Natural Resources. 1989. *Forest Practice Guidelines for Wisconsin*. Bureau of Forestry, Madison, WI. PUBL-FR-064-89.
- Yee, C.S., and T.D. Roelofs. 1980. *Planning Forest Roads to Protect Salmonid Habitat*. USDA Forest Service. General Technical Report PNW-109.
- Yoho, N.S. 1980. Forest Management and Sediment Production in the South—A Review. *Southern Journal of Applied Forestry*, 4(1):27-36.



Appendix 3A

Examples of State Processes Useful for Ensuring Implementation of Management Measures

3A-1: Examples from Florida

SRWMD PERMIT NUMBER _____
APPLICATION FOR AGRICULTURE OR FORESTRY MANAGEMENT
GENERAL SURFACEWATER MANAGEMENT PERMIT
FORM 40B-4-1

SUWANNEE RIVER WATER MANAGEMENT DISTRICT
 ROUTE 3, BOX 64
 LIVE OAK, FLORIDA 32060
 TELEPHONE (904) 362-1001

Landowner/Applicant: _____

Address: _____

Street - Route - Box City State Zip Code

Person Responsible: _____

Phone: _____ **Beginning Date:** _____

Project Location: _____ **Location Sketch:** _____

County

Township	Range	Section

Parcel ID Number (from County records) _____

Project Area: _____	Acres owned or in management block
_____	Acres in project area (aerial photograph copy with project area outlined is suggested.)
Wetlands Area: _____	Wetland acres in project area
_____	Wetland acres affected by the work

[Location Sketch Area]

Description of the proposed work to include sizes and dimensions: _____

THE GENERAL SURFACEWATER MANAGEMENT PERMIT AUTHORIZED BY SS.40B-4.2010(1), FLORIDA ADMINISTRATIVE CODE (F.A.C.), REQUIRES PERMITTEES TO COMPLY WITH BEST MANAGEMENT AND ACCEPTED CONSERVATION PRACTICES. ADDITIONAL LIMITATIONS AND/OR STANDARDS ARE CONTAINED IN SS.40B-4.2010(1)(C)1. THROUGH 6. A COPY OF CHAPTER 40B-4, F.A.C., AND BEST MANAGEMENT PRACTICES MANUALS ARE AVAILABLE AT NO CHARGE FROM THE DISTRICT, OR QUESTIONS MAY BE DIRECTED TO THE SUWANNEE RIVER WATER MANAGEMENT DISTRICT AT 904/362-1001 OR 1-800-342-1002. A DISTRICT PERMIT DOES NOT RELIEVE A PERMITTEE FROM OBTAINING APPROVALS THAT MAY BE REQUIRED BY ANY UNIT OF LOCAL, STATE, OR FEDERAL GOVERNMENT.

THIS APPLICATION IS NOT TO BE USED FOR SUBDIVISIONS, COMMERCIAL PROJECTS, OR ANY OTHER NON-AGRICULTURAL OR FORESTRY WORK.

Landowner/Applicant's Signature	Title	Date
SRWMD Staff Signature	Title	Date Approved

SRWMD Form 40B-4-1 (REV. 12/90) White-SRWMD/Yellow-Permittee

Authorization No. _____

NORTHWEST FLORIDA WATER MANAGEMENT DISTRICT

FORESTRY AUTHORIZATION NOTIFICATION FORM

Instructions:

- 1. Deliver or mail to the appropriate District Office identified on the attached sheet at least two (2) working days before commencing activity.
- 2. Emergency authorizations may be requested by calling the appropriate District Office.
- 3. See attached sheet for list of qualifying projects, limiting conditions, and District Offices.

Application is for: Construction Replacement Maintenance

Owner's Name: _____ Phone: _____

Address: _____

City: _____ State: _____ Zip: _____

Agent's Name: _____ Phone: _____

Address: _____

City: _____ State: _____ Zip: _____

Only the minor works listed in Section 40A-44.052(1), F.A.C. (see attached sheet), may qualify for an authorization. After reviewing the attached list, which letter identifies the minor work you propose? Please circle the appropriate one(s):

A B C D E F

Detailed description of the proposed work, include water quality protection and site stabilization methods: _____

Starting Date: _____

Location of Proposed Work: _____

County: _____

Section: _____

Township: _____

Range: _____

Water Body Affected: _____

Location Sketch

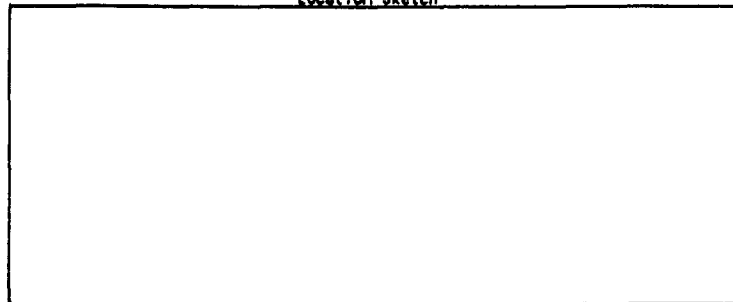

A copy of Chapter 40A-44, F.A.C., is available at any District office. A District authorization does not relieve a permittee from obtaining the necessary approvals of any local, state, or federal government.

I have read and will comply with the requirements of Section 40A-44.052, F.A.C. I understand that this Forestry Authorization Notice is available only under limited circumstances as set forth in Section 40A-44.052, F.A.C., and that permittees are required to comply with all limiting conditions listed in Section 40A-44.052, F.A.C.

Signature of: (Circle one) _____

Printed Name _____

Date _____

Owner Agent

* Signing by someone other than the owner is also certification that the person is authorized to act as the owner's agent.

NWFLWD Form A44-F
40A-44.052(2)(a), F.A.C.
Effective 7-1-92

White - District Copy, Yellow - Applicant's Copy

3A-2: Examples from Oregon

SIDE ONE

NOTIFICATION OF OPERATION / APPLICATION FOR PERMITS STATE OF OREGON DEPARTMENT OF FORESTRY DEPARTMENT OF REVENUE		NOTIFICATION NUMBER: _____	
1 County (Enter only one) _____		Date Received: _____	
2	Check Appropriate Boxes (2A, 2B, 2C, or 2D)	Time Received: _____	
	<input type="checkbox"/> 2A NOTICE TO THE STATE FORESTER THAT OPERATION WILL BE CONDUCTED ON LANDS DESCRIBED ON REVERSE (ORS 527 670)	District: _____	
	<input type="checkbox"/> 2B APPLICATION FOR PERMIT TO OPERATE POWER DRIVEN MACHINERY (ORS 477 825) Expires at end of calendar year	Office: _____	
	<input type="checkbox"/> 2C APPLICATION FOR PERMIT TO CLEAR RIGHTS-OF-WAY (ORS 477 845)		
<input type="checkbox"/> 2D NOTICE TO THE STATE FORESTER AND THE DEPARTMENT OF REVENUE OF THE INTENT TO HARVEST TIMBER (ORS 321 550)		APPLICANT REMARKS:	
3 Person to be contacted in case of Fire Emergency (Designated Representative) Phone No _____ PLEASE PRINT!			
CHECK ONE BOX IN THE FAR LEFT COLUMN TO INDICATE WHO FILLED OUT THE APPLICATION			
<input type="checkbox"/>	Name/Title _____		
4 Operator Information	Company Name _____		
	Mailing Address - Street _____		
	City, State and Zip Code _____ Phone No _____		
<input type="checkbox"/>	Name/Title _____		
5 Landowner Information	Company Name _____ RC _____		
	Mailing Address - Street _____ EG _____		
	City, State and Zip Code _____ Phone No _____ S _____		
<input type="checkbox"/>	Name/Title _____		
6 Timberowner and Harvest Tax Payer	Company Name _____		
	Mailing Address - Street _____		
	City, State and Zip Code _____ Phone No _____		
	Timberowner Employer Identification Number _____ or _____ Social Security Number _____		
7 Timber Sale Name and/or No _____			
8 WESTERN OREGON PRIVATE LAND ONLY! Is any timber being harvested certified under the Western Oregon Small Tract Optional Tax (WOSTOT) program? None <input type="checkbox"/> Part <input type="checkbox"/> All <input type="checkbox"/>		WOSTOT Certificate Number _____	
If you have checked Part or All please fill the number in the WOSTOT Certificate Number box			
FORM 520-6-1 (02/92) Rev. 11/91			

SIDE TWO

9 ACTIVITY CODES								10 LOCATION OF OPERATION												11 a ACTIVITY			11 b ACTIVITY			12 WEST OREGON SEVERANCE TAX UNIT NUMBER	13 SITE CONDITIONS				REGISTERED USE AREA			
FPF No (a)	Fire FPA	Unit Number	Activity Codes	Methods Used	Quantity (by unit) Acres/feet	Approx MBF Removed	Government Lot Numbers	N E				N W				S W				S E				STARTING DATE	ESTIMATED ENDING DATE	SEVERANCE	D100 D1 D2 D3	T1 T2 T3	S1 S2 S3	DWS WU SW		UGB SH CC IC2		
								ne	nw	sw	se	ne	nw	sw	se	ne	nw	sw	se	ne	nw	sw	se	STARTING DATE	ESTIMATED ENDING DATE	SEVERANCE	D100 D1 D2 D3	T1 T2 T3	S1 S2 S3	DWS WU SW	UGB SH CC IC2	REGISTERED USE AREA		
				</																														

**INSTRUCTIONS FOR FILLING OUT
"NOTIFICATION OF OPERATION / APPLICATION FOR PERMITS"**

The instructions are numbered to match the numbered form areas. Please print or type the information on the form. Do not fill out any space shaded gray. File notice with the State Forester at least 15 days prior to the date you would like to start operating. A notification is not considered accepted until it is received by the appropriate office. Mail or deliver the form to one of the following offices:

Office Address	Phone Number	Office Address	Phone Number
ASTORIA Rt 1, Box 950, 97103	325-5451	MOLALLA 14995 S Hwy 211, 97038	829-2216
BAKER Rt 1, Box 211, 97814	523-5831	MONUMENT P O Box 386 97864 (May Street)	934-2300
CENTRAL POINT 5288 Table Rock Road, 97502	664-3328	PENDLETON 1055 Airport Rd., 97801	276-3491
COLUMBIA CITY 405 E St., 97018	397-2636	PHILOMATH 24533 Alsea Hwy., 97370	929-3266
COOS BAY 300 Fifth St., Bay Park, 97420	267-3161	PRINEVILLE 220710 Ochoco Hwy., 97754	447-5658
DALLAS 825 Oak Villa Rd., 97338	623-8148	ROSEBURG 1758 N E. Airport Road, 97470-1499	440-3412
FOREST GROVE 801 Gales Cr Rd 97116-1199	357-2191	SISTERS P O Box 190, 97759 (221 SW Washington)	549-2731
FOSSIL Star Route, 97830	763-2575	SPRINGFIELD 3150 E Main St., 97478	726-3588
GOLD BEACH P O Box 603, 97444	247-6565	SWEET HOME: 4690 Hwy 20, 97386	367-6108
GRANTS PASS 5375 Monument Dr., 97526	474-3152	THE DALLES 3701 W 13th St., 97058	296-4626
JOHN DAY P O Box 546, 97845 (400 NW 9th)	575-1139	TILLAMOOK 4907 E Third St., 97141-2999	842-2545
KLAMATH FALLS 3400 Greensprings Dr., 97601	883-5681	TOLEDO 763 N W Forestry Rd., 97391	336-2273
LA GRANDE 611 20th St., 97850	963-3168	VENETA P O Box 157 97487	935-2283
LAKEVIEW 2290 N 4th St., 97630	947-3311	WALLOWA Rt 1 Box 80, 97885	886-2881
	MEHAMA 22965 N Fork Rd S E, Lyons 97358	859-2151	

SIDE ONE - Notification of Operation/Application for Permits

1. "County (Enter only one)". Fill in the county where the operation will take place. If an operation spans two or more counties, file a separate notification for each county.

An operation can be any combination of the following activities: harvest of forest crops; road construction or reconstruction; site preparation; chemical application; clearing for land use change; treatment of slashing; pre-commercial thinning; or other activities which require separate explanation.

2. "Check Appropriate Boxes (2A, 2B, 2C, or 2D)" next to the notice you are giving and/or the permit(s) you need.

3. "Person to be contacted in case of Fire Emergency (Designated Representative). Phone No." Print the name and telephone number of the person to contact in case a fire starts on this operation. This person should know what resources you have available to fight the fire, and have the authority to commit those resources in case of a fire.

"Check one box in the left column to indicate who filled out the application."

4. "Operator Information" 5. "Landowner Information" 6. "Timberowner and Harvest Tax Payer." You must fill in either a person's or a company's name, address and phone number. Fill in EITHER the timberowner's Employer Identification number or the timberowner's social security number, not both. The person who owns timber at the time of severance from the stump (harvest) is the timberowner, and is responsible for paying the harvest tax.

7. "Timber Sale Name and/or No." Fill in the sale name and/or number. This information is required for all state and federal timber sales and is optional for private land timber sales.

8. "Western Oregon Private Land Only!" If the timber to be harvested is from public land, do not fill out this portion! If it is from private land, check with the landowner to see whether the timber has been certified under the Western Oregon Small Tract Optional Tax (WOSTOT) law. Timber removed from land certified under WOSTOT is normally exempt from the Western Oregon Severance Tax. If you have checked "Part" or "All", please list the certificate number in the WOSTOT Certificate Number box.

SIDE TWO - Site Information

9. "Activity Codes". There are six columns here. You assign a one- or two-digit unit number, beginning with 1 and going sequentially up to 99. Or, if there is a unit number associated with a state or federal timber sale, use that number in the unit column. A unit can be:

- an operating area with a state or federal sale unit number; or
- a single operating area within a continuous boundary; or
- an operating area with a separate harvest tax number; or
- a separate area within your total operation area on which you plan to conduct a single type of activity (for example, 30 acres of clear cut only).

FORM 629-B-2-1-002b (Rev 11/91)

In all cases, all activities you plan on that piece of land should be listed under the unit number. For example, road construction activity needed prior to starting a commercial timber harvest should be described under the unit number along with the harvesting activity. If there will be more activities happening in the unit than you can fit on one line straight across, continue on the lines below. Leave a blank under the unit number. See the example below.

Activity Code. Write the codes for all activities taking place in one unit under this heading. Use the numbers, code names and associated methods shown below.

Activity Code	Methods Used	Activity Code	Methods Used
1a. Partial Cut (Partial Cut code must not be used for a pre-commercial thinning operation)	Cable/Ground/Other	4a. Herbicide Application	Ground/Aerial/Name/Rate/Carner
1b. Clear Cut	Cable/Ground/Other	4b. Insecticide Application	Ground/Aerial/Name/Rate/Carner
1c. Cutting only	Cable/Ground/Other	4c. Rodenticide Application	Ground/Aerial/Name/Rate/Carner
2a. Road Construction	Dozer/Backhoe/Other	4d. Fertilizer Application	Ground/Aerial/Name/Rate/Carner
2b. Road Reconstruction	Dozer/Backhoe/Other	5. Clearing for Land Use Change (Local land use rules may apply)	Burning/Mechanical
3. Site Preparation	Manual/Mechanical/Burning	6. Treatment of Slashing	Burning/Mechanical
		7. Pre-Commercial Thinning	Manual/Chemical
		8. Others	Explain

Write the methods you will use in the "Methods Used" column next to the code for the activity, in the same order as the activity codes are listed. If you need more space, go to the next row down in the same column. Write in the name of the spray product. In Applicant Remarks column list the carner and rate of application. See the example below

Quantity Column Fill in either the acres (A) or lineal feet (F) involved in the activity. The example shows 65 acres of harvest and 3000 ft. of road construction.

Approximate Thousand Board Feet (MBF) Removed List the approximate MBF to be removed for each unit with commercial timber harvesting.

Government Lot Numbers. List the government lot numbers for each unit. (Not tax lot numbers.)

UNIT NO.	ACTIVITY CODES	METHODS USED	QUANTITY	MBF REMOVED	LOCATION OF OPERATION								ACTIVITY ESTIMATED ENDING DATE	WESTERN OREGON SEVERANCE TAX UNIT NUMBER	SITE CONDITIONS
					1	2	3	4	5	6	7	8			
1	1c. Cutting only	Cable	65											4086	D 12 50
2	2b. Road Reconstruction	Dozer	3000											4086	D 12 51
3															
4															
5															
6															
7															
8															
9															
10															
11															
12															

10. "Location of Operation" (Legal Descriptions). Enter the legal descriptions for each unit number. If you have several rows worth of activities that will take place at one location, REPEAT THE CODES, not the legal descriptions.

11. a. & 11. b. "Activity Starting and Activity Estimated Ending Date" The starting date should be at least 15 days after the date the form is received by the appropriate Department office.

12. "Western Oregon Severance Tax Unit Number" Large landowners will have a list of harvest tax numbers which apply to the site(s).

13. "Site Conditions". Fill in a D, T, and S code for each unit, as shown in the example. Fill in DWS, WG or SW codes when necessary.

D = Distance to Class 1 waters A Class 1 water is "any portions of streams, lakes, estuaries, significant wetlands, or other waters of the state which are significant for (a) domestic use, including drinking, culinary and other household human use, (b) angling, (c) water dependant recreation; or (d) spawning, rearing or migration of anadromous or game fish."

- D100 = Class 1 waters are within 100 feet of the operation
- D1 = Class 1 waters are within 1/4 mile but greater than 100 feet from the operation
- D2 = Class 1 waters are within 1/4-1/2 mile of the operation
- D3 = None within 1/4 mile

T = Topography
T1 is a slope of 0 to 35% (percent)
T2 is a slope of 35% to 65%
T3 is a slope greater than 65%

S = Slope Stability
S1 = No evidence of mass soil movement (landslides, slips, slumps)
S2 = Evidence of old slides, small failures
S3 = Recent or active movement, wet areas

- DWS = The operation affects a Domestic Water Supply
- WG = The operation takes place in the Willamette Greenway
- SW = The operation takes place near a Scenic Waterway
- UGB = The operation takes place in an Urban Growth Boundary
- SH = The operation takes place near a Scenic Highway
- CC = The operation will result in a single clearcut or continuation of contiguous clearcuts that exceed 120 acres
- IC2 = The operation takes place near an influential Class II stream

14. If you request a waiver of the 15 day waiting period, check the box and contact the Forest Practice Forester (FPF). The FPF will decide if a waiver can be granted.

15. a. & 15. b. Print your name in 15. a. and sign your name and write the date in 15. b.

16. ATTACH MAP AND/OR AERIAL PHOTOS! The notification form is not complete unless a map or aerial photo of the operation area is attached!

3A-3: Examples from New Hampshire



STATE OF NEW HAMPSHIRE
Notice of Intent to Cut Wood or Timber
 (RSA 79:10)

PA-7
1992 - 1993
 Operation No _____
 DRA USE ONLY

TAX YEAR APRIL 1, 1992 TO MARCH 31, 1993
SEE INSTRUCTIONS FOR FILLING OUT THIS FORM ON REVERSE

PLEASE TYPE OR PRINT

- 1 To Selectmen/Assessors
 Town/City of _____ N H
- 2 Name & Tax Map # by which lot is commonly known

- 3 Is this intent an Original Supplemental
 Orig. Oper # _____
- 4 Name of road from which accessible: _____
- 5 Number of acres to be cut: _____
- 6 Type of ownership (check only one)
 - a. Owner of land and stumpage
 - b. Owner of stumpage only
 - c. Right of possession with authority to cut (including public lands)
- 7 Is any of the wood or timber cut for own use?
 (See Item #11) _____
- 8 If required, has a wetland notification or application been filed. YES
- 9 I/we hereby assume responsibility for any yield tax which may be assessed. (If Corporation, An Officer Must Sign)
 - A
 SIGNATURE OF OWNER(S) _____ DATE _____
 - B
 SIGNATURE _____
 - PRINT OWNER(S) NAME CLEARLY _____
 - MAILING ADDRESS _____
 - TOWN/CITY _____ ZIP CODE _____
 - Corp _____
 - Tel No _____
 - Federal Identification No. or Social Security No. of Landowner

CHECK ONE: Corporation } Landowner
 Proprietorship }
 Partnership }

SPACE BELOW FOR ASSESSING OFFICIALS ONLY

Amount of Security Required and Posted \$ _____ Type of Security Posted (Bond, Certified Check, etc.) _____
 _____ (Selectmen/Assessors)

 _____ of _____ Date _____

10. DESCRIPTION OF WOOD OR TIMBER TO BE CUT

Species	Estimated Amount To Be Cut
White Pine	BF
Hemlock	"
Red Pine	"
Spruce & Fir	"
Hard Maple	"
White Birch	"
Yellow Birch	"
Oak	"
Ash	"
Beech & Soft Maple	"
Pallet or Tie Logs	"
Others (Specify)	
Pulpwood:	Tons or Cords
Spruce & Fir	
Hardwood & Aspen	
Pine	
Hemlock	
Total Tree Chips	
Miscellaneous:	
Birch Bolts	Cords
Cordwood & Fuelwood	"
- 11 AMOUNT OF WOOD OR TIMBER FOR PERSONAL USE

12. PLEASE SIGN THE FOLLOWING.
 - I, _____ (SIGNATURE OF LOGGER FORESTER RESPONSIBLE FOR OPERATION) DATE _____
 - _____
 (PRINT LOGGER FORESTERS NAME)
 - _____
 MAILING ADDRESS

HAVE BECOME FAMILIAR WITH RSA 485-A, RSA 224 44A, 224 44B, 482-A AND RELATED RULES, AND HEREBY AGREE TO ABIDE BY APPROPRIATE, BEST MANAGEMENT PRACTICES TO INCLUDE ALL STATE LAWS PERTAINING TO LOGGING OPERATIONS.

13. CERTIFICATE/REPORT TO BE SENT TO LANDOWNER
 LOGGER/FORESTER

CHAPTER 4: MANAGEMENT MEASURES FOR URBAN AREAS

I. INTRODUCTION

A. What "Management Measures" Are

This chapter specifies management measures to protect coastal waters from urban sources of nonpoint pollution. "Management measures" are defined in section 6217 of the Coastal Zone Act Reauthorization Amendments of 1990 (CZARA) as economically achievable measures to control the addition of pollutants to our coastal waters, which reflect the greatest degree of pollutant reduction achievable through the application of the best available nonpoint pollution control practices, technologies, processes, siting criteria, operating methods, or other alternatives.

These management measures will be incorporated by States into their coastal nonpoint programs, which under CZARA are to provide for the implementation of management measures that are "in conformity" with this guidance. Under CZARA, States are subject to a number of requirements as they develop and implement their Coastal Nonpoint Pollution Control Programs in conformity with this guidance and will have some flexibility in doing so. The application of these management measures by States to activities causing nonpoint pollution is described more fully in *Coastal Nonpoint Pollution Control Program: Program Development and Approval Guidance*, published jointly by the U.S. Environmental Protection Agency (EPA) and the National Oceanic and Atmospheric Administration (NOAA).

B. What "Management Practices" Are

In addition to specifying management *measures*, this chapter also lists and describes management *practices* for illustrative purposes only. While State programs are required to specify management *measures* in conformity with this guidance, State programs need not specify or require the implementation of the particular management *practices* described in this document. However, as a practical matter, EPA anticipates that the management measures generally will be implemented by applying one or more management practices appropriate to the source, location, and climate. The practices listed in this document have been found by EPA to be representative of the types of practices that can be applied successfully to achieve the management measures. EPA has also used some of these practices, or appropriate combinations of these practices, as a basis for estimating the effectiveness, costs, and economic impacts of achieving the management measures. (Economic impacts of the management measures are addressed in a separate document entitled *Economic Impacts of EPA Guidance Specifying Management Measures for Sources of Nonpoint Pollution in Coastal Waters*.)

EPA recognizes that there is often site-specific, regional, and national variability in the selection of appropriate practices, as well as in the design constraints and pollution control effectiveness of practices. The list of practices for each management measure is not all-inclusive and does not preclude States or local agencies from using other technically sound practices. In all cases, however, the practice or set of practices chosen by a State needs to achieve the management measure.

C. Scope of This Chapter

This chapter addresses six major categories of sources of urban nonpoint pollution that affect surface waters:

- (1) Runoff from developing areas;
- (2) Runoff from construction sites;

- (3) Runoff from existing development;
- (4) On-site disposal systems;
- (5) General sources (households, commercial, and landscaping); and
- (6) Roads, highways, and bridges.

Each category of sources is addressed in a separate section of this guidance. Each section contains (1) the management measure; (2) an applicability statement that describes, when appropriate, specific activities and locations for which the measure is suitable; (3) a description of the management measure's purpose; (4) the basis for the management measure's selection; (5) information on management practices that are suitable, either alone or in combination with other practices, to achieve the management measure; (6) information on the effectiveness of the management measure and/or of practices to achieve the measure; and (7) information on costs of the measure and/or practices to achieve the measure.

D. Relationship of This Chapter to Other Chapters and to Other EPA Documents

1. Chapter 1 of this document contains detailed information on the legislative background for this guidance, the process used by EPA to develop this guidance, and the technical approach used by EPA in the guidance.
2. Chapter 6 of this document contains information and management measures for addressing nonpoint source impacts resulting from hydromodification, which often occurs to accommodate urban development.
3. Chapter 7 of this document contains management measures to protect wetlands and riparian areas that provide a nonpoint source pollution abatement function. These measures apply to a broad variety of sources, including urban sources.
4. Chapter 8 of this document contains information on recommended monitoring techniques to (1) ensure proper implementation, operation, and maintenance of the management measures and (2) assess over time the success of the measures in reducing pollution loads and improving water quality.
5. EPA has separately published a document entitled *Economic Impacts of EPA Guidance Specifying Management Measures for Sources of Nonpoint Pollution in Coastal Waters*.
6. NOAA and EPA have jointly published guidance entitled *Coastal Nonpoint Pollution Control Program: Program Development and Approval Guidance*. This guidance contains details on how State Coastal Nonpoint Pollution Control Programs are to be developed by States and approved by NOAA and EPA. It includes guidance on:
 - The basis and process for EPA/NOAA approval of State Coastal Nonpoint Pollution Control Programs;
 - How NOAA and EPA expect State programs to provide for the implementation of management measures "in conformity" with this management measures guidance;
 - How States may target sources in implementing their Coastal Nonpoint Pollution Control Programs;
 - Changes in State coastal boundaries; and
 - Requirements concerning how States are to implement their Coastal Nonpoint Pollution Control Programs.

E. Overlap Between This Management Measure Guidance for Control of Coastal Nonpoint Sources and Storm Water Permit Requirements for Point Sources

Historically, overlaps and ambiguity have existed between programs designed to control urban nonpoint sources and programs designed to control urban point sources. For example, runoff that originates as a nonpoint source may ultimately may be channelized and become a point source. Potential confusion concerning coverage and implementation of these two programs has been heightened by Congressional enactment of two important pieces of legislation: section 402(p) of the Clean Water Act, which establishes permit requirements for certain municipal and industrial storm water discharges, and section 6217 of CZARA, which requires EPA to promulgate and States to provide for the implementation of management measures to control nonpoint pollution in coastal waters. The discussion below is intended to clarify the relationship between these two programs and describe the scope of the coastal nonpoint program and its applicability to storm water in coastal areas.

1. The Storm Water Permit Program

The storm water permit program is a two-phased program enacted by Congress in 1987 under section 402(p) of the Clean Water Act. Under Phase I, National Pollutant Discharge Elimination System (NPDES) permits are required to be issued for municipal separate storm sewers serving large or medium-sized populations (greater than 250,000 or 100,000 people, respectively) and for storm water discharges associated with industrial activity. Permits are also to be issued, on a case-by-case basis, if EPA or a State determines that a storm water discharge contributes to the violation of a water quality standard or is a significant contributor of pollutants to waters of the United States. EPA published a rule implementing Phase I on November 16, 1990.

Under Phase II, EPA is to prepare two reports to Congress that assess remaining storm water discharges; determine, to the maximum extent practicable, the nature and extent of pollutants in such discharges; and establish procedures and methods to control storm water discharges to the extent necessary to mitigate impacts on water quality. Then, EPA is to issue regulations that designate storm water discharges, in addition to those addressed in Phase I, to be regulated to protect water quality and is to establish a comprehensive program to regulate those designated sources. The program is required to establish (1) priorities, (2) requirements for State storm water management programs, and (3) expeditious deadlines.

These regulations were to have been issued by EPA not later than October 1, 1992. However, because of EPA's emphasis on Phase I, the Agency has not yet been able to complete and issue appropriate regulations as required under section 402(p). The completion of Phase II is now scheduled for October 1993.

2. Coastal Nonpoint Pollution Control Programs

As discussed more fully earlier, Congress enacted section 6217 of CZARA in late 1990 to require that States develop Coastal Nonpoint Pollution Control Programs that are in conformity with the management measures guidance published by EPA.

3. Scope and Coverage of This Guidance

EPA is excluding from coverage under this section 6217(g) guidance all storm water discharges that are covered by Phase I of the NPDES storm water permit program. Thus, EPA is excluding any discharge from a municipal separate storm sewer system serving a population of 100,000 or more; any discharge of storm water associated with industrial activity; any discharge that has already been permitted; and any discharge for which EPA or the State makes a determination that the storm water discharge contributes to a violation of a water quality standard or is a significant contributor of pollutants to waters of the United States. All of these activities are clearly addressed by the storm water permit program and therefore are excluded from the Coastal Nonpoint Pollution Control Programs.

EPA is adopting a different approach with respect to other (Phase II) storm water discharges. At present, EPA has not yet promulgated regulations that would designate additional storm water discharges, beyond those regulated in Phase I, that will be required to be regulated in Phase II. It is therefore not possible to determine at this point which additional storm water discharges will be regulated by the NPDES program and which will not. Furthermore, because of the great number of such discharges, it is likely that it would take many years to permit all of these discharges even if EPA allows for relatively expeditious State permitting approaches such as the use of general permits.

Therefore, to give effect to the Congressional intent that coastal waters receive special and expeditious attention from EPA, NOAA, and the States, storm water runoff that potentially may be ultimately covered by Phase II of the storm water permits program is subject to this management measures guidance and will be addressed by the States' Coastal Nonpoint Pollution Control Programs. Any storm water runoff that ultimately is regulated under an NPDES permit will no longer be subject to this guidance once the permit is issued.

In addition, it should be noted that some other activities are not presently covered by the NPDES permit requirements and thus would be subject to a State's Coastal Nonpoint Pollution Control Program. Most importantly, construction activities on sites that result in the disturbance of less than 5 acres, which are not currently covered by Phase I storm water application requirements,¹ are covered by the Coastal Nonpoint Pollution Control Program. Similarly, runoff from wholesale, retail, service, or commercial activities, including gas stations, which are not covered by Phase I of the NPDES storm water program, would be subject instead to a State's Coastal Nonpoint Pollution Control Program. Further, onsite disposal systems (OSDS), which are generally not covered by the storm water permit program, would be subject to a State's Coastal Nonpoint Pollution Control Program.

Finally, EPA emphasizes that while different legal authorities may apply to different situations, the goals of the NPDES and CZARA programs are complementary. Many of the techniques and practices used to control storm water are equally applicable to both programs. Yet, the programs do not work identically. In the interest of consistency and comprehensiveness, States have the option to implement the CZARA section 6217(g) management measures throughout the State's 6217 management area as long as the NPDES storm water requirements continue to be met by Phase I sources in that area.

F. Background

The prevention and control of urban nonpoint source pollution in coastal areas pose a distinctive challenge to the environmental manager. Increasing water quality problems and degraded coastal resources point to the need for comprehensive solutions to protect and enhance coastal water quality. This chapter presents a framework for preventing and controlling urban nonpoint sources of pollution.

Urban runoff management requires that a number of objectives be pursued simultaneously. These objectives include the following:

- Protection and restoration of surface waters by the minimization of pollutant loadings and negative impacts resulting from urbanization;
- Protection of environmental quality and social well-being;
- Protection of natural resources, e.g., wetlands and other important aquatic and terrestrial ecosystems;

¹ On May 27, 1992, the United States Court of Appeals for the Ninth Circuit invalidated EPA's exemption of construction sites smaller than 5 acres from the storm water permit program in *Natural Resources Defense Council v. EPA*, 965 F.2d 759 (9th Cir. 1992). EPA is conducting further rulemaking proceedings on this issue and will not require permit applications for construction activities under 5 acres until further rulemaking has been completed.

- Minimization of soil erosion and sedimentation problems;
- Maintenance of the predevelopment hydrologic conditions;
- Protection of ground-water resources;
- Control and management of runoff to reduce/prevent flooding; and
- Management of aquatic and riparian resources for active and passive recreation (APWA, 1981).

1. Urbanization and Its Impacts

Urbanization first occurred in coastal areas and this historical trend continues. Approximately 80 percent of the Nation's population lives in coastal areas. The negative impacts of urbanization on coastal and estuarine waters has been well documented in a number of sources, including the Nationwide Urban Runoff Program (NURP) and the States' §305(b) and §319 reports.

During urbanization, pervious spaces, including vegetated and open forested areas, are converted to land uses that usually have increased areas of impervious surface, resulting in increased runoff volumes and pollutant loadings. While urbanization may enhance the use of property under a wide range of environmental conditions (USEPA, 1977), urbanization typically results in changes to the physical, chemical, and biological characteristics of the watershed. Vegetative cover is stripped from the land and cut-and-fill activities that enhance the development potential of the land occur. For example, natural depressions that temporarily pond water are graded to a uniform slope, increasing the volume of runoff during a storm event (Schueler, 1987). As population density increases, there is a corresponding increase in pollutant loadings generated from human activities. These pollutants typically enter surface waters via runoff without undergoing treatment.

a. Changes in Hydrology

As urbanization occurs, changes to the natural hydrology of an area are inevitable. Hydrologic and hydraulic changes occur in response to site clearing, grading, and the addition of impervious surfaces and maintained landscapes (Schueler, 1987). Most problematic are the greatly increased runoff volumes and the ensuing erosion and sediment loadings to surface waters that accompany these changes to the landscape. Uncontrolled construction site sediment loads have been reported to be on the order of 35 to 45 tons per acre per year (Novotny and Chesters, 1981; Wolman and Schick, 1967; Yorke and Herb, 1976, 1978). Loadings from undisturbed woodlands are typically less than 1 ton per year (Leopold, 1968).

Hydrological changes to the watershed are magnified after construction is completed. Impervious surfaces, such as rooftops, roads, parking lots, and sidewalks, decrease the infiltrative capacity of the ground and result in greatly increased volumes of runoff. Elevated flows also necessitate the construction of runoff conveyances or the modification of existing drainage systems to avoid erosion of streambanks and steep slopes. Changes in stream hydrology resulting from urbanization include the following (Schueler, 1987):

- Increased peak discharges compared to predevelopment levels (Leopold, 1968; Anderson, 1970);
- Increased volume of urban runoff produced by each storm in comparison to predevelopment conditions;
- Decreased time needed for runoff to reach the stream (Leopold, 1968), particularly if extensive drainage improvements are made;
- Increased frequency and severity of flooding;

- Reduced streamflow during prolonged periods of dry weather due to reduced level of infiltration in the watershed; and
- Greater runoff velocity during storms due to the combined effects of higher peak discharges, rapid time of concentration, and the smoother hydraulic surfaces that occur as a result of development.

In addition, greater runoff velocities occur during spring snowmelts and rain-on-snow events in suburban watersheds than in less impervious rural areas (Buttle and Xu, 1988). Major snowmelt events can produce peak flows as large as 20 times initial flow runoff rates for urban areas (Pitt and McLean, 1992).

Figures 4-1 and 4-2 illustrate the changes in runoff characteristics resulting from an increasing percentage of impervious areas. Other physical characteristics of aquatic systems that are affected by urbanization include the total volume of watershed runoff baseflow, flooding frequency and severity, channel erosion and sediment generation, and temperature regime (Klein, 1985).

b. Water Quality Changes

Urban development also causes an increase in pollutants. The pollutants that occur in urban areas vary widely, from common organic material to highly toxic metals. Some pollutants, such as insecticides, road salts, and fertilizers, are intentionally placed in the urban environment. Other pollutants, including lead from automobile exhaust and oil drippings from trucks and cars, are the indirect result of urban activities (USEPA, 1977).

Many researchers have linked urbanization to degradation of urban waterways (e.g., Klein, 1985, Livingston and McCarron, 1992, Schueler, 1987). The major pollutants found in runoff from urban areas include sediment, nutrients, oxygen-demanding substances, road salts, heavy metals, petroleum hydrocarbons, pathogenic bacteria, and viruses. Livingston and McCarron (1992) concluded that urban runoff was the major source of pollutants in pollutant loadings to Florida's lakes and streams. Table 4-1 illustrates examples of pollutant loadings from urban areas. Table 4-2 describes potential sources of urban runoff pollutants.

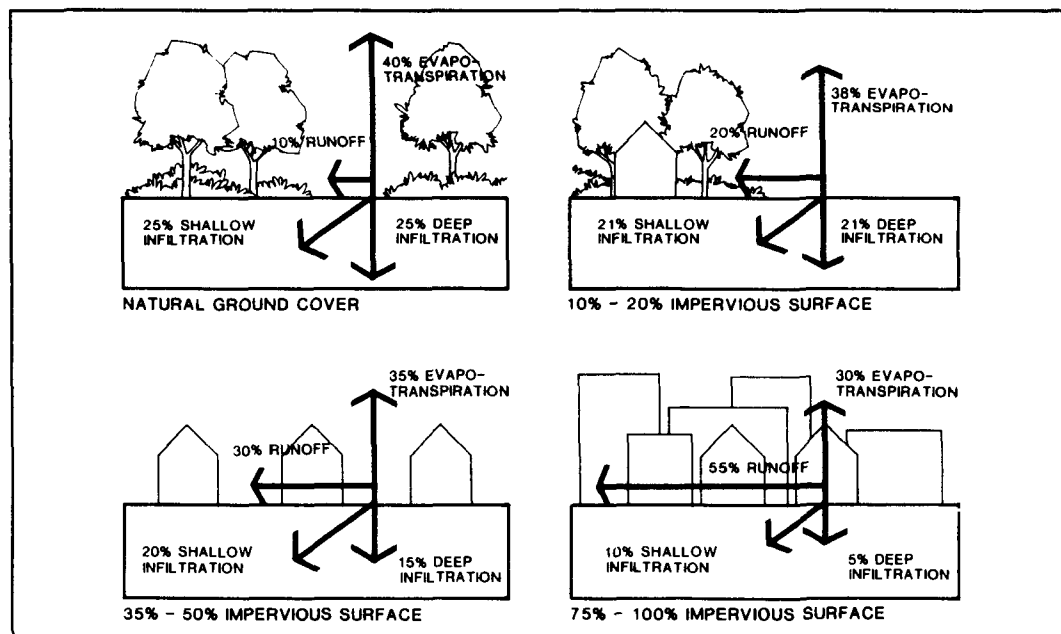

Figure 4-1. Changes in runoff flow resulting from increased impervious area (NC Dept. of Nat. Res. and Community Dev., in Livingston and McCarron, 1992).

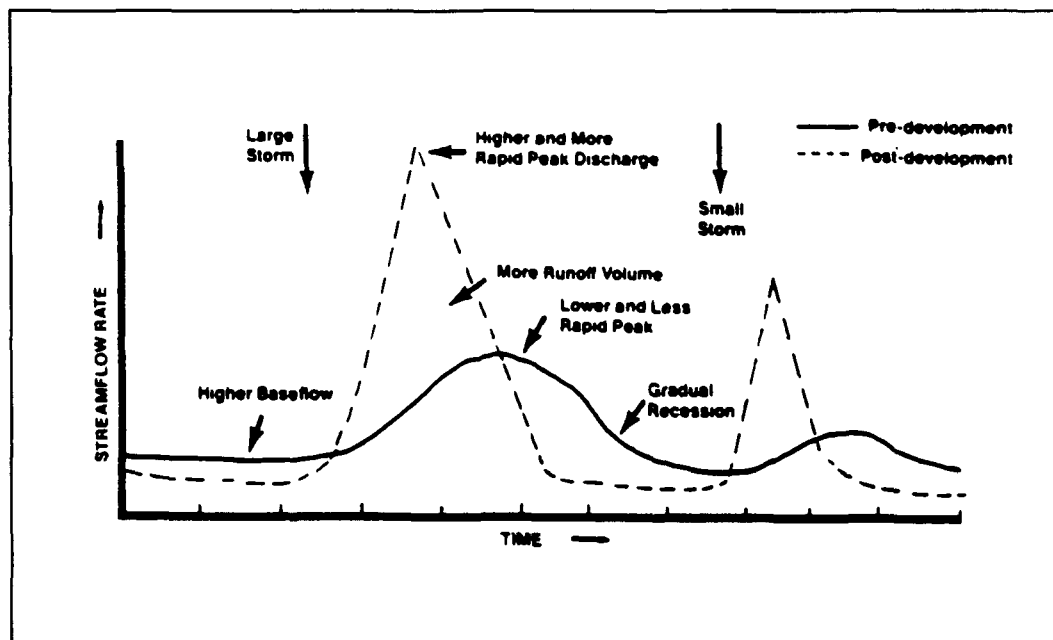

Figure 4-2. Changes in stream hydrology as a result of urbanization (Schueler, 1992).

2. Nonpoint Source Pollutants and Their Impacts

The following discussion identifies the principal types of pollutants found in urban runoff and describes their potential adverse effects (USEPA, 1990).

Sediment. Suspended sediments constitute the largest mass of pollutant loadings to surface waters. Sediment has both short- and long-term impacts on surface waters. Among the immediate adverse impacts of high concentrations of sediment are increased turbidity, reduced light penetration and decreases in submerged aquatic vegetation (SAV) (Chesapeake Implementation Committee, 1988), reduced prey capture for sight-feeding predators, impaired respiration of fish and aquatic invertebrates, reduced fecundity, and impairment of commercial and recreational fishing resources. Heavy sediment deposition in low-velocity surface waters may result in smothered benthic communities/reef systems

Table 4-1. Estimated Mean Runoff Concentrations for Land Uses, Based on the Nationwide Urban Runoff Program (Whalen and Cullum, 1989)

Parameter	Residential	Commercial	Industrial
TKN (mg/l)	0.23	1.5	1.6
NO ₃ + NO ₂ (mg/l)	1.8	0.8	0.93
Total P (mg/l)	0.62	2.29	0.42
Copper (µg/l)	56	50	32
Zinc (µg/l)	254	418	1,063
Lead (mg/l)	293	203	115
COD (mg/l)	102	84	62
TSS (mg/l)	228	168	108
BOD (mg/l)	13	14	62

**Table 4-2. Sources of Urban Runoff Pollutants
(Adapted from Woodward-Clyde, 1990)**

Source	Pollutants of Concern
Erosion	Sediment and attached soil nutrients, organic matter, and other adsorbed pollutants
Atmospheric deposition	Hydrocarbons emitted from automobiles, dust, aromatic hydrocarbons, metals, and other chemicals released from industrial and commercial activities
Construction materials	Metals from flashing and shingles, gutters and downspouts, galvanized pipes and metal plating, paint, and wood
Manufactured products	Heavy metals, halogenated aliphatics, phthalate esters, PAHs, other volatiles, and pesticides and phenols from automobile use, pesticide use, industrial use, and other uses
Plants and animals	Plant debris and animal excrement
Non-storm water connections	Inadvertent or deliberate discharges of sanitary sewage and industrial wastewater to storm drainage systems
Onsite disposal systems	Nutrients and pathogens from failing or improperly sited systems

(CRS, 1991), increased sedimentation of waterways, changes in the composition of bottom substrate, and degradation of aesthetic value. The primary cause of coral reef degradation in coastal areas is attributed to land disturbances and dredging activities due to urban development (Rogers, 1990). Additional chronic effects may occur where sediments rich in organic matter or clay are present. These enriched depositional sediments may present a continued risk to aquatic and benthic life, especially where the sediments are disturbed and resuspended.

Nutrients. The problems resulting from elevated levels of phosphorus and nitrogen are well known and are discussed in detail in Chapter 2 (agriculture). Excessive nutrient loading to marine ecosystems can result in eutrophication and depressed dissolved oxygen (DO) levels due to elevated phytoplankton populations. Eutrophication-induced hypoxia and anoxia have resulted in fish kills and widespread destruction of benthic habitats (Harper and Gullient, 1989). Surface algal scum, water discoloration, and the release of toxins from sediment may also occur. Species composition and size structure for primary producers may be altered by increased nutrient levels (Hecky and Kilham, 1988; GESAMP, 1989; Thingstad and Sakshaug, 1990).

Occurrences of eutrophication have been frequent in several coastal embayments along the northeast coast (Narragansett and Barnegat Bays), the Gulf Coast (Louisiana and Texas), and the West Coast (California and Washington) (NOAA, 1991). High nitrate concentrations have also been implicated in blooms of nuisance algae in Newport Bay, California (NRC, 1990b). Nutrient loadings in Louisiana coastal waters have decreased productivity, increased hypoxic events, and decreased fisheries yields (NOAA, 1991).

Oxygen-Demanding Substances. Proper levels of DO are critical to maintaining water quality and aquatic life. Decomposition of organic matter by microorganisms may deplete DO levels and result in the impairment of the waterbody. Data have shown that urban runoff with high concentrations of decaying organic matter can severely depress DO levels after storm events (USEPA, 1983). The NURP study found that oxygen-demanding substances can be present in urban runoff at concentrations similar to secondary treatment discharges.

Pathogens. Urban runoff typically contains elevated levels of pathogenic organisms. The presence of pathogens in runoff may result in waterbody impairments such as closed beaches, contaminated drinking water sources, and shellfish bed closings. OSDS-related pathogen contamination has been implicated in a number of shellfish bed closings. Table 4-3 shows the adverse impacts of septic systems and urban runoff on shellfish beds, resulting in closure. This problem may be especially prevalent in areas with porous or sandy soils.

Table 4-3. Percent of Limited or Restricted Classified Shellfish Waters Affected by Types of Pollution (Leonard et al., 1991)

	Septic Systems	Urban Runoff	Ag. Runoff	POTWs	Boats	Industry
North Atlantic	26	23	3	67	17	7
Mid-Atlantic	11	58	12	57	31	20
South Atlantic	34	34	28	44	17	21
Gulf	48	35	8	27	14	14
Pacific	19	36	13	25	15	42
Nationwide	37	38	11	37	18	17

Road Salts. In northern climates, road salts can be a major pollutant in urban areas. Klein (1985) reported on several studies by various authors of road salt contamination in lakes and streams and cases where well contamination had been attributed to road salts in New England. Snow runoff produces high salt/chlorine concentrations at the bottom of ponds, lakes, and bays. Not only does this condition prove toxic to benthic organisms, but it also prevents crucial vertical spring mixing (Bubeck et al., 1971; Hawkins and Judd, 1972).

Hydrocarbons. Petroleum hydrocarbons are derived from oil products, and the source of most such pollutants found in urban runoff is vehicles—auto and truck engines that drip oil. Many do-it-yourself auto mechanics dump used oil directly into storm drains (Klein, 1985). Concentrations of petroleum-based hydrocarbons are often high enough to cause mortalities in aquatic organisms.

Oil and grease contain a wide variety of hydrocarbon compounds. Some polynuclear aromatic hydrocarbons (PAHs) are known to be toxic to aquatic life at low concentrations. Hydrocarbons have a high affinity for sediment, and they collect in bottom sediments where they may persist for long periods of time and result in adverse impacts on benthic communities. Lakes and estuaries are especially prone to this phenomenon.

Heavy Metals. Heavy metals are typically found in urban runoff. For example, Klein (1985) reported on a study in the Chesapeake Bay that designated urban runoff as the source for 6 percent of the cadmium, 1 percent of the chromium, 1 percent of the copper, 19 percent of the lead, and 2 percent of the zinc.

Heavy metals are of concern because of toxic effects on aquatic life and the potential for ground-water contamination. Copper, lead, and zinc are the most prevalent NPS pollutants found in urban runoff. High metal concentrations may bioaccumulate in fish and shellfish and impact beneficial uses of the affected waterbody.

Toxics. Many different toxic compounds (priority pollutants) have been associated with urban runoff. NURP studies (USEPA, 1983) indicated that at least 10 percent of urban runoff samples contained toxic pollutants.

a. Pollutant Loading

Nonpoint source pollution has been associated with water quality standard violations and the impairment of designated uses of surface waters (Davenport, 1990). The 1990 Report to Congress on §319 of the Clean Water Act reported that:

- Siltation and nutrients are the pollutants most responsible for nonpoint source impacts to the Nation's surface waters, and

- Wildlife and recreation, (in particular, swimming, fishing, and shellfishing) are the uses most affected by nonpoint source pollution.

The pollutants described previously can have a variety of impacts on coastal resources. Examples of waterbodies that have been adversely impacted by nonpoint source pollution are varied.

- The Miami River and Biscayne Bay in Florida have experienced loss of habitat, loss of recreational and commercial fisheries, and decrease in productivity partly as the result of urban runoff (SFWMD, 1988).
- Shellfish beds in Port Susan, Puget Sound, Washington, have been declared unsafe for the commercial harvest of shellfish in part because of bacterial contamination from onsite disposal systems (USEPA, 1991).
- Impairment due to toxic pollution from urban runoff continues to be a problem in the southern part of San Francisco Bay (USEPA, 1992).
- Nonpoint sources of pollution have been implicated in degradation of water quality in Westport River, Massachusetts, a tributary of Buzzards Bay. High concentrations of coliform bacteria have been observed after rainfall events, and shellfish bed closures in the river have been attributed to loadings from surface runoff and septic systems (USEPA, 1992).
- In Brenner Bay, St. Thomas, U.S. Virgin Islands, populations of corals and shellfish and marine habitat have been damaged due to increased nutrient and sediment loadings. After several years of rapid urban development, less than 10 percent of original grass beds remain as a result of sediment shoaling, eutrophication, and algae blooms (Nichols and Towle, 1977).

b. Other Impacts

Other impacts not related to a specific pollutant can also occur as a result of urbanization. Temperature changes result from increased flows, removal of vegetative cover, and increases in impervious surfaces. Impervious surfaces act as heat collectors, heating urban runoff as it passes over the impervious surface. Recent data indicate that intensive urbanization can increase stream temperature as much as 5 to 10 degrees Celsius during storm events (Galli and Dubose, 1990). Thermal loading disrupts aquatic organisms that have finely tuned temperature limits. Salinity can also be affected by urbanization.

Freshwater inflows due to increased runoff can impact estuaries, especially if they occur in pulses, disrupting the natural salinity of an area. Increased impervious surface area and the presence of storm water conveyance systems commonly result in elevated peak flows in streams during and after storm events. These rapid pulses or influxes of fresh water into the watershed may be 2 to 10 times greater than normal (ABAG, 1991) This may lead to a decrease in the number of aquatic organisms living in the receiving waters (McLusky, 1989).

The alteration of natural hydrology due to urbanization and the accompanying runoff diversion, channelization, and destruction of natural drainage systems have resulted in riparian and tidal wetland degradation or destruction. Deltaic wetlands have also been impacted by changes in historic sediment deposition rates and patterns. Hydromodification projects designed to prevent flooding may reduce sedimentation rates and decrease marsh aggradation, which would normally offset erosion and apparent changes in sea level within the delta (Cahoon et al., 1983).

3. Opportunities

This chapter was organized to parallel the development process to address the prevention and treatment of nonpoint source pollution loadings during all phases of urbanization. (NOTE: The control of nonpoint source pollution requires the use of two primary strategies: the prevention of pollutant loadings and the treatment of unavoidable loadings. The strategy in this chapter relies primarily on the watershed approach, which focuses on pollution prevention or source reduction practices. While treatment options are an integral component of this chapter, a

combination of pollution prevention and treatment practices is favored because planning, design, and education practices are generally more effective, require less maintenance, and are more cost-effective in the long term.)

The major opportunities to control NPS loadings occur during the following three stages of development: the siting and design phase, the construction phase, and the postdevelopment phase. Before development occurs, land in a watershed is available for a number of pollution prevention and treatment options, such as setbacks, buffers, or open space requirements, as well as wet ponds or constructed urban runoff wetlands that can provide treatment of the inevitable runoff and associated pollutants. In addition, siting requirements/restrictions and other land use ordinances, which can be highly effective, are more easily implemented during this period. After development occurs, these options may no longer be practicable or cost-effective. Management Measures II.A through II.C address the strategies and practices that can be used during the initial phase of the urbanization process.

The control of construction-related sediment loadings is critical to maintaining water quality. The implementation of proper erosion and sediment control practices during the construction stage can significantly reduce sediment loadings to surface waters. Management Measures II.A and II.B address construction-related practices.

After development has occurred, lack of available land severely limits the implementation of cost-effective treatment options. Management Measure VI.A focuses on improving controls for existing surface water runoff through pollution prevention to mitigate nonpoint sources of pollution generated from ongoing domestic and commercial activities.

II. URBAN RUNOFF

A. New Development Management Measure

(1) By design or performance:

- (a) After construction has been completed and the site is permanently stabilized, reduce the average annual total suspended solid (TSS) loadings by 80 percent. For the purposes of this measure, an 80 percent TSS reduction is to be determined on an average annual basis,* or**
- (b) Reduce the postdevelopment loadings of TSS so that the average annual TSS loadings are no greater than predevelopment loadings, and**

(2) To the extent practicable, maintain postdevelopment peak runoff rate and average volume at levels that are similar to predevelopment levels.

Sound watershed management requires that both structural and nonstructural measures be employed to mitigate the adverse impacts of storm water. Nonstructural Management Measures II.B and II.C can be effectively used in conjunction with Management Measure II.A to reduce both the short- and long-term costs of meeting the treatment goals of this management measure.

* Based on the average annual TSS loadings from all storms less than or equal to the 2-year/24-hour storm. TSS loadings from storms greater than the 2-year/24-hour storm are not expected to be included in the calculation of the average annual TSS loadings.

1. Applicability

This management measure is intended to be applied by States to control urban runoff and treat associated pollutants generated from new development, redevelopment, and new and relocated roads, highways, and bridges. Under the Coastal Zone Act Reauthorization Amendments of 1990, States are subject to a number of requirements as they develop coastal nonpoint source (NPS) programs in conformity with this management measure and will have flexibility in doing so. The application of management measures by States is described more fully in *Coastal Nonpoint Pollution Control Program: Program Development and Approval Guidance*, published jointly by the U.S. Environmental Protection Agency (EPA) and the National Oceanic and Atmospheric Administration (NOAA) of the U.S. Department of Commerce.

For design purposes, postdevelopment peak runoff rate and average volume should be based on the 2-year/24-hour storm.

2. Description

This management measure is intended to accomplish the following: (1) decrease the erosive potential of increased runoff volumes and velocities associated with development-induced changes in hydrology; (2) remove suspended solids and associated pollutants entrained in runoff that result from activities occurring during and after development; (3) retain hydrological conditions to closely resemble those of the predisturbance condition; and (4) preserve natural systems including in-stream habitat.² For the purposes of this management measure, "similar" is defined as "resembling though not completely identical."

During the development process, both the existing landscape and hydrology can be significantly altered. As development occurs, the following changes to the land may occur (USEPA, 1977):

- Soil porosity decreases;
- Impermeable surfaces increase;
- Channels and conveyances are constructed;
- Slopes increase;
- Vegetative cover decreases; and
- Surface roughness decreases.

These changes result in increased runoff volume and velocities, which may lead to increased erosion of streambanks, steep slopes, and unvegetated areas (Novotny, 1991). In addition, destruction of in-stream and riparian habitat, increases in water temperature (Schueler et al., 1992), streambed scouring, and downstream siltation of streambed substrate, riparian areas, estuarine habitat, and reef systems may occur. An example of predicted effects of increased levels of urbanization on runoff volumes is presented in Table 4-4 (USDA-SCS, 1986). Methods are also available to compute peak runoff rates (USDA-SCS, 1986).

The annual TSS loadings can be calculated by adding the TSS loadings that can be expected to be generated during an average 1-year period from precipitation events less than or equal to the 2-year/24-hour storm. The 80 percent standard can be achieved by reducing, over the course of the year, 80 percent of these loadings. EPA recognizes that 80 percent cannot be achieved for each storm event and understands that TSS removal efficiency will fluctuate above and below 80 percent for individual storms.

Management Measures II.A, II.B, and II.C were selected as a system to be used to prevent and mitigate the problems discussed above. In combination, these three management measures applied on-site and throughout watersheds can be used to provide increased watershed protection and help prevent severe erosion, flooding, and increased pollutant loads generally associated with poorly planned development. Implementation of Management Measures II.B and II.C can help achieve the goals of Management Measure II.A.

Structural practices to control urban runoff rely on three basic mechanisms to treat runoff: **infiltration**, **filtration**, and **detention**. Table 4-5 lists specific urban runoff control practices that relate to these and includes information on advantages, disadvantages, and costs. Table 4-6 presents site-specific considerations, regional limitations, operation and maintenance burdens, and longevity for these practices.

² Several issues require clarification to fully understand the scope and intent of this management measure. First, this management measure applies only to postdevelopment loadings and not to construction-related loadings. Management measure options II.A.(1)(a) and (b) both apply only to the TSS loadings that are generated after construction has ceased and the site has been properly stabilized using permanent vegetative and/or structural erosion and sediment control practices. Second, for the purposes of this guidance, the term *predevelopment* refers to the sediment loadings and runoff volumes/velocities that exist onsite immediately before the planned land disturbance and development activities occur. Predevelopment is not intended to be interpreted as that period before any human-induced land disturbance activity has occurred. Third, management measure option II.A.(1)(b) is not intended to be used as an alternative to achieving an adequate level of control in cases where high sediment loadings are the result of poor management of developed sites (not "natural" sites), e.g., farmlands where the erosion control components of the USDA conservation management system are not used or sites where land disturbed by previous development was not permanently stabilized.

Table 4-4. Example Effects of Increased Urbanization on Runoff Volumes (USDA-SCS, 1986)

Development Scenario	Predicted Runoff
100 percent open space	2.81 inches (baseline)
70 percent of the total area divided into 1/2-acre lots; each lot is 25 percent impervious; 30 percent of the total area is open space	3.28 inches (24 percent increase)
70 percent of the total area is divided into 1/2-acre lots; each lot is 35 percent impervious; 30 percent of the total area is open space	3.48 inches (24 percent increase)
30 percent of the total area is divided into 1/2-acre lots - each lot is 25 percent impervious and contiguous; 40 percent is divided into 1/2-acre lots - each lot is 50 percent impervious and discontinuous; 30 percent of the total area is open space	3.19 inches (14 percent increase)

Infiltration devices, such as infiltration trenches, infiltration basins, filtration basins, and porous and concrete block pavement, rely on absorption of runoff to treat urban runoff discharges. Water is percolated through soils, where filtration and biological action remove pollutants. Systems that rely on soil absorption require deep permeable soils at separation distances of at least 4 feet between the bottom of the structure and seasonal ground water levels. The widespread use of infiltration in a watershed can be useful to maintain or restore predevelopment hydrology, increase dry-weather baseflow, and reduce bankfull flooding frequency. However, infiltration systems may not be appropriate where ground water requires protection. Restrictions may also apply to infiltration systems located above sole source (drinking water) aquifers. Where such designs are selected, they should be incorporated with the recognition that periodic maintenance is necessary for these areas. Long-term effectiveness in most cases will depend on proper operation and maintenance of the entire system.

NOTE: Infiltration systems, some filtration devices, and sand filters should be installed after construction has been completed and the site has been permanently stabilized. The State of Maryland has observed a high failure rate for infiltration systems. Many of these failures can be attributed to clogging due to sediment loadings generated during the construction process and/or the premature use of the device before proper stabilization of the site has occurred. In cases where construction of the infiltration system is necessary before the cessation of land-disturbing activities, diversions, covers, or other means to prevent sediment-laden runoff from entering and clogging the infiltration system should be used (State of Maryland DNR, personal communication, 1991).

Filtration practices such as filter strips, grassed swales, and sand filters treat sheet flow by using vegetation or sand to filter and settle pollutants. In some cases infiltration and treatment in the subsoil may also occur. After passing through the filtration media, the treated water can be routed into streams, drainage channels, or other waterbodies; evaporated; or percolated into ground water. Sand filters are particularly useful for ground-water protection. The influence of climatic factors must be considered in the process of selecting vegetative systems.

Detention practices temporarily impound runoff to control runoff rates, and settle and retain suspended solids and associated pollutants. Extended detention ponds and wet ponds fall within this category. Constructed urban runoff wetlands and multiple-pond systems also remove pollutants by detaining flows that lead to sedimentation (gravitational settling of suspended solids). Properly designed ponds protect downstream channels by controlling discharge velocities, thereby reducing the frequency of bankfull flooding and resultant bank-cutting erosion. If landscaped and planted with appropriate vegetation, these systems can reduce nutrient loads and also provide terrestrial and aquatic wildlife habitat. When considering the use of these devices, potential negative impacts such as downstream warming, reduced baseflow, trophic shifts, bacterial contamination due to waterfowl, hazards to

Table 4-5. Advantages and Disadvantages of Management Practices

Management Practice	Advantages	Disadvantages	Comparative Cost (Schueler, Kumble, and Heraty, 1992)
Infiltration Basin	<ul style="list-style-type: none"> • Provides ground-water recharge • Can serve large developments • High removal capability for particulate pollutants and moderate removal for soluble pollutants • When basin works, it can replicate predevelopment hydrology more closely than other BMP options • Basins provide more habitat value than other infiltration systems 	<ul style="list-style-type: none"> • Possible risk of contaminating ground water • Only feasible where soil is permeable and there is sufficient depth to rock and water table • Fairly high failure rate • If not adequately maintained, can be an eyesore, breed mosquitoes, and create undesirable odors • Regular maintenance activities cannot prevent rapid clogging of infiltration basins 	Construction cost moderate but rehabilitation cost high
Infiltration Trench	<ul style="list-style-type: none"> • Provides ground-water recharge • Can serve small drainage areas • Can fit into medians, perimeters, and other unused areas of a development site • Helps replicate predevelopment hydrology, increases dry weather baseflow, and reduces bankfull flooding frequency 	<ul style="list-style-type: none"> • Possible risk of contaminating ground water • Only feasible where soil is permeable and there is sufficient depth to rock and water table • Since not as visible as other BMPs, less likely to be maintained by residents • Requires significant maintenance 	Cost-effective on smaller sites. Rehabilitation costs can be considerable.
Vegetated Filter Strip (VFS)	<ul style="list-style-type: none"> • Low maintenance requirements • Can be used as part of the runoff conveyance system to provide pretreatment • Can effectively reduce particulate pollutant levels in areas where runoff velocity is low to moderate • Provides excellent urban wildlife habitat • Economical 	<ul style="list-style-type: none"> • Often concentrates water, which significantly reduces effectiveness • Ability to remove soluble pollutants highly variable • Limited feasibility in highly urbanized areas where runoff velocities are high and flow is concentrated • Requires periodic repair, regrading, and sediment removal to prevent channelization 	Low

Table 4-5. (Continued)

Management Practice	Advantages	Disadvantages	Comparative Cost (Schueler, Kumble, and Heraty, 1992)
Grassed Swale	<ul style="list-style-type: none"> • Requires minimal land area • Can be used as part of the runoff conveyance system to provide pretreatment • Can provide sufficient runoff control to replace curb and gutter in single-family residential subdivisions and on highway medians • Economical 	<ul style="list-style-type: none"> • Low pollutant removal rates • Leaching from culverts and fertilized lawns may actually increase the presence of trace metals and nutrients 	Low compared to curb and gutter
Porous Pavement	<ul style="list-style-type: none"> • Provides ground-water recharge • Provides water quality control without additional consumption of land • Can provide peak flow control • High removal rates for sediment, nutrients, organic matter, and trace metals • When operating properly can replicate predevelopment hydrology • Eliminates the need for stormwater drainage, conveyance, and treatment systems off-site 	<ul style="list-style-type: none"> • Requires regular maintenance • Possible risk of contaminating ground water • Only feasible where soil is permeable, there is sufficient depth to rock and water table, and there are gentle slopes • Not suitable for areas with high traffic volume • Need extensive feasibility tests, inspections, and very high level of construction workmanship (Schueler, 1987) • High failure rate due to clogging • Not suitable to serve large off-site pervious areas 	Cost-effective compared to conventional asphalt when working properly
Concrete Grid Pavement	<ul style="list-style-type: none"> • Can provide peak flow control • Provides ground-water recharge • Provides water quality control without additional consumption of land 	<ul style="list-style-type: none"> • Requires regular maintenance • Not suitable for area with high traffic volume • Possible risk of contaminating ground water • Only feasible where soil is permeable, there is sufficient depth to rock and water table, and there are gentle slopes 	Information not available

Table 4-5. (Continued)

Management Practice	Advantages	Disadvantages	Comparative Cost (Schueler, Kumble, and Heraty, 1992)
Filtration Basin	<ul style="list-style-type: none"> Ability to accommodate medium-size development (3-80 acres) Flexibility to provide or not provide ground-water recharge Can provide peak volume control 	<ul style="list-style-type: none"> Requires pretreatment of storm water through sedimentation to prevent filter media from prematurely clogging 	Information not available
Water Quality Inlets Catch Basins	<ul style="list-style-type: none"> Provide high degree of removal efficiencies for larger particles and debris as pretreatment Require minimal land area Flexibility to retrofit existing small drainage areas and applicable to most urban areas 	<ul style="list-style-type: none"> Not feasible for drainage area greater than 1 acre Marginal removal of small particles, heavy metals, and organic pollutants Not effective as water quality control for intense storms Minimal nutrient removal 	Information not available
Water Quality Inlet Catch Basins with Sand Filter	<ul style="list-style-type: none"> Provide high removal efficiencies of particulates Require minimal land area Flexibility to retrofit existing small drainage areas Higher removal of nutrient as compared to catch basins and oil/grid separator 	<ul style="list-style-type: none"> Not feasible for drainage area greater than 5 acres Only feasible for areas that are stabilized and highly impervious Not effective as water quality control for intense storms 	Information not available
Water Quality Inlet Oil/Grit Separator	<ul style="list-style-type: none"> Captures coarse-grained sediments and some hydrocarbons Requires minimal land area Flexibility to retrofit existing small drainage areas and applicable to most urban areas Shows some capacity to trap trash, debris, and other floatables Can be adapted to all regions of the country 	<ul style="list-style-type: none"> Not feasible for drainage area greater than 1 acre Minimal nutrient and organic matter removal Not effective as water quality control for intense storms Concern exists over the pollutant toxicity of trapped residuals Require high maintenance 	High, compared to trenches and sand filters

Table 4-5. (Continued)

Management Practice	Advantages	Disadvantages	Comparative Cost (Schueler, Kumble, and Heraty, 1992)
Extended Detention Dry Pond	<ul style="list-style-type: none"> • Can provide peak flow control • Possible to provide good particulate removal • Can serve large development • Requires less capital cost and land area when compared to wet pond • Does not generally release warm or anoxic water downstream • Provides excellent protection for downstream channel erosion • Can create valuable wetland and meadow habitat when properly landscaped 	<ul style="list-style-type: none"> • Removal rates for soluble pollutants are quite low • Not economical for drainage area less than 10 acres • If not adequately maintained, can be an eyesore, breed mosquitoes, and create undesirable odors 	Lowest cost alternative in size range
Wet Pond	<ul style="list-style-type: none"> • Can provide peak flow control • Can serve large developments; most cost-effective for larger, more intensively developed sites • Enhances aesthetics and provides recreational benefits • Little ground-water discharge • Permanent pool in wet ponds helps to prevent scour and resuspension of sediments • Provides moderate to high removal of both particulate and soluble urban stormwater pollutants 	<ul style="list-style-type: none"> • Not economical for drainage area less than 10 acres • Potential safety hazards if not properly maintained • If not adequately maintained, can be an eyesore, breed mosquitoes, and create undesirable odors • Requires considerable space, which limits use in densely urbanized areas with expensive land and property values • Not suitable for hydrologic soil groups "A" and "B" (SCS classification) • With possible thermal discharge and oxygen depletion, may severely impact downstream aquatic life 	Moderate to high compared to conventional storm water detention

Table 4-5. (Continued)

Management Practice	Advantages	Disadvantages	Comparative Cost (Schueler, Kumble, and Heraty, 1992)
Extended Detention Wet Pond	<ul style="list-style-type: none"> • Can provide peak flow control • Can serve large developments; most cost-effective for larger, more intensively developed sites • Enhances aesthetic and provide recreational benefits • Permanent pool in wet ponds helps to prevent scour and resuspension of sediments • Provides better nutrient removal when compared to wet pond 	<ul style="list-style-type: none"> • Not economical for drainage area less than 10 acres • Potential safety hazards if not properly maintained • If not adequately maintained, can be an eyesore, breed mosquitoes, and create undesirable odors • Requires considerable space, which limits use in densely urbanized areas with expensive land and property values • Not suitable for hydrologic soil groups "A" and "B"(SCS classification) • With possible thermal discharge and oxygen depletion, may severely impact downstream aquatic life 	

Table 4-5. (Continued)

Management Practice	Advantages	Disadvantages	Comparative Cost (Schueler, Kumble, and Heraty, 1992)
Constructed Stormwater Wetland	<ul style="list-style-type: none"> • Can serve large developments; most cost-effective for larger, more intensively developed sites • Provides peak flow control • Enhances aesthetics and provides recreational benefits • The marsh fringe also protects shoreline from erosion • Permanent pool in wet ponds helps to prevent scour and resuspension of sediments • Has high pollutant removal capability 	<ul style="list-style-type: none"> • Not economical for drainage area less than 10 acres • Potential safety hazards if not properly maintained • If not adequately maintained can be an eyesore, breed mosquitoes, and create undesirable odors • Requires considerable space, which limits use in densely urbanized areas with expensive land and property values • With possible thermal discharge and oxygen depletion, may severely impact downstream aquatic life • May contribute to nutrient loadings during die-down periods of vegetation 	Marginally higher than wet ponds

Table 4-6. Regional, Site-Specific, and Maintenance Considerations for Structural Practices to Control Sediments in Storm Water Runoff (Schueler et al., 1992)

BMP Option	Size of Drainage Area	Site Requirements	Regional Restrictions	Maintenance Burdens	Longevity
Infiltration basins	Moderate to large	Deep permeable soils	Arid and cold regions	High	Low
Infiltration trenches	Moderate	Same as for infiltration basins			
Vegetated filter strips	Small	Low-density areas with low slopes	Arid and cold regions	Low	Low if poorly maintained
Grassed swales	Small	Low-density areas with <15% slope	Arid and cold regions	Low	High if maintained
Porous pavement	Small	Deep permeable soils, low slopes, and restricted traffic	Arid and cold regions or high wind erosion rates	High	Low
Concrete grid pavement	Small	Same as for porous pavement		Moderate to high	High
Filtration basins and sand filters	Widely applicable	Widely applicable	Arid and cold regions	Moderate	Low to moderate
Water quality inlets	Small	Impervious catchments	Few restrictions	Cleaned twice a year	High
Extended detention ponds	Moderate to large	Deep soils	Few restrictions	Dry ponds have relatively high burdens	High
Wet ponds	Moderate to large	Deep soils	Arid regions	Low	High
Constructed storm water wetlands	Moderate to large	Poorly drained soils, space may be limiting	Arid regions	Annual harvesting of vegetation	High

nearby residents, and nuisance factors such as mosquitoes and odor should be considered. Siting development in wetlands and floodplains should be avoided. Where drainage areas are greater than 250 acres and ponds are being considered, inundation of upstream channels may be of concern.

Constructed wetlands and multiple-pond systems also treat runoff through the processes of adsorption, plant uptake, filtration, volatilization, precipitation, and microbial decomposition (Livingston and McCarron, 1992; Schueler et al., 1992). Multiple-pond systems in particular have shown potential to provide much higher levels of treatment (Schueler et al., 1992). In general, the potential concerns and drawbacks applicable to wet ponds apply to these systems. Many of these systems are currently being designed to include vegetated buffers and deep-water areas to provide habitat for wildlife and aesthetic benefits. Where such designs are selected, they should be incorporated with the recognition that periodic maintenance is necessary. Long-term effectiveness in most cases will depend on proper operation and maintenance of the entire system. Refer to Chapter 7 for additional information on constructed wetlands.

Water quality inlets, like ponds, rely on gravity settling to remove pollutants before ponds discharge water to the storm sewer or other collection system. Water quality inlets are designed to trap floatable trash and debris. When inlets are coupled with oil/grit separators, hydrocarbon loadings from areas with high traffic/parking volumes can be reduced. However, experience has shown that these devices have limited pollutant-removal effectiveness and should not be used unless coupled with frequent and effective clean-out methods (Schueler et al., 1992). Although no costs are currently available, proper maintenance of water quality inlets must include proper disposal of trapped coarse-grained sediments and hydrocarbons. The costs of clean-out and disposal may be significant when contaminated sediments require proper disposal.

Inadequate maintenance is often cited as one of the major factors influencing the poor effectiveness of structural practices. The cost of long-term maintenance should be evaluated during the selection process. In addition, responsibility for maintenance should be clearly assigned for the life of the system. Typical maintenance requirements include:

- Inspection of basins and ponds after every major storm for the first few months after construction and annually thereafter;
- Mowing of grass filter strips and swales at a frequency to prevent woody growth and promote dense vegetation;
- Removal of litter and debris from dry ponds, forebays, and water quality inlets;
- Revegetation of eroded areas;
- Periodic removal and replacement of filter media from infiltration trenches and filtration ponds;
- Deep tilling of infiltration basins to maintain infiltrative capability;
- Frequent (at least quarterly) vacuuming or jet hosing of porous pavements or concrete grid pavements;
- Quarterly clean-outs of water quality inlets;
- Periodic removal of floatables and debris from catch basins, water quality inlets, and other collection-type controls; and
- Periodic removal and proper disposal of accumulated sediment (applicable to all practices). Sediments in infiltration devices need to be removed frequently enough to prevent premature failure due to clogging.

Operation and Maintenance

Proper operation and maintenance of structural treatment facilities is critical to their effectiveness in mitigating adverse impacts of urban runoff. The proper installation and maintenance of various BMPs often determines their success or failure (Reinalt, 1992).

During a field study of 51 urban runoff treatment facilities, the Ocean County, New Jersey, planning and engineering departments determined that the major source of urban runoff problems was a failure of the responsible party to provide adequate facility maintenance. The causes of this failure are complex and include factors such as lack of funding, manpower, and equipment; uncertain or irresponsible ownership; unassigned maintenance responsibility; and ignorance or disregard of potential consequences of maintenance neglect (Ocean County, 1989). The analysis of the field data collected during the study indicated the following trends:

- Bottoms, side slopes, trash racks, and low-flow structures were the primary sources of maintenance problems.

- Infiltration facilities seemed to be more prone to maintenance neglect and were generally in the poorest condition overall.
- Retention facilities appeared to receive the greatest amount of maintenance and generally were in the best condition overall.
- Publicly owned facilities were usually better maintained than those that were privately maintained.
- Facilities located at office development sites were better maintained than those at commercial or institutional sites; facilities in residential areas received average maintenance.
- Highly visible urban runoff facilities were generally better maintained than those in more remote, less visible locations (Ocean County, 1989).

The following program elements should be considered to ensure the proper design, implementation, and operation and maintenance of runoff treatment and control devices (adapted from The State of New Jersey Ocean County Demonstration Study's *Storm Water Management Facilities Maintenance Manual*):

- Adoption, promulgation, and implementation of planning and design standards that eliminate, reduce, and/or facilitate facility maintenance; coordination with other regulatory authorities with jurisdiction over runoff facilities;
- Establishment of a comprehensive design review program, which includes training and education to ensure adequate staff competency and expertise;
- Design standards published in a readily understandable format for all permittees and responsible parties including regulatory authorities; the provision of clear requirements to promote the adoption of planning and standards and expedite facility review and approval;
- Publication of specific obligations and responsibilities of the runoff facility owner/operator including procedures for the identification of owners/operators who will have long-term responsibility for the facility;
- Development of a procedure for addressing maintenance default by negligent owner/operators;
- Periodic review and evaluation of the runoff management program to ensure continued program effectiveness and efficiency;
- Runoff facility construction inspection program; and
- Provisions for public assumption of runoff control facilities.

3. Management Measure Selection

This management measure was selected because of the following factors.

- (1) Removal of 80 percent of total suspended solids (TSS) is assumed to control heavy metals, phosphorus, and other pollutants.
- (2) A number of coastal States, including Delaware and Florida, and the Lower Colorado River Authority (Texas) require and have implemented a TSS removal treatment standard of at least 80 percent for new development.

- (3) Analysis has shown that constructed wetlands, wet ponds, and infiltration basins can remove 80 percent of TSS, provided they are designed and maintained properly. Other practices or combinations of practices can be also used to achieve the goal.
- (4) The control of postdevelopment volume and peak runoff rates to reduce or prevent streambank erosion and stream scouring and to maintain predevelopment hydrological conditions can be accomplished using a number of water quality and flood control practices. Many States and local governments have implemented requirements that stipulate that, at a minimum, the 2-year/24-hour storm be controlled.

Management Measure II.A.(1)(b) was selected to provide a descriptive alternative to Management Measure II.A.(1)(a). Where preexisting conditions do not already present a water quality problem, preservation of predevelopment TSS loading levels is intended to promote TSS loading reductions that adequately protect surface waters and are equivalent to or greater than the levels achieved by Management Measure option II.A.(1)(a). In some cases, local conditions (e.g., mountainous areas with arid, steep slopes) may preclude the implementation of Management Measure II.A.(1)(a). Where local conditions do not allow the implementation of BMPs such as grassed swales or detention basins, and preconstruction/predevelopment (existing conditions) TSS loadings from the site are significant, it may not be cost-effective or beneficial to require 80 percent TSS postdevelopment loading reductions. Management Measure option II.A.(1)(b) was provided to allow flexibility where such conditions exist. This flexibility will be especially important in cases where loadings from surrounding undeveloped areas dwarf the TSS loadings generated from the new development. (NOTE: Predevelopment is defined, in the context of Management Measure II.A.(1)(b), as the sediment loadings and runoff volumes/velocities that exist onsite immediately before the planned land disturbance and development occur.)

4. Practices

As discussed more fully at the beginning of this chapter and in Chapter 1, the following practices are described for illustrative purposes only. State programs need not require implementation of these practices. However, as a practical matter, EPA anticipates that the management measure set forth above generally will be implemented by applying one or more management practices appropriate to the source, location, and climate. The practices set forth below have been found by EPA to be representative of the types of practices that can be applied successfully to achieve the management measure described above.

Cost and effectiveness information for these practices is shown in Tables 4-7 and 4-8. Many of these practices can be used during site development, but the focus of this section is the abatement of postdevelopment impacts.

- a.** *Develop training and education programs and materials for public officials, contractors, and others involved with the design, installation, operation, inspection, and maintenance of urban runoff facilities.*

Training programs and educational materials for public officials, contractors, and the public are crucial to implementing effective urban runoff management programs. Contractor certification, inspector training, and competent design review staff are important for program implementation and continuing effectiveness. The State of New Jersey Ocean County Demonstration Study's *Storm Water Management Facilities Maintenance Manual* addresses many of these issues and provides guidance on programmatic elements necessary for the proper operation and maintenance of urban runoff facilities. Several other States and local governments, including Virginia, Maryland, Washington, Delaware, Northeastern Illinois Planning Commission, and the City of Alexandria, Virginia, have developed manuals and training materials to assist in implementation of urban runoff requirements and regulations.

The State of Delaware passed legislation requiring that "all responsible personnel involved in a construction project will have a certificate of attendance at a Departmental sponsored or approved training course for the control of sediment and storm water before initiation of land disturbing activity." The State provides personnel training and educational opportunities for contractors to meet this requirement and has delegated program elements to conservation

Table 4-7. Effectiveness of Management Practices for Control of Runoff From Newly Developed Areas

Management Practice	Removal Efficiency (%)						Factors	References	
	TSS	TP	TN	COD	Pb	Zn			
INFILTRATION BASIN	Average:	75	65	60	65	65	65	<ul style="list-style-type: none"> • Soil percolation rates • Basin surface area • Storage volume 	NVPDC, 1979; EPA, 1977; Schueler, 1987; Griffin, et al, 1980; EPA, 1983; Woodward-Clyde, 1986
	Reported Range:	45-100	45-100	45-100	45-100	45-100	45-100		
	Probable Range: ^a								
	SCS Soil Group A	60-100	60-100	60-100	60-100	60-100	60-100		
	SCS Soil Group B	50-80	50-80	50-80	50-80	50-80	50-80		
No. Values Considered:	7	7	7	4	4	4			
INFILTRATION TRENCH	Average:	75	60	55	65	65	65	<ul style="list-style-type: none"> • Soil percolation rates • Trench surface area • Storage volume 	NVPDC, 1979; EPA, 1977; Schueler, 1987; Griffin, et al, 1980; EPA, 1983; Woodward-Clyde, 1986; Kuo et al., 1988; Lugbill, 1990
	Reported Range:	45-100	40-100	(-10)-100	45-100	45-100	45-100		
	Probable Range: ^b								
	SCS Soil Group A	60-100	60-100	60-100	60-100	60-100	60-100		
	SCS Soil Group B	50-90	50-90	50-90	50-90	50-90	50-90		
No. Values Considered:	9	9	9	4	4	4			
VEGETATED FILTER STRIP	Average:	65	40	40	40	45	60	<ul style="list-style-type: none"> • Runoff volume • Slope • Soil infiltration rates • Vegetative cover • Buffer length 	IEP, 1991; Casman, 1990; Glick et al., 1991; VADC, 1987; Minnesota PCA, 1989; Schueler, 1987; Hartigan et al., 1989
	Reported Range:	20-80	0-95	0-70	0-80	20-90 ^H	30-90 ^I		
	Probable Range: ^c	40-90	30-80	20-60	--	30-80	20-50		
	No. Values Considered:	7	4	3	2	3	3		
GRASS SWALE	Average:	60	20	10	25	70	60	<ul style="list-style-type: none"> • Runoff volume • Slope • Soil infiltration rates • Vegetative cover • Swale length • Swale geometry 	Yousef et al., 1985; Dupuis, 1985; Washington State, 1988; Schueler, 1987; British Columbia Res. Corp., 1991; EPA, 1983; Whalen, et al., 1988; Pitt, 1986; Casman, 1990
	Reported Range:	0-100	0-100	0-40	25	3-100 ^H	50-60 ^H		
	Probable Range: ^d	20-40	20-40	10-30	--	10-20	10-20		
	No. Values Considered:	10	8	4	1	10	7		

Table 4-7. (Continued)

Management Practice		Removal Efficiency (%)						Factors	References
		TSS	TP	TN	COD	Pb	Zn		
POROUS PAVEMENT	Average:	90	65	85	80	100	100	<ul style="list-style-type: none"> • Percolation rates • Storage volume 	Schueler, 1987
	Reported Range:	80-95	65	80-85	80	100	100		
	Probable Range:	60-90	60-90	60-90	60-90	60-90	60-90		
	No. Values Considered:	2	2	2	2	2	2		
CONCRETE GRID PAVEMENT	Average:	90	90	90	90	90	90	<ul style="list-style-type: none"> • Percolation rates 	Day, 1981; Smith, et al, 1981; Schueler, 1987
	Reported Range:	65-100	65-100	65-100	65-100	65-100	65-100		
	Probable Range:	60-90	60-90	60-90	60-90	60-90	60-90		
	No. Values Considered:	2	2	2	2	2	2		
SAND FILTER/FILTRATION BASIN	Average:	80	50	35	55	60	65	<ul style="list-style-type: none"> • Treatment volume • Filtration media 	City of Austin, 1988; Environmental and Conservation Service Department, 1990
	Reported Range:	60-95	0-90	20-40	45-70	30-90	50-80		
	Probable Range:	60-90	0-80	20-40	40-70	40-80	40-80		
	No. Values Considered:	10	6	7	3	5	5		
WATER QUALITY INLET ^a	Average:	35	5	20	5	15	5	<ul style="list-style-type: none"> • Maintenance • Sedimentation storage volume 	Pitt, 1896; Field, 1985; Schueler, 1987
	Reported Range:	0-95	5-10	5-55	5-10	10-25	5-10		
	Probable Range:	10-25	5-10	5-10	5-10	10-25	5-10		
	No. Values Considered:	3	1	2	1	2	1		

Table 4-7. (Continued)

Management Practice		Removal Efficiency (%)						Factors	References
		TSS	TP	TN	COD	Pb	Zn		
WATER QUALITY INLET WITH SAND FILTER ⁹	Average:	80	NA	35	55	80	65	• Sedimentation storage volume	Shaver, 1991
	Reported Range:	75-85	NA	30-45	45-70	70-90	50-80		
	Probable Range:	70-90	--	30-40	40-70	70-90	50-80	• Depth of filter media	
	No. Values Considered:	1	0	1	1	1	1		
OIL/GRIT SEPARATOR ⁹	Average:	15	5	5	5	15	5	• Sedimentation storage volume	Pitt, 1985; Schueler, 1987
	Reported Range:	0-25	5-10	5-10	5-10	10-25	5-10		
	Probable Range:	10-25	5-10	5-10	5-10	10-25	5-10	• Outlet configurations	
	Number of References	2	1	1	1	1	1		
EXTENDED DETENTION DRY POND	Average:	45	25	30	20	50	20	• Storage volume • Detention time • Pond shape	MWCOG, 1983; City of Austin, 1990; Schueler and Helfrich, 1988; Pope and Hess, 1989; OWML, 1987; Wolinski and Stack, 1990
	Reported Range:	5-90	10-55	20-60	0-40	25-65	(-40)-65		
	Probable Range: ⁹	70-90	10-60	20-60	30-40	20-60	40-60		
	No. Values Considered:	6	6	4	5	4	5		
WET POND	Average:	60	45	35	40	75	60	• Pool volume • Pond shape	Wotzka and Oberta, 1988; Yousef et al., 1986; Cullum, 1985; Driscoll, 1983; Driscoll, 1986; MWCOG, 1983; OWML, 1983; Yu and Benemouffok, 1988; Holler, 1989; Martin, 1988; Dorman et al., 1989; OWML, 1982; City of Austin, 1990
	Reported Range:	(-30)-91	10-85	5-85	5-90	10-95	10-95		
	Probable Range:	50-90	20-90	10-90	10-90	10-95	20-95		
	No. Values Considered:	18	18	9	7	13	13		

Table 4-7. (Continued)

Management Practice		Removal Efficiency (%)						Factors	References
		TSS	TP	TN	COD	Pb	Zn		
EXTENDED DETENTION WET POND	Average:	80	65	55	NA	40	20	<ul style="list-style-type: none"> • Pool volume • Pond shape • Detention time 	Ontario Ministry of the Environment, 1991, cited in Schueler et al., 1992
	Reported Range:	50-100	50-80	55	NA	40	20		
	Probable Range:	50-95	50-90	10-90	10-90	10-95	20-95		
	No. Values Considered:	3	3	1	0	1	1		
CONSTRUCTED STORMWATER WETLANDS	Average:	65	25	20	50	65	35	<ul style="list-style-type: none"> • Storage volume • Detention time • Pool shape • Wetland's biota • Seasonal variation 	Harper et al., 1986; Brown, 1985; Wotzka and Obert, 1988; Hickock et al., 1977; Barten, 1987; Melorin, 1986; Morris et al., 1981; Sherberger and Davis, 1982; ABAG, 1979; Oberts et al., 1989; Rushton and Dye, 1990; Hey and Barrett, 1991; Martin and Smoot, 1986, Reinelt et al., 1990, cited in Woodward-Clyde, 1991
	Reported Range:	(-20)-100	(-120)-100	(-15)-40	20-80	30-95	(-30)-80		
	Probable Range ^d :	50-90	(-5)-80	0-40	---	30-95	---		
	No. Values Considered:	23	24	8	2	10	8		

NA - Not available.

^a Design criteria: storage volume equals 90% avg runoff volume, which completely drains in 72 hours; maximum depth = 8 ft; minimum depth = 2 ft.

^b Design criteria: storage volume equals 90% avg runoff volume, which completely drains in 72 hours; maximum depth = 8 ft; minimum depth = 3 ft; storage volume = 40% excavated trench volume.

^c Design criteria: flow depth < 0.3 ft, travel time > 5 min.

^d Design criteria: low slope and adequate length.

^e Design criteria: min. ED time 12 hours.

^f Design criteria: minimum area of wetland equal 1% of drainage area.

^g No information was available on the effectiveness of removing grease or oil.

^h Also reported as 90% TSS removed.

ⁱ Also reported as 50% TSS removed.

Table 4-8. Cost of Management Practices for Control of Runoff from Newly Developed Areas

Practice	Land requirement	Construction cost	Useful life	Annual O&M	Total annual cost	References
Infiltration Basin	High	Average: \$0.5/ ft ³ storage Probable Cost: \$0.4 - \$0.7/ft ³ Reported Range: \$0.2 - \$1.2/ ft ³	25 ^a	Average: 7% of capital cost Reported Range: 3% - 13% of capital cost	\$0.03 - \$0.05/ ft ³	Wiegand, et al, 1986; SWRPC, 1991
Infiltration Trench	Low	Average: \$4.0/ ft ³ storage Probable Cost: \$2.5 - \$7.5/ft ³ Reported Range: \$0.9 - \$9.2/ ft ³	10 ^a	Average: 9% of capital cost Reported Range: 5% - 15% of capital cost	\$0.3 - \$0.9/ft ³	Wiegand, et al, 1986; Macal, et al, 1987; SWRPC, 1991; Kuo, et al, 1988
Vegetative Filter Strip	Varies	Established from existing vegetation- Average: \$0 Reported Range: \$0 Established from seed- Average: \$400/ acre Reported Range: \$200 - \$1,000/ acre Established from seed and mulch- Average: \$1,500/ acre Reported Range: \$800 - \$3,500/ acre Established from sod- Average: \$11,300/ acre Reported Range: \$4,500 - \$48,000/ acre	50 ^b	Natural succession allowed to occur- Average: \$100/ acre Reported Range: \$50 - \$200/ acre Natural succession not allowed to occur- Average: \$800/ acre Reported Range: \$700 - \$900/ acre	Natural succession allowed to occur- Established from-Natural vegetation: \$100/ acre Seed: \$125/ acre Seed & mulch: \$200/ acre Sod: \$700/ acre Natural succession not allowed to occur- Established from: natural vegetation: \$800/acre Seed: \$825/acre Seed & mulch: \$900/acre Sod: \$1,400/acre	Schueler, 1987; SWRPC, 1991

Table 4-8 (continued)

Practice	Land requirement	Construction cost	Useful life	Annual O&M	Total annual cost	References
Grass Swales	Low	Established from seed: Average: \$6.5/ lin ft Reported Range: \$4.5 - \$8.5/ lin ft Established from sod: Average: \$20/ lin ft Reported Range: \$8 - \$50/ lin ft	50 ^b	Established from seed or sod- Average: \$0.75/ lin ft Reported Range: \$0.5 - \$1.0/ lin ft	Established from seed: \$1/lin ft Established from sod: \$2/lin ft	Schueler, 1987; SWRPC, 1991
Porous Pavement	None	Average: \$1.5/ ft ^{2c} Reported Range: \$1 - \$2/ ft ^{2c}	10 ^d	Average: \$0.01/ ft ^{2c} Reported Range: \$0.01/ ft ^{2c}	0.15/ ft ^{2c}	SWRPC, 1991; Schueler, 1987
Concrete Grid Pavement	None	Average: \$1/ ft ^{2c} Reported Range: \$1 - \$2/ ft ^{2c}	20	Average: (-\$0.04)/ft ^{2c} Reported Range: (-\$0.04)/ ft ^{2c}	0.05/ ft ^{2c}	Smith, 1981
Sand Filter/ Filtration Basin	High	Average: \$5/ ft ³ Probable Cost: \$2 - \$9/ft ³ Reported Range: \$1 - \$11/ft ³	25 ^d	Average: Not Available Probable Cost: 7% of construction cost Reported Range: Not Available	\$0.1 - \$0.8/ft ³	Tull, 1990
Water Quality Inlet	None	Average: \$2,000/ each Reported Range: \$1,100 - \$3,000/ each	50	Average: \$30/each ^l Reported Range: \$20-40/each ^l	\$150/ each	SWRPC, 1991
Water Quality Inlet with Sand Filters	None	Average: \$10,000/ drainage acre Reported Range: \$10,000/ drainage acre	50	Average: Not Available Probable Cost: \$100/ drainage acre Reported Range: Not Available	\$700/ drainage acre	Shaver, 1991
Oil/Grit Separator	None	Average: \$18,000/ drainage acre Reported Range: \$15,000 - \$20,000/ drainage acre	50	Average: \$20/ drainage acre ^l Reported Range: \$5 - \$40/ drainage acre ^l	\$1,000/ drainage acre	Schueler, 1987

Table 4-8 (continued)

Practice	Land requirement	Construction cost	Useful life	Annual O&M	Total annual cost	References
Extended Detention Dry Pond	High	Average \$0.5/ ft ³ storage Probable Cost: \$0.09 - \$5/ft ³ Reported Range: \$0.05 - \$3.2/ft ³	50	Average: 4% of capital cost Reported Range: 3% - 5% of capital cost	\$0.007 - \$0.3/ft ³	APWA Res. Foundation
Wet Pond and Extended Detention Wet Pond	High	Storage Volume < 1,000,000 ft ³ : Average: \$0.5/ ft ³ storage Probable Cost: \$0.5 - \$1/ft ³ Reported Range: \$0.05 - \$1.0/ft ³ Storage Volume > 1,000,000 ft ³ : Average: \$0.25/ ft ³ storage Probable Cost: \$0.1 - \$0.5/ft ³ Reported Range: \$0.05 - \$0.5/ft ³	50	Average: 3% of capital cost Probable Cost: <100,000 ft ³ = 5% of capital cost >100,000 & <1,000,000 ft ³ = 3% of capital cost >1,000,000 ft ³ = 1% of capital cost Reported Range: 0.1% - 5% of capital cost	\$0.008 - \$0.07/ft ³	APWA Res. Foundation; Wiegand, et al, 1986; Schueler, 1987; SWRPC, 1991
Stormwater Wetlands	High	Average: Not available Reported Range: Not available	50 ^b	Average: Not Available Reported Range: Not Available	Not available	

^a References indicate the useful life for infiltration basins and infiltration trenches at 25-50 and 10-15 years, respectively. Because of the high failure rate, infiltration basins are assumed to have useful life span of 25 years and infiltration trenches are assumed to have useful life span of 10 years.

^b Useful life taken as life of project, assumed to be 50 years.

^c Incremental cost, i.e., cost beyond that required for conventional asphalt pavement.

^d Since no information was available for useful life of porous pavement, it was assumed to be similar to that of infiltration trenches.

^e Since no information was available for useful life of filtration basins it was assumed to be similar to that of infiltration basins.

^f Frequency of cleaning assumed 2 times per year.

districts, counties, and other agencies. The program has been well received and from February 1991 to July 1991, over 1,100 individuals from 300 companies and organizations participated in the program (Shaver and Piorko, 1992).

■ *b. Ensure that all urban runoff facilities are operated and maintained properly.*

Once an urban runoff facility is installed, it should receive thorough maintenance in order to function properly and not pose a health or safety threat. Maintenance should occur at regular intervals, be performed by one or more individuals trained in proper inspection and maintenance of urban runoff facilities, and be performed in accordance with the adopted standards of the State or local government (Ocean County, undated). It is more effective and efficient to perform preventative maintenance on a regular basis than to undertake major remedial or corrective action on an as needed basis (Ocean County, undated).

■ *c. Infiltration Basins*

Infiltration basins are impoundments in which incoming urban runoff is temporarily stored until it gradually infiltrates into the soil surrounding the basin. Infiltration basins should drain within 72 hours to maintain aerobic conditions, which favor bacteria that aid in pollutant removal, and to ensure that the basin is ready to receive the next storm (Schueler, 1987). The runoff entering the basin is pretreated to remove coarse sediment that may clog the surface soil pore on the basin floor. Concentrated runoff should flow through a sediment trap, or a vegetated filter strip may be used for sheet flow.

■ *d. Infiltration Trenches*

Infiltration trenches are shallow excavated ditches that have been backfilled with stone to form an underground reservoir. Urban runoff diverted into the trench gradually infiltrates from the bottom of the trench into the subsoil and eventually into the ground water. Variations in the design of infiltration trenches include dry wells, pits designed to control small volumes of runoff (such as the runoff from a rooftop), and enhanced infiltration trenches, which are equipped with extensive pretreatment systems to remove sediment and oil. Depending on the quality of the runoff, pretreatment will generally be necessary to lower the failure rate of the trench. More costly than pond systems in terms of cost per unit of runoff treated, infiltration trenches are suited best for drainage areas of less than 5 to 10 acres or where ponds cannot be applied (Schueler et al., 1992).

■ *e. Vegetated Filter Strips*

Vegetated filter strips are areas of land with vegetative cover that are designed to accept runoff as overland sheet flow from upstream development. They may closely resemble many natural ecotones, such as grassy meadows or riparian forests. Dense vegetative cover facilitates sediment attenuation and pollutant removal. Vegetated filter strips do not effectively treat high-velocity flows and are therefore generally recommended for use in agriculture and low-density development and other situations where runoff does not tend to be concentrated. Unlike grassed swales, vegetated filter strips are effective only for overland sheet flow and provide little treatment for concentrated flows. Grading and level spreaders can be used to create a uniformly sloping area that distributes the runoff evenly across the filter strip (Dillaha et al., 1987). Vegetated filter strips are often used as pretreatment for other structural practices, such as infiltration basins and infiltration trenches. Refer to Chapter 7 of this guidance for additional information.

Filter strips are less effective on slopes of over 15 percent. Periodic inspection, repair, and regrading are required to prevent channelization (Schueler et al., 1992). Inspection is especially important following major storm events. Excessive use of pesticides, fertilizers, and other chemicals should be avoided. To minimize soil compaction, vehicular traffic and excessive pedestrian traffic should be avoided.

A berm of sediment that must be periodically removed may form at the upper edge of grassed filter strips. Mowing of grassed filter strips at a minimum of two to three times per year will maintain a thicker vegetative cover,

providing better sediment retention. To avoid impacts on ground-nesting birds, mowing should be limited to spring or fall (USEPA, undated). Harvesting of mowed vegetation will allow for thicker growth and promotes the retention of nutrients that are released during decomposition (Dillaha et al., 1989).

Forested areas directly adjacent to waterbodies should be left undisturbed except for the removal of trees presenting unusual hazards and the removal of small debris near the stream that may be refloated by high water. Periodic harvesting of some trees not directly adjacent to waterbodies removes sequestered nutrients (Lowrance, Leonard, and Sheridan, 1985) and maintains an efficient filter through vigorous vegetation (USEPA, undated). Exposure of forested filter strip soil to direct radiation should be avoided to keep the temperature of water entering waterbodies low, and moist conditions conducive to microbial activities in filter strip soil should be maintained (Nutter and Gaskin, 1989).

■ f. *Grassed Swales*

A grassed swale is an infiltration/filtration method that is usually used to provide pretreatment before runoff is discharged to treatment systems. Grassed swales are typically shallow, vegetated, man-made ditches designed so that the bottom elevation is above the water table to allow runoff to infiltrate into ground water. The vegetation or turf prevents erosion, filters sediment, and provides some nutrient uptake (USDA-SCS, 1988). Grassed swales can also serve as conveyance systems for urban runoff and provide similar benefits.

The swale should be mowed at least twice each year to stimulate vegetative growth, control weeds, and maintain the capacity of the system. It should never be mowed shorter than 3 to 4 inches. The established width should be maintained to ensure the continued effectiveness and capacity of the system (Bassler, undated).

■ g. *Porous Pavement and Permeable Surfaces*

Porous pavement, an alternative to conventional pavement, reduces much of the need for urban runoff drainage conveyance and treatment off-site. Instead, runoff is diverted through a porous asphalt layer into an underground stone reservoir. The stored runoff gradually exfiltrates out of the stone reservoir into the subsoil. Many States no longer promote the use of porous pavement because it tends to clog with fine sediments (Washington Department of Ecology, 1991). A vacuum-type street sweeper should be used to maintain porous pavement.

Permeable paving surfaces such as modular pavers, grassed parking areas, and permeable pavements may also be employed to reduce runoff volumes and trap vehicle-generated pollutants (Pitt, 1990; Smith, 1981); however, care should be taken when selecting such alternatives. The potential for ground-water contamination, compaction, or clogging due to sedimentation should be evaluated during the selection process. (NOTE: These practices should be selected only in cases where proper operation and maintenance can be guaranteed due to high failure rates without proper upkeep.)

■ h. *Concrete Grid Pavement*

Concrete grid pavement consists of concrete blocks with regularly interdispersed void areas that are filled with pervious materials, such as gravel, sand, or grass. The blocks are typically placed on a sand or gravel base and designed to provide a load-bearing surface that is adequate to support vehicles, while allowing infiltration of surface water into the underlying soil.

■ i. *Water Quality Inlets*

Water quality inlets are underground retention systems designed to remove settleable solids. Several designs of water quality inlets exist. In their simplest form, catch basins are single-chambered urban runoff inlets in which the bottom has been lowered to provide 2 to 4 feet of additional space between the outlet pipe and the structure bottom for collection of sediment. Some water quality inlets include a second chamber with a sand filter to provide additional

removal of finer suspended solids by filtration. The first chamber provides effective removal of coarse particles and helps prevent premature clogging of the filter media. Other water quality inlets include an oil/grit separator. Typical oil/grit separators consist of three chambers. The first chamber removes coarse material and debris; the second chamber provides separation of oil, grease, and gasoline; and the third chamber provides safety relief should blockage occur (NVPDC, 1980). While water quality inlets have the potential to perform effectively, they are not recommended. Maintenance and disposal of trapped residuals and hydrocarbons must occur regularly for these devices to work. No acceptable clean-out and disposal techniques currently exist (Schueler et al., 1992).

■ j. *Extended Detention Ponds*

Extended detention (ED) ponds temporarily detain a portion of urban runoff for up to 24 hours after a storm, using a fixed orifice to regulate outflow at a specified rate, allowing solids and associated pollutants the required time to settle out. The ED ponds are normally "dry" between storm events and do not have any permanent standing water. These basins are typically composed of two stages: an upper stage, which remains dry except for larger storms, and a lower stage, which is designed for typical storms. Enhanced ponds are equipped with plunge pools near the inlet, a micropool at the outlet, and an adjustable reverse-sloped pipe as the ED control device (orifice) (NVPDC, 1980; Schueler et al., 1992). Temporary and most permanent ED ponds use a riser with an antivortex trash rack on top to control trash.

■ k. *Wet Ponds*

Wet ponds are basins designed to maintain a permanent pool of water and temporarily store urban runoff until it is released at a controlled rate. Enhanced designs include a forebay to trap incoming sediment where it can easily be removed. A fringe wetland can also be established around the perimeter of the pond.

■ l. *Constructed Wetlands*

Constructed wetlands are engineered systems designed to simulate the water quality improvement functions of natural wetlands to treat and contain surface water runoff pollutants and decrease loadings to surface waters. Where site-specific conditions allow, constructed wetlands or sediment retention basins should be located to have a minimal impact on the surrounding areas. (The State of Washington requires that constructed wetlands be located in uplands (Washington Department of Ecology, 1992).) In addition, constructed urban runoff wetlands differ from artificial wetlands created to comply with mitigation requirements in that they do not replicate all of the ecological functions of natural wetlands. Enhanced designs may include a forebay, complex microtopography, and pondscaping with multiple species of wetland trees, shrubs, and plants. Additional information on constructed wetlands is provided in Chapter 7.

■ m. *Filtration Basins and Sand Filters*

Filtration basins are impoundments lined with filter media, such as sand or gravel. Urban runoff drains through the filter media and perforated pipes into the subsoil. Detention time is typically 4 to 6 hours. Sediment-trapping structures are typically used to prevent premature clogging of the filter media (NVPDC, 1980; Schueler et al., 1992).

Sand filters are a self-contained bed of sand to which the first flush of runoff water is diverted. The runoff percolates through the sand, where colloidal and particulate materials are strained out by the cake of solids that forms, or is placed, on the surface of the media. Water leaving the filter is collected in underground pipes and returned to the stream or channel. A layer of peat, limestone, and/or topsoil may be added to improve removal efficiency.

n. Educate the public about the importance of runoff management facilities.

"... the value of a comprehensive public information and education program cannot be overemphasized. Such a program must explain the basis, purpose, and details of the proposal and must convince the public and their elected officials that it is both necessary to implement and beneficial to their interests. It must also explain the fundamentals of storm water management facilities, the vital role they play in our lives, and their need for regular maintenance. This information can be presented through flyers, brochures, posters, and other educational aids. Work sessions and field trips can also be conducted. Signs at facility sites can also be erected. Finally, presentations to planning boards, municipal councils and committees, and county freeholders by storm water management experts can also be of great assistance" (New Jersey, undated).

5. Effectiveness and Cost Information

The box and whisker plot in Figure 4-3 summarizes efficiencies for selected structural TSS removal practices, as reported by Schueler et al., 1992. The whiskers of each box represent the range of reported TSS removal efficiencies. The box ends delimit the 25th and 75th percentiles. The horizontal line represents the median, or 50th percentile. Circles represent outliers. Figure 4-3 and Table 4-7 illustrate the range of removal efficiencies, based on monitoring and modeling studies, for total suspended solids for several of the structural practices. The reviewed literature reported a median TSS removal efficiency above 80 percent for three practices—constructed wetlands, wet ponds, and filtration basins. However, it has been reported that the other practices are capable of achieving 80 percent TSS removal efficiency when properly designed, sited, operated, and maintained. More detailed information on the removal efficiencies of the practices and factors influencing the removal efficiencies is presented in Table 4-7. Costs of the practices are shown in Table 4-8.

In many cases, a systems approach to best management practice (BMP) design and implementation may be more effective. By applying multiple practices, enhanced runoff attenuation, conveyance, pretreatment, and treatment may be attained (Schueler et al., 1992). In addition, regionalization of systems (installing and maintaining a BMP or BMPs for more than one development site) may prove more efficient and cost-effective due to the economies of scale of operating one large system versus several smaller systems.

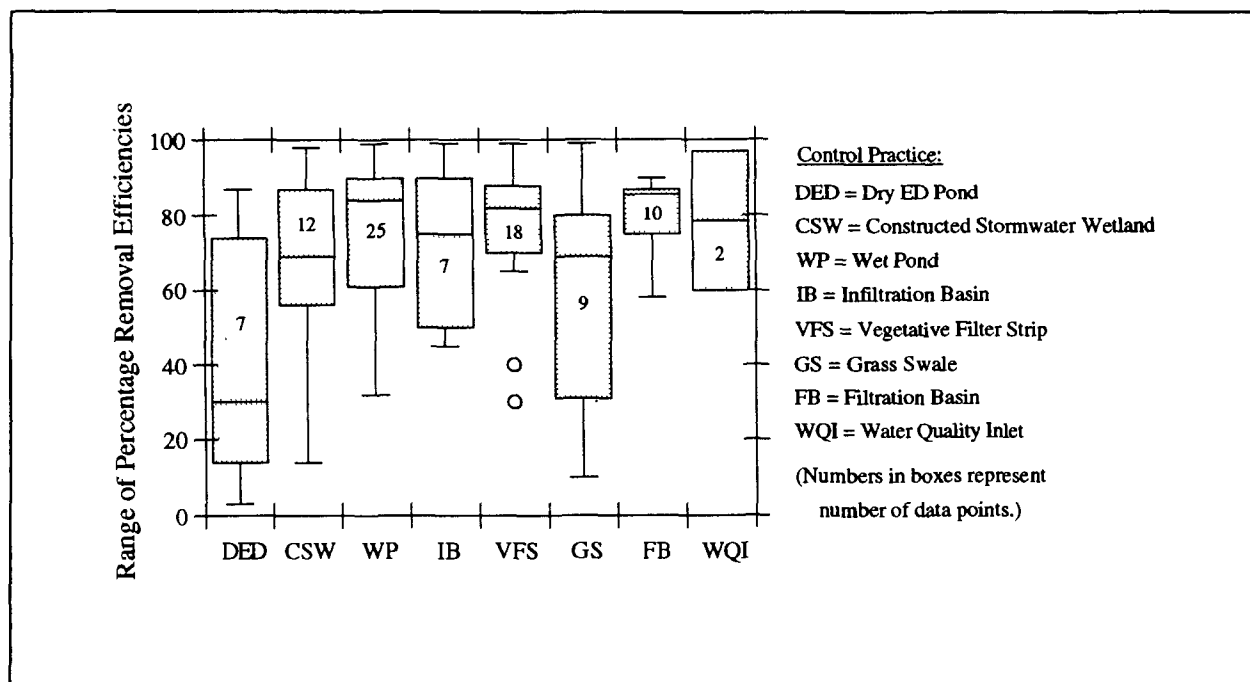

Figure 4-3. Removal efficiencies of selected urban runoff controls for TSS (adapted from Schueler et al., 1992).

B. Watershed Protection Management Measure

Develop a watershed protection program to:

- (1) Avoid conversion, to the extent practicable, of areas that are particularly susceptible to erosion and sediment loss;**
- (2) Preserve areas that provide important water quality benefits and/or are necessary to maintain riparian and aquatic biota; and**
- (3) Site development, including roads, highways, and bridges, to protect to the extent practicable the natural integrity of waterbodies and natural drainage systems.**

1. Applicability

This management measure is intended to be applied by States to new development or redevelopment including construction of new and relocated roads, highways, and bridges that generate nonpoint source pollutants. Under the Coastal Zone Act Reauthorization Amendments of 1990, States are subject to a number of requirements as they develop coastal nonpoint source programs in conformity with this management measure and will have flexibility in doing so. The application of management measures by States is described more fully in *Coastal Nonpoint Pollution Control Program: Program Development and Approval Guidance*, published by the U.S. Environmental Protection Agency (EPA) and the National Oceanic and Atmospheric Administration (NOAA) of the U.S. Department of Commerce.

2. Description

The purpose of this management measure is to reduce the generation of nonpoint source pollutants and to mitigate the impacts of urban runoff and associated pollutants that result from new development or redevelopment, including the construction of new and relocated roads, highways, and bridges. The measure is intended to provide general goals for States and local governments to use in developing comprehensive programs for guiding future development and land use activities in a manner that will prevent and mitigate the effects of nonpoint source pollution.

A watershed is a geographic region where water drains into a particular receiving waterbody. As discussed in the introduction, comprehensive planning is an effective nonstructural tool available to control nonpoint source pollution. Where possible, growth should be directed toward areas where it can be sustained with a minimal impact on the natural environment (Meeks, 1990). Poorly planned growth and development have the potential to degrade and destroy entire natural drainage systems and surface waters (Mantel et al., 1990). Defined land use designations and zoning direct development away from areas where land disturbance activities or pollutant loadings from subsequent development would severely impact surface waters. Defined land use designations and zoning also protect environmentally sensitive areas such as riparian areas, wetlands, and vegetative buffers that serve as filters and trap sediments, nutrients, and chemical pollutants. Refer to Chapter 7 for a thorough description of the benefits of wetlands and vegetative buffers.

Areas such as streamside buffers and wetlands may also have the added benefit of providing long-term pollutant removal capabilities without the comparatively high costs usually associated with structural controls. Conservation or preservation of these areas is important to water quality protection. Land acquisition programs help to preserve areas critical to maintaining surface water quality. Buffer strips along streambanks provide protection for stream ecosystems and help to stabilize the stream and prevent streambank erosion (Holler, 1989). Buffer strips protect and maintain near-stream vegetation that attenuates the release of sediment into stream channels and prevent excessive loadings. Levels of suspended solids increase at a slower rate in stream channel sections with well-developed riparian vegetation (Holler, 1989).

The availability of infrastructure specifically sewage treatment facilities, is also a factor in watershed planning. If centralized sewage treatment is not available, onsite disposal systems (OSDS) most likely will be used for sewage treatment. Because of potential ground-water and surface water contamination from OSDS, density restrictions may be needed in areas where OSDS will be used for sewage treatment. Section VI of this chapter contains a more detailed discussion of siting densities for OSDS.

3. Management Measure Selection and Effectiveness Information

This measure was selected for the following reasons:

- (1) Watershed protection is a technique to provide long-term water quality benefits, and many States and local communities already use this practice. Numerous State and local governments have already legislated and implemented detailed watershed planning controls that are consistent with this management measure. For example, Oregon, New Jersey, Delaware, and Florida have passed legislation that requires county and municipal governments to adopt comprehensive plans, including requirements to direct future development away from sensitive areas. Several municipalities and regions, in addition to those in these States, have adopted land use and growth controls, including Amherst, Massachusetts, the Cape Cod region, Norwood, Massachusetts, and Narragansett, Rhode Island.
- (2) Setting general water quality objectives oriented toward protection of environmentally sensitive areas and areas that provide water quality benefits allows States flexibility in the pursuit of widely differing water quality priorities and reduces potential conflicts that may arise due to existing State or local program goals and requirements. Although public comments on the May 1991 draft guidance suggested that much more specific criteria should be required, such as minimum setbacks from waterbodies, prohibitions on development on slopes in excess of 45 degrees, and bans on development in floodplains, such prescriptive measures are deemed unreasonable given the need for State and local determination of priorities and program direction.
- (3) This measure is effective in producing long-term water quality benefits and lacks the high operation and maintenance costs associated with structural controls.

By protecting those areas necessary for maintaining surface water quality in a natural or near natural state, adverse impacts can be reduced. To illustrate the effectiveness of this management measure, two case studies are presented.

CASE STUDY 1 - RHODE RIVER ESTUARY, CHESAPEAKE BAY, MARYLAND

An evaluation of the impact of the Maryland Critical Area Act on nonpoint source pollution (nutrients and sediment) in surface runoff was completed by modeling three land use scenarios and determining the relative change in nonpoint loadings from the Rhode River Critical Area. Research findings suggest that the implementation of the Act will reduce nonpoint source nutrient and sediment loading by mandating agricultural and urban best management practices (BMPs) and limiting development in forested lands. Figure 4-4 illustrates the predicted nitrogen and phosphorus loadings from various land uses within the watershed under various development scenarios. These predictions are based on the assumption that no structural BMPs are in place.

New development allowed by the Critical Area Act is required to minimize impervious surfaces and reduce nonpoint source pollution through urban BMPs. Results from this study indicate that by limiting the impervious portion of a building site to 15 percent in the Rhode River Estuary, nutrient loadings could be reduced by one-third when compared to similar development without this practice (Houlihan, 1990).

CASE STUDY 2 - ALAMEDA COUNTY, CALIFORNIA

Pollutant loading estimates can be used to evaluate the effectiveness of land planning on controlling nonpoint source pollution. For example, Alameda County, California, has estimated seven pollutant loadings for seven parameters by type of land use, as shown in Table 4-9. By leaving larger areas in open space—through easements, buffers, clustering, or preserves—the potential pollutant loading to San Francisco Bay can be reduced. For example, it is estimated that if 50 percent of a 100-acre parcel designated for residential development is preserved in open space, pollutant loadings for zinc and total suspended solids can be reduced by 50.24 percent and 49.76 percent, respectively, when compared to residential development of the entire 100-acre parcel.

**Table 4-9. Load Estimates for Six Land Uses in Alameda County, California
(based on average wet weather load, lb/acre; adapted from Woodward-Clyde, 1991)**

Land Use	Cadmium	Chromium	Copper	Lead	Nickel	Zinc	Total Suspended Solids
Open	N/A	N/A	N/A	N/A	N/A	0.002	0.75
Residential	0.002	0.026	0.058	0.134	0.037	0.424	52.16
Commercial	0.002	0.038	0.084	0.094	0.053	0.655	511.76
Transportation	0.003	0.050	0.112	0.259	0.071	0.274	683.23
Industrial	0.003	0.044	0.097	0.171	0.028		251.43
Industrial Park	0.002	0.026	0.057	0.101	0.017	0.479	148.88

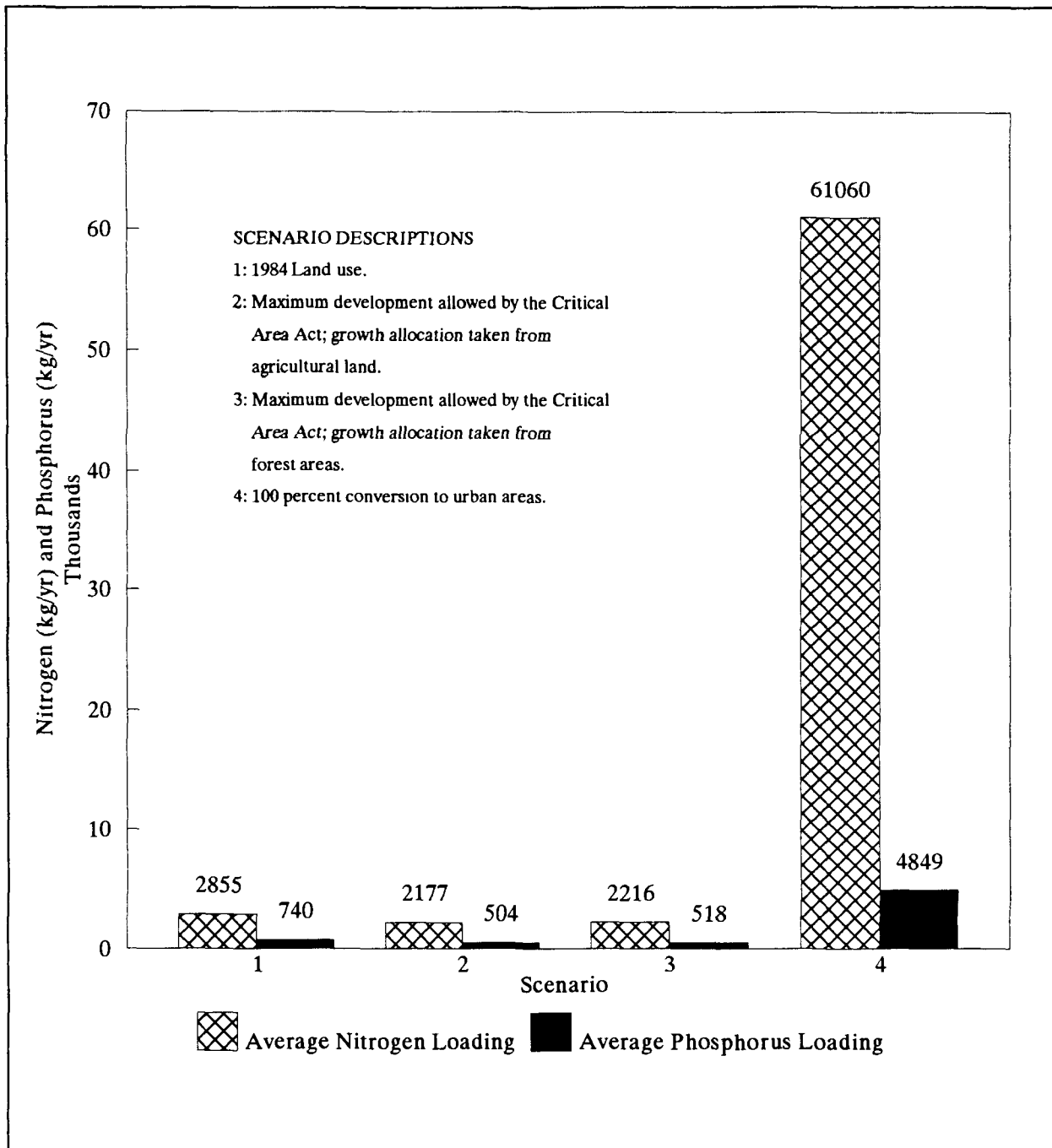

Figure 4-4. Predicted total nitrogen and phosphorus loadings in surface water after runoff from the Rhode River Critical Area under different land use scenarios (Houlihan, 1990).

Considerable uncertainty is associated with the ability to quantify load reductions from various nonstructural practices for controlling nonpoint source pollution (USEPA, 1990). Table 4-10 illustrates the general effectiveness of various planning and site design practices. Many are described in the practices section of this management measure and the Site Development Management Measure.

Table 4-10. General Effectiveness of Various Nonstructural Control Practices (Metropolitan Washington Council of Governments, 1991)

	Nutrient Control	Shellfish	Estuarine Habitat Protection	Sedimentation	Sediment Toxics	Stormwater Control	Feasibility in Coastal Areas	Maintenance Burdens	Longevity	Community Acceptance	Secondary Environmental Impacts	Cost to Developers	Cost to Local Governments	Difficulty in Local Implementation	Site Data Required	Water Dependent Use
I. COASTAL DENSITY ZONES																
Intense Zones	○	○	○	○	○	○	●	■	■	○	○	○	●	○	●	
Rural Zones	○	●	●	●	●	●	●	■	■	○	●	●	●	○	●	
Protection Zones	●	●	●	●	●	●	●	■	■	○	●	●	●	●	●	
Overlay Zones	●	●	●	●	●	●	●	■	■	○	●	●	●	●	○	
Performance Zoning	●	●	●	●	●	●	●	■	■	○	●	●	●	●	○	
II. ENVIRONMENTAL RESERVES																
Stream Buffers	●	●	●	●	○	○	●	●	●	●	●	●	●	●	●	○
Wetland Buffers	●	○	●	●	○	○	●	●	●	●	●	○	●	●	●	●
Coastal Buffers	●	●	●	●	○	○	●	●	●	●	●	○	●	○	●	●
Expanded Buffers	●	●	●	●	○	○	●	●	●	●	●	●	●	○	○	●
Floodplain Limits	●	○	●	○	○	●	●	●	●	●	●	●	●	●	●	○
Steep Soils Limits	○	○	●	●	○	●	●	●	●	●	●	●	●	●	●	●
Septic Limits	●	●	○	○	○	■	●	●	●	●	●	○	●	○	●	●
Wetland Protection	●	●	●	●	○	●	●	●	●	●	●	●	●	●	○	●
Forest Protection	○	●	●	●	○	○	●	●	●	●	●	○	●	●	●	●
Habitat Protection	○	○	●	○	○	○	●	●	●	●	●	○	●	○	●	●
Open Space Protection	○	○	●	○	○	○	●	●	●	●	●	○	●	●	●	●
	○ ● High Level of Control ○ ● Moderate Level of Control ○ ● Low Level of Control ■ Ineffective	○ ● Highly Effective ○ ● Moderately Effective ○ ● Low Effectiveness ■ Ineffective	○ ● Directly Protects ○ ● Indirectly Protects ○ ● No Protection ○ ● Not Realized	○ ● 80% + High ○ ● 50 - 80% Mod ○ ● 0 - 50% Low ■ Ineffective	○ ● Highly Effective ○ ● Moderately Effective ○ ● Low Effectiveness ■ Ineffective	○ ● Highly Effective ○ ● Moderately Effective ○ ● Low Effectiveness ■ Ineffective	○ ● Widely Applicable ○ ● Applicable Depending on Site ○ ● Somewhat Applicable ○ ● Not Applicable	○ ● Low Burden ○ ● Moderate Burden ○ ● High Burden ○ ● Not Applicable	○ ● Long Life ○ ● Long Life with Maintenance ○ ● Short-lived ○ ● Not Applicable	○ ● Positive ○ ● Neutral ○ ● Negative ○ ● Mixed	○ ● None or Positive ○ ● Slight Negative Impacts ○ ● Strong Negative Impacts at Some Sites ○ ● Prohibited	○ ● Low ○ ● Moderate ○ ● High ○ ● Very High	○ ● Low ○ ● Moderate ○ ● High ○ ● Very High	○ ● Easy ○ ● Moderate ○ ● Tough ○ ● Very Tough	○ ● Simple ○ ● Moderate ○ ● Complex ○ ● None	○ ● Can be Used Moderately in These Areas ○ ● Sometimes Can Be Used ○ ● Seldom Used ○ ● Not Used

	Household Hazardous Waste	Septic Maintenance	Fertilizer Control	Urban Housekeeping	V. POST DEVELOPMENT	Time/Area Disturbance	EROSION & SEDIMENT CONTROL	Minimize Imperviousness	Performance Criteria	Cluster	III. SITE PLANNING	
<ul style="list-style-type: none"> ● 0 - 40% High Level of Control ○ 30 - 40% Moderate Level of Control ○ 0 - 20% Low Level of Control ■ Ineffective 	○	●	●	○		●		○	●	○		Nutrient Control
<ul style="list-style-type: none"> ● Highly Effective ○ Moderately Effective ○ Low Effectiveness ■ Ineffective 	■	●	○	●		○	○		●	●		Shellfish
<ul style="list-style-type: none"> ● Directly Protects ○ Indirectly Protects ○ No Protection ■ Not Related 	○	○	■	○		●		○	●	○		Estuarine Habitat Protection
<ul style="list-style-type: none"> ● 60% + High ○ 30 - 60% Mod ○ 0 - 30% Low ■ Ineffective 	■	■	■	●		●		○	●	○		Sedimentation
<ul style="list-style-type: none"> ● Highly Effective ○ Moderately Effective ○ Low Effectiveness ■ Ineffective 	●	■	■	●		■		○	●	○		Sediment Toxics
<ul style="list-style-type: none"> ● Highly Effective ○ Moderately Effective ○ Low Effectiveness ■ Ineffective 	■	■	■	■		○		●	●	○		Stormwater Control
<ul style="list-style-type: none"> ● Widely Applicable ○ Applicable Depending on Site ○ Seldom Applicable ■ Not Applicable 	●	●	●	●		●		●	●	●		Feasibility in Coastal Areas
<ul style="list-style-type: none"> ● Low Burden ○ Moderate Burden ○ High Burden ■ Not Applicable 	○	○	○	●		●		○	●	●		Maintenance Burdens
<ul style="list-style-type: none"> ● Long Lived ○ Long Lived w/Maintenance ○ Shortlived ■ Not Applicable 	○	●	○	○		●		○	●	●		Longevity
<ul style="list-style-type: none"> ● Positive ○ Neutral ○ Negative ■ Mixed 	●	●	●	●		●		○	●	○		Community Acceptance
<ul style="list-style-type: none"> ● None or Positive ○ Slight Negative Impacts ○ Strong Negative Impacts at Some Sites ■ Prohibited 	●	●	●	●		●		○	●	●		Secondary Environmental Impacts
<ul style="list-style-type: none"> ● Low ○ Moderate ○ High ■ Very High 						●		○	●	○		Cost to Developers
<ul style="list-style-type: none"> ● Low ○ Moderate ○ High ■ Very High 	●	●	●	●		●		○	●	○		Cost to Local Governments
<ul style="list-style-type: none"> ● Easy ○ Moderate ○ Tough ■ Very Tough 	●	●	●	●		●		○	○	○		Difficulty in Local Implementation
<ul style="list-style-type: none"> ● Simple ○ Moderate ○ Complex ■ None 	○	○	●	●		○		○	○	●		Site Data Required
<ul style="list-style-type: none"> ● Can be Used Moderately in These Areas ○ Sometimes Can Be Used ○ Seldom Used ■ Not Used 	●	●	●	●		●		●	●	●		Water Dependent Use

Table 4-10 (continued)

4. Watershed Protection Practices and Cost Information

As discussed more fully at the beginning of this chapter and in Chapter 1, the following practices are described for illustrative purposes only. State programs need not require implementation of these practices. However, as a practical matter, EPA anticipates that the management measure set forth above generally will be implemented by applying one or more management practices appropriate to the source, location, and climate. The practices set forth below have been found by EPA to be representative of the types of practices that can be applied successfully to achieve the management measure described above.

The most effective way to achieve this management measure is to develop a comprehensive program that incorporates protection of surface waters with programs and plans for guiding growth and development. Planning is an orderly process, and each step builds upon preceding steps. The following practices are part of the process and can be modified to meet the needs of the community. Many of the practices can be incorporated into existing activities being carried out by a local government, such as land planning, zoning, and site plan review. Other activities, such as land acquisition programs, may have to be developed. Where cost and effectiveness information was available, it was included in the discussion of the examples. The general cost and effectiveness of planning programs are described after the practices.

■ a. *Resource Inventory and Information Analysis*

Before a comprehensive program can be developed, define the watershed boundaries, target areas, and pollutants of concern, and conduct resource inventory and information analysis. These activities can be done by using best available information or collecting primary data, depending on funding availability and the quality of available data. Activities pursued under this process include: assessment of ground-water and surface water hydrology; evaluation of soil type and ground cover; identification of areas with water quality impairments; and identification of environmentally sensitive areas, such as steep or erodible uplands, wetlands, riparian areas, floodplains, aquifer recharge areas, drainage ways, and unique geologic formations. Once environmentally sensitive areas are identified, areas that are integral to the protection of surface waters and the prevention of nonpoint source pollution can be protected.

The following are examples of resource inventory and information analysis programs:

LOCATION	PROGRAM	COST
City of Virginia Beach, Virginia	Three-phase natural areas inventory to help planners and public officials develop practices for resource protection	Phase I (data collection) \$13,867; Phase II (field inventory) \$54,624; and Phase III (final report) \$15,225 (Jenkins, 1991).
Richmond County, Virginia	The Richmond County Resource Information System (RIS) was developed to provide a basis for responsible planning and development of shoreline areas. The compilation and mapping of resource information are part of the county's planning and zoning program.	In 1990, the program was supported by a \$39,000 Federal Coastal Zone Management Grant, \$45,000 from the Chesapeake Bay Foundation through a Virginia Environmental Endowment Grant, and \$96,000 from the county's comprehensive plan budget (Jenkins, 1991).

■ b. *Development of Watershed Management Plan*

The resource inventory and information analysis component provides the basis for a watershed management plan. A watershed management plan is a comprehensive approach to addressing the needs of a watershed, including land use, urban runoff control practices, pollutant reduction strategies, and pollution prevention techniques.

For a watershed management plan to be effective, it should have measurable goals describing desired outcomes and methods for achieving the goals. Goals, such as reducing pollutant loads to surface water by 25 percent, can be articulated in a watershed management plan. Development and implementation of urban runoff practices, both structural and nonstructural, can be incorporated as methods for achieving the goal. Table 4-11 describes the general steps for developing a watershed management plan.

**Table 4-11. Watershed Management: A Step-by-Step Guide
(Livingston and McCarron, 1992)**

<p>1. Delineate and map watershed boundary and sub-basins within the watershed.</p>	<p>10. Analysis. Determine infrastructure and natural resources management needs within each watershed.</p>
<p>2. Inventory and map natural storm water conveyance and storage systems.</p>	<p>11. Set resource management goals and objectives.</p>
<p>3. Inventory and map man-made storm water conveyance and storage system. This includes all ditches, swales, storm sewers, detention ponds, and retention areas and includes information such as size, storage capacity, and age.</p>	<p>Before corrective actions can be taken, a resource management target must be set. The target can be defined in terms of water quality standards; attainment and preservation of beneficial uses; or other local resource management objectives.</p>
<p>4. Inventory and map land use by sub-basin.</p>	<p>12. Determine pollutant reduction (for existing and future land uses) needed to achieve water quality goals.</p>
<p>5. Inventory and map detailed soils by sub-basin.</p>	<p>13. Select appropriate management practices (point source, nonpoint source) that can be used to achieve the goal.</p>
<p>6. Establish a clear understanding of water resources in the watershed. Analyze water quality, sediment, and biological data. Analyze subjective information on problems (such as citizen complaints). Evaluate waterbody use impairment—frequency, timing, seasonality of problem. Conduct water quantity assessment—low flows, seasonality.</p>	<p>Evaluate pollutant removal effectiveness, land owner acceptance, financial incentives and costs, availability of land operation and maintenance needs, feasibility, and availability of technical assistance.</p>
<p>7. Inventory pollution sources in the watershed. Point sources—location, pollutants, loadings, flow, capacity, etc. Nonpoint sources—type, location, pollutants, loading, etc. - land use/loading rate analysis for storm water; - sanitary survey for septic tanks; - dry flow monitoring to locate illicit discharges</p>	<p>14. Develop watershed management Plan. Since the problems in each watershed will be unique, each watershed management plan will be specific. However, all watershed plans will include elements such as: - existing and future land use plan; - master storm water management plan that addresses existing and future needs; - wastewater management plan including septic tank maintenance programs; - infrastructure and capital improvements plan</p>
<p>8. Identify and map future land use by sub-basin. Conduct land use loading rate analyses to assess potential effects of various land use scenarios.</p>	
<p>9. Identify planned infrastructure improvements—5-year, 20-year. Stormwater management deficiencies should be coordinated and scheduled with other infrastructure or development projects.</p>	

Development of a watershed management plan may involve establishing general land use designations that define allowable activities on a parcel of land. For example, land designated for low-density residential use would be limited to a density of two houses per acre, provided that all other regulations and requirements are met. All development activities allowed in a use category should be defined. By guiding uses within the planning areas, impacts to surface waters from urban runoff can be controlled. Those areas identified in the resource inventory and information analysis phase as environmentally sensitive and important to maintaining water quality can be preserved through various measures supported by State or local goals, objectives, and policies.

The following are examples of plan development:

LOCATION	PROGRAM	COST
Florida	<ul style="list-style-type: none"> • Local governments (counties and incorporated municipalities) were required to develop comprehensive plans based on existing information to guide growth and development in the short term (5 years) and long term (20 to 25 years). • Local plans must be consistent with the State plan and the State Growth Management law. • Each plan must identify environmentally sensitive areas and areas with water quality problems. 	<p>Cost information specific to those parts of the plans relating to NPS pollution was not available.</p>
Fairfax County, Virginia	<ul style="list-style-type: none"> • The Environmental Quality Corridor (EQC) System was established to preserve floodplains, wetlands, shoreline areas, and steep valley slopes. • EQCs are defined in the county's comprehensive plan and identified on the county land use map. • If a parcel of land subject to a zoning or land use designation change contains an EQC, it is set aside by the developer as part of development approval. Since its initiation, tens of thousands of acres have been set aside through the EQC program. 	<p>The cost of implementing the program is part of the operating budget of the County Planning Department (Fairfax County Planning Department, personal communication, 1991).</p>
Howard County, Maryland	<ul style="list-style-type: none"> • A Land Preservation and Recreation Plan was developed as part of the county comprehensive plan. • Open space resources are purchased for preservation and recreation. 	<p>The annual cost to update the plan, \$25,000, is funded by the State. In FY 1990, the county received \$1.14 million in State funds to update the plan and to acquire land (Jenkins, 1991).</p>

c. Plan Implementation

Once critical areas have been identified, land use designations have been defined, and goals have been established to guide activities in the watershed, implementation strategies can be developed. At this point, the requirements of future development are defined. These requirements include, but are not limited to, permitted uses, construction techniques, and protective maintenance measures. Land development regulations may also prescribe natural performance standards; for example, "rates of runoff or soil loss should be no greater than predevelopment

conditions" (USEPA, 1977). Listed below are examples of the types of development regulations and other implementation tools that have been successful at controlling nonpoint source pollution.

- *Development of ordinances or regulations requiring NPS pollution controls for new development and redevelopment.*

These ordinances or regulations should address, at a minimum:

- (1) Control of off-site urban runoff discharges (to control potential impacts of flooding);
 - (2) The use of source control BMPs and treatment BMPs;
 - (3) The performance expectations of BMPs, specifying design storm size, frequency, and minimum removal effectiveness, as specified by the State or local government;
 - (4) The protection of stream channels, natural drainage ways, and wetlands;
 - (5) Erosion and sediment control requirements for new construction and redevelopment; and
 - (6) Treatment BMP operation and maintenance requirements and designation of responsible parties.
- *Infrastructure planning*

Infrastructure planning is the multiyear scheduling and implementation of public physical improvements (infrastructure), such as roads, sewers, potable water delivery, landfills, public transportation, and urban runoff management facilities. Infrastructure planning can be an effective practice to help guide development patterns away from areas that provide water quality benefits, are susceptible to erosion, or are sensitive to disturbance or pollutant loadings. Where possible, long-term comprehensive plans to prevent the conversion of these areas to more intensive land uses should be drafted and adopted. Infrastructure should be planned for and sited in areas that have the capacity to sustain environmentally sound development. Development tends to occur in response to infrastructure availability, both existing and planned. New development should be targeted for areas that have adequate infrastructure to support growth in order to promote infill development, prevent urban sprawl, and discourage the use of septic tanks where they are inappropriate (International City Management Association, 1979). Infill development may have the added advantage of municipal cost savings.

To discourage development in the environmentally sensitive East Everglades area, Dade County, Florida, has developed an urban services boundary (USB). In areas outside the USB, the county will not provide infrastructure and has kept land use densities very low. This strategy was selected to prevent urban sprawl, protect the Everglades wetlands (outside of Everglades National Park), and minimize the costs of providing services countywide. The area is defined in the county comprehensive plan, and restrictions have been implemented through the land development regulations (Metro-Dade Comprehensive Development Master Plan, 1988).

Congress has enacted similar legislation for the protection of coastal barrier islands. In 1981, the availability of Federal flood insurance for new construction on barrier islands was discontinued. In 1982, Congress passed the Coastal Barriers Resources Act, establishing the Coastal Barrier Resource System (CBRS), and terminated a variety of Federal assistance programs for designated coastal barriers, including grants for new water, sewage, and transportation systems. In 1988, similar legislation was passed for the Great Lakes area, adding 112 Great Lakes barrier islands. Additions to the CBRS in 1990 included parts of the Florida Keys, the U.S. Virgin Islands, Puerto Rico, and the Great Lakes (Simmons, 1991).

The result of the legislation and subsequent additions to the CBRS has been the establishment of 1,394,059 acres of barriers that are ineligible for Federal assistance for infrastructure and flood insurance (Simmons, 1991). This Act has helped to guide development away from these sensitive coastal areas to more suitable locations.

- *Local ordinances*

Zoning is the division of a municipality or county into districts for the purpose of regulating land use. Usually defined on a map, the allowable uses within each zone are described in an official document, such as a zoning ordinance. Zoning is enacted for a variety of reasons, including preservation of environmentally sensitive areas and areas necessary to maintain the environmental integrity of an area (International City Management Association, 1979).

Within zoning ordinances, subdivision regulations govern the process by which individual lots of land are created out of larger tracts. Subdivision regulations are intended to ensure that subdivisions are appropriately related to their surroundings. General site design standards, such as preservation of environmentally sensitive areas, are one example of subdivision regulations (International City Management Association, 1979).

Farmland preservation ordinances are another measure that can be implemented to provide open space retention, habitat protection, and watershed protection. Farmland protection may be a less costly means of controlling pollutant loadings than the implementation of urban runoff structural control practices. Much of the farmland currently being converted has soils that are stable and not highly erodible. Conversion of these farmlands often displaces farming activities to less productive, more erodible areas that may require increased nutrient and pesticide applications.

- *Limits on impervious surfaces, encouragement of open space, and promotion of cluster development*

As described earlier, urban runoff contains high concentrations of pollutants washed off impervious surfaces (roadways, parking lots, loading docks, etc.). By retaining the greatest area of pervious surface and maximizing open space, nonpoint source pollution due to runoff from impervious surfaces can be kept to a minimum.

The following are examples of open space requirements and cluster development:

LOCATION	PROGRAM	COST
Brunswick, Maine	<ul style="list-style-type: none"> • Recently adopted an allowable impervious area threshold of 5 percent of the site to be developed in the defined Coastal Protection Zone. • The remaining 95 percent must be left natural or landscaped. 	Accomplished with a \$28,000 grant (Brunswick Planning Department, personal communication, 1991).
Commonwealth of Virginia	<ul style="list-style-type: none"> • Provides general guidance with regard to minimum open space/maximum impervious areas to local governments within the Chesapeake Bay watershed. • While specific requirements are not associated with the guidance, local government plans must contain criteria and must be approved by the Chesapeake Bay Local Assistance Board. 	Cost information specific to those parts of the guidance relating to NPS pollution was not available.

LOCATION	PROGRAM	COST
Carroll County, Maryland	<ul style="list-style-type: none"> Amended its zoning ordinance to encourage cluster development and preserve open space. This requirement has been applied to three subdivisions in the county and has resulted in the protection of more than 200 acres of wetlands (Carroll County Planning Department, personal communication, 1991). 	Developed using existing county staff and funding.
State of Maryland	<ul style="list-style-type: none"> Adopted the Forest Conservation Act of 1991. Requires all public agency and private landowner submitting a subdivision plan or application for a sediment control permit for an area greater than 40,000 square feet to develop a forest conservation plan for retention of existing forest cover on the site. Clearing essential to site development is allowed. The Act also established a forest conservation fund for reforestation projects. 	Not available.
Broward County, Florida	<ul style="list-style-type: none"> Implements an open space program and encourages cluster development to reduce the amount of impervious surface, to protect water quality, and to enhance aquifer recharge (Broward County, Florida, Land Development Code, 1990). 	Developed using existing county staff and funding.
New Hampshire	<ul style="list-style-type: none"> Model shoreland protection ordinance. Encourages grouping of residential units provided a minimum of 50 percent of the total parcel remains as open space. 	Not available.

One way to increase open space while allowing reasonable development of land is to encourage cluster development. Clustering entails decreasing the allowable lot size while maintaining the number of allowable units on a site. Such policies provide planners the flexibility to site buildings on more suitable areas of the property and leave environmentally sensitive areas undeveloped. Criteria can be varied.

- Setback (buffer zone) standards*

In coastal areas, setbacks or buffer zones adjacent to surface waterbodies, such as rivers, estuaries, or wetlands, provide a transition between upland development and waterbodies. The use of setbacks or buffer zones may prevent direct flow of urban runoff from impervious areas into adjoining surface waters and provide pollutant removal, sediment attenuation, and infiltration. Riparian forest buffers function as filters to remove sediment and attached pollutants, as transformers that alter the chemical composition of compounds, as sinks that store nutrients for an extended period of time, and as a source of energy for aquatic life (USEPA, 1992). Setbacks or buffer zones are commonly used to protect coastal vegetation and wildlife corridors, reduce exposure to flood hazards, and protect surface waters by reducing and cleansing urban runoff (Mantell et al., 1990). The types of development allowed in these areas are usually limited to nonhabitable structures and those necessary to allow reasonable use of the property (docks, nonenclosed gazebos, etc.).

Factors for delineating setbacks and buffer zones vary with location and environment and include seasonal water levels, the nature and extent of wetlands and floodplains, the steepness of adjacent topography, the type of riparian vegetation, and wildlife values.

EPA recommends that no habitat-disturbing activities should occur within tidal or nontidal wetlands. In addition, a buffer area should be established that is adequate to protect the identified wetland values. Minimum widths for buffers should be 50 feet for low-order headwater streams with expansion to as much as 200 feet or more for larger streams. In coastal areas, a 100-foot minimum buffer of natural vegetation landward from the mean high tide line helps to remove or reduce sediment, nutrients, and toxic substances entering surface waters (MWCOG, 1991).

Examples of setback or buffer requirements include the following:

LOCATION	PROGRAM	COST
Monroe County, Florida	<ul style="list-style-type: none"> Requires a setback of 20 feet from high water on man-made or lawfully altered shorelines for all enclosed structures and 50 feet from the landward extent of mangroves or mean high tide line for natural waterbodies with unaltered shorelines (Monroe County, Florida, Code, Section 9.5-286). 	Developed using existing county staff and funding.
Town of Brunswick, Maine	<ul style="list-style-type: none"> Requires a buffer of 125 to 300 feet from mean high water within the Coastal Protection Zone (Section 315 of the Brunswick Zoning Ordinance), depending on the slope of the buffer, as designated on the land use map. 	Developed using a \$28,000 grant (Brunswick Planning Department, personal communication, 1991).
Queen Annes County, Maryland	<ul style="list-style-type: none"> Established a standard shore buffer of 300 feet from the edge of tidal water or wetland, 50 percent of which must be forested. 	Developed using existing county staff and funding; a bond of surety to cover the cost of implementation is required prior to development (Jenkins, 1991).
Maryland Critical Areas Regulations	<ul style="list-style-type: none"> Requires a 25-foot buffer around nontidal wetlands and 100 feet landward of mean high water in tidal areas. Allowable uses within the setback area are defined in the regulations (Chesapeake Bay Critical Areas Commission, 1988). 	Developed as part of the Chesapeake Bay Critical Areas program.
City of Alexandria, Virginia	<ul style="list-style-type: none"> Buffers are required as part of the city's Chesapeake Bay Preservation Ordinance. Applies to all designated Resource Protection Areas (RPAs). The buffer must achieve 75 percent reduction of sediments and 40 percent reduction of nutrients (100-foot-wide buffer is considered adequate to achieve this standard; smaller widths may be allowed if they are proven to meet the sediment and nutrient removal requirements). Indigenous vegetation removal is limited to that necessary to provide reasonable sight lines, access paths, general woodlot management, and BMP implementation. 	Not available.

LOCATION	PROGRAM	COST
Northeastern Illinois Planning Commission	<ul style="list-style-type: none"> • Model ordinance • Suggests 75-foot setback from the ordinary high watermark of streams, lakes, ponds, and edge of wetlands or the boundary of the 100-year floodplain (as defined by FEMA), whichever is greater. • Suggests a minimum 25-foot-wide natural vegetation strip from the ordinary highwater mark of perennial and intermittent streams, lakes, ponds, and the edge of wetlands. 	Not available

- *Slope restrictions*

Slope restrictions can be effective tools to control erosion and sediment transport. Erosion rates depend on several site-specific factors including soil type, vegetative cover, and rainfall intensity. In general, as slope increases, there is a corresponding increase in runoff water velocity, which may result in increased erosion and sediment transport to surface waters (Schwab et al., 1981; Dunn and Leopold, 1978). The Maryland Chesapeake Bay Critical Areas Program prohibits clearing on slopes greater than 25 percent (Chesapeake Bay Critical Areas Commission, 1988).

- *Site plan reviews and approval*

A site plan review involves review of specific development proposals for consistency with the laws and regulations of the local government of jurisdiction. To ensure that natural resources necessary for protecting surface water quality are preserved, inspection of a potential development site should occur. Inspection ensures that the information presented in any application for development approval is accurate and that sensitive areas are noted for preservation. Inspections should also be conducted during and after development to ensure compliance with development conditions. Depending on the size of the local government and the amount of new development occurring, this inspection could be incorporated into the duties of existing staff at minimal additional cost to the local government or could require the addition of staff to conduct onsite inspections and monitoring. The effectiveness of such a program depends on the ability of the inspectors to evaluate property for its natural resource value and the practices used to protect areas necessary for the preservation of water quality.

Development approvals should contain conditions requiring steps to be taken to maintain the environmental integrity of the area and prevent degradation due to nonpoint source pollution, consistent with the goals, objectives, and policies of the comprehensive program and the requirements of the land development regulations. The criteria for new development are outlined as part of a development permit. Examples include the following:

- Areas for preservation or mitigation may be identified, similar to the Fairfax County Environmental Quality Corridor System (page 44).
- The use of nonstructural and structural best management practices described in this chapter for controlling nonpoint source pollution may be a condition of development approval.
- Setbacks and limits on impervious areas may be clearly defined in a condition for development approval, as is being done in the programs discussed earlier such as Monroe County, Florida, Queen Annes County, Maryland, State of Maryland Critical Areas Program, Town of Brunswick, Maine, and the Northeastern Illinois Planning Commission (pages 48 and 49).

- Reduce the use of pesticides and fertilizers on landscaped areas by encouraging the use of vegetation that is adaptable to the environment and requires minimal maintenance. (Xeriscaping is described later in this chapter.)
- *Designation of an entity or individual who is responsible for maintaining the infrastructure, including the urban runoff management systems*

The responsible party should be trained in the maintenance and management of urban runoff management systems. If desired, the local government could be designated to maintain urban runoff systems, with financial compensation from the developer. Because they are not usually trained in infrastructure maintenance, homeowners groups are not the best entity for monitoring infrastructure for adequacy, especially urban runoff management systems. This responsibility should belong to a responsible party who understands the complexity of urban runoff management systems, can determine when such systems are not functioning properly, and has the resources to correct the problem. Again, this is a duty that the local government can assume, with either existing staff or additional staff, depending on the size of the local government and the amount of new development occurring. The amount of funding needed depends on the size of the local government.

- *Official mapping*

Official maps can be used to designate and/or protect environmentally sensitive areas, zoning districts, identified land uses, or other areas that provide water quality benefits. When approved by the local governing body, these maps can be used as legal instruments to make land use decisions related to nonpoint source pollution.

- *Environmental impact assessment statements*

To evaluate the impact that proposed development may have on the natural resources of an area, some counties and municipalities require an environmental assessment as part of the development approval processes. These assessments can be incorporated into the land development regulation process. Areas to be covered include geology, slopes, vegetation, historical features, wildlife, and infrastructure needs (International City Management Association, 1979).

■ d. *Cost of Planning Programs*

Cost information was provided for several of the practices discussed in this section. The cost of planning programs depends on a variety of factors, including the level of effort needed to complete and implement a program. As discussed earlier, many of the practices described in this section can be incorporated into ongoing activities of a State or local government.

The Florida legislature funded the development of comprehensive programs and land development regulations required by the Local Government Comprehensive Planning and Land Development Regulation Act (1985). Distribution of funds was based on population according to formulas used for determining funding for the plan and land development regulations. A base amount was given to all counties that requested it. The balance of the monies was allocated to each county in an amount proportionate to its share of the total unincorporated population of all the counties. A similar distribution process was used for local governments. A total of \$2.1 million was allocated for plan development; however, not all components of the plans address NPS issues.

The effect of planning programs depends on many variables, including implementation of programs and monitoring of conformance with conditions of development approval.

5. Land or Development Rights Acquisition Practices and Cost Information

As discussed more fully at the beginning of this chapter and in Chapter 1, the following practices are described for illustrative purposes only. State programs need not require implementation of these practices. However, as a practical matter, EPA anticipates that the management measure set forth above generally will be implemented by applying one or more management practices appropriate to the source, location, and climate. The practices set forth below have been found by EPA to be representative of the types of practices that can be applied successfully to achieve the management measure described above.

An effective way to preserve land necessary for protecting the environmental integrity of an area is to acquire it outright or to limit development rights. The following practices can be used to protect beneficial uses.

■ a. Fee Simple Acquisition/Conservation Easements

The most direct way to protect land for preservation purposes and associated nonpoint source control functions is fee simple acquisition, through either purchase or donation. Once a suitable area is identified for preservation, the area may be acquired along with the development rights. The more development rights that are associated with a piece of property, the more expensive the property. Many State and local governments and private organizations have programs for purchasing land.

Conservation easements are restrictions put on property that legally restrict the present and future use of the land. For preservation purposes, the easement holder is usually not the owner of the property and is able to control property rights that a landowner could use that might cause adverse impacts to resources on the property. In effect, the property owner gives up development rights within the easement while retaining fee ownership of the property (Mantell et al., 1990; Barrett and Livermore, 1983).

■ b. Transfer of Development Rights

The principle of transfer of development rights (TDR) is based on the concept that ownership of real property includes the ownership of a bundle of rights that goes with it. These rights may include densities granted by a certain use designation, environmental permits, zoning approvals, and others. Certain properties have a bigger bundle of rights than others, depending on what approvals have been received by the owner. The TDR system takes all or some of the rights on one piece of property and moves them to another parcel. The purpose of TDRs is to shift future development potential from an area that is determined to be unsuitable for development (sending site) to an area deemed more suitable (receiving site). The development potential can be measured in a variety of ways, including number of dwelling units, square footage, acres, or number of parking spaces. Most TDR systems require a legal restriction for future development on the sending site. TDR programs can be either fixed so that there are only a certain number of sending and receiving sites in an area or flexible so that a sender and receiver can be matched as the situation allows (Mantell et al., 1990; Barrett and Livermore, 1983).

This system is useful for the preservation of those areas thought necessary for maintaining the quality of surface waters in that development rights associated with the environmentally sensitive areas can be transferred to less sensitive areas. There are several examples in the United States where TDRs have been used. Some of the more successful projects involve preservation of the New Jersey Pine Barrens and the Santa Monica Mountains in California. For the TDR concept to work, receiving and sending sites should be identified and evaluated, a program that is simple and flexible should be developed, and the use of the program should be promoted and facilitated (Mantell et al., 1990).

■ c. Purchase of Development Rights

In this process, the rights of development are purchased while the remaining rights remain with the fee title holder. Restrictions in the deed make it clear that the land cannot be developed based on the rights that have been purchased (Mantell et al., 1990).

Howard County, Maryland, has the goal of preserving 20,000 acres of farmland. Development rights are acquired in perpetuity with one-fourth of one percent of the local land transfer tax used as funding. There is no cap on the percent of assessed value that may be considered development value, and payment for development rights may be spread over 30 years to ease the capital gains tax burden on the landowner (Jenkins, 1991).

■ d. Land Trusts

Land trusts may be established as publicly or privately sponsored nonprofit organizations with the goal of holding lands or conservation easements for the protection of habitat, water quality, recreation, or scenic value or for agricultural preservation. A land trust may also preacquire properties that are conservation priorities if the land trust enters the development market when government funds are not immediately available by acquiring bank funding with the government as guarantor (Jenkins, 1991).

■ e. Agricultural and Forest Districts

Agricultural or forest districting is an alternative to acquisition of land or development rights. Jurisdictions may choose to allow landowners to apply for designation of land as an Agricultural or Forest District. Tax benefits are received in exchange for a commitment to maintain the land in agriculture, forest, or open space.

Fairfax County, Virginia, taxes land designated as Agricultural or Forest District based on the present use valuation rather than the usual potential use valuation. A commitment to agricultural or forestry activities must be shown, and sound land management practices must be used. The districts are established and renewed for 8-year periods (Jenkins, 1991).

■ f. Cost and Effectiveness of Land Acquisition Programs

The cost associated with land acquisition programs varies, depending on the desired outcome. If land is to be purchased, the cost will vary depending on the value of the land. An additional cost to be considered is the maintenance of the property once it is in public ownership. Easements and development rights are less expensive, and maintenance of the property is retained by the owner. Depending on the size of the local government, implementation of these programs is usually part of the operating budget of the appropriate agency (planning department or parks and recreation department, for example) and additional operational funding for implementation is dependent on the size of the local government.

The effectiveness of a land acquisition program is determined by the size of the parcel and the difference between predevelopment and potential postdevelopment pollutant loading rates. In addition, wetlands and riparian areas have been shown to reduce pollutant loadings. The acquisition and preservation of these areas can be extremely important to water quality protection and decrease the cost of implementing structural BMPs. However, the use of wetlands for urban runoff treatment, in general, should be discouraged. Where no other alternative exists, States and local governments can target upland areas for acquisition to minimize the impacts to wetlands and preserve the function of wetlands. One option for acquiring land is a public/private partnership. Several examples of such partnerships exist throughout the country. Harford County, Maryland, has targeted areas for purchase of conservation easements. The county staff is working jointly with a local land trust to acquire conservation easements and to educate people in environmentally sound land use practices. The estimated cost for the program is \$60,000 per year (Jenkins, 1991). To aid in the establishment of two local land trusts, Anne Arundel County, Maryland, provided \$350,000 in seed money for capital expenditures such as land and easement procurement. The county also gives staff assistance to volunteers; additional support comes from contributions of money or land, grants, and fundraisers (Jenkins 1991).

C. Site Development Management Measure

Plan, design, and develop sites to:

- (1) Protect areas that provide important water quality benefits and/or are particularly susceptible to erosion and sediment loss;
- (2) Limit increases of impervious areas, except where necessary;
- (3) Limit land disturbance activities such as clearing and grading, and cut and fill to reduce erosion and sediment loss; and
- (4) Limit disturbance of natural drainage features and vegetation.

1. Applicability

This management measure is intended to be applied by States to all site development activities including those associated with roads, highways, and bridges. Under the Coastal Zone Act Reauthorization Amendments of 1990, States are subject to a number of requirements as they develop coastal NPS programs in conformity with this management measure and will have flexibility in doing so. The application of management measures by States is described more fully in *Coastal Nonpoint Pollution Control Program: Program Development and Approval Guidance*, published jointly by the U.S. Environmental Protection Agency (EPA) and the National Oceanic and Atmospheric Administration (NOAA) of the U.S. Department of Commerce.

2. Description

The goal of this management measure is to reduce the generation of nonpoint source pollution and to mitigate the impacts of urban runoff and associated pollutants from all site development, including activities associated with roads, highways, and bridges. Management Measure II.C is intended to provide guidance for controlling nonpoint source pollution through the proper design and development of individual sites. This management measure differs from Management Measure II.A, which applies to postdevelopment runoff, in that Management Measure II.C is intended to provide controls and policies that are to be applied during the site planning and review process. These controls and policies are necessary to ensure that development occurs so that nonpoint source concerns are incorporated during the site selection and the project design and review phases. While the goals of the Watershed Protection Management Measure (II.B) are similar, Management Measure II.C is intended to apply to individual sites rather than watershed basins or regional drainage basins. The goals of both the Site Development and Watershed Protection Management Measures are, however, intended to be complementary and the measures should be used within a comprehensive framework to reduce nonpoint source pollution.

Programs designed to control nonpoint source pollution resulting from site development, both during and after construction, should be developed to include provisions for:

- Site plan review and conditioned approval to ensure that the integrity of environmentally sensitive areas and areas necessary for maintaining surface water quality will not be lost;

- Requirements for erosion and sediment control plan review and approval prior to issuance of appropriate development permits; and
- Guidance on appropriate pollution prevention practices to be incorporated into site development and use.

In addition to the preceding provisions, where applicable, the following objectives should be incorporated into the site development process:

- During site development, disturb the smallest area necessary to perform current activities to reduce erosion and offsite transport of sediment;
- Avoid disturbance of unstable soils or soils particularly susceptible to erosion and sediment loss, and favor sites where development will minimize erosion and sediment loss;
- Where appropriate, protect and retain indigenous vegetation to decrease concentrated flows and to maintain site hydrology;
- Minimize, to the extent practicable, the percentage of impervious area on-site;
- Properly manage all maintained landscapes to avoid water quality impacts;
- Avoid alteration, modification, or destruction of natural drainage features on-site; and
- Design sites so that natural buffers adjacent to coastal waterbodies and their tributaries are preserved.

The use of site planning and evaluation can significantly reduce the cost of providing structural controls to retain sediment on the development site. Long-term maintenance burdens may also be reduced. Good site planning not only can attenuate runoff from development, but also can improve the effectiveness of the conveyance and treatment components of an urban runoff management system (MWCOG, 1991).

During the site design process, planners should further identify sensitive areas and land forms that may provide water quality protection. These areas should be targeted for preservation or conservation and incorporated into site design. Highly erodible soils should be avoided. By siting development away from erodible soils, it is possible to significantly reduce the amount of erosion, although soil type, topography, vegetation, and climatological conditions affect the degree of erosion resulting from land disturbance activities both during and after construction. In the United States, it has been estimated that human activity causes the transport of nearly 4 billion tons of sediment annually, one-fourth of which eventually reaches the ocean. Sediment loads from developing areas where new construction is occurring can be 5 to 500 times greater than loadings from undeveloped rural areas (Gray, 1972). Natural erosion rates from forested areas or well-sodded prairies are in the range of 0.1 to 1.0 ton of soil per acre per year (Washington Department of Ecology, 1989). Because many nonpoint source pollutants, including heavy metals and nutrients, adsorb to sediments, it is important to limit the volume of sediment leaving a site and entering surface waters.

The Maryland State Highway Administration has developed initiatives to protect sensitive habitats as part of the governor's program to clean up and preserve the Chesapeake Bay. A selection of these initiatives include the following:

- Use of turbidity curtains to protect sensitive sections of a waterway during construction;
- Inspection and maintenance of runoff controls after every storm event;
- Immediate notification of noncompliance and follow-up inspection, when noncompliance occurs;

- A 72-hour stabilization requirement;
- Oversizing of sediment traps and basins depending on right-of-way constraints;
- Innovative scheduling for paving versus vegetative stabilization and implementation of infiltration practices to reduce thermal impacts;
- Minimal clearing of forest areas; and
- Installation of traps and basins prior to grading (Maryland State Highway Administration, 1990).

3. Management Measure Selection

This management measure was selected because the components of the measure have already been implemented, to varying degrees, by State and local governments. For example, the States of California, Maryland, Delaware, and Florida and the local governments of Montgomery, Prince Georges, and Anne Arundel counties in Maryland have implemented these concepts in State or local ordinances and in erosion and sediment control regulations. This measure is intended to provide States and local governments with general guidance on nonpoint source pollution objectives that can be integrated into the site planning process. The components of the management measure were selected to represent the minimum provisions that State and local governments must implement.

This approach was adopted to use existing programs and staff, thereby reducing administrative burdens and implementation costs as much as possible. A significant number of local governments have programs to oversee and review the site development process. In many communities, the costs of implementing this measure within the scope of existing programs may be nominal.

4. Practices and Cost Information for Control of Erosion During Site Development

As discussed more fully at the beginning of this chapter and in Chapter 1, the following practices are described for illustrative purposes only. State programs need not require implementation of these practices. However, as a practical matter, EPA anticipates that the management measure set forth above generally will be implemented by applying one or more management practices appropriate to the source, location, and climate. The practices set forth below have been found by EPA to be representative of the types of practices that can be applied successfully to achieve the management measure described above.

■ a. *Erosion and Sediment Control Plans and Programs*

Structural control measures for reducing impacts from erosion during site construction are discussed in the Construction Management Measure. These practices can be implemented as part of plans established in erosion and sediment control ordinances by local government or State laws. A well-thought-out plan for urban runoff management on construction sites can control erosion, retain sediments on the site, and reduce the environmental effects of runoff. In addition to a plan for BMP use, contractors should develop schedules that minimize the area of exposed soil at any given time, particularly during times of heavy or frequent rains. Table 4-12 lists items that should be considered in an erosion and sediment control (ESC) plan. Table 4-13 contains examples of sediment and erosion control requirements implemented at the State and local levels. All temporary erosion and sediment control practices that will be used during the construction phase should be detailed in architectural or engineering drawings to ensure that they are properly implemented. Inclusion of temporary pollution control practices on construction drawings also ensures that their costs are included in the pricing and bidding process (USEPA, 1973).

**Table 4-12. Items to Consider in Developing an Erosion and Sediment Control Plan
(Adapted from Goldman, 1986)**

Item	Description
Schedule grading and construction to minimize soil exposure.	<ul style="list-style-type: none"> • Schedule projects so clearing and grading are done during the dry season or the time of minimum erosion potential. Many parts of the country have a time of year when erosion potential is relatively low and carefully planned construction scheduling could be very effective. • Stage construction so that one area can be stabilized before another is disturbed. This practice reduces the time that an area is left unstabilized.
Retain existing vegetation wherever feasible.	<ul style="list-style-type: none"> • Clear only those areas that are essential for completing site construction. • Avoid disturbing vegetation on steep slopes or other critical areas and locate material stockpiles, borrow areas, and access roads away from critical areas. • Route construction traffic to avoid existing or newly planted vegetation. • Physically mark off limits of land disturbance with tape, signs, or barriers. This ensures that the bulldozer operator knows the proposed limits of clearing. • Protect natural vegetation with fencing, tree armoring, retaining walls, or tree walls.
Stabilize all denuded areas within 15 calendar days after final grading. Disturbed areas that are inactive and will be exposed to rain for 30 days or more should also be temporarily stabilized.	<ul style="list-style-type: none"> • During favorable seeding dates and in areas where vegetation can be established, the following should be implemented: <ul style="list-style-type: none"> - Use seeding and fertilizing in very flat, nonsensitive areas with favorable soils. - Use seeding and mulching for less erosive soil or on moderately steep slopes with moderately erosive soils in relatively sensitive areas. - Use seeding with multiple mulching treatments or sodding for highly erosive soil, very steep slopes, or sensitive areas with highly erosive soils. • If stabilization is required during the time of year that vegetation cannot be established, implement the following practices: <ul style="list-style-type: none"> - On moderate slopes or soil that is not highly erodible, mulching should be employed. - On steep slopes or highly erodible soils, multiple mulching treatments should be used. • If in high elevation or desert site where grasses cannot survive due to harsh environment, at a minimum, plant native shrubs. • Before stabilizing an area, make sure necessary controls (e.g., diversion of runoff) are in place. • Where practical, stockpile topsoil and reapply to revegetate site. • Cover or stabilize topsoil stockpiles. • For high potential for wind-blown sediment transport, prior to stabilization protect with dust controls such as wind barriers, mulching, tillage, or sprinkling.
Divert runoff away from denuded areas or newly seeded slopes.	<ul style="list-style-type: none"> • Above disturbed areas, construct dike or swale or install pipe slope drain to intercept runoff and convey it to a permanent channel or storm drain.
Minimize length and steepness of slopes.	<ul style="list-style-type: none"> • On long or steep disturbed or man-made slopes, construct benches, terraces, or ditches at regular intervals to intercept runoff.

Table 4-12. (Continued)

Item	Description
Prepare drainageways and outlets to handle concentrated or increased runoff.	<ul style="list-style-type: none"> • Provide lining for any existing or newly constructed channel on-site or off-site so the 2-year storm channel velocity does not cause erosion. • Check dams should be installed on temporary swales that have erosive velocity but due to their short service life cannot support a vegetative lining.
Trap sediment onsite (sediment controls).	<ul style="list-style-type: none"> • In areas where greater than 5 acres drain to a point, sediment basin should be installed. • In areas where less than 5 acres of concentrated flow leaves the site, silt traps should be installed. • In areas where sheet flow leaves the site and the drainage area is less than 0.5 ac/100 ft of flow, filter fabric fence should be installed. • In areas where sheet flow leaves the site and the drainage area is greater than 0.5 ac/100 ft of flow, perimeter dikes should be installed and flow should be diverted to a sediment trap or sediment basin. • Install inlet protection around all storm drain inlets. • Install construction entrance (gravel pad to collect mud and sediment from wheels) and route all traffic leaving the site to the construction entrance. • Install all sediment controls prior to grading.
Inspect and maintain control measures.	<ul style="list-style-type: none"> • Remove sediment from sediment traps and filter fence when silted to half capacity. • Inspect and repair, as needed, all controls after each storm event.

NOTE: These are recommendations only and are not intended to be all-inclusive.

Table 4-13. State and Local Construction Site Erosion and Sediment Control Plan Requirements

State or Local Government	General Requirements
Delaware	State law requires erosion and sediment control plans as part of site development approval on construction sites over 5,000 square feet. The State has adopted an ESC handbook. Temporary or permanent stabilization must occur within 14 calendar days of disturbance.
Florida	State law requires erosion and sediment control plans on all construction sites requiring a storm water management permit.
Maine	State law requires ESC plans for construction sites adjacent to a wetland or waterbody. Measures should ensure that soil is stabilized to prevent erosion of shoreline and siltation of the waterbody. The ESC must prevent the wash of materials into surface waters. Sites must be stabilized at completion of construction or if there is no activity for 7 calendar days. If temporary stabilization is used, permanent stabilization must occur within 30 calendar days; if not, permanent stabilization is required upon completion of construction.
Maryland	State law requires ESC plans for all construction sites over 5,000 square feet. If there is no activity on a construction site for 14 calendar days, the site must be seeded. Permanent stabilization must occur within 7 calendar days.
Michigan	State law requires ESC plans for sites over 1 acre or within 500 feet of a waterbody. Permanent stabilization must occur within 15 calendar days of final grading. Temporary stabilization is required within 30 days if construction activity ceases.
New Jersey	State law requires ESC plans for sites over 5,000 square feet.
North Carolina	State law requires ESC plans on construction sites over 1 acre. Controls must be sufficient to retain the sediment generated by land disturbance activities. Stabilization must occur within 30 working days of completion of any phase of development.
Ohio	State law requires ESC plans for sites larger than 5 acres. Permanent stabilization must occur within 7 calendar days of final grading or when there has been no construction activity on the site for 45 days.
Pennsylvania	State law requires ESC plans for all development; however, the State reviews only plans for sites greater than 25 acres. Sites must be stabilized as soon as possible after grading. Temporary stabilization is required within 70 days if the site will be inactive for more than 30 days. Permanent stabilization is required if the site will be inactive for more than 1 year.
South Carolina	State law requires an ESC plan for all residential, commercial, industrial, or institutional land use, unless specifically exempted. Perimeter controls must be installed, and temporary or permanent stabilization is required for topsoil stockpiles and all other disturbed areas within 7 calendar days of site disturbance.
Virginia	For areas within the jurisdiction of the Chesapeake Bay Preservation Act, no more land is to be disturbed than is necessary to provide for the allowed development. Indigenous vegetation must be preserved to the greatest extent possible.
Washington	State law mandated development of a State storm water management plan, including erosion control provisions. In response, the Department of Ecology is to develop construction activity regulations.

Table 4-13. (Continued)

State or Local Government	General Requirements
King County, WA	King County Code requires submission of a comprehensive plan in accordance with BMPs in King County Conservation District's publication, <i>Construction and Water Quality: A Guide to Recommended Construction Practices for the Control of Erosion and Sedimentation in King County</i> .
City of Bellevue, WA	A Temporary Erosion/Sedimentation Control Plan is required for any construction requiring a storm water detention facility or a Clearing and Grading Permit.
Puget Sound Basin, WA	Program Implementation Guidance requires all exposed and unworked soils to be stabilized by suitable application of BMPs. From October 1 to April 30, no soils shall remain unstabilized for more than 2 days. From May 1 to September 30, no soils shall remain unstabilized for more than 7 days. Prior to leaving the site, stormwater runoff shall pass through a sediment pond or sediment trap, or other appropriate BMPs.
Wisconsin	State law requires ESC plans for sites over 4,000 square feet. Permanent or temporary stabilization is required within 7 days.
Colleton County, SC	The county Development Standards Ordinance requires that BMPs be used during development or land-disturbing activity affecting greater than 1 acre. The State's guidelines for BMPs are adopted by reference.
Birmingham, AL	Through the city's Soil and Erosion Sediment Control Code, a clearing and earthwork permit is required for most construction sites over 10,000 square feet. The disturbed area must be stabilized as quickly as practicable.

b. Phasing and Limiting Areas of Disturbance

This practice reduces the potential for erosion and can be accomplished by prohibiting clearing and grading from all postdevelopment buffer zones, configuring the site plan to retain high amounts of open space, and using phased construction sequencing to limit the amount of disturbed area at any given time.

c. Require vegetative stabilization.

Rapid establishment of a grass or mulch cover on a cleared or graded area at construction sites can reduce suspended sediment levels to surface waters by up to sixfold. Mandatory temporary stabilization of areas left undisturbed for 7 to 14 days is recommended, unless conditions indicate otherwise. Section III.A contains detailed information regarding vegetative stabilization practices.

d. Minimum Disturbance/Minimum Maintenance

Minimum disturbance/minimum maintenance is an approach to site development in which clearing and site grading are allowed only within a carefully prescribed building area, preserving and protecting the existing natural vegetation. Landscapes that demand significant amounts of chemical treatment should be avoided. Minimum disturbance/minimum maintenance strategies help minimize nonpoint source impacts associated with the application of fertilizers, pesticides, and herbicides that result from new land development. The retention of existing vegetation may also help maintain predevelopment runoff volumes and peak rates of discharge and thus reduce erosion.

Translation of a concept such as minimum disturbance/minimum maintenance into straightforward numerical standards and criteria is difficult. A certain level of interpretation and judgment is often necessary. Nevertheless, basic standards can be established. Assuming that land use categories have been established through the local land

use plans or zoning ordinances, vegetation mapping can be used to illustrate where the proposed development can be constructed with minimal impact on existing vegetation. The area to be disturbed should be identified for all buildings, structures, roads, walkways, and activity areas. The exact dimensions of this disturbance will be subjective and will depend on factors such as lot size and site-specific conditions. For example, a single-family residential development can be constructed with a narrower zone of disturbance than a mall or office park that may require larger construction equipment with greater maneuverability. In general, an extremely conservative zone width would be 10 feet beyond the roof line of a structure or dwelling unit; a more moderate criterion might be 25 feet. Mall sites and large residential developments are typically mass-graded. Limits of Disturbance (LOD) are usually required on all erosion and sediment control plans and are always a function of grading requirements.

Program Implementation Costs

The annual costs of establishing and implementing a minimum disturbance/minimum maintenance (MD/MM) program are estimated below. In some cases, the MD/MM tasks can be incorporated within the framework of the existing land development review process and implementation costs would only be additive. A new program, however, would need trained staff responsible for ensuring that developers properly integrate the requirements for the MD/MM into their respective site plans. The need to inspect sites during construction would also result in additional costs. The annual operating costs of implementing such a program will vary depending on the size of the community and the degree of new development. For a typical program, estimated costs may be approximately \$110,000 for one professional staffperson and can be divided as follows:

Professional staff	\$ 60,000
Support staff	\$ 30,000
Office space	\$ 15,000
Office expenses	<u>\$ 5,000</u>
 Total	 \$110,000 per year

These figures are based on approximate average salaries and expenses for similar programs.

The manner by which a turf management or landscape control ordinance is developed or implemented varies to some extent, county by county, State by State. The process would reflect county size, the framework of existing government agencies, techniques of governance, and numerous other factors. Costs would vary as well. These specific aspects of the program would be established by any initial studies and establishment of program requirements, as discussed above. Also, as experience is gained by the staff and the minimum disturbance/minimum maintenance concept is better understood by the development community, the need for services might be expected to decrease as the result of increased program operation efficiency.

5. Site Planning Practices

As discussed more fully at the beginning of this chapter and in Chapter 1, the following practices are described for illustrative purposes only. State programs need not require implementation of these practices. However, as a practical matter, EPA anticipates that the management measure set forth above generally will be implemented by applying one or more management practices appropriate to the source, location, and climate. The practices set forth below have been found by EPA to be representative of the types of practices that can be applied successfully to achieve the management measure described above.

■ a. Clustering

Clustering development is used to concentrate development and construction activity on a limited portion of a site, leaving the remaining portion undisturbed. This allows for the design of more effective erosion and sediment control and urban runoff management plans for the sites, as described in Section II.A. It also provides a mechanism for preserving environmentally sensitive areas and reducing road lengths and impervious parking areas.

NOTE: A common belief is that low-density development is more environmentally sound because it results in increased open space. Minimum lot size requirements can result in suburban sprawl. Many of these areas are heavily landscaped and therefore have the potential to contribute significant loadings of nutrients and pesticides to surface waters. In many cases, clustering and infill development may be more environmentally sound strategies. They may also result in a cost savings for municipalities because clustering and infill development usually require less infrastructure, including urban runoff treatment systems. The imposition of density controls may preclude clustering. While minimum lot size requirements are useful in some instances, such as farmland preservation, zoning ordinances should not preclude the implementation of clustered development as an alternative to traditional suburban development.

■ b. *Performance Criteria*

Performance criteria for site development contain certain built-in safeguards to protect natural features. Performance criteria often apply not to individual zoning districts but to the site being regulated or protected and set fixed protection levels for specific resources that are not based on general zoning definitions.

■ c. *Site Fingerprinting*

The total amount of disturbed area within a site can be reduced by fingerprinting development. Fingerprinting places development away from environmentally sensitive areas (wetlands, steep slopes, etc.), future open spaces, tree save areas, future restoration areas, and temporary and permanent vegetative forest buffer zones. At a subdivision or lot level, ground disturbance is confined to areas where structures, roads, and rights of way will exist after construction is complete.

■ d. *Preserving Natural Drainage Features and Natural Depressional Storage Areas*

As discussed in the Watershed Protection Management Measure, natural drainage features should be preserved as development occurs. This can be done at the site planning stage as well as the watershed planning stage and is desirable because of the ability of natural drainage features to infiltrate and attenuate flows and filter pollutants. Depressional storage areas, commonly found as ponded areas in fields during the wet season or large runoff events, serve the purpose of reducing runoff volumes and trapping pollutants. These areas are usually filled and graded as a site is developed. Cluster development can be used to preserve natural drainage features and depressional storage areas and allow for incorporation of these features into a site design (Dreher and Price, 1992).

■ e. *Minimizing Imperviousness*

Through the use of various incentives, such as those found in the Maryland Chesapeake Bay Critical Areas 10 Percent Rule, a general strategy of minimizing paved areas can be implemented at the site planning level. Methods used to meet this goal include:

- Reduced sidewalk widths, especially in low-traffic neighborhoods;
- Use of permeable materials for sidewalk construction;
- Mandatory open space requirements;
- Use of porous, permeable, or gritted pavement, where appropriate;
- Reduced building setbacks, which reduces the lengths of driveways and entry walks; and
- Reduced street widths by elimination of onstreet parking (where such action does not pose a safety hazard).

■ f. *Reducing the Hydraulic Connectivity of Impervious Surfaces*

Pollutant loading from impervious surfaces may be reduced if the impervious area does not connect directly to an impervious conveyance system. This can be done in at least four ways:

- Route runoff over lawn areas to increase infiltration;
- Discourage the direct connection of downspouts to storm sewers or the discharge of downspouts to driveways or parking lots;
- Substitute swale and pond systems to increase infiltration; and
- Reduce the use of storm sewers to drain streets, parking lots, and back yards (NIPC, 1992)

■ *g. Xeriscape Programs*

Xeriscaping is a landscaping concept that maximizes the conservation of water by the use of site-appropriate plants and an efficient watering system and involves the use of landscaping plants that need minimal watering, fertilization, and pesticide application. Xeriscaping can reduce the contribution of landscaped areas to coastal nonpoint source pollution. Xeriscape designs can reduce landscape maintenance by as much as 50 percent, primarily as a result of the following:

- Reduction of water loss and soil erosion through careful planning, design, and implementation;
- Reduction of mowing by limiting lawn areas and using proper fertilization techniques; and
- Reduction of fertilization through soil preparation (Clemson University, 1991).

In 1991, the Florida Legislature adopted a xeriscape law that requires State agencies to adopt and implement xeriscaping programs. The law requires that rules and guidelines for implementation of xeriscaping along highway rights-of-way and on public property associated with publicly owned buildings constructed after July 1, 1992, be adopted. Local governments are to determine whether xeriscaping is a cost-effective measure for conserving water. If so, local governments are to work with the water management districts in developing their xeriscape guidelines. Water management districts will provide financial incentives to local governments for developing xeriscape plans and ordinances. These plans must include:

- Landscape design, installation, and maintenance standards;
- Identification of prohibited plant species (invasive exotic plants);
- Identification of controlled plant species and conditions for their use;
- Specifications for maximum percentage of turf and impervious surfaces allowed in a xeriscaped area;
- Specifications for land clearing and requirements for the conservation of existing native vegetation; and
- Monitoring programs for ordinance implementation and compliance.

There is also a provision in the law requiring local governments and water management districts to promote the use of xeriscape practices in already developed areas through public education programs. California has passed a law requiring all municipalities to consider enacting water-efficient landscape requirements.

III. CONSTRUCTION ACTIVITIES

A. Construction Site Erosion and Sediment Control Management Measure

- (1) Reduce erosion and, to the extent practicable, retain sediment onsite during and after construction, and
- (2) Prior to land disturbance, prepare and implement an approved erosion and sediment control plan or similar administrative document that contains erosion and sediment control provisions.

1. Applicability

This management measure is intended to be applied by States to all construction activities on sites less than 5 acres in areas that do not have an NPDES permit³ in order to control erosion and sediment loss from those sites. This management measure does not apply to: (1) construction of a detached single family home on a site of 1/2 acre or more or (2) construction that does not disturb over 5,000 square feet of land on a site. (NOTE: All construction activities, including clearing, grading, and excavation, that result in the disturbance of areas greater than or equal to 5 acres or are a part of a larger development plan are covered by the NPDES regulations and are thus excluded from these requirements.) Under the Coastal Zone Act Reauthorization Amendments of 1990, States are subject to a number of requirements as they develop coastal NPS programs in conformity with this management measure and will have flexibility in doing so. The application of management measures by States is described more fully in *Coastal Nonpoint Pollution Control Program: Program Development and Approval Guidance*, published jointly by the U.S. Environmental Protection Agency (EPA) and the National Oceanic and Atmospheric Administration (NOAA) of the U.S. Department of Commerce.

2. Description

The goal of this management measure is to reduce the sediment loadings from construction sites in coastal areas that enter surface waterbodies. This measure requires that coastal States establish new or enhance existing State erosion and sediment control (ESC) programs and/or require ESC programs at the local level. It is intended to be part of a comprehensive land use or watershed management program, as previously detailed in the Watershed and Site Development Management Measures. It is expected that State and local programs will establish criteria determined by local conditions (e.g., soil types, climate, meteorology) that reduce erosion and sediment transport from construction sites.

Runoff from construction sites is by far the largest source of sediment in urban areas under development (York County Soil and Water Conservation District, 1990). Soil erosion removes over 90 percent of sediment by tonnage in urbanizing areas where most construction activities occur (Canning, 1988). Table 4-14 illustrates some of the

³ On May 27, 1992, the United States Court of Appeals for the Ninth Circuit invalidated EPA's exemption of construction sites smaller than 5 acres from the storm water permit program in *Natural Resources Defense Council v. EPA*, 965 F.2d 759 (9th Cir. 1992). EPA is conducting further rulemaking proceedings on this issue and will not require permit applications for construction activities under 5 acres until further rulemaking has been completed.

measured sediment loading rates associated with construction activities found across the United States. As seen in Table 4-14, erosion rates from natural areas such as undisturbed forested lands are typically less than one ton/acre/year, while erosion from construction sites ranges from 7.2 to over 1,000 tons/acre/year.

Table 4-14. Erosion and Sediment Problems Associated With Construction

Location	Problem	Reference
United States	Sediment loading rates vary from 36.5 to 1,000 ton/ac/yr. These are 5 to 500 times greater than those from undeveloped land. Approximately 600 million tons of soil erodes from developed sites each year. Construction site sediment in runoff can be 10 to 20 times greater than that from agricultural lands.	York County Soil and Water Conservation District, 1990
Franklin County, FL	Sediment yield (ton/ac/yr): forest < 0.5 rangeland < 0.5 tilled 1.4 construction site 30 established urban < 0.5	Franklin County, FL
Wisconsin	Erosion rates range from 30 to 200 ton/ac/yr (10 to 20 times those of cropland).	Wisconsin Legislative Council, 1991
Washington, DC	Erosion rates range from 35 to 45 ton/ac/yr (10 to 100 times greater than agriculture and stabilized urban land uses).	MWCOG, 1987
Anacostia River Basin, VA, MD, DC	Sediment yields from portions of the Anacostia Basin have been estimated at 75,000 to 132,000 ton/yr.	U.S. Army Corps of Engineers, 1990
Washington	Erosion rates range from 50 to 500 ton/ac/yr. Natural erosion rates from forests or well-sodded prairies are 0.01 to 1.0 ton/ac/yr.	Washington Department of Ecology, 1989
Anacostia River Basin, VA, MD, DC	Erosion rates range from 7.2 to 100.8 ton/ac/yr.	USGS, 1978
Alabama	1.4 million tons eroded per year.	Woodward-Clyde, 1991
North Carolina	6.7 million tons eroded per year.	
Louisiana	5.1 million tons eroded per year.	
Oklahoma	4.2 million tons eroded per year.	
Georgia	3.8 million tons eroded per year.	
Texas	3.5 million tons eroded per year.	
Tennessee	3.3 million tons eroded per year.	
Pennsylvania	3.1 million tons eroded per year.	
Ohio	3.0 million tons eroded per year.	
Kentucky	3.0 million tons eroded per year.	

Eroded sediment from construction sites creates many problems in coastal areas including adverse impacts on water quality, critical habitats, submerged aquatic vegetation (SAV) beds, recreational activities, and navigation (APWA, 1991). For example, the Miami River in Florida has been severely affected by pollution associated with upland erosion. This watershed has undergone extensive urbanization, which has included the construction of many commercial and residential buildings over the past 50 years. Sediment deposited in the Miami River channel contributes to the severe water quality and navigation problems of this once-thriving waterway, as well as Biscayne Bay (SFWMD, 1988).

ESC plans are important for controlling the adverse impacts of construction and land development and have been required by many State and local governments, as shown in Table 4-13 (in the Site Development section of this chapter). An ESC plan is a document that explains and illustrates the measures to be taken to control erosion and sediment problems on construction sites (Connecticut Council on Soil and Water Conservation, 1988). It is intended that existing State and local erosion and sediment control plans may be used to fulfill the requirements of this management measure. Where existing ESC plans do not meet the management measure criteria, inadequate plans may be enhanced to meet the management measure guidelines.

Typically, an ESC plan is part of a larger site plan and includes the following elements:

- Description of predominant soil types;
- Details of site grading including existing and proposed contours;
- Design details and locations for structural controls;
- Provisions to preserve topsoil and limit disturbance;
- Details of temporary and permanent stabilization measures; and
- Description of the sequence of construction.

ESC plans ensure that provisions for control measures are incorporated into the site planning stage of development and provide for the reduction of erosion and sediment problems and accountability if a problem occurs (York County Soil and Water Conservation District, 1990). An effective plan for urban runoff management on construction sites will control erosion, retain sediments on site, to the extent practicable, and reduce the adverse effects of runoff. Climate, topography, soils, drainage patterns, and vegetation will affect how erosion and sediment should be controlled on a site (Washington State Department of Ecology, 1989). An effective ESC plan includes both structural and nonstructural controls. Nonstructural controls address erosion control by decreasing erosion potential, whereas structural controls are both preventive and mitigative because they control both erosion and sediment movement.

Typical nonstructural erosion controls include (APWA, 1991; York County Soil and Water Conservation District, 1990):

- Planning and designing the development within the natural constraints of the site;
- Minimizing the area of bare soil exposed at one time (phased grading);
- Providing for stream crossing areas for natural and man-made areas; and
- Stabilizing cut-and-fill slopes caused by construction activities.

Structural controls include:

- Perimeter controls;
- Mulching and seeding exposed areas;
- Sediment basins and traps; and
- Filter fabric, or silt fences.

Some erosion and soil loss are unavoidable during land-disturbing activities. While proper siting and design will help prevent areas prone to erosion from being developed, construction activities will invariably produce conditions where erosion may occur. To reduce the adverse impacts associated with construction, the construction management measure suggests a system of nonstructural and structural erosion and sediment controls for incorporation into an

ESC plan. Erosion controls have distinct advantages over sediment controls. Erosion controls reduce the amount of sediment transported off-site, thereby reducing the need for sediment controls. When erosion controls are used in conjunction with sediment controls, the size of the sediment control structures and associated maintenance may be reduced, decreasing the overall treatment costs (SWRPC, 1991).

3. Management Measure Selection

This management measure was selected to minimize sediment being transported outside the perimeter of a construction site through two broad performance goals: (1) **reduce** erosion and (2) **retain** sediment onsite, to the extent practicable. These performance goals were chosen to allow States and local governments flexibility in specifying practices appropriate for local conditions.

While several commentors responding to the draft (May 1991) guidance expressed the need to define "more measurable, enforceable ways" to control sediment loadings, other commentors stressed the need to draft management measures that do not conflict with existing State programs and allow States and local governments to determine appropriate practices and design standards for their communities. These management measures were selected because virtually all coastal States control construction activities to prevent erosion and sediment loss.

The measures were specifically written for the following reasons:

- (1) Predevelopment loadings may vary greatly, and some sediment loss is usually inevitable;
- (2) Current practice is built on the use of systems of practices selected based on site-specific conditions; and
- (3) The combined effectiveness of erosion and sediment controls in systems is not easily quantified.

4. Erosion Control Practices

As discussed more fully at the beginning of this chapter and in Chapter 1, the following practices are described for illustrative purposes only. State programs need not require implementation of these practices. However, as a practical matter, EPA anticipates that the management measure set forth above generally will be implemented by applying one or more management practices appropriate to the source, location, and climate. The practices set forth below have been found by EPA to be representative of the types of practices that can be applied successfully to achieve the management measure described above.

Erosion controls are used to reduce the amount of sediment that is detached during construction and to prevent sediment from entering runoff. Erosion control is based on two main concepts: (1) disturb the smallest area of land possible for the shortest period of time, and (2) stabilize disturbed soils to prevent erosion from occurring.

■ *a. Schedule projects so clearing and grading are done during the time of minimum erosion potential.*

Often a project can be scheduled during the time of year that the erosion potential of the site is relatively low. In many parts of the country, there is a certain period of the year when erosion potential is relatively low and construction scheduling could be very effective. For example, in the Pacific region if construction can be completed during the 6-month dry season (May 1 - October 31), temporary erosion and sediment controls may not be needed. In addition, in some parts of the country erosion potential is very high during certain parts of the year such as the spring thaw in northern areas. During this time of year, melting snowfall generates a constant runoff that can erode soil. In addition, construction vehicles can easily turn the soft, wet ground into mud, which is more easily washed offsite. Therefore, in the north, limitations should be placed on grading during the spring thaw (Goldman et al., 1986).

■ b. Stage construction.

Avoid areawide clearance of construction sites. Plan and stage land disturbance activities so that only the area currently under construction is exposed. As soon as the grading and construction in an area are complete, the area should be stabilized.

By clearing only those areas immediately essential for completing site construction, buffer zones are preserved and soil remains undisturbed until construction begins. Physical markers, such as tape, signs, or barriers, indicating the limits of land disturbance, can ensure that equipment operators know the proposed limits of clearing. The area of the watershed that is exposed to construction is important for determining the net amount of erosion. Reducing the extent of the disturbed area will ultimately reduce sediment loads to surface waters. Existing or newly planted vegetation that has been planted to stabilize disturbed areas should be protected by routing construction traffic around and protecting natural vegetation with fencing, tree armoring, retaining walls, or tree wells.

■ c. Clear only areas essential for construction.

Often areas of a construction site are unnecessarily cleared. Only those areas essential for completing construction activities should be cleared, and other areas should remain undisturbed. Additionally, the proposed limits of land disturbance should be physically marked off to ensure that only the required land area is cleared. Avoid disturbing vegetation on steep slopes or other critical areas.

■ d. Locate potential nonpoint pollutant sources away from steep slopes, waterbodies, and critical areas.

Material stockpiles, borrow areas, access roads, and other land-disturbing activities can often be located away from critical areas such as steep slopes, highly erodible soils, and areas that drain directly into sensitive waterbodies.

■ e. Route construction traffic to avoid existing or newly planted vegetation.

Where possible, construction traffic should travel over areas that must be disturbed for other construction activity. This practice will reduce the area that is cleared and susceptible to erosion.

■ f. Protect natural vegetation with fencing, tree armoring, and retaining walls or tree wells.

Tree armoring protects tree trunks from being damaged by construction equipment. Fencing can also protect tree trunks, but should be placed at the tree's drip line so that construction equipment is kept away from the tree. The tree drip line is the minimum area around a tree in which the tree's root system should not be disturbed by cut, fill, or soil compaction caused by heavy equipment. When cutting or filling must be done near a tree, a retaining wall or tree well should be used to minimize the cutting of the tree's roots or the quantity of fill placed over the tree's roots.

■ g. Stockpile topsoil and reapply to revegetate site.

Because of the high organic content of topsoil, it cannot be used as fill material or under pavement. After a site is cleared, the topsoil is typically removed. Since topsoil is essential to establish new vegetation, it should be stockpiled and then reapplied to the site for revegetation, if appropriate. Although topsoil salvaged from the existing site can often be used, it must meet certain standards and topsoil may need to be imported onto the site if the existing topsoil is not adequate for establishing new vegetation.

■ h. *Cover or stabilize topsoil stockpiles.*

Unprotected stockpiles are very prone to erosion and therefore stockpiles must be protected. Small stockpiles can be covered with a tarp to prevent erosion. Large stockpiles should be stabilized by erosion blankets, seeding, and/or mulching.

■ i. *Use wind erosion controls.*

Wind erosion controls limit the movement of dust from disturbed soil surfaces and include many different practices. Wind barriers block air currents and are effective in controlling soil blowing. Many different materials can be used as wind barriers, including solid board fence, snow fences, and bales of hay. Sprinkling moistens the soil surface with water and must be repeated as needed to be effective for preventing wind erosion (Delaware DNREC, 1989); however, applications must be monitored to prevent excessive runoff and erosion.

■ j. *Intercept runoff above disturbed slopes and convey it to a permanent channel or storm drain.*

Earth dikes, perimeter dikes or swales, or diversions can be used to intercept and convey runoff above disturbed areas. An earth dike is a temporary berm or ridge of compacted soil that channels water to a desired location. A perimeter dike/swale or diversion is a swale with a supporting ridge on the lower side that is constructed from the soil excavated from the adjoining swale (Delaware DNREC, 1989). These practices should be used to intercept flow from denuded areas or newly seeded areas to keep the disturbed areas from being eroded from the uphill runoff. The structures should be stabilized within 14 days of installation. A pipe slope drain, also known as a pipe drop structure, is a temporary pipe placed from the top of a slope to the bottom of the slope to convey concentrated runoff down the slope without causing erosion (Delaware DNREC, 1989).

■ k. *On long or steep, disturbed, or man-made slopes, construct benches, terraces, or ditches at regular intervals to intercept runoff.*

Benches, terraces, or ditches break up a slope by providing areas of low slope in the reverse direction. This keeps water from proceeding down the slope at increasing volume and velocity. Instead, the flow is directed to a suitable outlet, such as a sediment basin or trap. The frequency of benches, terraces, or ditches will depend on the erodibility of the soils, steepness and length of the slope, and rock outcrops. This practice should be used if there is a potential for erosion along the slope.

■ l. *Use retaining walls.*

Often retaining walls can be used to decrease the steepness of a slope. If the steepness of a slope is reduced, the runoff velocity is decreased and, therefore, the erosion potential is decreased.

■ m. *Provide linings for urban runoff conveyance channels.*

Often construction increases the velocity and volume of runoff, which causes erosion in newly constructed or existing urban runoff conveyance channels. If the runoff during or after construction will cause erosion in a channel, the channel should be lined or flow control BMPs installed. The first choice of lining should be grass or sod since this reduces runoff velocities and provides water quality benefits through filtration and infiltration. If the velocity in the channel would erode the grass or sod, then riprap, concrete, or gabions can be used.

■ n. *Use check dams.*

Check dams are small, temporary dams constructed across a swale or channel. They can be constructed using gravel or straw bales. They are used to reduce the velocity of concentrated flow and, therefore, to reduce the erosion in

a swale or channel. Check dams should be used when a swale or channel will be used for a short time and therefore it is not feasible or practical to line the channel or implement flow control BMPs (Delaware DNREC, 1989).

o. *Seed and fertilize.*

Seeding establishes a vegetative cover on disturbed areas. Seeding is very effective in controlling soil erosion once a dense vegetative cover has been established. However, often seeding and fertilizing do not produce as thick a vegetative cover as do seed and mulch or netting. Newly established vegetation does not have as extensive a root system as existing vegetation and therefore is more prone to erosion, especially on steep slopes. Care should be taken when fertilizing to avoid untimely or excessive application. Since the practice of seeding and fertilizing does not provide any protection during the time of vegetative establishment, it should be used only on favorable soils in very flat areas and not in sensitive areas.

p. *Use seeding and mulch/mats.*

Seeding establishes a vegetative cover on disturbed areas. Seeding is very effective in controlling soil erosion once the vegetative cover has been established. The mulching/mats protect the disturbed area while the vegetation becomes established.

The management of land by using ground cover reduces erosion by reducing the flow rate of runoff and the raindrop impact. Bare soils should be seeded or otherwise stabilized within 15 calendar days after final grading. Denuded areas that are inactive and will be exposed to rain for 30 days or more should also be temporarily stabilized, usually by planting seeds and establishing vegetation during favorable seasons in areas where vegetation can be established. In very flat, non-sensitive areas with favorable soils, stabilization may involve simply seeding and fertilizing. Mulching and/or sodding may be necessary as slopes become moderate to steep, as soils become more erosive, and as areas become more sensitive.

q. *Use mulch/mats.*

Mulching involves applying plant residues or other suitable materials on disturbed soil surfaces. Mulchs/mats used include tacked straw, wood chips, and jute netting and are often covered by blankets or netting. Mulching alone should be used only for temporary protection of the soil surface or when permanent seeding is not feasible. The useful life of mulch varies with the material used and the amount of precipitation, but is approximately 2 to 6 months. Figure 4-5 shows water velocity reductions that could be expected using various mulching techniques. Similarly, Figure 4-6 shows reductions in soil loss achievable using various mulching techniques. During times of year when vegetation cannot be established, soil mulching should be applied to moderate slopes and soils that are not highly erodible. On steep slopes or highly erodible soils, multiple mulching treatments should be used. On a high-elevation or desert site where grasses cannot survive the harsh environment, native shrubs may be planted. Interlocking ceramic materials, filter fabric, and netting are available for this purpose. Before stabilizing an area, it is important to have installed all sediment controls and diverted runoff away from the area to be planted. Runoff may be diverted away from denuded areas or newly planted areas using dikes, swales, or pipe slope drains to intercept runoff and convey it to a permanent channel or storm drain. Reserved topsoil may be used to revegetate a site if the stockpile has been covered and stabilized.

Consideration should be given to maintenance when designing mulching and matting schemes. Plastic nets are often used to cover the mulch or mats; however, they can foul lawn mower blades if the area requires mowing.

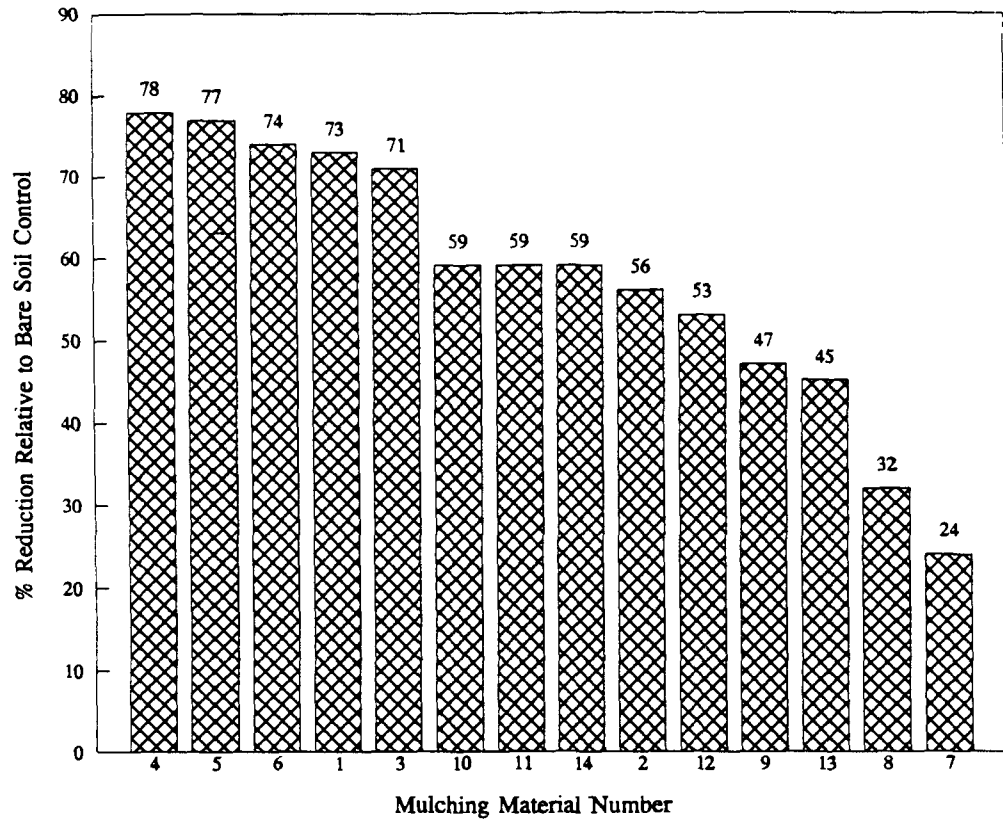

Mulch Material	Characteristics
1	100% wheat straw/top net
2	100% wheat straw/two nets
3	70% wheat straw/30% coconut fiber
4	70% wheat straw/30% coconut fiber
5	100% coconut fiber
6	Nylon monofilament/two nets
7	Nylon monofilament/rigid/bonded
8	Vinyl monofilament/flexible/bonded
9	Curled wood fibers/top net
10	Curled wood fibers/two nets
11	Antiwash netting (jute)
12	Interwoven paper and thread
13	Uncrimped wheat straw – 2,242 kg/ha
14	Uncrimped wheat straw – 4,484 kg/ha

Figure 4-5. Water velocity reductions for different mulch treatments (adapted from Harding, 1990).

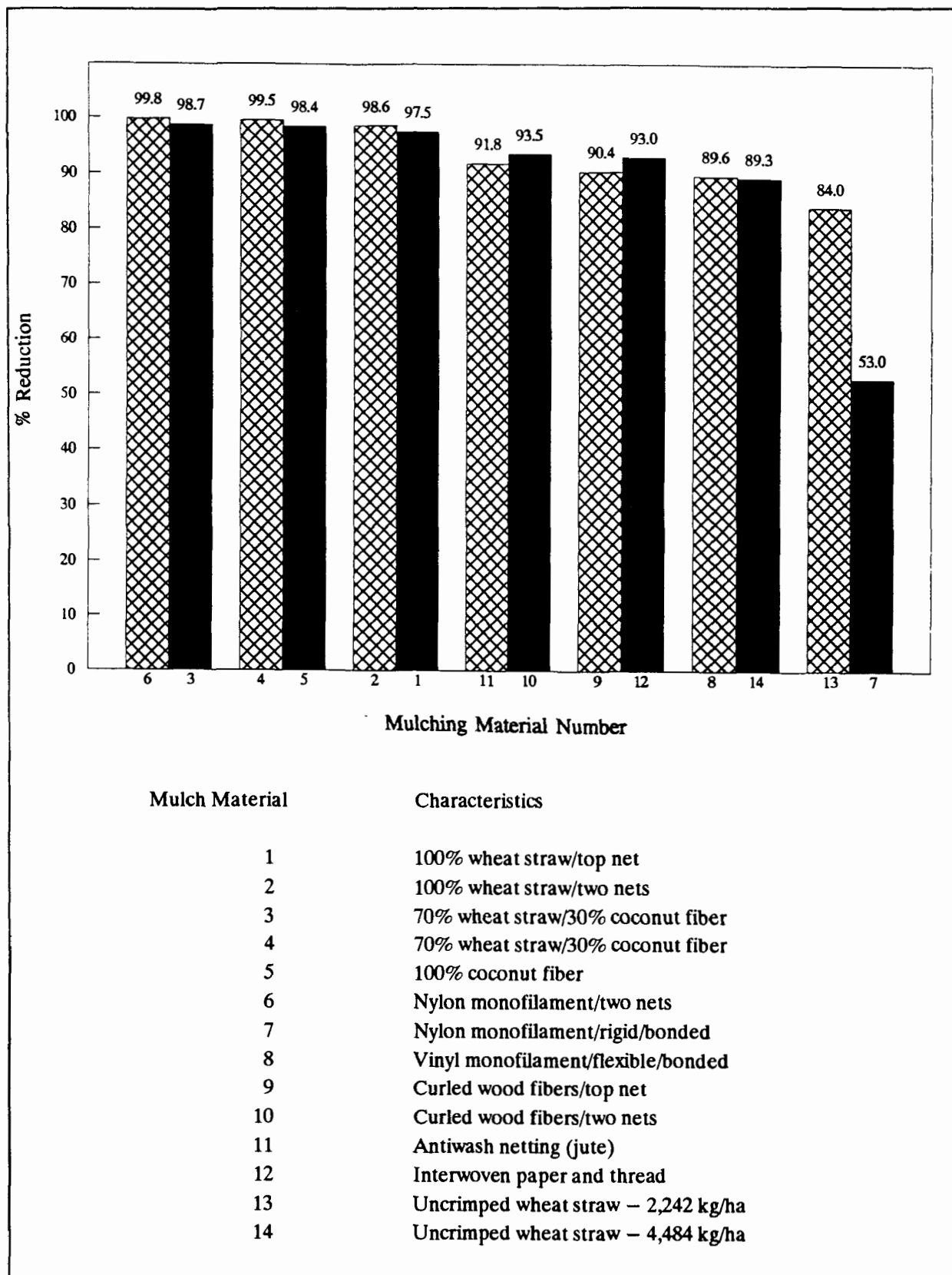

Figure 4-6. Actual soil loss reductions for different mulch treatments (adapted from Harding, 1990).

r. Use sodding.

Sodding permanently stabilizes an area. Sodding provides immediate stabilization of an area and should be used in critical areas or where establishment of permanent vegetation by seeding and mulching would be difficult. Sodding is also a preferred option when there is a high erosion potential during the period of vegetative establishment from seeding.

s. Use wildflower cover.

Because of the hardy drought-resistant nature of wildflowers, they may be more beneficial as an erosion control practice than turf grass. While not as dense as turfgrass, wildflower thatches and associated grasses are expected to be as effective in erosion control and contaminant absorption. Because thatches of wildflowers do not need fertilizers, pesticides, or herbicides, and watering is minimal, implementation of this practice may result in a cost savings (Brash et al., undated). In 1987, Howard County, Maryland, spent \$690.00 per acre to maintain turfgrass areas, compared to only \$31.00 per acre for wildflower meadows (Wilson, 1990).

A wildflower stand requires several years to become established; maintenance requirements are minimal once the area is established (Brash et al., undated).

5. Sediment Control Practices⁴

As discussed more fully at the beginning of this chapter and in Chapter 1, the following practices are described for illustrative purposes only. State programs need not require implementation of these practices. However, as a practical matter, EPA anticipates that the management measure set forth above generally will be implemented by applying one or more management practices appropriate to the source, location, and climate. The practices set forth below have been found by EPA to be representative of the types of practices that can be applied successfully to achieve the management measure described above.

Sediment controls capture sediment that is transported in runoff. Filtration and detention (gravitational settling) are the main processes used to remove sediment from urban runoff.

a. Sediment Basins

Sediment basins, also known as silt basins, are engineered impoundment structures that allow sediment to settle out of the urban runoff. They are installed prior to full-scale grading and remain in place until the disturbed portions of the drainage area are fully stabilized. They are generally located at the low point of sites, away from construction traffic, where they will be able to trap sediment-laden runoff.

Sediment basins are typically used for drainage areas between 5 and 100 acres. They can be classified as either temporary or permanent structures, depending on the length of service of the structure. If they are designed to function for less than 36 months, they are classified as "temporary"; otherwise, they are considered permanent structures. Temporary sediment basins can also be converted into permanent urban runoff management ponds. When sediment basins are designed as permanent structures, they must meet all standards for wet ponds.

b. Sediment Trap

Sediment traps are small impoundments that allow sediment to settle out of runoff water. Sediment traps are typically installed in a drainageway or other point of discharge from a disturbed area. Temporary diversions can be

⁴Adapted from Goldman (1986).

used to direct runoff to the sediment trap. Sediment traps should not be used for drainage areas greater than 5 acres and typically have a useful life of approximately 18 to 24 months.

■ c. *Filter Fabric Fence*

Filter fabric fence is available from many manufacturers and in several mesh sizes. Sediment is filtered out as urban runoff flows through the fabric. Such fences should be used only where there is sheet flow (i.e., no concentrated flow), and the maximum drainage area to the fence should be 0.5 acre or less per 100 feet of fence. Filter fabric fences have a useful life of approximately 6 to 12 months.

■ d. *Straw Bale Barrier*

A straw bale barrier is a row of anchored straw bales that detain and filter urban runoff. Straw bales are less effective than filter fabric, which can usually be used in place of straw bales. However, straw bales have been effectively used as temporary check dams in channels. As with filter fabric fences, straw bale barriers should be used only where there is sheet flow. The maximum drainage area to the barrier should be 0.25 acre or less per 100 feet of barrier. The useful life of straw bales is approximately 3 months.

■ e. *Inlet Protection*

Inlet protection consists of a barrier placed around a storm drain drop inlet, which traps sediment before it enters the storm sewer system. Filter fabric, straw bales, gravel, or sand bags are often used for inlet protection.

■ f. *Construction Entrance*

A construction entrance is a pad of gravel over filter cloth located where traffic leaves a construction site. As vehicles drive over the gravel, mud, and sediment are collected from the vehicles' wheels and offsite transport of sediment is reduced.

■ g. *Vegetated Filter Strips*

Vegetated filter strips are low-gradient vegetated areas that filter overland sheet flow. Runoff must be evenly distributed across the filter strip. Channelized flows decrease the effectiveness of filter strips. Level spreading devices are often used to distribute the runoff evenly across the strip (Dillaha et al., 1989).

Vegetated filter strips should have relatively low slopes and adequate length and should be planted with erosion-resistant plant species. The main factors that influence the removal efficiency are the vegetation type, soil infiltration rate, and flow depth and travel time. These factors are dependent on the contributing drainage area, slope of strip, degree and type of vegetative cover, and strip length. Maintenance requirements for vegetated filter strips include sediment removal and inspections to ensure that dense, vigorous vegetation is established and concentrated flows do not occur. Maintenance of these structures is discussed in Section II.A of this chapter.

6. Effectiveness and Cost Information

■ a. *Erosion Control Practices*

The effectiveness of erosion control practices can vary based on land slope, the size of the disturbed area, rainfall frequency and intensity, wind conditions, soil type, use of heavy machinery, length of time soils are exposed and unprotected, and other factors. In general, a system of erosion and sediment control practices can more effectively reduce offsite sediment transport than can a single system. Numerous nonstructural measures such as protecting natural or newly planted vegetation, minimizing the disturbance of vegetation on steep slopes and other highly

erodible areas, maximizing the distance eroded material must travel before reaching the drainage system, and locating roads away from sensitive areas may be used to reduce erosion.

Table 4-15 contains the available cost and effectiveness data for some of the erosion controls listed above. Information on the effectiveness of individual nonstructural controls was not available. All reported effectiveness data assume that controls are properly designed, constructed, and maintained. Costs have been broken down into annual capital costs, annual maintenance costs, and total annual costs (including annualization of the capital costs).

■ b. Sediment Control Practices

Regular inspection and maintenance are needed for most erosion control practices to remain effective. The effectiveness of sediment controls will depend on the size of the construction site and the nature of the runoff flows. Sediment basins are most appropriate for drainage areas of 5 acres or greater. In smaller areas with concentrated flows, silt traps may suffice. Where concentrated flow leaves the site and the drainage area is less than 0.5 ac/100 ft of flow, filter fabric fences may be effective. In areas where sheet flow leaves the site and the drainage area is greater than 0.5 acre/100 ft of flow, perimeter dikes may be used to divert the flow to a sediment trap or sediment basin. Urban runoff inlets may be protected using straw bales or diversions to filter or route runoff away from the inlets.

Table 4-16 describes the general cost and effectiveness of some common sediment control practices.

■ c. Comparisons

Figure 4-7 illustrates the estimated TSS loading reductions from Maryland construction sites possible using a combination of erosion and sediment controls in contrast to using only sediment controls. Figure 4-8 shows a comparison of the cost and effectiveness of various erosion control practices. As can be seen in Figure 4-8, seeding or seeding and mulching provide the highest levels of control at the lowest cost.

Table 4-15. ESC Quantitative Effectiveness and Cost Summary

Practice	Design Constraints or Purpose	Percent Removal of TSS	Useful Life (years) ^a	Construction Cost	Annual Maintenance Cost (as % construction cost)	Total Annual Cost
Sod	Immediate erosion protection where there is high erosion potential during vegetative establishment.	Average: 99% Observed range: 98% - 99% References: Minnesota Pollution Control Agency, 1989; Pennsylvania, 1983 cited in USEPA, 1991	2	Average: \$0.2 per ft ² [\$11,300 per acre] Range: \$0.1 - \$1.1 References: SWRPC, 1991; Schueler, 1987; Virginia, 1980	Average: 5% Range: 5% Reference: SWRPC, 1991	\$0.20 per ft ² \$7,500 per acre
Seed	Establish vegetation on disturbed area.	After vegetation established- Average: 90% Observed range: 50% - 100% References: SCS, 1985 cited in EPA, 1991; Minnesota Pollution Control Agency, 1989; Oberts, 1984 cited in City of Austin, 1988; Delaware Department of Natural Resources, 1989	2	Average: \$400 per acre Range: \$200 - \$1000 per acre References: Wisconsin DOT cited in SWRPC, 1991; SWRPC, 1991; Goldman, 1986; Virginia, 1980	Average: 20% Range: 15% - 25% References: Wisconsin DOT cited in SWRPC, 1991; SWRPC, 1991	\$300 per acre
Seed and Mulch	Establish vegetation on disturbed area.	After vegetation established- Average: 90% Observed range: 50% - 100% References: SCS, 1985 cited in EPA, 1991; Minnesota Pollution Control Agency, 1989; Oberts, 1984 cited in City of Austin, 1988; Delaware Department of Natural Resources, 1989	2	Average: \$1,500 per acre Range: \$800 - \$3,500 per acre References: Goldman, 1986; Washington DOT, 1990; NC State, 1990; Schueler, 1987; Virginia, 1980; SWRPC, 1991	Average: NA ^b Range: NA References: None	\$1,100 per acre

Table 4-15. (Continued)

Practice	Design Constraints or Purpose	Percent Removal of TSS	Useful Life (years) ^a	Construction Cost	Annual Maintenance Cost (as % construction cost)	Total Annual Cost	
Mulch	Temporary stabilization of disturbed area.	Observed range:		Straw mulch: 0.25	Straw mulch: Average: \$1,700 per acre Range: \$500 - \$5,000 per acre References: Wisconsin DOT cited in SWRPC, 1991; Washington DOT, 1990; Virginia, 1980	Straw mulch: \$7,500 per acre	
		<u>sand:</u>				Average: NA ^b Range: NA References: None	
			<u>20% slope</u>	<u>50% slope</u>			
		wood fiber @ 1500 lb/ac	50-60%	0-20%			
		wood fiber @ 3000 lb/ac	50-85%	50-70%			
		straw @ 3000 lb/ac	90-100%	95%			
		<u>Silt-loam:</u>			Wood fiber mulch: 0.33	Wood fiber mulch: Average: \$1,000 per acre Range: \$100 - \$2,300 per acre References: Washington DOT, 1990; Virginia, 1980	Wood fiber mulch: \$3,500 per acre
			<u>20% slope</u>	<u>50% slope</u>			
		wood fiber @ 1500 lb/ac	20-60%	40-60%			
		wood fiber @ 3000 lb/ac	60-90%	60-70%			
		straw @ 3000 lb/ac	80-95%	70-90%			
		<u>Silt-clay-loam:</u>			Jute netting: 0.33	Jute netting: Average: \$3,700 per acre Range: \$3,500-\$4,100 per acre References: Washington DOT, 1990; Virginia, 1980	Jute netting: \$12,500 per acre
	<u>10-30% slope</u>	<u>30-50% slope</u>					
wood fiber @ 1500 lb/ac	5%	--					
wood fiber @ 3000 lb/ac	40%	--					
jute netting	30-60%	30%					
straw @ 3000 lb/ac	40-70%	20-40%					
wood chips @ 10,000 lb/ac	60-80%	50-60%		Straw and jute: Average: \$5,400 per acre Range: \$4,000-\$9,100 per acre References: Washington DOT, 1990; Virginia, 1980	Straw and jute: \$18,000 per acre		
mulch blanket	60-80%	50-60%	Straw and jute: 0.33				
excelsior blanket	60-80%	50-60%					
multiple treatment (straw and jute)	90%	90%					
References: Minnesota Pollution Control Agency, 1989; Kay, 1983 cited in Goldman, 1986							

Table 4-15. (Continued)

Practice	Design Constraints or Purpose	Percent Removal of TSS		Useful Life (years) ^a	Construction Cost	Annual Maintenance Cost (as % construction cost)	Total Annual Cost
Terraces	Break up long or steep slopes.	Observed range:		2	Average: \$5 per lin ft Range: \$1 - \$12 References: SWRPC, 1991; Goldman, 1986; Virginia, 1991	Average: 20% Range: 20% Reference: SWRPC, 1991	\$4 per lin ft
		<u>Land Slope</u>	<u>Reduction in Erosion</u>				
		1-12%	70%				
		12-18%	60%				
		18-24%	55%				
		<p>Additionally, if the slope steepness is halved, while other factors are held constant, the soil loss potential decreases 2-1/2 times. If both the slope and length are halved, the soil loss potential is decreased 4 times. References: Goldman, 1986; Beasley, 1972</p>					
All Erosion Controls	Reduce amount of sediment entering runoff.	Average: 85% Observed range: 85% Reference: Schueler, 1990		--	Varies but typically low	Varies but typically low	Varies but typically low

NA - Not available.

^a Useful life estimated as length of construction project (assumed to be 2 years).

^b For Total Annual Cost, assume Annual Maintenance Cost = 2% of construction cost.

Table 4-16. ESC Quantitative Effectiveness and Cost Summary for Sediment Control Practices

Practice	Design Constraints or Purpose	Percent Removal of TSS	Useful Life (years) ^a	Construction Cost	Annual Maintenance Cost (as % construction cost)	Total Annual Cost
Sediment basin	Minimum drainage area = 5 acres, maximum drainage area = 100 acres	Average: 70% Observed range: 55% - 100% References: Schueler, 1990; Engle, BW and Jarrett, AR, 1990; Baumann, 1990	2	Less than 50,000 ft ³ storage Average: \$0.60 per ft ³ storage (\$1,100 per drainage acre ^c) Range: \$0.20 - \$1.30 per ft ³	Average: 25% Range: 25% References: Denver COG cited in SWRPC, 1991; SWRPC, 1991	Less than 50,000 ft ³ storage \$0.40 per ft ³ storage \$700 per drainage acre ^b
				Greater than 50,000 ft ³ storage Average: \$0.3 per ft ³ storage (\$550 per drainage acre ^c) Range: \$0.10 - \$0.40 per ft ³ References: SWRPC, 1991		Greater than 50,000 ft ³ storage \$0.20 per ft ³ storage \$900 per drainage acre ^c
Sediment trap	Maximum drainage area = 5 acres	Average: 60% Observed range: (-7%) - 100% References: Schueler, et al., 1990; Tahoe Regional Planning Agency, 1989; Baumann, 1990	1.5	Average: \$0.60 per ft ³ storage (\$1,100 per drainage acre ^c) Range: \$0.20 - \$2.00 per ft ³ References: Denver COG cited in SWRPC, 1991; SWRPC, 1991; Goldman, 1986	Average: 20% Range: 20% References: Denver COG cited in SWRPC, 1991; SWRPC, 1991	\$0.70 per ft ³ storage \$1,300 per drainage acre ^c
Filter Fabric Fence	Maximum drainage area = 0.5 acre per 100 feet of fence. Not to be used in concentrated flow areas.	Average: 70% Observed range: 0% - 100% sand: 80% - 99% silt-loam: 50% - 80% silt-clay-loam: 0% - 20% References: Munson, 1991; Fisher et al., 1984; Minnesota Pollution Control Agency, 1989	0.5	Average: \$3 per lin ft (\$700 per drainage acre ^c) Range: \$1 - \$8 per lin ft References: Wisconsin DOT cited in SWRPC, 1991; SWRPC, 1991; Goldman, 1986; Virginia, 1991; NC State, 1990	Average: 100% Range: 100% References: SWRPC, 1991	\$7 per lin ft \$850 per drainage acre ^c

Table 4-16. (Continued)

Practice	Design Constraints or Purpose	Percent Removal of TSS	Useful Life (years) ^a	Construction Cost	Annual Maintenance Cost (as % construction cost)	Total Annual Cost
Straw Bale Barrier	Maximum drainage area = 0.25 acre per 100 feet of barrier. Not to be used in concentrated flow areas.	Average: 70% Observed Range: 70% References: Virginia, 1980 cited in EPA, 1991	0.25	Average: \$4 per lin ft (\$1,600 per drainage acre ^d) Range: \$2 - \$6 per lin ft References: Goldman, 1986; Virginia, 1991	Average: 100% Range: 100% References: SWRPC, 1991	\$17 per lin ft \$6,800 per drainage acre ^d
Inlet Protection	Protect storm drain inlet.	Average: NA Observed Range: NA References: None	1	Average: \$100 per inlet Range: \$50 - \$150 References: SWRPC, 1991; Denver COG cited in SWRPC, 1991; Virginia, 1991; EPA cited in SWRPC, 1991	Average: 60% Range: 20% - 100% References: SWRPC, 1991; Denver COG cited in SWRPC, 1991	\$150 per inlet
Construction Entrance	Removes sediment from vehicles wheels.	Average: NA Observed Range: NA References: None	2	Average: \$2,000 each Range: \$1,000 - \$4,000 References: Goldman, 1986; NC State, 1990 With washrack: Average: \$3,000 each Range: \$1,000 - \$5,000 References: Virginia, 1991	Average: NA ^e Range: NA References: None	\$1,500 each \$2,200 each

Table 4-16. (Continued)

Practice	Design Constraints or Purpose	Percent Removal of TSS	Useful Life (years) ^a	Construction Cost	Annual Maintenance Cost (as % construction cost)	Total Annual Cost
Vegetative Filter Strip	Must have sheet flow.	Average: 70% Observed Range: 20% - 80% References: Hayes and Hairston, 1983 cited in Casman, 1990; Dillaha et al., 1989, cited in Glick et al., 1991; Virginia Department of Conservation, 1987; Nonpoint Source Control Task Force, 1983 cited in Minnesota PCA, 1989; Schueler, 1987	2	Established from existing vegetation- Average: \$0 Range: \$0 References: Schueler, 1987 Established from sod- Average: \$11,300 per acre Range: \$4,500 - \$48,000 per acre References: Schueler, 1987; SWRPC, 1991	Average: NA Range: NA References: None	NA

NA - Not available.

^a Useful life estimated as length of construction project (assumed to be 2 years)

^e For Total Annual Cost, assume Annual Maintenance Cost=20% of construction cost.

^b Assumes trap volume = 1800 cf/ac (0.5 inches runoff per acre).

^c Assumes drainage area of 0.5 acre per 100 feet of fence (maximum allowed).

^d Assumes drainage area of 0.25 acre per 100 feet of barrier (maximum allowed).

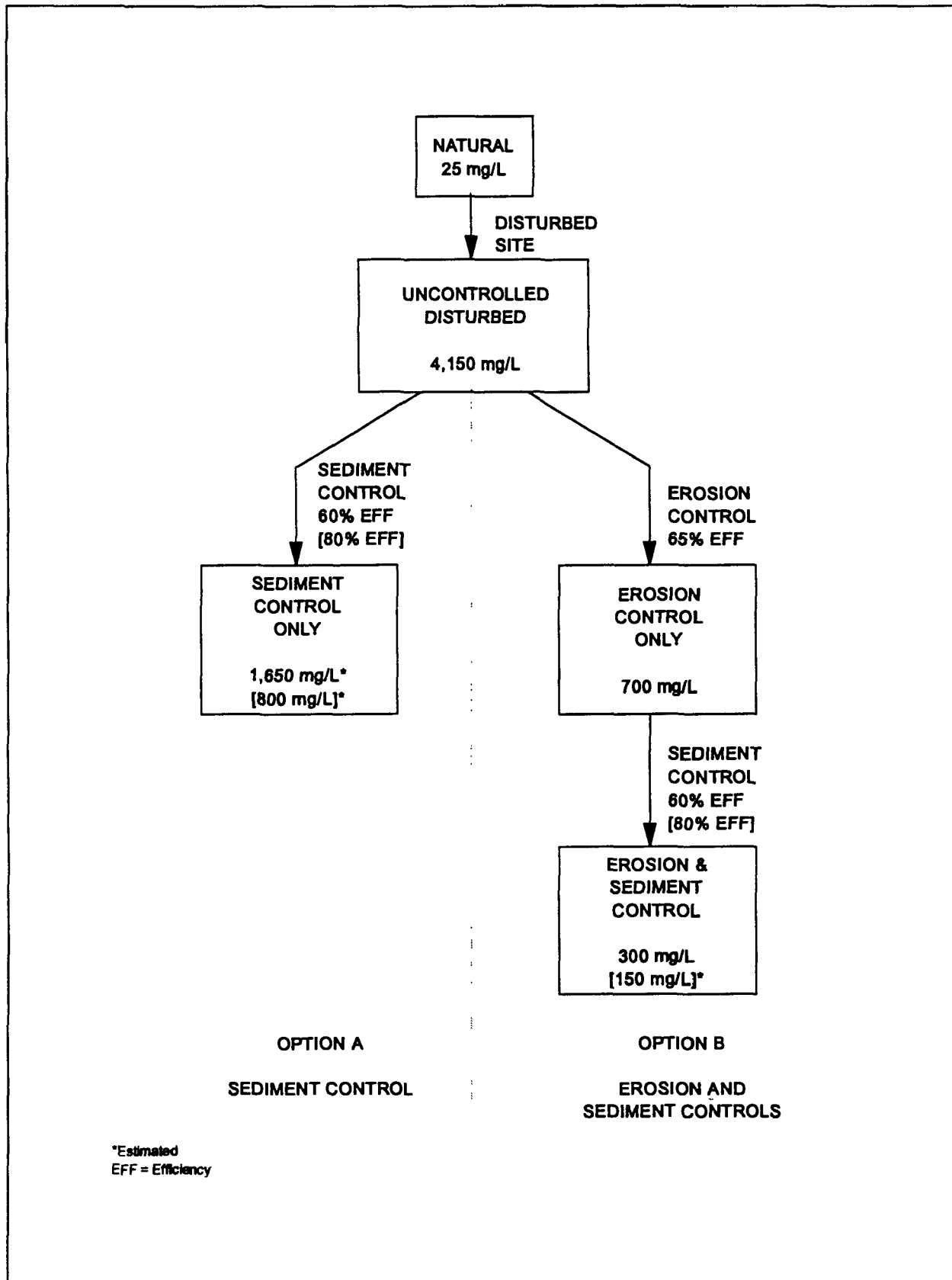

Figure 4-7. TSS concentrations from Maryland construction sites (Schueler, 1987).

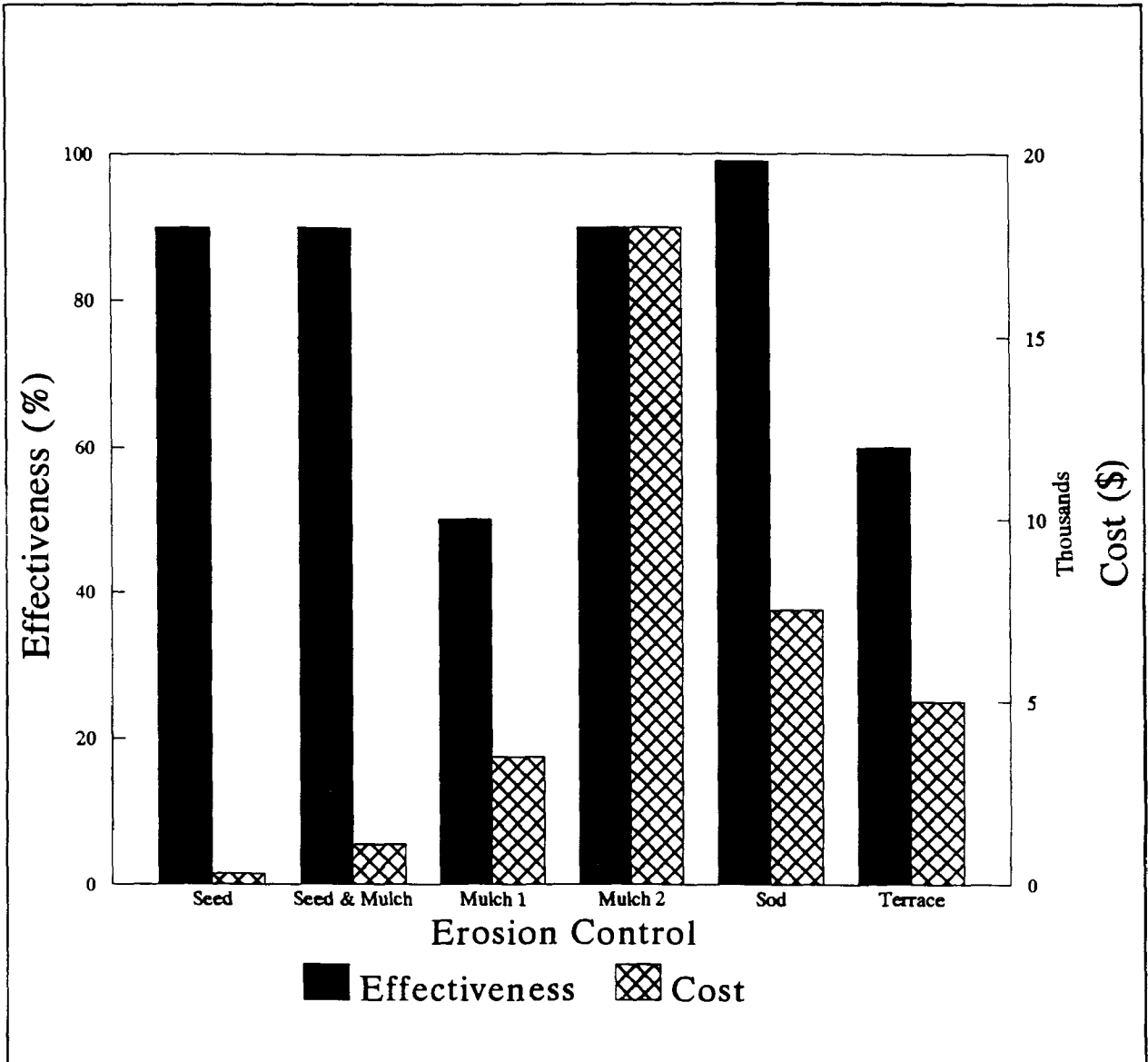

Figure 4-8. Comparison of cost and effectiveness for erosion control practices (based on information in Tables 4-15 and 4-16).

B. Construction Site Chemical Control Management Measure

- (1) Limit application, generation, and migration of toxic substances;
- (2) Ensure the proper storage and disposal of toxic materials; and
- (3) Apply nutrients at rates necessary to establish and maintain vegetation without causing significant nutrient runoff to surface waters.

1. Applicability

This management measure is intended to be applied by States to all construction sites less than 5 acres in area and to new, resurfaced, restored, and reconstructed road, highway, and bridge construction projects. This management measure does not apply to: (1) construction of a detached single family home on a site of 1/2 acre or more or (2) construction that does not disturb over 5,000 square feet of land on a site. (NOTE: All construction activities, including clearing, grading, and excavation, that result in the disturbance of areas greater than or equal to 5 acres or are a part of a larger development plan are covered by the NPDES regulations and are thus excluded from these requirements.) Under the Coastal Zone Act Reauthorization Amendments of 1990, States are subject to a number of requirements as they develop coastal NPS programs in conformance with this management measure and will have flexibility in doing so. The application of management measures by States is described more fully in *Coastal Nonpoint Pollution Control Program: Program Development and Approval Guidance*, published jointly by the U.S. Environmental Protection Agency (EPA) and the National Oceanic and Atmospheric Administration (NOAA) of the U.S. Department of Commerce.

2. Description

The purpose of this management measure is to prevent the generation of nonpoint source pollution from construction sites due to improper handling and usage of nutrients and toxic substances, and to prevent the movement of toxic substances from the construction site.

Many potential pollutants other than sediment are associated with construction activities. These pollutants include pesticides (insecticides, fungicides, herbicides, and rodenticides); fertilizers used for vegetative stabilization; petrochemicals (oils, gasoline, and asphalt degreasers); construction chemicals such as concrete products, sealers, and paints; wash water associated with these products; paper; wood; garbage; and sanitary wastes (Washington State Department of Ecology, 1991).

The variety of pollutants present and the severity of their effects are dependent on a number of factors:

- (1) **The nature of the construction activity.** For example, potential pollution associated with fertilizer usage may be greater along a highway or at a housing development than it would be at a shopping center development because highways and housing developments usually have greater landscaping requirements.
- (2) **The physical characteristics of the construction site.** The majority of all pollutants generated at construction sites are carried to surface waters via runoff. Therefore, the factors affecting runoff volume,

such as the amount, intensity, and frequency of rainfall; soil infiltration rates; surface roughness; slope length and steepness; and area denuded, all contribute to pollutant loadings.

- (3) **The proximity of surface waters to the nonpoint pollutant source.** As the distance separating pollutant-generating activities from surface waters decreases, the likelihood of water quality impacts increases.

a. Pesticides

Insecticides, rodenticides, and herbicides are used on construction sites to provide safe and healthy conditions, reduce maintenance and fire hazards, and curb weeds and woody plants. Rodenticides are also used to control rodents attracted to construction sites. Common insecticides employed include synthetic, relatively water-insoluble chlorinated hydrocarbons, organophosphates, carbamates, and pyrethrins.

b. Petroleum Products

Petroleum products used during construction include fuels and lubricants for vehicles, for power tools, and for general equipment maintenance. Specific petroleum pollutants include gasoline, diesel oil, kerosene, lubricating oils, and grease. Asphalt paving also can be particularly harmful since it releases various oils for a considerable time period after application. Asphalt overloads might be dumped and covered without inspection. However, many of these pollutants adhere to soil particles and other surfaces and can therefore be more easily controlled.

c. Nutrients

Fertilizers are used on construction sites when revegetating graded or disturbed areas. Fertilizers contain nitrogen and phosphorus, which in large doses can adversely affect surface waters, causing eutrophication.

d. Solid Wastes

Solid wastes on construction sites are generated from trees and shrubs removed during land clearing and structure installation. Other wastes include wood and paper from packaging and building materials, scrap metals, sanitary wastes, rubber, plastic and glass, and masonry and asphalt products. Food containers, cigarette packages, leftover food, and aluminum foil also contribute solid wastes to the construction site.

e. Construction Chemicals

Chemical pollutants, such as paints, acids for cleaning masonry surfaces, cleaning solvents, asphalt products, soil additives used for stabilization, and concrete-curing compounds, may also be used on construction sites and carried in runoff.

f. Other Pollutants

Other pollutants, such as wash water from concrete mixers, acid and alkaline solutions from exposed soil or rock, and alkaline-forming natural elements, may also be present and contribute to nonpoint source pollution.

Revegetation of disturbed areas may require the use of fertilizers and pesticides, which, if not applied properly, may become nonpoint source pollutants. Many pesticides are restricted by Federal and/or State regulations.

Hydroseeding operations, in which seed, fertilizers, and lime are applied to the ground surface in a one-step operation, are more conducive to nutrient pollution than are the conventional seedbed-preparation operations, in which fertilizers and lime are tilled into the soil. Use of fertilizers containing little or no phosphorus may be required by

local authorities if the development is near sensitive waterbodies. The addition of lime can also affect the pH of sensitive waters, making them more alkaline.

Improper fueling and servicing of vehicles can lead to significant quantities of petroleum products being dumped onto the ground. These pollutants can then be washed off site in urban runoff, even when proper erosion and sediment controls are in place. Pollutants carried in solution in runoff water, or fixed with sediment crystalline structures, may not be adequately controlled by erosion and sediment control practices (Washington Department of Ecology, 1991). Oils, waxes, and water-insoluble pesticides can form surface films on water and solid particles. Oil films can also concentrate water-soluble insecticides. These pollutants can be nearly impossible to control once present in runoff other than by the use of very costly water-treatment facilities (Washington Department of Ecology, 1991).

After spill prevention, one of the best methods to control petroleum pollutants is to retain sediments containing oil on the construction site through use of erosion and sediment control practices. Improved maintenance and safe storage facilities will reduce the chance of contaminating a construction site. One of the greatest concerns related to use of petroleum products is the method for waste disposal. The dumping of petroleum product wastes into sewers and other drainage channels is illegal and could result in fines or job shutdown.

The primary control method for solid wastes is to provide adequate disposal facilities. Erosion and sediment control structures usually capture much of the solid waste from construction sites. Periodic removal of litter from these structures will reduce solid waste accumulations. Collected solid waste should be removed and disposed of at authorized disposal areas.

Improperly stored construction materials, such as pressure-treated lumber or solvents, may lead to leaching of toxics to surface water and ground water. Disposal of construction chemicals should follow all applicable State and local laws that may require disposal by a licensed waste management firm.

3. Management Measure Selection

This management measure was selected based on the potential for many construction activities to contribute to nutrient and toxic NPS pollution.

This management measure was selected because (1) construction activities have the potential to contribute to increased loadings of toxic substances and nutrients to waterbodies; (2) various States and local governments regulate the control of chemicals on construction sites through spill prevention plans, erosion and sediment control plans, or other administrative devices; (3) the practices described are commonly used and presented in a number of best management practice handbooks and guidance manuals for construction sites; and (4) the practices selected are the most economical and effective.

4. Practices

As discussed more fully at the beginning of this chapter and in Chapter 1, the following practices are described for illustrative purposes only. State programs need not require implementation of these practices. However, as a practical matter, EPA anticipates that the management measure set forth above generally will be implemented by applying one or more management practices appropriate to the source, location, and climate. The practices set forth below have been found by EPA to be representative of the types of practices that can be applied successfully to achieve the management measure described above.

■ a. *Properly store, handle, apply, and dispose of pesticides.*

Pesticide storage areas on construction sites should be protected from the elements. Warning signs should be placed in areas recently sprayed or treated. Persons mixing and applying these chemicals should wear suitable protective clothing, in accordance with the law.

Application rates should conform to registered label directions. Disposal of excess pesticides and pesticide-related wastes should conform to registered label directions for the disposal and storage of pesticides and pesticide containers set forth in applicable Federal, State, and local regulations that govern their usage, handling, storage, and disposal. Pesticides and herbicides should be used only in conjunction with Integrated Pest Management (IPM) (see Chapter 2). Pesticides should be the tool of last resort; methods that are the least disruptive to the environment and human health should be used first.

Pesticides should be disposed of through either a licensed waste management firm or a treatment, storage, and disposal (TSD) facility. Containers should be triple-rinsed before disposal, and rinse waters should be reused as product.

Other practices include setting aside a locked storage area, tightly closing lids, storing in a cool, dry place, checking containers periodically for leaks or deterioration, maintaining a list of products in storage, using plastic sheeting to line the storage area, and notifying neighboring property owners prior to spraying.

■ *b. Properly store, handle, use, and dispose of petroleum products.*

When storing petroleum products, follow these guidelines:

- Create a shelter around the area with cover and wind protection;
- Line the storage area with a double layer of plastic sheeting or similar material;
- Create an impervious berm around the perimeter with a capacity 110 percent greater than that of the largest container;
- Clearly label all products;
- Keep tanks off the ground; and
- Keep lids securely fastened.

Oil and oily wastes such as crankcase oil, cans, rags, and paper dropped into oils and lubricants should be disposed of in proper receptacles or recycled. Waste oil for recycling should not be mixed with degreasers, solvents, antifreeze, or brake fluid.

■ *c. Establish fuel and vehicle maintenance staging areas located away from all drainage courses, and design these areas to control runoff.*

Proper maintenance of equipment and installation of proper stream crossings will further reduce pollution of water by these sources. Stream crossings should be minimized through proper planning of access roads. Refer to Chapter 3 for additional information on stream crossings.

■ *d. Provide sanitary facilities for construction workers.*

■ *e. Store, cover, and isolate construction materials, including topsoil and chemicals, to prevent runoff of pollutants and contamination of ground water.*

■ *f. Develop and implement a spill prevention and control plan. Agencies, contractors, and other commercial entities that store, handle, or transport fuel, oil, or hazardous materials should develop a spill response plan.*

Post spill procedure information and have persons trained in spill handling on site or on call at all times. Materials for cleaning up spills should be kept on site and easily available. Spills should be cleaned up immediately and the contaminated material properly disposed of. Spill control plan components should include:

- Stop the source of the spill.
- Contain any liquid.
- Cover the spill with absorbent material such as kitty litter or sawdust, but do not use straw. Dispose of the used absorbent properly.

■ *g. Maintain and wash equipment and machinery in confined areas specifically designed to control runoff.*

Thinners or solvents should not be discharged into sanitary or storm sewer systems when cleaning machinery. Use alternative methods for cleaning larger equipment parts, such as high-pressure, high-temperature water washes, or steam cleaning. Equipment-washing detergents can be used, and wash water may be discharged into sanitary sewers if solids are removed from the solution first. (This practice should be verified with the local sewer authority.) Small parts can be cleaned with degreasing solvents, which can then be reused or recycled. Do not discharge any solvents into sewers.

Washout from concrete trucks should be disposed of into:

- A designated area that will later be backfilled;
- An area where the concrete wash can harden, can be broken up, and then can be placed in a dumpster; or
- A location not subject to urban runoff and more than 50 feet away from a storm drain, open ditch, or surface water.

Never dump washout into a sanitary sewer or storm drain, or onto soil or pavement that carries urban runoff.

■ *h. Develop and implement nutrient management plans.*

Properly time applications, and work fertilizers and liming materials into the soil to depths of 4 to 6 inches. Using soil tests to determine specific nutrient needs at the site can greatly decrease the amount of nutrients applied.

■ *i. Provide adequate disposal facilities for solid waste, including excess asphalt, produced during construction.*

■ *j. Educate construction workers about proper materials handling and spill response procedures. Distribute or post informational material regarding chemical control.*

IV. EXISTING DEVELOPMENT

A. Existing Development Management Measure

Develop and implement watershed management programs to reduce runoff pollutant concentrations and volumes from existing development:

- (1) Identify priority local and/or regional watershed pollutant reduction opportunities, e.g., improvements to existing urban runoff control structures;
- (2) Contain a schedule for implementing appropriate controls;
- (3) Limit destruction of natural conveyance systems; and
- (4) Where appropriate, preserve, enhance, or establish buffers along surface waterbodies and their tributaries.

1. Applicability

This management measure is intended to be applied by States to all urban areas and existing development in order to reduce surface water runoff pollutant loadings from such areas. Under the Coastal Zone Act Reauthorization Amendments of 1990, States are subject to a number of requirements as they develop coastal NPS programs in conformity with this management measure and will have flexibility in doing so. The application of management measures by States is described more fully in *Coastal Nonpoint Pollution Control Program: Program Development and Approval Guidance*, published jointly by the U.S. Environmental Protection Agency (EPA) and the National Oceanic and Atmospheric Administration (NOAA).

2. Description

The purpose of this management measure is to protect or improve surface water quality by the development and implementation of watershed management programs that pursue the following objectives:

- (1) Reduce surface water runoff pollution loadings from areas where development has already occurred;
- (2) Limit surface water runoff volumes in order to minimize sediment loadings resulting from the erosion of streambanks and other natural conveyance systems; and
- (3) Preserve, enhance, or establish buffers that provide water quality benefits along waterbodies and their tributaries.

Maintenance of water quality becomes increasingly difficult as areas of impervious surface increase and urbanization occurs. For the purpose of this guidance, urbanized areas are those areas where the presence of "man-made" impervious surfaces results in increased peak runoff volumes and pollutant loadings that permanently alter one or

more of the following:⁵ stream channels, natural drainageways, and in-stream and adjacent riparian habitat so that predevelopment aquatic flora and fauna are eliminated or reduced to unsustainable levels and predevelopment water quality has been degraded. Increased bank cutting, streambed scouring, siltation damaging to aquatic flora and fauna, increases in water temperature, decreases in dissolved oxygen, changes to the natural structure and flow of the stream or river, and the presence of anthropogenic pollutants that are not generated from agricultural activities, in general, are indications of urbanization.

The effects of urbanization have been well described in the introduction to this chapter. Protection of water quality in urbanized areas is difficult because of a range of factors. These factors include diverse pollutant loadings, large runoff volumes, limited areas suitable for surface water runoff treatment systems, high implementation costs associated with structural controls, and the destruction or absence of buffer zones that can filter pollutants and prevent the destabilization of streambanks and shorelines.

As discussed in Section II.B of this chapter, comprehensive watershed planning facilitates integration of source reduction activities and treatment strategies to mitigate the effects of urban runoff. Through the use of watershed management, States and local governments can identify local water quality objectives and focus resources on control of specific pollutants and sources. Watershed plans typically incorporate a combination of nonstructural and structural practices.

An important nonstructural component of many watershed management plans is the identification and preservation of buffers and natural systems. These areas help to maintain and improve surface water quality by filtering and infiltrating urban runoff. In areas of existing development, natural buffers and conveyance systems may have been altered as urbanization occurred. Where possible and appropriate, additional impacts to these areas should be minimized and if degraded, the functions of these areas restored. The preservation, enhancement, or establishment of buffers along waterbodies is generally recommended throughout the section 6217 management area as an important tool for reducing NPS impacts. The establishment and protection of buffers, however, is most appropriate along surface waterbodies and their tributaries where water quality and the biological integrity of the waterbody is dependent on the presence of an adequate buffer/riparian area. Buffers may be necessary where the buffer/riparian area (1) reduces significant NPS pollutant loadings, (2) provides habitat necessary to maintain the biological integrity of the receiving water, and (3) reduces undesirable thermal impacts to the waterbody. For a discussion of protection and restoration of wetlands and riparian areas, refer to Chapter 7.

Institutional controls, such as permits, inspection, and operation and maintenance requirements, are also essential components of a watershed management program. The effectiveness of many of the practices described in this chapter is dependent on administrative controls such as inspections. Without effective compliance mechanisms and operation and maintenance requirements, many of these practices will not perform satisfactorily.

Where existing development precludes the use of effective nonstructural controls, structural practices may be the only suitable option to decrease the NPS pollution loads generated from developed areas. In such situations, a watershed plan can be used to integrate the construction of new surface water runoff treatment structures and the retrofit of existing surface water runoff management systems.

Retrofitting is a process that involves the modification of existing surface water runoff control structures or surface water runoff conveyance systems, which were initially designed to control flooding, not to serve a water quality improvement function. By enlarging existing surface water runoff structures, changing the inflow and outflow characteristics of the device, and increasing detention times of the runoff, sediment and associated pollutants can be removed from the runoff. Retrofit of structural controls, however, is often the only feasible alternative for improving water quality in developed areas. Where the presence of existing development or financial constraints limits treatment options, targeting may be necessary to identify priority pollutants and select the most appropriate retrofits.

⁵ Changes resulting from dam building and "acts of God" such as earthquakes, hurricanes, and unusual natural events (e.g., a 100-year storm), as well as natural predevelopment riverine behavior that results in stream meander and deposition of sediments in sandbars or similar formations, are excluded from consideration in this definition. For additional information, refer to Chapter 6.

Once key pollutants have been identified, an achievable water quality target for the receiving water should be set to improve current levels based on an identified objective or to prevent degradation of current water quality. Extensive site evaluations should then be performed to assess the performance of existing surface water runoff management systems and to pinpoint low-cost structural changes or maintenance programs for improving pollutant-removal efficiency. Where flooding problems exist, water quality controls should be incorporated into the design of surface water runoff controls. Available land area is often limited in urban areas, and the lack of suitable areas will frequently restrict the use of conventional pond systems. In heavily urbanized areas, sand filters or water quality inlets with oil/grit separators may be appropriate for retrofits because they do not limit land usage.

3. Management Measure Selection

Components (1) and (2) of this management measure were selected so that local communities develop and implement watershed management programs. Watershed management programs are used throughout the 6217 management area although coverage is inconsistent among States and local governments (Puget Sound Water Quality Authority, 1986).

Local conditions, availability of funding, and problem pollutants vary widely in developed communities. Watershed management programs allow these communities to select and implement practices that best address local needs. The identification of priority and/or local regional pollutant reduction opportunities and schedules for implementing appropriate controls were selected as logical starting points in the process of instituting an institutional framework to address nonpoint source pollutant reductions.

Cost was also a major factor in the selection of this management measure. EPA acknowledges the high costs and other limitations inherent in treating existing sources to levels consistent with the standards set for developing areas. Suitable areas are often unavailable for structural treatment systems that can adequately protect receiving waters. The lack of universal cost-effective treatment options was a major factor in the selection of this management measure. EPA was also influenced by the frequent lack of funding for mandatory retrofitting and the extraordinarily high costs associated with the implementation of retention ponds and exfiltration systems in developed areas.

The use of retrofits has been encouraged because of proven water quality benefits. (Table 4-17 illustrates the effectiveness of structural runoff controls for developed areas and retrofitted structures.) Retrofits are currently being used by a number of States and local governments in the 6217 management area, including Maryland, Delaware, and South Carolina.

Management measure components (3) and (4) were selected to preserve, enhance, and establish areas within existing development that provide positive water quality benefits. Refer to the New Development and Site Planning Management Measures for the rationale used in selecting components (3) and (4) of this management measure.

4. Practices

As discussed more fully at the beginning of this chapter and in Chapter 1, the following practices are described for illustrative purposes only. State programs need not require implementation of these practices. However, as a practical matter, EPA anticipates that the management measure set forth above generally will be implemented by applying one or more management practices appropriate to the source, location, and climate. The practices set forth below have been found by EPA to be representative of the types of practices that can be applied successfully to achieve the management measure described above.

- a. *Priority NPS pollutants should be targeted, and implementation strategies for mitigating the effects of NPS pollutants should be developed.*
- b. *Policies, plans, and organizational structures that ensure that all surface water runoff management facilities are properly operated and maintained should be developed. Periodic monitoring and maintenance may be necessary to ensure proper operation and maintenance.*

Table 4-17. Existing Development Management Practices Effectiveness Summary

Management Practice		% Removal						Main Removal Efficiency Factors	References
		TSS	TP	TN	COD	Pb	Zn		
Water Quality Inlet - Catch Basin (1)	Average:	15	5	5	5	15	5	• Maintenance	Pitt, 1986; Field, 1985; Schueler, 1987
	Reported Range:	10-95	5-10	5-10	5-10	10-55	5-10		
	Probable Range:	10-25	5-10	5-10	5-10	10-25	5-10		
	No. Values Considered:	2	1	1	1	3	1		
Water Quality Inlet - Catch Basins With Sand Filter (1)	Average:	80	NA	35	55	80	65	• Sedimentation storage volume	Shaver, 1991
	Reported Range:	75-85	NA	30-45	45-70	70-90	50-80		
	Probable Range:	70-90	--	30-40	40-70	70-90	50-80		
	No. Values Considered:	1	0	1	1	1	1		
Water Quality Inlet - Oil/Grid Separator (1)	Average:	15	5	5	5	15	5	• Sedimentation storage volume	Pitt, 1986; Schueler, 1987
	Reported Range:	10-25	5-10	5-10	5-10	10-25	5-10		
	Probable Range:	10-25	5-10	5-10	5-10	10-25	5-10		
	Number of References	1	1	1	1	1	1		
Dry Pond Modified into Ed Dry Pond	Average:	45	25	35	20	45	20	• Storage volume • Detention time • Pond shape	MWCOG, 1983; City of Austin, 1990; Schueler and Helfrich, 1988; Pope and Hess, 1989; OWML, 1987; Welinski and Stack, 1990
	Reported Range:	5-90	10-55	20-60	0-40	25-65	(-40)-65		
	Probable Range (2):	70-90	10-60	20-60	30-40	20-60	40-60		
	No. Values Considered:	6	6	4	5	4	5		

Table 4-17. (Continued)

Management Practice	% Removal										Main Removal Efficiency Factors	References	
	TSS	TP	TN	COD	Pb	Zn							
Dry Pond Modified into Wet Pond	Average:	60	45	35	40	70	60					<ul style="list-style-type: none"> • Pool volume • Pond shape 	Wetzka and Oberta, 1988; Yoosef et al., 1986; Collum, 1985; Driscoll, 1983; Driscoll, 1986; MWCOG, 1983; OWML, 1983; Wu et al., 1988; Holter, 1987; Martin, 1988; Darmay et al., 1989; OWML, 1982; City of Austin, 1990
	Reported Range:	(-30)-91	10-85	5-85	5-90	10-95	10-95						
	Probable Range:	50-90	20-90	10-90	10-90	10-95	20-95						
	No. Values Considered:	11	10	7	4	8	7						
Dry Pond or Wet Pond Modified into ED Wet Pond	Average:	80	65	55	NA	40	20					<ul style="list-style-type: none"> • Pool volume • Pond shape • Detention time 	Ontario Ministry of the Environment, 1991
	Reported Range:	50-100	50-80	55	NA	40	20						
	Probable Range:	50-95	50-80	---	---	---	---						
	No. Values Considered:	1	1	1	0	1	1						
Streambank Stabilization	Average:	NA	NA	NA	NA	NA	NA						MWCOG, 1990
	Reported Range:	NA	NA	NA	NA	NA	NA						
	Probable Range:	--	--	--	--	--	--						
	No. Values Considered:	0	0	0	0	0	0						
Riparian Forest (assumed same as Vegetated Filter Strip)	Average:	70	50	60	70	20	50					<ul style="list-style-type: none"> • Runoff volume • Slope • Soil infiltration rates • Vegetative cover • Buffer length 	IEP, 1991; Casman, 1990; Glick et al., 1991; VADC, 1987; Minnesota CA, 1989; Schueler, 1987; Hartigen et al., 1989
	Reported Range:	20-80	30-95	40-70	60-80	20	50						
	Probable Range (3):	40-90	30-80	20-60	--	30-80	20-50						
	No. Values Considered:	6	3	2	1	2	2						

Table 4-17. (Continued)

Management Practice		% Removal						Main Removal Efficiency Factors	References
		TSS	TP	TN	COD	Pb	Zn		
Wetland (assumed same as Constructed Storm Water Wetlands)	Average:	65	25	20	50	65	35	<ul style="list-style-type: none"> • Storage volume • Detention time • Pool shape • Wetland's biota • Seasonal Variation 	Harper et al., 1986; Brown, 1985; Wotzka and Obert, 1988; Hickack et al., 1977; Barten, 1987; Meloria, 1986; Morris et al., 1981; Sherberger and Davis, 1982; ABAG, 1979; Oberts et al., 1989; Rushton and Dye, 1990; Hey and Barrett, 1991
	Reported Range:	(-20)-100	(-120)-100	(-15)-40	20-80	30-95	(-30)-80		
	Probable Range (6):	50-90	(-5)-80	0-40	---	30-95	---		
	No. Values Considered:	14	14	6	2	6	4		

- c. *Remnant pervious areas in already-built areas should be subject to enforceable preservation requirements. For example, set green space goals to promote tree plantings and pavement reclamation projects.*
- d. *Developed areas in need of local or regional structural solutions should be identified and put in priority order.*
- e. *Regional structural solutions, retrofit opportunities, and nonstructural alternatives should be identified, inventoried, and put in priority order.*
- f. *Where possible, modify existing surface water runoff management structures to address water quality.*
- g. *As capital resources allow, implement practices such as those in Table 4-17.*

5. Effectiveness Information and Cost Information

The following is a general description of various retrofit options and their effectiveness. Since each retrofit situation is different, the costs will depend on site-specific factors such as climate, drainage area, or pollutants. Table 4-17 discusses the effectiveness of several practices often implemented when correcting existing NPS pollution problems in urban areas.

a. Construction or Modification of Pollutant Removal Facilities

Many of the management practices described in Section II of this chapter cannot be used in already urbanized areas because they require space that is typically not available in urbanized areas. However, two types of pollutant removal retrofits can be used to treat runoff: new treatment facilities can be built in limited land space, and existing facilities can be modified to obtain increased water quality benefits.

New Facilities. If there is space available, the management practices described in Section II can be applied to provide water quality benefits. Typically, however, there are space constraints in urbanized areas that will not allow construction of these facilities. Water quality inlets may be appropriate in areas where space is limited and runoff from highly impervious areas such as parking lots must be treated. The effectiveness and costs of these facilities would be similar to those previously discussed. There are several types of water quality inlets—catch basins, catch basins with sand filters, and oil/grit separators. These are described in detail in Section II.

Retrofit of Existing Facilities. In the past, many surface water runoff management facilities were constructed to provide peak volume control; however, no provisions for pollutant removal were provided. These existing facilities can be modified to provide water quality benefits. Two common modifications are dry pond conversion and fringe marsh creation.

- **Dry Pond Conversion.** Many dry ponds for surface water runoff management that provide peak volume control, but no water quality benefits, have been constructed. Many of these ponds can be modified to provide water quality control. These modifications can include decreasing the size of the outlet to increase the detention of the dry pond. A dry pond's outlet may also be modified to detain a permanent pool of water and thus create a wet pond or extended detention wet pond. Prince George's County, Maryland, has a successful program for urban retrofits. They are usually off-line facilities with forebays, vegetative benches, and deeper portions for storage.
- **Fringe Marsh Creation.** Aquatic vegetation can be planted along the perimeter of constructed wet ponds or other open water systems to enhance sediment control and provide some biological pollutant uptake.

b. Stabilization of Shorelines, Stream Banks, and Channels

Urbanization can significantly increase the volume and velocity of surface water runoff that has the potential to erode streambanks and channels. This erosion can create high sediment loads in surface water. Streambanks can be stabilized by providing plantings along the streambank or by placing boulders, riprap, retaining walls, or other structural controls in eroding areas. Where feasible, vegetation and other soft practices should be used instead of hard, structural practices. See the Shoreline and Streambank Protection section of Chapter 6 for additional information.

c. Protection and Restoration of Riparian Forest and Wetland Areas

Riparian forests and wetlands are very effective water quality controls. They should be protected and restored wherever possible. Riparian forests can be restored by replanting the banks and floodplains of a stream with native species to stabilize erodible soils and improve surface water and ground water quality. Refer to Chapter 7 for additional information.

Some examples of urban watershed retrofit programs are presented below. The first case study, the Anacostia watershed, involves a developed urban area suffering from multiple NPS pollution impacts. As with many of the examples given, the project has advanced only through the planning and early implementation stages. Therefore, performance data are not currently available.

CASE STUDY 1 - ANACOSTIA WATERSHED, MARYLAND

Opportunities for urban retrofitting are limited in developed watersheds, but they can be implemented through extensive onsite evaluations. For example, between 1989 and 1991 over 125 sites in the 179-square-mile Anacostia watershed in Montgomery County, Maryland, were identified as candidates for retrofitting after extensive on-site evaluation (Schueler et al., 1991). Retrofit options developed in the watershed included source reduction, extended detention (ED) marsh ponds or ED ponds to handle the first flush, additional storage capacity in the open channel, routing of surface water runoff away from sensitive channels, diversion of the first flush to sand-peat filters, and installation of oil/grit separators in the drain network itself. The most commonly used retrofit technique in the Anacostia watershed is the retrofit of existing dry surface water runoff detention or flood control structures to improve their runoff storage and treatment capacity. Existing detention ponds are maintained by excavation, adding to the elevation of the embankment, or by construction of low-flow orifices. The newly created storage is used to provide a permanent pool, extended detention storage, or a shallow wetland. Nearly 20 such retrofits are in some stage of design or construction in the Anacostia watershed.

CASE STUDY 2 - LOCH RAVEN RESERVOIR, MARYLAND

(Stack and Belt, 1989)

Loch Raven Reservoir, a water supply reservoir serving Baltimore, Maryland, had a eutrophication problem due to excessive phosphorus loads. To address this problem, the city examined the effectiveness of its existing phosphorus controls. They found that the more than 24 extended detention dry ponds that had been originally constructed for surface water runoff management had been designed to treat the once-in-10-year or once-in-100-year flood. The extended detention ponds were thus inefficient at treating runoff from frequent storm events, and the city was receiving few water quality benefits from these structures. Modifications, or retrofits, allowed the basins to collect runoff from smaller events and reduce pollutant loadings without affecting their capacity to contain runoff from larger storms.

Difficulties in obtaining permission from private pond owners restricted the number of ponds with planned retrofits to six ponds owned by the county and one privately owned pond. Private owners were concerned about the maintenance costs associated with the retrofits. Changes to the ponds usually involved alteration of the size of the orifice of the low-flow release structure. Computer modeling was used to determine the minimum size that would not interfere with the pond's design criteria (i.e., containing the 2-, 10- and 100-year storms) while providing sufficient detention time to settle the majority of the solids in urban runoff from the more frequent storms. Each retrofit was tailored to the basin's unique outlet and site characteristics, and costs reflect the differences in approach. For example, one of the ponds was modified as a urban runoff wetland for an estimated cost of \$27,800. Retrofits of dry ponds were the least expensive, with costs of less than about \$2,000. Draining and dredging boosted the cost of retrofitting a wet pond with a clogged low-flow release structure to approximately \$13,000.

Monitoring of the performance of the retrofits during 12 storm events measured removal efficiencies for particulate matter of over 90 percent and removal efficiencies for total phosphorus of between 30 and 40 percent. All of the storms monitored were less than the 1-year storm, and detention times ranged from 1 to 5 hours. Trash debris collectors were effective at reducing clogging; thus no maintenance was necessary in the first year of operation.

CASE STUDY 3 - INDIAN RIVER LAGOON, FLORIDA

(Bennett and Heaney, 1991)

Improper surface water runoff drainage practices have degraded the quality of Florida's Indian River Lagoon by increasing the volume of freshwater runoff to the estuarine receiving water, as well as increasing the loading of suspended solids. Draining of wetlands for urban and agricultural development has led to nutrient loading in the lagoon.

The study area, typical of most Florida flatwood watersheds, was selected as a representative drainage catchment. EPA's Storm Water Management Model (SWMM) was used to summarize the relationship between catchment hydrology, channel hydraulics, and pollutant loads. The model, calibrated for the study region, was used to evaluate the effectiveness of the proposed watershed control program and to project performance levels expected after the study region becomes fully developed. The retrofit of multiple structural measures was undertaken as a demonstration-scale project. An existing trunk channel was modified to act as a wet detention basin. Flow from the trunk channel enters a partially disturbed, interdunal, freshwater wetland. The wetland system provides nutrient assimilation, additional water storage capacity, sediment attenuation, and enhanced evapotranspiration. SWMM predicted that the project will remove between 80 percent and 85 percent of the total suspended solids, depending on the level of future development. The cost of the project in 1989 dollars, including operation and monitoring costs over a 10-year period, was \$198,960.

V. ONSITE DISPOSAL SYSTEMS

A. New Onsite Disposal Systems Management Measures

- (1) Ensure that new Onsite Disposal Systems (OSDS) are located, designed, installed, operated, inspected, and maintained to prevent the discharge of pollutants to the surface of the ground and to the extent practicable reduce the discharge of pollutants into ground waters that are closely hydrologically connected to surface waters. Where necessary to meet these objectives: (a) discourage the installation of garbage disposals to reduce hydraulic and nutrient loadings; and (b) where low-volume plumbing fixtures have not been installed in new developments or redevelopments, reduce total hydraulic loadings to the OSDS by 25 percent. Implement OSDS inspection schedules for preconstruction, construction, and postconstruction.
- (2) Direct placement of OSDS away from unsuitable areas. Where OSDS placement in unsuitable areas is not practicable, ensure that the OSDS is designed or sited at a density so as not to adversely affect surface waters or ground water that is closely hydrologically connected to surface water. Unsuitable areas include, but are not limited to, areas with poorly or excessively drained soils; areas with shallow water tables or areas with high seasonal water tables; areas overlaying fractured bedrock that drain directly to ground water; areas within floodplains; or areas where nutrient and/or pathogen concentrations in the effluent cannot be sufficiently treated or reduced before the effluent reaches sensitive waterbodies;
- (3) Establish protective setbacks from surface waters, wetlands, and floodplains for conventional as well as alternative OSDS. The lateral setbacks should be based on soil type, slope, hydrologic factors, and type of OSDS. Where uniform protective setbacks cannot be achieved, site development with OSDS so as not to adversely affect waterbodies and/or contribute to a public health nuisance;
- (4) Establish protective separation distances between OSDS system components and groundwater which is closely hydrologically connected to surface waters. The separation distances should be based on soil type, distance to ground water, hydrologic factors, and type of OSDS;
- (5) Where conditions indicate that nitrogen-limited surface waters may be adversely affected by excess nitrogen loadings from ground water, require the installation of OSDS that reduce total nitrogen loadings by 50 percent to ground water that is closely hydrologically connected to surface water.

1. Applicability

This management measure is intended to be applied by States to all new OSDS including package plants and small-scale or regional treatment facilities not covered by NPDES regulations in order to manage the siting, design,

installation, and operation and maintenance of all such OSDS. Under the Coastal Zone Act Reauthorization Amendments of 1990, States are subject to a number of requirements as they develop coastal NPS programs in conformity with this management measure and will have flexibility in doing so. The application of management measure by States is described more fully in *Coastal Nonpoint Pollution Control Program: Program Development and Approval Guidance*, published jointly by the U.S. Environmental Protection Agency (EPA) and the National Oceanic and Atmospheric Administration (NOAA) of the U.S. Department of Commerce.

2. Description

The purpose of this management measure is to protect the 6217 management area from pollutants discharged by OSDS. The measure requires that OSDS be sited, designed, and installed so that impacts to waterbodies will be reduced, to the extent practicable. Factors such as soil type, soil depth, depth to water table, rate of sea level rise, and topography must be considered in siting and installing conventional OSDS.

The objective of the management measure is to prevent the installation of conventional OSDS in areas where soil absorption systems will not provide adequate treatment of effluents containing solids, phosphorus, pathogens, nitrogen, and nonconventional pollutants prior to entry into surface waters and ground water (e.g., highly permeable soils, areas with shallow water tables or confining layers, or poorly drained soils). In addition to soil criteria, setbacks, separation distances, and management and maintenance requirements need to be established to fulfill the requirements of this management measure. Guidance on design factors to consider in the installation of OSDS is available in EPA's *Design Manual for Onsite Wastewater Treatment and Disposal Systems* (1980), currently under revision. This measure also requires that in areas experiencing pollution problems due to OSDS-generated nitrogen loadings, OSDS designs should employ denitrification systems or some other nitrogen removal process that reduces total nitrogen loadings by at least 50 percent. Additionally, hydraulic loadings to OSDS can be reduced by up to 25 percent by installing low-volume plumbing fixtures and enforcing water conservation measures. Garbage disposals are to be discouraged in all new development or redevelopment where conventional OSDS are employed as another means of reducing overloading and ensure proper operation of the OSDS. Regularly scheduled maintenance and pumpout of OSDS will prolong the life of the system and prevent degradation of surface waters.

States need not conduct new monitoring programs or collect new monitoring data to determine whether ground water is closely hydrologically connected to surface water, nor are States expected to determine exactly where the resulting water quality problems are significant. Rather, States are encouraged to make reasonable determinations based upon existing information and data sources.

3. Management Measure Selection

This management measure was selected to address the proper siting, design, and installation of new OSDS in the 6217 management area. OSDS have been identified as contributors of pathogens, nutrients, and other pollutants to ground water and surface waters. Nearly all coastal States have siting regulations establishing criteria for setbacks, separation distances, and percolation rates (Myers, 1991; WCFS, 1992). However, these programs often do not adequately protect surface waters from pollutants generated by OSDS. This management measure was selected to ensure that States comprehensively control new OSDS siting, design, and installation in order to protect surface waters.

The management measure components were selected to address problems known to be associated with OSDS. These management measure components were selected because proper siting of OSDS and the use of setbacks have been identified as effective methods for reducing nutrient and pathogen loadings to ground water and surface waters. All components of this management measure were selected to direct the placement of OSDS away from areas where site conditions are inadequate to allow proper treatment to occur and areas where there is a high potential for subsequent system failures that may cause contamination of waterbodies. In addition, this management measure was selected because siting and density controls can be effective complements to denitrifying systems. However, these requirements alone are often not adequate to protect surface waters, particularly in situations where installation and

replacement of OSDS are allowed without thorough consideration of OSDS-related impacts. Periodic reevaluation of these requirements is necessary to ensure protection of surface waters.

Management measure components (1) (a) and (b) were selected to reduce occurrences of hydraulic overloading of conventional OSDS, which may result in inadequate treatment of septic system effluent and contamination of ground water or surface water. When excessive wastewater volumes are delivered to the soil absorption field, failure can occur. In addition, soil saturated with wastewater will not allow oxygen to pass into the soil. Hydraulic overloading often results from changes in water use habits, such as increased family size, the addition of new water-using appliances that require increased water consumption, or high seasonal use. New systems may fail within a few months if water use exceeds the system's capacity to absorb effluent (Mancl, 1985). Water conservation reduces the amount of water an absorption field must accept.

Since numerous States have responded to this concern by adopting low-flow plumbing fixture regulations (Table 4-18), requiring such fixtures is not unreasonable. In addition, a number of States have regulations prohibiting the installation of garbage disposals where OSDS are used. If low-flow plumbing fixtures are used, it is important that OSDS design not be modified to decrease the required septic tank size. The use of smaller septic tanks will negate the advantages of using low-flow plumbing fixtures.

For absorption fields to operate properly, they must have aerobic conditions. Jarrett et al. (1985) stated that 75 percent of the total number of soil absorption field failures could be attributed to hydraulic overloading. High-efficiency plumbing fixtures can reduce the total water load by as much as 60 percent (Jarrett et al., 1985) and reduce the chance of absorption field failure. Table 4-19 illustrates daily water use and pollutant loadings.

Management measure component (5) was selected to abate OSDS nitrogen loadings to surface waters where nitrogen is a cause of surface water degradation. The Chesapeake Bay Program (1990) found that 55 to 85 percent of the nitrogen entering a conventional OSDS can be discharged into ground water. Conventional septic systems account for 74 percent of the nitrogen entering Buttermilk Bay (at the northern end of Buzzard's Bay) in Massachusetts (Horsely Witten Hegeman, 1991). A study of nitrogen entering the Delaware Inland Bays found that a significant portion of the total pollutant load could be attributed to septic systems. The study determined that septic systems accounted for 15 percent, 16 percent, and 11 percent of the nitrogen inputs to Assawoman, Indian River, and Rehoboth Bays, respectively (Reneau, 1977; Ritter, 1986). Alternatives to conventional OSDS that can substantially reduce nitrogen loadings are available.

In 1980, EPA developed a design manual for onsite wastewater treatment and disposal systems. An update of this document is being prepared.

4. Practices

As discussed more fully at the beginning of this chapter and in Chapter 1, the following practices are described for illustrative purposes only. State programs need not require implementation of these practices. However, as a practical matter, EPA anticipates that the management measure set forth above generally will be implemented by applying one or more management practices appropriate to the source, location, and climate. The practices set forth below have been found by EPA to be representative of the types of practices that can be applied successfully to achieve the management measure described above.

Many of the following practices involve siting and locating OSDS within the 6217 management area. They address issues such as minimum lot size, depth to water table, and site-specific characteristics such as soil percolation rate. Table 4-20 illustrates the variability in State and local requirements for siting of OSDS. The practices were developed to address the issue of siting OSDS given the variable nature of this activity.

- a. *Develop setback guidelines and official maps showing areas where conditions are suitable for conventional septic OSDS installation.*

**Table 4-18. States That Have Adopted Low-Flow Plumbing Fixture Regulations
(In gallons per flush for toilets and gallons per minute for other fixtures)
(Small Flows Clearinghouse, 1991)^a**

State	Effective Date	Water Closets	Urinal	Shower Heads	Lavatory Faucets	Kitchen Faucets
California	01/01/92	1.6	1.0	2.5 @ 80 psi	2.2 @ 60 psi	2.2 @ 60 psi
Colorado	01/01/90	3.5		3.0 @ 80 psi	2.5 @ 80 psi	2.5 @ 80 psi
Connecticut	10/01/90 01/01/92	1.6	1.0	2.5	2.5	2.5
Delaware	07/01/91	1.6	1.5	3.0 @ 80 psi	3.0 @ 80 psi	3.0 @ 80 psi
Georgia						
Residential	04/01/92	1.6	1.0	2.5 @ 60 psi	2.0	2.5
Commercial	07/01/92	1.6	1.0	2.5 @ 60 psi	2.0	2.5
Massachusetts	03/02/89 01/01/88 09/01/91	1.6 (1-piece) 1.6 (all others)	1.5	 3.0		
New Jersey	07/01/91	1.6	1.5	3.0	3.0	3.0
New York	1980 01/26/88 01/01/91 01/01/92		 1.0	 3.0 @ psi	 2.0	 3.0
Oregon	07/01/93	1.6	1.0	2.5	2.5	2.5
Rhode Island	09/01/90 03/01/91	1.6 (2-piece) 1.6 (all others)	 1.0	2.5 @ 80 psi	2.0 @ 80 psi	2.0 @ 80 psi
Texas	01/01/92	1.6 ^b	1.0	2.75 @ 80 psi	2.2 @ 60 psi	2.2 @ 60 psi
Washington	07/01/93	1.6	1.0	2.5 @ 80 psi	2.5 @ 80 psi	2.5 @ 80 psi

psi = pounds per square inch.

^a Information provided by Judith L. Ranton, City of Portland, Oregon, Bureau of Water Works.

^b 2.0 gallons or flow rate for ANSI ultra-low flush toilets, whichever is lowest for wall-mounted with flushometers.

Table 4-19. Daily Water Use and Pollutant Loadings by Source (USEPA, 1980)

Water Use	Volume (L/capita)	BOD (g/capita)	SS (g/capita)	Total N (g/capita)	Total P (g/capita)
Garbage Disposal	4.54	10.8	15.9	0.4	0.6
Toilet	61.3	17.2	27.6	8.6	1.2
Basins and Sinks	84.8	22.0	13.6	1.4	2.2
Misc.	25.0	0	0	0	0
Total	175.6	50.0	57.0	10.4	3.5

L = liters

g = grams

Both conventional and alternative OSDS usually include a soil absorption field. These absorption fields require a certain minimum area of soil surrounding the system to effectively remove pathogens and other pollutants. Setbacks from wells, surface waters, building foundations, and property boundaries are necessary to minimize the threat to public health and the environment. The setback should be based on soil type, slope, presence and character of the water table (as defined on a map developed by the implementing agency), and the type of OSDS. Setback guidelines should be set for both traditional and alternative OSDS. The *Design Manual for Onsite Wastewater Treatment and Disposal Systems* (USEPA, 1980) recommends the following setbacks for soil absorption systems, although other increased setbacks may be necessary to protect ground water and surface waters from viral and bacteria transport to account for tidal influences and accommodate sea level rise. (NOTE: Setback distance requirements may vary considerably based on local soil conditions and aquifer properties):

Water supply wells	50 to 100 feet
Surface waters, springs	50 to 100 feet
Escarments	10 to 20 feet
Boundary of property	5 to 10 feet
Building foundations	10 to 20 feet (30 feet when located up-slope from a building in slowly permeable soils)

For mound systems, the mound perimeter requires down-slope setbacks to make certain that the basal area of the mound is sufficient to absorb the wastewater before it reaches the perimeter of the mound to avoid surface seepage. The *Design Manual for Onsite Wastewater Treatment and Disposal Systems* (USEPA, 1980) provides guidance on setbacks for mound systems.

- *b. OSDS should be sited, designed, and constructed so that there is sufficient separation between the soil absorption field and the seasonal high water table or limiting layer, depending on site characteristics, including but not limited to hydrology, soils, and topography.*

Studies have shown that at least 4 feet of unsaturated soil below the ponded liquid in a soil absorption field is necessary to (1) remove bacteria and viruses to an acceptable level, (2) remove most organics and phosphorus, and (3) nitrify a large portion of the ammonia (University of Wisconsin, 1978). The majority of coastal States already require a minimum separation distance of at least 2 feet (Woodward-Clyde, 1992). Massachusetts requires a minimum separation of 4 feet; 5 feet is required by towns with sensitive surface waters. Several towns on Cape Cod have adopted 5 feet as the minimum. A prescribed minimum distance is necessary to prevent contaminants from directly entering ground water and surface waters. Areas with rapid soil permeabilities (e.g., a percolation rate of less than 5 minutes/inch) may require a greater separation distance. However, because of local variation, these numbers are provided only as guidance.

A study on a barrier island of North Carolina (Carlile et al., 1981) found high concentrations of nitrogen, phosphorus, and pathogens in shallow ground-water wells located beneath septic system soil absorption fields. These high concentrations were suspected to be the result of inadequate separation distance to the water table. Further analysis revealed that, at the design loading rate, a greater separation distance reduced the ground-water concentration of indicator organisms from 4.6 to 2.3 logs, and phosphorus by 93 percent. Nitrogen levels were also reduced, but this improvement (10 percent) was not as dramatic as that observed for bacteria and phosphorus.

- *c. Require assessments of site suitability prior to issuing permits for OSDS.*

Site assessments should be performed to determine the soil infiltration rate, soil pollutant removal capacity, acceptable hydraulic loading rate, and depth to the water table prior to issuing permits for OSDS. Percolation tests are usually performed to determine the soil infiltration rate. However, Hill and Frink (1974) stated that percolation tests are often performed improperly and system failures have resulted from improper siting and inadequate percolation rates. In addition, regulatory values based on acceptable percolation rates vary considerably (e.g., Delaware - 6 to 60 min/in; Georgia - 50 to 90 min/in; Michigan - 3 to 60 min/in; and Virginia - 5 to 120 min/in).

Table 4-20. Example Onsite Sewage Disposal System Siting Requirements

State	OSDS Siting Requirement
Florida	With respect to ground-water movement, the State requires that onsite systems must be placed no closer than 75 ft from a private potable water well, 100 ft from a public drinking water well, and 200 ft from a public drinking water well serving a facility with an estimated sewage flow of more than 2,000 gallons per day. Systems must not be located within 5 ft of building foundations or laterally within 75 ft of the mean high water line. Subdivisions and lots where each lot has a minimum area of at least 1/2 acre and either a minimum dimension of 100 ft or a mean of at least 100 ft from the street may be developed with private potable wells or wells serving water systems and onsite sewage disposal systems.
Massachusetts	The State requires that no septic tank shall be closer than 10 ft and no leaching facility shall be closer than 20 ft to surface water supplies; no septic tank shall be closer than 25 ft and no leaching facility shall be closer than 50 ft to watercourses. Onsite systems must be at least 4 ft above ground water.
South Carolina	No State requirement. County requirements vary. For example, the County of Charleston recommends a minimum lot size of 12,500 ft ² with a 70-ft front on lots with public water supplies and 30,000 ft ² with a 100-ft front for lots with private water supplies.
Virginia	The Chesapeake Bay Act requires that no sewage system shall be placed within 25 ft of a Resource Preservation Watercourse or within 100 ft of a Resource Management Watercourse. In the event that these requirements cannot be met, the State requires minimum setbacks of 70 ft for shellfish waters, 50 ft for impounded surface waters, and 50 ft for streams.
Washington	The State requires a 1/2- to 1-acre minimum lot size, dependent upon soil type, for areas served by public water supplies and a 1- to 2-acre minimum lot size for septic tank siting, dependent upon soil type, for individual areas served by water supplies and private wells.
Wisconsin	The State requirements of lot areas and widths vary according to percolation rate (measured as time required to percolate 1 inch). For example, for a lot with a private water supply system and a percolation rate of under 10 minutes, a minimum lot area of 20,000 ft ² , a minimum average lot width of 100 ft, and a minimum continuous suitable soil area of 10,000 ft ² are required before an OSDS can be sited. For areas served by a community water supply system, a lot with a percolation rate of under 10 minutes requires a minimum lot area of 12,000 ft ² , a minimum average lot width of 75 ft, and a minimum continuous suitable soil area of 6,000 ft ² .

(Woodward-Clyde, 1992). States such as Florida and Mississippi require soil evaluations to determine the suitability of an absorption field. A soil evaluation should also be used in conjunction with percolation test results to determine whether a site is acceptable, and soil percolation requirements should be phased out, if appropriate. These evaluations should examine the organic content of the soil, the grain size distribution, and the structure of the soil. In addition, hydraulic loading should be evaluated to determine the suitability of a site for septic tank use.

A system such as DRASTIC methodology (USEPA, 1987) can also be used to map areas where aquifers may be vulnerable to pollution from OSDS. DRASTIC considers soil permeability, depth to ground water, and aquifer characteristics.

- d. *If OSDS are sited in areas where conditions indicate that nitrogen-limited waters may be adversely affected by excessive nitrogen loading, minimize densities of development in those areas and require the use of denitrification systems.*

In areas where nitrogen is a problem pollutant, it is important to consider the density of OSDS. As the density of residences increases, lot sizes decrease and impacts (especially from nitrogen) on underlying ground water may intensify. One-half to 5-acre lots are generally the minimal requirement for siting OSDS, but the lot size may need to be larger if nitrogen is a problem pollutant. Limits on the density of absorption fields should also reflect variations in climate (Rutledge et al., undated). In Buzzards Bay, Massachusetts, a minimum lot size of 70,000 square feet was recommended as necessary to avoid nitrogen-induced degradation (Horsely Witten Hegeman, 1991). However, this practice should not preclude implementation of the use of cluster development to retain open areas necessary for controlling NPS pollution.

A number of treatment systems are known to remove nitrogen using denitrification. Such systems include sand and anaerobic upflow filters, and constructed wetlands. These systems are described in practice "f." Most of these systems require nitrification of septic tank effluent as an initial stage of the treatment process. When properly operated, these systems have been shown to have the potential to remove over 50 percent of the total nitrogen from septic tank effluent.

- e. *Develop and implement local plumbing codes that require practices that are compatible with OSDS use.*

As stated previously, the majority of OSDS soil absorption field failures are attributed to hydraulic overload. Solids loads from garbage disposals can also lead to clogging and failure of an absorption field. To address these problems, plumbing codes that minimize the potential for soil absorption field failure should be implemented.

Plumbing codes that require the use of high-efficiency plumbing fixtures in new development can reduce these water loads considerably. Such high-efficiency fixtures include toilets of 1.5 gallons or less per flush, shower heads of 2.0 gallons per minute (gpm), faucets of 1.5 gpm or less, and front-loading washing machines of up to 27 gallons per 10- to 12-pound load. Implementing these fixtures can reduce total in-house water use by 30 percent to 70 percent (*Consumer Reports* July 1990, February 1991).

- f. *In areas suitable for OSDS, select, design, and construct the appropriate OSDS that will protect surface waters and ground water.*

Selection of an OSDS should consider site soil and ground-water characteristics and the sensitivity of the receiving water(s) to OSDS effluent. Descriptions and design considerations for systems have been provided below. Table 4-21 contains available cost and effectiveness data for some of these systems. Design and operation and maintenance information on these devices can be found in *Design Manual for Onsite Wastewater Treatment and Disposal Systems* (USEPA, 1980).

Conventional Septic System. A conventional septic system consists of a settling or septic tank and a soil absorption field. The traditional system accepts both greywater (wastewater from showers, sinks, and laundry) and blackwater (wastewater from toilets). These systems are typically restricted in that the bottom invert of the absorption field must be at least 2 feet above the seasonally high water table or impermeable layer (separation distance) and the percolation rate of the soil must be between 1 and 60 minutes per inch. Also, to ensure proper operation, the tank should be pumped every 3 to 5 years. Nitrogen removal of these systems is minimal and somewhat dependent on temperature. The most common type of failure of these systems is from clogging of the absorption field, insufficient separation distance to the water table, insufficient percolation capacity of the soil, and overloading of water.

Mound Systems. Mound systems are an alternative to conventional OSDS and are used on sites where insufficient separation distance or percolation conditions exist. Mound systems are typically designed so the effluent from the

Table 4-21. OSDS Effectiveness and Cost Summary

Practice	Effectiveness ^a						Cost		References
	Water (%)	TSS (%)	BOD (%)	TN (%)	TP (%)	Path. (Logs)	Capital Cost ^b (\$/House)	Maintenance Cost ^b (\$/Year)	
Conventional Septic System									
Average	NA	72	45	28	57	3.5	\$4,500	\$70	USEPA, 1977, 1980, 1989, 1991; Sandy et al., 1988; Lamb et al., 1988; Rhode Island, 1989; Degen et al., 1991; Healy, 1982; Hanson et al., 1988; Dix, 1986; Fulhage and Day, 1988.
Probable Range	NA	60-70	40-55	10-45	30-80	3-4	\$2,000-\$8,000	\$50-\$100	
Observed Range	NA	54-83	30-60	0-58	0-95	3-4	\$2,000-\$10,000	\$25-\$110	
No. Values Considered	0	7	7	13	12	2	8	4	
Mound Systems									
Average	NA	NA	NA	44	NA	NA	\$8,300	\$180	USEPA, 1977, 1980, 1991; Small Flows Clearinghouse, undated.; Hanson et al., 1988; Degen et al., 1991.
Probable Range	NA	60-70	40-55	10-45	30-80	3-4	\$7,000-\$10,000	\$100-\$300	
Observed Range	NA	NA	NA	44-44	NA	NA	\$6,800-\$11,000	\$90-\$310	
No. Values Considered	0	0	0	1	0	0	4	4	
Low Pressure Systems									
Average	NA	NA	NA	NA	NA	NA	\$5,100	\$150	Fulhage and Day, 1988; USEPA, 1980.
Probable Range	NA	60-70	40-55	10-45	30-80	3-4	\$4,000-\$6000	\$100-\$200	
Observed Range	NA	NA	NA	NA	NA	NA	\$2,800-\$7,400	\$150-\$150	
No. Values Considered	0	0	0	0	0	0	2	1	
Anaerobic Upflow Filter									
Average	NA	44	62	59	NA	NA	\$5,550	NA	USEPA, 1991; Venhuizen, 1991; Mitchell, undated.
Probable Range	NA	30-60	50-75	40-75	60-80	3-4	\$3,000-\$8,000	\$150-\$400	
Observed Range	NA	24-89	46-84	20-75	NA	NA	\$3,000-\$8,000	NA	
No. Values Considered	0	6	6	6	0	0	2	0	
Intermittent Sand Filter									
Average	NA	92	92	55	80	3.2	\$5,400	\$275	USEPA, 1977, 1980, 1991; Small Flows Clearinghouse, undated.; Venhuizen, 1991.
Probable Range	NA	80-95	90-95	50-65	70-90	3-4	\$4,000-\$8,000	\$250-\$400	
Observed Range	NA	70-99	80-99	40-75	70-90	2-4	\$2,300-\$10,000	\$100-\$440	
No. Values Considered	0	7	10	7	2	6	7	5	

Table 4-21. (Continued)

Practice	Effectiveness ^a						Cost		References
	Water (%)	TSS (%)	BOD (%)	TN (%)	TP (%)	Path. (Logs)	Capital Cost ^b (\$/House)	Maintenance Cost ^b (\$/Year)	
Recirculating Sand Filter									
Average	NA	90	92	64	80	2.9	\$3,900	\$145	Hoxie et al., 1988; Small Flows Clearinghouse, undated.; Fulhage and Day, 1988; USEPA, 1991; Venhuizen, 1991; Swanson and Dix, 1988; Lamb et al., 1988; Laak, 1986; USEPA, 1980; Sandy et al., 1988.
Probable Range	NA	85-95	85-95	60-85	70-90	2-4	\$5,000-\$8,000	\$250-\$400	
Observed Range	NA	70-98	75-98	1-94	70-90	2-4	\$1,850-\$9,200	\$15-\$410	
No. Values Considered	0	12	15	13	2	8	5	7	
Water Separation System									
Average	NA	60	42	83	30	3	\$8,000	\$300	USEPA, 1991; USEPA, 1986; USEPA, 1980; USEPA, 1977.
Probable Range	NA	55-70	35-55	70-90	30-55	2-4	\$5,000-\$11,000	\$300-\$750	
Observed Range	NA	36-75	22-55	68-99	14-42	NA	\$5,000-\$11,000	\$300-\$300	
No. Values Considered	0	4	3	6	6	0	1	1	
Constructed Wetlands									
Average	NA	80	81	90	NA	4	\$710	\$25	Reed, 1991; Small Flows Clearinghouse, undated.; USEPA, 1980; Amberg, 1990; Dwyer et al., 1989.
Probable Range	NA	60-90	70-90	60-90	30-70	3-4	\$1,000-\$3,000	\$25-\$100	
Observed Range	NA	50-983	65-97	90-90	NA	4-4	\$50-\$350	\$25-\$25	
No. Values Considered	0		4	2	0	NA	19	1	
Cluster Systems									
Average	NA	NA	NA	NA	NA	NA	\$4,950	\$370	Decker, 1987; Small Flows Clearinghouse, undated.
Probable Range	NA	NA	NA	NA	NA	NA	\$5,000-\$7,000	\$300-\$400	
Observed Range	NA	NA	NA	NA	NA	NA	\$3,000-\$6,900	\$370-\$370	
No. Values Considered	0	NA	NA	NA	NA	NA	3	1	

Table 4-21. (Continued)

Practice	Effectiveness ^a						Cost		References
	Water (%)	TSS (%)	BOD (%)	TN (%)	TP (%)	Path. (Logs)	Capital Cost ^b (\$/House)	Maintenance Cost ^b (\$/Year)	
Eliminating Garbage Disposals									USEPA, 1980, 1986, 1991.
Average	NA	37	28	5	2.5	NA	NA	NA	
Probable Range	NA	35-40	25-30	5-10	2-3	NA	Negligible	Negligible	
Observed Range	NA	37-37	28-28	5-5	2-3	NA	NA	NA	
No. Values Considered	0	3	2	2	2	NA	NA	NA	
Low Phosphate Detergents									USEPA, 1980, 1991.
Average	NA	NA	NA	NA	50	NA	NA	NA	
Probable Range	NA	NA	NA	NA	40-50	NA	Negligible	Negligible	
Observed Range	NA	NA	NA	NA	50-50	NA	NA	NA	
No. Values Considered	0	0	0	0	2	0	0	0	
Water Conservation Fixtures									USEPA, 1977, 1980, 1991; Small Flows Clearinghouse, undated.; Jarrett et al., 1985.
Average									
Probable Range	45	NA	NA	NA	NA	NA	NA	NA	
Observed Range	25-80	NA	NA	NA	NA	NA	Varies	Negligible	
No. Values Considered	4-90	NA	NA	NA	NA	NA	NA	NA	
	11	0	0	0	0	0	0	0	
Holding Tanks									Small Flows Clearinghouse, undated.; Dix, 1986; Hanson et al., 1988.
Average	NA	NA	NA	NA	NA	NA	\$3,900	\$1,300	
Probable Range	NA	95-100	95-100	95-100	95-100	3-4	\$4,000-\$6,000	\$1,000-\$2,000	
Observed Range	NA	NA	NA	NA	NA	NA	\$1,220-\$6,670	\$100-\$2,400	
No. Values Considered	0	0	0	0	0	0	8	12	

NA - Not available.

^a Effectiveness values reflect total system reductions including soil absorption fields.^b Costs are in 1988 equivalent dollars, and an average household with four occupants was assumed.

septic tank is routed to a dosing tank and then pumped to a soil absorption field that is located in elevated sand fill above the natural soil surface. There is evidence suggesting that pressure dosing provides more uniform distribution of effluent throughout the absorption field and may result in marginally better performance. A major limitation to the use of mounds is slope. In Pennsylvania, elevated sand mound beds are permitted only in areas with slopes less than 8 percent (Mancl, 1985).

Where adequate area is available for subsurface effluent discharge, and permanent or seasonal high ground water is at least 2 feet below the surface, the elevated sand mound may be used in coastal areas. This system can treat septic tank effluent to a level that usually approaches primary drinking water standards for BOD₅, suspended solids, and pathogens by the time the effluent plume passes the property line for single-family dwellings. A mound system will not normally produce significant reductions in levels of total nitrogen discharged, but should achieve high levels of nitrification.

Intermittent Sand Filter. Intermittent sand filters are used in conjunction with pretreatment methods such as septic tanks and soil absorption fields. An intermittent sand filter receives and treats effluent from the septic tank before it is distributed to the leaching field. The sand filter consists of a bed (either open or buried) of granular material from 24 to 36 inches deep. The material is usually from 0.35 to 1.0 mm in diameter. The bed of granular material is underlain with graded gravel and collector drains. These systems have been shown to be effective for nitrogen removal; however, this process is dependent on temperature. Water loading recommendations for intermittent sand filters are typically between 1 and 5 gallons per day/square foot (gpd/ft²) but can be higher depending on wastewater characteristics. Primary failure of sand filters is from clogging, and the following maintenance is recommended to keep the system performing properly: resting the bed, raking the surface layer, or removing the top surface medium and replacing it with clean medium. In general, the filters should be inspected every 3 to 4 months to ensure that they are operating properly (Otis, undated).

Intermittent sand filters are used for small commercial and institutional developments and individual homes. The size of the facility is limited by land availability. The filters should be buried in the ground, but may be constructed above ground in areas of shallow bedrock or high water tables. Covered filters are required in areas with extended periods of subfreezing weather. Excessive long-term rainfall and runoff may be detrimental to filter performance, requiring measures to divert water away from the system (USEPA, 1980).

Recirculating Sand Filter. A recirculating sand filter is a modified intermittent sand filter in which effluent from the filter is recirculated through the septic tank and/or the sand filter before it is discharged to the soil absorption field. The addition of the recirculation loop in the system may enhance removal effectiveness and allows media size to be increased to as much as 1.5 mm in diameter and allows water loading rates in the range of 3 to 10 gpd/ft² to be used. Recirculation rates of 3:1 to 5:1 are generally recommended.

Buried or recirculating sand filters can achieve a very high level of treatment of septic tank effluent before discharge to surface water or soil. This usually means single-digit figures for BOD₅ and suspended solids and secondary body contact standards for pathogens (in practice, 100-900 per 100 ml). Dosed recycling between sand filter and septic tank or similar devices can result in significant levels of nitrification/denitrification, equivalent to between 50 and 75 percent overall nitrogen removal, depending on the recycling ratio. Regular buried or recirculating sand filters may require as much as 1 square foot of filter per gallon of septic tank effluent.

Anaerobic Upflow Filter. An anaerobic upflow filter (AUF) resembles a septic tank filled with 3/8-inch gravel with a deep inlet tee and a shallow outlet tee. An AUF system includes a septic tank, an AUF, a sand filter, and a soil absorption field. As with the sand filter, dose recycling can be used to enhance this system's performance. Hydraulic loading for an AUF is generally in the range of 3 to 15 gpd. An AUF resembles a septic tank or the second chamber of a dual-chambered tank. It should be sized to allow retention times between 16 and 24 hours. There is a high degree of removal of suspended solids and insoluble BOD. Dosed recycling between sand filter and AUF can result in 60 to 75 percent overall nitrogen removal.

A growing body of data at the University of Arkansas and elsewhere suggests that an AUF can provide further treatment of septic tank effluent before discharge to a sand filter. This treatment allows a drastic reduction (by a factor of 8 to 20) in the size of sand filter needed to attain the performance described above, with major reductions in cost (Krause, 1991).

Trenches and Beds. Trenches are typically 1 to 3 feet wide and can be greater than 100 feet long. Infiltration occurs through the bottom and sides of the trench. Each trench contains one distribution pipe, and there may be multiple trenches in a single system. Like conventional septic systems, they require 2 to 4 feet between the bottom of the system and the seasonally high water table or bedrock, and are best suited in sandy to loamy soils where the infiltration rate is 1 to 60 minutes per inch. Gravelly soils or poor-permeability soils (60 to 90 minutes per inch) are not suitable for trench systems. However, where the infiltration rate is greater than 1 minute per inch, 6 inches of loamy soil can be added around the system to create the proper infiltration rate (Otis, undated).

Beds are similar to trenches except that infiltration occurs only through the bottom of the bed. Beds are usually greater than 3 feet wide and contain one distribution pipe per bed. Single beds are commonly used; however, dual beds may be installed and used alternately. The same soil suitability conditions that apply to trenches apply to bed systems.

Trenches are often preferred to beds for a few reasons. First, with equal bottom areas, trenches have five times the sidewall area for effluent absorption; second, there is less soil damage during the construction of trenches; and third, trenches are more easily used on sloped sites.

The effluent from trenches or beds can be distributed by gravity, dosing, or uniform application. Dosing refers to periodically releasing the effluent using a siphon or pump after a small quantity of effluent has accumulated. Uniform application similarly stores the effluent for a short time, after which it is released through a pressurized system to achieve uniform distribution over the bed or trench. Uniform application results in the least amount of clogging.

Maintenance of trenches and beds is minimal. Dual trench or bed systems are especially effective because they allow the use of one system while the other rests for 6 months to a year to restore its effectiveness (Otis, undated).

Water Separation System. A water separation system separates greywater and blackwater. The greywater is treated using a conventional septic system, and the blackwater is contained in a vault/holding tank. The blackwater is later hauled off site for disposal.

For extreme situations or for seasonal residents, some form of separation of toilet wastes from bath and kitchen wastes may be helpful. Most nitrogen discharges in residential wastewater come from human urine. A very efficient toilet (0.8 gallon per flush), if routed to a separate holding tank, would need pumping only three or four times per year even for a family of four permanent residents.

Constructed Wetlands. Constructed wetlands are usually used for polishing of septage effluent that has already had some degree of treatment (processing through a septic tank or other aggregated system). The performance of constructed wetlands will be degraded in colder climates during winter months because of plant die-off and reduction in the metabolic rate of aquatic organisms.

Cluster Systems. For the purposes of this guidance, a cluster system can be defined as a collection of individual septic systems where primary treatment of septage occurs on each site and the resulting effluent is collected and treated to further reduce pollutants. Additional treatment may involve the use of sand filters or AUF, constructed wetlands, chemical treatment, or aerobic treatment. The use of cluster systems may provide advantages due to increased treatment capability and economy of scale.

Evapotranspiration (ET) and Evapotranspiration/Absorption (ETA) Systems. ET and ETA systems combine the process of evaporation from the surface of a bed and transpiration from plants to dispose of wastewater. The

wastewater would require some form of pretreatment such as a septic tank. An ET bed usually consists of a liner, drainfield tile, and gravel and sand layers. ET and ETA systems are useful where soils are unsuitable for subsurface disposal, where the climate is favorable to evaporation, and where ground-water protection is essential. In both types of systems, distribution piping is laid in gravel, overlain by sand, and planted with suitable vegetation. Plants can transpire up to 10 times the amount of water evaporated during the daytime. For an ET system to be effective, evaporation must be equal to or greater than the total water input to the system because it requires an impermeable seal around the system. In the United States, this limits use of ET systems to the Southwest. The size of the system depends on the quantity of effluent inflow, precipitation, the local evapotranspiration rate, and soil permeability (Otis, undated). Data were unavailable on this BMP, so its cost and effectiveness were not evaluated.

Vaults or Holding Tanks. Vaults or holding tanks are used to containerize wastewater in emergency situations or other temporary functions. This technology should be discouraged because of high anticipated overloads due to difficult pumping logistics. Such systems require frequent pumping, which can be expensive.

Fixed Film Systems. A fixed film system employs media to which microorganisms may become attached. Fixed film systems include trickling filters, upflow filters, and rotating biological filters. These systems require pretreatment of sewage in a septic tank; final effluent can be discharged to a soil absorption field. Cost and effectiveness data for this BMP were not available.

Aerobic Treatment Units. Aerobic treatment units can be employed on site. A few systems are available commercially that employ various types of aerobic technology. However, these systems require regular supervision and maintenance to be effective. They require pretreatment by a septic tank, and effluent can be discharged to a soil absorption field. Power requirements can be significant for certain types of these packages. Cost and effectiveness data for this BMP were not available.

Sequencing Batch Reactor. A sequencing batch reactor is a modified conventional continuous-flow activated sludge treatment system. Conventional activated sludge systems treat wastewater in a series of separate tanks. Sequencing batch reactors carry out aeration and sedimentation/clarification simultaneously in the same tank. They are designed for the removal of biochemical oxygen demand (BOD) and total suspended solids (TSS) from typical municipal and industrial wastewater at flow rates of less than 5 MGD. Modification to the design of the basic system allows for nitrification and denitrification and for the removal of biological phosphorus to occur.

The sequencing batch reactor is particularly suitable for small flows and for nutrient removal. Sequencing batch reactors can be either used for new developments or connected to existing septic systems. Small reactors can be sited in areas of only a few hundred square feet. While sequencing batch reactor cost and operation and maintenance requirements are greater than those for conventional OSDS, sequencing batch reactors may be suitable alternatives for sites where high-density development and/or unsuitable soils may preclude adequate treatment of effluent.

Sequencing batch reactors can also be used where municipal and industrial wastes require conventional or extended aeration activated sludge treatment. They are most applicable at flow rates of 3000 gpd to 5 MGD but lose their cost-effectiveness at design rates exceeding 10 MGD (USEPA, 1992). Sequencing batch reactors are very useful for the pretreatment of industrial waste and for small flow applications. They are also optimally useful where wastewater is generated for less than 12 hours per day.

Disinfection Devices. In some areas, pathogen contamination from OSDS is a major concern. Disinfection devices may be used in conjunction with the above systems to treat effluent for pathogens before it is discharged to a soil absorption field. Disinfection devices include halogen applicators (for chlorine and iodine), ozonators, and UV applicators. Of these three types, halogen applicators are usually the most practical (USEPA, 1980). Installation of these devices in an OSDS increases the system's cost and adds to the system's operation and maintenance requirements. However, it may be necessary in some areas to install these devices to control pathogen contamination of surface waters and ground water.

(NOTE: The use of disinfection systems should be evaluated to determine the potential impacts of chlorine or iodine loadings. Some States, such as Maryland, have additional requirements or prohibit the use of these processes.)

Massachusetts has adopted a provision of its State Environmental Code that allows for "approval of innovative disposal systems if it can be demonstrated that their impact on the environment and hazard to public health is not greater than that of other approved systems" (310 CMR 15.18). Commonly referred to as Title 5, this legislation requires evaluation of pollutant loadings as well as management requirements prior to approval of alternative systems (Venhuizen, 1992).

- *g. Design sites so that an area for a backup soil absorption field is planned for in case of failure of the first field.*

In preparation of site plans and designs for OSDS, it is recommended that a suitable area be identified and reserved for construction of a second or replacement soil absorption field, in the event that the first fails or expansion is necessary. Oliveri and others (1981) determined that continuously loaded soil absorption fields have a finite life span and that 50 percent of all fields fail within 25 years. Consequently, dual systems or a plan for a backup system is necessary. The area for the backup soil absorption field should be located to facilitate simultaneous or alternate loading of the old and new systems. With trench systems, the area between the original trenches can serve as the replacement area as long as sufficient vertical spacing exists between the trenches.

- *h. During construction of OSDS, soils should not be compacted in the primary or the backup soil absorption field area.*

Care must be taken during the construction of OSDS so that the soil in the absorption field area is not compacted. Compaction could severely decrease the infiltration capacity of the soil and lead to failure of the absorption field.

- *i. Perform postconstruction inspection of OSDS.*

A postconstruction inspection program should be implemented to ensure that OSDS were installed properly. The inspection should ensure that design specifications were followed and that soil absorption field areas were not compacted during construction. Many local governments in Massachusetts require postconstruction inspection for OSDS (Myers, 1991).

5. Effectiveness Information and Cost Information

Cost and effectiveness data on alternative OSDS systems are presented in Table 4-21.

The availability of high-quality, water-efficient plumbing fixtures (1.6-gallon toilets, 1.5-gpm showerheads, etc.) can provide a reduction of 50 percent in residential water use and wastewater volume, at an incremental cost of only about \$20 to \$100 for new homes. For on-site treatment, the higher influent concentrations are counterbalanced by longer septic tank retention time. This water conservation can allow further reductions in the size of sand filters or other forms of treatment (Krause, 1991).

The elimination of garbage disposals will reduce hydraulic loadings to OSDS and decrease the potential for solids to clog the absorption field, as shown in Table 4-22.

Performance data on sequencing batch reactors show that typical designs can achieve BOD and TSS concentrations of less than 10 mg/L and that modified systems can denitrify to limits of 1 to 2 mg/L $\text{NH}_3\text{-N}$ (EPA, 1992). Some modified sequencing batch reactors have been shown to exhibit denitrification. Biological phosphorus removal to less than 1.0 mg/L has also been achieved (EPA, 1992).

Table 4-22. Reduction in Pollutant Loading by Elimination of Garbage Disposals

Parameter	Reduction in Pollutant Loading (%)
Suspended Solids	25-40
Biochemical Oxygen Demand	20-28
Total Nitrogen	3.6
Total Phosphorus	1.7

The costs for sequencing batch reactors, adjusted to 1991 dollars, for constructing and operating sequencing batch reactors were determined for several existing systems. The capital costs for six treatment systems were found to range from \$1.93 to \$30.69/gpd of design flow (USEPA, 1992). The operating costs for three existing systems, based on 1990 average flow rates, ranged from \$0.17/gpd to \$2.88/gpd (USEPA, 1992).

Costs for a complete mound system, including a septic tank, in the rural Midwest are typically \$7,000 installed (Krause, 1991). The cost for a residential septic tank/AUF/sand filter combination in the rural Midwest normally ranges from \$3,000 to \$4,000 (Krause, 1991). Costs for buried or recirculating sand filters depend on the filter size and the availability of sand of the proper texture. Costs for a complete system in the rural Midwest may range between \$5,000 and \$10,000 (Krause, 1991).

B. Operating Onsite Disposal Systems Management Measure

- (1) Establish and implement policies and systems to ensure that existing OSDS are operated and maintained to prevent the discharge of pollutants to the surface of the ground and to the extent practicable reduce the discharge of pollutants into ground waters that are closely hydrologically connected to surface waters. Where necessary to meet these objectives, encourage the reduced use of garbage disposals, encourage the use of low-volume plumbing fixtures, and reduce total phosphorus loadings to the OSDS by 15 percent (if the use of low-level phosphate detergents has not been required or widely adopted by OSDS users). Establish and implement policies that require an OSDS to be repaired, replaced, or modified where the OSDS fails, or threatens or impairs surface waters;**
- (2) Inspect OSDS at a frequency adequate to ascertain whether OSDS are failing;**
- (3) Consider replacing or upgrading OSDS to treat influent so that total nitrogen loadings in the effluent are reduced by 50 percent. This provision applies only:
 - (a) where conditions indicate that nitrogen-limited surface waters may be adversely affected by significant ground water nitrogen loadings from OSDS, and**
 - (b) where nitrogen loadings from OSDS are delivered to ground water that is closely hydrologically connected to surface water.****

1. Applicability

This management measure is intended to be applied by States to all operating OSDS. Under the Coastal Zone Act Reauthorization Amendments of 1990, States are subject to a number of requirements as they develop coastal NPS programs in conformity with this management measure and will have flexibility in doing so. The application of management measures by States is described more fully in *Coastal Nonpoint Pollution Control Program: Program Development and Approval Guidance*, published jointly by the U.S. Environmental Protection Agency (EPA) and the National Oceanic and Atmospheric Administration (NOAA) of the U.S. Department of Commerce. This management measure does not apply to existing conventional OSDS that meet all of the following criteria: (1) treat wastewater from a single family home; (2) are sited where OSDS density is less than or equal to one OSDS per 20 acres; and (3) the OSDS is sited at least 1,250 feet away from surface waters.

2. Description

The purpose of this management measure is to minimize pollutant loadings from operating OSDS. This management measure requires that OSDS be modified, operated, repaired, and maintained to reduce nutrient and pathogen loadings in order to protect and enhance surface waters. In the past, it has been a common practice to site conventional OSDS

in coastal areas that have inadequate separation distances to ground water, fractured bedrock, sandy soils, or other conditions that prevent or do not allow adequate treatment of OSDS-generated pollutants. Eutrophication in surface waters has also been attributed to the low nitrogen reductions provided by conventional OSDS designs.

Poorly designed or operating systems can cause ponding of partially treated sewage on the ground that can reach surface waters through runoff. In addition to oxygen-demanding organics and nutrients, these surface sources contain bacteria and viruses that present problems to human health. Viral organisms can persist in temperatures as low as -20 °F, suggesting that they may survive over winter in contaminated ice, later becoming available to ground water in the form of snowmelt (Hurst et al., undated). Although ground-water contamination from toxic substances is more often life-threatening, the majority of ground-water-related health complaints are associated with pathogens from septic tank systems (Yates, 1985).

Where development utilizing OSDS has already occurred, States and local governments have a limited capability to reduce OSDS pollutant loadings. One way to reduce the possibility of failed systems is to required scheduled pumpouts and regular maintenance of OSDS. Frequent inspections and proper operation and maintenance are the keys to achieving the most cost-effective OSDS pollutant reductions. Inspections upon resale or change of ownership of properties are also a cost-effective solution to ensure that OSDS are operating properly and meet current standards necessary to protect surface waters from OSDS-generated pollutants. Where phosphorus is a problem, phosphate bans can reduce phosphorus loadings by 14 to 17 percent (USEPA, 1992). Garbage disposal restrictions and low-volume plumbing fixtures can help ensure that conventional systems continue to operate properly. Low-volume plumbing fixtures have been shown to reduce hydraulic loadings to OSDS by 25 percent.

An option for managing and maintaining OSDS is through wastewater management utilities or districts. From a regulatory standpoint, a wastewater management program can reduce water quality degradation and save the time and money a local government or homeowner may spend maintaining and repairing systems. A variety of agencies are taking on the responsibilities of managing OSDS. Water utilities are the leading decentralized wastewater management agency (Dix, 1992). The following case studies illustrate successful wastewater management programs used where there are OSDS.

CASE STUDY 1 - GEORGETOWN DIVIDE PUBLIC UTILITIES, CALIFORNIA

The Georgetown Divide Public Utility District in California manages water reservoirs, two water treatment plants, an irrigation canal system, and two hydroelectric plants. Approximately 10 percent of the agency's resources are allocated to managing onsite systems in a large subdivision. The utility provides a comprehensive site evaluation program, designs the onsite system for each lot, lays out the system for the contractor, and makes numerous inspections during construction. There is also continued communication between the homeowners and the utility after construction, including scheduled inspections. For the service homeowners pay \$12.50 per month for management of single-family systems. Owners of undeveloped lots pay \$6.25 per month (Dix, 1992).

CASE STUDY 2 - STINSON BEACH COUNTY WATER DISTRICT, CALIFORNIA

In addition to monitoring the operation of septic tank systems, the Stinson Beach County Water District in California monitors ground water, streams, and sensitive aquatic systems that surround the coastal community to detect contamination from OSDS. Routine monitoring has identified people who use straight pipes and failures due to residents using overloaded systems. Homeowners pay a monthly fee of \$12.90, in addition to the cost of construction or repair.

3. Management Measure Selection

This management measure was selected to control OSDS-related pollutant loadings to surface waters. Numerous States have implemented inspection requirements at title transfer, low-volume plumbing fixture regulations, garbage disposal prohibitions, and other requirements. Conventional systems are designed to operate over a specified period of time. At the end of the expected life span, replacement is generally necessary. Because failures of conventional systems may occur if systems are not properly designed and maintained, it is essential that programs are established to inspect and correct failing systems and to reduce pollutant loadings, public health problems, and inconveniences. Low-flow plumbing fixture installations and garbage disposal restrictions should be encouraged because as many as 75 percent of all system failures can be attributed to hydraulic overloading (Jarrett et al., 1985). Failure occurs when a system does not provide the level of treatment that is expected from the specific OSDS design.

National and local studies have indicated that conventional OSDS experience a significant rate of failure. Failure rates typically range between 1 and 5 percent per year (De Walle, 1981). In the State of Washington, high failure rates were observed in coastal regions (failure rates in 1971: King County - 6.1 percent; Gray's Harbor - 3.3 percent; and Skagit County - 2.6 percent). It has also been estimated in various soils of Connecticut that 4 percent of conventional OSDS fail per year. The failure rate in coastal areas may be greater because many systems (such as those in North Carolina) are approved for unsuitable soil conditions (Duda and Cromartie, 1982). Jarrett and others (1985) presented suggestions from several researchers describing the possible causes of high OSDS failure rates. These suggestions include:

- Smearing of trench bottoms during construction;
- Inadequate absorption areas;
- Improperly performed percolation tests;
- Inadequate design;
- Flooding and high water tables;
- Improper construction and installation;
- Inadequate soil permeability; and
- Use of cleaners and additives.

As stated previously, conventional OSDS do not remove nitrogen effectively and OSDS nitrogen loadings have been linked to degraded surface waters and ground water (Chesapeake Bay Program, 1990).

States should consider replacement with denitrifying OSDS in areas with nitrogen-limited waters. While all OSDS should be inspected periodically (at a recommended interval of once every 3 years) and corrected if failing, requiring that denitrifying systems be installed in all cases where existing systems fail to adequately treat nitrogen was deemed unduly burdensome and impractical.

Refer to the selection statement in the New OSDS Management Measure for additional rationale for selections relating to denitrification, garbage disposals, and low-flow plumbing fixtures.

Phosphorus reductions have been implemented in a number of States (see Table 4-23). Significant reductions in phosphorus loadings (14 to 17 percent) have resulted from such phosphate reductions, with nominal increases in costs for phosphate-free detergents.

4. Practices

As discussed more fully at the beginning of this chapter and in Chapter 1, the following practices are described for illustrative purposes only. State programs need not require implementation of these practices. However, as a practical matter, EPA anticipates that the management measure set forth above generally will be implemented by applying one or more management practices appropriate to the source, location, and climate. The practices set forth below have been found by EPA to be representative of the types of practices that can be applied successfully to achieve the management measure described above.

**Table 4-23. Phosphate Limits in Detergents
(The Soap and Detergent Association, 1992)**

State	Phosphorus (P) Laundry Detergents	Phosphorus (P) Dishwashing Detergents	Industrial and Institutional	Effective Date
Connecticut	7 grams recommended use level			2/1/72
Florida	8.7% by weight as elemental P			12/31/72
Georgia	0.5% by weight as elemental P	8.7% by weight as elemental P		1/1/91
Indiana	0.5% by weight as elemental P			1/1/73
Maine	0.5% by weight as elemental P			7/1/93
Maryland	0.5% by weight as elemental P	8.7% by weight as elemental P	8.7% by weight as elemental P	12/1/85
Michigan	0.5% by weight as elemental P	8.7% by weight as elemental P	28% by weight as elemental P	10/1/77
Minnesota	0.5% by weight as elemental P	11% by weight as elemental P		8/30/79
New York	0.5% by weight as elemental P	8.7% by weight as elemental P		6/1/73
North Carolina	0.5% by weight as elemental P	8.7% by weight as elemental P		1/1/88
Oregon	0.5% by weight as elemental P	8.7% by weight as elemental P		7/1/92
Pennsylvania	0.5% by weight as elemental P	8.7% by weight as elemental P		3/1/91
South Carolina	0.5% by weight as elemental P	8.7% by weight as elemental P		1/1/92
Virginia	0.5% by weight as elemental P	8.7% by weight as elemental P		1/1/88
Wisconsin	0.5% by weight as elemental P	8.7% by weight as elemental P		1/1/84

a. Perform regular inspections of OSDS.

As previously stated, the high degree of failure of OSDS necessitates that systems be inspected regularly. This can be accomplished in several ways. Homeowners can serve as monitors if they are educated on how to inspect their own systems. Brochures can be made available to instruct individuals on how to inspect their systems and the steps they need to take if they determine that their OSDS is not functioning properly. Trained inspectors, such as those in Maine, also can aid in identifying failing systems.

State or local officials should also develop a program for regular inspection. By using utilities and wastewater management programs or agencies, the costs can be kept minimal. At a minimum, systems should be inspected when the ownership of a property is changed. If, prior to the transfer of ownership, the system is found to be deficient, corrective action should be taken. States and localities can also indirectly assess whether OSDS are failing through surface water and ground-water monitoring. If indicator pollutants (e.g., pathogens) are found during the course of monitoring, nearby OSDS should be inspected to determine whether they are the primary source of the indicators. USEPA (1991) has presented a method for tracing effluent from failing septic systems. This method could be followed as part of an indirect inspection program to locate failing systems.

■ *b. Perform regular maintenance of OSDS.*

OSDS are not maintenance-free systems. Huang (1983) stated that half of OSDS failures are due to poor operation and maintenance. Most septic tanks are designed so that wastewater is held for 24 hours to allow removal of solids, greases, and fats. Up to 50 percent of the solids retained in the tank decompose naturally by bacterial and chemical action (Mancl and Magette, 1991). However, during normal use, sludge accumulates on the bottom of the tank, leaving less time for the solids in the influent to settle. When little or no settling occurs, the solids move directly to the soil absorption system and may clog (Mancl and Magette, 1991). Consequently, periodic removal of the solids from the tank is necessary to protect the soil absorption system.

Management options for OSDS maintenance include (NSFCH, 1989):

- Maintenance via contract;
- Operating permits;
- Private management systems; and
- Local ordinances/utility management.

Most tanks need to be pumped out every 3 to 5 years; however, several factors need to be considered when determining the frequency of pumping required. These factors include (Mancl and Magette, 1991):

- Capacity of the tank;
- Flow of wastewater (based on family size); and
- Volume of solids in the wastewater (more solids are produced if a garbage disposal is used).

Failure will not occur immediately if a septic system is not pumped regularly; however, continued neglect will cause the system to fail because the soil absorption system is no longer protected from solids and may need to be replaced (at considerable expense).

Table 4-24 shows an estimate of how often a septic tank should be pumped based on tank and household size. The Arlington County, Virginia, Chesapeake Bay Preservation Ordinance requires that all septic tanks be pumped at least once every 5 years.

Alternative OSDS may have maintenance requirements in addition to septic tank pumping. These maintenance requirements are discussed in the descriptions of the systems presented in Management Measure V.A.

■ *c. Retrofit or upgrade improperly functioning systems.*

Improperly functioning systems are usually the result of failure of the soil absorption field. Several practices are available to retrofit these failing systems so that they operate properly. The most common reason for failure of the absorption field is hydraulic overload. Jarrett and others (1985) and other researchers have had good success in retrofitting failing systems by combining the construction of backup soil absorption fields with water conservation measures. A backup absorption system is constructed so that water can be diverted from the primary absorption system. The primary system is rested, and in many cases biological activity will unclog the system and aerobic conditions will be restored in the soil. Scheduling is then done to alternate the use of the primary and backup

**Table 4-24. Suggested Septic Tank Pumping Frequency (Years)
(Cooperative Extension Service - University of Maryland, 1991)**

Tank Size (gal)	Household Size (number of people)									
	1	2	3	4	5	6	7	8	9	10
500	5.8	2.6	1.5	1.0	0.7	0.4	0.3	0.2	0.1	-
750	9.1	4.2	2.6	1.8	1.3	1.0	0.7	0.6	0.4	0.3
1,000	12.4	5.9	3.7	2.6	2.0	1.5	1.2	1.0	0.8	0.7
1,250	15.6	7.5	4.8	3.4	2.6	2.0	1.7	1.4	1.2	1.0
1,500	18.9	9.1	5.9	4.2	3.3	2.6	2.1	1.8	1.5	1.3
1,750	22.1	10.7	6.9	5.0	3.9	3.1	2.6	2.2	1.9	1.6
2,000	25.4	12.4	8.0	5.9	4.5	3.7	3.1	2.6	2.2	2.0
2,250	28.6	14.0	9.1	6.7	5.2	4.2	3.5	3.0	2.6	2.3
2,500	31.9	15.6	10.2	7.5	5.9	4.8	4.0	4.0	3.0	2.6

systems (e.g., use of each system 6 months of the year), so that systems in marginally permeable soils can continue to operate properly. Garbage disposals should be eliminated, and low-volume plumbing fixtures should be installed in cases where the absorption field has failed in order to reduce total pollutant and water loads to the field. (Refer to discussion in Management Measure V.A.)

In some cases, either because of improper siting (e.g., inadequate separation distance, proximity to surface water, poor soil conditions, or lack of land available for a backup absorption system) or the inadequacy of conventional OSDS to remove pollutants of concern, the above retrofit practice may not be feasible. In these cases, alternative OSDS, constructed wetlands, filters, or holding tanks may be necessary to adequately protect surface waters or ground water. Descriptions of these systems and their respective effectiveness and cost are provided in Management Measure V.A.

- d. *Use denitrification systems where conditions indicate that nitrogen-limited surface waters may be adversely impacted by excessive nitrogen loading.*

As stated previously, even properly functioning conventional OSDS are not effective at removing nitrogen. In areas where nitrogen is a problem pollutant, existing conventional systems should be retrofitted to denitrification OSDS to provide adequate nitrogen removal. Several systems such as sand filters and constructed wetlands have been shown to remove over 50 percent of the total nitrogen from septic tank effluent (see Table 4-21). Descriptions of these types of systems and their effectiveness and cost are presented in Management Measure V.A.

- e. *Discourage the use of phosphate in detergents.*

Conventional OSDS are usually very effective at removing phosphorus. However, certain soil conditions, combined with close proximity to sensitive surface waters, can result in phosphorus pollution problems from OSDS. In such cases the use of detergents containing phosphates may need to be discouraged or banned. Low-phosphate detergents are commercially available from a variety of manufacturers with negligible increases in cost. Eliminating phosphates from detergent can reduce phosphorus loads to OSDS by 40 to 50 percent (USEPA, 1980).

■ *f. Eliminate the use of garbage disposals.*

As presented in Table 4-22, eliminating the use of garbage disposals can significantly reduce the loading of suspended solids and BOD to OSDS. Total nitrogen and phosphorus loads may also be slightly reduced because of decreased loadings of vegetative matter and foodstuffs. Eliminating garbage disposals can also reduce the buildup of solids in the septic tank and reduce the frequency of pumping required. Reduction of the solids also provides added protection against clogging of the soil absorption system.

■ *g. Discourage or ban the use of acid and organic chemical solvent septic system additives.*

Organic solvents used as septic system cleaners are frequently linked to pollution from septic systems. Many brands of septic system cleaning solvents are currently on the market. Makers of these solvents, which often contain halogenated and aromatic hydrocarbons, advertise that they reduce odors, clean, unclog, and generally enhance septic system operations. Manufacturers also advertise that cleaning solvents provide an alternative to periodic pumping of septage from septic tanks. However, there is little evidence indicating that these cleaners perform any of the advertised functions. In fact, their use may actually hinder effective septic system operation by destroying useful bacteria that aid in the degradation of waste, resulting in disrupted treatment activity and the discharge of contaminants.

In addition, since the organic chemicals in the solvents are highly mobile in the soils and toxic (some are suspected carcinogens), they can easily contaminate ground water and surface waters and threaten public health. Research on the common septic system cleaner constituents (methylene chloride (MC) and 1,1,1-trichloroethane (TCA), which are listed on EPA's priority pollutant list and for which EPA's Office of Drinking Water has issued health advisories) has shown that application rates recommended by the manufacturer have resulted in high MC and moderate TCA discharges to ground water.

This issue is discussed further in the pollution prevention section.

■ *h. Promote proper operation and maintenance of OSDS through public education and outreach programs.*

This practice is discussed in the pollution prevention section (Section VI).

VI. POLLUTION PREVENTION

A. Pollution Prevention Management Measure

Implement pollution prevention and education programs to reduce nonpoint source pollutants generated from the following activities, where applicable:

- The improper storage, use, and disposal of household hazardous chemicals, including automobile fluids, pesticides, paints, solvents, etc.;
- Lawn and garden activities, including the application and disposal of lawn and garden care products, and the improper disposal of leaves and yard trimmings;
- Turf management on golf courses, parks, and recreational areas;
- Improper operation and maintenance of onsite disposal systems;
- Discharge of pollutants into storm drains including floatables, waste oil, and litter;
- Commercial activities including parking lots, gas stations, and other entities not under NPDES purview; and
- Improper disposal of pet excrement.

1. Applicability

This management measure is intended to be applied by States to reduce the generation of nonpoint source pollution in all areas within the section 6217 management area. The adoption of the Pollution Prevention Management Measure does not exclude applicability of other management measures to those sources covered by this management measure. Under the Coastal Zone Act Reauthorization Amendments of 1990, States are subject to a number of requirements as they develop coastal NPS programs in conformity with this management measure and will have flexibility in doing so. The application of management measures by States is described more fully in *Coastal Nonpoint Pollution Control Program: Program Development and Approval Guidance*, published jointly by the U.S. Environmental Protection Agency (EPA) and the National Oceanic and Atmospheric Administration (NOAA) of the U.S. Department of Commerce.

2. Description

This management measure is intended to prevent and reduce NPS pollutant loadings generated from a variety of activities within urban areas not addressed by other management measures within Chapter 4. Source reduction is considered preferable over waste recycling for pollution reduction (DOI, 1991; USEPA, 1991). Everyday activities have the potential to contribute to nonpoint source pollutant loadings. Some of the major sources include households, garden and lawn care activities, turf grass management, diesel and gasoline vehicles, OSDS, illegal discharges to urban runoff conveyances, commercial activities, and pets and domesticated animals. These sources are described below. By reducing pollutant generation, adverse water quality impacts from these sources can be decreased.

a. Households

Everyday household activities generate numerous pollutants that may affect water quality. Common household NPS pollutants include paints, solvents, lawn and garden care products, detergents and cleansers, and automotive products such as antifreeze and oil. The use and disposal of these products are chronic sources of pollution (Puget Sound Water Quality Authority, 1991). Table 4-25 summarizes estimated pollutant loadings from various household chemicals that may contaminate runoff. These pollutants are typically introduced into the environment due to ignorance on the part of the user or the lack of proper disposal options. Storm drains are commonly mistaken for treatment systems, and significant loadings to waterbodies result from this misconception. Other wastes and chemicals are dumped directly onto the ground (Washington State Department of Ecology, 1990).

b. Improper Disposal of Used Oil

The improper disposal of used oil and antifreeze can significantly degrade surface waters. The Washington Department of Ecology estimated that over 4.5 million gallons of used oil are dumped in Washington State each year. Of this total, 2 million gallons eventually are discharged into the Puget Sound (USEPA, 1988). Such loadings can severely degrade surface waters. One quart of oil can contaminate up to 2 million gallons of drinking water; 4 quarts of oil can form an oil slick approximately 8 acres in size (University of Maryland Cooperative Extension Service, 1987).

Table 4-25. Estimates of Improperly Disposed Used Oil and Household Hazardous Waste

Reference	Chemical and Estimated Amount
USEPA, 1989	Estimated that 40% of used oil from DIYs ^a is poured onto roads, driveways, or yards or into storm sewers (80 million gallons per year).
Hoffman et al., 1980	Survey of Providence, RI, residents revealed that 35% were DIYs. Of this group, 42% used improper disposal methods (30% disposed of used oil by backyard dumping, 7% by dumping into sewers or storm drains, and 5% by pouring onto roads).
Stanek et al., 1987	Survey of Massachusetts households revealed that one-third changed their oil (17% dumped used oil on the ground and 3% discharged used oil into the town sewers); 17% changed their antifreeze (54% used ground disposal and 14% discharged into the sewer). The majority of the 10% who disposed of oil-based paints or pesticides annually used improper methods.
Voorhees and Temple, Baker and Sloane, Inc., 1989	Survey of studies estimated that between 52% and 64% of private vehicle owners are DIYs. Nationally, DIYs have been estimated to generate 193 million gallons of used oil per year. Of this amount, it was estimated that 61% (118 million gallons) was improperly disposed of.
King County Solid Waste Division, 1990	Estimated that 15% to 20% of household hazardous wastes end up in storm drains or runoff. Estimated that one-third of DIYs dump used oil directly into storm drains or onto the ground.
King County Solid Waste Division, 1990	Estimated that 83% of DIYs that changed their antifreeze flushed their car radiators directly into a storm sewer or street.

^a DIYs - Do-it-yourself oil changers.

c. Landscape Maintenance and Turf Management

The care of landscaped areas, including golf courses, can contribute significantly to nonpoint source pollutant loadings. The application of fertilizers and pesticides in coastal areas can be detrimental to surface waters. After a site is developed, a significant area of maintained landscape may be regularly treated with fertilizer and pesticides. Heavily landscaped areas include residential yards, golf courses, and parks. In the coastal zone, much residential development commonly is sited on unconsolidated coastal plain with sandy soils. Where such soils are present, frequent fertilization, pesticide application, and watering must occur to maintain turf grasses. Turf management programs and landscaping ordinances that require minimum maintenance and minimum disturbance or xeriscaping can effectively reduce these loadings.

In areas where nitrogen is a problem pollutant, measures to control the introduction of nitrogen into runoff and leachate are important. Several studies have been completed that demonstrate the leaching potential of nitrogen from turf. Researchers at Cornell University found that 60 percent of nitrogen applied to turf leached to ground water (Long Island Regional Planning Board, 1984). Shultz (1989) suggests that 50 percent of the nitrogen applications are leached out and not used by plants. A study completed by Exner and others (1991) showed that as much as 95 percent of nitrate applied in late August on an urban lawn was leached below the turf grass root zone. In coastal areas, where soils are highly permeable and ground water and surface waters are hydrologically connected, reduced applications of nutrients may be necessary to control subsurface flow of nutrients into surface waters.

A recent nonpoint source loading analysis (Cahill and Associates, 1991) indicated that 10 percent of the nitrogen and 4 percent of the phosphorus applied annually in a 193-square-mile area (an area approximately 10 miles by 20 miles) of maintained landscaped residential development end up in surface waters as the result of overapplication. A total of 512.7 tons of nitrogen and 49.4 tons of phosphorus enter surface waters from this area. These estimated pollutant delivery rates are conservative. Delivery rates in coastal areas with sandy soils may be much higher. Schultz (1989) found that over 50 percent of the nitrogen in fertilizer leaches from lawns when improperly applied. In addition, the proximity of sources to waterbodies may result in increased loadings. Where waterbodies are nitrogen- or phosphorus-limited, applications of fertilizers should be reduced or prohibited. Fertilizer control programs can effectively reduce nitrogen and phosphorus loadings by encouraging the proper application of nutrients. Fertilizer costs may also be reduced.

A study in Rhode Island concluded that medium-density residential development has the highest loading factor of pesticides and fertilizers of all land uses in the State (RIDEM, 1988). These results echoed the findings of research conducted on the Chesapeake Bay watershed that identified medium- and high-density residential development as having the highest loading factors for nitrogen and phosphorus in the Bay area (Chesapeake Bay Local Advisory Committee, 1989). Table 4-26 shows a summary of results from various studies quantifying application rates of household fertilizers. Table 4-27 summarizes recommended application rates.

Home use is estimated to account for 20 percent of pesticide use in the Puget Sound area, and household users often apply pesticides excessively or in too concentrated a formulation (PSWQA, 1991). The Puget Sound Water Quality

Table 4-26. Summary of Application Rates of Fertilizers from Various Studies

Estimated Application Rates	Reference
3.3 lb/1000 ft ² (affluent areas) 1.1 lb/1000 ft ² (less affluent areas)	Cornell Water Resources Institute, 1985
2.2 lb/1000 ft ² /yr to 3.9 lb/1000 ft ² /yr	Long Island Planning Board, 1984
3.03 lb/ft ² /yr (Nitrogen) 0.77 lb/ft ² /yr (Phosphorus) (New Jersey)	Cahill and Associates, 1992

Table 4-27. Recommended Fertilizer Application Rates

Recommended Rate	Reference
Virginia - No more than 1 lb/1000 ft ² at any one time — not to exceed 3 lb/1000 ft ² /yr	Hall, personal communication, 1991; No. VA Soil and Water Conservation District, 1991; VA Cooperative Extension, 1991
Virginia — 1.5 to 2 lb/1000 ft ² /yr	Bowling, personal communication, 1991
Long Island — 1 lb/1000 ft ² /yr	Long Island Regional Planning Board, 1984
Long Island — no more than 1 lb/1000 ft ² /yr on mature lawns	Myers, 1988
General — 2 lb/1000 ft ² /yr	Shultz, 1989

Authority summarized available data in a 1990 issue paper on pesticides in the Puget Sound. This research revealed that 50 to 80 percent of all household users apply some form of pesticides for lawn and garden use. EPA Region 10 and the Puget Sound Water Quality Authority (PSWQA, 1990) reviewed data and surveyed pesticide use in 12 counties in the Puget Sound basin and concluded that household pesticide use in 1988 was greater than 213,000 pounds. Unnecessary pesticide loadings to surface waters may result from homeowner overapplication, poor knowledge of proper application techniques, or applications during grass dormancy. Both the PSWQA and the Virginia Cooperative Extension Survey (1991) have determined that such improper use commonly occurs.

Consideration of the potential for exposure and toxic effects of applied fertilizers and pesticides should be an important component of golf course policy decisions. Some of the technical issues concerning intensive management of turf grass include (1) extent of nutrient and pesticide applications, (2) chronic and acute toxicity to nontarget organisms, (3) potential for exposure of nontarget organisms to applied chemicals, (4) use of increasingly scarce water resources for irrigation, (5) potential off-site movement of fertilizers and pesticides, (6) effects of maintenance and storage facilities on soil and water quality, and (7) potential loss of and effects on wetlands resulting from construction and turf grass maintenance (Balogh and Walker, 1992).

While quantitative information is not currently available regarding the effectiveness of fertilizer and pesticide control measures, it can be assumed that application reductions will result in corresponding decreases in pollutant loadings. Table 4-28 provides guidance useful for reducing fertilizer and pesticide use. This guidance was developed by the Northern Virginia Soil and Water Conservation District, the Lake Barcroft Watershed Improvement District, the Northern Virginia Planning District Commission, and the Virginia Cooperative Extension service for use by commercial lawn care companies and households that choose to use commercial lawn care services. This advice, however, is useful for all turf grass management.

d. Yard Trimmings Management

Improper disposal of yard trimmings can lead to increased nutrient levels in runoff. Yard trimmings deposited on street corners may be washed down storm sewers and result in elevated nutrient loadings to surface waters. Proper management of yard trimmings and home composting can reduce the level of nutrients in runoff and decrease overall runoff volumes through the addition of humus to the soil. Increased levels of humus enhance soil permeability, decrease erodibility, and provide nutrients in a less soluble form than commercial fertilizers.

e. Improper Installation and Maintenance of Onsite Disposal Systems

As discussed in Section V of this chapter, failing or improperly sited or designed OSDS may contribute both pathogens and nutrients to surface waters. Many engineers, contractors, surveyors, drain-layers, sanitarians, OSDS installers, waste haulers, building inspectors, local and State officials, and owners of OSDS are insufficiently informed regarding the need for proper siting, design, and maintenance of onsite systems. While a number of States

Table 4-28. Watershed Chemical Control Standards

Nutrient and Pesticide Control Standard	Estimated Savings and Impacts
Decrease fertilizer use.	The average DIY ^a applies 2 to 4 times the desirable amount of fertilizer. By reducing fertilizer amounts, costs can be reduced accordingly.
Use phosphorus-free or low-phosphorus-content fertilizers.	Cost increases \$1.00 to \$1.50 per household where phosphate-free fertilizer are used. In the Lake Barcroft, Virginia, Water Management District, Natural Lawn estimated a 7,000-pound reduction in fall phosphorus loadings and an 80-85% decrease in spring loadings due to the use of phosphate-free fertilizers (Natural Lawn, personal communication, 1991).
Use slow-release fertilizers.	Organic fertilizers tend to be slow acting and less soluble than chemical fertilizers (Shultz, 1989). Depending on the fertilizer source, conversion to organic fertilizers would reduce costs to \$0.00 where compost from a municipal or county facility is used; costs would increase \$1.00 per 100 ft ² for the purchase of commercial organic fertilizer (Cook, 1991)
Test soils to determine appropriate application rates.	Soil tests and fertilizer recommendations range in cost from \$0.00 to \$5.00 if done by a Cooperative Extension Service. Private soil test labs may charge \$30.00 to \$45.00 for the service (Carr et al., 1991).
Stagger fertilizer applications instead of using one large application.	Excess fertilizer may leach into ground water if not utilized by plants. Plants have a limited capacity to utilize fertilizer in any one application; fertilizer costs can be reduced by staggered applications so that the bulk of available nutrients are utilized and excess fertilizers are not applied.
Spot-apply pesticides to control broad-leaved weeds.	Natural Lawn Company reports that by switching from blanket applications to spot applications of herbicides, herbicide use can be reduced 85% to 90% (Bonifant, personal communication, 1991). Volume reductions will result in a comparable cost savings.
Mow lawn at the recommended height.	Shultz (1989) and Carr (1991) suggest that proper mowing techniques result in healthier lawns and can reduce pesticide and fertilizer use.
Retain grass clippings on lawns and other areas planted with turf grass.	Research conducted by Starr and DeRoo (1981) on grass grown in low-nitrogen sandy loam soils showed that grass clippings are beneficial as fertilizer for continued grass growth. Use of clippings as fertilizer can enhance grass growth, reduce the need for additional fertilizer, and decrease total fertilizer costs. <i>(This recommendation is promoted by the Professional Lawn Care Association of America.)</i>

^a DIY - Do-it-yourself lawn caretaker.

currently license OSDS installers and waste haulers in accordance with State health standards, these licensing procedures may be out-of-date. In addition, many of these standards address only limited health-related issues and do not address the complex joint issues of water quality and public health (Myers, 1991).

Many homeowners are unaware of proper OSDS operation and maintenance principles. They often do not know how frequently their septic tanks need to be pumped, what hydraulic load their systems can accommodate, and what should or should not be disposed of in their systems (Huang, 1983). Some homeowners use septic system cleaners containing substances that may contaminate ground water, may provide little to no benefit to the OSDS, and may even be harmful to the system (RIDEM, 1988). Public education programs can help homeowners to prepare, operate, and maintain OSDS and thus help to ensure the continued pollutant removal effectiveness of the OSDS. A variety of brochures and other educational materials regarding OSDS have already been developed, and these materials have

been used in many areas to educate the general public about proper OSDS operation and maintenance (e.g., the Chesapeake Bay Region, Puget Sound). State and local agencies should make use of these materials and implement mailing and information dissemination programs. Brochures mailed to homeowners as part of general utility correspondence or as special mailings are also effective. Posters and other materials distributed at libraries can help disseminate this information to the public. Educational and outreach programs should target builders, buyers, system installation contractors, inspectors, and enforcement personnel, in addition to homeowners, realtors, and pumpers.

f. Discharges Into Storm Drains

Significant loadings of NPS pollutants enter surface waters and tributaries via illegal discharges into storm drains. The public unknowingly assumes that storm drains discharge into sanitary sewers, and materials are dumped into storm drains under the assumption that treatment will occur at the sewage treatment plant. Illicit discharges may also be a problem. Public education programs, such as storm drain stenciling, and identification of illicit discharges can be effective tools to reduce pollutant loadings. Sanitary surveys are also a useful method to help managers identify the presence and entry point(s) of illicit discharges or other sources of pollutants to storm sewer systems.

g. Litter

Litter along coastal waterways, estuaries, and inland shorelines has become a significant source of nonpoint source pollution. Litter, debris, and dumped large solid items impair coastal water quality, as well as the aesthetic and recreational value of coastal waters, and may also be a hazard to wildlife. Storm sewers have been identified as a significant source of marine debris (Younger and Hodge, 1992).

Plastics are the major debris problem in the marine environment. Plastic accounts for 59 percent of the debris collected in coastal cleanup efforts (Younger and Hodge, 1992). Other litter may also be a problem. The State Adopt-a-Highway programs have revealed that beverage cans are the item most frequently removed from the side of roads. These wastes commonly have entered surface waters via storm sewers or swale systems. During 1991-1992, participants in the Virginia Adopt-a-Highway program removed 36,000 cubic yards of debris with volunteer hours valued at \$2 million (M. Kornwolf, Virginia Dept. of Transportation, personal communication, 1992).

h. Commercial Activities

Nonpoint source runoff from commercial land areas such as shopping centers, business districts, and office parks, and large parking lots or garages may contain high hydrocarbon loadings and metal concentrations that are twice those found in the average urban area (Woodward-Clyde, 1991). These loadings can be attributed to heavy traffic volumes and large areas of impervious surface on which these pollutants concentrate (Long Island Sound Regional Planning Board, 1982). For example, contributions of lead to the Milwaukee River south watershed have been estimated as 20 to 25 percent from commercial areas and 40 to 55 percent from industrial areas (Wisconsin Department of Natural Resources, 1991). Where activities other than traffic, such as liquids storage and equipment use and maintenance, are associated with specific commercial activities, other pollutants may also be present in runoff. BMPs suited to the control of automotive-related pollutants and any other pollutants associated with specific commercial uses should be used to control their entry into surface waters.

Gas stations, in most communities, are designated as a commercial land use and are subject to the same controls as shopping centers and office parks. However, gas stations may generate high concentrations of heavy metals, hydrocarbons, and other automobile-related pollutants that can enter runoff (Santa Clara Valley Water Control District, 1992). Since gas stations have high potential loadings and pollutant profiles similar to those of industrial sites, the good housekeeping controls used on industrial sites are usually necessary.

i. Pet Droppings

Pet droppings have been found to be important contributors of NPS pollution in estuaries and bays where there are high populations of dogs. Fecal coliform and fecal streptococcal bacteria levels in runoff in several drainage basins

in Long Island, New York, can be attributed to the dog population (Long Island Regional Planning Board, 1982). Although dogs cause the more common pet droppings problem, other urban animals, such as domestic or semi-wild ducks, also contribute to NPS pollution where their populations are high enough. Eliminating or significantly reducing the quantity of pet droppings washed into storm drains and hence into surface waters can improve the quality of urban runoff. It has been estimated that for a small bay watershed (up to 20 square miles), 2 to 3 days of droppings from a population of 100 dogs contribute enough bacteria, nitrogen, and phosphorus to temporarily close a bay to swimming and shellfishing (George Heufelder, personal communication, 1992).

The Soil Conservation Service in the Nassau-Suffolk region of New York collected data indicating that domestic animals contribute BOD, COD, bacteria, nitrogen, and phosphorus to ground water and surface waters (Nassau-Suffolk Regional Planning Board, 1978). Runoff containing pet droppings has been found to be responsible for numerous shellfish bed closures in Massachusetts (George Heufelder, personal communication, 1992; Nassau-Suffolk Regional Planning Board, 1978). In New York the large populations of semi-wild White Pekin ducks contribute heavily to runoff problems, while in a Massachusetts study, dog feces alone were found to be sufficient to account for the closures.

3. Management Measure Selection

This management measure was selected to ensure that communities implement solutions that may result in behavioral changes to reduce nonpoint source pollutant loading from the sources listed in the management measure. A number of States and local communities, including Washington, Maryland, Virginia, Florida, and Alameda County, California, are using pollution prevention activities to protect or enhance coastal water quality. Such activities include public education, promotion of alternative and public transportation, proper management of maintained landscapes, pollution prevention, training and urban runoff control plans for commercial sources, and OSDS inspection and maintenance. To allow flexibility, specific controls have not been specified in the management measure. Communities may select practices that best fit local priorities and the availability of funding. In addition, flexibility is necessary to account for community acceptance, which is often the major determinant affecting whether education and outreach activities and administrative mechanisms such as certification and training requirements are practical or effective solutions.

CASE STUDY - ARLINGTON COUNTY, VIRGINIA

Arlington County, Virginia, is drafting a source control plan for "minimizing impacts on its streams, as well as impacts to the Potomac River and the Chesapeake Bay, from pollutants entering the streams from many diverse sources." The plan is aimed at implementing individual programs for controlling sources of nonpoint pollution. Projects include:

- Storm drainage master plan;
- Educational programs for lawn management;
- Evaluation of street sweeping programs;
- Stream valley stabilization and restoration;
- Evaluation of parking lot and street design requirements;
- Land use planning;
- Leaf and debris collection;
- Household hazardous waste disposal; and
- Storm drain stenciling.

4. Practices, Effectiveness Information, and Cost Information

As discussed more fully at the beginning of this chapter and in Chapter 1, the following practices are described for illustrative purposes only. State programs need not require implementation of these practices. However, as a practical matter, EPA anticipates that the management measure set forth above generally will be implemented by

applying one or more management practices appropriate to the source, location, and climate. The practices set forth below have been found by EPA to be representative of the types of practices that can be applied successfully to achieve the management measure described above.

■ *a. Promote public education programs regarding proper use and disposal of household hazardous materials and chemicals.*

Public education is an important component of this management measure. The provision of information regarding the environmental impacts of common household activities can produce long-term shifts in behavior and may result in significant reductions in household-generated pollutants. School curricula on watershed protection, including nonpoint pollution control, have been developed for elementary and secondary school education programs. An example is the program developed by the Washington State Office of Environmental Education (Puget Sound Water Quality Authority, 1989). Incorporating such programs into regular school curricula is an effective way to educate youth about the importance of environmentally conscious behavior, which in turn can help reduce the need for and cost of technology-based pollution control.

Florida developed a comprehensive Statewide plan for environmental education coordinated by its Council on Comprehensive Environmental Education to be implemented through formal and informal education programs and State agency programs. All teachers receive the training, as well as State agency personnel and school children in grades kindergarten through 12 (Florida Council on Comprehensive Environmental Education, 1987).

Public participation is an effective means of educating the public and is also necessary for successfully creating and implementing a nonpoint pollution control plan. Public involvement should be encouraged during the planning process through attendance at meetings, workshops, and private or group consultations, and by encouraging the public to comment on planning documents. Support for the documents and the plans being developed is fostered through public involvement. Newsletters are an effective means of keeping the public informed of what planning steps are being taken and how the public can become and stay involved. Metropolitan Seattle has printed an educational brochure concerning waste oil disposal in six languages in order to reach a wider audience (Washington State Department of Ecology, 1992).

■ *b. Establish programs such as Amnesty Days to encourage proper disposal of household hazardous chemicals.*

Recognizing the potential impacts for environmental degradation from the improper disposal of hazardous household materials and chemicals, many communities have implemented programs to collect these chemicals. There has been an exponential growth in the number of such collection programs since the early 1980s. Two programs were in place in 1980; 822 were in place in 1990. The most common type of collection system is a 1-day event at a temporary site (often referred to as an Amnesty Day). More local governments are beginning to sponsor these programs several times a year, and many communities are establishing permanent programs, including retail store drop-off programs, curbside collection, and mobile permanent facilities (Duxbury, 1990). Table 4-29 summarizes the cost and effectiveness of some household chemical collection programs.

In spite of relatively low participation rates, collection programs can have a significant impact on the amount of hazardous chemicals and materials entering the waste stream. It has been estimated that the amount of hazardous chemicals collected in States having approved coastal management programs was approximately 51,000 drums, or 280,500 gallons, in 1990 (extrapolated from Duxbury, 1990).

■ *c. Develop used oil, used antifreeze, and hazardous chemical recycling programs and site collection centers in convenient locations.*

Household hazardous chemical (HHC) collection programs already exist in many counties throughout the United States. Specific days are usually designated as drop-off days and are advertised through television, newspapers,

Table 4-29. Waste Recycling Cost and Effectiveness Summary

Program Description	Effectiveness	Cost
University of Alabama - Project ROSE^a <ul style="list-style-type: none"> Initiated in 1977 Focuses on used oil Includes curbside collection (as part of regular garbage pick-up), collection centers (primarily service stations), and drum placement (in more rural areas) Involves public outreach program 	Of the approximately 17 million gallons of used oil generated annually in Alabama, 8 million gallons (47 percent) was reclaimed in 1990.	Annual budget is \$80,000 (\$45,000 is spent on public education).
Sunnyvale, CA, Curbside Used Oil Collection^b <ul style="list-style-type: none"> Curbside collection of used oil, along with other recyclable products Residents provided with gallon containers to hold the oil Involves large public outreach program 	<p>75 to 120 gallons of used oil from 28,000 homes collected daily.</p> <p>A 40 percent increase in participation was observed from FY 87-88 to FY 90-91.</p>	Exact breakdowns were not available. Costs are kept low by incorporating the program into an existing recycling program; public information is distributed by such means as flyers in utility bills and brochures left by city employees such as repair crews and street sweepers.
Seattle, WA, Mobile Permanent Collection System <ul style="list-style-type: none"> Established in 1989 by King County Solid Waste Department 5,000 ft² mobile facility equipped to collect household hazardous materials ("Wastemobile") Collected material is either recycled, detoxified, or taken to a secured hazardous waste facility Includes extensive public outreach program 	<p>In the first 6 months of operation, 276.8 tons of material was collected; participation was twice that expected (one site recorded 875 cars in 6 days)</p> <p>In the first quarter, 98.3 tons were collected with the following breakdown:</p> <ul style="list-style-type: none"> 44.3 tons (45%) paint 23.1 tons (23.5%) waste oil 8.6 tons (8.8%) solvents 5.9 tons (6%) pesticides. <p>The balance was miscellaneous other household wastes.</p>	The Wastemobile cost \$110,000. King County has budgeted \$1.5 million (including public outreach and staff) over a 28-month period.
San Francisco, CA, Permanent Collection Facility^d <ul style="list-style-type: none"> A permanent household waste site that was initiated as a pilot project 65 percent of the collected material was recycled or reused 	30,730 gallons of hazardous wastes (excluding batteries) were collected the first year. The most common type of waste was paint, which was recycled and used by citizens groups to paint over graffiti.	<p>Operated by the private company that hauls the city's solid waste. Funds are obtained from the residential rate mechanism.</p> <p>The city is responsible for public education, waste disposal, and facility inspection.</p>

^a USEPA, 1989; Project ROSE Fact Sheet, 1991.

^b USEPA, 1988.

^c Johnston and Kehoe, 1989.

^d Misner, 1990

flyers, and radio. In Arlington County, Virginia, collection during the week is by appointment with a water pollution chemist employed by the county and on one Saturday a month. Other HHC collection programs have once-a-week or once-a-month collection days, and some programs have a single day set aside each year for all HHC collection for the county or region. The waste collected by these programs is usually disposed of by a licensed HHC contractor. Table 4-29 presents program descriptions, effectiveness, and cost information for representative HHC collection programs. Many service stations currently provide used oil and antifreeze recycling facilities for "do-it-yourselfers" to encourage environmentally sound disposal.

■ d. *Encourage proper lawn management and landscaping.*

The care of landscaped areas can contribute significantly to NPS pollutant loadings. Results of a telephone survey conducted in 1982 by the Virginia Polytechnic Institute and State University showed that only 12 to 15 percent of home lawns in Virginia were being managed properly. The majority of homeowners preferred to do their own lawn work; only 8 to 10 percent of the households used commercial lawn care companies. A similar survey conducted on Long Island concluded that in affluent neighborhoods, 72 percent of the respondents used a lawn care service; in the least affluent neighborhoods, no one subscribed to commercial lawn care (Cornell Water Resources Institute, 1985). The extent of nonpoint source pollution from fertilizer application is site-specific and depends on a number of factors, including soil type, application rate, type of fertilizer, precipitation and watering amount, and socioeconomic status of residents. Because most people are not trained in proper fertilization and maintenance application, homeowner lawn care may result in significant amounts of nonpoint source pollution.

To significantly decrease homeowners' pesticide and fertilizer loadings requires a broad-based educational effort. The State Cooperative Extension Service (CES) is one educational vehicle; however, the CES reaches only a small percentage of the population. Mass media approaches are generally the most effective way to reach a large part of the population, though some other possibilities are discussed below (Puget Sound Water Quality Authority, 1991). The following practices are part of proper lawn management and landscaping.

- *Proper pesticide and herbicide use, and reduced applications*

While few studies have been conducted to correlate pesticide and herbicide use with adverse effects on marine water quality, the magnitude of potential impacts can be inferred from incidents such as the extensive ground-water contamination in counties bordering the Puget Sound following widespread use of the pesticide ethylene dibromide (EDB) (Puget Sound Water Quality Authority, 1989). Estimates of pesticide use in the Puget Sound area reveal that 20 percent of the volume of pesticides applied is from residential sources and that these applications are typically in excess of recommended amounts or are too concentrated (Puget Sound Water Quality Authority, 1991).

Maintaining a buffer between surface water and areas treated with pesticides is one method to increase the transport distance and reduce the potential for offsite movement of toxics. Selection of less toxic, mobile, and persistent chemicals with greater selective control of pests is encouraged (Spectrum Research, 1990).

- *Reduced fertilizer applications and proper application timing*

Lawn fertilization has been identified as a source of excess nitrogen and phosphorus loadings that may lead to eutrophication. A modeling study of urban runoff pollution conducted in Pennsylvania, Maryland, Washington, DC, and Virginia by Cohn-Lee and Cameron (1991) estimated that the nonpoint source loadings of nutrients were equal to or greater than loadings discharged from POTWs and industries in the Chesapeake Bay area.

Ground-water contamination also may be of concern especially where interflow exists between surface waters and ground waters. Schultz (1989) found that over 50 percent of the nitrogen in fertilizer leaches from a lawn when improperly applied. NVSWCD et al. (1991) found that up to two-thirds less fertilizer can be applied than is typically recommended by manufacturers. The use of slow-release forms of nitrogen and proper watering may also decrease nonpoint source pollution loadings (Nassau-Suffolk Regional Planning Board, 1978).

- *Limited lawn watering*

Nonpoint source runoff from lawns can be reduced by employing efficient watering techniques. Overwatering can increase nitrogen loss 5 to 11 times the amount lost when proper watering strategies are used (Morton et al., 1988).

Soaker hoses and trickle or drip irrigation systems are an alternative to sprinkler systems. These types of systems deliver water at lower rates, which can increase the volume infiltrated, conserve water, and avoid runoff that can be associated with improperly operated sprinkler systems.

- *Use of minimum maintenance/minimum disturbance and IPM methods*

Minimum maintenance/minimum disturbance policies and strategies can effectively reduce land disturbance and associated soil loss and can reduce fertilizer, pesticide, and herbicide loadings. Where new development is occurring, community standards that limit the use of fertilizers or require commercial lawn care companies to use low-impact lawn care practices can decrease NPS loadings. Such practices can be promoted through public education programs for both new and existing developments.

Effective use of IPM strategies can further reduce nonpoint source loadings. Regional soil conservation services, agricultural extension offices, local conservation districts, or the U.S. Department of Agriculture are good sources of information on IPM. A study in Maryland on IPM for street and landscape trees in a planned suburban community demonstrated that pesticide use could be reduced by 79 to 87 percent when spot application techniques were substituted for cover spray techniques. An average annual cost savings of 22 percent also resulted from the program.

Effective IPM Strategies include (Washington State Department of Ecology, 1992):

- Use of natural predators and pathogens;
- Mechanical control;
- Use of native and resistant plantings;
- Maintenance of proper growing conditions;
- Removal of or substitutions for less-favored pest habitat;
- Timing annual crops to avoid pests;
- Localized use of appropriate chemicals as a last alternative.

- *Xeriscaping*

Xeriscaping, creative landscaping for decreased water, energy, and pesticide/fertilizer inputs, can be used to reduce urban runoff and minimize the application of lawn care products that may adversely impact coastal waters. The use of xeriscaping practices can reduce required lawn maintenance up to 50 percent and reduce watering requirements by 60 percent (Clemson University, 1991). Florida has passed legislation requiring xeriscaping on the grounds of all State buildings. Several other States, including New Jersey and California, actively support xeriscaping efforts. A more detailed discussion of xeriscaping is in Section II.C of this chapter.

- *Reduced runoff potential*

Rainwater from roofs can be infiltrated into the ground in gravel-filled trenches in well-drained soils or collected in rain barrels for later irrigation. Wood decking or brick pavers allow greater infiltration than do solid concrete structures. Landscape terracing reduces runoff and erosion when gardening on slopes (Washington State Department of Ecology, 1992).

- *Training, certification, and licensing programs for landscaping and lawn care professionals*

Training, certification, and licensing programs are an effective method to educate lawn care professionals about potential nonpoint pollution problems associated with fertilizer, pesticide, and herbicide applications. The State Cooperative Extension Service commonly provides these services. Trained lawn care professional can also help educate the general public about the advantages of low-input approaches.

■ e. *Encourage proper onsite recycling of yard trimmings.*

Home composting promotes onsite recycling of plant nutrients contained in yard trimmings and reduces the potential for nutrients to enter surface waters. Unlike most commercial fertilizers, compost releases nutrients slowly and is a source of trace metals (Hansen and Mancl, 1988). When added as an amendment to lawn or garden soils, compost increases the organic content of the soil, which increases infiltration, reduces runoff, and decreases the need for watering. Sediment and bound nutrients in soils with high organic content are less mobile and less likely to migrate from the site. Compost applications may also result in increased plant health and vigor, allowing for the reduced use of pesticides (Logsdon, 1990).

Home composting programs may result in municipal cost savings. An average suburban yard generates up to 1,500 pounds of yard trimmings per year, most of which is usually landfilled (McNelly, undated). Homeowners should be encouraged to place compost piles or bins away from streams and roadways that may serve as conveyances of leached nutrients. Recycling of grass clippings and mulched leaves should also be encouraged through education programs. The retention of grass clippings and mulched leaves reduces the need for supplemental water and fertilizer inputs.

Suggested backyard composting programs include the following:

- Provide compost bins free or at cost.
- Create pamphlets explaining benefits and methods.
- Start a "Master Composter" program in which graduates receive free equipment and conduct their own workshops.
- Provide credits on waste removal fees to people who compost yard wastes.

■ f. *Encourage the use of biodegradable cleaners and other alternatives to hazardous chemicals.*

Improperly disposed household cleaners containing nonbiodegradable chemicals have the potential to contaminate surface waters and ground water. OSDS systems may also be adversely impacted by these substances (PSWQA, 1989). The use of nontoxic, biodegradable alternatives, which quickly break down, should be encouraged through public education efforts (Reef Relief, 1992).

■ g. *Manage pet excrement to minimize runoff into surface waters.*

The Soil Conservation Service in the Nassau-Suffolk region of New York collected data indicating that domestic animals contribute BOD, COD, bacteria, nitrogen, and phosphorus to ground water and surface waters (Nassau-Suffolk Regional Planning Board, 1978). Urban runoff containing pet excrement has been found to be responsible for numerous shellfish bed closures in New York and has been implicated in shellfish bed closures in Massachusetts (George Huefelder, personal communication, 1992; Nassau-Suffolk Regional Planning Board, 1978). In New York, the large populations of semi-wild Pekin ducks contribute heavily to water quality problems. A study in Massachusetts found that dog droppings alone were significant enough to cause shellfish bed closures.

Curb laws, requiring that dogs be walked close to street curbs so they will defecate on the streets near curbs, are intended to ensure that street sweeping operations collect the droppings and prevent them from entering runoff. However, traditional street sweeping has been found to be an ineffective means for controlling fines and soluble NPS pollution and the dog droppings are more often swept into sewers and delivered to bays and estuaries during rain storms (Long Island Regional Planning Board, 1982; 1984; Nassau-Suffolk Regional Planning Board, 1978). Curbing ordinances should therefore be repealed where they are in effect, and laws requiring pet owners to clean up after their pets when they are walked in public areas and to dispose of the droppings properly should be enacted.

Proper cleanup and disposal of canine fecal material and discouragement of public feeding of waterfowl are two ways of potentially controlling the adverse impacts of animal droppings. The following examples from the Long Island Regional Planning Board (1984) illustrate controls for NPS pollution from animal droppings.

Control of NPS pollution from dogs:

- Enactment of "pooper-scooper" laws requiring the removal and proper disposal of dog feces on public property.
- Enforcement of existing "pooper-scooper" and leash laws should be improved in priority target areas where animal feces are known to be an NPS pollution problem.

Control of NPS pollution from horses:

- Instituting zoning ordinances to control the keeping of horses. These ordinances should include:
 - Minimum acreage requirements per horse;
 - Specifying areas where horse waste may be stored; and
 - Designated areas where horses may be kept.
- Limiting the density of horses in deep aquifer recharge areas, in selected shallow aquifer recharge areas, in areas immediately adjacent to surface waters, and where slopes are greater than 5 percent.

Public education programs:

- The Cooperative Extension Service and similar agencies should be encouraged to develop and distribute informational material on all aspects of animal waste problems.

Owners of large animals should use BMPs similar to those for pasture management, including the fencing of animals away from surface waters, avoidance of "overgrazing," "grazing area" rotation, and limited "grazing" when soil is wet. Manure is best stored away from waterbodies on an impervious surface with a cover or roof (Washington State Department of Ecology, 1992).

The following actions can be used to help control the problem of pet excrement:

- Pass regulations controlling the disposal of excrement from domestic animals;
- Enact domestic animal clean-up regulations; and
- Require commercial domestic animal operations (e.g., pet stores, kennels) to implement BMPs for the control and proper disposal of animal excrement.

■ *h. Use storm drain stenciling in appropriate areas.*

Storm drain stenciling programs can be effective tools to reduce illegal dumping of litter, leaves, and toxic substances down urban runoff drainage systems. These programs also serve as educational reminders to the public that such storm drains often discharge untreated runoff directly to coastal waters.

A successful program was initiated in Anne Arundel County, Maryland. The program was implemented by volunteers to prevent dumping of harmful material into storm drains that ultimately discharge to the Chesapeake Bay. The county's only involvement has been to publicize the program and provide stencils and painting materials.

Approximately 60 to 70 percent of all communities in the county have participated. Several other counties around the Chesapeake Bay have inquired about the program. Data on effectiveness in terms of pounds of pollutant removed were not available; however, an informal survey that occurred after the program was implemented revealed that there is increased public understanding that storm drains should not be used for disposal of hazardous materials and dumping has decreased. Costs were nominal (\$7.00 per stencil kit, including paint and brushes; the average neighborhood cost was \$40.00). There is a similar program in place in Puget Sound, Washington. The total cost of implementing the stenciling program for the Sound was \$2,644.39, including materials and labor. This practice is currently being used in other States and localities, including the Indian River Lagoon, Florida, drainage basin.

■ *i. Encourage alternative designs and maintenance strategies for impervious parking lots.*

Parking lot runoff accounts for a significant percentage of nonpoint source pollution in commercial areas, depending on the proportion of building size to parking lot size. Sweeping is a viable method of reducing this runoff from paved areas. If a lot is rectangular and has no parking bumpers or medians dividing it, the job is easier and less expensive. As indicated in the case study, a computer model proved to be a useful tool in evaluating the effectiveness of pavement sweeping as a method to control one source of nonpoint pollution (Broward County Planning Council, 1982).

CASE STUDY - FORT LAUDERDALE, FLORIDA

Through an EPA Continuing Planning Process Grant, the Broward County Planning Council received funding to conduct a study to determine the effectiveness of parking lot sweeping as a method to abate water pollution. A computer model, utilizing simple and multiple regression equations, was used to simulate the conditions at the study area and to predict the runoff loads from the area due to rainfall. Some results of the study are as follows: for paved commercial parking lots, the 3-day to 28-day sweeping cycle produces a pollutant removal range of 60 percent to 20 percent, respectively; as the quantity of residue increases, sweeper efficiency also increases, and there is a point of diminishing return for pollutant removal by sweeping and for sweeper efficiency in removing pollutant loadings (Broward County Planning Council, 1982).

Equipment types commonly used for street sweeping include abrasive brush and vacuum device sweepers. Both abrasive brush and vacuum sweepers have been shown to be generally inefficient at picking up fine solids of less than 43 microns. Although vacuum sweepers are more effective at removing fine particulates than brush sweepers, they are still generally considered to be inefficient. A newly developed helical brush sweeper that incorporates a steel brush with vacuum has been shown to be more effective at removing fine solids and is currently being evaluated. Although currently used sweeper technologies have been shown to be inefficient at removing fine particulates, their use in conjunction with other BMPs that are effective in trapping fine solids could improve downstream water quality (NVPDC, 1987).

Another promising method of street cleaning that concentrates on oil and grease removal is wet-sweeping. By spraying a small area with water containing biodegradable soaps or detergents that solubilize the oil and grease deposited on pavement surfaces, increased removal can occur with a combination of sweeping and vacuum action. This method, however, is a fairly new concept and requires further testing (Silverman et al., 1986).

Vegetated areas/grassed swales are another method commonly used to reduce pollutant loadings from pavement runoff. These areas can be designed to accept runoff with relatively high oil and grease concentrations from parking lots. Percolation through soil and underlying layers typically results in hydrocarbon filtration and adsorption, and degradation by naturally occurring soil bacteria.

■ j. *Control commercial sources of NPS pollutants by promoting pollution prevention assessments and developing NPS pollution reduction strategies or plans and training materials for the workplace.*

The opportunities for and advantages of pollution prevention practices vary from industry to industry, location to location, and activity to activity. Therefore, it is important to develop pollution prevention programs tailored specifically to an activity or site. Pollution prevention assessments on a site-by-site basis reduce some wastes and possibly eliminate the generation of other wastes. Such assessments are often necessary for successful pollution prevention programs (DOI, 1991).

States should promote and/or provide pollution prevention training and on-site assessments of individual facilities to help reduce the amount of hazardous wastes entering the environment from households and commercial facilities. A typical assessment for a facility will identify the types of waste produced, appropriate disposal methods and sites, and source reduction techniques. An education program to instruct personnel about proper materials handling and waste reduction strategies is also recommended.

The Alachua County, Florida, Office of Environmental Protection produced a handbook of BMPs to be applied in 12 separate commercial operations. Many of the BMPs are common to more than one type of operation, though specifics are mentioned for each category of activities. The 12 operations mentioned are small and large mechanical repair, dry cleaning, junk yards, photo processing, print and silk screening, machine shops and airport maintenance, boat manufacturing and repair, concrete and mining, agricultural, paint manufacturers and distributors, and plastic manufacturers (Alachua County Office of Environmental Protection, 1991).

The Santa Clara Valley Nonpoint Source Pollution Control Program and the San Jose Office of Environmental Management produced a handbook of BMPs for automobile service stations (Santa Clara Valley Water Control District, 1992). The handbook describes 18 BMPs that can be used to control onsite nonpoint source pollutants. Many of these BMPs require little or no investment for implementation. Most of the BMPs rely on education-induced behavior changes to minimize spills and disposal of chemicals and wastewaters down storm drains. Recycling, spill prevention and response plans, and proper material storage are also covered.

The City of Lacey, Washington, developed guidelines to control NPS pollution impacts from service stations and automotive repair facilities on Puget Sound. These include:

- Straining used solvents and paint thinner for reuse;
- Recycling antifreeze, oil, metal chips, and batteries;
- Properly disposing of wastes, including oils, machine-tool coolant, and batteries;
- Using dry floor cleaners, such as kitty litter or vermiculite; and
- Limiting use of water to clean driveways and walkways.

The city developed educational material for distribution that describes these guidelines, defines procedures for potential hazardous materials problems, and provides the State Hazardous Substance Hotline.

The City of Bellevue, Washington, Storm and Surface Water Utility, in cooperation with local businesses, has conducted a series of workshops aimed at the prevention of nonpoint pollution for automotive, construction, landscaping, food, and building maintenance businesses. The city gives recognition to businesses that attend a workshop and prepare a water quality action program. Videos of the workshops and accompanying manuals are also produced by the City of Bellevue (Washington State Department of Ecology, 1992).

■ k. *Promote water conservation.*

Excessive use of water contributes to numerous NPS pollution problems, including runoff from fertilized areas, OSDS drainfield failures, and sewage leaks. Water overuse may also contribute indirectly to NPS pollution problems: streams, rivers, and ground water may be excessively drawn down for water supply, decreasing their

capacity to absorb pollutant runoff and upsetting their natural flow (Long Island Regional Planning Board, 1982; Maddaus, 1989). Additional information on water conservation is contained in the OSDS section of this chapter.

■ *l. Discourage the use of septic system additives.*

A 1980 EPA study identified 23 priority pollutants that are likely to be disposed of down household drains. Disposal of these chemicals into OSDS may impair OSDS function and contaminate ground water. Septic system cleaners are included in this category. There is little scientific evidence that septic system cleaners are effective in improving the function of septic systems. Many of the septic system cleaners contain chemicals such as chlorinated hydrocarbons, aromatic organic compounds, and acids and bases that may have an adverse affect on the biological treatment system and that may also pollute ground water. Many of these chemicals are also highly persistent in the ground water. Studies of ground-water contamination in New York and Connecticut have monitored these compounds in ground water and have found that (1) the septic system additives are not effective in improving the treatment systems and (2) the additives pass into ground water in relatively unaltered form (RIDEM, 1988).

Many States and local governments have adopted legislation prohibiting the use of septic system cleaning solvents, including the States of Maine and Delaware, the New Jersey Pinelands Regional Planning Commission, and several jurisdictions in Massachusetts. Rhode Island prohibits the disposal of acids or organic chemical solvents in septic systems and specifically discourages the use of septic tank cleaners. The State of Connecticut Department of Environmental Protection has taken the process one step further by banning the sale and use of cleaning solvents and also implementing the law through press releases, statewide surveys, direct manufacturer contact, and contact with the State Retail Merchants Association.

■ *m. Encourage litter control.*

While street sweeping historically has been found to provide little benefit in reducing fines and pollutants associated with small particulates because of outdated sweeping equipment and irregular sweeping frequencies, litter control can be an effective means to improve the quality of urban runoff. Both the Baltimore and Long Island Nationwide Urban Runoff Program (NURP) projects found that litter control substantially influenced the quality of runoff from urban areas (Myers, 1989). Suggestions for controlling litter include:

- Encouraging businesses to keep the streets in front of their buildings free of litter;
- Developing local ordinances restricting or prohibiting food establishments from using disposable food packaging, especially plastics, styrofoam, and other floatables;
- Implementing "bottle bills" and mandatory recycling laws;
- Providing technical and financial assistance for establishing and maintaining community waste collection programs;
- Distributing public education materials on the benefits of recycling; and
- Developing "user-friendly" ways for recycling, such as curbside pick-up, voluntary container buy-back systems, and drop-off recycling centers.

■ *n. Promote programs such as Adopt-a-Stream to assist in keeping waterways free of litter and other debris.*

Such programs can eliminate much of the floatable debris found in coastal waters and their tributaries. These programs involve volunteers who pick up trash along designated streambeds. Several successful programs similar to these are being implemented in Maryland, Alaska, Virginia, North Carolina, and Washington. The International

Coastal Cleanup, the largest coastal cleanup effort in the country, is coordinated by the Center for Marine Conservation (CMC). With the use of data cards, plastic gloves, and trash bags, 130,152 volunteers cleared 4,347 miles of beaches and waterways of 2,878,913 pounds of trash during the 1991 cleanup effort (Younger and Hodge, 1992).

In addition to the visible benefits of such clean-up efforts, these programs offer valuable educational opportunities for volunteers and provide a significant amount of data on the amounts and types of debris being found in waterways. The sources of various types of debris can be traced as well. Debris can be traced to a specific company or organization based on labeling or marking. Where possible, CMC contacts these organizations about the finding of their debris, informs them of the problems caused by marine debris, and asks them to join the battle against the debris problem. From the 1990 CMC coastal clean-up effort, approximately 150 organizations were identified and contacted. As a result, the majority of organizations responded positively by printing educational "Do not litter" slogans on their products, and several launched internal investigations into current waste-handling procedures (Younger and Hodge, 1992).

- o. *Promote proper operation and maintenance of OSDS through public education and outreach programs.*

Many of the problems associated with improper use of OSDS may be attributed to lack of knowledge on operation and maintenance of onsite systems. Training courses for installers and inspectors and education materials for homeowners on proper maintenance may reduce some of the incidences of OSDS failure.

VII. ROADS, HIGHWAYS, AND BRIDGES

NOTE: Management Measures II.A and II.B of this chapter also apply to planning, siting, and developing roads and highways.⁶

A. Management Measure for Planning, Siting, and Developing Roads and Highways

Plan, site, and develop roads and highways to:

- (1) Protect areas that provide important water quality benefits or are particularly susceptible to erosion or sediment loss;
- (2) Limit land disturbance such as clearing and grading and cut and fill to reduce erosion and sediment loss; and
- (3) Limit disturbance of natural drainage features and vegetation.

1. Applicability

This measure is intended to be applied by States to site development and land disturbing activities for new, relocated, and reconstructed (widened) roads (including residential streets) and highways in order to reduce the generation of nonpoint source pollutants and to mitigate the impacts of urban runoff and associated pollutants from such activities. Under the Coastal Zone Act Reauthorization Amendments of 1990, States are subject to a number of requirements as they develop coastal NPS programs in conformity with this management measure and will have some flexibility in doing so. The application of management measures by States is described more fully in *Coastal Nonpoint Pollution Control Program: Program Development and Approval Guidance*, published jointly by the U.S. Environmental Protection Agency (EPA) and the National Oceanic and Atmospheric Administration (NOAA) of the U.S. Department of Commerce.

2. Description

The best time to address control of NPS pollution from roads and highways is during the initial planning and design phase. New roads and highways should be located with consideration of natural drainage patterns and planned to avoid encroachment on surface waters and wet areas. Where this is not possible, appropriate controls will be needed to minimize the impacts of NPS runoff on surface waters.

This management measure emphasizes the importance of planning to identify potential NPS problems early in the design process. This process involves a detailed analysis of environmental features most associated with NPS pollution, erosion and sediment problems such as topography, drainage patterns, soils, climate, existing land use, estimated traffic volume, and sensitive land areas. Highway locations selected, planned, and designed with consideration of these features will greatly minimize erosion and sedimentation and prevent NPS pollutants from entering watercourses during and after construction. An important consideration in planning is the distance between

⁶ Management measure II.A applies only to runoff that emanates from the road, highway, and bridge right-of-way. This management measure does not apply to runoff and total suspended solid loadings from upland areas outside the road, highway, or bridge project.

a highway and a watercourse that is needed to buffer the runoff flow and prevent potential contaminants from entering surface waters. Other design elements such as project alignment, gradient, cross section, and the number of stream crossings also must be taken into account to achieve successful control of erosion and nonpoint sources of pollution. (Refer to Chapter 3 of this guidance for details on road designs for different terrains.)

The following case study illustrates some of the problems and associated costs that may occur due to poor road construction and design. These issues should be addressed in the planning and design phase.

CASE STUDY - ANNAPOLIS, MARYLAND

Poor road siting and design resulted in concentrated runoff flows and heavy erosion that threatened several house foundations adjacent to the road. Sediment-laden runoff was also discharged into Herring Bay. To protect the Chesapeake Bay and the nearby houses, the county corrected the problem by installing diversions, a curb-and-drain urban runoff conveyance, and a rock wall filtration system, at a total cost of \$100,000 (Munsey, 1992).

3. Management Measure Selection

This management measure was selected because it follows the approach to highway development recommended by the American Association of State Highway and Transportation Officials (AASHTO), Federal Highway Administration (FHWA) guidance, and highway location and design guidelines used by the States of Virginia, Maryland, Washington, and others.

Additionally, AASHTO has location and design guidelines (AASHTO, 1990, 1991) available for State highway agency use that describe the considerations necessary to control erosion and highway-related pollutants. Federal Highway Administration policy (FHWA, 1991) requires that Federal-aid highway projects and highways constructed under direct supervision of the FHWA be located, designed, constructed, and operated according to standards that will minimize erosion and sediment damage to the highway and adjacent properties and abate pollution of surface water and ground-water resources.

4. Practices

As discussed more fully at the beginning of this chapter and in Chapter 1, the following practices are described for illustrative purposes only. State programs need not require implementation of these practices. However, as a practical matter, EPA anticipates that the management measure set forth above generally will be implemented by applying one or more management practices appropriate to the source, location, and climate. The practices set forth below have been found by EPA to be representative of the types of practices that can be applied successfully to achieve the management measure described above.

- a. *Consider type and location of permanent erosion and sediment controls (e.g., vegetated filter strips, grassed swales, pond systems, infiltration systems, constructed urban runoff wetlands, and energy dissipators and velocity controls) during the planning phase of roads, highway, and bridges. (AASHTO, 1991; Hartigan et al., 1989)*
- b. *All wetlands that are within the highway corridor and that cannot be avoided should be mitigated. These actions will be subject to Federal Clean Water Act section 404 requirements and State regulations.*

- c. *Assess and establish adequate setback distances near wetlands, waterbodies, and riparian areas to ensure protection from encroachment in the vicinity of these areas.*

Setback distances should be determined on a site-specific basis since several variables may be involved such as topography, soils, floodplains, cut-and-fill slopes, and design geometry. In level or gently sloping terrain, a general rule of thumb is to establish a setback of 50 to 100 feet from the edge of the wetland or riparian area and the right-of-way. In areas of steeply sloping terrain (20 percent or greater), setbacks of 100 feet or more are recommended. Right-of-way setbacks from major waterbodies (oceans, lakes, estuaries, rivers) should be in excess of 100 to 1000 feet.

- d. *Avoid locations requiring excessive cut and fill. (AASHTO, 1991)*
- e. *Avoid locations subject to subsidence, sink holes, landslides, rock outcroppings, and highly erodible soils. (AASHTO, 1991; TRB, Campbell, 1988)*
- f. *Size rights-of-way to include space for siting runoff pollution control structures as appropriate. (AASHTO, 1991; Hartigan, et al., 1989)*

Erosion and sediment control structures (extended detention dry ponds, permanent sediment traps, catchment basins, etc.) should be planned and located during the design phase and included as part of the design specifications to ensure that such structures, where needed, are provided within the highway right-of-way.

- g. *Plan residential roads and streets in accordance with local subdivision regulations, zoning ordinances, and other local site planning requirements (International City Managers Association, Model Zoning/Subdivision Codes). Residential road and street pavements should be designed with minimum widths.*

Local roads and streets should have right-of-way widths of 36 to 50 feet, with lane widths of 10 to 12 feet. Minimum pavement widths for residential streets where street parking is permitted range from 24 to 28 feet between curbs. In large-lot subdivisions (1 acre or more), grassed drainage swales can be used in lieu of curbs and gutters and the width of paved road surface can be between 18 and 20 feet.

- h. *Select the most economic and environmentally sound route location. (FHWA, 1991)*
- i. *Use appropriate computer models and methods to determine urban runoff impacts with all proposed route corridors. (Driscoll, 1990)*

Computer models to determine urban runoff from streets and highways include TR-55 (Soil Conservation Service model for controlling peak runoff); the P-8 model to determine storage capacity (Palmstrom and Walker); the FHWA highway runoff model (Driscoll et al., 1990); and others (e.g., SWMM, EPA's stormwater management model; HSP continuous simulation model by Hydrocomp, Inc.).

- j. *Comply with National Environmental Policy Act requirements including other State and local requirements. (FHWA, T6640.8A)*
- k. *Coordinate the design of pollution controls with appropriate State and Federal environmental agencies. (Maryland DOE, 1983)*

■ I. *Develop local official mapping to show location of proposed highway corridors.*

Official mapping can be used to reserve land areas needed for public facilities such as roads, highways, bridges, and urban runoff treatment devices. Areas that require protection, such as those which are sensitive to disturbance or development-related nonpoint source pollution, can be reserved by planning and mapping necessary infrastructure for location in suitable areas.

5. Effectiveness Information and Cost Information

The most economical time to consider the type and location of erosion, sediment, and NPS pollution control is early in the planning and design phase of roads and highways. It is much more costly to correct polluted runoff problems after a road or highway has already been built. The most effective and often the most economical control is to design roads and highways as close to existing grade as possible to minimize the area that must be cut or filled and to avoid locations that encroach upon adjacent watercourses and wet areas. However, some portions of roads and highways cannot always be located where NPS pollution does not pose a threat to surface waters. In these cases, the impact from potential pollutant loadings should be mitigated. Interactive computer models designed to run on a PC are available (e.g., FHWA's model, Driscoll et al., 1990) and can be used to examine and project the runoff impacts of a proposed road or highway design on surface waters. Where controls are determined to be needed, several cost-effective management practices, such as vegetated filter strips, grassed swales, and pond systems, can be considered and used to treat the polluted runoff. These mitigating practices are described in detail in the discussion on urban developments (Management Measure IV.A).

B. Management Measure for Bridges

Site, design, and maintain bridge structures so that sensitive and valuable aquatic ecosystems and areas providing important water quality benefits are protected from adverse effects.

1. Applicability

This management measure is intended to be applied by States to new, relocated, and rehabilitated bridge structures in order to control erosion, streambed scouring, and surface runoff from such activities. Under the Coastal Zone Act Reauthorization Amendments of 1990, States are subject to a number of requirements as they develop coastal NPS programs in conformity with this management measure and will have some flexibility in doing so. The application of management measures by States is described more fully in *Coastal Nonpoint Pollution Control Program: Program Development and Approval Guidance*, published jointly by the U.S. Environmental Protection Agency (EPA) and the National Oceanic and Atmospheric Administration (NOAA) of the U.S. Department of Commerce.

2. Description

This measure requires that NPS runoff impacts on surface waters from bridge decks be assessed and that appropriate management and treatment be employed to protect critical habitats, wetlands, fisheries, shellfish beds, and domestic water supplies. The siting of bridges should be a coordinated effort among the States, the FHWA, the U.S. Coast Guard, and the Army Corps of Engineers. Locating bridges in coastal areas can cause significant erosion and sedimentation, resulting in the loss of wetlands and riparian areas. Additionally, since bridge pavements are extensions of the connecting highway, runoff waters from bridge decks also deliver loadings of heavy metals, hydrocarbons, toxic substances, and deicing chemicals to surface waters as a result of discharge through scupper drains with no overland buffering. Bridge maintenance can also contribute heavy loads of lead, rust particles, paint, abrasive, solvents, and cleaners into surface waters. Protection against possible pollutant overloads can be afforded by minimizing the use of scuppers on bridges traversing very sensitive waters and conveying deck drainage to land for treatment. Whenever practical, bridge structures should be located to avoid crossing over sensitive fisheries and shellfish-harvesting areas to prevent washing polluted runoff through scuppers into the waters below. Also, bridge design should account for potential scour and erosion, which may affect shellfish beds and bottom sediments.

3. Management Measure Selection

This management measure was selected because of its documented effectiveness and to protect against potential pollution impacts from siting bridges over sensitive waters and tributaries in the coastal zone. There are several examples of siting bridges to protect sensitive areas. The Isle of Palms Bridge near Charleston, South Carolina, was designed without scupper drains to protect a local fishery from polluted runoff by preventing direct discharge into the waters below. In another example, the Louisiana Department of Transportation and Development specified stringent requirements before allowing the construction of a bridge to protect destruction of fragile wetlands near New Orleans. A similar requirement was specified for bridge construction in the Tampa Bay area in Florida (ENR, 1991).

4. Practices

As discussed more fully at the beginning of this chapter and in Chapter 1, the following practices are described for illustrative purposes only. State programs need not require implementation of these practices. However, as a practical matter, EPA anticipates that the management measure set forth above generally will be implemented by applying one or more management practices appropriate to the source, location, and climate. The practices set forth below have been found by EPA to be representative of the types of practices that can be applied successfully to achieve the management measure described above.

Additional erosion and sediment control management practices are listed in the construction section for urban sources of pollution (Management Measure IV.A).

- a. *Coordinate design with FHWA, USCG, COE, and other State and Federal agencies as appropriate.*
- b. *Review National Environmental Policy Act requirements to ensure that environmental concerns are met (FHWA, T6640.8A and 23 CFR 771).*
- c. *Avoid highway locations requiring numerous river crossings. (AASHTO, 1991)*
- d. *Direct pollutant loadings away from bridge decks by diverting runoff waters to land for treatment.*

Bridge decks should be designed to keep runoff velocities low and control pollutant loadings. Runoff waters should be conveyed away from contact with the watercourse and directed to a stable storm drainage, wetland, or detention pond. Conveyance systems should be designed to withstand the velocities of projected peak discharge.

- e. *Restrict the use of scupper drains on bridges less than 400 feet in length and on bridges crossing very sensitive ecosystems.*

Scupper drains allow direct discharge of runoff into surface waters below the bridge deck. Such discharges can be of concern where the waterbody is highly susceptible to degradation or is an outstanding resource such as a spawning area or shellfish bed. Other sensitive waters include water supply sources, recreational waters, and irrigation systems. Care should be taken to protect these areas from contaminated runoff.

- f. *Site and design new bridges to avoid sensitive ecosystems.*

Pristine waters and sensitive ecosystems should be protected from degradation as much as possible. Bridge structures should be located in alternative areas where only minimal environmental damage would result.

- g. *On bridges with scupper drains, provide equivalent urban runoff treatment in terms of pollutant load reduction elsewhere on the project to compensate for the loading discharged off the bridge.*

5. Effectiveness Information and Cost Information

Effectively controlling NPS pollutants such as road contaminants, fugitive dirt, and debris and preventing accidental spills from entering surface waters via bridge decks are necessary to protect wetlands and other sensitive ecosystems. Therefore, management practices such as minimizing the use of scupper drains and diverting runoff waters to land for treatment in detention ponds and infiltration systems are known to be effective in mitigating pollutant loadings. Tables 4-7 and 4-8 in Section II provide cost and effectiveness data for ponds, constructed wetlands, and filtration devices.

C. Management Measure for Construction Projects

- (1) Reduce erosion and, to the extent practicable, retain sediment onsite during and after construction and**
- (2) Prior to land disturbance, prepare and implement an approved erosion control plan or similar administrative document that contains erosion and sediment control provisions.**

1. Applicability

This management measure is intended to be applied by States to new, replaced, restored, and rehabilitated road, highway, and bridge construction projects in order to control erosion and offsite movement of sediment from such project sites. Under the Coastal Zone Act Reauthorization Amendments of 1990, States are subject to a number of requirements as they develop coastal NPS programs in conformity with this management measure and will have some flexibility in doing so. The application of management measures by States is described more fully in *Coastal Nonpoint Pollution Control Program: Program Development and Approval Guidance*, published jointly by the U.S. Environmental Protection Agency (EPA) and the National Oceanic and Atmospheric Administration (NOAA) of the U.S. Department of Commerce.

2. Description

Erosion and sedimentation from construction of roads, highways, and bridges, and from unstabilized cut-and-fill areas, can significantly impact surface waters and wetlands with silt and other pollutants including heavy metals, hydrocarbons, and toxic substances. Erosion and sediment control plans are effective in describing procedures for mitigating erosion problems at construction sites before any land-disturbing activity begins. Additional relevant practices are described in Management Measures III.A and III.B of this chapter.

Bridge construction projects include grade separations (bridges over roads) and waterbody crossings. Erosion problems at grade separations result from water running off the bridge deck and runoff waters flowing onto the bridge deck during construction. Controlling this runoff can prevent erosion of slope fills and the undermining failure of the concrete slab at the bridge approach. Bridge construction over waterbodies requires careful planning to limit the disturbance of streambanks. Soil materials excavated for footings in or near the water should be removed and relocated to prevent the material from being washed back into the waterbody. Protective berms, diversion ditches, and silt fences parallel to the waterway can be effective in preventing sediment from reaching the waterbody.

Wetland areas will need special consideration if affected by highway construction, particularly in areas where construction involves adding fill, dredging, or installing pilings. Highway development is most disruptive in wetlands since it may cause increased sediment loss, alteration of surface drainage patterns, changes in the subsurface water table, and loss of wetland habitat. Highway structures should not restrict tidal flows into salt marshes and other coastal wetland areas because this might allow the intrusion of freshwater plants and reduce the growth of salt-tolerant species. To safeguard these fragile areas, the best practice is to locate roads and highways with sufficient setback distances between the highway right-of-way and any wetlands or riparian areas. Bridge construction also can impact water circulation and quality in wetland areas, making special techniques necessary to accommodate construction. The following case study provides an example of a construction project where special considerations were given to wetlands.

CASE STUDY - BRIDGING WETLANDS IN LOUISIANA

To provide protection for an environmentally critical wetland outside New Orleans, the Louisiana Department of Transportation and Development (DOTD) required a special construction technique to build almost 2 miles of twin elevated structures for the Interstate 310 link between I-10 and U.S. Route 90. A technique known as "end-on" construction was devised to work from the decks of the structures, building each section of the bridge from the top of the last completed section and using heavy cranes to push each section forward one bay at a time. The cranes were also used to position steel platforms, drive in support pilings, and lay deck slabs, alternating this procedure between each bay. Without this technique, the Louisiana DOTD would not have been permitted to build this structure. The twin 9,200-foot bridges took 485 days to complete at a cost of \$25.3 million (*Engineering News Record*, 1991).

3. Management Measure Selection

This management measure was selected because it supports FHWA's erosion and sediment control policy for all highway and bridge construction projects and is the administrative policy of several State highway departments and local governmental agencies involved in land development activity. Examples of erosion and sediment controls and NPS pollutant control practices are described in AASHTO guidelines and in several State erosion control manuals (AASHTO, 1991; North Carolina DOT, 1991; Washington State DOT, 1988). A detailed discussion of cost-effective management practices is available in the urban development section (Section II) of this chapter. These example practices are also effective for highway construction projects.

4. Practices

As discussed more fully at the beginning of this chapter and in Chapter 1, the following practices are described for illustrative purposes only. State programs need not require implementation of these practices. However, as a practical matter, EPA anticipates that the management measure set forth above generally will be implemented by applying one or more management practices appropriate to the source, location, and climate. The practices set forth below have been found by EPA to be representative of the types of practices that can be applied successfully to achieve the management measure described above.

Additional erosion and sediment control management practices are listed in the construction section (Section III) of this chapter.

- a. *Write erosion and sediment control requirements into plans, specifications, and estimates for Federal aid construction projects for highways and bridges (FHWA, 1991) and develop erosion control plans for earth-disturbing activities.*

Erosion and sediment control decisions made during the planning and location phase should be written into the contract, plans, specifications, and special provisions provided to the construction contractor. This approach can establish contractor responsibility to carry out the explicit contract plan recommendations for the project and the erosion control practices needed.

- b. *Coordinate erosion and sediment controls with FHWA, AASHTO, and State guidelines.*

Coordination and scheduling of the project work with State and local authorities are major considerations in controlling anticipated erosion and sediment problems. In addition, the contractor should submit a general work schedule and plan that indicates planned implementation of temporary and permanent erosion control practices, including shutdown procedures for winter and other work interruptions. The plan also should include proposed methods of control on restoring borrow pits and the disposal of waste and hazardous materials.

- c. *Install permanent erosion and sediment control structures at the earliest practicable time in the construction phase.*

Permanent or temporary soil stabilization practices should be applied to cleared areas within 15 days after final grade is reached on any portion of the site. Soil stabilization should also be applied within 15 days to denuded areas that may not be at final grade but will remain exposed to rain for 30 days or more. Soil stabilization practices protect soil from the erosive forces of raindrop impact and flowing water. Temporary erosion control practices usually include seeding, mulching, establishing general vegetation, and early application of a gravel base on areas to be paved. Permanent soil stabilization practices include vegetation, filter strips, and structural devices.

Sediment basins and traps, perimeter dikes, sediment barriers, and other practices intended to trap sediment on site should be constructed as a first step in grading and should be functional before upslope land disturbance takes place. Structural practices such as earthen dams, dikes, and diversions should be seeded and mulched within 15 days of installation.

- d. *Coordinate temporary erosion and sediment control structures with permanent practices.*

All temporary erosion and sediment controls should be removed and disposed of within 30 days after final site stabilization is achieved or after the temporary practices are no longer needed. Trapped sediment and other disturbed soil areas resulting from the disposition of temporary controls should be permanently stabilized to prevent further erosion and sedimentation (AASHTO, 1991).

- e. *Wash all vehicles prior to leaving the construction site to remove mud and other deposits. Vehicles entering or leaving the site with trash or other loose materials should be covered to prevent transport of dust, dirt, and debris. Install and maintain mud and silt traps.*

- f. *Mitigate wetland areas destroyed during construction.*

Marshes and some types of wetlands can often be developed in areas where fill material was extracted or in ponds designed for sediment control during construction. Vegetated strips of native marsh grasses established along highway embankments near wetlands or riparian areas can be effective to protect these areas from erosion and sedimentation (FHWA, 1991).

- g. *Minimize the area that is cleared for construction.*

- h. *Construct cut-and-fill slopes in a manner that will minimize erosion.*

Cut-and-fill slopes should be constructed in a manner that will minimize erosion by taking into consideration the length and steepness of slopes, soil types, upslope drainage areas, and ground-water conditions. Suggested recommendations are as follows: reduce the length of long steep slopes by adding diversions or terraces; prevent concentrated runoff from flowing down cut-and-fill slopes by containing these flows within flumes or slope drain structures; and create roughened soil surfaces on cut-and-fill slopes to slow runoff flows. Wherever a slope face crosses a water seepage plane, thereby endangering the stability of the slope, adequate subsurface drainage should be provided.

- i. *Minimize runoff entering and leaving the site through perimeter and onsite sediment controls.*

- j. *Inspect and maintain erosion and sediment control practices (both on-site and perimeter) until disturbed areas are permanently stabilized.*

- k. *Divert and convey offsite runoff around disturbed soils and steep slopes to stable areas in order to prevent transport of pollutants off site.*
- l. *After construction, remove temporary control structures and restore the affected area. Dispose of sediments in accordance with State and Federal regulations.*
- m. *All storm drain inlets that are made operable during construction should be protected so that sediment-laden water will not enter the conveyance system without first being filtered or otherwise treated to remove sediment.*

5. Effectiveness Information and Cost Information

The detailed cost and effectiveness information presented under the construction measure for urban development is also applicable to road, highway, and bridge construction. See Tables 4-15 and 4-16 in Section III.

D. Management Measure for Construction Site Chemical Control

- (1) Limit the application, generation, and migration of toxic substances;**
- (2) Ensure the proper storage and disposal of toxic materials; and**
- (3) Apply nutrients at rates necessary to establish and maintain vegetation without causing significant nutrient runoff to surface water.**

1. Applicability

This management measure is intended to be applied by States to new, resurfaced, restored, and rehabilitated road, highway, and bridge construction projects in order to reduce toxic and nutrient loadings from such project sites. Under the Coastal Zone Act Reauthorization Amendments of 1990, States are subject to a number of requirements as they develop coastal NPS programs in conformity with this management measure and will have some flexibility in doing so. The application of management measures by States is described more fully in *Coastal Nonpoint Pollution Control Program: Program Development and Approval Guidance*, published jointly by the U.S. Environmental Protection Agency (EPA) and the National Oceanic and Atmospheric Administration (NOAA) of the U.S. Department of Commerce.

2. Description

The objective of this measure is to guard against toxic spills and hazardous loadings at construction sites from equipment and fuel storage sites. Toxic substances tend to bind to fine soil particles; however, by controlling sediment mobilization, it is possible to limit the loadings of these pollutants. Also, some substances such as fuels and solvents are hazardous and excess applications or spills during construction can pose significant environmental impacts. Proper management and control of toxic substances and hazardous materials should be the adopted procedure for all construction projects and should be established by erosion and sediment control plans. Additional relevant practices are described in Management Measure III.B of this chapter.

3. Management Measure Selection

This management measure was selected because of existing practices that have been shown to be effective in mitigating construction-generated NPS pollution at highway project sites and equipment storage yards. In addition, maintenance areas containing road salt storage, fertilizers and pesticides, snowplows and trucks, and tractor mowers have the potential to contribute NPS pollutants to adjacent watercourses if not properly managed (AASHTO, 1988, 1991a). This measure is intended to safeguard surface waters and ground water from toxic and hazardous pollutants generated at construction sites. Examples of effective implementation of this measure are presented in the section on construction in urban areas. Several State environmental agencies are using this approach to regulate toxic and hazardous pollutants (Florida DER, 1988; Puget Sound Basin, 1991).

4. Practices

As discussed more fully at the beginning of this chapter and in Chapter 1, the following practices are described for illustrative purposes only. State programs need not require implementation of these practices. However, as a practical matter, EPA anticipates that the management measure set forth above generally will be implemented by applying one or more management practices appropriate to the source, location, and climate. The practices set forth below have been found by EPA to be representative of the types of practices that can be applied successfully to achieve the management measure described above.

The practices that are applicable to this management measure are described in Section III.B.

5. Effectiveness Information and Cost Information

The detailed cost and effectiveness data presented in the Section III.A of this chapter describing NPS controls for construction projects in urban development areas are also applicable to highway construction projects.

E. Management Measure for Operation and Maintenance

Incorporate pollution prevention procedures into the operation and maintenance of roads, highways, and bridges to reduce pollutant loadings to surface waters.

1. Applicability

This management measure is intended to be applied by States to existing, restored, and rehabilitated roads, highways, and bridges. Under the Coastal Zone Act Reauthorization Amendments of 1990, States are subject to a number of requirements as they develop coastal NPS programs in conformity with this management measures and will have some flexibility in doing so. The application of measures by States is described more fully in *Coastal Nonpoint Pollution Control Program: Program Development and Approval Guidance*, published jointly by the U.S. Environmental Protection Agency (EPA) and the National Oceanic and Atmospheric Administration (NOAA) of the U.S. Department of Commerce.

2. Description

Substantial amounts of eroded material and other pollutants can be generated by operation and maintenance procedures for roads, highways, and bridges, and from sparsely vegetated areas, cracked pavements, potholes, and poorly operating urban runoff control structures. This measure is intended to ensure that pollutant loadings from roads, highways, and bridges are minimized by the development and implementation of a program and associated practices to ensure that sediment and toxic substance loadings from operation and maintenance activities do not impair coastal surface waters. The program to be developed, using the practices described in this management measure, should consist of and identify standard operating procedures for nutrient and pesticide management, road salt use minimization, and maintenance guidelines (e.g., capture and contain paint chips and other particulates from bridge maintenance operations, resurfacing, and pothole repairs).

3. Management Measure Selection

This management measure for operation and maintenance was selected because (1) it is recommended by FHWA as a cost-effective practice (FHWA, 1991); (2) it is protective of the human environment (Puget Sound Water Quality Authority, 1989); (3) it is effective in controlling erosion by revegetating bare slopes (AASHTO, 1991b); (4) it is helpful in minimizing polluted runoff from road pavements (Transportation Research Board, 1991); and (5) both Federal (Richardson, 1974) and State highway agencies (Minnesota Pollution Control Agency, 1989; Pitt, 1973) advocate highway maintenance as an effective practice for minimizing pollutant loadings.

Maintenance of erosion and sediment control practices is of critical importance. Both temporary and permanent controls require frequent and periodic cleanout of accumulated sediment. Any trapping or filtering device, such as silt fences, sediment basins, buffers, inlets, and check dams, should be checked and cleaned out when approximately 50 percent of their capacity is reached, as determined by the erodible nature of the soil, flow velocity, and quantity of runoff. Seasonal and climatic differences may require more frequent cleanout of these structures. The sediments removed from these control devices should be deposited in permanently stabilized areas to prevent further erosion and sediment from reaching drainages and receiving streams. After periods of use, control devices may require replacement of deteriorated materials such as straw bales and silt fence fabrics, or restoration and reconstruction of sediment basins and riprap installations.

Permanent erosion controls such as vegetated filter strips, grassed swales, and velocity dissipators should be inspected periodically to determine their integrity and continued effectiveness. Continual deterioration or damage to these controls may indicate a need for better design or construction.

4. Practices

As discussed more fully at the beginning of this chapter and in Chapter 1, the following practices are described for illustrative purposes only. State programs need not require implementation of these practices. However, as a practical matter, EPA anticipates that the management measure set forth above generally will be implemented by applying one or more management practices appropriate to the source, location, and climate. The practices set forth below have been found by EPA to be representative of the types of practices that can be applied successfully to achieve the management measure described above.

- a. *Seed and fertilize, seed and mulch, and/or sod damaged vegetated areas and slopes.*
- b. *Establish pesticide/herbicide use and nutrient management programs.*

Refer to the Management Measure for Construction Site Chemical Control in this chapter.

- c. *Restrict herbicide and pesticide use in highway rights-of-way to applicators certified under the Federal Insecticide, Fungicide, and Rodenticide Act (FIFRA) to ensure safe and effective application.*
- d. *The use of chemicals such as soil stabilizers, dust palliatives, sterilants, and growth inhibitors should be limited to the best estimate of optimum application rates. All feasible measures should be taken to avoid excess application and consequent intrusion of such chemicals into surface runoff.*
- e. *Sweep, vacuum, and wash residential/urban streets and parking lots.*
- f. *Collect and remove road debris.*
- g. *Cover salt storage piles and other deicing materials to reduce contamination of surface waters. Locate them outside the 100-year floodplain.*
- h. *Regulate the application of deicing salts to prevent oversalting of pavement.*
- i. *Use specially equipped salt application trucks.*
- j. *Use alternative deicing materials, such as sand or salt substitutes, where sensitive ecosystems should be protected.*
- k. *Prevent dumping of accumulated snow into surface waters.*
- l. *Maintain retaining walls and pavements to minimize cracks and leakage.*
- m. *Repair potholes.*
- n. *Encourage litter and debris control management.*

- o. *Develop an inspection program to ensure that general maintenance is performed on urban runoff and NPS pollution control facilities.*

To be effective, erosion and sediment control devices and practices must receive thorough and periodic inspection checks. The following is a suggested checklist for the inspection of erosion and sediment controls (AASHTO Operating Subcommittee on Design, 1990):

- Clean out sediment basins and traps; ensure that structures are stable.
 - Inspect silt fences and replace deteriorated fabrics and wire connections; properly dispose of deteriorated materials.
 - Renew ripped areas and reapply supplemental rock as necessary.
 - Repair/replace check dams and brush barriers; replace or stabilize straw bales as needed.
 - Regrade and shape berms and drainage ditches to ensure that runoff is properly channeled.
 - Apply seed and mulch where bare spots appear, and replace matting material if deteriorated.
 - Ensure that culverts and inlets are protected from siltation.
 - Inspect all permanent erosion and sediment controls on a scheduled, programmed basis.
- p. *Ensure that energy dissipators and velocity controls to minimize runoff velocity and erosion are maintained.*
- q. *Dispose of accumulated sediment collected from urban runoff management and pollution control facilities, and any wastes generated during maintenance operations, in accordance with appropriate local, State, and Federal regulations.*
- r. *Use techniques such as suspended tarps, vacuums, or booms to reduce, to the extent practicable, the delivery to surface waters of pollutants used or generated during bridge maintenance (e.g., paint, solvents, scrapings).*
- s. *Develop education programs to promote the practices listed above.*

5. Effectiveness Information and Cost Information

Preventive maintenance is a time-proven, cost-effective management approach. Operation schedules and maintenance procedures to restore vegetation, proper management of salt and fertilizer application, regular cleaning of urban runoff structures, and frequent sweeping and vacuuming of urban streets have effective results in pollution control. Litter control, clean-up, and fix-up practices are a low-cost means for eliminating causes of pollution, as is the proper handling of fertilizers, pesticides, and other toxic materials including deicing salts and abrasives. Table 4-30 presents summary information on the cost and effectiveness of operation and maintenance practices for roads, highways, and bridges. Many States and communities are already implementing several of these practices within their budget limitations. As shown in Table 4-30, the use of road salt alternatives such as calcium magnesium acetate (CMA) can be very costly. Some researchers have indicated, however, that reductions in corrosion of infrastructure, damage to roadside vegetation, and the quantity of material that needs to be applied may offset the higher cost of CMA. Use of road salt minimization practices such as salt storage protection and special salt spreading equipment reduces the amount of salt that a State or community must purchase. Consequently, implementation of these practices can pay for itself through savings in salt purchasing costs. Similar programs such as nutrient and pesticide management can also lead to decreased expenditures for materials.

CMA Eligible for Matching Funds

Calcium magnesium acetate (CMA) is now eligible for Federal matching funds under the Bridge Program of the Intermodal Surface Transportation Efficiency Act (ISTEA) of 1991. The Act provides 80 percent funding for use of CMA on salt-sensitive bridges in order to protect against corrosion and to extend their useful life. CMA can also be used to protect vegetation from salt damage in environmentally sensitive areas.

Table 4-30. Effectiveness and Cost Summary for Roads, Highways, and Bridges Operation and Maintenance Management Practices

Management Practice	% Removal						Cost
	TSS	TP	TN	COD	Pb	Zn	
MAINTAIN VEGETATION							
For Sediment Control							Natural succession allowed to occur - Avg: \$100/ac/year
Average:	90	NA	NA	NA	NA	NA	Reported Range: \$50-\$200/ac/year
Reported Range:	50-100	NA	NA	NA	NA	NA	
Probable Range:	80-100	-	-	-	-	-	
For Pollutant Removal							Natural succession not allowed to occur - Avg: \$800/ac/year
Average:	60	40	40	50	50	50	Reported Range: \$700-\$900/ac/year
Reported Range:	0-100	0-100	0-70	20-80	0-100	50-60	
Probable Range:	0-100	0-100	0-100	0-100	0-100	0-100	
PESTICIDE/HERBICIDE USE MANAGEMENT							
Average:	NA						Generally accepted as an economical program to control excessive use
Reported Range:	NA						
Probable Range:							
STREET SWEEPING							
Smooth Street, Frequent Cleaning (One or More Passes Per Week)							Avg: \$20/curb mile Reported Range: \$10-\$30/curb mile
Average:	20	NA	NA	5	25	NA	
Reported Range:	20	NA	NA	0-10	5-35	NA	
Probable Range:	20-50	-	-	0-10	20-50	10-30	
Infrequent Cleaning (One Pass Per Month or Less)							
Average:	NA	NA	NA	NA	5	NA	
Reported Range:	NA	NA	NA	NA	0-10	NA	
Probable Range:	0-20	-	-	-	0-20	0-10	
LITTER CONTROL							
Average:	NA						Generally accepted as an economical approach to control excessive use
Reported Range:	NA						
Probable Range:							

Table 4-30. (Continued)

Management Practice	% Removal						Cost
	TSS	TP	TN	COD	Pb	Zn	
GENERAL MAINTENANCE (e.g., pothole and roadside repairs)							Generally accepted as an economical preventive maintenance program by local and State agencies
Average:	NA						
Reported Range:	NA						
Probable Range:							
PROTECTION OF SALT PILES							For salt storage building - Ave: \$30/ton salt Reported Range: \$10-\$70/ton salt
Average:	NA						
Reported Range:	NA						
Probable Range:	90-100 ^a						
MINIMIZATION OF APPLICATION OF DEICING SALTS							Generally accepted as an economical preventive maintenance program by local and State agencies
Average:	NA						
Reported Range:	NA						
Probable Range:	Deicing salts that are not applied to roads will not enter runoff _a						
SPECIALLY EQUIPPED SALT APPLICATION TRUCKS							For spread rate control on truck - Ave: \$6,000/truck Reported Range: \$6,000/truck
Average:	NA						
Reported Range:	NA						
Probable Range:	Deicing salts that are not applied to roads will not enter runoff _a						
USE OF ALTERNATIVE DEICING MATERIALS							CMA - Ave: \$650/ton Reported Range: \$650/ton (note: cost of salt \$30/ton)
Average:	NA						
Reported Range:	NA						
Probable Range:	Deicing salts that are not applied to roads will not enter runoff _a						
CONTAIN POLLUTANTS GENERATED DURING BRIDGE MAINTENANCE							Varies with method of containment use
Average:	NA						
Reported Range:	NA						
Probable Range:	50-100 ^b						

NA = Not applicable.

^aMeasured as reduction in salt.^bMeasured as reduction of all pollutants.

F. Management Measure for Road, Highway, and Bridge Runoff Systems

Develop and implement runoff management systems for existing roads, highways, and bridges to reduce runoff pollutant concentrations and volumes entering surface waters.

- (1) Identify priority and watershed pollutant reduction opportunities (e.g., improvements to existing urban runoff control structures; and**
- (2) Establish schedules for implementing appropriate controls.**

1. Applicability

This management measure is intended to be applied by States to existing, resurfaced, restored, and rehabilitated roads, highways, and bridges that contribute to adverse effects in surface waters. Under the Coastal Zone Act Reauthorization Amendments of 1990, States are subject to a number of requirements as they develop coastal NPS programs in conformity with this management measure and will have some flexibility in doing so. The application of management measures by States is described more fully in *Coastal Nonpoint Pollution Control Program: Program Development and Approval Guidance*, published jointly by the U.S. Environmental Protection Agency (EPA) and the National Oceanic and Atmospheric Administration (NOAA) of the U.S. Department of Commerce.

2. Description

This measure requires that operation and maintenance systems include the development of retrofit projects, where needed, to collect NPS pollutant loadings from existing, reconstructed, and rehabilitated roads, highways, and bridges. Poorly designed or maintained roads and bridges can generate significant erosion and pollution loads containing heavy metals, hydrocarbons, sediment, and debris that run off into and threaten the quality of surface waters and their tributaries. In areas where such adverse impacts to surface waters can be attributed to adjacent roads or bridges, retrofit management projects to protect these waters may be needed (e.g., installation of structural or nonstructural pollution controls). Retrofit projects can be located in existing rights-of-way, within interchange loops, or on adjacent land areas. Areas with severe erosion and pollution runoff problems may require relocation or reconstruction to mitigate these impacts.

Runoff management systems are a combination of nonstructural and structural practices selected to reduce nonpoint source loadings from roads, highways, and bridges. These systems are expected to include structural improvements to existing runoff control structures for water quality purposes; construction of new runoff control devices, where necessary to protect water quality; and scheduled operation and maintenance activities for these runoff control practices. Typical runoff controls for roads, highways, and bridges include vegetated filter strips, grassed swales, detention basins, constructed wetlands, and infiltration trenches.

3. Management Measure Selection

This management measure was selected because of the demonstrated effectiveness of retrofit systems for existing roads and highways that were constructed with inadequate nonpoint source pollution controls or without such controls. Structural practices for mitigating polluted runoff from existing highways are described in the literature (Silverman, 1988).

4. Practices

As discussed more fully at the beginning of this chapter and in Chapter 1, the following practices are described for illustrative purposes only. State programs need not require implementation of these practices. However, as a practical matter, EPA anticipates that the management measure set forth above generally will be implemented by applying one or more management practices appropriate to the source, location, and climate. The practices set forth below have been found by EPA to be representative of the types of practices that can be applied successfully to achieve the management measure described above.

- a. *Locate runoff treatment facilities within existing rights-of-way or in medians and interchange loops.*
- b. *Develop multiple-use treatment facilities on adjacent lands (e.g., parks and golf courses).*
- c. *Acquire additional land for locating treatment facilities.*
- d. *Use underground storage where no alternative is available.*
- e. *Maximize the length and width of vegetated filter strips to slow the travel time of sheet flow and increase the infiltration rate of urban runoff.*

5. Effectiveness Information and Cost Information

Cost and effectiveness data for structural urban runoff management and pollution control facilities are outlined in Tables 4-15 and 4-16 in Section III and discussed in Section IV of this chapter and are applicable to determine the cost and effectiveness of retrofit projects. Retrofit projects can often be more costly to construct because of the need to locate the required structures within existing space or the need to locate the structures within adjacent property that requires purchase. However, the use of multiple-use facilities on adjacent lands, such as diverting runoff waters to parkland or golf courses, can offset this cost. Nonstructural practices described in the urban section also can be effective in achieving source control. As with other sections of this document, the costs of loss of habitat, fisheries, and recreational areas must be weighed against the cost of retrofitting control structures within existing rights-of-way.

6. Pollutants of Concern

Table 4-31 lists the pollutants commonly found in urban runoff from roads, highways, and bridges and their sources. The disposition and subsequent magnitude of pollutants found in highway runoff are site-specific and are affected by traffic volume, road or highway design, surrounding land use, climate, and accidental spills.

The FHWA conducted an extensive field monitoring and laboratory analysis program to determine the pollutant concentration in highway runoff from 31 sites in 11 States (Driscoll et al., 1990). The event mean concentrations (EMCs) developed in the study for a number of pollutants are presented in Table 4-32. The study also indicated that for highways discharging into lakes, the pollutants of major concern are phosphorus and heavy metals. For highways discharging into streams, the pollutants of major concern are heavy metals—cadmium, copper, lead, and zinc.

Table 4-31. Highway Runoff Constituents and Their Primary Sources

Constituents	Primary Sources
Particulates	Pavement wear, vehicles, atmosphere, maintenance
Nitrogen, Phosphorus	Atmosphere, roadside fertilizer application
Lead	Leaded gasoline (auto exhaust), tire wear (lead oxide filler material, lubricating oil and grease, bearing wear)
Zinc	Tire wear (filler material), motor oil (stabilizing additive), grease
Iron	Auto body rust, steel highway structures (guard rails, bridges, etc.), moving engine parts
Copper	Metal plating, bearing and bushing wear, moving engine parts, brake lining wear, fungicides and insecticides
Cadmium	Tire wear (filler material), insecticide application
Chromium	Metal plating, moving engine parts, brake lining wear
Nickel	Diesel fuel and gasoline (exhaust), lubricating oil, metal plating, bushing wear, brake lining wear, asphalt paving
Manganese	Moving engine parts
Cyanide	Anticake compound (ferric ferrocyanide, sodium ferrocyanide, yellow prussiate of soda) used to keep deicing salt granular
Sodium, Calcium, Chloride	Deicing salts
Sulphate	Roadway beds, fuel, deicing salts
Petroleum	Spills, leaks or blow-by of motor lubricants, antifreeze and hydraulic fluids, asphalt surface leachate

In colder regions where deicing agents are used, deicing chemicals and abrasives are the largest source of pollutants during winter months. Deicing salt (primarily sodium chloride, NaCl) is the most commonly used deicing agent. Potential pollutants from deicing salt include sodium chloride, ferric ferrocyanide (used to keep the salt in granular form), and sulfates such as gypsum. Table 4-33 summarizes potential environmental impacts caused by road salt. Other chemicals used as a salt substitute include calcium magnesium acetate (CMA) and, less frequently, urea and glycol compounds. Researchers have differing opinions on the environmental impacts of CMA compared to those of road salt (Chevron Chemical Company, 1991; Salt Institute, undated; Transportation Research Board, 1991).

Table 4-32. Pollutant Concentrations in Highway Runoff (Driscoll et al., 1990)

Pollutant	Event Mean Concentration for Highways With Fewer Than 30,000 Vehicles/Day ^a (mg/L)	Event Mean Concentration for Highways With More Than 30,000 Vehicles/Day ^a (mg/L)
Total Suspended Solids	41	142
Volatile Suspended Solids	12	39
Total Organic Carbon	8	25
Chemical Oxygen Demand	49	114
Nitrite and Nitrate	0.46	0.76
Total Kjeldahl Nitrogen	0.87	1.83
Phosphate Phosphorus	0.16	0.40
Copper	0.022	0.054
Lead	0.080	0.400
Zinc	0.080	0.329

^aEvent mean concentrations are for the 50% median site.

Table 4-33. Potential Environmental Impacts of Road Salts

Environmental Resource	Potential Environmental Impact of Road Salt (NaCl)
Soils	May accumulate in soil. Breaks down soil structure, increases erosion. Causes soil compaction that results in decreased permeability.
Vegetation	Osmotic stress and soil compaction harm root systems. Spray causes foliage dehydration damage. Many plant species are salt-sensitive.
Ground Water	Mobile Na and Cl ions readily reach ground water. Increases NaCl concentration in well water, as well as alkalinity and hardness.
Surface Water	Causes density stratification in ponds and lakes that can prevent reoxygenation. Increases runoff of heavy metals and nutrients through increased erosion.
Aquatic Life	Monovalent Na and Cl ions stress osmotic balances. Toxic levels: Na - 500 ppm for stickleback; Cl - 400 ppm for trout.
Human/Mammalian	Sodium is linked to heart disease and hypertension. Chlorine causes unpleasant taste in drinking water. Mild skin and eye irritant. Acute oral LD ₅₀ in rats is approximately 3,000 mg/kg (slightly toxic).

VIII. GLOSSARY

Unless otherwise noted, the source of these definitions is *Glossary of Environmental Terms and Acronym List* (USEPA, 1989).

Bankfull event (also bankfull discharge): A flow condition in which streamflow completely fills the stream channel up to the top of the bank. In undisturbed watersheds, the discharge condition occurs on average every 1.5 to 2 years and controls the shape and form of natural channels. (Schueler, 1987)

Berm: An earthen mound used to direct the flow of runoff around or through a best management practice (BMP) (Schueler, 1987).

Constructed urban runoff wetlands: Those wetlands that are intentionally created on sites that are not wetlands for the primary purpose of wastewater or urban runoff treatment and are managed as such. Constructed wetlands are normally considered as part of the urban runoff collection and treatment system.

Conveyance system: The drainage facilities, both natural and human-made, which collect, contain, and provide for the flow of surface water and urban runoff from the highest points on the land down to a receiving water. The natural elements of the conveyance system include swales and small drainage courses, streams, rivers, lakes, and wetlands. The human-made elements of the conveyance system include gutters, ditches, pipes, channels, and most retention/detention facilities (Washington Department of Ecology, 1992).

Denitrification: The anaerobic biological reduction of nitrate nitrogen to nitrogen gas.

Discharge: Outflow; the flow of a stream, canal, or aquifer. One may also speak of the discharge of a canal or stream into a lake, river, or ocean. (Hydraulics) Rate of flow, specifically fluid flow; a volume of fluid passing a point per unit of time, commonly expressed as cubic feet per second, cubic meters per second, gallons per minute, gallons per day, or millions of gallons per day. (Washington Department of Ecology, 1992)

Drainage basin: A geographic and hydrologic subunit of a watershed (Washington Department of Ecology, 1992).

Ecosystem: The interacting system of a biological community and its nonliving environmental surroundings.

Erosion: The wearing away of the land surface by wind or water. Erosion occurs naturally from weather or runoff but can be intensified by land-clearing practices related to farming, residential or industrial development, road building, or timber cutting.

Forebay: An extra storage space provided near an inlet of a BMP to trap incoming sediments before they accumulate in a pond BMP (Schueler, 1987).

Heavy metals: Metallic elements with high atomic weights, e.g., mercury, chromium, cadmium, arsenic, and lead. They can damage living things at low concentrations and tend to accumulate in the food chain.

Illicit discharge: All nonurban runoff discharges to urban runoff drainage systems that could cause or contribute to a violation of State water quality, sediment quality, or ground-water quality standards, including but not limited to sanitary sewer connections, industrial process water, interior floor drains, car washing, and greywater systems (Washington Department of Ecology, 1992).

Impervious surface: A hard surface area that either prevents or retards the entry of water into the soil mantle as under natural conditions prior to development and/or a hard surface area that causes water to run off the surface in greater quantities or at an increased rate of flow from the flow present under natural conditions prior to development. Common impervious surfaces include, but are not limited to, rooftops, walkways, patios, driveways, parking lots,

storage areas, concrete or asphalt paving, gravel roads, packed earthen materials, and oiled, macadam, or other surfaces that similarly impede the natural infiltration of urban runoff. Open, uncovered retention/detention facilities shall not be considered as impervious surfaces. (Washington Department of Ecology, 1992)

Invasive exotic plants: Non-native plants having the capacity to compete and proliferate in introduced environments (Washington Department of Ecology, 1992).

Land conversion: A change in land use, function, or purpose (Washington Department of Ecology, 1992).

Land-disturbing activity: Any activity that results in a change in the existing soil cover (both vegetative and nonvegetative) and/or the existing soil topography. Land-disturbing activities include, but are not limited to, demolition, construction, clearing, grading, filling, and excavation. (Washington Department of Ecology, 1992)

Local government: Any county, city, or town having its own incorporated government for local affairs (Washington Department of Ecology, 1992).

Municipal separate storm sewer systems: Any conveyance or system of conveyance that is owned or operated by the State or local government entity, is used for collecting and conveying storm water, and is not part of a publicly owned treatment works (POTW), as defined in EPA 40 CFR Part III (Washington Department of Ecology, 1992).

Onsite disposal system (OSDS): Sewage disposal system designed to treat wastewater at a particular site. Septic tank systems are common OSDS. (Washington Department of Ecology, 1992)

Organophosphate: Pesticide chemical that contains phosphorus; used to control insects. Organophosphates are short-lived, but some can be toxic when first applied.

Postdevelopment peak runoff: Maximum instantaneous rate of flow during a storm, after development is complete (Washington Department of Ecology, 1992).

Retrofit: The creation or modification of an urban runoff management system in a previously developed area. This may include wet ponds, infiltration systems, wetland plantings, streambank stabilization, and other BMP techniques for improving water quality and creating aquatic habitat. A retrofit can consist of the construction of a new BMP in a developed area, the enhancement of an older urban runoff management structure, or a combination of improvement and new construction. (Schueler et al., 1992)

Soil absorption field: A subsurface area containing a trench or bed with clean stones and a system of distribution piping through which treated sewage may seep into the surrounding soil for further treatment and disposal.

Turbidity: A cloudy condition in water due to suspended silt or organic matter.

Urban runoff: That portion of precipitation that does not naturally percolate into the ground or evaporate, but flows via overland flow, underflow, or channels or is piped into a defined surface water channel or a constructed infiltration facility (Washington Department of Ecology, 1992).

Vegetated buffer: Strips of vegetation separating a waterbody from a land use with potential to act as a nonpoint pollution source; vegetated buffers (or simply buffers) are variable in width and can range in function from a vegetated filter strip to a wetland or riparian area.

Watershed: The land area that drains into a receiving waterbody.

Wetlands: Areas that are inundated or saturated by surface or ground water at a frequency and duration to support, and that under normal circumstances do support, a prevalence of vegetation typically adapted for life in saturated soil conditions; wetlands generally include swamps, marshes, bogs, and similar areas. (This definition is consistent

with the Federal definition at 40 CFR 230.3; December 24, 1989. As amendments are made to the wetland definition, they will be considered applicable to this guidance.)

Xeriscaping: A horticultural practice that combines water conservation techniques with landscaping; also known as dry landscaping (Clemson University Cooperative Extension Service, 1991).

IX. REFERENCES

- AASHTO. 1987. *AASHTO Manual for Bridge Maintenance*. American Association of State Highway Transportation Officials.
- AASHTO. 1988. *Guide Specifications for Highway Construction (Sections 201 and 208)*. American Association of State Highway Transportation Officials.
- AASHTO. 1989. *Standard Specifications for Highway Bridges (Section 1)*. American Association of State Highway Transportation Officials.
- AASHTO. 1990. *Guidelines for Erosion and Sediment Control in Highway Construction - 5th Draft*. American Association of State Highway Transportation Officials.
- AASHTO. 1991a. *A Guide For Transportation Landscape and Environmental Design*. American Association of State Highway Transportation Officials.
- AASHTO. 1991b. *Model Drainage Manual (Chapter 16)*. American Association of State Highway Transportation Officials.
- ABAG. 1979. *Treatment of Stormwater Runoff by a Marsh/Flood Basin: Interim Report*. Association of Bay Area Governments, in association with Metcalf & Eddy, Inc. and Ramlit Associates, Berkeley, CA.
- ABAG. 1991. *San Francisco Estuary Project: Status and Trends Report on Wetlands and Related Habitats in the San Francisco Bay Estuary*. Prepared under cooperative agreement with U.S. EPA. Agreement No. 815406-01-0. Association of Bay Area Governments, Oakland, California.
- Alachua County Office of Environmental Protection. 1991. *Best Management Practices for the Use and Storage of Hazardous Materials*. Gainesville, Florida.
- Amberg, L.W. 1990. *Rock-Plant Filter an Alternative for Septic Tank Effluent Treatment*. U.S. Environmental Protection Agency, Washington, DC.
- American Public Works Association Research Foundation. 1981. *Costs of Stormwater Management Systems*. In *Urban Stormwater Management*. American Public Works Association, Chicago, IL.
- American Public Works Association Research Foundation. 1991. *Water Quality: Urban Runoff Solutions*. The American Public Works Association, Chicago, IL.
- American Society of Agricultural Engineers. 1988. *On-Site Wastewater Treatment Vol. 5*. In *Proceedings of the Fifth National Symposium on Individual and Small Community Sewage Systems*. American Society of Engineers, Chicago, Illinois, December 14-15, 1987. ASAE Publication No. 10-87.
- Apogee Research, Inc. 1991. *Nutrient Trading in the Dillon Reservoir*. Prepared for U.S. Environmental Protection Agency, Office of Water, by Apogee Research, Inc.
- August, L., and T. Graupensperger. 1989. *Impacts of Highway Deicing Programs on Groundwater and Surface Water Quality in Maryland*. In *Proceedings of the Groundwater Issues and Solutions in the Potomac River Basin/Chesapeake Bay Region*. National Water Well Association.
- Balogh, J.C., and W.J. Walker. 1992. *Golf Course Management and Construction: Environmental Issues*. Lewis Publishers, Boca Raton, FL, pp. 24, 244-245.

- Barten, J.M. 1987. Stormwater Runoff Treatment in a Wetland Filter: Effects on the Water Quality of Clear Lake. *Lake and Reservoir Management*, 2:297-305.
- Barrett, T.S., and P. Livermore. 1983. *The Conservation Easement in California*. Island Press, Covelo, CA
- Bassler, R.E., Jr. Undated. Grassed Waterway Maintenance. In *Agricultural Engineering Fact Sheet No. 129*, Cooperative Extension Service, University of Maryland, College Park, MD.
- Baumann, J. 1990. *Wisconsin Construction Site Best Management Practice Handbook*. Wisconsin Department of Natural Resources, Madison.
- Bazemore, D.E., C.R. Hupp, and T.H. Diehl. 1991. *Wetland Sedimentation and Vegetation Patterns Near Selected Highway Crossings in West Tennessee*. U.S. Geological Survey, Reston, VA.
- Beasley, R. 1972. *Erosion and Sediment Pollution Control*. The Iowa State University Press.
- Bennett, D.B., and J.P. Heaney. 1991. Retrofitting for Watershed Drainage. *Water Environment Technology*, 3(9):63-68.
- Birkitt, B.F., et al. 1979. *Effects of Bridging on Biological Productivity and Diversity*. Florida Department of Transportation, Tallahassee.
- Borromeo, N.R. 1992. *Leaching of Turfgrass Pesticides*. A thesis presented to the faculty of the graduate school of Cornell University.
- British Columbia Research Corporation. 1991. *Urban Runoff Quality and Treatment: A Comprehensive Review*. Greater Vancouver Regional District, Vancouver, Canada.
- Broward County, Florida. 1990. *Land Development Code*. Ft. Lauderdale, FL.
- Broward County Planning Council. 1982. *Determining the Effectiveness of Sweeping Commercial Parking Areas to Reduce Water Pollution*. Ft. Lauderdale, FL.
- Brunswick, Maine, Zoning Ordinance. 1991.
- Bubeck, R.C., W.H. Diment, B.L. Deck, A.L. Baldwin, and S.D. Lipton. 1971. Runoff of Deicing Salt: Effect on Irondequoit Bay, Rochester, New York. *Science*, 172:1128-1132.
- Buck, E.H. 1991. *CRS Report for Congress: Corals and Coral Reef Protection*. Congressional Research Service, Washington, DC.
- Butch, G.K. Undated. *Measurement of Scour at Selected Bridges in New York*. U.S. Geological Survey, Reston, VA.
- Buttle, J.M. and F. Xu. 1988. Snowmelt Runoff in Suburban Environments. *Nordic Hydrology*, 19:19-40.
- Cahill Associates. 1991. *Limiting NPS Pollution from New Development in the New Jersey Coastal Zone*. Prepared for the New Jersey Department of Environmental Protection, Trenton.
- Cahill Associates. 1992. *A Comparison: NPS Pollutant Removal Effectiveness for New Land Development Comparing Nonstructural Best Management Practices (Minimum Disturbance/Minimum Maintenance) and Various Structural BMP Techniques*. Prepared for the U.S. Environmental Protection Agency, Nonpoint Source Control Branch, Washington, DC.

- Cahill, T.H., W.R. Horner, J. McGuire, and C. Smith. 1991. *Interim Report: Infiltration Technologies - Draft*. Cahill and Associates. Prepared for the U.S. Environmental Protection Agency, Nonpoint Source Control Branch, Washington, DC.
- Cahoon, D.R., D.R. Clark, D.G. Chambers, and J.L. Lindsey. 1983. Managing Louisiana's Coastal Zone: The Ultimate Balancing Act. In *Proceedings of the Water Quality and Wetland Management Conference*. Louisiana Environmental Professionals Association, New Orleans, LA.
- Campbell, B. 1988. *Methods of Cost-Effectiveness Analysis for Highway Projects*. National Research Council, Transportation Research Board, Washington, DC.
- Canning, D.J. 1988a. *Construction erosion control: Shorelands Technical Advisory Paper No. 3*. Shorelands and Coastal Zone Management Program, Washington Department of Ecology, Olympia, WA.
- Canning, D.J. 1988b. *Urban Runoff Water Quality: Effects and Management Options (Shorelands Technical Advisory Paper No. 4)*. Shorelands and Coastal Zone Management Program, Washington Department of Ecology, Olympia, WA.
- Cape Cod Commission. 1991. *Regional Policy Plan*. Barnstable, MA.
- Carlile, B.L., C.G. Cogger, M.D. Sobsey, J. Scandura, and S.J. Steinbeck. 1981. *Movement and Fate of Septic Tank Effluent in Soils of the North Carolina Coastal Plain*.
- Carr, A., M. Smith, L. Gilkeson, J. Smillie, and B. Wolf. 1991. *Chemical-Free Yard and Garden*. Rodale Press, Emmaus, PA.
- Casman, E. 1990. *Selected BMP Efficiencies Wrenched from Empirical Studies*. Interstate Commission on Potomac River Basin.
- Chesapeake Bay Local Government Advisory Committee. 1988. *Recommendations of the Nonpoint Source Control Subcommittee to the Local Government Advisory Committee Concerning Nonpoint Source Control Needs*. A draft white paper for discussion at the Local Government Advisory Committee's First Annual Conference.
- Chesapeake Bay Program. 1990. *Annual Progress Report for the Baywide Nutrient Strategy*.
- Chevron Chemical Company. 1991. *Comments on Chapter 4, Sections IV and V of EPA's Proposed Guidance Specifying Management Measures for Sources of Nonpoint Pollution in Coastal Waters*. November 4, 1991.
- Chevron Chemical Company and New York State Highway Administration. 1990. *Proceedings on Environmental Symposium on Calcium Magnesium Acetate (CMA)*.
- City of Austin, Texas. 1988a. *Environmental Criteria Manual*. Sections 1.1 through 1.6.
- City of Austin, Texas. 1988b. *Inventory of Urban Nonpoint Source Pollution Control Practices*.
- City of Austin Environmental Resource Management Division, Environmental and Conservation Services Department. 1990. *Removal Efficiencies of Stormwater Control Structures*. Environmental Resource Management, Austin, Texas.
- Clemson University Cooperative Extension Service. 1991. *Xeriscape: Landscape Water Conservation in the Southeast*. Clemson University, Clemson, SC.
- Cohn-Lee, R.G., and D.M. Cameron. 1991. *Urban Stormwater Runoff Contamination of the Chesapeake Bay: Sources and Mitigation*. Natural Resources Defense Council, Water and Coastal Program, Washington, DC.

-
- Colleton Area Joint Planning Advisory Commission. 1988. *Colleton County Development Standards Ordinance*. Walterboro, SC. September 1988.
- Connecticut Council on Soil and Water Conservation. 1988. *Connecticut Guidelines for Soil Erosion and Sediment Control*. Connecticut Council on Soil and Water Conservation, Hartford, CT.
- Cook, A. Guidebook for the PC Gardener. *Washington Post*, September 26, 1991.
- Cooperative Extension Service, University of Maryland. 1991. *Maintaining Your Septic Tank*. Water Resources 28, University of Maryland, Cooperative Extension Service, College Park, MD.
- Dana Duxbury and Associates. 1990. *The National Listing of Household Hazardous Waste Collection Programs 1990*.
- Davenport, T.E. 1988. Nonpoint Source Regulation - A Watershed Approach. In *Nonpoint Pollution: 1988 - Policy, Economy, Management, and Appropriate Technology*. American Water Resources Association and U.S. Environmental Protection Agency, Washington, DC.
- Day, G., D.R. Smith, and J. Bowers. 1981. *Runoff and Pollution Abatement Characteristics of Concrete Grid Pavements*. Virginia Water Resources Research Center, Virginia Polytechnic Institute, Blacksburg, VA.
- Delaware DNREC. 1989. *Delaware Erosion and Sediment Control Handbook*. Delaware Department of Natural Resources and Environmental Control, Dover, DE.
- Decker, R.W. 1987. *Crystal Lake Life or Death*. Board of Public Works, Benzie County, MI.
- Defoe, J.H. 1989. *Evaluation of Improved Calcium Magnesium Acetate as an Ice Control Agent*. Michigan Transportation Commission, Lansing, MI.
- Degen, M.B., R.B. Renbeau, Jr., C. Hagedorn, and D.C. Martens. 1991. *Denitrification in Onsite Wastewater Treatment and Disposal Systems*. Virginia Polytechnic Institute, Blacksburg, VA.
- DeWalle, F.B. 1981. Failure Analysis of Large Septic Tank Systems. *Journal of the Environmental Engineering Division*, 107:229-240. American Society of Civil Engineers.
- Dillaha, T.A., R.B. Reneau, S. Mostaghimi, V.O. Shanholtz, and W.L. Magette. 1987. *Evaluating Nutrient and Sediment Losses from Agricultural Lands: Vegetative Filter Strips*. U.S. Environmental Protection Agency, Chesapeake Bay Program, Annapolis, MD.
- Dillaha, T.A., J.H. Sherrard, and D. Lee. 1989. Long Term Effectiveness of Vegetative Filter Strips. *Water Environment and Technology*, 1:418-421.
- Dix, S.P. 1986. *Case Study No. 4 Crystal Lakes, Colorado*. U.S. Environmental Protection Agency, National Small Flows Clearinghouse, West Virginia University, Morgantown, WV.
- Dorman, M.E., J. Hartigan, R.F. Steg, and T. Quasebarth. 1989. *Retention, Detention and Overland Flow for Pollutant Removal from Highway Stormwater Runoff. Volume I*. Research report. Federal Highway Administration. August 1989.
- Dreher, D.W., and T.H. Price. 1992. *Best Management Practice Handbook for Urban Development*. Northeastern Illinois Planning Commission, Chicago, IL.

- Driscoll, E.D. 1986. Detention and Retention Controls for Urban Runoff. In *Urban Runoff Quality - Impact and Quality Enhancement Technology*, ed. B. Urbonas and L.A. Roesner, American Society of Civil Engineers, pp. 381-393.
- Driscoll, E., P. Shelley, and E. Strecker. 1989a. *Pollutant Loadings and Impacts From Highway Stormwater Runoff - Volume II*. Federal Highway Administration. April 1989.
- Driscoll, E., P. Shelley, and E. Strecker. 1989b. *Pollutant Loadings and Impacts From Highway Stormwater Runoff - Volume IV*. Federal Highway Administration. May 1989.
- Driscoll, E., P. Shelley, and E. Strecker. 1990. *Pollutant Loadings and Impacts From Highway Stormwater Runoff, Volume I*. Federal Highway Administration. April 1990.
- Duda, A.M., and K.D. Cromartie. 1982. Coastal Pollution from Septic Tank Drainfields. *Journal of the Environmental Engineering Division*, 108:1265-1279. American Society of Civil Engineers.
- Dunne, T., and L.B. Leopold. 1978. *Water in Environmental Planning*. W.H. Freeman and Company, San Francisco, CA.
- Dupuis, T.V., et al. 1985. *Effects of Highway Runoff on Receiving Waters. Volume III: Resource Document for Environmental Assessments*. Federal Highway Administration. March 1985. Report No. FHWA/RD-84/064.
- Dupuis, T.V., and N.P. Kobriger. 1985. *Effects of Highway Runoff on Receiving Waters. Volume IV: Procedural Guidelines for Environmental Assessments*. Federal Highway Administration. July 1985. Report No. FHWA/RD-84/065.
- Duxbury, D. 1990. Emerging Prominence for HHW. *Waste Age*, 21:37.
- Dwyer, T., and K. Sylvester. 1989. Natural Processes for Tertiary Treatment of Municipal Wastewater Coupled with Shallow Ground-Water Discharge in a Saltwater Marsh Environment. In *Proceedings of Groundwater Issues and Solutions in the Potomac River Basin/Chesapeake Bay Region*, March 14-16, 1989, National Water Well Association, Washington, DC.
- Enckson, P., G. Camougio, and N. Miner. 1980. Impact Assessment, Mitigation, and Enhancement Measures. In *Highways and Wetlands - Volume II*. Federal Highway Administration. July, 1980.
- Engle, B.W., and Jarrett, A.R. 1990. *Improved Sediment Retention Efficiencies of Sedimentation Basins*. American Society of Agricultural Engineers, Chicago, IL. Paper No. 90-2629.
- Exner, M.E., M.E. Burbach, D.G. Watts, R.C. Shearman, and R.F. Spalding. 1991. Deep Nitrate Movement in the Unsaturated Zone of a Simulated Urban Lawn. *Journal of Environmental Quality*, 20:658-662.
- FHWA. 1985. *Construction Manual*. Federal Highway Administration.
- FHWA. 1987. *Technical Summary, Sources and Migration of Highway Runoff Pollutants*. Federal Highway Administration. Report No. FHWA/RD-84/057-060-XX.
- FHWA. 1991. *Federal-Aid Policy Guide*. Federal Highway Administration.
- Field, R. 1985. Urban Runoff: Pollution Sources, Control, and Treatment. American Water Resource Association, *Water Resources Bulletin*, 21(2).

- Field, R., et al. 1974. Water Pollution and Associated Effects from Street Salting. *Journal of the Environmental Engineering Division*.
- Finnemore, E.J. 1982. Stormwater Pollution Control: Best Management Practices. *Journal of Environmental Engineering*, 108:706-721
- Firehock, K. 1991. *Virginia's Erosion and Sediment Control Law*. Isaac Walton League.
- Fisher, L.S., and Jarrett, A.R. 1984. Sediment Retention Efficiency of Synthetic Filter Fabrics. In *Transactions of the American Society of Agricultural Engineers*, 27(2):429-436.
- Florida Council on Comprehensive Environmental Education. 1987. *Comprehensive Plan for Environmental Education*. Orlando, FL.
- Florida DER. 1988. *Florida Development Manual: A Guide to Sound Land and Water Management*. Florida Department of Environmental Regulation, Tallahassee.
- Foster, B. 1990. Alternative Technologies for Deicing Highways. *National Conference of State Legislatures. State Legislative Report*, 15(10). April 1990.
- Franklin County, Florida. 1987. *Land Planning Regulations for the Appalachicola Bay Area of Critical State Concern*. Franklin County Administration Commission, Appalachicola, FL.
- Fritzche, C. 1987. *CMA in Winter Maintenance: Massachusetts Confronts Environmental Issues*. Public Works.
- Fritzche, C. 1992. Calcium Magnesium Acetate Deicer - An Effective Alternative for Salt-Sensitive Areas. *Water Environment and Technology*.
- Fulhage, C.D., and D. Day. 1988. Design, Installation and Operation of a Low Pressure Pipe Sewage Absorption System in the Missouri Claypan Soil. On-Site Wastewater Treatment Vol. 5. In *Proceedings of the Fifth National Symposium on Individual and Small Community Sewage Systems*, American Society of Agricultural Engineers, Chicago, Illinois, December 14-15, 1987. pp. 114-121. ASAE Publication No. 10-87.
- Galli, J., and R. Dubose. 1990. *Water Temperature and Freshwater Stream Biota: An Overview*. Maryland Department of the Environment, Sediment and Stormwater Administration, Baltimore.
- GESAMP. 1990. *The State of the Marine Environment*, United Nations Environment Program (UNEP) Regional Seas Reports and Studies no. 115. IMO/FAO/UNESCO/WMO/WHO/IAEA/UN/UNEP Joint Group of Experts on the Scientific Aspects of Marine Pollution, New York.
- Glick, R., M.L. Wolfe, and T.L. Thurow. 1991. Urban Runoff Quality as Affected by Native Vegetation. *Presented at the 1991 International Summer Meeting sponsored by American Society of Engineers*, Albuquerque, NM. ASAE Paper No. 91-2067.
- Gold, A.J., T.G. Morton, W.M. Sullivan, and J. McClory. 1987. Leaching of 2,4-D and Dicamba from Home Lawns. *Water, Air, and Soil*, 37:121-129.
- Goldman, C., and G. Maly. 1989. *Environmental Impact of Highway Deicing*. U.C. Dans. Inst.
- Goldman, S.J., K. Jackson, and T.A. Borstztynsky. 1986. *Erosion and Sediment Control Handbook*. McGraw-Hill, Inc.

- Gray, D.H., and A.T. Leiser. 1982. *Biotechnical Slope Protection and Erosion Control*. Van Nostrand Reinhold, New York.
- Griffin, Jr, D.M., C. Randall, and T.J. Grizzard. 1980. Efficient Design of Stormwater Holding Basins Used for Water Quality Protection. *Water Research*, 14:1549-1554.
- Gupta, M.K. 1981. *Constituents of Highway Runoff*. Vol. 1. Federal Highway Administration.
- Hansen, R.C., and K.M. Mancl. 1988. *Modern Composting—A Natural Way to Recycle Wastes*. Ohio State University, Ohio Cooperative Extension Service, Columbus. Bulletin #792.
- Hanson, M.E., and H.M. Jacobs. 1987. Land Use and Cost Impacts of Private Sewage System Policy in Wisconsin. On-Site Wastewater Treatment Vol. 5. In *Proceedings of the Fifth National Symposium on Individual and Small Community Sewage Systems*, Chicago, IL, December 14-15, 1987. pp. 26-39. ASAE Publication No. 10-87.
- Harding, M.V. 1990. Erosion Control Effectiveness: Comparative Studies of Alternative Mulching Techniques. *Environmental Restoration*, pp. 149-156.
- Harper, H.H., M.P. Wanielista, B.M. Fries, and D.M. Baker. 1986. *Stormwater Treatment by Natural Systems*. STAR project #84-026 - Final Report. Florida Department of Environmental Regulation, Tallahassee.
- Hartigen, J.P., T.S. George, T.F. Quasebarth, and M.E. Dorman. 1989. *Retention, Detention, and Overland Flow for Pollutant Removal from Highway Stormwater Runoff. Vol. II Design Guidelines*. Federal Highway Administration. Report No. FHWA/RD-89/203.
- Hawkins, R.H., and J.H. Judd. 1972. Water Pollution as Affected by Street Salting. American Water Resources Association. *Water Resources Bulletin*, 8 (6).
- Healy, K.A. 1982. *Water Compliance Unit Seepage and Pollutant Renovation Analysis for Land Treatment, Sewage Disposal Systems*. Connecticut Department of Environmental Protection, Hartford, CT.
- Hey, D.L., and K.R. Barrett. 1991. Hydrologic, Water Quality, and Meteorologic Studies. In *The Des Plaines River Wetlands Demonstration Project*, Final Draft Report to the Illinois Department of Energy and Natural Resources. Wetlands Research, Inc., Chicago, IL.
- Hickok, E.A., M.C. Hannaman, and N.C. Wenck. 1977. *Urban Runoff Treatment Methods: Volume I - Non-Structural Wetland Treatment*. U.S. Environmental Protection Agency, Office of Research and Development, Municipal Environmental Research Laboratory, Cincinnati, OH. EPA-600/2-77-217.
- Hill, D.E., and C.R. Frink. 1974. *Longevity of Septic Systems in Connecticut Soils*. Connecticut Agricultural Experiment Station Bulletin 747.
- Hoffman, E.J., A.M. Falke, and J.G. Quinn. 1980. Waste Lubricating Oil Disposal Practices in Providence, Rhode Island: Potential Significance to Coastal Water Quality. *Coastal Zone Management Journal*, Vol. 8.
- Holler, S. 1989. Buffer Strips in Watershed Management. In *Watershed Management Strategies for New Jersey*, Cook College Department of Environmental Resources and New Jersey Agricultural Experiment Station, Rutgers University, New Brunswick, NJ, pp. 69-116.
- Horner, R.R. 1988. Environmental Monitoring and Evaluation of Calcium Magnesium Acetate. National Research Council, Transportation Research Board, Washington, DC.
- Horsely Witten Hegeman, Inc. 1991. *Quantification and Control of Nitrogen Inputs to Buttermilk Bay. Vol. I*.

- Houlihan, J.M. 1990. *The Effectiveness of the Maryland Critical Area Act in Reducing Nonpoint Source Pollution to the Rhode River Estuary*. Master's Thesis, University of Maryland, College Park, MD.
- Hoxie, D.C., R.G. Martin, and D.P. Rocque. 1988. A Numerical Classification System to Determine Overall Site Suitability for Subsurface Wastewater Disposal. On-Site Wastewater Treatment Vol. 5. In *Proceedings of the Fifth National Symposium on Individual and Small Community Sewage Systems*, American Association of Agricultural Engineers, Chicago, IL, December 14-15, 1987, pp. 366-374. ASAE Publication No. 10-87.
- Huang, J.Y.C. 1983. Management of On-Site Disposal Systems: Case Study. American Society of Civil Engineers. *Journal of Environmental Engineering*, 109(4):845-858.
- Hurst, C.J., W.H. Benton, and K.A. McClellan, and U.S. Environmental Protection Agency. Undated. Thermal and Water Source Effects upon the Stability of Enteroviruses in Surface Freshwaters. *Canadian Journal of Microbiology*, 35:474-480.
- IEP, Inc. 1991. *Vegetated Buffer Strip Designation Method Guidance Manual. Narragansett Bay Project*. Prepared for U.S. Environmental Protection Agency and the Rhode Island Department of Environmental Management, Providence, RI.
- Indiana Administrative Code. 1991. Cumulative Supplement. Title 327 IAD 2-5-1.
- International City Management Association. 1979. *The Practice of Local Government Planning*. American Planning Association.
- Irwin, G.A., and G.T. Losey. 1978. *Water Quality Assessment of Runoff from a Rural Highway Bridge Near Tallahassee, Florida*. U.S. Geological Survey and the Florida Department of Transportation, Tallahassee.
- Jacobs, H.M. 1992. Planning the use of land for the 21st century. *Journal of Soil and Water Conservation*, 47(1):32-34.
- Jarrett, A.R., D.D. Fritton, and W.E. Sharpe. 1985. *Renovation of Failing Absorption Fields by Water Conservation and Resting*. American Association of Agricultural Engineers, Paper No. 85-2630.
- Jenkins. 1991. *Chesapeake Bay Restoration: Innovations at the Local Level. A Compilation of Local Government Programs*. The Chesapeake Bay Local Government Advisory Committee and the U.S. Environmental Protection Agency, Annapolis, MD.
- Johnson, F., and F. Chang. 1984. *Drainage of Highway Pavements*. Federal Highway Administration, Washington, DC.
- Johnston, K., and C. Kehoe. 1989. Facility Prepares HHW for Recycling, Reuse. *Waste Age*, July 1989.
- Jones, P., B. Jeffrey, P. Walter, and H. Hutc. 1986. *Environmental Impact of Road Salting - State of the Art*. R&D Ontario Ministry.
- Kelly, J., M. Haque, D. Shuping, and J. Zahner. 1991. *Xeriscape: Landscape Water Conservation in the Southeast*. Cooperative Extension Service, Clemson University, Clemson, SC.
- King County Solid Waste Division. 1990. *Local Hazardous Waste Management Plan for Seattle-King County: Final Plan and Environmental Impact Statement for the Management of Small Quantities of Hazardous Waste in the Seattle-King County Region*. King County Department of Public Works, Solid Waste Division, Seattle, WA.

- Klein, R.D. 1985. *Effects of Urbanization on Aquatic Resources*, draft. Maryland Department of Natural Resources, Tidewater Administration, Annapolis, MD.
- Klein, R. 1990. *Protecting the Aquatic Environment From the Effects of Golf Courses*. Community & Environmental Defense Associates, Maryland Line, MD.
- Kobriger, N. et al. 1983. *Guidelines for the Management of Highway Runoff on Wetlands*. National Research Council, Transportation Research Board, Washington, DC.
- Kuo, C.Y., K.A. Cave, and G.V. Loganathan. 1988. Planning of Urban Best Management Practices. American Water Resources Association. *Water Resources Bulletin*.
- Lamb, B., A.J. Gold, G. Loomis, and C. McKiel. 1988. Evaluation of Nitrogen Removal Systems for On-Site Sewage Disposal. On-Site Wastewater Treatment Vol. No. 5. In *Proceedings of the Fifth National Symposium on Individual and Small Community Sewage Systems*. American Society of Agricultural Engineers, Chicago, IL, December 14-15, 1987, pp. 151-160. ASAE Publication No. 10-87.
- Landers, M.N. Undated. *A Bridge Scour Measurement Data Base System*. U.S. Geological Survey, Reston, VA.
- Lemly, D.A. 1982. Erosion Control at Construction Sites on Red Clay Soils. *Environmental Management*, 6(4):343.
- Leonard, D. et al. 1991. *The 1990 National Shellfish Register of Classified Estuarine Waters*. Department of Commerce, National Oceanic and Atmospheric Administration, Strategic Assessment Branch, Washington, DC.
- Leopold, L.B. 1968. *Hydrology for Urban Land Planning*, Circular 559. U.S. Geological Survey, Washington, DC.
- Lindsey G., L. Roberts, and W. Page. 1991. *Stormwater Management Infiltration Practices in Maryland: A Second Survey*. Maryland Department of the Environment, Sediment and Stormwater Administration, Baltimore. June 1991.
- Linker, L. 1989. *Creation of Wetlands for the Improvement of Water Quality: A Proposal for the Joint Use of Highway Right-of-Way*.
- Livingston, E.H., and E. McCarron. 1992. *Stormwater Management: A Guide for Floridians*. Florida Department of Environmental Regulation, Tallahassee.
- Logsdon, G. 1990. Greenhouse Industry Breakthrough: Plant Protection Through Compost. *Biocycle*, January 1990: 52-54.
- Long Island Regional Planning Board. 1982. The Long Island Segment of the Nationwide Urban Runoff Program. Hauppauge, New York. December. Chapter 5, pp. 115-131.
- Long Island Regional Planning Board. 1984. *Nonpoint Source Management Handbook*. Hauppauge, New York.
- Lowrance, R., R. Leonard, and J. Sheridan. 1985. Managing Riparian Ecosystems to Control Nonpoint Pollution. *Journal of Soil and Water Conservation*, 40(1):87-91.
- Lugbill, J. 1990. *Potomac River Basin Nutrient Inventory*. Metropolitan Washington Council of Governments, Washington, DC.
- Macal, C.M., and B.J. Broomfield. 1980. *Costs and Water Quality Effects of Controlling Point and Nonpoint Pollution Sources*. National Science Foundation, Argonne National Laboratory.
- Maddaus, W.O. 1989. *Water Conservation*. American Water Works Association

- Maestri, B., and B. Lord. Undated. *Guide for Mitigation of Highway Stormwater Runoff Pollution*. Society of Transportation Engineers.
- Maine DEP. 1990. *Best Management Practices for Stormwater Management*. Maine Department of Environmental Protection, Bureau of Water Quality, and York County Soil and Water Conservation District, Sanford, ME.
- Maine DEP. 1991. *Stormwater Management Best Management Practices*. Maine Department of Environmental Protection and York County Soil and Water Conservation District, Sanford, ME.
- Mancl, K.M. 1985a. Mound System for Wastewater Treatment. *Agricultural Engineering Fact Sheet*. The Pennsylvania State University, PA.
- Mancl, K.M. 1985b. Septic System Failure. *Agricultural Engineering Fact Sheet*. The Pennsylvania State University, PA.
- Mancl, K., and W. Magette. 1991. Maintaining Your Septic Tank. *Water Resources* 28. Cooperative Extension Service, University of Maryland, College Park, MD.
- Mantell, M.A., S.F. Harper, and L. Propst. 1990. *Creating Successful Communities: A Guidebook to Growth Management Strategies*. Island Press, Washington, DC.
- Marble, A.D. 1990. *A Guide to Wetland Functional Design*. Federal Highway Administration, Washington, DC. July 1990.
- Martin, E.H. 1988. Effectiveness of an Urban Runoff Detention Pond-Wetlands System. *Journal of Environmental Engineering*, 114(4):810-827.
- McKenzie, D., and G. Irwin. 1983. *Water-Quality Assessment of Stormwater Runoff from a Heavily Used Urban Highway Bridge in Miami, Florida*. U.S. Geological Survey and the Florida Department of Transportation, Tallahassee.
- McLusky, D.S. 1989. *The Estuarine Ecosystem*. Chapman and Hall, Inc., New York, NY.
- McNelly, J. Undated. *Yard waste composting guide for Michigan communities*. Michigan Department of Natural Resources, Lansing.
- Maryland Cooperative Extension Service. 1987. *Your Farm and the Chesapeake Bay*, Bay Leaflet 1. Maryland Cooperative Extension Service, Maryland Dept. of Agriculture, Maryland Farm Bureau, and the U.S. Department of Agriculture, Soil Conservation Service, Washington, DC.
- Maryland DOE. 1983. *1983 Maryland Standards and Specifications for Soil Erosion and Sediment Control*. Maryland Department of the Environment, Sediment and Stormwater Administration, Baltimore
- Meeks, G., Jr. 1990. *State Land Conservation and Growth Management Policy: A Legislator's Guide*. National Conference of State Legislators. Washington, DC.
- Meiorin, E.C. 1986. *Urban Stormwater Treatment at Coyote Hills Marsh*. Association of Bay Area Governments, Oakland, CA.
- Metro-Dade Planning Department. 1988. *Comprehensive Development Master Plan*. Miami, FL.
- Minnesota Pollution Control Agency. 1989. *Protecting Water Quality in Urban Areas*. Minnesota Pollution Control Agency, St Paul.

- Misner, M. 1990. King County's Wastemobile Project. *Waste Age*, 21:44.
- Mitchell, D. Undated. *Laboratory and Prototype Onsite Denitrification by an Anaerobic-Aerobic Fixed Film System WWPCRE11*. University of Arkansas.
- Monroe County Florida, Planning Department. Undated. *Monroe County Code*.
- Morris, F.A., M.K. Morris, T.S. Michaud, and L.R. Williams. 1981. *Meadowland Natural Treatment Processes in the Lake Tahoe Basin: A Field Investigation (Final Report)*. U.S. Environmental Protection Agency, Office of Research and Development, Environmental Monitoring Systems Laboratory, Las Vegas, NV. EPA-600/4-81-026.
- Morton, T.G., A.J. Gold, and W.M. Sullivan. 1988. Influence of Overwatering and Fertilization on Nitrogen Losses from Home Lawns. *Journal of Environmental Quality*, 17(1):124-130.
- MSHA. 1990. *Chesapeake Bay Initiatives Action Plan*. Maryland State Highway Association.
- Munsey, C. Project Wipes Out Washouts. *The Capitol*. June 26, 1992.
- Munson, T. 1991. A Flume Study Examining Silt Fences. In *Proceedings of the 5th Federal Interagency Sedimentation Conference, Las Vegas, NV, March 18, 1991*.
- Murray, D., and E. Ulrich. 1976. *An Economic Analysis of the Environmental Impact of Highway Deicing*. U.S. Environmental Protection Agency, Washington, DC.
- MWCOG. 1983. *Urban Runoff in the Washington Metropolitan Area: Final Report Washington, D.C. Area Urban Runoff Project*. Prepared for U.S. Environmental Protection Agency, Nationwide Urban Runoff Program, Washington, DC.
- MWCOG. 1989. *State of the Anacostia - 1989 Status Report*. Metropolitan Washington Council of Governments, Washington, DC.
- MWCOG. 1991. *Coastal Urban NPS Management Measures-Draft Report*. Metropolitan Washington Council of Governments, Washington, DC.
- Myers, J. 1991. *Draft Management Measures for Onsite Sewage Disposal Systems in Coastal Areas*. The Land Management Project. Providence, RI.
- Myers, J.C. 1988. *Governance of Non-Point Source Inputs to Narragansett Bay: A Plan for Coordinated Action*. Prepared for The Narragansett Bay Project, Providence, RI. NBP-88-09.
- Myers, L.H. 1989. Grazing and Riparian Management in Southwestern Montana. In *Practical Approaches to Riparian Res. Management: An Educational Workshop*. Montana State University, pp. 117-120.
- Nassau-Suffolk Regional Planning Board. 1978. *Areawide Water Treatment Management 208 Summary Plan*. Interim report series: 7. Hauppauge, NY. May 1988, pp. 71-218.
- New Hampshire State. 1991. *New Hampshire State Model Shoreland Protection Ordinance*.
- New York State Department of Environmental Conservation. 1986. Best Management Practices. In *Stream Corridor Management: A Basic Reference Manual*. Division of Water, Bureau of Water Quality, Albany, NY. pp. 65-93.
- New York Soil and Water Conservation Society. 1988. *New York Guidelines for Urban Erosion and Sediment Control*. Empire State Chapter, Soil and Water Conservation Service.

Nichols, M., E. Towle, et al. 1977. *Water, Sediments and Ecology of The Mangrove Lagoon and Benner Bay, St. Thomas*. Island Resources Foundation, Virgin Islands, Technical Report 1. Department of Conservation and Cultural Affairs Division of Natural Resources Management, U.S. Virgin Islands.

NOAA. 1991. *Coastal Nonpoint Pollution Control Program: Program Development and Approval Guidance*. U.S. Department of Commerce, National Oceanic and Atmospheric Administration, and U.S. Environmental Protection Agency, Office of Water, Washington, DC.

North Carolina Department of Transportation. 1991. *NCDOT Erosion and Sediment Control Manual - New Standards*.

North Carolina State University. 1990. *Evaluation of the North Carolina Erosion and Sedimentation Control Program*. North Carolina Sedimentation Control Commission, Raleigh. pp. V6-V13.

Northeastern Illinois Planning Commission. 1988. *Model Stream and Wetland Protection Ordinance for the Creation of a Lowland Conservancy Overlay District: A Guide for Local Officials*. Chicago, IL.

Northern Virginia Planning District Commission. 1980. *Guidebook for Screening Urban Nonpoint Pollution Management Strategies. A Final Report*. Prepared for the Metropolitan Washington Council of Governments, Washington, DC.

Northern Virginia Planning District Commission. 1987. *BMP Handbook for the Occoquan Watershed*. Annandale, VA.

NVSWCD. 1991. Newsletter entitled, *Please Don't Feed Our Streams - How to Feed Your Lawn Without Overloading the Bay*. Northern Virginia Soil and Water Conservation District, Lake Barcroft Watershed Improvement District, Northern Virginia Planning District Commission, and Virginia Cooperative Extension Service (Fairfax Office), Fairfax, VA.

Nottingham, D. et al. 1983. *Costs to the Public Due to Corrosive Deicing Chemicals*. Alaska Department of Transportation.

Novotny, V. 1991. *Urban Diffuse Pollution: Sources and Abatement*. *Water Environment and Technology*, December 1991.

Novotny, V., and G. Chesters. 1981. *Handbook of Nonpoint Pollution: Sources and Management*. Van Nostrand Reinhold, New York.

Nutter, W.L., and J.W. Gaskin. 1989. *Role of Streamside Management Zones in Controlling Discharges to Wetlands*. U.S. Department of Agriculture, Forest Service General Technical Report SE-50, pp. 81-84.

O'Neill, W.A., and L. Carothers. 1985. *Connecticut Guidelines for Soil Erosion and Sediment Control*. Connecticut Council on Soil and Water Conservation, January 1985.

Oberts, G., P.J. Wotzka, and J.A. Hartsoe. 1989. *The Water Quality Performance of Select Urban Runoff Treatment Systems: Part One of a Report to the Legislative Commission on Minnesota Resources*. Metropolitan Council of the Twin Cities Area, St. Paul, MN. Pub. No. 590-89-062a.

OECD. 1989. *Curtailing Usage of Deicing Agents in Winter Maintenance*. Organization for Economic Cooperation and Development, Paris.

Olivieri, A.W., R.J. Roche, and G.L. Johnston. 1981. *Guidelines for Control of Septic Tank Systems*. *Journal of the Environmental Engineering Division*, 107:1025-1034.

- Otis, R.J. Undated. Subsurface Soil Absorption of Wastewater: Mound Systems. In *Small Flows Clearinghouse*, ed. West Virginia University, Morgantown.
- Otis, R.J. Undated. Subsurface Soil Absorption of Wastewater: Trenches and Beds. In *Small Flows Clearinghouse*, ed. West Virginia University, Morgantown.
- Pennsylvania Department of Environmental Resources. 1990. *Erosion and Sediment Pollution Control Program Manual*.
- Pitt, D.G. 1990. *Land Use Policy: A Key to Ground Water Management*, Water Resources Information. University of Maryland System, Cooperative Extension Service. Water Resources 33.
- Pitt, D.G., W. Gould, Jr. and L. LaSota. 1990. *Landscape Design to Reduce Surface Water Pollution in Residential Areas*, Water Resources Information. University of Maryland, Cooperative Extension Service. Water Resources 32.
- Pitt, R., and G. Amy. 1973. *Toxic Materials Analysis of Street Contaminants*. U.S. Environmental Protection Agency, Washington, DC.
- Pitt, R. and J. McLean. 1992. Stormwater, Baseflow, and Snowmelt Pollutant Contributions from an Industrial Area. *Water Environment Federation 65th Annual Conference & Exposition, Surface Water Quality & Ecology Symposia, Volume VII*, September 20-24, New Orleans, LA. Order No. C2007.
- Pitt, R., and B. Shawley. 1981. *San Francisco NURP Project: NPS Pollution Management on Castro Valley Creek*. U.S. Environmental Protection Agency, Washington, DC.
- Pitt, R. 1986. Runoff Controls in Wisconsin's Priority Watersheds. Urban Runoff Quality-Impact and Quality Enhancement Technology. In *Proceedings of an Engineering Foundation Conference*, American Society of Civil Engineers, Henniker, NH, June 23-27, 1986, pp. 290-313. ASCE.
- Portele, G., et al. 1982. *Effects of Seattle Area Highway Stormwater Runoff on Aquatic Biota*. Washington State Department of Transportation, Olympia.
- Puget Sound Water Quality Authority. 1986. *Issue paper: Nonpoint source Pollution*. Puget Sound Water Quality Authority, Seattle, WA, May 1986.
- Puget Sound Water Quality Authority. 1989. *Managing Nonpoint Pollution—An Action Plan Handbook for Puget Sound Watersheds*. Puget Sound Water Quality Authority, Seattle, WA.
- Puget Sound Water Quality Authority. 1990. *Pesticides in Puget Sound*. Puget Sound Water Quality Authority, Seattle, WA.
- Puget Sound Water Quality Authority. 1991. *Puget Sound Water Quality Management Plan. Chapter 3: Action Plan. Household Hazardous Waste Program*. Puget Sound Water Quality Authority, Seattle, WA, pp. 134-139.
- Reed, S.C. 1991. Constructed Wetlands for Wastewater Treatment. *BioCycle: Journal of Waste Recycling*.
- Reef Relief. 1992. Brochure for public education on septic tanks. Key West, FL.
- Reneau, R. 1977. Changes in Organic Nitrogenous Compounds from Septic Tank Effluent in a Soil with Fluctuating Water Table. *Journal of Environmental Quality*, 8:189-196.

- Rhode Island, Land Management Project. 1989. *Nitrate Nitrogen Pollution from Septic systems; and Phosphorus Pollution from Septic Systems*. U.S. Environmental Protection Agency, Land Management Project, Providence, RI.
- RIDEM. 1988. *An Assessment of Nonpoint Sources of Pollution to Rhode Island's Waters*. Rhode Island Department of Environmental Management, Providence, RI.
- RIDEM. 1988. *ISDS Task Force Report*, pp. 1-9. Rhode Island Department of Environmental Management, Providence, RI.
- Richardson, D.L., C.P. Campbell, R.J. Carroll, D.I. Hellstrom, J.B. Metzger, P.J. O'Brien, R.C. Terry, and Arthur D. Little, Inc. 1974. *Manual for Deicing Chemicals: Storage and Handling*. NERC, ORD, U.S. Environmental Protection Agency, Washington, DC. EPA 670/2-74-033.
- Richardson, D.L., et al. 1974. *Manual for Deicing Chemicals: Application Practices*. NERC, ORD, U.S. Environmental Protection Agency, Washington, DC.
- Ritter, W. 1986. *Nutrient Budgets for the Inland Bays*.
- Ritter, W. 1990. *Impact of Alternative Onsite Wastewater System on Ground Water Quality in Delaware*.
- Rogers, C.S. 1990. Responses of Coral Reefs and Reef Organisms to Sedimentation. *Marine Ecology Progress Series*, 62:185-202.
- Rushton, B.T., and C. Dye. 1990. Hydrologic and Water Quality Characteristics of a Wet Detention Pond. In *The Science of Water Resources: 1990 and Beyond*, November 4-9, 1990, ed. M. Jennings. American Water Resources Association, Bethesda, MD.
- Salt Institute. Undated a. *Deicing Salt and Our Environment*. Salt Institute, Alexandria, VA.
- Salt Institute. Undated b. *Deicing Salt Facts*. Salt Institute, Alexandria, VA
- Salt Institute. Undated c. *Salt Storage*. Salt Institute, Alexandria, VA
- Salt Institute. Undated d. *Sensible Salting Program*. Salt Institute, Alexandria, VA
- Salt Institute. 1987. *The Salt Storage Handbook*. Salt Institute, Alexandria, VA.
- Salt Institute. 1988. *Snowball Snowfighter*. Salt Institute, Alexandria, VA
- Salt Institute. 1991a. *Salt and Highway Deicing*. Salt Institute, Alexandria, VA.
- Salt Institute. 1991b. *The Snowfighters Handbook*. Salt Institute, Alexandria, VA.
- Sandy, A.T., W.A. Sack, and S.P. Dix. 1988. Enhanced Nitrogen Removal Using a Modified Recirculating Sand Filter (RSF²). On-Site Wastewater Treatment Vol. 5. In *Proceedings of the Fifth National Symposium on Individual and Small Community Sewage Systems*. American Society of Agricultural Engineers, Chicago, IL, December 14-15, 1987. ASAE Publication No. 10-87. pp. 161-170.
- Santa Clara Valley Water Control District. Undated. *Best Management Practices for Automotive-Related Industries. Practices for Sanitary Sewer Discharges and Storm Water Pollution Control*. Santa Clara, CA.

- Santa Clara Valley Water Control District. 1992. *Best Management Practices for Automotive-Related Industries*. Santa Clara Valley Nonpoint Source Pollution Control Program and the San Jose Office of Environmental Management, Santa Clara, CA.
- Sartor, J., and G. Boyd. 1972. *Water Pollution Aspects of Street Surface Contaminants*. U.S. Environmental Protection Agency, Washington, DC.
- Schiffer, D. 1990a. *Wetlands for Stormwater Treatment*. U.S. Geological Survey and the Florida Department of Transportation, Tallahassee.
- Schiffer, D. 1990b. *Impact of Stormwater Management Practices on Groundwater*. U.S. Geological Survey and the Florida Department of Transportation, Tallahassee.
- Schueler, T.R. 1987. *Controlling Urban Runoff: A Practical Manual for Planning and Designing Urban BMPs*. Metropolitan Washington Council of Governments, Washington, DC.
- Schueler, T.R., J. Galli, L. Herson, P. Kumble, and D. Shepp. 1991. Developing Effective BMP Strategies for Urban Watersheds. In *Nonpoint Source Watershed Workshop*, September 1, 1991, Seminar Publication, pp. 69-83. U.S. Environmental Protection Agency, Washington, DC. EPA/625/4-91/027.
- Schueler, T.R., P.A. Kumble, and M.A. Heraty. 1992. *A Current Assessment of Urban Best Management Practices: Techniques for Reducing Non-Point Source Pollution in the Coastal Zone*. Department of Environmental Programs, Metropolitan Washington Council of Governments, Washington, DC.
- Schueler, T.R., and J. Lugbill. 1990. *Performance of Current Sediment Control Measures at Maryland Construction Sites*. Metropolitan Washington Council of Governments, Washington, DC.
- Schultz, W. 1989. *The Chemical-Free Lawn*. Rodale Press, Emmaus, PA.
- Schwab, G., R. Frevert, T. Edminster, and K. Barnes. 1966. *Soil and Water Conservation Engineering*. John Wiley & Sons, Inc, New York.
- Seattle-King County Department of Public Health. 1990. *Local Hazardous Waste Management Plan for Seattle-King County*.
- Shaheen, D. 1975. *Contributions of Urban Roadway Usage to Water Pollution*. U.S. Environmental Protection Agency, Washington, DC.
- Shaver, E. 1991. *Sand Filter Design for Water Quality Treatment*. Presented at 1991 ASCE Stormwater Conference in Crested Butte, CO.
- Shaver, H., and F. Poirko. 1991. *The Role of Education and Training in the Development of the Delaware Sediment and Stormwater Management Program*. Delaware Department of Natural Resources, Dover.
- Silverman, G.S., and M.K. Stenstrom. 1988. Source Control of Oil and Grease in an Urban Area. Design of Urban Runoff Quality Controls. In *Proceedings of an Engineering Foundation Conference*, Potosi, MO, July 10-15, 1988, pp. 403-420. American Association of Civil Engineers.
- Simmons, M.M. 1991. *Coastal Barriers Protection Issues in the 101st Congress*. Congressional Reporting Service, Environment and Natural Resource Policy Division, Washington, DC.
- Small Flows Clearinghouse, West Virginia University, ed. 1989. Small Flows Clearinghouse, Morgantown.

Small Flows Clearinghouse, West Virginia University, ed. 1991. *Very Low Flush Toilets* WWBKG09. (Product information from various vendors.) Small Flows Clearinghouse and West Virginia University, Morgantown.

Small Flows Clearinghouse, West Virginia University, ed. 1992. More States Using Constructed Wetlands for Onsite Wastewater Treatment. *Small Flows*, 6 (1). Small Flows Clearinghouse, West Virginia University, Morgantown.

Small Flows Clearinghouse, West Virginia University, ed. Undated. *On-Site Systems*. (A series of fact sheets.) Small Flows Clearinghouse and West Virginia University, Morgantown.

Small Flows Clearinghouse, West Virginia University, ed. Undated. *Introduction Package on Sand Filters*. Small Flows Clearinghouse and West Virginia University, Morgantown.

Silverman, G.S., M.K. Stenstrom, and S. Fam. 1986. Best Management Practices for Controlling Oil and Grease in Urban Stormwater Runoff. *The Environmental Professional*, 8.

Smith, D.R. 1981. *Life Cycle Cost and Energy Comparison of Grass Pavement and Asphalt Based on Data and Experience from the Green Parking Lot, Dayton, Ohio*. City of Dayton, OH.

Smith, D.R., M.K. Hughes, and D.A. Sholtis. 1981. *Green Parking Lot Dayton, Ohio—An Experimental Installation of Grass Pavement*. City of Dayton, OH.

Smith, D., and B. Lord. 1989. *Highway Water Quality Control—Summary of 15 Years of Research*. Federal Highway Administration, Washington, DC.

Smith, D., and M. Raupp. 1986. Economic and Environmental Assessment of an Integrated Pest Management Program for Community-Owned Landscape Plants. *Journal of Economic Entomology*, 79:162-165.

Sonzogni, W., and T. Heidtke, 1986. Effect of Influent Phosphorus Reductions on Great Lakes Sewage Treatment Costs. American Water Resources Association, *Water Resources Bulletin*, 22(4):623-627.

South Florida Water Management District. 1988. *Biscayne Bay Surface Water Improvement and Management Plan*. West Palm Beach, FL.

Southeastern Wisconsin Regional Planning Commission. 1991. *Costs of Urban Nonpoint Source Water Pollution Control Measures*. SWRPC, Waukesha, WI. Technical Report Number 31.

Spectrum Research, Inc. 1990. *Environmental Issues Related to Golf Course Construction and Management: A Literature Search and Review*. A final report submitted to the United States Golf Association, Green Section. p. 245.

Spotts, D. 1989. *Effects of Highway Runoff on Brook Trout*. Pennsylvania Fish Commission.

Stack, W.P., and K.T. Belt. 1989. Modifying Stormwater Management Basins for Phosphorous Control. *Lake Line*. May 1989, pp. 1-8. (A publication of the Virginia Regional Symposium, April 1988.)

Stanek, III, E.J., R.W. Tuthill, C. Willis, and G.S. Moore. 1987. Household Hazardous Waste in Massachusetts. *Archives of Environmental Health*, 42(2):83-86.

Starr and DeRoo. 1981. The Fate of Nitrogen Fertilizer Applied to Turfgrass. *Crop Science*, 21:351-356.

State of Washington Water Research Center. 1991. Nonpoint Source Pollution: The Unfinished Agenda for the Protection of Our Water Quality. In *Proceedings from the Technical Sessions of the Regional Conference*, March 20-21, Tacoma, WA.

- Swanson, S.W., and S.P. Dix. On-Site Batch Recirculation Bottom Ash Filter Performance. On-Site Wastewater Treatment Vol. No. 5. In *Proceedings of the Fifth National Symposium on Individual and Small Community Sewage Systems*. American Society of Agricultural Engineers, Chicago, IL, December 14-15, 1987, pp. 132-141. ASAE Publication No. 10-87.
- Tahoe Regional Planning Agency. 1988. *Water Quality Management for the Lake Tahoe Region, Handbook of Best Management Practices*, Vol. II. Tahoe Regional Planning Agency, Tahoe, NV.
- The Land Management Project - Rhode Island. 1989. *Land Use and Water Quality; and Best Management Practices Series—Fact Sheets*. The Land Management Project, Providence, RI.
- Transportation Research Board. 1991. *Highway Deicing: Comparing Salt and Calcium Magnesium Acetate*. Transportation Research Board, Washington, DC. Special Report No.235.
- Tull, L. 1990. *Cost of Sedimentation/Filtration Basins*. City of Austin, TX.
- U.S. ACOE. 1990. *Anacostia River Basin Reconnaissance Study*. U.S. Army Corps of Engineers, Baltimore District, Baltimore, MD.
- USDA-SCS. 1986. *Urban Hydrology for Small Watersheds*. U.S. Department of Agriculture, Soil Conservation Service, Washington, DC. Technical Release 55.
- USDA-SCS. 1988. *1-4 Effects of Conservation Practices on Water Quantity and Quality*. U.S. Department of Agriculture, Soil Conservation Service, Washington, DC.
- USDOI. 1991. *Pollution Prevention Handbook: Housing Maintenance*. No. 16 in a series of fact sheets. U.S. Department of the Interior, Office of Environmental Affairs, Washington, DC.
- USDOT, U.S. Coast Guard. Undated. *Bridge Permit Application Guide*. U.S. Department of Transportation, U.S. Coast Guard, Washington, DC.
- USDOT, U.S. Coast Guard. 1983. *Bridge Administration Manual*. U.S. Department of Transportation, U.S. Coast Guard, Washington, DC. M16590.5.
- USEPA. 1973. *Processes, Procedures, and Methods to Control Pollution Resulting from All Construction Activity*. U.S. Environmental Protection Agency, Office of Air and Water Programs, Washington, DC. EPA 430/9-73-007.
- USEPA. 1977a. *Alternatives for Small Wastewater Treatment Systems. (Volumes 1, 2 and 3)*. U.S. EPA Technology Transfer Seminar Publication.
- USEPA. 1977b. *Nonpoint Source-Stream Nutrient Level Relationships: A Nationwide Study*. United States Environmental Protection Agency, Washington, DC. NTIS No. PB-276 600.
- USEPA. 1980. *Design Manual—Onsite Wastewater Treatment and Disposal Systems*. U.S. Environmental Protection Agency, Office of Water, Washington, DC. (in revision).
- USEPA. 1983. *Final Report of the Nationwide Urban Runoff Program*. U.S. Environmental Protection Agency, Water Planning Division, Washington, DC.
- USEPA. 1984. *Handbook: Septage Treatment and Disposal*. U.S. Environmental Protection Agency, Water Planning Division. Municipal Environmental Research Lab, CERL.

USEPA. 1986. *Septic Systems and Groundwater Protection: A Program Manager's Guide and Reference Book*. U.S. Environmental Protection Agency, Office of Water, Washington, DC.

USEPA. 1987a.

USEPA. 1987b. *DRASTIC: A Standardized System for Evaluating Ground Water Pollution Potential Using Hydrogeologic Settings*. U.S. Environmental Protection Agency, Washington, DC. EPA-600/2-87-035.

USEPA. 1988. *Used Oil Recycling*. U.S. Environmental Protection Agency, Washington, DC. EPA/530-SW-89-006.

USEPA. 1989a. *How to Set Up a Local Program to Recycle Used Oil*. U.S. Environmental Protection Agency, Washington, DC. EPA/530-SW-89-039A.

USEPA. 1989b. *Septic Systems*. U.S. Environmental Protection Agency, Office of Water, The Land Management Project, Providence, RI.

USEPA. 1989c. *Recycling Works! State and Local Solutions to Solid Waste Management Problems*. U.S. Environmental Protection Agency, Washington, DC. EPA/530-SW-89-014.

USEPA. 1989d. *Process Design Manual Land Treatment of Municipal Wastewater*. With the U.S. Army Corps of Engineers, U.S. Department of Agriculture, and U.S. Department of the Interior, Washington, DC.

USEPA. 1989e. *Research Review: Nitrate Nitrogen Pollution from Septic Systems*. U.S. Environmental Protection Agency, Office of Water, The Land Management Project, Providence, RI.

USEPA. 1989f. *Research Review: Phosphorus Pollution from Septic Systems*. U.S. Environmental Protection Agency, Office of Water, The Land Management Project, Providence, RI.

USEPA. 1991a. *Guides to Pollution Prevention: The Automotive Refinishing Industry*. U.S. Environmental Protection Agency, Office of Research and Development, Washington, DC. EPA/625/7-91/016. October 1991.

USEPA. 1991b. A Method for Tracing On-Site Effluent from Failing Septic Systems. In *U.S. EPA Nonpoint Source News Notes*. U.S. Environmental Protection Agency, Office of Water, Washington, DC.

USEPA. 1991b. *Snowmelt Literature Review*. Prepared by Tetra Tech for the U.S. Environmental Protection Agency, Washington, DC.

USEPA. 1991d. *Proposed Guidance Specifying Management Measures for Sources of Nonpoint Pollution in Coastal Waters*. U.S. Environmental Protection Agency, Office of Water, Washington, DC.

USEPA. 1992a. *Environmental Impacts of Stormwater Discharges*. U.S. Environmental Protection Agency, Office of Water, Washington, DC.

USEPA. 1992b. Notes of Riparian and Forestry Management. In *U.S. EPA, Nonpoint Source News Notes*. U.S. Environmental Protection Agency, Office of Water, Washington, DC. March 1992, pp. 10-11.

USEPA. 1992c. *Sequencing Batch Reactors for Nitrification and Nutrient Removal*. U.S. Environmental Protection Agency, Office of Water Enforcement and Compliance, Washington, DC.

USFWS. Undated. *Specification: Riparian Forest Buffer*, unpublished memorandum. U.S. Department of Interior, Fish and Wildlife Service, Northeast Region.

- U.S. Geological Survey. 1978. *Effects of Urbanization on Streamflow and Sediment Transport in the Rock Creek and Anacostia River Basins, Montgomery County, Maryland, 1962-74*. Professional paper 1003. United States Government Printing Office, Washington, DC.
- University of Wisconsin. 1978. *Management of Small Waste Flows*. U.S. Environmental Protection Agency, Cincinnati, OH. EPA-600/2-78-173.
- VADCHR and DSWC. 1987. *Chesapeake Bay Research/Demonstration Project Summaries*. July 1, 1984 - June 30, 1985. Virginia Department of Conservation and Historic Resources, Richmond.
- Venhuizen, D. 1991. *Town of Washington, WI, Wastewater System Feasibility Study—Exploration of Treatment Technology and Disposal System Alternatives*. Wisconsin Department of Natural Resources, Madison.
- Venhuizen, D. 1992. *Equivalent Environmental Protection Analysis - Draft*.
- Virginia Cooperative Extension Service of Virginia Polytechnic Institute and State University. 1991. *Report on Pesticides and Fertilizers in the Urban Environment*. Prepared for the Governor and the General Assembly of Virginia. House Document No. 14. Richmond, VA.
- Virginia Department of Conservation and Historic Resources. 1987. *Chesapeake Bay Research/Demonstration Project Summaries, December 2, 1987*.
- Virginia Department of Conservation and Recreation Division of Soil and Water Conservation. 1980, 1990. *Virginia Erosion and Sediment Control Handbook*. Draft.
- Vitaliano, D. 1991a. *An Economic Assessment of the Social Costs of Highway Salting and the Efficiency of Substituting a New Deicing Material*. Rensselaer Polytechnic Institute.
- Vitaliano, D. 1991b. *Infrastructure Costs of Road Salting*. Rensselaer Polytechnic Institute.
- Voorhees, Temple, Barker, and Sloane, Inc. 1989. *Generation and Flow of Used Oil in the United States in 1988*. Undated. Prepared for the U.S. Environmental Protection Agency, Office of Solid Waste, under EPA Contract No. 68-01-7290.
- Wanielista, M., et al. 1978. *Shallow-Water Roadside Ditches for Stormwater Purification*. Florida Department of Transportation, Tallahassee.
- Wanielista, M., et al. 1980. *Management of Runoff from Highway Bridges*. Florida Department of Transportation, Tallahassee.
- Wanielista, M., et al. 1987. *Best Management Practices - Enhanced Erosion and Sediment Control Using Swale Block*. Florida Department of Transportation, Tallahassee. FLDOT-ER-35-87.
- Wanielista, M.P., and Y.A. Yousef, ed. 1985. Overview of BMP's and Urban Stormwater Management. In: *Proceedings: Stormwater Management - "An Update"*, University of Central Florida Environmental Engineering Systems Institute, Orlando, FL. Pub. 85-1.
- Washington State Department of Ecology. 1989. *Nonpoint Source Pollution Assessment and Management Program*. Washington State Department of Ecology, Water Quality Program, Olympia, WA. Document No. 88-17.
- Washington State Department of Ecology. 1990. *1991 Puget Sound Water Quality Management Plan*. Washington State Department of Ecology, Olympia, WA.

- Washington State Department of Ecology. 1991. *Stormwater Management Manual for the Puget Sound Basin - Public Review Draft*. Washington State Department of Ecology, Olympia, WA.
- Washington State Department of Ecology. 1992. *Stormwater Program Guidance Manual for the Puget Sound Basin*. Washington State Department of Ecology, Olympia, WA.
- Washington State Department of Transportation/University of Washington. 1988. *Washington State Department of Transportation, Highway Water Quality Manual*. Chapters 1 and 2. Washington State Department of Transportation, Olympia, WA.
- Washington State Department of Transportation/University of Washington. 1990. *Washington State DOT Highway Water Quality Manual*. Chapter 3. Washington State Department of Transportation, Olympia, WA.
- Welinski and Stack, Baltimore Department of Public Works. 1989. *Detention Basin Retrofit Project and Monitoring Study Results*. Water Quality Management Office, Baltimore, MD.
- Westchester County, New York. 1981. *Highway Deicing Storage and Application Methods*. Westchester County, NY, White Plains.
- Whalen, P.J., and M.G. Cullum. 1989. *An Assessment of Urban Land Use/Stormwater Runoff Quality Relationships and Treatment Efficiencies of Selected Stormwater Management Systems*. South Florida Water Management District Resource Planning Department, Water Quality Division. Technical Publication No. 88-9.
- Wiegand C., T. Schueler, W. Chitterden, and D. Jellick. 1986. Cost of Urban Runoff Quality Controls. Urban Runoff Quality - Impact and Quality Enhancement Technology. In *Proceedings of an Engineering Foundation Conference*, Henniker, NH, June 23-27, 1986. American Society of Civil Engineers, pp. 366-380.
- Wieman, T., D. Komac, and S. Bigler. 1989. *Statewide Experiments with Chemical Deicers—Final Report Winter of '88/'89*. Washington State Department of Transportation, Olympia, WA.
- Wisconsin Department of Natural Resources. 1991. *A Nonpoint Source Control Plan for the Milwaukee River South Priority Watershed Project*. Wisconsin Department of Natural Resources, Nonpoint Source Water Pollution Abatement Program, Madison. PUBL-WR-245-91.
- Wisconsin Legislative Council. 1991. *Wisconsin Legislation on Nonpoint Source Pollution*. Wisconsin Legislative Council, Madison.
- Woodward-Clyde. 1986. *Methodology for Analysis of Detention Basins for Control of Urban Runoff Quality*. Prepared for U.S. Environmental Protection Agency, Office of Water, Nonpoint Source Division, Washington, DC.
- Woodward-Clyde. 1989. *Analysis of Storm Event Characteristics for Selected Rainfall Gages Throughout the United States*.
- Woodward-Clyde. 1990. *Urban Targeting and BMP Selection, An Information and Guidance Manual for State Nonpoint Source Staff Engineers and Managers*. Prepared for the U.S. Environmental Protection Agency, Region 5, Water Division, Chicago, IL, and the Office of Water Regulations and Standards, Washington, DC.
- Woodward-Clyde. 1991a. *The Use of Wetlands for Controlling Stormwater Pollution*. Prepared for U.S. Environmental Protection Agency, Region 5, Chicago, IL.
- Woodward-Clyde. 1991b. *Urban BMP Cost and Effectiveness Summary Data for 6217(g) Guidance: Erosion and Sediment Control During Construction - Draft*. December 12, 1991.

- Woodward-Clyde. 1991c. *Urban Nonpoint Source Pollution Resource Notebook. Final Draft Report.*
- Woodward-Clyde. 1992a. *Urban Management Practices Cost and Effectiveness Summary Data for 6217(g) Guidance: Onsite Sanitary Disposal Systems.* Prepared for U.S. Environmental Protection Agency, Washington, DC.
- Woodward-Clyde. 1992b. *Urban BMP Cost and Effectiveness Summary Data For 6217(g) Guidance: Erosion and Sediment Control During Construction.* Prepared for U.S. Environmental Protection Agency, Washington, DC.
- Wotzka, P., and G. Oberts. 1988. The Water Quality Performance of a Detention Basin-Wetland Treatment System in an Urban Area. In *Nonpoint Pollution: 1988 - Policy, Economy, Management, and Appropriate Technology*, pp. 237-247. American Water Resources Association, Bethesda, MD.
- Yates, M.V. 1985. Septic Tank Density and Groundwater Contamination. *Groundwater*, 23:5.
- Yorke, T.H., and W.J. Herbe. 1978. *Effects of Urbanization on Streamflow and Sediment Transport in the Rock Creek and Anacostia Basins, Montgomery County Maryland, 1962-1974.* Professional Paper 1003. U.S. Geological Survey, Washington, DC.
- Young, G. K., and D. Danner. 1982. *Urban Planning Criteria for Non-Point Source Water Pollution Control.* U.S. Department of the Interior, Office of Water Research and Technology, Washington, DC.
- Younger, L.K., and K. Hodge. 1992. *1991 International Coastal Cleanup Results.* Center for Marine Conservation, Washington, DC.
- Yousef, Y., et al. 1985. *Consequential Species of Heavy Metals in Highway Runoff.* Florida Department of Transportation, Tallahassee.
- Yousef, Y., et al. 1986. *Effectiveness of Retention/Detention Ponds for Control of Contaminants in Highway Runoff.* Florida Department of Transportation, Tallahassee.
- Yousef, Y.A., L. Lin, J. Sloat, and K. Kay. 1991. *Maintenance Guidelines For Accumulated Sediments in Retention/Detention Ponds Receiving Highway Runoff.* Florida Department of Transportation, Tallahassee.
- Yousef, Y.A., M.P. Wanielista, H.H. Harper, D.B. Pearce, and R.D. Tolbert. 1985. *Best Management Practices—Removal of Highway Contaminants by Roadside Swales. Final Report.* Florida Department of Transportation, Tallahassee.
- Yu, S.L., and D.E. Benelmouffok. 1988. Field Testing of Selected Urban BMP's. In *Critical Water Issues and Computer Applications: Proceedings of the 15th Annual Water Resources Conference.* American Society of Civil Engineers, Water Resources Planning and Management Division, pp. 309-312.

CHAPTER 5: Management Measures for Marinas and Recreational Boating

I. INTRODUCTION

A. What "Management Measures" Are

This chapter specifies management measures to protect coastal waters from sources of nonpoint pollution from marinas and recreational boating. "Management measures" are defined in section 6217 of the Coastal Zone Act Reauthorization Amendments of 1990 (CZARA) as economically achievable measures to control the addition of pollutants to our coastal waters, which reflect the greatest degree of pollutant reduction achievable through the application of the best available nonpoint pollution control practices, technologies, processes, siting criteria, operating methods, or other alternatives.

These management measures will be incorporated by States into their coastal nonpoint programs, which under CZARA are to provide for the implementation of management measures that are "in conformity" with this guidance. Under CZARA, States are subject to a number of requirements as they develop and implement their coastal nonpoint pollution control programs in conformity with this guidance and will have some flexibility in doing so. The application of these management measures by States to activities causing nonpoint pollution is described more fully in *Coastal Nonpoint Pollution Control Program: Program Development and Approval Guidance*, published jointly by the U.S. Environmental Protection Agency (EPA) and the National Oceanic and Atmospheric Administration (NOAA).

B. What "Management Practices" Are

In addition to specifying management *measures*, this chapter also lists and describes management *practices* for illustrative purposes only. While State programs are required to specify management *measures* in conformity with this guidance, State programs need not specify or require the implementation of the particular management *practices* described in this document. However, as a practical matter, EPA anticipates that the management measures generally will be implemented by applying one or more management practices appropriate to the source, location, and climate. The practices listed in this document have been found by EPA to be representative of the types of practices that can be applied successfully to achieve the management measures. EPA has also used some of these practices, or appropriate combinations of these practices, as a basis for estimating the effectiveness, costs, and economic impacts of achieving the management measures. (Economic impacts of the management measures are addressed in a separate document entitled *Economic Impacts of EPA Guidance Specifying Management Measures for Sources of Nonpoint Pollution in Coastal Waters*.)

EPA recognizes that there is often site-specific, regional, and national variability in the selection of appropriate practices, as well as in the design constraints and pollution control effectiveness of practices. The list of practices for each management measure is not all-inclusive and does not preclude States or local agencies from using other technically sound practices. In all cases, however, the practice or set of practices chosen by a State needs to achieve the management measure.

C. Scope of This Chapter

This chapter addresses categories of sources of nonpoint pollution from marinas and recreational boating that affect coastal waters. This chapter specifies 15 management measures grouped under two broad headings: (1) siting and design and (2) operation and maintenance.

Each category of sources is addressed in a separate section of this guidance. Each section contains (1) the management measure(s); (2) an applicability statement that describes, when appropriate, specific activities and locations for which the measure is suitable; (3) a description of the management measure's purpose; (4) the basis for the management measure's selection; (5) information on management practices that are suitable, either alone or in combination with other practices, to achieve the management measure; (6) information on the effectiveness of the management measure and/or of practices to achieve the measure; and (7) information on costs of the measure and/or practices to achieve the measure.

D. Relationship of This Chapter to Other Chapters and to Other EPA Documents

1. Chapter 1 of this document contains detailed information on the legislative background for this guidance, the process used by EPA to develop this guidance, and the technical approach used by EPA in this guidance.
2. Chapter 7 of this document contains management measures to protect wetlands and riparian areas that serve a nonpoint source abatement function. These measures apply to a broad variety of sources, including marinas and recreational boating sources.
3. Chapter 8 of this document contains information on recommended monitoring techniques to (1) ensure proper implementation, operation, and maintenance of the management measures and (2) assess over time the success of the measures in reducing pollution loads and improving water quality.
4. EPA has separately published a document entitled *Economic Impacts of EPA Guidance Specifying Management Measures for Sources of Nonpoint Pollution in Coastal Waters*.
5. NOAA and EPA have jointly published guidance entitled *Coastal Nonpoint Pollution Control Program: Program Development and Approval Guidance*. This guidance contains details on how State Coastal Nonpoint Pollution Control Programs are to be developed by States and approved by NOAA and EPA. It includes guidance on the following:
 - The basis and process for EPA/NOAA approval of State Coastal Nonpoint Pollution Control Programs;
 - How NOAA and EPA expect State programs to provide for the implementation of management measures "in conformity" with this management measures guidance;
 - How States may target sources in implementing their Coastal Nonpoint Pollution Control Programs;
 - Changes in State coastal boundaries; and
 - Requirements concerning how States are to implement their Coastal Nonpoint Pollution Control Programs.

E. Problem Statement

Marinas and recreational boating are increasingly popular uses of coastal areas. The growth of recreational boating, along with the growth of coastal development in general, has led to a growing awareness of the need to protect waterways. In the Coastal Zone Management Act (CZMA) of 1972, as amended, Congress declared it to be national policy that State coastal management programs provide for public access to the coasts for recreational purposes. Clearly, boating and adjunct activities (e.g., marinas) are an important means of public access. When these facilities are poorly planned or managed, however, they may pose a threat to the health of aquatic systems and may pose other environmental hazards. Ensuring the best possible siting for marinas, as well as the best available design and

construction practices and appropriate operation and maintenance practices, can greatly reduce nonpoint source (NPS) pollution from marinas.

Because marinas are located right at the water's edge, there is often no buffering of the release of pollutants to waterways. Adverse environmental impacts may result from the following sources of pollution associated with marinas and recreational boating:

- Poorly flushed waterways where dissolved oxygen deficiencies exist;
- Pollutants discharged from boats;
- Pollutants transported in storm water runoff from parking lots, roofs, and other impervious surfaces;
- The physical alteration or destruction of wetlands and of shellfish and other bottom communities during the construction of marinas, ramps, and related facilities; and
- Pollutants generated from boat maintenance activities on land and in the water.

The management measures described in this chapter are designed to reduce NPS pollution from marinas and recreational boating. Effective implementation will avoid impacts associated with marina siting, prevent the introduction of nonpoint source pollutants, and/or reduce the delivery of pollutants to water resources.

Pollution prevention should be at the fore of any NPS management strategy. It is expected that each coastal State's decision on implementation of these management measures will be based on a management strategy that balances the need for protecting the coastal environment and the need to provide adequate public access to coastal waters.

F. Pollutant Types and Impacts

A marina can have significant impacts on the concentrations of pollutants in the water, sediment, and tissue of organisms within the marina itself. Although sources of pollutants outside the marina are part of the problem, marina design, operation, and location appear to play crucial roles in determining whether local water quality is impacted (NCDEM, 1991).

Marina construction may alter the type of habitat found at the site. Alterations can have both negative and positive effects. For example, a soft-bottom habitat (i.e., habitat characterized by burrowing organisms and deposit feeders) could be replaced with a habitat characterized by fouling organisms attached to the marina pilings and bulkhead. These fouling organisms, however, may attract other organisms, including invertebrates and juvenile fish.

The presence of a marina is not necessarily an indicator of poor water quality. In fact, many marinas have good water quality. Despite this, they may still have degraded biological resources and contaminated sediments resulting from bioaccumulation in organisms and adhesion of pollutants to sediments. A brief summary of some of the impacts that can be associated with marina and boating activities is presented below.

1. Toxicity in the Water Column

Pollutants from marinas can result in toxicity in the water column, both lethal and sublethal, related to decreased levels of dissolved oxygen and elevated levels of metals and petroleum hydrocarbons. These pollutants may enter the water through discharges from boats or other sources, spills, or storm water runoff.

Low Dissolved Oxygen. The organics in sewage discharged from recreational boats require dissolved oxygen (DO) to decompose. The biological oxygen demand (BOD) of a waterbody is a measure of the DO required to decompose sewage and other organic matter (Milliken and Lee, 1990). Accumulation of organic material in sediment will result in a sediment oxygen demand (SOD) that can negatively impact water column DO. The effect of boat sewage on

DO can be intensified in temperate regions because the peak boating season coincides with the highest water temperatures and thus the lowest solubilities of oxygen in the water and the highest metabolism rates of aquatic organisms. (As temperature increases, dissolved oxygen levels decrease.) Cardwell and Koons (1981) recorded significant decreases in DO in several northwestern marinas in the late summer and early fall, which are the peak times of marina use. Nixon et al. (1973) measured lower DO levels in an area of marina development than in an adjacent undeveloped bay of similar size. An intensive study in several North Carolina marinas showed significant decreases in DO concentration compared to ambient concentrations in the receiving waterbody. These decreases in DO were thought to result from high SOD within the marinas and poor flushing resulting from improper marina design (NCDEM, 1990).

Metals. Metals and metal-containing compounds have many functions in boat operation, maintenance, and repair. Lead is used as a fuel additive and ballast and may be released through incomplete fuel combustion and boat bilge discharges (NCDEM, 1991). Arsenic is used in paint pigments, pesticides, and wood preservatives. Zinc anodes are used to deter corrosion of metal hulls and engine parts. Copper and tin are used as biocides in antifouling paints. Other metals (iron, chrome, etc.) are used in the construction of marinas and boats.

Many of these metals/compounds are found in marina waters at levels that are toxic to aquatic organisms. Copper is the most common metal found at toxic concentrations in marina waters (NCDEM, 1990, 1991). Dissolved copper was detected at toxic concentrations at several marinas within the Chesapeake Bay (Hall et al., 1987). The input of copper via bottom paints and scrapings has been shown to be quite significant (Young et al., 1974). Tin in the form of butyltin, an extremely potent biocide, has been detected at toxic levels within marina waters nationwide (Stephenson et al., 1986; Maguire, 1986; Grovhoug et al., 1986; Stallard et al., 1987). The use of butyltins in bottom paint is now regulated, and butyltins cannot be used on nonaluminum recreational boats under 25 meters in length. High levels of zinc, chromium, and lead were also detected in waters within North Carolina marinas (NCDEM, 1990). Table 5-1 presents results of a recent study of boatyard hull pressure-washing wastewater in the Puget Sound area that revealed concentrations of metals and other pollutants that are of concern to environmental regulators (METRO, 1992a).

Petroleum Hydrocarbons. McMahon (1989) found elevated concentrations of hydrocarbons in marina waters and attributed them to refueling activities and bilge or fuel discharge from nearby boats.

2. Increased Pollutant Levels in Aquatic Organisms

Aquatic organisms can concentrate pollutants in the water column through biological activity. Copper and zinc concentrations in oysters were significantly higher in oysters in South Carolina and North Carolina marinas than at reference sites (NCDEM, 1991; SCDHEC, 1987). Increased levels of copper, cadmium, chromium, lead, tin, zinc, and PCBs were found in mussels from southern California marina waters (CARWQCB, 1989; Young et al., 1979). Three months after planting, concentrations of lead, zinc, and copper in oysters transplanted to several Australian marinas were two to three times higher than those of control sites (McMahon, 1989). Concentrations of copper in a green algae and the fouling community were significantly higher in a Rhode Island marina area than in adjacent control areas (Nixon et al., 1973). Several polynuclear aromatic hydrocarbons were detected in oyster tissue at marinas in South Carolina (Marcus and Stokes, 1985; Wendt et al., 1990).

3. Increased Pollutant Levels in Sediments

Many of the contaminants found in the storm water runoff of marinas do not dissolve well in water and accumulate to higher concentrations in sediments than in the overlying water. Contaminated sediments may, in turn, act as a source from which these contaminants can be released into the overlying waters. Benthic organisms—those organisms that live on the bottom or in the sediment—are exposed to pollutants that accumulate in the sediments and may be affected by this exposure or may avoid the contaminated area.

Metals. Copper is the major contaminant of concern because most common antifouling paint preparations contain cuprous oxide as the active biocide component (METRO, 1992a). In most cases metals have a higher affinity for sediments than for the water column and therefore tend to concentrate there. A recent Puget Sound area study of

wastewater from boat hull pressure washing found that suspended solids accounted for 96 percent of the copper, 94 percent of the lead, and 83 percent of the zinc in the wastewater (see Table 5-1 for concentrations). Most of the metal concentrations were associated with particles less than 60 microns in size, resulting in their settling out of solution slowly (METRO, 1992a). Stallard et al. (1987) noted that the sediments of nearly every California marina tested had high concentration of butyltins. Marina sites in North Carolina had significantly higher levels of arsenic, cadmium, chromium, copper, lead, mercury, nickel, and zinc than did reference sites (NCDEM, 1991). McMahon (1989) found significantly higher concentrations of copper, lead, zinc, and mercury in the sediments at a marina site than in the parent waterbody. Within the marina, higher levels of copper and lead were found near a maintenance area drain and fuel dock, suggesting the drain as a source of copper and lead and the fuel dock as a possible source of lead. Sediments at most stations within Marina Del Rey were sufficiently contaminated with copper, lead, mercury, and zinc to affect fish and/or invertebrates, especially at the larval or juvenile stage (Soule et al., 1991). Researchers thought that this contamination might account for the absence of more sensitive species and the low diversity within the marina. However, the extent of the sediment contamination resulting from marina-related activities was unclear.

Petroleum Hydrocarbons. Petroleum hydrocarbons, particularly polynuclear aromatic hydrocarbons (PAHs), tend to adsorb to particulate matter and become incorporated into sediments. They may persist for years, resulting in exposure to benthic organisms. Voudrias and Smith (1986) reported that sediments from two Virginia creeks with marinas contained significantly higher levels of hydrocarbons than did control sites. The North Carolina Division of Environmental Management (NCDEM, 1990) found PAHs in the sediments of six marinas, all of which had fuel docks. Nearby reference areas did not appear to be affected. Marcus et al. (1988) found an increase in PAHs in the sediments of two South Carolina marinas. Sources of petroleum hydrocarbons were identified as the origin of

Table 5-1. Boatyard Pressure-washing Wastewater Contaminants and Regulatory Limits in the Puget Sound Area (METRO, 1992)

Analytical Parameter	Units	Untreated Sample (average) ^a	Untreated Sample (high)	Sanitary Sewers (Metro)	Permit Limit Values		
					Sanitary Sewers	Boatyard NPDES	
						Marine	Fresh
pH	pH	7.2	6.7 - 8.2	5.5 - 12.0	— ^c	— ^d	— ^d
Turbidity	ntu	469	1700	— ^c	— ^c	— ^d	— ^d
Suspended Solids	mg/L	800	3100	— ^c	— ^c	— ^c	— ^c
Oil/Grease	mg/L	— ^b	— ^b	100	— ^c	— ^d	— ^d
Copper	mg/L	55	190	8.0	2.4	0.006	0.018
Lead	mg/L	1.7	14	4.0	1.2	0.280	0.068
Zinc	mg/L	6.0	22	10.0	3.3	0.190	0.130
Tin	mg/L	0.49	1.4	— ^e	— ^e	— ^e	— ^e
Arsenic	mg/L	0.08	0.1	4.0	3.6	0.138	0.720

^a Values are based on analysis of 18 samples.

^b Oil and grease not detected by visible inspections.

^c No limit set or known for this parameter.

^d No monitoring requirements, but limits will be based on water-quality criteria.

^e Tin regulated by restrictions on the application of tributyltin paints.

^f Limit values based on 8/13/91 draft of the Boatyard General NPDES Permit.

sediment contamination within several Australian marinas; however, a well-flushed marina in this study did not have an increase in sediment hydrocarbons (McMahon, 1989). This finding supports the supposition that sufficient flushing within a marina basin prevents build-up of pollutants in marina sediments.

4. Increased Levels of Pathogen Indicators

Studies conducted in Puget Sound, Long Island Sound, Narragansett Bay, North Carolina, and Chesapeake Bay have shown that boats can be a significant source of fecal coliform bacteria in areas with high boat densities and low hydrologic flushing (NCDEM, 1990; Sawyer and Golding, 1990; Milliken and Lee, 1990; Gaines and Solow, 1990; Seabloom et al., 1989; Fisher et al., 1987). Fecal coliform levels in marinas and mooring fields become elevated near boats during periods of high boat occupancy and usage. NOAA identified boating activities (the presence of marinas, shipping lanes, or intracoastal waterways) as a contributing source in the closure to harvesting of millions of acres of shellfish-growing waters on the east coast of the United States (Leonard et al., 1989).

5. Disruption of Sediment and Habitat

Boat operation and dredging can destroy habitat; resuspend bottom sediment (resulting in the reintroduction of toxic substances into the water column); and increase turbidity, which affects the photosynthetic activity of algae and estuarine vegetation. Paulson and Da Costa (1991) demonstrated that propeller-induced flows can contribute significantly to bottom scour in shallow embayments and may have adverse effects on water clarity and quality. The British Waterways Board (1983) noted that propeller-driven boats may impact the aquatic environment and result in bank erosion. Waterways with shallow water environments would be affected as follows:

- (1) The propeller would cut off or uproot water plants growing up from the bottom, and
- (2) The propeller agitation of the water (propwash) would disturb the sediments, creating turbidity that would reduce the light available for photosynthesis of plants, impact feeding and clog the breathing mechanisms of aquatic animals, and smother animals and plants.

EPA (1974) noted a resuspension of solids from the bottom and disturbance to aquatic macrophytes following boating activity. Changes in turbidity were dependent on water depth, motor power, operational time and type, and nature of sediment deposits. The increase in turbidity was generally accompanied by an increase in organic carbon and phosphorus concentrations. However, the possible contribution of these nutrients to eutrophication was not determined. The biological communities of rivers may be impacted by boat traffic, which can increase turbidity; resuspend sediments that move into backwaters; create changes in waves, velocity, and pressure; and increase shoreline erosion (USFWS, 1982).

Dredging may alter the marina and the adjacent water by increasing turbidity, reducing the oxygen content of the water, burying benthic organisms, causing disruption and removal of bottom habitat, creating stagnant areas, and altering water circulation (Chmura and Ross, 1978). Some of these impacts (e.g., turbidity and reduced DO) are temporary and without long-term adverse effects. Dredging is addressed under CWA section 404 and associated regulations and is therefore not discussed further in this chapter.

6. Shoaling and Shoreline Erosion

Shoaling and shoreline erosion result from the physical transport of sediment due to waves and/or currents. These waves and currents may be natural (wind-induced, rainfall runoff, etc.) or human-induced (alterations in current regimes, boat wakes, etc.).

The British Waterways Board (1983) noted that when vessel-generated waves reach the shallow margins of a waterway, they can erode the banks and the bed, tending to wash away fringing plants and their associated animal life. The Waterways Board also found that a substantial volume of the sediment that results in shoaling comes from bank erosion and that removal of this material by dredging is a costly recurrent expense, especially where boat traffic causes extensive bank erosion. Factors influencing vessel-generated shoreline erosion include the distance of the boat

from shore, boat speed, side slopes, sediment type, and depth of the waterway (Camfield et al., 1980; Sorensen, 1986; Zabawa and Ostrom, 1980).

G. Other Federal and State Marina and Boating Programs

1. NPDES Storm Water Program

The storm water permit program is a two-phase program enacted by Congress in 1987 under section 402(p) of the Clean Water Act. Under Phase I, National Pollutant Discharge Elimination System (NPDES) permits are required to be issued for municipal separate storm sewers serving large or medium-sized populations (greater than 250,000 or 100,000 people, respectively), and for storm water discharges associated with industrial activity such as certain types of marinas. Permits are also to be issued, on a case-by-case basis, if EPA or a State determines that a storm water discharge contributes to a violation of a water quality standard or is a significant contributor of pollutants to waters of the United States. EPA published a rule implementing Phase I on November 16, 1990.

a. Which marinas are regulated by the NPDES Storm Water Program?

Under the NPDES Storm Water Program, discharge permits are required for point source discharges of storm water from certain types of marinas. A point source discharge of storm water is a flow of rainfall runoff in some kind of discrete conveyance (a pipe, ditch, channel, swale, etc.).

If a marina is primarily in the business of renting boat slips, storing boats, cleaning boats, and repairing boats, and generally performs a range of other marine services, it is classified under the storm water program (using the Standard Industrial Classification (SIC) system developed by the Office of Management and Budget) as a SIC 4493. Marinas classified as SIC 4493 are the type that may be regulated under the storm water program and may be required to obtain a storm water discharge permit.

A marina that is classified as a SIC 4493 is required to obtain an NPDES storm water discharge permit if vehicle maintenance activities such as vehicle (boat) rehabilitation, mechanical repairs, painting, fueling, and lubrication or equipment cleaning operations are conducted at the marina. The storm water permit will apply only to the point source discharges of storm water from the maintenance areas at the marinas. Operators of these types of marinas should consult the water pollution control agency of the State in which the marina is located to determine how to obtain a storm water discharge permit.

b. Which marinas are not regulated by the NPDES Storm Water Program?

Marinas classified as SIC 4493 that are *not* involved in equipment cleaning or vehicle maintenance activities are not covered under the storm water program. Likewise, a marina, regardless of its classification and the types of activities conducted, that has no point source discharges of storm water, is also not regulated under the NPDES storm water program. In addition, some marinas are classified SIC code 5541 - marine service stations and are also not regulated under the NPDES Storm Water Program. These types of marinas are primarily in the business of selling fuel *without vehicle maintenance or equipment cleaning operations*.

c. What marina activities are covered by this guidance?

EPA has not yet promulgated regulations that would designate additional storm water discharges, beyond those regulated in Phase I, that will be required to be regulated in Phase II. Therefore, marina discharges that are not covered under Phase I, including those discharges that potentially may be ultimately covered by Phase II of the storm water permits program, are covered by this management measures guidance and will be addressed by the Coastal Nonpoint Pollution Control Programs. Any storm water discharge at a marina that ultimately is issued an NPDES permit will become exempt from this guidance and from the Coastal Nonpoint Pollution Control Program at the time that the permit is issued.

2. Other Regulatory Programs

The management measures for marinas do not address discharge of sanitary waste from vessels. They do, however, specify a measure to require that new marinas be designed to include pumpout stations and other facilities to handle sanitary waste from marine toilets, also referred to as marine sanitation devices (MSDs), and another measure to ensure that these facilities are properly maintained.

Vessels are not required to be equipped with an MSD. If a boat does have an MSD, however, the MSD has to meet certain standards set by EPA as required by CWA section 312. In addition to EPA standards for MSDs, EPA may allow a State to prohibit all discharges (treated or untreated) from MSDs, thus declaring the area a "no-discharge zone." Any State may apply to the EPA Administrator for designation of a "no-discharge zone" in some or all of the waters of the State; however, EPA must ensure that these waters meet certain tests before granting the application.

The siting and permitting process to which marinas are subject varies from State to State. State and Federal agencies both play a role in this process. Under section 10 of the Rivers and Harbors Act of 1899, the U.S. Army Corps of Engineers (USACE) regulates all work and structures in navigable waters of the United States. Under section 404 of the Clean Water Act, USACE permits are issued or denied to regulate discharges of dredged or fill materials in navigable waters of the United States, including wetlands.

All coastal States with Federally-approved coastal zone management programs can review Federal permit applications, and some States regulate dredge and fill, marshlands, or wetlands permitting for marina development. All States with Federally-approved coastal programs have the authority to object to section 10/section 404 permits if the proposed action is inconsistent with the State's coastal zone management program. Some States require permits for the use of State water bottomlands. States have authority under the Clean Water Act to issue section 401 water quality certifications for Federally-permitted actions as part of their water quality standards program.

The Food and Drug Administration (FDA) has established fecal coliform standards for certified shellfish-growing waters. Each coastal State regulates its own shellfish sanitation program under the National Shellfish Sanitation Program. States must participate if they wish to export shellfish across State lines. Various approaches are used to comply.

Some States also have a State coastal zone management permit providing them authority over development activities in areas located within their defined coastal zone. Alternatively, or in addition to this permitting authority, some States have regulatory planning authority in given areas of the coast, allowing them to influence the siting of marinas, if not their actual design and construction.

Finally, Massachusetts has developed a Harbor Planning Program, and other States (e.g., Connecticut, Rhode Island, New York, and Oregon) are developing similar programs. Municipalities participating in the program develop Harbor Management Plans. The plans must be consistent with approved coastal zone management plans, and they offer benefits such as giving municipalities greater influence over licensing of State tidelands and priority consideration for grants. The plans recommend comprehensive, long-term management programs that help municipalities balance conservation and development, address pollution impacts on a cumulative rather than piecemeal basis, and resolve conflicts over water-dependent and non-water-dependent uses of the waterfront.

H. Applicability of Management Measures

The management measures in this chapter are intended to be applied by States to control impacts to water quality and habitat from marina siting, construction (both new and expanding marinas), and operation and maintenance, as well as boat operation and maintenance. Under the Coastal Zone Act Reauthorization Amendments of 1990, States are subject to a number of requirements as they develop coastal nonpoint source (NPS) programs in conformity with the management measures and will have some flexibility in doing so. The application of these management measures

by States is described more fully in *Coastal Nonpoint Pollution Control Program: Program Development and Approval Guidance*.

The management measures for marinas are applicable to the facilities and their associated shore-based services that support recreational boats and boats for hire. The following operations/facilities are covered by the management measures of this chapter:

- Any facility that contains 10 or more slips, piers where 10 or more boats may tie up, or any facility where a boat for hire is docked;
- Boat maintenance or repair yards that are adjacent to the water;
- Any Federal, State, or local facility that involves recreational boat maintenance or repair that is on or adjacent to the water;
- Public or commercial boat ramps;
- Any residential or planned community marina with 10 or more slips; and
- Any mooring field where 10 or more boats are moored.

Many States already use a 5- to 10-slip definition for marinas. The 10-slip definition for marinas is also based on Federal legislation that implements MARPOL (the International Convention for the Prevention of Pollution from Ships). This legislation requires adequate waste disposal facilities for ships at facilities with 10 or more slips. This guidance is not intended to address shipyards where extensive repair and maintenance of larger vessels occur. Such facilities are subject to NPDES point source and storm water permitting requirements.

Certain types of changes or additions to existing marinas may produce insignificant differences in impacts from such marinas, while other types of changes and expansions may have a far greater effect. Activities that alter the design, capacity, purpose, or use of the marina are subject to the siting and design management measures. The States are to define: (1) activities that significantly change the physical configuration or construction of the marina, (2) activities that significantly change the number of vessels accommodated, or (3) the operational changes that significantly change the potential impacts of the marina. Potential changes to marinas may be treated in the same manner as new marinas; i.e., the changes to the marina would be subject to applicable siting and design management measures.

The management measures for siting and design are applicable to new marinas. Application of the management measures to expanding marinas should be done on a case-by-case basis and should hinge on the potential for the expansion to impact water quality and important habitat. For example, an expanding marina would not be required to implement the flushing, water quality assessment, or shoreline stabilization management measures if the expansion involved only an increase in the number of parking spaces. The storm water runoff management measure is the only siting and design measure that is always applicable to existing and expanding marinas, as well as new marinas.

One method that has been used successfully by several States to determine whether an alteration/expansion is significant is to set a marina perimeter when the marina is constructed. Thereafter, alterations that occur within that perimeter (such as dock reconfiguration) are considered not significant. Another method that States have used is to set a limit, such as a 25 percent increase in the number of slips or a set number of slips (e.g., an increase of more than five slips is considered significant). Rhode Island has successfully implemented a combination of these methods (Rhode Island Coastal Resources Management Program, Section 300.4).

Changes to a marina may also result from catastrophic natural disasters such as hurricanes and severe flooding. It is possible, in smaller marinas, that efforts to rebuild need not be subject to all siting and design management measures.

II. SITING AND DESIGN

Siting and design are among the most significant factors affecting a marina's potential for water quality impacts. The location of a marina—whether it is open (located directly on a river, bay, or barrier island) or semi-enclosed (located on an embayment or other protected area)—affects its circulation and flushing characteristics. Circulation and flushing can also be influenced by the basin configuration and orientation to prevailing winds. Circulation and flushing play important roles in the distribution and dilution of potential contaminants. The final design is usually a compromise that will provide the most desirable combination of marina capacity, services, and access, while minimizing environmental impacts, dredging requirements, protective structures, and other site development costs. The objective of the marina siting and design management measures is to ensure that marinas and ancillary structures do not cause direct or indirect adverse water quality impacts or endanger fish, shellfish, and wildlife habitat both during and following marina construction.

Many factors influence the long-term impact a marina will have on water quality within the immediate vicinity of the marina and the adjacent waterway. Initial marina site selection is the most important factor. Selection of a site that has favorable hydrographic characteristics and requires the least amount of modification can reduce potential impacts. Because marina development can result in reduced levels of dissolved oxygen, many waters with average dissolved oxygen concentrations barely at or below State standards may be unsuitable for marina development.

A. Marina Flushing Management Measure

Site and design marinas such that tides and/or currents will aid in flushing of the site or renew its water regularly.

1. Applicability

This management measure is intended to be applied by States to new and expanding¹ marinas. Under the Coastal Zone Act Reauthorization Amendments of 1990, States are subject to a number of requirements as they develop coastal nonpoint source programs in conformity with this measure and will have some flexibility in doing so. The application of management measures by States is described more fully in *Coastal Nonpoint Pollution Control Program: Program Development and Approval Guidance*, published jointly by the U.S. Environmental Protection Agency (EPA) and the National Oceanic and Atmospheric Administration (NOAA) of the U.S. Department of Commerce.

2. Description

The term *flushing* or *residence time* is often misused in that a single number (e.g., 10 days) is sometimes given to describe the flushing time of an estuary or harbor. In actuality, the flushing time ranges from zero days at the boundary to possibly several weeks, depending on location within the marina waterbody.

Maintaining water quality within a marina basin depends primarily on flushing as determined by water circulation within the basin (Tsinker, 1992). If a marina is not properly flushed, pollutants will concentrate to unacceptable levels in the water and/or sediments, resulting in impacts to biological resources (McMahon, 1989; NCDEM, 1990, 1991). In tidal waters, flushing is primarily due to tidal advective mixing and is controlled by the movement of the tidal prism into and out of the marina waterbody. A large tidal prism relative to the mean total volume of the waterbody indicates a large potential for flushing because more of the "old" water has a chance to become mixed with the "new" water outside the boundary or opening to the waterbody.

In nontidal coastal waters, such as the Great Lakes, wind drives circulation in the adjacent waterbody, causing a velocity shear between the marina basin and the adjacent waterbody and thereby producing one or more circulation cells (vortices). Such cells can have a flushing effect on water within a marina. The current created by local wind conditions is influenced by its persistence in terms of velocity and direction. The depth of the affected water layer is controlled by temperature and how the salinity changes with depth. Several hours of consistent wind are required for full development of wind-driven currents. These currents can be 2 percent of the wind's velocity and are generally downwind in most shallow areas (Tobiasson and Kollmeyer, 1991). In many situations wind-driven currents will provide adequate flushing of marina basins.

The degree of flushing necessary to maintain water quality in a marina should be balanced with safety, vessel protection, and sedimentation. Wave energy should be dissipated adequately to ensure that boater safety and protection of vessels are not at risk. The protected nature of marina basins can result in high sedimentation rates in waters containing high concentrations of suspended solids. Methods for assessing and mitigating sedimentation rates are available (NRC, 1987).

¹ Refer to Section I.H (General Applicability) for additional information on expansions of existing marinas.

3. Management Measure Selection

The measure was selected because it has been shown that adequate flushing will greatly reduce or eliminate the potential for stagnation of water in a marina and will help maintain biological productivity and aesthetics (Tsinker, 1992; SCCC, 1984). Presented below are some illustrative examples of flushing guidelines in different coastal regions and different conditions. In areas where tidal ranges do not exceed 1 meter, as in the southeastern United States, a flushing reduction (the amount of a conservative substance that is flushed from the basin) of 90 percent over a 24-hour period has been recommended. For example, a flushing analysis for a proposed marina/canal on the St. Johns River, Florida, was conducted to predict how an effluent would disperse and to determine the configuration that would provide for maximum flushing of a hypothetical conservative pollutant (Tetra Tech, 1988). The selected design provided the recommended flushing reduction of 90 percent over a 24-hour period. This study showed that employing modeling to demonstrate how to achieve the recommended flushing rate is effective at avoiding adverse water quality and other environmental impacts. In the Northwest, a minimum flushing reduction of 70 percent per day was judged to be adequate (Cardwell and Koons, 1981). The 70 percent value, which represents the overall mean flushing rate for the marina basin, was based on the prevailing 1.82-meter tidal range for a 24-hour period. However, if the marina was in a protected area, such as an estuary or embayment, where tidal ranges never attain 1.82 meters, then a minimum flushing reduction of approximately 85 percent per day was recommended.

4. Practices

As discussed more fully at the beginning of this chapter and in Chapter 1, the following practices are described for illustrative purposes only. State programs need not require implementation of these practices. However, as a practical matter, EPA anticipates that the management measure set forth above generally will be implemented by applying one or more management practices appropriate to the source, location, and climate. The practices set forth below have been found by EPA to be representative of the types of practices that can be applied successfully to achieve the management measure described above.

- a. *Site and design new marinas such that the bottom of the marina and the entrance channel are not deeper than adjacent navigable water unless it can be demonstrated that the bottom will support a natural population of benthic organisms.*

Existing water depths can affect the entire marina layout and design. Therefore, if depth information is not available, bathymetric surveys should be conducted in the proposed marina basin area as well as in those areas that will be used as channels, whether existing or proposed (Schluchter and Slotta, 1978). Flushing rates in marinas can be maximized by proper design of the entrance channel and basins. For example, in areas of minimal or no tides, marina basin and channel depths should be designed to gradually increase toward open water to promote flushing (USEPA, 1985a). Otherwise, isolated deep holes where water can stagnate may be created (SCCC, 1984).

Good flushing alone does not guarantee that a marina's deepest waters will be renewed on a regular basis. Several studies have concluded that deep canals and holes deeper than adjacent waters are not adequately flushed by tidal action or by wind-generated forces and thus cause stagnant or semi-stagnant conditions (Walton, 1983; Barada and Partington, 1972). Lower layers in canals and basins can act as traps for fine sediment and organic detritus and exhibit low dissolved oxygen concentrations. Lower-layer stagnation can occur in holes of depths less than 10 feet (Murawski, 1969). The low DO concentrations, resulting from an oxygen demand exerted by resuspended sediments and decaying organic matter, can impact aquatic life in the warmer months when the normal DO concentration is lower because of higher temperatures (Sherk, 1971). Fine sediments trapped in deep holes may form a thin surface ooze, which gives poor internal oxygen circulation and leads to oxygen reduction both within the sediments and in the overlying water (USEPA, 1976).

- b. *Design new marinas with as few segments as possible to promote circulation within the basin.*

Flushing efficiency for a marina is inversely proportional to the number of segments. For example, a one-segment marina will not flush as well as a marina in open water, a two-segment marina will not flush as well as a one-

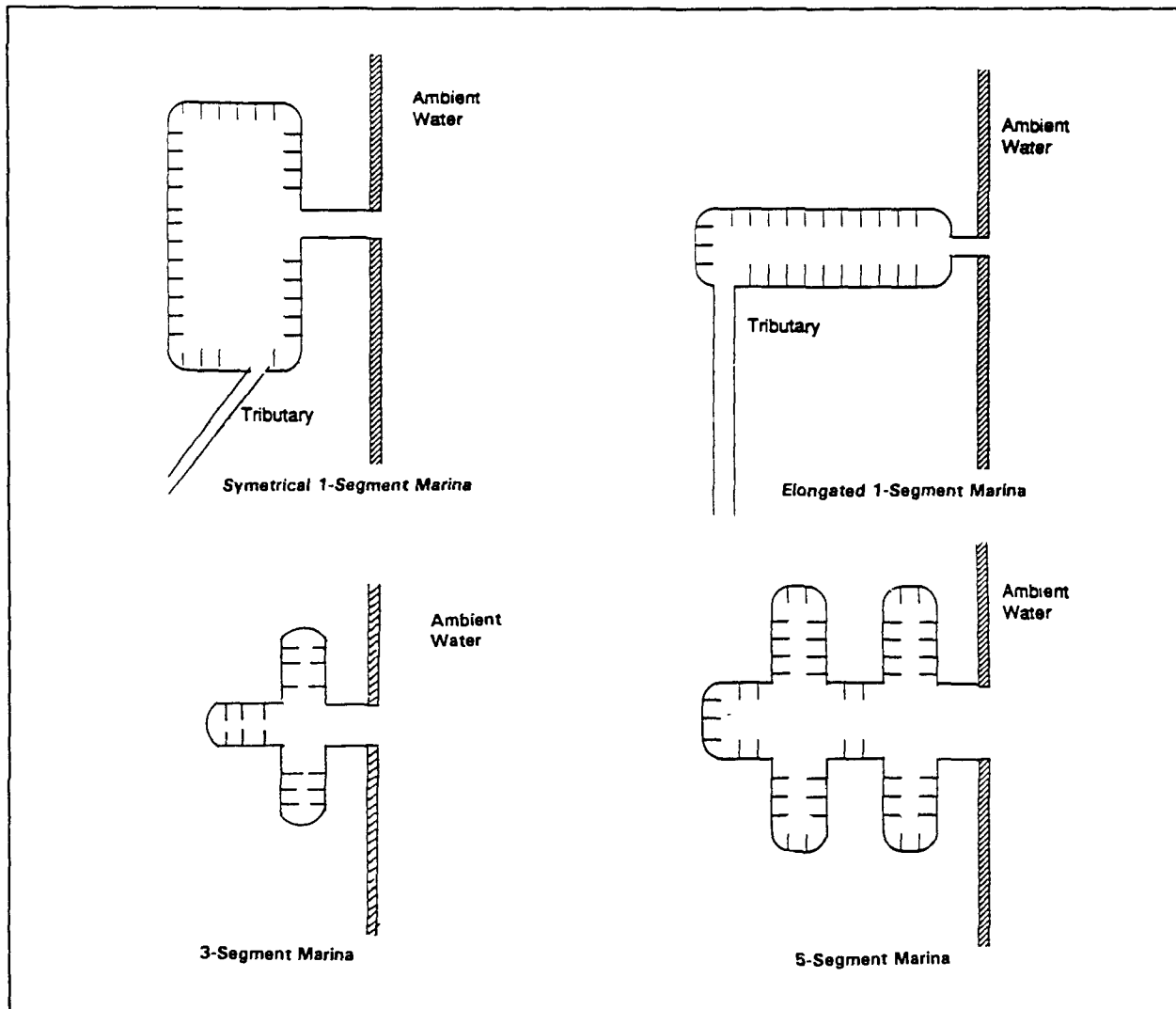

Figure 5-1. Example marina designs (adapted from DNREC, 1990).

segment marina, and so forth. Figure 5-1 presents examples of marinas with one segment and more than one segment. The physical configuration of the proposed marina as determined by the orientation of the marina toward the natural water flow can have a significant effect on the flushing capacity of the waterway. The ideal situation is one in which the distance between the exchange boundary and the inner portion of the basin is minimized. As the shape of the basin becomes more elongated (i.e., more than one segment) with respect to total surface area, the tidal advective or other dispersive mixing processes become more confined along a single flow path, and it takes longer for a water particle originating in the inner part of the basin to travel the greater distance to the boundary.

The marina's aspect ratio (the ratio of its length to its breadth) should be used as a guideline for marina basin design with respect to flushing. This ratio should be greater than 0.33 and less than 3.0, preferably between 0.5 and 2.0 (Cardwell and Koons, 1981). For rectangular marinas with one entrance connected directly to the source waterbody, the length-to-breadth ratio should be between 0.5 and 3.0 to eliminate secondary circulation cells where mixing and tidal flushing are reduced (McMahon, 1989).

Marina configurations that promote flushing exhibit, in general, better dissolved oxygen conditions than those with restrictions or stagnant areas such as improper entrance channel design, bends, and square corners (NCDEM, 1990). These areas also tend to trap sediment and debris. If debris are allowed to collect and settle to the bottom, an oxygen demand will be imposed on the water and water quality will suffer. Therefore, square corners should be

avoided in critical downwind or similar areas where this is most likely to be a problem. If square corners are unavoidable because of other considerations, then points of access should be provided in those corners to allow for easy cleanout of accumulated debris.

In tidal waters, marina design should replace conventional rectangular boat basin geometry with curvilinear geometry to eliminate the stagnation effects of sharp-edged corners and to exploit the natural hydraulic patterns of flow and prevent the occurrence of areas where flushing is negligible (Cardwell and Koons, 1981). By combining these elements in the design of a marina, analytical studies have suggested that a strong internal basin circulation system could develop, resulting in acceptable water quality levels (Layton, 1991).

■ c. *Consider other design alternatives in poorly flushed waterbodies (open marina basin over semi-enclosed design; wave attenuators over a fixed structure) to enhance flushing.*

In selecting a marina site and developing a design, consideration of the need for efficient flushing of marina waters should be a prime factor along with safety and vessel protection. For example, sites located on open water or at the mouth of creeks and tributaries usually have higher flushing rates. These sites are generally preferable to sites located in coves or toward the heads of creeks and tributaries, locations that tend to have lower flushing rates.

In poorly flushed waterbodies, special arrangements may be necessary to ensure adequate overall flushing. In these areas, selection of an open marina design and/or the use of wave attenuators should be considered. Open marina designs have no fabricated or natural barriers, which tend to restrict the exchange of water between ambient water and water within the marina area. Wave attenuators improve flushing rates because water exchange is not restricted. They are also attractive because they do not interfere with the bottom ecology or aesthetic view. Other advantages include their easy removal and minimization of potential interference with fish migration and shoreline processes (Rogers et al., 1982).

The effectiveness of wave attenuators is usually dependent on their mass (Tobiasson and Kollmeyer, 1991). The greater the horizontal and draft dimensions, the greater their displacement and effectiveness. Floating wave attenuators have limitations on their use in extreme wave fields, and site-specific studies should be performed as to their suitability.

■ d. *Design and locate entrance channels to promote flushing.*

Entrance channel alignment should follow the natural channel alignment as closely as possible to increase flushing. Any bends that are necessary should be gradual (Dunham and Finn, 1974). In areas where the tidal range is small, it is recommended that the marina's entrance be designed as wide as possible to promote flushing while still providing adequate protection from waves (USEPA, 1985a). In areas where the tidal range is large, however, a single narrow entrance channel, if properly designed, has proven to provide adequate flushing (Layton, 1991).

Entrance channel design and placement can alleviate potential water quality problems. In tidal and nontidal waters, marina flushing rates are enhanced by wind action when entrance channels are aligned parallel to the direction of prevailing winds because wind-generated currents can mix basin water and facilitate circulation between the basin and the adjacent waterway (Christensen, 1986).

Shoaling may be significant in areas of significant bed load transport if the entrance channel is located perpendicular to the waterway. Increased shoaling could require extensive maintenance dredging of the channel or create a sill at the entrance to the marina basin. Shoaling at the marina entrance can lead to water quality problems by reducing flushing and water circulation within the basin (Tetra Tech, 1988; USEPA, 1985a). In Panama City, Florida, a study of bathymetric surveys before and after the construction of an artificial inlet showed that the areas of deposition and erosion in the natural bay rapidly changed as a result of alterations of channel positions and depths (Johnston, 1981).

The orientation and location of a solitary entrance can impact marina flushing rates and should be given consideration along with other factors impacting flushing. When a marina basin is square or rectangular, a single entrance at the

center of a marina produces better flushing than does a single corner-located asymmetric entrance (Nece, 1981). This results in part because the jet entering the marina on the flood tide is able to circumnavigate a greater length of the sub-basin perimeter associated with each of the two gyres than it could in a single-gyre basin with an asymmetric entrance. If the marina basin is circular, an off-center entrance channel will promote better circulation. Off-center entrance channels also promote better circulation in circular canals.

- e. *Establish two openings, where appropriate, at opposite ends of the marina to promote flow-through currents.*

Where water-level fluctuations are small, alternatives in addition to the ones previously discussed should be considered to ensure adequate water exchange and to increase flushing rates (Dunham and Finn, 1974). An elongated marina situated parallel to a tidal river can be adequately flushed using two entrances to establish a flow-through current so that wind-generated currents or tidal currents move continuously through the marina. In situations where both openings cannot be used for boat traffic, a smaller outlet onto an adjacent waterbody can be opened solely to enhance flushing. In other situations a buried pipeline has been used to promote flushing.

- f. *Designate areas that are and are not suitable for marina development; i.e., provide advance identification of waterbodies that do and do not experience flushing adequate for marina development.*

For example, the physical characteristics of some small tidal creeks result in poor flushing and increased susceptibility to water quality problems (Klein, 1992). These characteristics include:

- Bottom configuration — Flushing is retarded when a depression exists that is lower than the entrance to the waterway.
- Entrance configuration — A constricted entrance will decrease flushing.
- Tributary inflow — Higher freshwater inflow will increase flushing.
- Tidal range — Increased tidal range will increase flushing.
- Shape of the waterway — As the configuration of a waterway becomes more convoluted and irregular, flushing tends to decrease.

B. Water Quality Assessment Management Measure

Assess water quality as part of marina siting and design.

1. Applicability

This management measure is intended to be applied by States to new and expanding² marinas. Under the Coastal Zone Act Reauthorization Amendments of 1990, States are subject to a number of requirements as they develop coastal nonpoint source programs in conformity with this measure and will have some flexibility in doing so. The application of management measures by States is described more fully in *Coastal Nonpoint Pollution Control Program: Program Development and Approval Guidance*, published jointly by the U.S. Environmental Protection Agency (EPA) and the National Oceanic and Atmospheric Administration (NOAA) of the U.S. Department of Commerce.

2. Description

Assessments of water quality may be used to determine whether a proposed marina design will result in poor water quality. This may entail predevelopment and/or postdevelopment monitoring of the marina or ambient waters, numerical or physical modeling of flushing and water quality characteristics, or both. Cost impacts may preclude a detailed water quality assessment for marinas with 10 to 49 slips (See *Economic Impacts of EPA Guidance Specifying Management Measures for Sources of Nonpoint Pollution in Coastal Waters*.) A preconstruction inspection and assessment can still be expected, however. Historically, water quality assessments have focused on two parameters: dissolved oxygen (DO) and pathogen indicators. The problems resulting from low DO in surface waters have been recognized for over a century. The impacts of low DO concentrations are reflected in an unbalanced ecosystem, fish mortality, and odor and other aesthetic nuisances. DO levels may be used as a surrogate variable for the general health of the aquatic ecosystem (Thomann and Mueller, 1987). Coastal States use pathogen indicators, such as fecal coliform bacteria (*Escherichia coli*) and enterococci, as a surrogate variable for assessing risk to public health through ingestion of contaminated water or shellfish (USEPA, 1988) and through bathing (USEPA, 1986).

Dissolved Oxygen. Three important factors support the use of DO as an indicator of water quality associated with marinas. First, low DO is considered to pose a significant threat to aquatic life. For example, fish and invertebrate kills due to low DO are well known and documented (Cardwell and Koons, 1981). Second, DO is among the few variables that have been measured historically with any consistency. A historical water quality baseline is extremely useful for predicting the impacts of a proposed marina. Third, DO is fundamentally important in controlling the structure—and, in some areas, the productivity—of biological communities.

Pathogen Indicators. Marinas in the vicinity of harvestable shellfish beds represent potential sources for bacterial contamination of the shellfish. Siting and construction of a marina or other potential source of human sewage contiguous to beds of shellfish may result in closure of these beds. Also, nearby beaches and waters used for bathing should be considered.

Fecal coliform bacteria, *Escherichia coli*, and enterococci are used as indicators of the pathogenic organisms (viruses, bacteria, and parasites) that may be present in sewage. These indicator organisms are used because no reliable and

² Refer to Section I.H (General Applicability) for additional information on expansions of existing marinas.

cost-effective test for pathogenic organisms exists. Water quality assessments can be used to ensure that water quality standards supporting a designated use are not exceeded. For example, in waters approved for shellfish harvesting, a marina water quality assessment could be used to document potential fecal coliform concentrations in the water column in excess of the standard of 14 organisms MPN (most probable number) per 100 milliliters of water. This standard should not be exceeded in areas where the exceedance would result in the closure of harvestable or productive shellfish beds. Many States have adopted EPA's 1986 ambient water quality criteria for bacteria, which recommend *E. coli* and enterococci as indicators of pathogens for freshwater and marine bathing.

3. Management Measure Selection

Selection of this measure was based on the widespread use and proven effectiveness of water quality assessments in the siting and design of marinas. The North Carolina Department of Environmental Management conducted a postdevelopment study to characterize the water quality conditions of several marinas and to provide data that can be used to evaluate future marina development (NCDEM, 1990). The sampling program demonstrated that marina water quality monitoring studies are effective at assessing potential water quality impacts from coastal marinas. Water quality assessments have been used successfully at a variety of other proposed marina locations nationwide to determine potential water quality impacts (USEPA, 1992b). Many States require water quality assessments of proposed marina development (Appendix 5A). Marinas with 10 to 49 slips may not be able to afford monitoring or modeling. (See *Economic Impacts of EPA Guidance Specifying Management Measures for Sources of Nonpoint Pollution in Coastal Waters*.) In such instances a preconstruction inspection and assessment can still be performed. Dredging requires a River and Harbor Act section 10 permit from the U.S. Army Corps of Engineers (USACE). If there is discharge into waters of the United States after dredging, then a CWA section 404 permit is required. A CWA section 401 Water Quality Certification is required from the State before a section 404 permit is issued by the USACE.

4. Practices

As discussed more fully at the beginning of this chapter and in Chapter 1, the following practices are described for illustrative purposes only. State programs need not require implementation of these practices. However, as a practical matter, EPA anticipates that the management measure set forth above generally will be implemented by applying one or more management practices appropriate to the source, location, and climate. The practices set forth below have been found by EPA to be representative of the types of practices that can be applied successfully to achieve the management measure described above.

Two effective techniques are available to evaluate water quality conditions for proposed marinas. In the first technique, a water quality monitoring program that includes predevelopment, during-development, and postdevelopment phases can be used to assess the water quality impacts of a marina. In the second approach, effective assessment can be accomplished through numerical modeling that includes predevelopment and postconstruction model applications.

Numerical modeling can be used to study impacts associated with several alternatives and to select an optimum marina design that avoids and minimizes impacts to both water quality and habitats existing at the site (e.g., Rive St. Johns Canal study and Willbrook Island marina). A combination of field surveys and numerical modeling studies may be necessary to identify all environmental concerns and to avoid or minimize marina impacts on both water quality conditions and nearby shellfish habitat.

■ a. Use a water quality monitoring methodology to predict postconstruction water quality conditions.

A primary objective for use of a water quality assessment is to ensure that the 24-hour average dissolved oxygen concentration and the 1-hour (or instantaneous) minimum dissolved oxygen concentration both inside the proposed marina and in adjacent ambient waters will not violate State water quality standards or preclude designated uses.

The first step in a marina water quality assessment should be the evaluation and the characterization of existing water quality conditions. Before an analysis of the potential impacts of future development is made, it should be determined whether current water quality is acceptable, marginal, or substandard. The best way to assess existing water quality is to measure it. Acceptable water quality data may already have been collected by various government organizations. Candidate organizations include the U.S. Geological Survey, the USACE, State and local water quality control and monitoring agencies, and engineering and oceanographic departments of local universities.

The second step in a marina water quality assessment is to set design standards in terms of water quality. In most States, the water quality is graded based on DO content, and a standard exists for the 24-hour average concentration and an instantaneous minimum concentration. A State's water quality standard for DO during the critical season may be used to set limits of acceptability for good water quality.

The best way to assess marina impacts on water quality is to design a sampling strategy and physically measure dissolved oxygen levels. During the sampling, sediment oxygen demand and other data that may be used to estimate dissolved oxygen levels using numerical modeling procedures can be collected (USEPA, 1992c, 1992d). A postdevelopment field program may include dye-release and/or drogoue-release studies (to verify circulation patterns) and a water quality monitoring program. Data collected from such studies may be used to assist in the prediction of water quality or circulation at other potential marina sites.

Sampling programs are effective methods to evaluate the potential water quality impacts from proposed marinas. The main objective of a preconstruction sampling program is to characterize the water surrounding the area in the vicinity of the proposed marina. Another objective of a preconstruction sampling program is to provide necessary information for modeling investigations (e.g., Tetra Tech, 1988).

b. Use a water quality modeling methodology to predict postconstruction water quality conditions.

Water quality monitoring can be expensive, and therefore a field monitoring approach may not be practical. The use of a numerical model may be the most economical alternative. However, all models require some field data for proper calibration. A better and more cost-effective approach would be a combination of both water quality monitoring and numerical modeling (Tetra Tech, 1988).

Modeling techniques are used to predict flushing time and pollutant concentrations in the absence of site-specific data. A distinct advantage of numerical models over monitoring studies is the ability to easily perform sensitivity analyses to establish a set of design criteria. Limits of water quality acceptability, flushing rates, and sedimentation rates must be known before quantifying the limit of geometric parameters to comply with these standards. Numerical models can be used to evaluate different alternative designs to determine the configuration that would provide for maximum flushing of pollutants. Models can also be used to perform sensitivity analysis on the selected optimum design.

In 1982, preconstruction numerical modeling studies were conducted to investigate whether a proposed marina in South Carolina would meet the State water quality standards after construction. Modeling results indicated that the proposed Wexford Marina would meet water quality standards (Cubit Engineering, 1982). The marina was approved and constructed. Follow-up monitoring studies were conducted to evaluate preconstruction model predictions (USEPA, 1986). The monitoring results indicated that shellfish harvesting standards were being met, thereby validating the preconstruction modeling study.

EPA Region 4 recently completed an in-depth report on marina water quality models (USEPA, 1992c). The primary focus of the study was to provide guidance for selection and application of computer models for analyzing the potential water quality impacts (both DO and pathogen indicators) of a marina. EPA reviewed a number of available methods and classified them into three categories: simple methods, mid-range models, and complex models. Simple methods are screening techniques that provide only information on the average conditions in the marina. Screening methods do not provide spatial or time-varying water quality predictions, and therefore it is recommended that these methods be used with open marina designs and/or marinas sited in areas characterized by good flushing rates and

good water quality conditions (USEPA, 1992c). In addition, simple models are not suitable where marina flushing is controlled by the prevailing wind, requiring the application of more advanced models, such as WASP4.

In poorly flushed areas and in marinas with a complex design, a more advanced method will identify those areas where water quality standards may be violated. The complex methods are also capable of predicting spatial and time-variant water quality conditions and provide the complete water quality picture inside a proposed marina. In general, advanced models are more effective and more appropriate than simple screening methods in assessing environmental impacts associated with marina siting and design (USEPA, 1992c).

Costs associated with applying a numerical model or conducting a water quality monitoring program range from 0.1 to 2.0 percent of the total marina development project cost. Table 5-2 provides cost information by marina, size, State, and year built. These factors should all be considered when comparing a particular cost associated with a specific item. For example, costs associated with the water quality monitoring program for Barbers Point Harbor and Marina complex were estimated at \$56,000. On the other hand, the cost of the water quality monitoring program for the Beacons Reach marina, North Carolina, was \$3,000. It was only when a full environmental assessment was conducted (e.g., North Point and Barbers Point marina complex) that costs were higher. In addition, several models have been recommended as appropriate tools to assess potential water quality impacts from coastal marinas (USEPA, 1992c, 1992d). The cost associated with applying the simple model is on the order of \$1,000, whereas the cost associated with the advanced model is in the range of \$25,000 to \$100,000. Siting and design practices to reduce environmental impacts were frequently part of a larger design/environmental study. Costs for a total environmental assessment of a proposed marina ranged from 1 percent to 5 percent of the total project cost.

■ c. *Perform preconstruction inspection and assessment.*

A preconstruction inspection and assessment may be affordable in place of detailed water quality monitoring or modeling for marinas with 10 to 49 slips. The River and Harbor Act of 1899 section 10 and Clean Water Act section 404 permit application process requires applicants to present to the USACE information necessary for a water quality assessment. An expert knowledgeable in water quality and hydrodynamics may assess potential impacts using available information and site inspection.

Table 5-2. Cost Summary of Selected Marina Siting Practices (USEPA, 1992b)

Marina/Project Name and Location	Years	Scope of Work	Cost (x \$1000)
North Point Marina Illinois (1,493 slips)	1983-	Full environmental assessment	100
	1989	Construction cost	39,000
Point Roberts Marina Washington (1,000 slips)	1976- 1978	Environmental studies (physical and numerical modeling, littoral drift, and biological studies)	300
		Postconstruction water quality monitoring program (including dye release and drogoue)	10
		Construction cost	6,000
Barbers Point Harbor and Marina Complex (Retrofit) Hawaii	1981- 1985	Physical model	650
		Numerical model (both 2D and 3D)	100
		Botanical survey	15
		Baseline water quality monitoring program	56
		Total construction	140,000
Marina Water Quality Modeling Study	1990	Numerical model applications to 3 Southeast marinas	30
		Data collection	22
Rive St. Johns Canal Florida	1988	Littoral studies and data collection	20
		Numerical model study	30
North Carolina Coastal Marina Water Quality Assessment	1989	Water quality monitoring program ^a	3
		Dye study ^a	3
		Numerical modeling studies	0.5
Willbrook Island Marina (200 slips) South Carolina	1990	Water quality modeling study	10
Coastal Water Quality Assessment (NCDEM) North Carolina	1989	Monitoring program ^a	3
		Numerical modeling application ^b	0.5
		Dye study (flushing) ^c	3
Wexford Marina South Carolina	1982 and 1986	Numerical model application	— ^d
		Numerical model application	— ^d

^a Cost estimate is per marina site.

^b Simple screening model.

^c This program was conducted by NCDEM personnel.

^d Not available.

C. Habitat Assessment Management Measure

Site and design marinas to protect against adverse effects on shellfish resources, wetlands, submerged aquatic vegetation, or other important riparian and aquatic habitat areas as designated by local, State, or Federal governments.

1. Applicability

This management measure is intended to be applied by States to new and expanding³ marinas where site changes may impact on wetlands, shellfish beds, submerged aquatic vegetation (SAV), or other important habitats. The habitats of nonindigenous nuisance species, such as some clogging vegetation or zebra mussels, are not considered important habitats. Under the Coastal Zone Act Reauthorization Amendments of 1990, States are subject to a number of requirements as they develop coastal nonpoint source programs in conformity with this measure and will have some flexibility in doing so. The application of management measures by States is described more fully in *Coastal Nonpoint Pollution Control Program: Program Development and Approval Guidance*, published jointly by the U.S. Environmental Protection Agency (EPA) and the National Oceanic and Atmospheric Administration (NOAA) of the U.S. Department of Commerce.

2. Description

Coastal marinas are often located in estuaries, one of the most diverse of all habitats. Estuaries contain many plant and animal communities that are of economic, recreational, ecological, and aesthetic value. These communities are frequently sensitive to habitat alteration that can result from marina siting and design. Biological siting and design provisions for marinas are based on the premise that marinas should not destroy important aquatic habitat, should not diminish the harvestability of organisms in adjacent habitats, and should accommodate the same biological uses (e.g., reproduction, migration) for which the source waters have been classified (Cardwell et al., 1980). Important types of habitat for an area, such as wetlands, shellfish beds, and submerged aquatic vegetation (SAV), are usually designated by local, State, and Federal agencies. In most situations the locations of all important habitats are not known. Geographic information systems are used to map biological resources in Delaware and show promise as a method of conveying important habitat and other siting information to marina developers and environmental protection agencies (DNREC, 1990).

3. Management Measure Selection

The selection of this measure was based on its widespread use in siting and design and the fact that proper siting and design can reduce short-term impacts (habitat destruction during construction) and long-term impacts (water quality, sedimentation, circulation, wake energy) on the surrounding environment (USEPA, 1992b). Currently, 50 percent of the coastal States minimize adverse impacts caused by siting and design by requiring a habitat assessment prior to siting a marina, and an additional 40 percent require a habitat assessment under special conditions (Appendix 5A).

³ See Section I.H (General Applicability) for additional information on expansions of existing marinas.

4. Practices

As discussed more fully at the beginning of this chapter and in Chapter 1, the following practices are described for illustrative purposes only. State programs need not require implementation of these practices. However, as a practical matter, EPA anticipates that the management measure set forth above generally will be implemented by applying one or more management practices appropriate to the source, location, and climate. The practices set forth below have been found by EPA to be representative of the types of practices that can be applied successfully to achieve the management measure described above.

■ a. *Conduct surveys and characterize the project site.*

The first step in achieving compatibility between coastal development and coastal resources is to properly characterize the proposed project site. The site's physical properties and water quality characteristics must be assessed. To minimize potential impacts, available habitat and seasonal use of the site by benthos, macroinvertebrates, and ichthyofauna should be evaluated. Once these data are assembled, it becomes possible to identify environmental risks associated with development of the site. Through site-design modifications, preservation of critical or unique habitat, and biological/chemical/physical monitoring, it is possible to minimize the direct and indirect impacts associated with a specific waterfront development (USEPA, 1985a). To properly evaluate development applications for projects at the periphery of critical or endangered habitat areas, it may be necessary to conduct on-site visits and surveys to determine the distribution of critical habitat such as spawning substrate and usage by spawning fish.

Based on data compiled primarily by the New Jersey Department of Environmental Protection (NJDEP) prior to construction, it was concluded that a large proposed marina (Port Liberte) could have a serious environmental impact on resident and transient fish and macroinvertebrates. Loss of unique habitat, water quality degradation, and disturbance of contaminated sediments were some of the more severe anticipated impacts. Following a comprehensive NJDEP review process, the developer modified the site plan and phased construction activities, thereby satisfying the concerns of the various environmental regulatory agencies and minimizing potential direct and indirect impacts (Souza et al., 1990). Follow-up monitoring established that the management practices were effective in avoiding impacts to important fishery habitat.

■ b. *Redevelop coastal waterfront sites that have been previously disturbed; expand existing marinas or consider alternative sites to minimize potential environmental impacts.*

Proper marina site selection is a practice that can minimize adverse impacts on nearby habitats. For example, the selected site for North Point Marina in Illinois was not a suitable environment for either floral or faunal habitat because of high erosion rates, high ground-water conditions, and the high potential for flooding (Braam and Jansen, 1991). Despite the surrounding environment, this site was thought to be suitable for marina development because the site had been previously disturbed. Within existing urban harbors where the shorelines have been modified previously by bulkheading and filling, there will be many opportunities to site recreational boating facilities with minimal adverse environmental consequences (Goodwin, 1988).

Alternative site analysis may be used to demonstrate that a chosen site is the most economic and environmentally suitable. Alternative site/design analysis has been found effective at reducing potential impacts from many proposed marinas. The proposed Rive St. Johns Canal, Willbrook Island, and John Wayne marinas used this practice and demonstrated the effectiveness of analyzing alternative sites and designs to minimize environmental impacts. For example, eight design alternatives were considered for the John Wayne marina. The selected alternative reduced tideland alteration, biological destruction, and stream diversion. This was accomplished by moving the marina basin nearly 1,000 feet north of the original site and reducing the basin capacity (Holland, 1986). Five alternatives were considered for the Rive St. Johns Canal. The selected site avoided impacts to wetland habitats and has better flushing characteristics. The Willbrook study considered five alternatives, and the site selected successfully minimized impacts to submerged aquatic vegetation and wetlands.

■ c. *Employ rapid bioassessment techniques to assess impacts to biological resources.*

Rapid bioassessment techniques, when fully developed, will provide cost-effective biological assessments of potential marina development sites. Rapid bioassessment uses biological criteria and is based on comparing the community assemblages of the potential development site to an undisturbed reference condition. Biological criteria or biocriteria describe the reference condition of aquatic communities inhabiting unimpaired waterbodies (USEPA, 1992a). These methods consist of community-level assessments designed to evaluate the communities based on a variety of functional and structural attributes or metrics. Rapid bioassessment protocols for freshwater streams and rivers were published in 1989 for macroinvertebrates and fish to provide States with guidelines for conducting cost-effective biological assessments (USEPA, 1989). Development of similar protocols for application in estuaries and near coastal areas is under way (USEPA, 1992a).

Scores from rapid bioassessments may be used to determine the biological integrity of a site. Sites that are comparable to pristine conditions, with complete assemblages of species, should not be developed as marinas because of the unavoidable impacts associated with such development. The level of effort required to characterize a site will depend on the specific protocol (level of detail required and organisms used) employed. The time needed to perform a rapid bioassessment in freshwater streams varied from 1.5-3 hours to 5-10 hours for benthos and 3 to 17 hours for fish (USEPA, 1989).

■ d. *Assess historic habitat function (e.g., spawning area, nursery area, migration pathway) to minimize indirect impacts.*

Washington State issued siting and tidal height provisions (WDF, 1971, 1974) to ensure that bulkheads do not destroy spawning of surf smelt habitat and increase the vulnerability of juvenile salmon. In addition, marina breakwaters may disrupt the migration pattern of migratory fish, such as salmon. The design of marinas should consider the migration, survival, and the harvestability of food fish and shellfish.

■ e. *Minimize disturbance to indigenous vegetation in the riparian area.*

A riparian area is defined as:

Vegetated ecosystems along a waterbody through which energy, materials, and water pass. Riparian areas characteristically have a high water table and are subject to periodic flooding and influence from the adjacent waterbody. These systems encompass wetlands, uplands, or some combination of these two land forms. They will not in all cases have all of the characteristics necessary for them to be classified as wetlands.⁴

Riparian areas are generally more productive habitat, in both diversity and biomass, than adjacent uplands because of their unique hydrologic condition. Many important processes occur in the riparian zone, including the following:

- Because of their linear form along waterways, riparian areas process large fluxes of energy and materials from upstream systems as well as from ground-water seepage and upland runoff.
- They can serve as effective filters, sinks, and transformers of nutrients, eroded soils, and other pollutants.
- They often appear to be nutrient transformers that have a net import of inorganic nutrient forms and a net export of organic forms.

Chapter 7 of this document, which also requires protection of riparian areas when they have significant nonpoint pollution control value, contains a more detailed discussion of riparian functions.

⁴ This definition is adapted from the definition offered previously by Mitsch and Gosselink (1986) and Lowrance et al. (1988).

- f. *Encourage the redevelopment or expansion of existing marina facilities that have minimal environmental impacts instead of new marina development in habitat areas that local, State, or Federal agencies have designated important.*

One method to avoid new marina development in areas containing important habitat is the purchase of development rights of existing marinas or important habitat. In the case of preserving an existing marina (thus avoiding the impacts associated with developing new marinas), the government pays the difference (if there is one) between the just value and the water-dependent value and owns the rights to develop the property for other uses. This approach provides instant liquidity for the marina owner, who keeps the profits derived from all marina assets even though the government may have paid 80 to 90 percent of the value of the land. This would in theory offset the inability to sell the marina for non-water-dependent activities and decrease marina development in areas containing important habitat. The purchase of development rights and conservation easements for land containing important habitat or NPS control values is discussed in Chapter 4. In the Broward County (Florida) Comprehensive Plan, expansion of existing marina facilities is preferred over development of new facilities (Bell, 1990).

- g. *Develop a marina siting policy to discourage development in areas containing important habitat as designated by local, State, or Federal agencies.*

Establishing a marina siting policy is an efficient and effective way to control habitat degradation and water pollution impacts associated with marinas. Creating such a policy involves:

- Establishing goals for coastal resource use and protection;
- Cataloging coastal resources; and
- Analyzing existing conditions and problems, as well as future needs.

A siting policy benefits the environment, the public, regulatory agencies, and the marina industry. Examples of such benefits include:

- Impacts to and destruction of environmentally sensitive areas (such as wetlands, fish nursery areas, and shellfish beds) are avoided by directing development to sites more appropriate for marina development;
- Coastal resources (such as submerged aquatic vegetation and beaches) are protected;
- Cumulative impacts from numerous pollution sources are more easily assessed;
- Coastal development and economic growth are balanced with environmental protection, and the continued viability of water-dependent uses is ensured;
- The needs of the marina industry and rights of public access are accounted for;
- The permitting process is streamlined;
- Regulatory efforts are coordinated; and
- Interjurisdictional consistency is improved.

Many States already address coastal resource and development needs through coastal zone management plans, growth management plans, critical area programs, and other means. The following examples illustrate the high level of acceptance such planning has achieved and the variety of program types upon which a marina siting policy could be built:

- Twelve States have established critical area programs that protect public health and safety, the quality of natural features, scenic value, recreational opportunities, and the historical and cultural significance of coastal areas (Myers, 1991).
- North Carolina has a water use classification system to assist in the implementation of land use policies. Coastal areas are designated for preservation, conservation, or development (Clark, 1990).
- Massachusetts has a Harbor Management Program, wherein municipalities devise specific harbor management plans consistent with State goals (Massachusetts Coastal Zone Management, 1988).
- The Narragansett Bay Project, part of EPA's National Estuary Program, recognizes land use planning as the key to accomplishing many goals, including controlling NPS pollution, protecting and restoring habitat, and preserving public access and recreational opportunities (Myers, 1991).
- The Cape Cod Commission found that unplanned growth over the last several decades has limited public access, displaced marinas and boatyards in favor of non-water-dependent uses, encroached on fishermen's access, degraded water quality, destroyed habitat, and created use conflicts (Cape Cod Commission, 1991).

D. Shoreline Stabilization Management Measure

Where shoreline erosion is a nonpoint source pollution problem, shorelines should be stabilized. Vegetative methods are strongly preferred unless structural methods are more cost effective, considering the severity of wave and wind erosion, offshore bathymetry, and the potential adverse impact on other shorelines and offshore areas.

1. Applicability

This management measure is intended to be applied by States to new and expanding⁵ marinas where site changes may result in shoreline erosion. Under the Coastal Zone Act Reauthorization Amendments of 1990, States are subject to a number of requirements as they develop coastal nonpoint source programs in conformity with this measure and will have some flexibility in doing so. The application of management measures by States is described more fully in *Coastal Nonpoint Pollution Control Program: Program Development and Approval Guidance*, published jointly by the U.S. Environmental Protection Agency (EPA) and the National Oceanic and Atmospheric Administration (NOAA) of the U.S. Department of Commerce.

2. Description

The establishment of vegetation as a primary means of shore protection has shown the greatest success in low-wave-energy areas where underlying soil types provide the stability required for plants and where conditions are amenable to the sustaining of plant growth. Under suitable conditions, an important advantage of vegetation is its relatively low initial cost. The effectiveness of vegetation for shore stabilization varies with the amount of wave reduction provided by the physiography and offshore bathymetry of the site or with the degree of wave attenuation provided by structural devices. Identification of the cause of the erosion problem is essential for selecting the appropriate technique to remedy the problem. Methods for determining the potential effectiveness of stabilizing a site with indigenous vegetation are presented in Chapter 7.

Some structural methods to stabilize shorelines and navigation channels are bulkheads, jetties, and breakwaters. They are designed to dissipate incoming wave energy. While structures can provide shoreline protection, unintended consequences may include accelerated scouring in front of the structure, as well as increased erosion of unprotected downstream shorelines.

Among structural techniques, gabions, riprap, and sloping revetments dissipate incoming wave energy more effectively and result in less scouring. Bulkheads are appropriate in some circumstances, but where alternatives are appropriate they should be used first. Costs and design considerations of these and other structural methods for controlling shoreline erosion are presented in Chapter 6.

⁵ Refer to Section I.H (General Applicability) for additional information on expansions of existing marinas.

3. Management Measure Selection

Selection of this measure was based on the demonstrated effectiveness of vegetation and structural methods to mitigate shoreline erosion and the resulting turbidity and shoaling (see Chapters 6 and 7). Also, it is in the best interest of marina operators to minimize shoreline erosion because erosion may increase sedimentation and the frequency of dredging in the marina basin and channel(s).

4. Practices

As discussed more fully at the beginning of this chapter and in Chapter 1, the following practices are described for illustrative purposes only. State programs need not require implementation of these practices. However, as a practical matter, EPA anticipates that the management measure set forth above generally will be implemented by applying one or more management practices appropriate to the source, location, and climate. The practices set forth below have been found by EPA to be representative of the types of practices that can be applied successfully to achieve the management measure described above.

Detailed information on practices and the cost and effectiveness of structural and vegetative practices can be found in Chapters 6 and 7, respectively.

E. Storm Water Runoff Management Measure

Implement effective runoff control strategies which include the use of pollution prevention activities and the proper design of hull maintenance areas.

Reduce the average annual loadings of total suspended solids (TSS) in runoff from hull maintenance areas by 80 percent. For the purposes of this measure, an 80 percent reduction of TSS is to be determined on an average annual basis.

1. Applicability

This management measure is intended to be applied by States to new and expanding⁶ marinas, and to existing marinas for *at least* the hull maintenance areas.⁷ If boat bottom scraping, sanding, and/or painting is done in areas other than those designated as hull maintenance areas, the management measure applies to those areas as well. This measure is not applicable to runoff that enters the marina property from upland sources. Under the Coastal Zone Act Reauthorization Amendments of 1990, States are subject to a number of requirements as they develop coastal nonpoint source programs in conformity with this measure and will have some flexibility in doing so. The application of management measures by States is described more fully in *Coastal Nonpoint Pollution Control Program: Program Development and Approval Guidance*, published jointly by the U.S. Environmental Protection Agency (EPA) and the National Oceanic and Atmospheric Administration (NOAA) of the U.S. Department of Commerce.

2. Description

The principal pollutants in runoff from marina parking areas and hull maintenance areas are suspended solids and organics (predominately oil and grease). Toxic metals from boat hull scraping and sanding are part of, or tend to become associated with, the suspended solids (METRO, 1992a). Practices for the control of these pollutants can be grouped into three types: (1) filtration/infiltration, (2) retention/detention, and (3) physical separation of pollutants. A further discussion of storm water runoff controls can be found in Chapter 4.

The proper design and operation of the marina hull maintenance area is a significant way to prevent the entry of toxic pollutants from marina property into surface waters. Recommended design features include the designation of discrete impervious areas (e.g., cement areas) for hull maintenance activities; the use of roofed areas that prevent rain from contacting pollutants; and the creation of diversions and drainage of off-site runoff away from the hull maintenance area for separate treatment. Source controls that collect pollutants and thus keep them out of runoff include the use of sanders with vacuum attachments, the use of large vacuums for collecting debris from the ground, and the use of tarps under boats that are being sanded or painted.

The perviousness of non-hull maintenance areas should be maximized to reduce the quantity of runoff. Maximizing perviousness can be accomplished by placing filter strips around parking areas. Swales are strongly recommended for the conveyance of storm water instead of drains and pipes because of their infiltration and filtering characteristics.

⁶ Refer to Section I.H (General Applicability) for additional information on expansions of existing marinas.

⁷ Hull maintenance areas are areas whose primary function is to provide a place for boats during the scraping, sanding, and painting of their bottoms.

Technologies capable of treating runoff that has been collected (e.g., wastewater treatment systems and holding tanks) may be used in situations where other practices are not appropriate or pretreatment is necessary. The primary disadvantages of using such systems are relatively high costs and high maintenance requirements. Some marinas are required to pretreat storm water runoff before discharge to the local sewer system (Nielsen, 1991). Washington State strongly recommends that marinas pretreat hull-cleaning wastewater and then discharge it to the local sewer system (METRO, 1992b).

The annual TSS loadings can be calculated by adding together the TSS loadings that can be expected to be generated during an average 1-year period from precipitation events less than or equal to the 2-year/24-hour storm. The 80 percent standard can be achieved, by reducing over the course of the year, 80 percent of these loadings. EPA recognizes that 80 percent cannot be achieved for each storm event and understands that TSS removal efficiency will fluctuate above and below 80 percent for individual storms.

3. Management Measure Selection

The 80 percent removal of TSS was selected because chemical wastewater treatment systems, sand filters, wet ponds, and constructed wetlands can all achieve this degree of pollutant removal if they are designed properly and the site is suitable. Source controls can also reduce final TSS concentrations in runoff. Table 5-3 presents summary information on the effectiveness, cost, and suitability of the practices listed below. The discussion under each practice presents factors to be considered when selecting a specific practice(s) for a particular marina site.

The 80 percent removal of TSS is applicable to the hull maintenance area only. Although pollutants in runoff from the remaining marina property are to be considered in implementing effective runoff pollution prevention and control strategies for all marinas, existing marinas may be unable to economically treat storm water runoff by retention/detention or filtration/infiltration technologies because of treatment system land requirements and the likely need to collect and transfer runoff from marina shoreline areas (at lower elevations) to upland areas for treatment. Also, marina property may be developed to such an extent that space is not available to build the detention/retention structures. In other situations, the soil type and groundwater levels may not allow sufficient infiltration for trenches, swales, filter strips, etc. The measure applies to all new and existing marina hull maintenance areas because it allows for runoff control of a smaller, more controlled area and also because the runoff from these hull maintenance areas contain higher levels of toxic pollutants (CDEP, 1991; and METRO, 1992a).

In addition, many of the available practices are currently being employed by States to control runoff from marinas and other urban nonpoint sources (Appendix 5A).

4. Practices

As discussed more fully at the beginning of this chapter and in Chapter 1, the following practices are described for illustrative purposes only. State programs need not require implementation of these practices. However, as a practical matter, EPA anticipates that the management measure set forth above generally will be implemented by applying one or more management practices appropriate to the source, location, and climate. The practices set forth below have been found by EPA to be representative of the types of practices that can be applied successfully to achieve the management measure described above.

■ a. *Design boat hull maintenance areas to minimize contaminated runoff.*

Boat hull maintenance areas can be designed so that all maintenance activities that are significant potential sources of pollution can be accomplished over dry land and under roofs (where practical), allowing the collection and proper disposal of debris, residues, solvents, spills, and storm water runoff. Boat hull maintenance areas can be specified with signs, and hull maintenance should not be allowed to occur outside these areas. The use of impervious surfaces (e.g., cement) in hull maintenance areas will greatly enhance the collection of sandings, paint chips, etc. by vacuuming or sweeping.

Table 5-3. Stormwater Management Practice Summary Information

Practice - Characteristics	Pollutants Controlled	Removal Efficiencies (%)	Use with Other Practices	Cost	Retrofit Suitability	References	Pretreatment of Runoff Recommended
Sand Filter	TSS TP TN Fecal Col Metals	60-90 0-80 20-40 40 40-80	Yes	\$1 - 11 per ft ³ of runoff	Medium	City of Austin, 1990; Schueler 1991; Tull 1990	Yes
Wet Pond	TSS TP TN COD Pb Zn Cu	50-90 20-90 10-90 10-90 10-95 20-95 38-90	Yes	\$349-823 per acre treated; 3-5 of capital cost per year	Medium	Schueler, 1987, 1991; USEPA, 1986	Yes, but not necessary
Constructed Wetlands	TSS TP SP TN NO ₃ COD Pb Zn	50-90 0-80 30-65 0-40 5-95 20-80 30-95 30-80	Yes	See Chapter 7	Medium		Yes
Infiltration Basin/Trench	TSS TP TN BOD Bacteria Metals	50-99 50-100 50-100 70-90 75-98 50-100	Yes	<u>Of capital costs:</u> Basins = 3-13 Trenches = 5-15	Medium	Schueler, 1987, 1991	Yes
Porous Pavement	TSS TP TN COD Pb Zn	60-90 60-90 60-90 60-90 60-90 60-90	No	<u>Incremental cost:</u> \$40,051-78,288 per acre	Low	Schueler, 1987; SWRPC, 1991; Cahill Associates, 1991	
Vegetated Filter Strip	TSS TP TN COD Metals	40-90 30-80 20-60 0-80 20-80	Combine with practices for MM	<u>Seed:</u> \$200-1000 per acre; <u>Seed & mulch:</u> \$800-3500 per acre; <u>Sod:</u> \$4500-48,000 per acre	High	Schueler et al., 1992	No
Grassed Swale	TSS TP TN Pb Zn Cu Cd	20-40 20-40 10-30 10-20 10-20 50-60 50	Combine with practices for MM	<u>Seed:</u> \$4.50-8.50 per linear ft; <u>Sod:</u> \$8-50 per linear ft	High	SWRPC, 1991; Schueler, 1987, 1991; Honer, 1988; Wanielista and Yousef, 1986	No

Table 5-3. (Continued)

Practice - Characteristics	Pollutants Controlled	Removal Efficiencies (%)	Use with Other Practices	Cost	Retrofit Suitability	References	Pretreatment of Runoff Recommended
Swirl Concentrator	TSS BOD		Yes		High	WPCF, 1989; Pisano, 1989; USEPA, 1982	No
Catch Basins	TSS COD	60-97 10-56	Yes	\$1100-3000	High	WPCF, 1989; Richards, 1981; SWRPA, 1991	No
Catch Basin with Sand Filter	TSS TN COD Pb Zn	70-90 30-40 40-70 70-90 50-80	High	\$10,000 per drainage acre		Shaver, 1991	No
Adsorbents in Drain Inlets	Oil	High	Yes	\$85-93 for 10 pillows		Silverman, 1989; Industrial Products and Lab Safety, 1991	No
Holding Tank	All	100 for first flush	Yes			WPCF, 1989	No
Boat Maintenance Area Design	All	Minimizes area of pollutant dispersal	Yes	Low	High	IEP, 1992	No
Oil-grit Separators	TSS	10-25	No		High	Steel and McGhee, 1979; Romano, 1990; Schueler, 1987; WPCF, 1989	No

■ b. Implement source control practices.

Source control practices prevent pollutants from coming into contact with runoff. Sanders with vacuum attachments are effective at collecting hull paint sandings (Schlomann, 1992). Encouraging the use of such sanders can be accomplished by including the price of their rental in boat haul-out and storage fees, in effect making their use by marina patrons free. Vacuuming impervious areas can be effective in preventing pollutants from entering runoff. A schedule (e.g., twice per week during the boating season) should be set and adhered to. Commercial vacuums are available for approximately \$765 to \$1065 (Dickerson, 1992), and approximately one machine is needed at a marina of 250 slips or smaller. Tarpaulins may be placed on the ground prior to placement of a boat in a cradle or stand and subsequent sanding/painting. The tarpaulins will collect paint chips, sanding, and paint drippings and should be disposed of in a manner consistent with State policy.

■ c. Sand Filter

Sand filters (also known as filtration basins) consist of layers of sand of varying grain size (grading from coarse sand to fine sands or peat), with an underlying gravel bed for infiltration or perforated underdrains for discharge of treated water. Figure 5-2 shows a conceptual design of a sand filter system. Pollutant removal is primarily achieved by "straining" pollutants through the filtering media and by settling on top of the sand bed and/or a pretreatment pool.

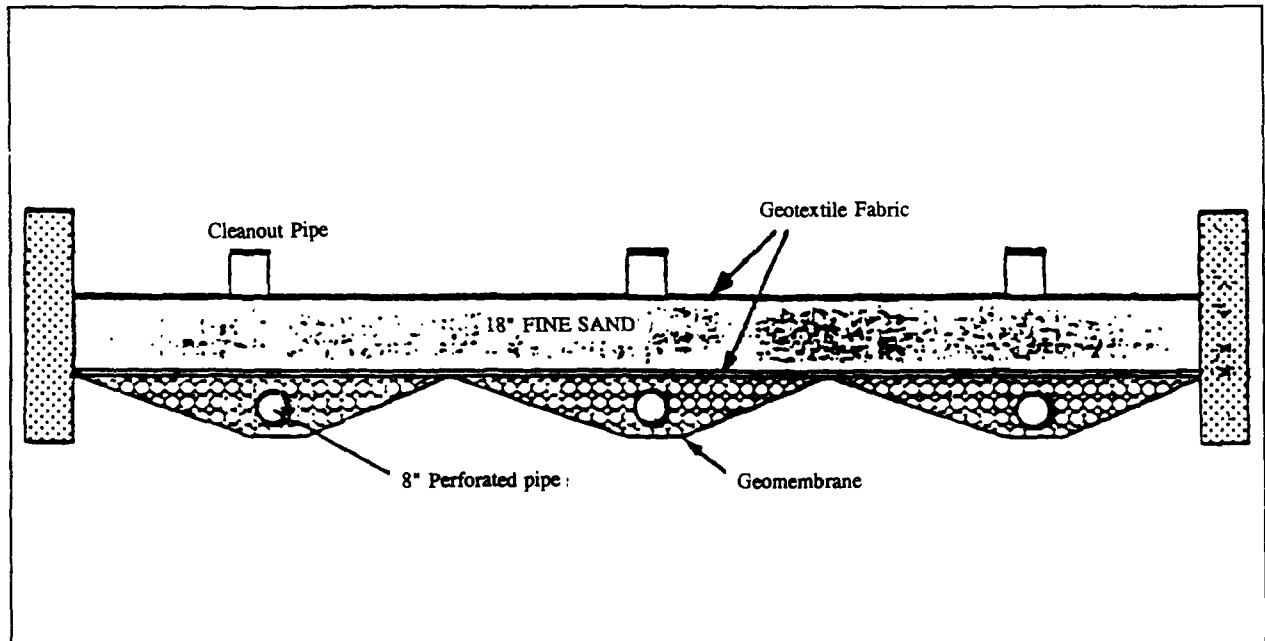

Figure 5-2. Conceptual design of a sand filter system (Austin, Texas, 1991).

Detention time is typically 4 to 6 hours (City of Austin, 1990), although increased detention time will increase effectiveness (Schueler et al., 1992). Sand filters may be used for drainage areas from 3 to 80 acres (City of Austin, 1990). Sand filters may be used on sites with impermeable soils since the runoff filters through filter media, not native soils. The main factors that influence removal rates are the storage volume, filter media, and detention time. Three different designs may be appropriate for marina sites: off-line sedimentation/filtration basins, on-line sand/sod filtration basins, and on-line sand basins. Performance monitoring of these designs produced average removal rates of 85 percent for sediment, 35 percent for nitrogen, 40 percent for dissolved phosphorous, 40 percent for fecal coliform, and 50 percent to 70 percent for trace metals (Schueler et al., 1992).

Sand filters become clogged with particulates over time. In general, clogging occurs near the runoff input to the sand filter. Frequent manual maintenance is required of sand filters, primarily raking, surface sediment removal, and removal of trash, debris, and leaf litter. Sand filters appear to have excellent longevity because of their off-line design and the high porosity of sand as a filtering medium (Schueler et al., 1992). Construction costs have been estimated at \$1.30 to \$10.50 per cubic foot of runoff treated (Tull, 1990). Significant economies of scale exist as sand filter size increases (Schueler et al., 1992). Maintenance costs are estimated to be approximately 5 percent of construction cost per year (Austin DPW, 1991, in Schueler et al., 1992).

■ d. Wet Pond

Wet ponds are basins designed to maintain a permanent pool of water and temporary storage capacity for storm water runoff (see Figure 5-3). The permanent pool enhances pollutant removal by promoting the settling of particulates, chemical coagulation and precipitation, and biological uptake of pollutants and is normally 1/2 to 1 inch in depth per impervious acre. Wet ponds are typically not used for drainage areas less than 10 acres (Schueler, 1987). Pond liners are required if the native soils are permeable or if the bedrock is fractured. Design parameters of concern include geometry, wet pond depth, area ratio, volume ratio, and flood pool drawdown time. Ponds may be designed to include shallow wetlands, thereby enhancing pollutant removal. Pollutant removal ranges are presented in Table 5-3. Removal rates of greater than 80 percent for total suspended solids were achieved in many studies (Schueler et al., 1992). Pollutant removal is primarily a function of the ratio of pond volume to watershed size (USEPA, 1986).

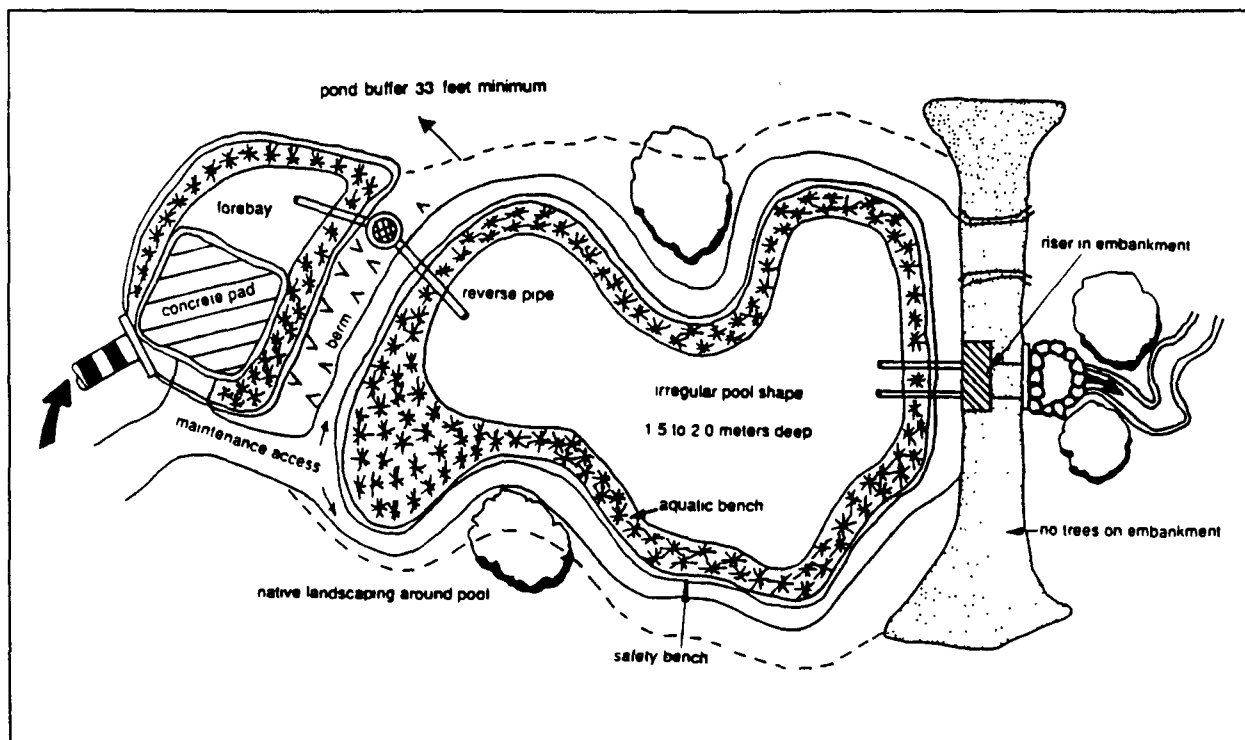

Figure 5-3. Schematic design of an enhanced wet pond system (Schueler, 1991).

A low level of routine maintenance, including tasks such as mowing of side slopes, inspections, and clearing of debris from outlets, is required. Wet ponds can be expected to lose approximately 1 percent of their runoff storage capacity per year as a result of sediment accumulation. To maintain the pollutant removal capacity of the pond, periodic removal of sediment is necessary. A recommended sediment cleanout cycle is every 10 to 20 years (British Columbia Research Corp., 1991). With proper maintenance and replacement of inlet and outlet structures every 25 to 50 years, wet ponds should last in excess of 50 years (Schueler, 1987). A review of capital costs for wet ponds revealed costs of \$349 to \$823 per acre treated and annual maintenance costs of 3 percent to 5 percent of the capital cost (Schueler, 1987).

■ e. Constructed Wetland

A complete discussion of created wetlands can be found in Chapter 7. Summary information on pollutant removal efficiencies, cost, etc. is presented in Table 5-3.

■ f. Infiltration Basin/Trench

Infiltration practices suitable for storm water treatment include basins and trenches. Figures 5-4 and 5-5 show examples of infiltration basins and trenches. Like porous pavement, infiltration practices reduce runoff by increasing ground-water recharge. Prior to infiltration, runoff is stored temporarily at the surface, in the case of infiltration basins, or in subsurface stone-filled trenches.

Infiltration devices should drain within 72 hours of a storm event and should be dry at other times. The maximum contributing drainage area should not exceed 5 acres for an individual infiltration trench and should range from 2 to 15 acres for an infiltration basin (Schueler et al., 1992).

Pretreatment to remove coarse sediments and PAHs is necessary to prevent clogging and diminished infiltration capacity over time. The application of infiltration devices is severely restricted by soils, water table, slope, and

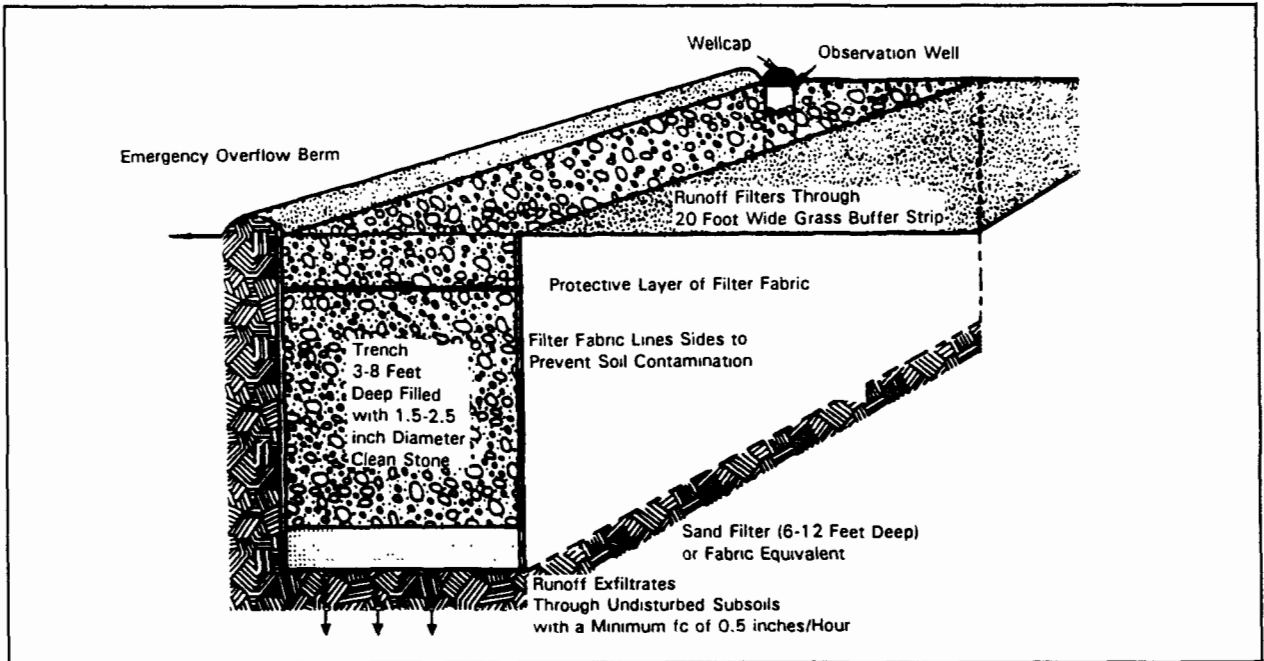

Figure 5-4. Schematic design of a conventional infiltration trench (Schueler, 1987).

contributing area conditions. The sediment load from marina hull maintenance areas may limit the applicability of infiltration devices in these areas. Infiltration devices are not practical in soils with field-verified infiltration rates of less than 1/2 inch per hour (Schueler et al., 1992). Soil borings should be taken well below the proposed bottom of the trench to identify any restricting layers and the depth of the water table. Removal of soluble pollutants in

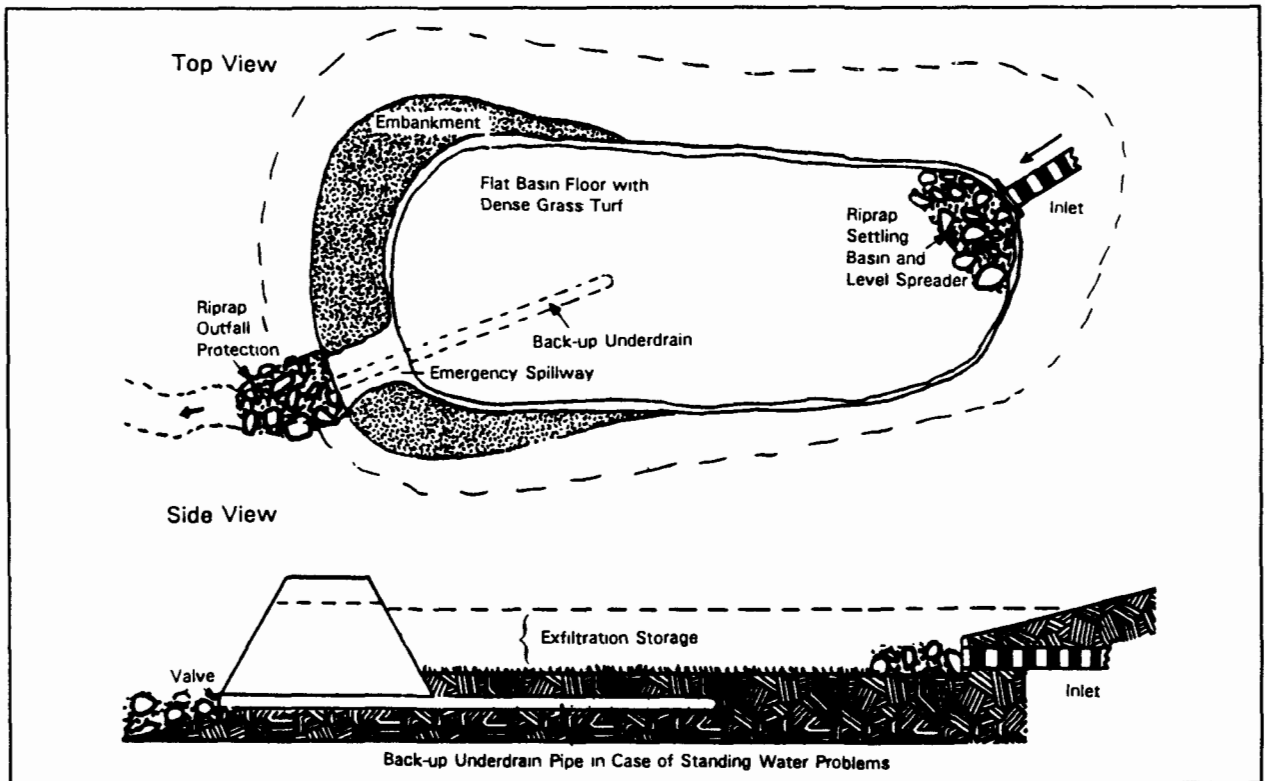

Figure 5-5. Schematic design of an infiltration basin (Schueler, 1987).

infiltration devices relies heavily on soil adsorption, and removal efficiencies are lowered in sandy soils with limited binding capacity. Schueler (1987) reported a sediment removal efficiency of 95 percent, 60 percent to 75 percent removal of nutrients, and 95 percent to 99 percent removal of metals using a 2-year design storm. Other effectiveness data are presented in Table 5-3.

Infiltration basins and trenches have had high failure rates in the past (Schueler et al., 1992). A geotechnical investigation and design of a sound and redundant pretreatment system should be required before construction approval. Routine maintenance requirements include inspecting the basin after every major storm for the first few months after construction and annually thereafter to determine whether scouring or excessive sedimentation is reducing infiltration. Infiltration basins must be mowed twice annually to prevent woody growth. Tilling may be required in late summer to maintain infiltration capacities in marginal soils (Schueler, 1987). Field studies indicate that regular maintenance is not done on most infiltration trenches/basins, and 60 percent to 70 percent were found to require maintenance. Based on longevity studies, replacement or rehabilitation may be required every 10 years (Schueler et al., 1992). Proper maintenance of pretreatment structures may result in increased longevity. Reported costs for infiltration devices (Table 5-3) varied considerably based on runoff storage volume. Annual maintenance costs varied from 3 percent to 5 percent of capital cost for infiltration basins and from 5 percent to 10 percent for infiltration trenches.

■ g. *Chemical and Filtration Treatment Systems*

Chemical treatment of wastewater is the addition of certain chemicals that causes small solid particles to adhere together to form larger particles that settle out or can be filtered. Filtration systems remove suspended solids by forcing the liquid through a medium, such as folded paper in a cartridge filter (METRO, 1992b). A recent study showed that such treatment systems can remove in excess of 90 percent of the suspended solids and 80 percent of most toxic metals associated with hull pressure-washing wastewater (METRO, 1992a). The degree of treatment necessary may be dependent on whether the effluent can be discharged to a sewage treatment system. The cost of a homemade system for a small boatyard to treat 100 gallons a day was estimated at \$1,560. The cost of larger commercial systems capable of treating up to 10,000 gallons a day was estimated at \$3000 to \$50,000 plus site preparation. The solid waste generated by these treatment systems may be considered hazardous waste and may be subject to disposal restrictions.

■ h. *Vegetated Filter Strip*

A complete discussion of vegetated filter strips can be found in Chapter 7. Summary information on pollutant removal efficiencies, cost, etc. is presented in Table 5-3.

■ i. *Grassed Swale*

Grassed swales are low-gradient conveyance channels that may be used in marinas in place of buried storm drains. To effectively remove pollutants, the swales should have relatively low slope and adequate length and should be planted with erosion-resistant vegetation. Swales are not practical on very flat grades or steep slopes or in wet or poorly drained soils (SWRPC, 1991). Grassed swales can be applied in areas where maximum flow rates are not expected to exceed 1.5 feet per second (Horner et al., 1988). The main factors influencing removal efficiency are vegetation type, soil infiltration rate, flow depth, and flow travel time. Properly designed and functioning grassed swales provide pollutant removal through filtering by vegetation of particulate pollutants, biological uptake of nutrients, and infiltration of runoff. Schueler (1987) suggests the use of check dams in swales to slow the water velocity and provide a greater opportunity for settling and infiltration. Swales are designed to deal with concentrated flow under most conditions, resulting in low pollutant removal rates (SWRPC, 1991). Removal rates are most likely higher under low-flow conditions when sheet flow occurs. This may help to explain that the reported percent removal for TSS varied from 0 to greater than 90 percent (W-C, 1991). Wanielista and Yousef (1986) stated that swales are a useful component in a storm water management system and removal efficiencies can be improved by designing swales to infiltrate and retain runoff. Swales should be used only as part of a storm water management system and may be used with the other practices listed under this management measure.

Maintenance requirements for grassed swales include mowing and periodic sediment cleanout. Surveys by Horner et al. (1988) and in the Washington area indicate that the vast majority of swales operate as designed with relatively minor maintenance. The primary maintenance problem was the gradual build-up of soil and grass adjacent to roads, which prevents the entry of runoff into swales. The cost of a grassed swale will vary depending on the geometry of the swale (height and width) and the method of establishing the vegetation (see Table 5-3). Construction costs for grassed swales are typically less than those for curb-and-gutter systems. Regular maintenance costs for conventional swales are minimal. Cleanout of sediments trapped behind check dams and spot vegetation repair may be required (Schueler et al., 1992).

■ j. Porous Pavement

Porous pavement has a layer of porous top course covering an additional layer of gravel. A crushed stone-filled ground-water recharge bed is typically installed beneath these top layers. The runoff infiltrates through the porous asphalt layer and into the underground recharge bed. The runoff then exfiltrates out of the recharge bed into the underlying soils or into a perforated pipe system (see Figure 5-6). When operating properly, porous pavement can replicate predevelopment hydrology, increase ground-water recharge, and provide excellent pollutant removal (up to 80 percent of sediment, trace metals, and organic matter). The use of porous pavement is highly constrained and requires deep and permeable soils, restricted traffic, and suitable adjacent land uses. Pretreatment of runoff is necessary to remove coarse particulates and prevent clogging and diminished infiltration capacity.

The major advantages of porous pavement are (1) it may be used for parking areas and therefore does not use additional site space and (2) when operating properly, it provides high long-term removal of solids and other pollutants. However, significant problems exist in the use of porous pavement. Porous pavement sites have a high failure rate (75 percent) (Schueler et al., 1992). High sediment loads and oil result in clogging and eventual failure of the system. Therefore, porous pavement is not recommended for treatment of runoff from hull cleaning/maintenance areas. Porous pavement is appropriate for low-intensity parking areas where restrictions on use (no heavy trucks) and maintenance (no deicing chemicals, sand, or improper resurfacing) can be enforced. Quarterly vacuum sweeping and/or jet hosing is needed to maintain porosity. Field data, however, indicate that this routine maintenance practice is not frequently followed (Schueler et al., 1992).

The cost of porous pavement should be measured as the incremental cost, or the cost beyond that required for conventional asphalt pavement (up to 50 percent more). To determine the full value of porous pavement, however, the savings from reducing land consumption and eliminating storm systems such as curbs, inlets, and pipes should be considered (Cahill Associates, 1991). Also, the additional cost of directing pervious area runoff around porous pavement should be considered. Maintenance of porous pavement consists of quarterly vacuum sweeping and may be 1 percent to 2 percent of the original construction costs (Schueler et al., 1992). Other maintenance costs include rehabilitation of clogged systems. In a Maryland study, 75 percent of the porous pavement systems surveyed had partially or totally clogged within 5 years. Failure was attributed to inadequate construction techniques, low permeable soils and/or restricting layers, heavy vehicular traffic, and resurfacing with nonporous pavement materials (Schueler et al., 1992).

■ k. Oil-Grit Separators

Oil-grit separators (see Figure 5-7) may be used to treat water from small areas where other measures are infeasible and are applicable where activities contribute large loads of grease, oil, mud, sand, and trash to runoff (Steel and McGhee, 1979). Oil-grit separators are mainly suitable for oil droplets 150 microns in diameter or larger. Little is known regarding the oil droplet size in storm water; however, droplets less than 150 microns in diameter may be more representative of storm water (Romano, 1990). Basic design criteria include providing 200-400 cubic feet of oil storage per acre of area directed to the structure. The depth of the oil storage should be approximately 3-4 feet, and the depth of grit storage should be approximately 1.5-2.5 feet minimum under the oil storage. Application is limited to highly impervious catchments that are 2 acres or smaller.

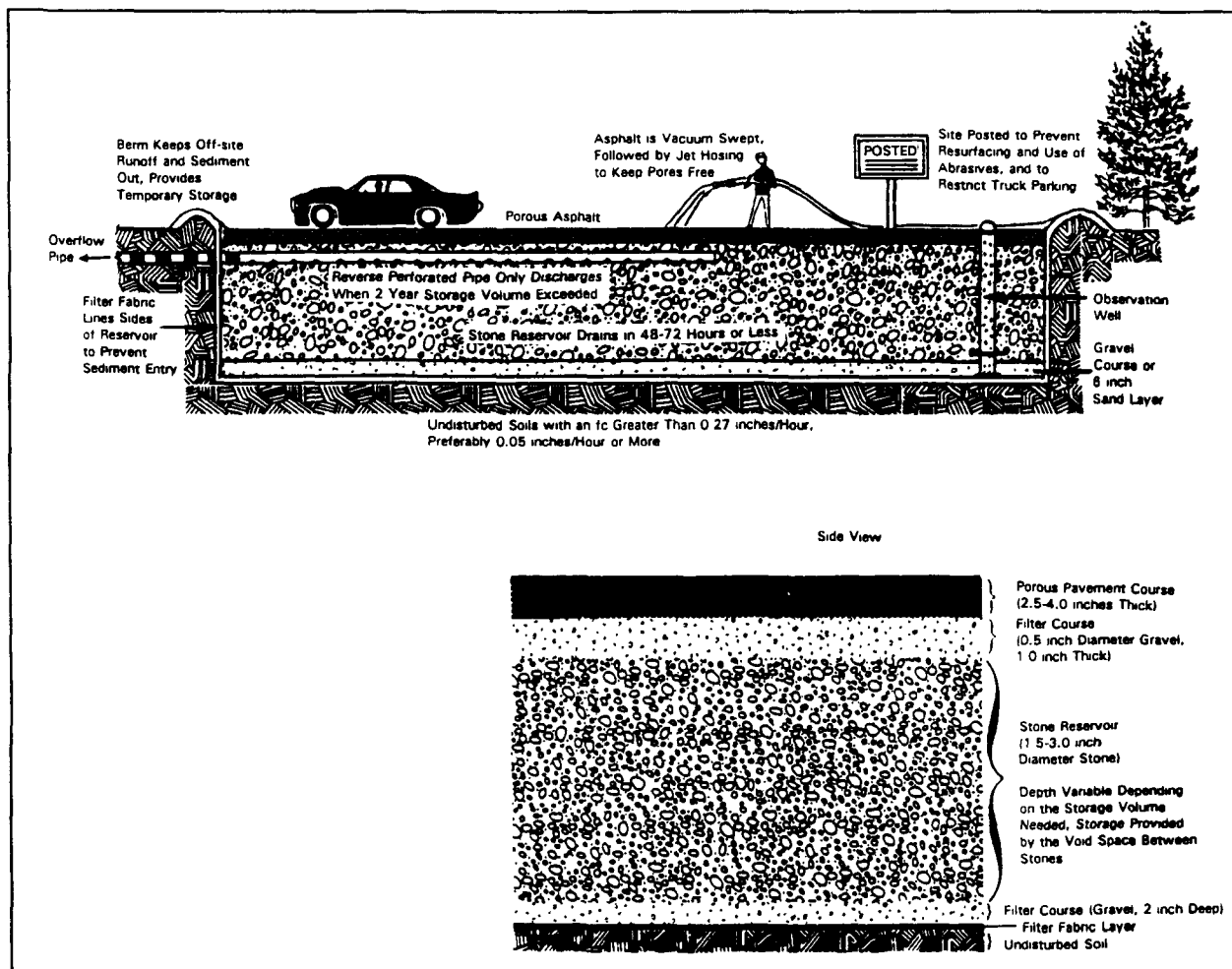

Figure 5-6. Schematic design of a porous pavement system (Schueler, 1987).

Actual pollutant removal occurs only when the chambers are cleaned out. Re-suspension limits long-term removal efficiency if the structure is not cleaned out. Periodic inspections and maintenance of the structure should be done at least twice a year (Schueler, 1987). With proper maintenance, the oil/grit separator should have at least a 50-year life span.

I. Holding Tanks

Simply put, holding tanks act as underground detention basins that capture and hold storm water until it can receive treatment. There are generally two classes of tanks: first flush tanks and settling tanks (WPCF, 1989). First flush tanks are used when the time of concentration of the impervious area is 15 minutes or less. The contents of the tank are transported via pumpout or gravity to another location for treatment. Excess runoff is discharged via the upstream overflow outlet when the tank is filled. Settling tanks are used when a pronounced first flush is not expected. A settling tank is similar to a primary settling tank in that only treated flow is discharged. The load to the clarifier overflow is usually restricted to about $0.2 \text{ ft}^3/\text{sec}/\text{ac}$ of impervious area. If the inflow exceeds this, upstream overflows are activated. Settling tanks require periodic cleaning.

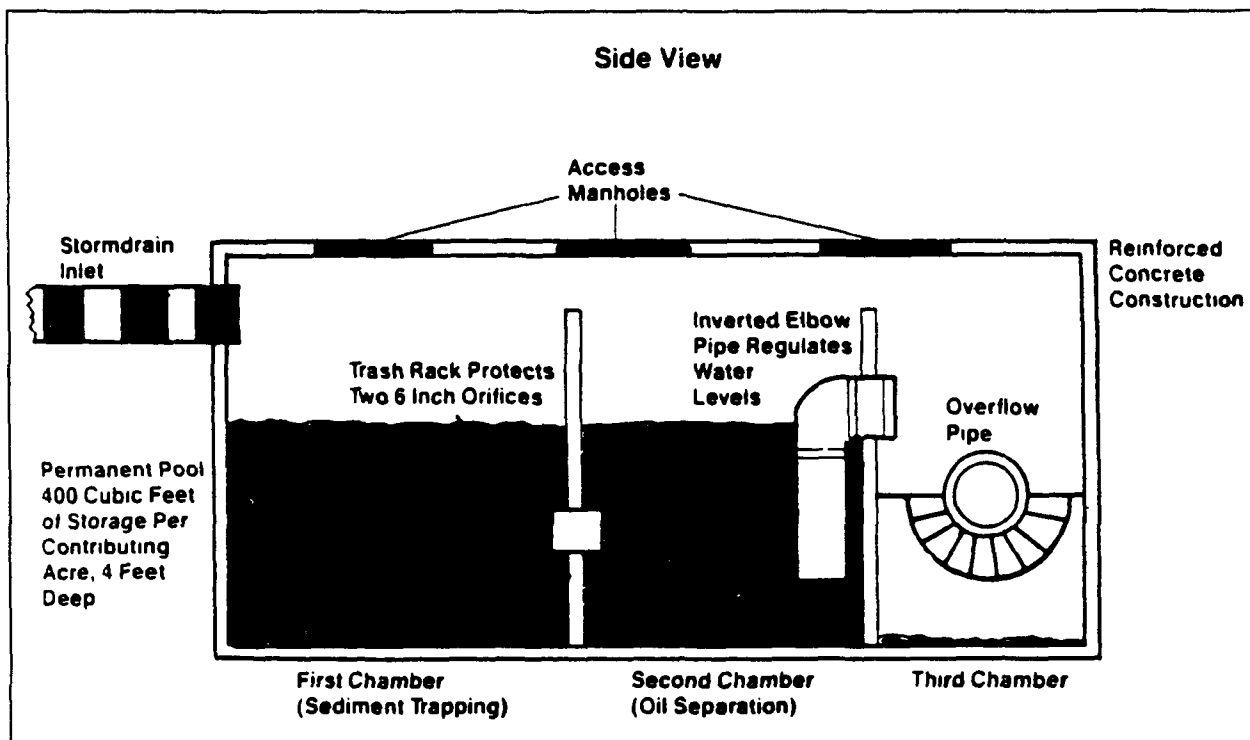

Figure 5-7. Schematic design of a water quality inlet/oil grit separator (Schueler, 1987).

m. Swirl Concentrator

A swirl concentrator is a small, compact solids separation device with no moving parts. During wet weather the unit's outflow is throttled, causing the unit to fill and to self-induce a swirling vortex. Secondary flow currents rapidly separate first flush settleable grit and floatable matter (WPCF, 1989). The pollutant matter is concentrated for treatment, while the cleaner, treated flow discharges to receiving waters. Swirl concentrators are intended to operate under high-flow regimes and may be used in conjunction with settling tanks. EPA published a design manual for swirl and helical bend pollution control devices (USEPA, 1982). However, monitoring data reveal that swirls built in accordance with this manual should be operated at lesser flows than the design indicates to achieve the desired efficiency (Pisano, 1989). Total suspended solids and BOD concentration removal efficiencies in excess of 60 percent have been reported, particularly under first flush conditions (WPCF, 1989). In another report removal effectiveness of total suspended solids from current U.S. swirls varied from a low of 5.2 percent to a high of 36.7 percent excluding first flush, 32.6 percent to 80.6 percent for first flush only, and 16.4 percent to 33.1 percent for entire storm events (Pisano, 1989). Removal efficiencies are dependent on the initial concentrations of pollutants, flow rate, size of structure, when the sumps in the catchments were cleaned, and other parameters (WPCF, 1989; and Pisano, 1989).

n. Catch Basins

Catch basins with flow restrictors may be used to prevent large pulses of storm water from entering surface waters at one time. They provide some settling capacity because the bottom of the structure is typically lowered 2 to 4 feet below the outlet pipe. Above- and below-ground storage is used to hold runoff until the receiving pipe can handle the flow. Temporary surface ponding may be used to induce infiltration and reduce direct discharge. Overland flow can be induced from sensitive areas to either sink discharge points or other storage locations. Catch basins with flow restrictors are not very effective at pollutant removal by themselves (WPCF, 1989) and should be used in conjunction with other practices. Removal efficiencies for larger particles and debris are high and make catch basins attractive as pretreatment systems for other practices. The traps of catch basins require periodic cleaning and maintenance.

Cleaning catch basins can result in large pulses of pollutants in the first subsequent storm if the method of cleaning results in the disturbance and breaking up of residual matter and some material is left in the catch basin (Richards et al., 1981). With proper maintenance, a catch basin should have at least a 50-year life span (Schueler et al., 1992).

o. Catch Basin with Sand Filter

A catch basin with sand filter consists of a sedimentation chamber and a chamber filled with sand. The sedimentation chamber removes coarse particles, helps to prevent clogging of the filter medium, and provides sheet flow into the filtration chamber. The sand chamber filters smaller-sized pollutants. Catch basins with sand filters are effective in highly impervious areas, where other practices have limited usefulness. The effectiveness of the sediment chamber for removal of the different particles depends on the particles' settling velocity and the chamber's length and depth. The effectiveness of the filtration medium depends on its depth.

Catch basins with sand filters should be inspected at least annually, and periodically the top layer of sand with deposition of sediment should be removed and replaced. In addition, the accumulated sediment in the sediment chamber should be removed periodically (Shaver, 1991). With proper maintenance and replacement of the sand, a catch basin with sand filter should have at least a 50-year life span (Schueler et al., 1992).

p. Adsorbents in Drain Inlets

While there is some tendency for oil and grease to sorb to trapped particles, oil and grease will not ordinarily be captured by catch basins, holding tanks, or swirl concentrators. Adsorbent material placed in these structures in a manner that will allow sufficient contact between the adsorbent and the storm water will remove much of the oil and grease load of runoff (Silverman and Stenstrom, 1989). In addition, the performance of oil-grit separators could be enhanced through the use of adsorbents. An adsorbent/catch basin system that treats the majority of the grease and oil in storm water runoff could be designed, and annual replacement of the adsorbent would be sufficient to maintain the system in most cases (Silverman et al., 1989). Manufacturers report that their products are able to sorb 10 to 25 times their weight in oil (Industrial Products, 1991; Lab Safety, 1991). The cost of 10 pillows, 24 inches by 14 inches by 5 inches (total weight 24 pounds), is approximately \$85 to \$93 (Lab Safety, 1991).

F. Fueling Station Design Management Measure

Design fueling stations to allow for ease in cleanup of spills.

1. Applicability

This management measure is intended to be applied by States to new and expanding⁸ marinas where fueling stations are to be added or moved. Under the Coastal Zone Act Reauthorization Amendments of 1990, States are subject to a number of requirements as they develop coastal nonpoint source programs in conformity with this measure and will have some flexibility in doing so. The application of management measures by States is described more fully in *Coastal Nonpoint Pollution Control Program: Program Development and Approval Guidance*, published jointly by the U.S. Environmental Protection Agency (EPA) and the National Oceanic and Atmospheric Administration (NOAA) of the U.S. Department of Commerce.

2. Description

Spillage is a source of petroleum hydrocarbons in marinas (USEPA, 1985a). Most petroleum-based fuels are lighter than water and thus float on the water's surface. This property allows for their capture if petroleum containment equipment is used in a timely manner.

3. Management Measure Selection

Selection of this measure is based on the preference for pollution prevention in the design of marinas rather than reliance on control of material that is released without forethought as to how it will be cleaned up. The possibility of spills during fueling operations always exists. Therefore, arrangements should be made to contain pollutants released from fueling operations to minimize the spread of pollutants through and out of the marina.

4. Practices

As discussed more fully at the beginning of this chapter and in Chapter 1, the following practices are described for illustrative purposes only. State programs need not require implementation of these practices. However, as a practical matter, EPA anticipates that the management measure set forth above generally will be implemented by applying one or more management practices appropriate to the source, location, and climate. The practices set forth below have been found by EPA to be representative of the types of practices that can be applied successfully to achieve the management measure described above.

- a. *Locate and design fueling stations so that spills can be contained in a limited area.*

The location and design of the fueling station should allow for booms to be deployed to surround a fuel spill. Pollutant reduction effectiveness and the cost of the design of fueling areas are difficult to quantify. When designing a new marina, the additional costs of ensuring that the design incorporates effective cleanup considerations should be minimal.

⁸Refer to Section I.H (General Applicability) for additional information on expansions of existing marinas.

■ b. Design a Spill Contingency Plan.

A Spill Contingency Plan must be developed for fuel storage and dispensation areas. The plan must meet local and State requirements and must include spill emergency procedures, including health and safety, notification, and spill containment and control procedures. Marina personnel must be properly trained in spill containment and control procedures.

■ c. Design fueling stations with spill containment equipment.

Appropriate containment and control materials must be stored in a clearly marked, easily accessible cabinet or locker. The cabinet or locker must contain absorbent pads and booms, fire extinguishers, a copy of the Spill Contingency Plan, and other equipment deemed suitable. Easily used effective oil spill containment equipment is readily available from commercial suppliers. Booms that can be strung around the spill, absorb up to 25 times their weight in petroleum products, and remain floating after saturation are available at a cost of approximately \$160 for four booms 8 inches in diameter and 10 feet long with a weight of 40 pounds (Lab Safety, 1991). Oil-absorbent sheets, rolls, and pillows are also available at comparable prices.

G. Sewage Facility Management Measure

Install pumpout, dump station, and restroom facilities where needed at new and expanding marinas to reduce the release of sewage to surface waters. Design these facilities to allow ease of access and post signage to promote use by the boating public.

1. Applicability

This management measure is intended to be applied by States to new and expanding⁹ marinas in areas where adequate marine sewage collection facilities do not exist. Marinas that do not provide services for vessels that have marine sanitation devices (MSDs) do not need to have pumpouts, although dump stations for portable toilets and restrooms should be available. This measure does not address direct discharges from vessels covered under CWA section 312. Under the Coastal Zone Act Reauthorization Amendments of 1990, States are subject to a number of requirements as they develop coastal nonpoint source programs in conformity with this measure and will have some flexibility in doing so. The application of management measures by States is described more fully in *Coastal Nonpoint Pollution Control Program: Program Development and Approval Guidance*, published jointly by the U.S. Environmental Protection Agency (EPA) and the National Oceanic and Atmospheric Administration (NOAA) of the U.S. Department of Commerce.

2. Description

Three types of onshore collection systems are available: fixed point systems, portable/mobile systems, and dedicated slipside systems. Information on the installation and operation of sewage pumpout stations is available from the State of Maryland (MDDNR, 1991).

EPA Region I determined that, in general, a range of one pumpout facility per 300-600 boats with holding tanks (type III MSDs) should be sufficient to meet the demand for pumpout services in most harbor areas (USEPA, 1991b). EPA Region 4 suggested one facility for every 200 to 250 boats with holding tanks and provided a formula for estimating the number of boats with holding tanks (USEPA, 1985a). The State of Michigan has instituted a no-discharge policy and mandates one pumpout facility for every 100 boats with holding tanks.

According to the 1989 American Red Cross Boating Survey, there were approximately 19 million recreational boats in the United States (USCG, 1990). About 95 percent of these boats were less than 26 feet in length. A very large number of these boats used a portable toilet, rather than a larger holding tank. Given the large percentage of smaller boats, facilities for the dumping of portable toilet waste should be provided at marinas that service significant numbers of boats under 26 feet in length.

Two of the most important factors in successfully preventing sewage discharge are (1) providing "adequate and reasonably available" pumpout facilities and (2) conducting a comprehensive boater education program (USEPA, 1991b). The Public Education Management Measure presents additional information on this subject. One reason that pumpout use in Puget Sound is higher than that in other areas could be the extensive boater education program established in that area.

⁹ Refer to Section I.H (General Applicability) for additional information on expansions of existing marinas.

Chemicals from holding tanks may retard the normal functioning of septic systems. Information on septic systems can be found in Chapter 4. Neither the chemicals nor the concentration of marine wastes has proven to be a problem for properly operating public sewage treatment plants.

3. Management Measure Selection

Measure selection is based on the need to reduce discharges of sanitary waste and the fact that most coastal States and many localities already require the installation of pumpout facilities and restrooms at all or selected marinas (Appendix 5A). Other States encourage the installation and use of pumpouts through grant programs and boater education.

In a Long Island Sound study, only about 5 percent of the boats were expected to use pumpouts. Given the low documented usage by boaters at marinas with pumpouts, the time, inconvenience, and cost associated with pumpouts were determined to be more of a deterrent to use than was lack of availability of facilities (Tanski, 1989). A Puget Sound study found that 35 percent of the boats responding to a survey had holding tanks (type III MSDs). Eighty percent of these boats had y-valves that allowed illegal discharge. About half of these boats used pumpouts. The boaters surveyed felt that the most effective methods to ensure proper disposal of boat waste would be the improvement of waste-disposal facilities and boater education (Cheyne and Carter, 1989). Another Puget Sound study found that the problem of marine sewage waste could best be addressed through containment of wastes onboard the vessel and subsequent onshore disposal through the provision of adequate numbers of clean, accessible, economical, and easily used pumpout stations (Seabloom et al., 1989). Designation and advertisement of no-discharge zones can also increase boater use of pumpout facilities (MDDNR, 1991).

4. Practices

As discussed more fully at the beginning of this chapter and in Chapter 1, the following practices are described for illustrative purposes only. State programs need not require implementation of these practices. However, as a practical matter, EPA anticipates that the management measure set forth above generally will be implemented by applying one or more management practices appropriate to the source, location, and climate. The practices set forth below have been found by EPA to be representative of the types of practices that can be applied successfully to achieve the management measure described above.

■ a. Fixed-Point Systems

Fixed-point collection systems include one or more centrally located sewage pumpout stations (see Figure 5-8). These stations are generally located at the end of a pier, often on a fueling pier so that fueling and pumpout operations can be combined. A boat requiring pumpout services docks at the pumpout station. A flexible hose is connected to the wastewater fitting in the hull of the boat, and pumps or a vacuum system move the wastewater to an onshore holding tank, a public sewer system, a private treatment facility, or another approved disposal facility. In cases where the boats in the marina use only small portable (removable) toilets, a satisfactory disposal facility could be a dump station.

■ b. Portable Systems

Portable/mobile systems are similar to fixed-point systems and in some situations may be used in their place at a fueling dock. The portable unit includes a pump and a small storage tank. The unit is connected to the deck fitting on the vessel, and wastewater is pumped from the vessel's holding tank to the pumping unit's storage tank. When the storage tank is full, its contents are discharged into a municipal sewage system or a holding tank for removal by a septic tank pumpout service. In many instances, portable pumpout facilities are believed to be the most logistically feasible, convenient, accessible (and, therefore, used), and economically affordable way to ensure proper disposal of boat sewage (Natchez, 1991). Portable systems can be difficult to move about a marina and this factor should be considered when assessing the correct type of system for a marina. Another portable/mobile pumpout unit that is an emerging technology and is popular in the Great Salt Pond in Block Island, New York, is the radio-

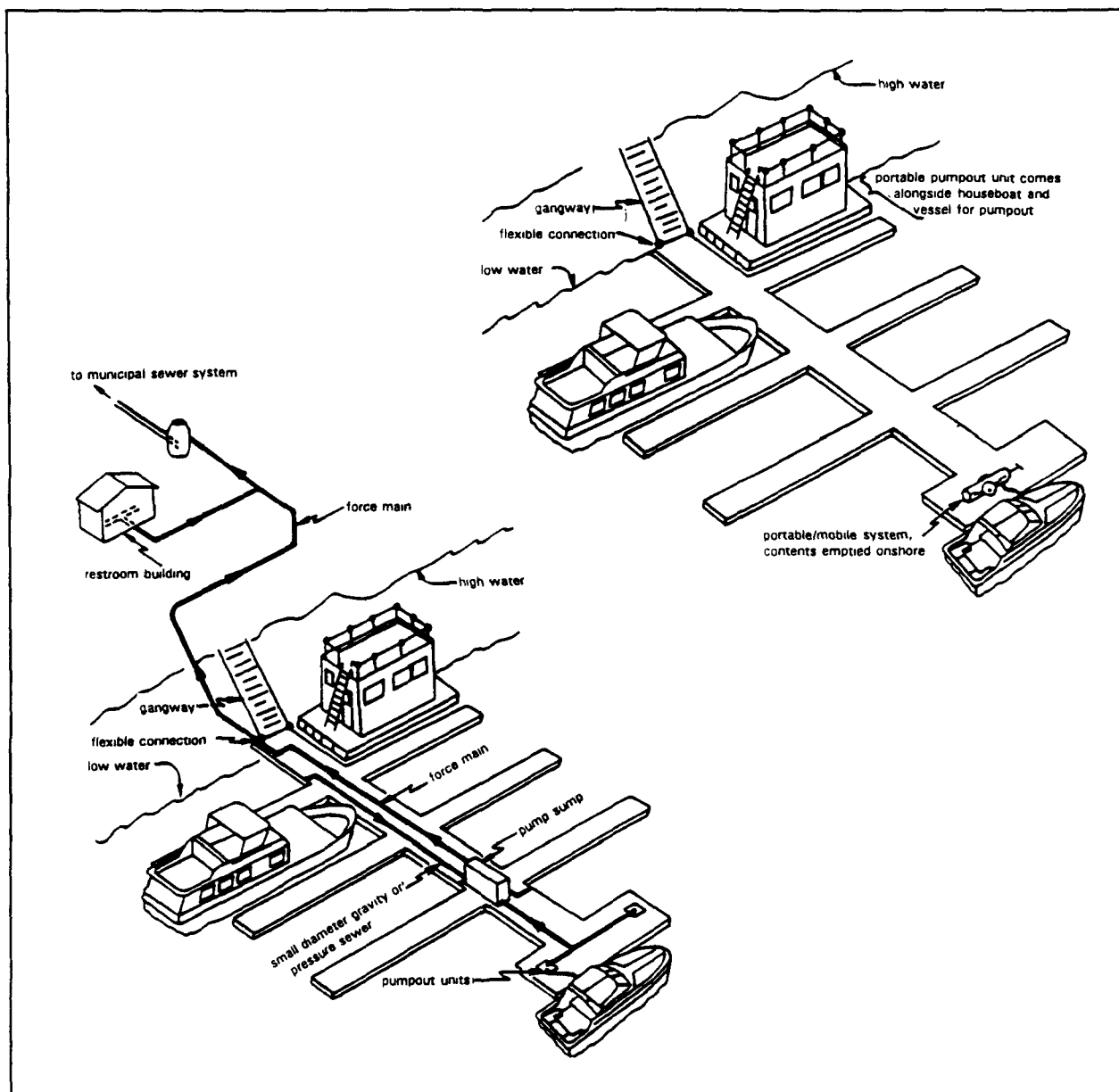

Figure 5-8. Examples of pumpout devices.

dispatched pumpout boat. The pumpout boat goes to a vessel in response to a radio-transmitted request, pumps the holding tank, and moves on to the next requesting vessel. This approach eliminates the inconvenience of lines, docking, and maneuvering vessels in high-traffic areas.

Costs associated with pumpouts vary according to the size of the marina and the type of pumpout system. Table 5-4 presents 1985 cost information for three marina sizes and two types of pumpout systems (USEPA, 1985a). More recent systems are less expensive, with a homemade portable system costing less than \$250 in parts and commercial portable units available for between \$2,000 and \$4,000 (Natchez, 1991).

c. Dedicated Slipside Systems

Dedicated slipside systems provide continuous wastewater collection at a slip. Slipside pumpout should be provided to live-aboard vessels. The remainder of the marina can still be served by either marina-wide or mobile pumpout systems.

**Table 5-4. Annual Per Slip Pumpout Costs for Three Collection Systems^a
(USEPA, 1985a)**

	Marina-Wide	Portable/Mobile	Slipside
Small Marina (200 slips)			
Capital Costs	15 ^b	15 ^c	102 ^b
O&M Costs	110	200	50
Total Cost/Slip/Year	125	215	152
Medium Marina (500 slips)			
Capital Costs	17	10	101
O&M Costs	90	160	40
Total Cost/Slip/Year	107	170	141
Large Marina (2000 slips)			
Capital Costs	16	10	113
O&M Costs	80	140	36
Total Cost/Slip/Year	96	150	149

^a 1985 data; all figures in dollars.

^b Based on 12% interest, 15 years amortization.

^c 12% interest, 15 years on piping; 12% interest, 15 years on portable units.

■ d. Adequate Signage

Marina operators should post ample signs prohibiting the discharge of sanitary waste from boats into the waters of the State, including the marina basin, and also explaining the availability of pumpout services and public restroom facilities. Signs should also fully explain the procedures and rules governing the use of the pumpout facilities. An example of an easily understandable sign that has been used to advertise the availability of pumpout facilities is presented in Figure 5-9 (Keko, Inc., 1992).



Figure 5-9. Example signage advertising pumpout availability (Keko, Inc., 1992).

III. MARINA AND BOAT OPERATION AND MAINTENANCE

During the course of normal marina operations, various activities and locations in the marina can generate polluting substances. Such activities include waste disposal, boat fueling, and boat maintenance and cleaning; such locations include storage areas for materials required for these activities and hull maintenance areas (METRO, 1992a; Tobiasson and Kollmeyer, 1991). Of special concern are substances that can be toxic to aquatic biota, pose a threat to human health, or degrade water quality.¹ Paint sandings and chippings, oil and grease, fuel, detergents, and sewage are examples (METRO, 1992a; Tobiasson and Kollmeyer, 1991).

It is important that marina operators and patrons take steps to control or minimize the entry of these substances into marina waters. For the most part, this can be accomplished with simple preventative measures such as performing these activities on protected sites, locating servicing equipment where the risk of spillage is reduced (see Siting and Design section of this chapter), providing adequate and well-marked disposal facilities, and educating the boating public about the importance of pollution prevention. The benefit of effective pollution prevention to the marina operator can be measured as the relative low cost of pollution prevention compared to potentially high environmental clean-up costs (Tobiasson and Kollmeyer, 1991).

For those planning to build a marina, attention to the environmental concerns of marina operation during the marina design phase will significantly reduce the potential for generating pollution from these activities. For existing marinas, minor changes in operations, staff training, and boater education should help protect marina waters from these sources of pollution. The management measures that follow address the control of pollution from marina operation and maintenance activities.

¹See Section I.F for further discussion.

A. Solid Waste Management Measure

Properly dispose of solid wastes produced by the operation, cleaning, maintenance, and repair of boats to limit entry of solid wastes to surface waters.

1. Applicability

This management measure is intended to be applied by States to new and expanding² marinas. Under the Coastal Zone Act Reauthorization Amendments of 1990, States are subject to a number of requirements as they develop coastal nonpoint source programs in conformity with this measure and will have some flexibility in doing so. The application of management measures by States is described more fully in *Coastal Nonpoint Pollution Control Program: Program Development and Approval Guidance*, published jointly by the U.S. Environmental Protection Agency (EPA) and the National Oceanic and Atmospheric Administration (NOAA) of the U.S. Department of Commerce.

2. Description

Marina operators are responsible for determining what types of wastes will be generated at the marina and ensuring proper disposal. Marina operators are thus responsible for the contents of their dumpsters and the management of solid waste on their property. Hazardous waste should never be placed in dumpsters. Liquid waste should not be mixed with solid waste but rather disposed of properly by other methods (see Liquid Waste Management Measure).

3. Management Measure Selection

This measure was selected because marinas have shown the ability to minimize the entry of solid waste into surface waters through implementation of some or all of the practices. Marinas generate a variety of solid waste through the activities that occur on marina property and at their piers. If adequate disposal facilities are not available there is a potential for disposal of solid waste in surface waters or on shore areas where the material can wash into surface waters. Marina patrons and employees are more likely to properly dispose of solid waste if given adequate opportunity and disposal facilities. Under Federal law, marinas and port facilities must supply adequate and convenient waste disposal facilities for their customers (NOAA, 1988).

4. Practices

As discussed more fully at the beginning of this chapter and in Chapter 1, the following practices are described for illustrative purposes only. State programs need not require implementation of these practices. However, as a practical matter, EPA anticipates that the management measure set forth above generally will be implemented by applying one or more management practices appropriate to the source, location, and climate. The practices set forth below have been found by EPA to be representative of the types of practices that can be applied successfully to achieve the management measure described above.

²Refer to Section I.H (General Applicability) for additional information on expansions of existing marinas.

- a. *Perform boat maintenance/cleaning above the waterline in such a way that no debris falls into the water.*

This subject is also addressed under the Boat Cleaning Management Measure later in this chapter.

- b. *Provide and clearly mark designated work areas for boat repair and maintenance. Do not permit work outside designated areas.*
- c. *Clean hull maintenance areas regularly to remove trash, sandings, paint chips, etc.*

Vacuuming is the preferred method of collecting these wastes.

- d. *Perform abrasive blasting within spray booths or plastic tarp enclosures to prevent residue from being carried into surface waters. If tarps are used, blasting should not be done on windy days.*
- e. *Provide proper disposal facilities to marina patrons. Covered dumpsters or other covered receptacles are preferred.*

While awaiting transfer to a landfill, dumpsters in which items such as used oil filters are stored should be covered to prevent rain from leaching material from the dumpster onto the ground.

- f. *Provide facilities for the eventual recycling of appropriate materials.*

Recycling of nonhazardous solid waste such as scrap metal, aluminum, glass, wood pallets, paper, and cardboard is recommended wherever feasible. Used lead-acid batteries should be stored on an impervious surface, under cover, and sent to or picked up by an approved recycler. Receipts should be retained for inspection.

B. Fish Waste Management Measure

Promote sound fish waste management through a combination of fish-cleaning restrictions, public education, and proper disposal of fish waste.

1. Applicability

This management measure is intended to be applied by States to marinas where fish waste is determined to be a source of water pollution. Under the Coastal Zone Act Reauthorization Amendments of 1990, States are subject to a number of requirements as they develop coastal nonpoint source programs in conformity with this measure and will have some flexibility in doing so. The application of management measures by States is described more fully in *Coastal Nonpoint Pollution Control Program: Program Development and Approval Guidance*, published jointly by the U.S. Environmental Protection Agency (EPA) and the National Oceanic and Atmospheric Administration (NOAA) of the U.S. Department of Commerce.

2. Description

Fish waste can result in water quality problems at marinas with large numbers of fish landings or at marinas that have limited fish landings but poor flushing. The amount of fish waste disposed of into a small area such as a marina can exceed that existing naturally in the water at any one time. Fish waste decomposes, which requires oxygen. In sufficient quantity, disposal of fish waste can thus be a cause of dissolved oxygen depression as well as odor problems (DNREC, 1990; McDougal et al., 1986).

3. Management Measure Selection

This measure was selected because marinas have shown the ability to prevent fish-waste-induced water quality or aesthetic problems through implementation of the identified practices. Marinas that cater to patrons who fish a large amount can produce a large amount of fish waste at the marina from fish cleaning. If adequate disposal facilities are not available, there is a potential for disposal of fish waste in areas without enough flushing to prevent decomposition and the resulting dissolved oxygen depression and odor problems. Marina patrons and employees are more likely to properly dispose of fish waste if told of potential consequences and provided adequate and convenient disposal facilities. States require, and many marinas have already implemented, this management measure (Appendix 5A).

4. Practices

As discussed more fully at the beginning of this chapter and in Chapter 1, the following practices are described for illustrative purposes only. State programs need not require implementation of these practices. However, as a practical matter, EPA anticipates that the management measure set forth above generally will be implemented by applying one or more management practices appropriate to the source, location, and climate. The practices set forth below have been found by EPA to be representative of the types of practices that can be applied successfully to achieve the management measure described above.

■ a. Establish fish-cleaning areas.

Particular areas can be set aside or designated for the cleaning of fish, and receptacles can be provided for the waste. Boaters and fishermen should be advised to use only these areas for fish cleaning, and the waste collected in the receptacles should be disposed of properly.

■ b. Issue rules governing the conduct and location of fish-cleaning operations.

Marinas can issue rules regarding the cleaning of fish at the marina, depending on the type of services offered by the marina and its clientele. Marinas not equipped to handle fish wastes may prohibit the cleaning of fish at the marina; those hosting fishing competitions or having a large fishing clientele should establish fish-cleaning areas with specific rules for their use and should establish penalties for violation of the rules.

■ c. Educate boaters regarding the importance of proper fish-cleaning practices.

Boaters should be educated about the problems created by discarding their fish waste into marina waters, proper disposal practices, and the ecological advantages of cleaning their fish at sea and discarding the wastes into the water where the fish were caught. Signs posted on the docks (especially where fish cleaning has typically been done) and talks with boaters during the course of other marina operations can help to educate boaters about marina rules governing fish waste and its proper disposal.

■ d. Implement fish composting where appropriate.

A law passed in 1989 in New York forbids discarding fish waste, with exceptions, into fresh water or within 100 feet of shore (White et al., 1989). Contaminants in some fish leave few alternatives for disposing of fish waste, so Cornell University and the New York Sea Grant Extension Program conducted a fish composting project to deal with the over 2 million pounds of fish waste generated by the salmonid fishery each year. They found that even with this quantity of waste, if composting was properly conducted the problems of odor, rodents, and maggots were minimal and the process was effective (White et al., 1989). Another method of fish waste composting described by the University of Wisconsin Sea Grant Institute is suitable for amounts of compost ranging from a bucketful to the quantities produced by a fish-processing plant (Frederick et al., 1989).

C. Liquid Material Management Measure

Provide and maintain appropriate storage, transfer, containment, and disposal facilities for liquid material, such as oil, harmful solvents, antifreeze, and paints, and encourage recycling of these materials.

1. Applicability

This management measure is intended to be applied by States to marinas where liquid materials used in the maintenance, repair, or operation of boats are stored. Under the Coastal Zone Act Reauthorization Amendments of 1990, States are subject to a number of requirements as they develop coastal nonpoint source programs in conformity with this measure and will have some flexibility in doing so. The application of management measures by States is described more fully in *Coastal Nonpoint Pollution Control Program: Program Development and Approval Guidance*, published jointly by the U.S. Environmental Protection Agency (EPA) and the National Oceanic and Atmospheric Administration (NOAA) of the U.S. Department of Commerce.

2. Description

This management measure minimizes entry of potentially harmful liquid materials into marina and surface waters through proper storage and disposal. Marina operators are responsible for the proper storage of liquid materials for sale and for final disposal of liquid wastes, such as waste fuel, used oil, spent solvents, and spent antifreeze. Marina operators should decide how liquid waste material is to be placed in the appropriate containers and disposed of and should inform their patrons.

3. Management Measure Selection

This measure was selected because marinas have shown the ability to prevent entry of liquid waste into marina and surface waters. Marinas generate a variety of liquid waste through the activities that occur on marina property and at their piers. If adequate disposal facilities are not available, there is a potential for disposal of liquid waste in surface waters or on shore areas where the material can wash into surface waters. Marina patrons and employees are more likely to properly dispose of liquid waste if given adequate opportunity and disposal facilities. The practices on which the measure is based are available. Many coastal States already have mandatory or voluntary programs that satisfy this management measure (Appendix 5A).

4. Practices

As discussed more fully at the beginning of this chapter and in Chapter 1, the following practices are described for illustrative purposes only. State programs need not require implementation of these practices. However, as a practical matter, EPA anticipates that the management measure set forth above generally will be implemented by applying one or more management practices appropriate to the source, location, and climate. The practices set forth below have been found by EPA to be representative of the types of practices that can be applied successfully to achieve the management measure described above.

- a. *Build curbs, berms, or other barriers around areas used for the storage of liquid material to contain spills. Store materials in areas impervious to the type of material stored.*

To contain spills, curbs or berms should be installed around areas where liquid material is stored. The berms or curbs should be capable of containing 10 percent of the liquid material stored or 110 percent of the largest container, whichever is greater (WADOE, 1991). There should not be drains in the floor. Implementation of this practice will prevent spilled material from directly entering surface waters. The cost of 6-inch cement curbs placed around a cement pad is \$10 to \$14 per linear foot (Means, 1990). The cost of a temporary spill dike capable of absorbing 50 liters of material (5 inches in diameter and 30 feet long) is approximately \$110 (Lab Safety, 1991).

- b. *Separate containers for the disposal of waste oil; waste gasoline; used antifreeze; and waste diesel, kerosene, and mineral spirits should be available and clearly labeled.*

Waste oil includes waste engine oil, transmission fluid, hydraulic fluid, and gear oil. A filter should be drained before disposal by placing the filter in a funnel over the appropriate waste collection container. The containers should be stored on an impermeable surface and covered in a manner that will prevent rainwater from entering the containers. Containers should be clearly marked to prevent mixing of the materials with other liquids and to assist in their identification and proper disposal. Waste should be removed from the marina site by someone permitted to handle such waste, and receipts should be retained for inspection.

Care should be taken to avoid combining different types of antifreeze. Standard antifreeze (ethylene glycol, usually identifiable by its blue or greenish color) should be recycled. If recycling is not available, propylene-glycol-based anti-freeze should be used because it is less toxic when introduced to the environment. Propylene glycol is often a pinkish hue (Gannon, 1990). Many States, including Maryland, Washington, and Oregon, have developed programs to encourage the proper disposal of used antifreeze.

Fifty-five-gallon closed-head polyethylene or steel drums approved for shipping hazardous and nonhazardous materials are available commercially at a cost of approximately \$50 each. Open-head steel drums (approximately \$60 each) with self-closing steel drum covers (approximately \$90 each) may also be used (Lab Safety, 1991). A package of five labels that may be affixed to drums (10 inches by 10 inches) costs approximately \$10.

- c. *Direct marina patrons as to the proper disposal of all liquid materials through the use of signs, mailings, and other means.*

If individuals within a marina collect, contain, and dispose of their own liquid waste, signs and education programs (see Public Education Management Measure) should direct them to proper recycling and disposal options.

D. Petroleum Control Management Measure

Reduce the amount of fuel and oil from boat bilges and fuel tank air vents entering marina and surface waters.

1. Applicability

This management measure is intended to be applied by States to boats that have inboard fuel tanks. Under the Coastal Zone Act Reauthorization Amendments of 1990, States are subject to a number of requirements as they develop coastal nonpoint source programs in conformity with this measure and will have some flexibility in doing so. The application of management measures by States is described more fully in *Coastal Nonpoint Pollution Control Program: Program Development and Approval Guidance*, published jointly by the U.S. Environmental Protection Agency (EPA) and the National Oceanic and Atmospheric Administration (NOAA) of the U.S. Department of Commerce.

2. Description

Fuel and oil are commonly released into surface waters during fueling operations through the fuel tank air vent, during bilge pumping, and from spills directly into surface waters and into boats during fueling. Oil and grease from the operation and maintenance of inboard engines are a source of petroleum in bilges.

3. Management Measure Selection

This measure was selected because (1) the practices have shown the ability to minimize the introduction of petroleum from fueling and bilge pumping and thus prevent a visible sheen on the water's surface and (2) New York State requires the installation of fuel/air separators on new boats. Boaters and fuel station attendants often inadvertently spill fuel when "topping off" fuel tanks. They know the tank is full when fuel comes out of the mandatory air vent. This is preventable by the use of attachments on the air vent that suppress overflowing. Boat bilges have automatic and manual pumps that empty directly to marina or surface waters. When activated, these pumps often cause direct discharge of oil and grease from operation and maintenance of inboard engines. Oil-absorbing bilge pads contain oil and grease and prevent their discharge.

4. Practices

As discussed more fully at the beginning of this chapter and in Chapter 1, the following practices are described for illustrative purposes only. State programs need not require implementation of these practices. However, as a practical matter, EPA anticipates that the management measure set forth above generally will be implemented by applying one or more management practices appropriate to the source, location, and climate. The practices set forth below have been found by EPA to be representative of the types of practices that can be applied successfully to achieve the management measure described above.

- a. Use automatic shut-off nozzles and promote the use of fuel/air separators on air vents or tank stems of inboard fuel tanks to reduce the amount of fuel spilled into surface waters during fueling of boats.

During the fueling of inboard tanks fuel can be spilled into surface waters due to overfilling the fuel tank. An automatic shut-off nozzle is partially effective in reducing the potential for overfilling, but often during fueling operations fuel overflows from the air vent on the fuel tank of the boat. Attachments for vents on fuel tanks, which act as fuel/air separators, are available commercially. These devices release air and vapor but contain overflowing fuel. The State of New York passed a law in 1990 that requires that all boats sold in New York after January 1, 1994, have air vents on their fuel tanks that are designed to prevent fuel overflows or spills. The commercial cost of these devices is approximately \$85 per unit. Marinas can make these units available in their retail stores and post notices describing their spill prevention benefits and availability.

- *b. Promote the use of oil-absorbing materials in the bilge areas of all boats with inboard engines. Examine these materials at least once a year and replace as necessary. Recycle them if possible, or dispose of them in accordance with petroleum disposal regulations.*

Marina operators can advertise the availability of such oil-absorbing material or can include the cost of installation of such material in yearly dock fees. Marina operators can also insert a clause in their leasing agreements that boaters will use oil-absorbing material in their bilges. Pillows/pads that absorb oils and petroleum-based products and not water are available. These pillows/pads absorb up to 12 times their weight in oil and cost approximately \$40 for a package of 10 (Lab Safety, 1991).

E. Boat Cleaning Management Measure

For boats that are in the water, perform cleaning operations to minimize, to the extent practicable, the release to surface waters of (a) harmful cleaners and solvents and (b) paint from in-water hull cleaning.

1. Applicability

This management measure is intended to be applied by States to marinas where boat topsides are cleaned and marinas where hull scrubbing in the water has been shown to result in water or sediment quality problems. Under the Coastal Zone Act Reauthorization Amendments of 1990, States are subject to a number of requirements as they develop coastal nonpoint source programs in conformity with this measure and will have some flexibility in doing so. The application of management measures by States is described more fully in *Coastal Nonpoint Pollution Control Program: Program Development and Approval Guidance*, published jointly by the U.S. Environmental Protection Agency (EPA) and the National Oceanic and Atmospheric Administration (NOAA) of the U.S. Department of Commerce.

2. Description

This measure minimizes the use and release of potentially harmful cleaners and bottom paints to marina and surface waters. Marina employees and boat owners use a variety of boat cleaners, such as teak cleaners, fiberglass polishers, and detergents. Boats are cleaned over the water or onshore adjacent to the water. This results in a high probability of some of the cleaning material entering the water. Boat bottom paint is released into marina waters when boat bottoms are cleaned in the water.

3. Management Measure Selection

This measure was selected because marinas have shown the ability to prevent entry of boat cleaners and harmful solvents as well as the release of bottom paint into marina and surface waters. The practices on which the measure is based are available, minimize entry of harmful material into marina waters, and still allow boat owners to clean their boats.

4. Practices

As discussed more fully at the beginning of this chapter and in Chapter 1, the following practices are described for illustrative purposes only. State programs need not require implementation of these practices. However, as a practical matter, EPA anticipates that the management measure set forth above generally will be implemented by applying one or more management practices appropriate to the source, location, and climate. The practices set forth below have been found by EPA to be representative of the types of practices that can be applied successfully to achieve the management measure described above.

- a. Wash the boat hull above the waterline by hand. Where feasible, remove the boat from the water and perform cleaning where debris can be captured and properly disposed of.

- b. *Detergents and cleaning compounds used for washing boats should be phosphate-free and biodegradable, and amounts used should be kept to a minimum.*
- c. *Discourage the use of detergents containing ammonia, sodium hypochlorite, chlorinated solvents, petroleum distillates, or lye.*
- d. *Do not allow in-the-water hull scraping or any process that occurs underwater to remove paint from the boat hull.*

The material removed from boat hulls treated with antifoulant paint contains high levels of toxic metals (see Table 5-1).

F. Public Education Management Measure

Public education/outreach/training programs should be instituted for boaters, as well as marina owners and operators, to prevent improper disposal of polluting material.

1. Applicability

This management measure is intended to be applied by States to all environmental control authorities in areas where marinas are located. Under the Coastal Zone Act Reauthorization Amendments of 1990, States are subject to a number of requirements as they develop coastal nonpoint source programs in conformity with this measure and will have some flexibility in doing so. The application of management measures by States is described more fully in *Coastal Nonpoint Pollution Control Program: Program Development and Approval Guidance*, published jointly by the U.S. Environmental Protection Agency (EPA) and the National Oceanic and Atmospheric Administration (NOAA) of the U.S. Department of Commerce.

2. Description

The best method of preventing pollution from marinas and boating activities is to educate the public about the causes and effects of pollution and methods to prevent it. One of the primary reasons for the success of existing programs is the widespread support for these efforts. Measuring the efficiency of the separate practices of public education and outreach programs can be extremely difficult. Programs need to be examined in terms of long-term impacts.

Creating a public education program should involve user groups and the community in all phases of program development and implementation. The program should be suited to a specific area and should use creative promotional material to spread its message. General information on how to educate and involve the public can be found in *Managing Nonpoint Pollution: An Action Plan Handbook for Puget Sound Watersheds* (PSWQA, 1989) and *Dealing with Annex V - Reference Guide for Ports* (NOAA, 1988).

3. Management Measure Selection

Measure selection is based on low cost (Table 5-5), proven effectiveness, availability, and widespread use by many States (Appendix 5A).

4. Practices

As discussed more fully at the beginning of this chapter and in Chapter 1, the following practices are described for illustrative purposes only. State programs need not require implementation of these practices. However, as a practical matter, EPA anticipates that the management measure set forth above generally will be implemented by applying one or more management practices appropriate to the source, location, and climate. The practices set forth below have been found by EPA to be representative of the types of practices that can be applied successfully to achieve the management measure described above.

Table 5-5. Approximate Costs for Educational and Promotional Material (NOAA, 1988)

Item	Quantity	Cost
Brochures	10,000	2,100
Posters	5,000	500
Decals	6,000	900
Coloring Books	3,000	1,000
Stickers	20,000	450
Signs (wood)	20	800
Litter bags	8,000	1,400
Litter bags (beach cleanup)	2,000	free
Slide shows	5	250
Photo displays	9	1,000
Sweatshirts	288	2,200
Hats	432	1,100
Notices	40	25
Videotaped programs (copies)	4	200
Radio PSAs (copies, 7 announcements)	25	250
TV Public Service Announcements (copies)	6	200
Advertisements, newspaper	2	350
Advertisements, TV	2 weeks	200
Total		12,925

NOTE: Additional costs (about \$2500) were involved in the development of the TV and radio public service announcements and brochures and in the acquisition of the rights to some art and photographic materials.

a. Signage

Interpretive and instructional signs placed at marinas and boat-launching sites are a key method of disseminating information to the boating public. The Chesapeake Bay Commission recommended that Bay States develop and implement programs to educate the boating public to stimulate increased use of pumpout facilities (CBC, 1989). The commission found that "boater education on this issue can be substantially expanded at modest expense."

Appropriate signage to direct boaters to the nearest pumpout facility to alert boaters to its presence would very likely stimulate increased use of pumpout facilities. Signs can be provided to marinas and posted in areas where recreational boats are concentrated. Ten-inch-square aluminum signs are available commercially for approximately \$12 each (Lab Safety, 1991).

■ b. Recycling/Trash Reduction Programs

A New Jersey marina issued reusable tote bags with the marina's name printed on the side. The bags were used repeatedly to transport groceries and to store recyclable materials for proper disposal (Bleier, 1991). Newport, Oregon, instituted a recycling program that was not immediately successful but has since achieved increased boater compliance (Bleier, 1991). The Louisiana and New Hampshire Sea Grant Programs both instituted successful public education programs designed to reduce the amount of marine debris discarded into surface waters (Doyle and Barnaby, 1990). The \$17,000 cost of the New Hampshire demonstration program included project organization, distribution of a season's supply of trash bags, advertising material, and project monitoring. More than 90 percent of the 91 participating boats indicated that they had made a commitment to reducing marine pollution.

■ c. Pamphlets or Flyers, Newsletters, Inserts in Billings

The Washington State Parks and Recreation Commission designed a multifaceted public education program and is working with local governments and boating groups to implement the program and evaluate its effectiveness. The program encourages the use of MSDs and pumpout facilities, discourages impacts to shellfish areas, and provides information to boaters and marina operators about environmentally sound operation and maintenance activities. The Commission has prepared written materials, given talks to boating groups, participated in events such as boat shows, and developed signs for placement at marinas and boat launches. Printed material includes a map of pumpout facilities, a booklet on boat pollution, a pamphlet on plastic debris, and articles on the effects of boating activities. Written material can be made available at marinas, supply stores, or other places frequently visited by boaters. Approximate costs of some educational and promotional materials used in a Newport, Oregon, program are presented in Table 5-5 (NOAA, 1988). Written material describing the importance of boater cooperation in solving the problems associated with marine discharges could be included with annual boat registration forms, and cooperative programs involving State environmental agencies and boaters' organizations could be established.

■ d. Meetings/Presentations

Presentations at local marinas or other locations are a good way to discuss issues with boaters and marina owners and operators. The New Moon Project in Puget Sound is a public education program that is attempting to increase use of portable sewage pumpouts. This effort has included workshops and seminars for boaters, marina operators, and harbor masters. The presentations have produced interest from marina operators who want to participate and boaters who want additional material (NYBA, 1990). Presentations can also present the positive aspects of marinas and successful case studies of pollution prevention and control.

G. Maintenance of Sewage Facilities Management Measure

Ensure that sewage pumpout facilities are maintained in operational condition and encourage their use.

1. Applicability

This management measure is intended to be applied by States to marinas where marine sewage disposal facilities exist. Under the Coastal Zone Act Reauthorization Amendments of 1990, States are subject to a number of requirements as they develop coastal nonpoint source programs in conformity with this measure and will have some flexibility in doing so. The application of management measures by States is described more fully in *Coastal Nonpoint Pollution Control Program: Program Development and Approval Guidance*, published jointly by the U.S. Environmental Protection Agency (EPA) and the National Oceanic and Atmospheric Administration (NOAA) of the U.S. Department of Commerce.

2. Description

The purpose of this measure is to reduce the release of untreated sewage into marina and surface waters.

3. Management Measure Selection

This measure was selected because it is effective in preventing failure of pumpouts and discourages improper disposal of sanitary wastes. Also, many pumpouts are not properly maintained, limiting their use. The Maryland Department of Natural Resources (MDDNR, 1991) provides operation and maintenance information on pumpouts to marina owners and operators in an effort to increase availability and use of pumpouts. Many other States inspect pumpout facilities to ensure that they are in operational condition (Appendix 5A).

4. Practices

As discussed more fully at the beginning of this chapter and in Chapter 1, the following practices are described for illustrative purposes only. State programs need not require implementation of these practices. However, as a practical matter, EPA anticipates that the management measure set forth above generally will be implemented by applying one or more management practices appropriate to the source, location, and climate. The practices set forth below have been found by EPA to be representative of the types of practices that can be applied successfully to achieve the management measure described above.

- a. *Arrange maintenance contracts with contractors competent in the repair and servicing of pumpout facilities.*
- b. *Develop regular inspection schedules.*
- c. *Maintain a dedicated fund for the repair and maintenance of marina pumpout stations. (Government-owned facilities only)*

- d. *Add language to slip leasing agreements mandating the use of pumpout facilities and specifying penalties for failure to comply.*

- e. *Place dye tablets in holding tanks to discourage illegal disposal.*

Boating activities that result in excessive fecal coliform bacteria levels can be addressed through the placement of a dye tablet in the holding tanks of all boats entering the adversely impacted waterbody. This practice was employed in Avalon Harbor, California, after moored boats were determined to be the source of problem levels of fecal coliform bacteria. Upon entering the harbor, a harbor patrol officer boards each vessel and places dye tablets in all sanitary devices. The officer then flushes the devices to ensure that the holding tanks do not leak. During the first 3 years of implementation, this practice detected 135 violations of the no-discharge policy and was extremely successful at reducing pollution levels (Smith et al., 1991). One tablet in approximately 60 gallons of water will give a visible dye concentration of one part per million. The cost of the tablets is approximately \$30 per 200 tablets (Forestry Suppliers, 1992).

H. Boat Operation Management Measure (applies to boating only)

Restrict boating activities where necessary to decrease turbidity and physical destruction of shallow-water habitat.

1. Applicability

This management measure is intended to be applied by States in non-marina surface waters where evidence indicates that boating activities are impacting shallow-water habitats. Under the Coastal Zone Act Reauthorization Amendments of 1990, States are subject to a number of requirements as they develop coastal nonpoint source programs in conformity with this measure and will have some flexibility in doing so. The application of management measures by States is described more fully in *Coastal Nonpoint Pollution Control Program: Program Development and Approval Guidance*, published jointly by the U.S. Environmental Protection Agency (EPA) and the National Oceanic and Atmospheric Administration (NOAA) of the U.S. Department of Commerce.

2. Description

Boat operation can resuspend bottom sediment, resulting in the reintroduction of toxic substances into the water column. It can increase turbidity, which affects the photosynthetic activity of algae and submerged aquatic vegetation (SAV). SAV provides habitat for fish, shellfish, and waterfowl and plays an important role in maintaining water quality through assimilating nutrients. It also reduces wave energy, protecting shorelines and bottom habitats from erosion. Replacing SAV once it has been uprooted or eliminated from an area is difficult, and the science of replacing it artificially is not well-developed. It is therefore important to protect existing SAV. Boat operation may also cut off or uproot SAV, damage corals and oyster reefs, and cause other habitat destruction. The definition of shallow-water habitat should be determined by State policy and should be dependent upon the ecological importance and sensitivity to direct and indirect disruption of the habitats found in the State.

3. Management Measure Selection

This measure was selected because some areas are not suitable for boat traffic due to their shallow water depth and the ecological importance and sensitivity to disruption of the types of habitats in the area. Excluding boats from such areas will minimize direct habitat destruction. Establishing no-wake zones will minimize the indirect impacts of increased turbidity (e.g., decreased light availability).

4. Practices

As discussed more fully at the beginning of this chapter and in Chapter 1, the following practices are described for illustrative purposes only. State programs need not require implementation of these practices. However, as a practical matter, EPA anticipates that the management measure set forth above generally will be implemented by applying one or more management practices appropriate to the source, location, and climate. The practices set forth below have been found by EPA to be representative of the types of practices that can be applied successfully to achieve the management measure described above.

■ a. *Exclude motorized vessels from areas that contain important shallow-water habitat.*

Many areas of shallow SAV exhibit troughs (areas of no vegetation) due to the action of boat propellers. This can result in increased erosion of the SAV due to the loss of bottom cover cohesion. SAV should be protected from boat or propeller damage because of its high habitat value.

■ b. *Establish and enforce no-wake zones to decrease turbidity.*

No-wake zones should be used in place of speed zones in shallow surface waters for reducing the turbidity caused by boat traffic. Motorboats traveling at relatively slow speeds of 6 to 8 knots in shallow waters can be expected to produce waves at or near the maximum size that can be produced by the boats. The height of a wave is directly proportional to the depth of water in which the wave will disturb the bottom (e.g., a taller wave will disturb the bottom of water deeper than a shorter wave). Bottom sediments composed of fine material will be resuspended and result in turbidity. In areas of high boat traffic, boat-induced turbidity can reduce the photosynthetic activity of SAV. Chapter 6 contains additional information on how to implement this practice.

IV. GLOSSARY

Bathymetric: Pertaining to the depth of a waterbody.

Bed load transport: Sediment transport along the bottom of a waterbody due to currents.

Benthic: Associated with the sea bottom.

Biocriteria: Biological measures of the health of an environment, such as the incidence of cancer in benthic fish species.

BOD: Biochemical oxygen demand; the quantity of dissolved oxygen used by microorganisms in the biochemical oxidation of organic matter and oxidizable inorganic matter by aerobic biological action.

Circulation cell: See *gyre*.

Conservative pollutant: A pollutant that remains chemically unchanged in the water.

Critical habitat: A habitat determined to be important to the survival of a threatened or endangered species, to general environmental quality, or for other reasons as designated by the State or Federal government.

DO: Dissolved oxygen; the concentration of free molecular oxygen in the water column.

Drogue-release study: A study of currents and circulation patterns using objects, or drogues, placed in the water at the surface or at specified depths.

Dye-release study: A study of dispersion using nontoxic dyes.

Exchange boundary: The boundary between one waterbody, e.g., a marina, and its parent waterbody; usually the marina entrance(s).

Fecal coliform: Bacteria present in mammalian feces, used as an indicator of the presence of human feces, bacteria, viruses, and pathogens in the water column.

Fixed breakwater: A breakwater constructed of solid, stationary materials.

Floating breakwater: A breakwater constructed to possess a limited range of movement.

Flushing time: Time required for a waterbody, e.g., a marina, to exchange its water with water from the parent waterbody.

Gyre: A mass of water circulating as a unit and separated from other circulating water masses by a boundary of relatively stationary water.

Hydrographic: Pertaining to ground or surface water.

Ichthyofauna: Fish.

Macrophytes: Plants visible to the naked eye.

Mathematical modeling: Predicting the performance of a design based on mathematical equations.

Micron: Micrometer; one-one millionth (0.000001) of a meter.

NCDEM DO model: A mathematical model for calculating dissolved oxygen concentrations developed by the North Carolina Division of Environmental Management (NCDEM).

No-discharge zone: An area where the discharge of polluting materials is not permitted.

NPDES: National Pollutant Discharge Elimination System. A permitting system for point source polluters regulated under section 402 of the Clean Water Act.

Numerical modeling: See *mathematical modeling*.

Nutrient transformers: Biological organisms, usually plants, that remove nutrients from water and incorporate them into tissue matter.

Organics: Carbon-containing substances such as oil, gasoline, and plant matter.

PAH: Polynuclear aromatic hydrocarbon; multiringed carbon molecules resulting from the burning of fossil fuels, wood, etc.

Physical modeling: Using a small-scale physical structure to simulate and predict the performance of a full-scale structural design.

Rapid bioassessment: An assessment of the environmental degradation of a waterbody based on a comparison between a typical species assemblage in a pristine waterbody and that found in the waterbody of interest.

Removal efficiency: The capacity of a pollution control device to remove pollutants from wastewater or runoff.

Residence time: The length of time water remains in a waterbody. Generally the same as *flushing time*.

Riparian: For the purposes of this report, riparian refers to areas adjoining coastal waterbodies, including rivers, streams, bays, estuaries, coves, etc.

Sensitivity analysis: Modifying a numerical model's parameters to investigate the relationship between alternative [marina] designs and water quality.

Shoaling: Deposition of sediment causing a waterbody or location within a waterbody to become more shallow.

Significant: A quantity, amount, or degree of importance determined by a State or local government.

SOD: Sediment oxygen demand; biochemical oxygen demand of microorganisms living in sediments.

Suspended solids: Solid materials that remain suspended in the water column.

Tidal prism: The difference in the volume of water in a waterbody between low and high tides.

Tidal range: The difference in height between mean low tide and mean high tide.

Velocity shear: Friction created by two masses of water moving in different directions or at different speeds in the same direction.

WASP4 model: A generalized modeling system for contaminant fate and transport in surface waters; can be applied to BOD, DO, nutrients, bacteria, and toxic chemicals.

V. REFERENCES

- Askren, D.R. 1979. *Numerical Simulation of Sedimentation and Circulation in Rectangular Marina Basins*. U.S. Department of Commerce, National Oceanic and Atmospheric Administration, Rockville, MD. NOAA Technical Report NOS 77.
- Barada, W., and W.M. Partington. 1972. *Report of Investigation of the Environmental Effects of Private Water Front Canals*. Board of Trustees of the Internal Improvement Fund, State of Florida.
- Bell, F.W. 1990. *Economic Impact of Bluebelting Incentives on the Marina Industry in Florida*. Florida Sea Grant College Program, Florida State University, Tallahassee, FL.
- Bleier, A. 1991. Waste Management/Marine Sanitation. In *Proceedings of the 1991 National Applied Marina Research Conference*, ed. N. Ross. International Marina Institute, Wickford, RI.
- Braam, G.A., and W.A. Jansen. 1991. North Point Marina—A Case Study. In *World Marina '91: Proceedings of the First International Conference*, American Society of Civil Engineers, Long Beach, CA, 4-8 September 1991.
- British Columbia Research Corporation. 1991. *Urban Runoff Quality and Treatment: A Comprehensive Review*. GVRD.
- British Waterways Board. 1983. *Waterway Ecology and the Design of Recreational Craft*. Inland Waterways Amenity Advisory Council, London, England.
- Cahill Associates. 1991. *Limiting NPS Pollution from New Development in the New Jersey Coastal Zone*. New Jersey Department of Environmental Protection.
- Camfield, R.E., R.E.L. Ray, and J.W. Eckert. 1980. *The Possible Impact of Vessel Wakes on Bank Erosion*. Prepared for U.S. Department of Transportation, United States Coast Guard, Office of Research and Development, Washington, DC.
- Cape Cod Commission. 1991. *Regional Policy Plan*. Barnstable County, Massachusetts.
- Cardwell, R.D., M.I. Car, and E.W. Sanborn. 1978. *Water Quality and Biotic Characteristics of Birch Bay Village Marina in 1977 (October 1, 1976 to December 31, 1977)*. Washington Department of Fisheries Protection. Report No. 69.
- Cardwell, R.D., and R.R. Koons. 1981. *Biological Consideration for the Siting and Design of Marinas and Affiliated Structures in Puget Sound*. Washington Department of Fisheries Technical Report No. 60.
- Cardwell, R.D., R.E. Nece, and E.P. Richey. 1980. Fish, Flushing, and Water Quality: Their Roles in Marina Design. In *Coastal Zone '80: Proceedings of the Second Symposium on Coastal and Ocean Management*, ASCE, Hollywood, FL.
- CARWQCB. 1989. Staff report: State Mussel Watch Program. California Regional Water Quality Control Board, Los Angeles Region. March 27, 1989.
- CBC. 1989. *Issues and Actions*. Chesapeake Bay Commission, Annapolis, MD.
- CDEP. 1991. *Best Management Practices for Marinas, Draft Report*. Connecticut Department of Environmental Protection, Long Island Sound Program, Hartford, CT.

- Cheyne, M., and N. Carter. 1989. *The 1988 Puget Sound Recreational Boaters Survey*. Washington Public Ports Association and Parks and Recreation Commission, State of Washington.
- Christensen, B.A. 1986. Marina Design and Environmental Concern. In *Ports 86: Proceedings of a Specialty Conference on Innovations in Port Engineering and Development in the 1990's*, American Society of Civil Engineers, Oakland, CA, 19-21 May 1986.
- Chmura, G.L., and N.W. Ross. 1978. *The Environmental Impacts of Marinas and Their Boats: A Literature Review with Management Considerations*. Marine Advisory Service, University of Rhode Island, Narragansett, RI.
- City of Austin. 1990. *The First Flush of Runoff and its Effects on Control Structure Design*.
- Clark, W.F. 1990. *North Carolina's Estuaries: A Pilot Study for Managing Multiple Use in the State's Public Trust Waters*. Albemarle-Pamlico Study report 90-10. University of North Carolina Sea Grant College Program.
- Cubit Engineering. 1982. *Wexford Marina Water Quality Analysis*. Prepared for Willard Byrd and Associates.
- Dickerson, G. 1992. Sales representative for Capital Vacuum, Raleigh, NC. Personal communication with Julie Duffin, Research Triangle Institute, 13 May 1992.
- Doyle, B., and R., Barnaby. 1990. *Reducing Marine Debris: A Model Program for Marinas*. University of New Hampshire Sea Grant College Program. International Marina Institute, Wickford, RI.
- DNREC. 1990. *State of Delaware Marina Guidebook*. Delaware Department of Natural Resources and Environmental Control, Dover, DE.
- Dunham, J.W., and A.A. Finn. 1974. *Small-craft Harbors: Design, Construction, and Operation*. U.S. Coastal Engineering Research Center, Fort Belvoir, VA. December. Special Report No. 2.
- Fisher, J.S., R.R. Perdue, M.F. Overton, M.D. Sobsey, and B.L. Sill, 1987. *Comparison of Water Quality at Two Recreational Marinas During a Peak-Use Period*. University of North Carolina Sea Grant College Program, Raleigh, NC.
- Forestry Suppliers. 1992. *Environmental 1992 Catalog*. Forestry Suppliers, Inc., Jackson, MS.
- Frederick, L., R. Harris., L. Peterson, and S. Kehrmeyer. 1989. *The Compost Solution to Dockside Fish Wastes*. University of Wisconsin Sea Grant Institute. WISCU-G-89-002 C3.
- Gaines, A.G., and A.R. Solow. 1990. *The Distribution of Fecal Coliform Bacteria in Surface Waters of the Edgartown Harbor Coastal Complex and Management Implications*. Woods Hole Oceanographic Institution, Woods Hole, MA.
- Gannon, T. 1990. Ethylene or Propylene? *Practical Sailor*, 16(19):15.
- Goodwin, F.R. 1988. Urban Ports and Harbor Management: Responding to Change Along U.S. Waterfront.
- Grovhoug, J.G., P.F. Seligman, G. Vafa, and R.L. Fransham. 1986. Baseline Measurements of Butyltin in U.S. Harbors and Estuaries. In *Proceedings Oceans 86, Volume 4 Organotin Symposium*, pp. 1283-1288. Institute of Electrical and Electronics Engineers, Inc., New York, NY.
- Hall, L.W., Jr., M.J. Lenkevich, W.S. Hall, A.E. Pinkney, and S.T. Bushong. 1987. Evaluation of Butyltin Compounds in Maryland Waters of Chesapeake Bay. *Marine Pollution Bulletin*, 18(2):78-83.

- Holland, R.C. 1986. Designing Marinas to Mitigate Impacts. In *Ports 86: Proceedings of a Specialty Conference on Innovations in Port Engineering and Development in the 1990's*, American Society of Civil Engineers, Oakland, CA, 19-21 May 1986.
- Horner, R.R., F.B. Gutermuth, L.L. Conquest, and A.W. Johnson. 1988. Urban Stormwater and Puget Trough Wetlands. In *First Annual Meeting for Puget Sound Research*, 18-19 March 1988, Seattle, WA. Puget Sound Water Quality Authority.
- Industrial Products Co. 1991. *Safety Equipment and Supplies*. Industrial Products Co., Langhorne, PA.
- Jansen, W.A. 1991. Personal communication, 24 October 1991.
- Johnston, S.A., Jr. 1981. Estuarine Dredge and Fill Activities: A Review of Impacts. *Journal of Environmental Management*, 5(5):427-440.
- Karp, C.A., and C.A. Penniman. 1991. *Boater Waste Disposal "Briefing Paper" and Proceedings from Narragansett Bay Project Management Committee*. The Narragansett Project, Rhode Island.
- Keko, Inc. 1992. Letter dated April 13, 1992, to Geoffrey Grubbs, Director, Assessment and Watershed Protection Division, U.S. Environmental Protection Agency, from W. Kenton, President, Keko, Inc.
- Klein, R.D. 1992. *The Effects of Boating Activity and Related Facilities Upon Small, Tidal Waterways in Maryland*. Community and Environmental Defense Services, Maryland Line, MD.
- Lab Safety. 1991. *1992 Safety Essentials Catalog*. Spring edition. Lab Safety Supply, Inc., Janesville, WI.
- Layton, J.A. 1980. Hydraulic Circulation Performance of a Curvilinear Marina. In *Proceedings of the 17th International Conference on Coastal Engineering*, American Society of Civil Engineers, Sydney, Australia, 23-28 March 1980.
- Layton, J.A. 1991a. Case History of the Point Roberts Marina. In *World Marina '91: Proceedings of the First International Conference*, American Society of Civil Engineers, Long Beach, CA, 4-8 September 1991.
- Layton, J.A. 1991b. Personal communication, 24 October 1991.
- Leonard, D.L., M.A. Broutman, and K.E. Harkness. 1989. *The Quality of Shellfish Growing Water on the East Coast of the United States*. U.S. Department of Commerce, National Oceanic and Atmospheric Administration, Rockville, MD.
- Lowrance, R.R., S. McIntyre, and C. Lance. 1988. Erosion and Deposition in a Field/Forest System Estimated Using Cesium-137 Activity. *Journal of Soil and Water Conservation*, 43(2):195-199.
- Maguire, R.J. 1986. Review of the Occurrence, Persistence and Degradation of Tributyltin in Fresh Water Ecosystems in Canada. In *Proceedings Oceans 86, Volume 4 Organotin Symposium*, pp. 1252-1255. Institute of Electrical and Electronics Engineers, Inc., New York, NY.
- Marcus, J.M., and T.P. Stokes. 1985. Polynuclear Aromatic Hydrocarbons in Oyster Tissue and Around Three Coastal Marinas. *Bulletin of Environmental Contamination and Toxicology*, 35:833-844.
- Marcus, J.M., G.R. Swearingen, A.D. Williams, and D.D. Heizer. 1988. Polynuclear Aromatic Hydrocarbons and Heavy Metals Concentrations in Sediments at Coastal South Carolina Marinas. *Archives of Environmental Contamination and Toxicology*, 17:103-113.
- Massachusetts Coastal Zone Management. 1988. *Harbor Planning Guidelines*. Harbor Planning Program.

- Massachusetts Coastal Zone Management. 1991. *Local Comprehensive Plans: Draft Guidance Document*.
- McDougal, W.G., R.S. Mustain, L.S. Slotta, and J.M. Milbrat. 1986. Marina Flushing and Sedimentation. In *Proceedings of a Specialty Conference on Innovations in Port Engineering and Development in the 1990's*, American Society of Civil Engineers, pp. 323-332.
- McMahon, P.J.T. 1989. The Impact of Marinas on Water Quality. *Water Science Technology*, 21(2):39-43.
- MDDNR. 1991. *A Guidebook for Marina Owners and Operators on the Installation and Operation of Sewage Pumpout Stations*. Maryland Department of Natural Resources, Boating Administration, Annapolis, MD.
- METRO. 1992a. *Maritime Industrial Waste Project: Reduction of Toxicant Pollution from the Maritime Industry in Puget Sound*. Municipality of Metropolitan Seattle Water Pollution Control Department, Industrial Waste Section, Seattle, WA.
- METRO. 1992b. *Boatyard Wastewater Treatment Guidelines*. Municipality of Metropolitan Seattle, Water Pollution Control Department, Industrial Waste Section. Seattle, WA.
- Milliken, A.S., and V. Lee. 1990. *Pollution Impacts from Recreational Boating: A Bibliography and Summary Review*. Rhode Island Sea Grant Publications, University of Rhode Island Bay Campus, Narragansett, RI.
- Mills, W.B., D.B. Porcella, M.J. Unga, S.A. Gherini, K.V. Summers, M. Lingfung, G.L. Rupp, G.L. Bowie, and D.A. Haith. 1985. *Water Quality Assessment: A Screening Procedure for Toxic and Conventional Pollutants*. U.S. Environmental Protection Agency, Athens, GA. EPA/600/6-85/002a,b.
- Mitsch, W.J., and J.G. Gosselink. 1986. *Wetlands*. Van Nostrand Reinhold Co., New York, NY.
- Moffatt and Nichol. 1986. Modification to the North Point Marina Breakwater Structures Based on the Physical Model Study.
- Murawski, W.S. 1969. *A Study of Submerged Dredge Holes in New Jersey Estuaries with Respect to Their Fitness as Finfish Habitat*. Prepared for New Jersey Department of Conservation and Economic Development, Division of Fish and Game, Bureau of Fisheries, Nacote Creek Research Station. August. Miscellaneous Report No. 2M.
- Myers, J. 1989. *Evaluation of Best Management Practices Applied to Control of Stormwater-borne Pollution in Mamaroneck Harbor, New York: Analysis and Recommendations*. Prepared for the Long Island Sound Study, U.S. EPA Region 2.
- Myers, J. 1991. Working With Local Governments to Enhance the Effectiveness of a Bay-wide Critical Area Program. Presented at the U.S. Environmental Protection Agency Nonpoint Source Watershed Workshop, 29-31 January, New Orleans, LA.
- Natchez, D.S. 1990. *Marina Structures as Sources of Environmental Habitats*. International Marina Institute, Wickford, RI.
- Natchez, D.S. 1991. *Are Marinas Really Polluting?* International Marina Institute, Wickford, RI.
- NCDEM. 1990. *North Carolina Coastal Marinas: Water Quality Assessment*. North Carolina Division of Environmental Management, Raleigh, NC. Report No. 90-01.
- NCDEM. 1991. *Coastal Marinas: Field Survey of Contaminants and Literature Review*. North Carolina Division of Environmental Management, Raleigh, NC. Report No. 91-03.

- Nece, R.E. 1981. Platform Effects on Tidal Flushing of Marinas. *Journal of Waterway, Port, Coastal and Ocean Engineering*, 110(2):251-268.
- Nielsen, T.A. 1991. Case Study: A San Diego Boatyard's Approach to Environmental Compliance. In *Proceedings of the 1991 National Applied Marina Research Conference*, ed. N. Ross. International Marina Institute, Wickford, RI.
- Nixon, S.W., C.A. Oviatt, and S.L. Northby. 1973. *Ecology of Small Boat Marinas*. Marine Technical Report Series No. 5, University of Rhode Island, Kingston, RI.
- NOAA. 1976. *Coastal Facility Guidelines*. U.S. Department of Commerce, National Oceanic and Atmospheric Administration, Office of Coastal Zone Management. Washington, DC.
- NOAA. 1988. *Dealing with Annex V—Reference Guide for Ports*. U.S. Department of Commerce, National Oceanic and Atmospheric Administration, National Marine Fisheries Service, Seattle, WA. NOAA Technical Memorandum NMFS F/NWR-23.
- NRC. 1987. National Research Council. *Sedimentation Control to Reduce Maintenance Dredging of Navigational Facilities In Estuaries*. National Research Council, Marine Board, Commission on Engineering and Technical Systems. National Academy Press, Washington, DC.
- NYBA. 1990. Northwest Yacht Brokers Association. *Progress Report: The New Moon Project*. Seattle, Washington.
- Paulson, B.K., and S.L. Da Costa. 1991. A Case Study of Propeller-induced Currents and Sediments Transport in a Small Harbor. In *Proceedings of World Marina '91*, pp. 514-523. American Society of Civil Engineers, New York, NY.
- Penttila, D., and M. Aguero. 1978. *Fish Usage of Birch Bay Village Marina, Whatcom County, Washington, in 1978*. Washington Department of Fisheries Progress Report No. 39.
- Pisano, W.C., 1989. Swirl Concentrators Revisited. In *Design of Urban Runoff Quality Controls*. ed. L.A. Roesner, B. Urbonas, and M.B. Sonnen, pp. 390-402. American Society of Civil Engineers, New York, NY.
- Polis, D.D. 1974. *The Environmental Effects of Dredged Holes*. Present State of Knowledge. Report to Water Resources Administration. May.
- PSWQA. 1989. *Managing Nonpoint Pollution: An Action Plan Handbook for Puget Sound Watersheds*. Puget Sound Water Quality Authority, Seattle, WA.
- PSWQA. 1990. *1991 Puget Sound Water Quality Management Plan*. Puget Sound Water Quality Authority, Seattle, WA, pp. 160-165.
- Richards, W.R., J.E. Shwop, and R. Romano. 1981. Evaluation of Urban Stormwater Quality and Non-Structural Best Management Practices. In *Nonpoint Pollution Control: Tools and Techniques for the Future*, ed. K.C. Flynn, pp. 82-99. Interstate Commission on the Potomac River Basin, Rockville, MD.
- Romano, F. 1990. *Oil and Water Don't Mix: The Application of Oil-Water Separation Technologies in Stormwater Quality*. Office of Water Quality, Municipality of Metropolitan Seattle, Seattle, WA.
- Ross, N. 1985. Towards a Balanced Perspective...Boat Sewage. Presented at Thirteenth National Docks and Marinas Technical Conference, University of Wisconsin, Madison, WI.
- Sawyer, C.M., and A.F. Golding. 1990. *Marina Pollution Abatement*. International Marina Institute, Wickford, RI.

- SCCC. 1984. *Guidelines for Preparation of Coastal Marina Report*. South Carolina Coastal Council, Charleston, SC.
- SCDHEC. 1987. *Heavy metals and extractable organic chemicals from the Coastal Toxics Monitoring Network 1984-1986*. South Carolina Department of Health and Environmental Control, Technical Report No. 007-87.
- Schluchter, S.S., and L. Slotta. 1978. Flushing Studies of Marinas. In *Coastal Zone '78—Proceedings Symposium on Technical, Socioeconomic and Regulatory Aspects of Coastal Zone Management*, American Society of Civil Engineering, San Francisco, CA, March 1978.
- Seabloom, R.A., G. Plews, F. Cox, and F. Kramer. 1989. *The Effect of Sewage Discharges from Pleasure Craft on Puget Sound Waters and Shellfish Quality*. Washington State Department of Health Shellfish Section, Olympia, WA.
- Schlomann, H. 1992. Letter dated June 22, 1992, to Geoffrey Grubbs, Director, Assessment and Watershed Protection Division, U.S. Environmental Protection Agency, from Northwest Marine Trade Association, Seattle, WA.
- Schueler, T.R. 1987. *Controlling Urban Runoff: A Practice Manual for Planning and Designing Urban BMPs*. Metropolitan Washington Council of Governments, Washington, DC.
- Schueler, T.R., P.A. Kumble and M.A. Heraty. 1992. *A Current Assessment of Urban Best Management Practices*. Metropolitan Washington Council of Governments, Washington, DC.
- Shaver, E. 1991. Sand Filter Design for Water Quality Treatment. Presented at 1991 ASCE Stormwater Conference in Crested Butte, CO.
- Sherk, J.A. 1971. *Effects of Suspended and Deposited Sediments on Estuarine Organisms*. Chesapeake Biological Laboratory, University of Maryland. Contribution No. 443.
- Silverman, G.S., M.K. Stenstrom, and S. Fam. 1986. Best Management Practices for Controlling Oil and Grease in Urban Stormwater Runoff. *Environmental Professional*, 8:51-362.
- Silverman, G.S., and M.K. Stenstrom. 1989. Source Control of Oil and Grease in an Urban Area. In *Design of Urban Runoff Quality Controls*, ed. L.A. Roesner, B. Urbonas, and M.B. Sonnen, pp. 403-420. American Society of Civil Engineers, New York, NY.
- Smith, G.F., and H.H. Webber. 1978. *A Biological Sampling Program of Intertidal Habitats of Northern Puget Sound. Appendix K. W.W.U. Intertidal Study. Baseline Study Program North Puget Sound*, Washington Department of Ecology, Olympia.
- Smith, H.T., J. Phelps, R. Nathan, and D. Cannon. 1991. Avalon Harbor: Example of a Successful Destination Harbor. In *Proceedings of World Marina '91*, pp. 370-391. American Society of Civil Engineers, New York, NY.
- Smith, J.E. 1977. *A Baseline Study of Invertebrates and of the Environmental Impacts of Intertidal Log Rafting on the Snohomish River Delta*. Final report. Fisheries Research Institute, University of Washington, Seattle, WA.
- Sorensen, R.F. 1986. *Bank Protection for Vessel Generated Waves*. Report No. WES-IHL-117-86, Lehigh University, Bethlehem, PA.
- Soule, D.F., M. Oguri, and B.H. Jones. 1991. *The Marine Environment of Marina Del Rey: October 1989 to September 1990*. Marine Studies of San Pedro Bay, California, Part 20F. University of Southern California, Los Angeles, CA.

- Souza, S.J., R.L. Conner, B.I. Krinsky, and J.A. Tiedemann. 1990. *Compatibility of Coastal Development and Coastal Resources, Port Liberte: A Case Study*.
- Stallard, M., V. Hodge, and E.D. Goldberg. 1987. TBT in California Coastal Waters: Monitoring and Assessment. *Environmental Monitoring and Assessment*, 9:195-220. D. Reidel Publishing Company.
- Stephenson, M.D., D.R. Smith, J. Goetzl, G. Ichikawa, and M. Martin. 1986. Growth Abnormalities in Mussels and Oysters from Areas With High Levels of Tributyltin in San Diego Bay. In *Proceedings Oceans 86, Volume 4 Organotin Symposium*, pp. 1246-1251. Institute of Electrical and Electronics Engineers, Inc., New York, NY.
- SWRPC. 1991. *Costs of Urban Nonpoint Source Water Pollution Control Measures*. Prepared by the Southeastern Wisconsin Regional Planning Commission, Waukesha, Wisconsin. Technical Report No. 31. June.
- Tanski, J. 1989. Boater Use of Pumpout Facilities in Suffolk County, Long Island, New York. In *Proceedings of the 1989 National Marina Research Conference*, International Marina Institute, Wickford, RI, pp. 173-191.
- Tetra Tech. 1988. *Rive St. Johns Phase II Canal System Water Quality Model Study*. Prepared for Dotsie Builders, Inc., Jacksonville, FL. Tetra Tech Report TC-3668-04.
- Thomann, R.V., and J.A. Mueller. 1987. *Principles of Surface Water Quality Modeling and Control*. Harper & Row, New York.
- Tiedemann, J.A. 1989. *Pump It or Dump It? An Analysis of the Sewage Pumpout Situation in the New Jersey Coastal Zone*. International Marina Institute, Wickford, RI.
- Tobiasson, B.O., and R.C. Kollmeyer. 1991. *Marinas and Small Craft Harbors*. Van Nostrand Reinhold, New York, NY.
- Tsinker, G.P. 1992. Small Craft Marinas. In *Handbook of Coastal and Ocean Engineering: Vol. 3, Harbors, Navigational Channels, Estuaries, Environmental Effects*, ed. J.B. Herbich, pp. 1115-1167. Gulf Publishing, Houston, TX.
- Tull, L. 1990. *Cost of Sedimentation/Filtration Basins*. City of Austin, TX.
- USACE. 1984. *Shore Protection Manual*. 4th ed. U.S. Army Corps of Engineers, Waterways Experiment Station, Coastal Engineering Research Center.
- USCG. 1990. *American Red Cross National Boating Survey: A Study of Recreational Boats, Boaters, and Accidents in the United States*. U.S. Department of Transportation, U.S. Coast Guard, Washington, DC.
- USEPA. 1974. *Assessing Effects on Water Quality by Boating Activity*. U.S. Environmental Protection Agency, National Environmental Research Center, Cincinnati, OH.
- USEPA. 1976. *Impacts of Construction Activities in Wetland of the United States*. U.S. Environmental Protection Agency. EPA/600/3-76-045.
- USEPA. 1982. *Design Manual: Swirl and Helical Bend Pollution Control Devices*. U.S. Environmental Protection Agency, Washington, DC. EPA-600/8-82-013.
- USEPA. 1985a. *Coastal Marinas Assessment Handbook*. U.S. Environmental Protection Agency, Region 4, Atlanta, GA. April.
- USEPA. 1985b. *Water Quality Assessment: A Screening Procedure for Toxic and Conventional Pollutants*. U.S. Environmental Protection Agency, Athens, GA. EPA/600/6-85/002a,b.

- USEPA. 1986. *Wexford Locked Harbor, April 1986 and September 1986*. U.S. Environmental Protection Agency, Region 4, Environmental Services Division, Marine and Wetlands Unit, Athens, GA.
- USEPA. 1988. *Bacteria: Water Quality Standards Criteria Summaries: A Compilation of State/Federal Criteria*. U.S. Environmental Protection Agency, Office of Water, Washington, DC. EPA/440/5-88/007.
- USEPA. 1989. *Rapid Bioassessment Protocols for Use in Streams and Rivers: Benthic Macroinvertebrates and Fish*. U.S. Environmental Protection Agency, Office of Water, Washington, DC. EPA/444/4-89-001.
- USEPA. 1990. U.S. Environmental Protection Agency, Office of Water Enforcement and Permits. National Pollutant Discharge Elimination System Permit Application Regulations for Storm Water Discharges; Final Rule. *Federal Register*, November 16, 1990, 55:48066.
- USEPA. 1991a. *Proposed Guidance Specifying Management Measures for Sources of Nonpoint Pollution in Coastal Waters*. U.S. Environmental Protection Agency, Office of Water, Washington, DC.
- USEPA. 1991b. *Draft EPA Region I No-Discharge Area Policy*. U.S. Environmental Protection Agency, Region 1, Boston, MA.
- USEPA. 1992a. *Development of Estuarine Community Bioassessment Protocols*. Issue Paper for Work Group Meeting January 8 and 9, 1992. U.S. Environmental Protection Agency, Washington, DC.
- USEPA. 1992b. *Draft Interim Report: Environmental Assessment for Siting and Design of Marinas*. Submitted to U.S. Environmental Protection Agency, Nonpoint Source Control Branch, Washington, DC, by Tetra Tech, Inc.
- USEPA. 1992c. *Final Report on Marina Water Quality Models*. Submitted to U.S. Environmental Protection Agency, Region 4, Atlanta, GA, by Tetra Tech, Inc.
- USEPA. 1992d. *Coastal Marina Water Quality Assessment Using Tidal Prism Analysis User's Manual*. Submitted to U.S. Environmental Protection Agency, Region 4, Atlanta, GA, by Tetra Tech, Inc.
- USFWS. 1982. *Mitigation and Enhancement Techniques for the Upper Mississippi River System and Other Large River Systems*. U.S. Department of the Interior, U.S. Fish and Wildlife Service. Resource Publication 149.
- Voudrias, E.A., and C.L. Smith. 1986. Hydrocarbon Pollution from Marinas in Estuarine Sediments. In *Estuarine, Coastal and Shelf Science*, vol. 22, pp. 271-284. Academic Press Inc., London, England.
- WADOE. 1991. *Stormwater Management Manual for the Puget Sound Basin*. Washington State Department of Ecology, Olympia, WA. Publication No. 90-73.
- Walton, R. 1983. *Computer Modeling of Hydrodynamics and Solute Transport in Canals and Marinas: A Literature Review and Guidelines for Future Development*. Prepared for the U.S Army Engineer Waterways Experiment Station, Vicksburg, MS, by Camp Dresser and McKee, Annandale, VA. Miscellaneous paper EL-83-5.
- Wanielista, M.P., and Y.A. Yousef. 1986. Best Management Practices Overview. In *Urban Runoff Quality—Impact and Quality Enhancement Technology*, proceedings of an Engineering Foundation Conference, American Society of Civil Engineers, New York, NY, pp. 314-322.
- WDF. 1971. *Criteria Governing the Design of Bulkheads in Puget Sound, Hood Canal, and Strait of Juan de Fuca for Protection of Fish and Shellfish Resources*. Washington State Department of Fisheries, Seattle, WA.
- WDF. 1974. *Bulkhead Criteria for Surf Smelt (Hypomesus pretiosus) Spawning Beaches in Puget Sound, Hood Canal, and Strait of Juan de Fuca, San Juan Islands, and the Strait of Georgia*. Washington State Department of Fisheries, Seattle, WA.

- Wendt, P.H., R.F. Van Dolah, M.Y. Bobo, and J.J. Manzi. 1990. The Effects of a Marina on Certain Aspects of the Biology of Oysters and Other Benthic Macrofauna in a South Carolina Estuary. Unpublished draft manuscript. South Carolina Department of Health and Environmental Control, Columbia, SC.
- White, D.G., J.M. Regenstein, T. Richard, and S. Goldhor. 1989. *Composting Salmonid Fish Waste: a Waste Disposal Alternative*. New York Sea Grant Extension Program and Cornell University. NYEXT-G-89-001 C3. December.
- Woodward-Clyde Federal Services. 1991. *Urban BMP Cost and Effectiveness: Summary Data for 6217 (G) Guidance*.
- WPCF. 1989. *Combined Sewer Overflow Pollution Abatement*. Manual of Practice No. FD-17. Water Pollution Control Federation, Alexandria, VA.
- Young, D.R., G.V. Alexander, and D. McDermott-Ehrlich. 1979. Vessel-related Contamination of Southern California Harbors by Copper and other Metals. *Marine Pollution Bulletin* 10:50-56.
- Young, D.R., T.C. Heesen, D.J. McDermott, and P.E. Smokler. 1974. *Marine Inputs of Polychlorinated Biphenyls and Copper from Vessel Antifouling Paints*. Southern California Coastal Water Research Project, El Segundo, CA.
- Zabawa, C., and C. Ostrom. 1980. *Final Report on the Role of Boat Wakes in Shore Erosion in Anne Arundel County, Maryland*. Tidewater Administration, Maryland Department of Natural Resources, Annapolis, MD.

Appendix 5A

Summary of Coastal States Marina Programs

APPENDIX 5A: SUMMARY OF COASTAL STATES MARINA PROGRAMS

STATE	Marina water quality (WQ) study required	Critical habitat assessment required prior to marina siting	Stormwater runoff regulations included in the State code for marinas	Pumpouts mandated? Enforced? How many units? Criteria	Authority for over-site of expansions*	Boat maintenance materials handling	Public education programs for boaters	Speed zones or no-wake zones for erosion
AL	Only where marinas basins are constructed out of upland.	Yes	No	Yes for new or expanding marinas	Dept. of Env. Mgmt. reviews	No	Yes, but minimal	Only for safety purposes
AK	No; just a USACE permit and local ordinances	Yes; very important for commercial fish species	No	No	Yes	No	No, but Coast Guard has pollution prevention program	Yes
CA	Yes; the CA Envir. Quality Act, similar to NEPA, is implemented on a regional level	Under the CA Coastal Act; Env. Impact Report written	At the local level; not at the State level	Water Resources Ctrl Board; yes, at least one pump-out facility in marina	CA Envir. Quality Act; must perform EIR, handled at the local level	Encouraged	Yes; very extensive, Dept. of Boating and Waterways	Local jurisdictions provide local control
CT	Yes for large projects or if circulation may be affected	Yes; developers are given guidance	Yes for new and expanding but not small marinas	Yes	Encouraged	Yes	Yes	Only for safety purposes

*The U.S. Army Corps of Engineers reviews all construction activity in navigable waters.

APPENDIX 5A: SUMMARY OF COASTAL STATES MARINA PROGRAMS, Continued

STATE	Marina water quality (WQ) study required	Critical habitat assessment required prior to marina siting	Stormwater runoff regulations included in the State code for marinas	Pumpouts mandated? Enforced? How many units? Criteria	Authority for oversight of expansions*	Boat maintenance materials handling	Public education programs for boaters	Speed zones or no-wake zones for erosion
DE	Yes for new marinas	Yes for new marinas and expansions	Yes	> 100 slips must have pumpout; < 25 not required; 25-100 allowed to share	Yes	BMPs required	Yes	Yes
FL	Yes	Yes	Yes for new development, not marina-specific	Yes for new marinas	Yes	Minimal	Yes	Yes
GA	No unless problem is found	Yes for shellfish	Yes only for dry stack storage	Yes	Yes	Yes	No; trade association does this	Yes
HA	Yes	Yes	No	No	Yes if expansion is part of a new plan	No	Yes	Only for safety purposes
ME	No	Sometimes	No	Yes	Yes	Yes	Yes	No

*The U.S. Army Corps of Engineers reviews all construction activity in navigable waters.

APPENDIX 5A: SUMMARY OF COASTAL STATES MARINA PROGRAMS, Continued

EPA-840-B-92-002 January 1993

5-79

STATE	Marina water quality (WQ) study required	Critical habitat assessment required prior to marina siting	Stormwater runoff regulations included in the State code for marinas	Pumpouts mandated? Enforced? How many units? Criteria	Authority for over-site of expansions*	Boat maintenance materials handling	Public education programs for boaters	Speed zones or no-wake zones for erosion
MD	Yes in some cases; monitoring may be required	Sometimes	Yes for new development, not marina-specific	Yes	Yes	Encouraged	Yes	Yes
MA	Yes in some cases	Sometimes	No	Yes	Yes	Yes	Yes	Only for safety purposes
MI	No	Yes	No	Yes	Yes	Encouraged	No	Yes at local level
MS	Yes in some cases	Sometimes	No	Yes	Yes	No	Yes	Yes
NH	No	No	Yes, treated the same as other development	Yes	Yes	No	No	Yes
NJ	Yes	Yes	Yes, treated the same as other development	Yes for > 25 slips	Yes	Yes	Yes	Only for safety purposes

*The U.S. Army Corps of Engineers reviews all construction activity in navigable waters.

APPENDIX 5A: SUMMARY OF COASTAL STATES MARINA PROGRAMS, Continued

STATE	Marina water quality (WQ) study required	Critical habitat assessment required prior to marina siting	Stormwater runoff regulations included in the State code for marinas	Pumpouts mandated? Enforced? How many units? Criteria	Authority for oversight of expansions*	Boat maintenance materials handling	Public education programs for boaters	Speed zones or no-wake zones for erosion
NY	No	Sometimes	Yes, treated the same as other development	No, except on case-by-case permit condition	Yes	Yes	Yes	Yes; no-wake at local level
NC	Yes	Yes	Yes, treated the same as other development	Yes for > 25 slips	Yes for > 20% increase	Yes	Yes	Only for safety purposes
OR	Not required at the state level	Encouraged by U.S. Fish and Wildlife Service	Yes, treated the same as other development	Yes; have no-discharge zones already	Yes	Not mandatory; very common to see liquid waste receptacles	Yes, by the Oregon State Marine Board	Yes
RI	Yes in degraded water	Yes	Yes	Yes; at least 1 pumpout for every 500 vessels over 25 feet	Yes	Yes	Yes	Yes
SC	Yes	Sometimes	Yes	Yes for new and expanding	Yes	Yes	Yes	Yes

*The U.S. Army Corps of Engineers reviews all construction activity in navigable waters.

APPENDIX 5A: SUMMARY OF COASTAL STATES MARINA PROGRAMS, Continued

STATE	Marina water quality (WQ) study required	Critical habitat assessment required prior to marina siting	Stormwater runoff regulations included in the State code for marinas	Pumpouts mandated? Enforced? How many units? Criteria	Authority for over-site of expansions ^a	Boat maintenance materials handling	Public education programs for boaters	Speed zones or no-wake zones for erosion
TX	No	No	No	No	Not available	No	No	Addressed at local level
VA	Yes	Yes	Yes, treated the same as other development	Yes for new and expanding	Yes	No	Yes	Addressed at local level
WA	Required by some local governments; as required for general NPDES permitting for boatyards	Yes	Yes	No, but could be imposed at the local level	Requires approval by the WA Department of Ecology	Yes	Yes	Yes

^aThe U.S. Army Corps of Engineers reviews all construction activity in navigable waters.

CHAPTER 6: Management Measures for Hydromodification: Channelization and Channel Modification, Dams, and Streambank and Shoreline Erosion

I. INTRODUCTION

A. What "Management Measures" Are

This chapter specifies management measures to protect coastal waters from sources of nonpoint pollution related to hydromodification activities. "Management measures" are defined in section 6217 of the Coastal Zone Act Reauthorization Amendments of 1990 (CZARA) as economically achievable measures to control the addition of pollutants to our coastal waters, which reflect the greatest degree of pollutant reduction achievable through the application of the best available nonpoint pollution control practices, technologies, processes, siting criteria, operating methods, or other alternatives.

These management measures will be incorporated by States into their coastal nonpoint programs, which under CZARA are to provide for the implementation of management measures that are "in conformity" with this guidance. Under CZARA, States are subject to a number of requirements as they develop and implement their Coastal Nonpoint Pollution Control Programs in conformity with this guidance and will have some flexibility in doing so. The application of these management measures by States to activities causing nonpoint pollution is described more fully in *Coastal Nonpoint Pollution Control Program: Program Development and Approval Guidance*, published jointly by the U.S. Environmental Protection Agency (EPA) and the National Oceanic and Atmospheric Administration (NOAA).

B. What "Management Practices" Are

In addition to specifying management *measures*, this chapter also lists and describes management *practices* for illustrative purposes only. While State programs are required to specify management *measures* in conformity with this guidance, State programs need not specify or require the implementation of the particular management *practices* described in this document. However, as a practical matter, EPA anticipates that the management measures generally will be implemented by applying one or more management practices appropriate to the source, location, and climate. The practices listed in this document have been found by EPA to be representative of the types of practices that can be applied successfully to achieve the management measures. EPA has also used some of these practices, or appropriate combinations of these practices, as a basis for estimating the effectiveness, costs, and economic impacts of achieving the management measures. (Economic impacts of the management measures are addressed in a separate document entitled *Economic Impacts of EPA Guidance Specifying Management Measures for Sources of Nonpoint Pollution in Coastal Waters*.)

EPA recognizes that there is often site-specific, regional, and national variability in the selection of appropriate practices, as well as in the design constraints and pollution control effectiveness of practices. The list of practices for each management measure is not all-inclusive and does not preclude States or local agencies from using other technically sound practices. In all cases, however, the practice or set of practices chosen by a State needs to achieve the management measure.

C. Scope of This Chapter

This chapter addresses three categories of sources of nonpoint pollution from hydromodification activities that affect coastal waters:

- (1) Channelization and channel modification;
- (2) Dams; and
- (3) Streambank and shoreline erosion.

Each category of management measures is addressed in a separate section of this guidance. Each section contains (1) the management measure; (2) an applicability statement that describes, when appropriate, specific activities and locations for which the measure is suitable; (3) a description of the management measure's purpose; (4) the basis for the management measure's selection; (5) information on management practices that are suitable, either alone or in combination with other practices, to achieve the management measure; (6) information on the effectiveness of the management measure and/or of practices to achieve the measure; and (7) information on costs of the measure and/or practices to achieve the measure.

D. Relationship of This Chapter to Other Chapters and to Other EPA Documents

1. Chapter 1 of this document contains detailed information on the legislative background for this guidance, the process used by EPA to develop this guidance, and the technical approach used by EPA in the guidance.
2. Chapter 7 of this document contains management measures to protect wetlands and riparian areas that serve an NPS pollution abatement function. These measures apply to a broad variety of sources, including sources related to hydromodification activities.
3. Chapter 8 of this document contains information on recommended monitoring techniques to (1) ensure proper implementation, operation, and maintenance of the management measures and (2) assess over time the success of the measures in reducing pollution loads and improving surface water quality.
4. EPA has separately published a document entitled *Economic Impacts of EPA Guidance Specifying Management Measures for Sources of Nonpoint Pollution in Coastal Waters*.
5. NOAA and EPA have jointly published guidance entitled *Coastal Nonpoint Pollution Control Program: Program Development and Approval Guidance*. This guidance contains details on how State Coastal Nonpoint Pollution Control Programs are to be developed by States and approved by NOAA and EPA. It includes guidance on the following:
 - The basis and process for EPA/NOAA approval of State Coastal Nonpoint Pollution Control Programs;
 - How NOAA and EPA expect State programs to provide for the implementation of management measures "in conformity" with this management measures guidance;
 - How States may target sources in implementing their Coastal Nonpoint Pollution Control Programs;
 - Changes in State coastal boundaries; and
 - Requirements concerning how States are to implement the Coastal Nonpoint Pollution Control Programs.

II. CHANNELIZATION AND CHANNEL MODIFICATION MANAGEMENT MEASURES

One form of hydromodification is *channelization* or *channel modification*. These terms (used interchangeably) describe river and stream channel engineering undertaken for the purpose of flood control, navigation, drainage improvement, and reduction of channel migration potential (Brookes, 1990). Activities such as straightening, widening, deepening, or relocating existing stream channels and clearing or snagging operations fall into this category. These forms of hydromodification typically result in more uniform channel cross sections, steeper stream gradients, and reduced average pool depths.

The terms *channelization* and *channel modification* are also used in this chapter to refer to the excavation of borrow pits, canals, underwater mining, or other practices that change the depth, width, or location of waterways or embayments in coastal areas. Excavation of marina basins is addressed separately in Chapter 5 of this guidance.

The term *flow alteration* describes a category of hydromodification activities that result in either an increase or a decrease in the usual supply of fresh water to a stream, river, or estuary. Flow alterations include diversions, withdrawals, and impoundments. In rivers and streams, flow alteration can also result from undersized culverts, transportation embankments, tide gates, sluice gates, and weirs.

Levees along a stream or river channel are also addressed by this section. A *levee* is defined by the U.S. Army Corps of Engineers (USACE) as an embankment or shaped mound for flood control or hurricane protection (USACE, 1981). Pond banks, and other small impoundment structures, often referred to as levees in the literature, are not considered to be levees as defined in this section. Additionally, a *dike* is not used in this guidance to refer to the same structure as a levee, but rather is defined as a channel stabilization structure sited in a river or stream perpendicular to the bank.

For the purpose of this guidance, no distinction will be made between the terms *river* and *stream* because no definition of either could be found to quantitatively distinguish between the two. Likewise, no distinction will be made for word combinations of these two terms; for example, *streambank* and *riverbank* will be considered to be synonymous.

The following definitions for common terms associated with channelization activities apply to this chapter (USACE, 1983). Other definitions are provided in the Glossary at the end of the chapter.

Channel: A natural or constructed waterway that continuously or periodically passes water.

Channel stabilization: Structures placed below the elevation of the average surface water level (lower bank) to control bank erosion or to prevent bank or channel failure.

Streambank: The side slopes of a channel between which the streamflow is normally confined.

Lower bank: The portion of the streambank below the elevation of the average water level of the stream.

Upper bank: The portion of the streambank above the elevation of the average water level of the stream.

Streambank stabilization: Structures placed on or near a distressed streambank to control bank erosion or to prevent bank failure.

Based on the above definitions, the difference between channel stabilization and streambank stabilization is that in streambank stabilization, the upper bank is also protected from erosion or failure. This additional protection guards against erosive forces caused by high-water events and by land-based causes such as runoff or improper siting of

buildings. Levees are placed along streambanks to prevent flooding in adjacent areas during extreme high-water events.

Effects of Channelization and Channel Modification Activities

General Problematic Effects

Channel modification activities have deprived wetlands and estuarine shorelines of enriching sediments, changed the ability of natural systems to both absorb hydraulic energy and filter pollutants from surface waters, and caused interruptions in the different life stages of aquatic organisms (Sherwood et al., 1990). Channel modification activities can also alter instream water temperature and sediment characteristics, as well as the rates and paths of sediment erosion, transport, and deposition. A frequent result of channelization and channel modification activities is a diminished suitability of instream and riparian habitat for fish and wildlife. Hardening of banks along waterways has eliminated instream and riparian habitat, decreased the quantity of organic matter entering aquatic systems, and increased the movement of NPS pollutants from the upper reaches of watersheds into coastal waters.

Channel modification projects undertaken in streams or rivers to straighten, enlarge, or relocate the channel usually require regularly scheduled maintenance activities to preserve and maintain completed projects. These maintenance activities may also result in a continual disturbance of instream and riparian habitat. In some cases, there can be substantial displacement of instream habitat due to the magnitude of the changes in surface water quality, morphology and composition of the channel, stream hydraulics, and hydrology.

Excavation projects can result in reduced flushing, lowered dissolved oxygen levels, saltwater intrusion, loss of streamside vegetation, accelerated discharge of pollutants, and changed physical and chemical characteristics of bottom sediments in surface waters surrounding channelization or channel modification projects. Reduced flushing, in particular, can increase the deposition of finer-grained sediments and associated organic materials or other pollutants.

Levees may reduce overbank flooding and the subsequent deposition of sediment needed to nourish riverine and estuarine wetlands and riparian areas. Levees can cause increased transport of suspended sediment to coastal and near-coastal waters during high-flow events. Levees located close to streambanks can also prevent the lateral movement of sediment-laden waters into adjacent wetlands and riparian areas that would otherwise serve as depositories for sediment, nutrients, and other NPS pollutants. This has been a major factor, for example, in the rapid loss of coastal wetlands in Louisiana (Hynson et al., 1985). Levees also interrupt natural drainage from upland slopes and can cause concentrated, erosive flows of surface waters.

The resulting changes to the distribution, amount, and timing of flows caused by flow alterations can affect a wide variety of living resources. Where tidal flow restrictors cause impoundments, there may be a loss of streamside vegetation, disruption of riparian habitat, changes in the historic plant and animal communities, and decline in sediment quality. Restricted flows can impede the movement of fish or crustaceans. Flow alteration can reduce the level of tidal flushing and the exchange rate for surface waters within coastal embayments, with resulting impacts on the quality of surface waters and on the rates and paths of sediment transport and deposition.

Specific Effects

Depending on preproject site conditions and the extent of hydromodification activity, new and existing channelization and channel modification projects may result in no additional NPS problems, additional NPS problems, or benefits.

The following are major categories of channelization and channel modification effects and examples of associated problems and benefits.

Changed Sediment Supply. One of the more significant changes in instream habitat associated with channelization and channel modification projects is in sediment supply and delivery. Streamside levees have been linked to

accelerated rates of erosion and decreased sediment supplies to coastal areas (Hynson et al., 1985). Sherwood and others (1990) evaluated the long-term impacts of channelization projects on the Columbia River estuary and found that changes to the river system resulted in a net increase of 68 million cubic meters of sediment in the estuary. These changes in sediment supply can include problems such as increased sedimentation to some areas (an estuary, for example) or decreased sediment to other areas (such as streamside wetlands or estuarine marshes). Other changes may be beneficial; for example, a diversion that delivers sediment to eroding marshes (Hynson et al., 1985). Another example of a beneficial channel stabilization project might be one that results in increased flushing and the elimination of unwanted sediment in the spawning area of a stream.

Reduced Freshwater Availability. Salinity above threshold levels is considered to be a form of NPS pollution in freshwater supplies. Reduced freshwater availability for municipal, industrial, or agricultural purposes can result from some channelization and channel modification practices. Similarly, alteration of the salinity regime in portions of a channel can result in ecological changes in vegetation in the streamside area. Diversion of fresh water by flood- and hurricane-protection levees has reduced freshwater inputs to adjacent marshes. This has resulted in increased marsh salinities and degradation of the marsh ecosystem (Hynson et al., 1985). A benefit of other diversion projects was a reduction of freshwater inputs to estuarine areas that were becoming too fresh because of overall increases in fresh water from changes in land use within a watershed. Increases in oyster harvests have been attributed to a freshwater diversion in Plaquemines Parish, Louisiana. Over the 6-year period from 1970 to 1976, oyster harvests increased by over 3.5 million pounds (Hynson et al., 1985). Potential problems with diversions include erosion, settlement, seepage, and liquefaction failure (Hynson et al., 1985).

Accelerated Delivery of Pollutants. Channelization and channel modification projects can lead to an increased quantity of pollutants and accelerated rate of delivery of pollutants to downstream sites. Alterations that increase the velocity of surface water or that increase flushing of the streambed can lead to more pollutants being transported to downstream areas at possibly faster rates. Urbanization has been linked to downstream channelization problems in Hawaii (Anderson, 1992). It is believed that the deterioration of Kaneohe Bay may be caused by development within the watershed, which has increased runoff flows to streams entering the Bay. Streams that once meandered and contained natural vegetation to filter out nutrient and sediment are now channelized and contain surface water that is rich in nutrients and other pollutants associated with urban areas (Anderson, 1992). Some excavation projects have resulted in poor surface water circulation along with increased sedimentation and other surface water quality problems within the excavated basin. In some of these cases, additional, carefully designed channel modifications can increase flushing rates, which deliver accumulated pollutants from the basin to points downstream that are able to assimilate or otherwise beneficially use the accumulated materials.

Loss of Contact with Overbank Areas. Instream hydraulic changes can decrease or interfere with surface water contact to overbank areas during floods or other high-water events. Channelization and channel modification activities that lead to a loss of surface water contact in overbank areas also may result in reduced filtering of NPS pollutants by streamside area vegetation and soils. Areas of the overbank that are dependent on surface water contact (i.e., riparian areas and wetlands) may change in character and function as the frequency and duration of flooding change. Erickson and others (1979) reported a major influence on wetland drainage in the Wild Rice Creek Watershed in North and South Dakota. Drainage rates from streamside areas were 2.6 times higher in the channelized area than in undisturbed areas during preliminary project activities and 5.3 times higher following construction. Schoof (1980) reported several other impacts of channelization, including drainage of wetlands, reduction of oxbows and stream meander, clearing of floodplain hardwood, lowering of ground-water levels, and increased erosion. Channel modification projects such as setback levees or compound channel design can provide the overbank flooding to areas needing it while also providing a desired level of flood protection to adjoining lands.

Changes to Ecosystems. Channelization and channel modification activities can lead to loss of instream and riparian habitat and ecosystem benefits such as pathways for wildlife migration and conditions suitable for reproduction and growth. Problematic flow modifications, for example, have resulted in reversal of flow regimes of some California rivers or streams, which has led to the disorientation of anadromous fish that rely on flow to direct them to spawning areas (James and Stokes Associates, Inc., 1976). Eroded sediment may deposit in new areas, covering benthic communities or altering instream habitat (Sherwood et al., 1990). Orlova and Popova (1976) researched the effects

on fish population resulting from altering the hydrologic regime with hydraulic structures such as channels. The effects assessed by Orlova and Popova (1976) include:

- Deterioration of spawning habitat and conditions, resulting in lower recruitment of river species;
- Increases in stocks of summer spawning river species; and
- Changes in types and amounts of food organisms.

Many channel or streambank stabilization structures provide increased instream habitat for certain aquatic species. For example, Sandheinrich and Atchison (1986) reported increases in densities of epibenthic insects within revetments and stone dike areas and more suitable substrate for bottom-dwelling insects in revetment areas.

Instream and Riparian Habitat Altered by Secondary Effects. Secondary instream and riparian habitat alteration effects from channelization and channel modification projects include movement of estuarine turbidity maximum zones (zone of higher sediment concentrations caused by salinity and tide-induced circulation) with salinity changes, cultural eutrophication caused by inadequate flushing, and trapping of large quantities of sediment. Wolff and others (1989) analyzed the impacts of flow augmentation on the stream channel and instream habitat following a transbasin water diversion project in Wyoming. The South Fork of Middle Crow Creek, previously ephemeral, was beneficially used as a conveyance to create instream habitat as a part of impact management measures of the transbasin diversion project. Discontinuous channels, high summer water temperature, and flow interruptions and fluctuations were identified as potential limiting factors for the development of such practices for this particular project. Modeling results, however, indicated that as the channel develops, the effects of the first two limiting factors will be negligible. Following 2 years of increased flow in the 5.5-mile section of stream channel (reach) used in this study, the volume of stream channel had increased 32 percent and more channel areas were expected to develop on approximately 67 percent of the stream reach. The total area of beaver ponds had more than doubled. The brook trout with which the beaver ponds were stocked were reported to be surviving and growing.

The examples described above illustrate the range of possible effects that can result from channelization and channel modification projects. These effects can be either beneficial or problematic to the ecology and surrounding riparian habitat. The effects caused by changed sediment supplies provide an excellent example of these varying impacts. In one case, sediment supplies to coastal marshes are insufficient and the marshes are subsiding (problem). In another case, sediment supplies to an estuary are increasing to the point of causing changes to the natural tidal flow (problem). A final example showed decreased sediment in a streambed, which has resulted in better conditions for native spawning fish (benefit). Thus, depending on site-specific conditions and the particular channelization or channel modification practices used, the project will have positive or negative NPS pollution impacts.

Another confounding factor is the potential for one project to have multiple NPS problems and/or benefits. Assuming that a channelization or channel modification project was originally designed to overcome a specific problem (e.g., channel deepening for navigation, streambank stabilization for erosion control, or levee construction for flood control), the project was intended to be beneficial. Unfortunately, planners of many channelization and channel modification projects have, in the past, been myopic when considering the range of impacts associated with the project. The purpose of the management measures in this section is to recommend proper evaluation of potential projects and reevaluation of existing projects to reduce NPS impacts and maximize potential benefits.

Proper evaluation of channelization and channel modification projects should consider three major points.

- (1) **Existing conditions.** New and existing channelization and channel modification projects should be evaluated for potential effects (both problematic and beneficial) based on existing stream and watershed conditions. Site-specific stream conditions, such as flow rate, channel dimensions, typical surface water quality, or slope, should be evaluated in conjunction with streamside conditions, such as soil and vegetation type, slopes, or land use. Characteristics of the watershed also need to be evaluated. This phase of the evaluation will identify baseline conditions for potential projects and can be compared to historical conditions for projects already in place.

- (2) **Potential conditions.** Anticipated changes to the base (or existing) conditions in a stream, along the streambank, and within the watershed should be evaluated. By examining potential changes caused by new conditions, long-term impacts can be factored into the design or management of a channelization or channel modification project. Studies like that of Sandheinrich and Atchison (1986) clearly show that short-term benefits from hydromodification activities can change to long-term problems.
- (3) **Watershed management.** Evaluation of changes in watershed conditions is paramount in the proper design of a channelization or channel modification project. Since the design of these projects is based on hydrology, changes in watershed hydrology will certainly impact the proper functioning of a channelization or channel modification structure. Additionally, many surface water quality changes associated with a channelization or channel modification project can be attributed to watershed changes, such as different land use, agricultural practices, or forestry practices.

The two management measures presented in this section of the chapter promote the evaluation of channelization and channel modification projects. Channels should be evaluated as a part of the watershed planning and design processes, including watershed changes from new development in urban areas, agricultural drainage, or forest clearing. The purpose of the evaluation is to determine whether resulting NPS changes to surface water quality or instream and riparian habitat can be expected and whether these changes will be good or bad.

Existing channelization and channel modification projects can be evaluated to determine the NPS impacts and benefits associated with the projects. Modifications to existing projects, including operation and maintenance or management, can also be evaluated to determine the possibility of improving some or all of the impacts without changing the existing benefits or creating additional problems.

In both new and existing channelization and channel modification projects, evaluation of benefits and/or problems will be site-specific. Mathematical models are one type of tool used to determine these impacts. Some models provide a simple analysis of a particular situation and are good for screening purposes. Other models evaluate complex interactions of many variables and can be powerful, site-specific evaluation tools. There are also structural and nonstructural practices that can be used to prevent either NPS pollution effects from or NPS impacts to channelization and channel modification projects. Interpretation of design changes, model results predicting changes or impacts, or the effects of structural or nonstructural practices requires sound biological and engineering judgment and experience.

The first three problems listed above are usually associated with the alteration of physical characteristics of surface waters. Accordingly, they are addressed by Management Measure II.A in the section below. The last three problems listed above can be grouped to represent problems resulting from modification of instream and riparian habitat. They are addressed by Management Measure II.B in the subsequent section below.

A. Management Measure for Physical and Chemical Characteristics of Surface Waters

- (1) Evaluate the potential effects of proposed channelization and channel modification on the physical and chemical characteristics of surface waters in coastal areas;**
- (2) Plan and design channelization and channel modification to reduce undesirable impacts; and**
- (3) Develop an operation and maintenance program for existing modified channels that includes identification and implementation of opportunities to improve physical and chemical characteristics of surface waters in those channels.**

1. Applicability

This management measure is intended to be applied by States to public and private channelization and channel modification activities in order to prevent the degradation of physical and chemical characteristics of surface waters from such activities. This management measure applies to any proposed channelization or channel modification projects, including levees, to evaluate potential changes in surface water characteristics, as well as to existing modified channels that can be targeted for opportunities to improve the surface water characteristics necessary to support desired fish and wildlife. Under the Coastal Zone Act Reauthorization Amendments of 1990, States are subject to a number of requirements as they develop coastal NPS programs in conformity with management measures and will have some flexibility in doing so. The application of this management measure by States is described more fully in *Coastal Nonpoint Pollution Control Program: Program Development and Approval Guidance*, published jointly by the U.S. Environmental Protection Agency (EPA) and the National Oceanic and Atmospheric Administration (NOAA) of the U.S. Department of Commerce.

2. Description

The purpose of this management measure is to ensure that the planning process for new hydromodification projects addresses changes to physical and chemical characteristics of surface waters that may occur as a result of the proposed work. Implementation of this management measure is intended to occur concurrently with the implementation of Management Measure B (Instream and Riparian Habitat Restoration) of this section. For existing projects, the purpose of this management measure is to ensure that the operation and maintenance program uses any opportunities available to improve the physical and chemical characteristics of the surface waters. Changes created by channelization and channel modification activities are problematic if they unexpectedly alter environmental parameters to levels outside normal or desired ranges. The physical and chemical characteristics of surface waters that may be influenced by channelization and channel modification include sediment, turbidity, salinity, temperature, nutrients, dissolved oxygen, oxygen demand, and contaminants.

Implementation of this management measure in the planning process for new projects will require a two-pronged approach:

- (1) Evaluate, with numerical models for some situations, the types of NPS pollution related to instream changes and watershed development.
- (2) Address some types of NPS problems stemming from instream changes or watershed development with a combination of nonstructural and structural practices.

The best available technology that can be applied to examine the physical and chemical effects of hydraulic and hydrologic changes to streams, rivers, or other surface water systems are models and past experience in situations similar to those described in the case studies discussed in this chapter. These models, discussed in detail under the practices of this section, can simulate many of the complex physical, chemical, and biological interactions that occur when hydraulic changes are imposed on surface water systems. Additionally, models can be used to determine a combination of practices to mitigate the unavoidable effects that occur even when a project is properly planned. Models, however, cannot be used independently of expert judgment gained through past experience. When properly applied models are used in conjunction with expert judgment, the effects of channelization and channel modification projects (both potential and existing projects) can be evaluated and many undesirable effects prevented or eliminated.

In cases where existing channelization or channel modification projects can be changed to enhance instream or streamside characteristics, several practices can be included as a part of regular operation and maintenance programs. New channelization and channel modification projects that cause unavoidable physical or chemical changes in surface waters can also use one or more practices to mitigate the undesirable changes. The practices include streambank protection, levee protection, channel stabilization, flow restrictors, check dam systems, grade control structures, vegetative cover, instream sediment control, noneroding roadways, and setback levees or flood walls. By using one or more of these practices in combination with predictive modeling, the adverse impacts of channelization and channel modification projects can be evaluated and possibly corrected.

This management measure addresses three of the effects of channelization and channel modification that affect the physical and chemical characteristics of surface waters:

- (1) Changed sediment supply;
- (2) Reduced freshwater availability; and
- (3) Accelerated delivery of pollutants.

3. Management Measure Selection

Selection of this management measure was based on the following factors:

- (1) Published case studies of existing channelization and channel modification projects describe alterations to the physical and chemical characteristics of surface waters (Burch et al., 1984; Erickson et al., 1979; Parrish et al., 1978; Pennington and Dodge, 1982; Petersen, 1990; Reiser et al., 1985; Roy and Messier, 1989; Sandheinrich and Atchison, 1986; Sherwood et al., 1990). Frequently, the postproject conditions are intolerable to desirable fish and wildlife.
- (2) The literature also describes instream benefits for fish and wildlife that can result from careful planning of channelization and channel modification projects (Bowie, 1981; Los Angeles River Watershed, 1973; Sandheinrich and Atchison, 1986; Shields et al., 1990; Swanson et al., 1987; USACE, 1981; USACE, 1989).
- (3) Increased volumes of runoff resulting from some types of watershed development produce hydraulic changes in downstream areas including bank scouring, channel modifications, and flow alterations (Anderson, 1992; Schueler, 1987).

4. Practices

As explained more fully at the beginning of this chapter and in Chapter 1, the following practices are described for illustrative purposes only. State programs need not require implementation of practices. However, as a practical matter, EPA anticipates that the management measure set forth above generally will be implemented by applying one or more management practices appropriate to the source, location, and climate. The practices set forth below have been found by EPA to be representative of the types of practices that can be applied successfully to achieve the management measure described above.

- a. *Use models/methodologies as one means to evaluate the effects of proposed channelization and channel modification projects on the physical and chemical characteristics of surface waters. Evaluate these effects as part of watershed plans, land use plans, and new development plans.*

Mathematical Models for Physical and Chemical Characteristics of Surface Waters, Including Instream Flows

Over the past 20 to 30 years, theoretical and engineering advances have been made in the quantitative descriptions and interactions of physical transport processes; sediment transport, erosion, and deposition; and surface water quality processes. Based on these theoretical approaches and the need for evaluations of proposed surface water resource engineering projects, a variety of simulation models have been developed and applied to provide technical input for complex decision-making. In planning-level evaluations of proposed hydromodification projects, it is critical to understand that the surface water quality and ecological impact of the proposed project will be driven primarily by the alteration of physical transport processes. In addition, it is critical to realize that the most important environmental consequences of many hydromodification projects will occur over a long-term time scale of years to decades.

The key element in the selection and application of models for the evaluation of the environmental consequences of hydromodification projects is the use of appropriate models to adequately characterize circulation and physical transport processes. Appropriate surface water quality and ecosystem models (e.g., salinity, sediment, cultural eutrophication, oxygen, bacteria, fisheries, etc.) are then selected for linkage with the transport model to evaluate the environmental impact of the proposed hydromodification project. Because of the increasing availability of relatively inexpensive computer hardware and software over the past decade, rapid advances have been made in the development of sophisticated two-dimensional (2D) and three-dimensional (3D) time-variable hydrodynamic models that can be used for environmental assessments of hydromodification projects (see Spaulding, 1990; McAnally, 1987). Two-dimensional depth or laterally averaged hydrodynamic models are economical and can be routinely developed and applied for environmental assessments of beneficial and adverse effects on surface water quality by knowledgeable teams of physical scientists and engineers (Hamilton, 1990). Three-dimensional hydrodynamic models, usually considered more of an academic research tool, are also beginning to be more widely applied for large-scale environmental assessments of aquatic ecosystems (e.g., EPA/USACE-WES Chesapeake Bay 3D hydrodynamic and surface water quality model).

The necessity for the application of detailed 2D and 3D hydrodynamic models for large-scale hydromodification projects can be demonstrated using detailed simulation models to hindcast the long-term surface water quality and ecological impact of projects that have actually been constructed over the past 20 to 40 years. Sufficient data are available from a number of large-scale hydromodification projects in the United States and overseas that can provide data sets for the development of hindcasting models to illustrate the capability of the models to simulate the known adverse long-term ecological consequences of projects that have actually been operational for decades. The results of such hindcasting evaluations could provide important guidance for resource managers, who use good professional judgment to understand the level of technical complexity and the costs required for an adequate assessment of the long-term ecological impacts of proposed hydromodification projects. In the Columbia River estuary, for example, Sherwood and others (1990) used historical bathymetric data with a numerical 2D hydrodynamic model (Hamilton, 1990) to document the long-term impact of hydromodification changes on channel morphology, riverflow transport processes, salinity intrusion, residence time, and net accumulation of sediment.

When models are not suited to evaluate a particular situation, examining existing conditions and using best professional judgment are another way to evaluate the effects of hydromodification activities. For example, in cases where water supplies need to be restored to wetlands that have historically experienced a loss of water contact, models can be used to ensure that the length of time of renewed water exposure is within the tolerance of the wetland plants for inundation, since excessive inundation of wetland plants can be as destructive as loss of water contact. Surface water quality monitoring and procedures such as Rapid Bioassessment Protocols (see Management Measure B in this section for more information) are examples of methods to examine existing conditions.

Table 6-1 lists some of the available models for studying the effects of channelization and channel modification activities. Listed below are examples of channelization and channel modification activities and associated models that can be used in the planning process.

- **Impoundments.** A hydrodynamic model coupled with a surface water quality model (e.g., WASP4) can be applied to determine changes in surface water quality due to an increased detention of storm water runoff caused by the upstream dams. Changes in sediment distribution in the estuary caused by a reduction in the sediment source (due to the trap efficiency of an upstream impoundment) are difficult to determine with modeling.
- **Tidal Flow Restrictions.** Restrictions of tidal flow may include undersized culverts and bridges, tide gates, and weirs. One potential modeling technique to determine the flow through the restriction is the USGS FESWMS-2DH model. Once the flows through the restriction are defined, then WASP4 can be applied to compute surface water quality impacts.
- **Breakwaters, Jetties, and Wave Barriers.** Construction of these coastal structures may alter the surface water circulation patterns and cause sediment accumulation. Physical hydraulic models can be used to qualitatively determine where sediment will accumulate, but they cannot reliably determine the quantities of accumulated sediment. Finite element (CAFE) or finite difference (EFDC) models can be used to determine changes in circulation/flushing caused by the addition or modification of coastal structures. The WASP4 model can be applied to determine surface water quality impacts.
- **Flow Regime Alterations.** Removing or increasing freshwater flows to an estuary can alter the hydraulic characteristics and water chemistry. The WASP4 model can be used to determine surface water quality impacts.
- **Excavation of Uplands for Marina Basins or Lagoon Systems.** Depending on the magnitude and frequency of water-level fluctuations, this activity may result in poorly flushed areas within a marina or lagoon system. Finite element or finite difference models (e.g., CAFE/DISPER and EFDC) can be used to determine a design that will result in adequate flushing. The WASP4 model can be applied to determine surface water quality (e.g., dissolved oxygen or salinity) impacts.

Model Selection

Although a wide range of adequate hydrodynamic and surface water quality models are available, the central issue in the selection of appropriate models for an evaluation of a specific hydromodification project is the appropriate match of the financial and geographical scale of the proposed project with the cost required to perform a credible technical evaluation of the projected environmental impact. It is highly unlikely, for example, that a proposal for a relatively small marina project with planned excavation of an upland area would be expected or required to contain a state-of-the-art hydrodynamic and surface water quality analysis that requires one or more person-years of effort. In such projects, a simplified, desktop approach—requiring less time and money—would most likely be sufficient (McPherson, 1991). In contrast, substantial technical assessment of the long-term environmental impacts would be expected for channelization proposed as part of construction of a major harbor facility or as part of a system of navigation and flood control locks and dams. The assessment should incorporate the use of detailed 2D or 3D hydrodynamic models coupled with sediment transport and surface water quality models.

Table 6-1. Models Applicable to Hydromodification Activities

Model	Description	Source and Contact
CAFE	Circulation Analysis Finite Element.	Developed at MIT in mid-1970s by J.D. Wang and J.J. Connor. E. Eric Adams Massachusetts Institute of Technology Department of Civil Engineering Cambridge, MA
DISPER	Dispersion analysis model that is coupled to the CAFE model.	Developed at MIT in mid-1970s by G.C. Christodoulou. E. Eric Adams Massachusetts Institute of Technology Department of Civil Engineering Cambridge, MA
TABS-2	Generalized numerical modeling system for open-channel flows, sedimentation, and constituent transport.	Developed by U.S. Army Corps of Engineers Waterways Experiment Station 1978-1984. U.S. Army Waterways Experiment Station Hydraulics Laboratory P.O. Box 631 Vicksburg, MS 39180-0631
EFDC	Environmental Fluid Dynamics Code. This is a 3D finite-difference hydrodynamic and salinity model.	Developed by John Hamrick at the Virginia Institute of Marine Science 1990-1991. Dr. John Hamrick 9 Sussex Court Williamsburg, VA 23188
WASP4	Water Quality Analysis Simulation Program. Simulates dissolved oxygen and nutrients.	Developed and updated by EPA Environmental Research Laboratory, Athens, Georgia, 1986-1990. David Disney U.S. EPA Center for Exposure Assessment Modeling College Station Road Athens, GA 30613
FESWMS-2DH	Finite element surface water modeling system for two-dimensional flow in a horizontal plane. Can simulate steady and unsteady surface water flow and is useful for simulating two-dimensional flow where complicated hydraulic conditions exist (e.g., highway crossings of streams and flood rivers).	Developed for U.S. Geological Survey, Reston, VA Dr. David Froehlich Department of Civil Engineering University of Kentucky Lexington, KY
TPA	Tidal Prism Analysis.	U.S. EPA. 1985. <i>Coastal Marinas Assessment Handbook</i> . U.S. EPA, Region 4, Atlanta, GA.
CE-QUAL-W2	Consists of directly coupled hydrodynamic and water quality transport models. Can simulate suspended solids and accumulation and decomposition of detritus and organic sediment. Two-dimensional in the x-z plane.	Developed by U.S. Army Corps of Engineers Waterways Experiment Station in 1986. U.S. Army Waterways Experiment Station Hydraulics Laboratory P.O. Box 631 Vicksburg, MS 39180-0631

In general, six criteria can be used to review available models for potential application in a given hydromodification project:

- (1) Time and resources available for model application;
- (2) Ease of application;
- (3) Availability of documentation;
- (4) Applicability of modeled processes and constituents to project objectives and concerns;
- (5) Hydrodynamic modeling capabilities; and
- (6) Demonstrated applicability to size and type of project.

The Center for Exposure Assessment Modeling (CEAM), EPA Environmental Research Laboratory, Athens, Georgia, provides continual support for several hydrodynamic and surface water quality models. Another source of information and technical support is the Waterways Experiment Station, U.S. Army Corps of Engineers, Vicksburg, Mississippi. Although a number of available models are in the public domain, costs associated with setting up and operating these models may exceed the project's available resources. For a simple to moderately difficult application, the approximate level of effort varies from 1 to 12 person-months (Table 6-2).

Model Limitations

Factors that need to be considered in the application of mathematical models to predict impacts from hydromodification projects include:

- Variations in the accuracy of these models when they are applied to the short- and long-term response of natural systems;
- The availability of relevant information to derive the simulations and validate the modeling results;
- The substantial computer time required for long-term simulations of 3D hydrodynamic and surface water quality process models; and
- The need for access to sophisticated equipment such as the CRAY-XMP.

- **b.** *Identify and evaluate appropriate BMPs for use in the design of proposed channelization or channel modification projects or in the operation and maintenance program of existing projects. Identify and evaluate positive and negative impacts of selected BMPs and include costs.*

Several available surface water management practices can be implemented to avoid or mitigate the physical and chemical impacts generated by hydromodification projects. Many of these practices have been engineered and used for several decades not only to mitigate human-induced impacts but also to rehabilitate hydrologic systems degraded by natural processes.

Table 6-2. Approximate Levels of Effort for Hydrodynamic and Surface Water Quality Modeling

Dimensionality	Surface Water Quality Parameter	Approximate Level of Effort
1D steady state	DO, BOD, nutrient	1-2 person-months
1D, 2D steady state	DO, BOD, nutrient, phytoplankton, toxics	1-4 person-months
1D, 3D time-variable	DO, BOD, nutrient, phytoplankton, toxics	1-12 person-months

Streambank Protection

In general, the design of streambank protection may involve the use of several techniques and materials. Nonstructural or programmatic management practices for the prevention of streambank failures include:

- Protection of existing vegetation along streambanks;
- Regulation of irrigation near streambanks and rerouting of overbank drainage; and
- Minimization of loads on top of streambanks (such as prevention of building within a defined distance from the streambed).

Several structural practices are used in the protection or the rehabilitation of eroded banks. These practices are usually implemented in combination to provide stability of the stream system, and they can be grouped into direct and indirect methods. Direct methods place protecting material in contact with the bank to shield it from erosion. Indirect methods function by deflecting channel flows away from the bank or by reducing the flow velocities to nonerosive levels (Henderson and Shields, 1984; Henderson, 1986). Indirect bank protection requires less bank grading and tree and snag removal.

Direct methods for streambank protection include stone riprap revetment, erosion control fabrics and mats, revegetation, burlap sacks, cellular concrete blocks, and bulkheads. Indirect methods include dikes, wire or board fences, gabions, and stone longitudinal dikes. The feasibility of these practices depends on the engineering design of the structure, the availability of the protecting material, the extent of the bank erosion, and specific site conditions such as the flow velocity, channel depth, inundation characteristics, and geotechnical characteristics of the bank. The use of vegetation alone or in combination with other structural practices, when appropriate, would further reduce the engineering and maintenance efforts.

Innovative designs of streambank protection tailored to specific environmental goals and site conditions may result in beneficial effects. Several innovative channel profiling and revetment design considerations were reviewed by Henderson and Shields (1984), including composite revetments for deep channels with flow concentrated along the bank line, windrow revetments for actively eroding and irregular banks, and reinforced revetments (stone toe protection) to control underwater activities adjacent to high banks. Composite revetments placed along the Missouri River were built with a combination of stone, gravel, clay, and flood-tolerant vegetation to protect the streambank (USACE, 1981). The different materials were selected to match the erosive potential of the streambank zones. Beneficial environmental impacts that can be achieved by this type of design include higher densities and abundance of riparian vegetation on the top bank, allowing flood-tolerant species to colonize the clay and gravel of the splash zone. The design was reported to provide better access to the channel by wildlife, and it had a greater aesthetic value.

An excavated bench (compound channel) streambank protection design, based on streambed stabilization, was used to control erosion activities on the Yazoo River tributaries in Mississippi. These tributaries were experiencing extensive bed degradation and channel migration. The design consisted of structural protection to the water elevation reached during 90 to 95 percent of the annual storm events, a flattened bench excavated just above the structural protection to provide a suitable growing environment for wood vegetation and shrubs, and a grass-seeded upper bank, which could be succeeded by native species. This practice has been reported to be successful in controlling streambank erosion (Bowie, 1981).

Streambank protection structures may impact the riparian wildlife community if the stabilization effort alters the quality of the riparian habitat. Comparison of protected riprapped and adjacent unprotected streambanks and cultivated nearby areas along the Sacramento River showed that bird species diversity and density were significantly lower on the riprapped banks than on the unaltered sites (Hehnke and Stone, 1978). However, benthic microorganisms appear to benefit from stone revetment. Burress and others (1982) found that the density and diversity of macroinvertebrates were higher in the protected bank areas.

Levee Protection

Many valuable techniques can be used, when applied correctly, to protect, operate, and maintain levees (Hynson et al., 1985). Evaluation of site-specific conditions and the use of best professional judgment are the best methods for selecting the proper levee protection and operation and maintenance plan. According to Hynson and others (1985), maintenance activities generally consist of vegetation management, burrowing animal control, upkeep of recreational areas, and levee repairs.

Methods to control vegetation include mowing, grazing, burning, and using chemicals. Selection of a vegetation control method should consider the existing and surrounding vegetation, desired instream and riparian habitat types and values, timing of controls to avoid critical periods, selection of livestock grazing periods, and timing of prescribed burns to be consistent with historical fire patterns (Hynson et al., 1985). Additionally, a balance between the vegetation management practices for instream and riparian habitat and engineering considerations should be maintained to avoid structural compromise (Hynson et al., 1985). Animal control methods are most effective when used as a part of an integrated pest management program and might include instream and riparian habitat manipulation or biological controls (Hynson et al., 1985). Recreational area management includes upkeep of planted areas, disposal of solid waste, and repairing of facilities (Hynson et al., 1985).

Channel Stabilization and Flow Restrictors

Channel stabilization using hydraulic structures to stabilize stream channels, as well as to control stream sediment load and transport, is a common practice. In general, these structures function to:

- Retard further downward cutting of the channel bed;
- Retard or reduce the sediment delivery rate;
- Raise and widen the channel beds;
- Reduce the stream grade and flow velocities;
- Reduce movement of large boulders; and
- Control the direction of flow and the position of the stream.

Check Dam Systems

The Los Angeles River Watershed (1973) evaluated the cost-effectiveness of check dam systems as sediment control structures in the Angeles National Forest. In general, the check dam systems were found to be marginally cost-effective and were able to provide some beneficial sediment-reduction functions.

Swanson and others (1987) described the use of 71 check dams in the headwaters area of a perennial stream in northwestern Nevada. Watershed management problems, such as a history of overgrazing, led to riparian habitat degradation in streamside areas and severe gullying. The problem was ameliorated with changes in watershed management practices (livestock exclusion in streamside areas or limited grazing programs) and structural practices (check dams). Loose rock check dams, designed for 25-year floods, were selected for their ability to retard water velocities and trap sediment.

Benefits of this planned channel modification project include both instream and streamside changes. Sediment was trapped behind the dams (average of 0.9 foot in 2 years), and small wetland areas were established behind most dams. Additionally, over one-half of the channel length was vegetated in the deepest areas and the entire channel was at least partially vegetated. Streamside benefits included increased bird and plant diversity and abundance.

Grade Control Structures - Streambank and Channel Stabilization

Grade control structures (GCS) are hydraulic barriers (weirs) installed across streams to stabilize the channel, control headcuts and scour holes, and prevent upstream degradation. These structures can be built with a variety of materials, including sheet piling, stone, gabions, or concrete. Grade control structures are usually installed in

combination with other practices to protect streambanks and direct the stream flow. Grade control structure design needs to account for stream morphologic, hydrologic, and hydraulic characteristics to determine the range of stream discharges for which the structure will function. Additionally, the upstream distance influenced by the structure, changes to surface water profiles, and the sediment transport capacity of the targeted stream reach need to be considered.

Shields and others (1990) evaluated the efficiency of GCS installed on Twentymile Creek (northeast Mississippi) to address channel instability. Effects on bank line vegetation were assessed using a before-and-after approach. Benefits of the GCS included local channel aggradation for about 1 mile upstream of each structure, increased streambank vegetation, locally increased fish species diversity downstream from the GCS, and the creation of low-flow velocities and greater pool depths downstream from the GCS. The primary problem associated with the project was the continued general streambed degradation after the structures were installed.

Vegetative Cover

Streambank protection using vegetation is probably the most commonly used practice, particularly in small tributaries. Vegetative cover, also used in combination with other structural practices, is relatively easy to establish and maintain, is visually attractive, and is the only streambank stabilization method that can repair itself when damaged (USACE, 1983). Appropriate native plant species should be used. Vegetation growing under the waterline provides two levels of protection. First, the root system helps to hold the soil together and increases overall bank stability by forming a binding network. Second, the exposed stalks, stems, branches, and foliage provide resistance to the streamflow, causing the flow to lose part of its energy by deforming the plants rather than by removing the soil particles. Above the waterline, vegetation protects against rainfall impact on the banks and reduces the velocity of the overland flow during storm events.

In addition to its bank stabilization potential, vegetation can provide pollutant-filtering capacity. Pollutant and sediment transported by overland flow may be partly removed as a result of a combination of processes including reduction in flow pattern and transport capacity, settling and deposition of particulates, and eventually nutrient uptake by plants.

Instream Sediment Load Control

Instream sediment can be controlled by using several structural practices depending on the management objective and the source of sediment. Streambank protection and channel stabilization practices, including various types of revetments, grade control structures, and flow restrictors, have been effective in controlling sediment production caused by streambank erosion. Significant amounts of instream sediment deposition can be prevented by controlling bank erosion processes and streambed degradation. Channel stabilization structures can also be designed to trap sediment and decrease the sediment delivery to desired areas by altering the transport capacity of the stream and creating sediment storage areas. In regulated streams, alteration of the natural streamflow, particularly the damping of peak flows caused by surface water regulation and diversion projects, can increase streambed sediment deposits by impairing the stream's transport capacity and its natural flushing power. Sediment deposits and reduced flow alter the channel morphology and stability, the flow area, the channel alignment and sinuosity, and the riffle and pool sequence. Such alterations have direct impacts on the aquatic habitat and the fish populations in the altered streams (Reiser et al., 1985).

Noneroding Roadways

Farm, forestry, and other rural road construction; streamside vehicle operation; and stream crossings usually result in significant soil disturbance and create a high potential for increased erosion processes and sediment transport to adjacent streams and surface waters. Road construction involves activities such as clearing of existing native vegetation along the road right-of-way; excavating and filling the roadbed to the desired grade; installation of culverts and other drainage systems; and installation, compaction, and surfacing of the roadbed.

Although most erosion from roadways occurs during the first few years after construction, significant impacts may result from maintenance operations using heavy equipment, especially when the road is located adjacent to a waterbody. In addition, improper construction and lack of maintenance may increase erosion processes and the risk for road failure. To minimize erosion and prevent sedimentation impacts on nearby waterbodies during construction and operation periods, streamside roadway management needs to combine proper design for site-specific conditions with appropriate maintenance practices. Chapter 3 of this document reviews available practices for rural road construction and management to minimize impacts on waterbodies in coastal zones. Chapter 4 outlines practices and design concepts for construction and management of roads designed for heavier traffic loads and can be applied to planning and installation of roads and highways in coastal areas.

Setback Levees and Flood Walls

Levees and flood walls are longitudinal structures used to reduce flooding and minimize sedimentation problems associated with fluvial systems. They can be constructed without disturbing the natural channel vegetation, cross section, or bottom slope. Usually no immediate instream effects from sedimentation are caused by implementing this type of modification. However, there may be a long-term problem in channel adjustment (USACE, 1989).

Siting of levees and flood walls should be addressed prior to design and implementation of these types of projects. Proper siting of such structures can avoid several types of problems. First, construction activities should not disturb the physical integrity of adjacent riparian areas and/or wetlands. Second, by setting back the structures (offsetting them from the streambank), the relationship between the channel and adjacent riparian areas can be preserved. Proper siting and alignment of proposed structures can be established based on hydraulic calculations, historical flood data, and geotechnical analysis of riverbank stability.

5. Costs for Modeling Practices

Costs for modeling of channelization and channel modification activities range from \$1,500 to over \$5,000,000 (see Table 6-3). Generally, more expensive modeling requires custom programming, extensive data collection, detailed calibration and verification, and larger computers. The benefits of more expensive modeling include a more detailed analysis of the problem and the ability to include more variables in the model. Less expensive models, in general, have minimal data requirements and require little or no programming, and they can usually be run on smaller computers. The difference in cost roughly corresponds to the detail that can be expected in the final analysis.

Table 6-3. Costs of Models for Various Applications

Application	Model	Cost (\$)
Channel Maintenance	Physical model of estuary, river, or stream "from scratch"	500,000 to 5,000,000
	Existing physical model of estuary, river, or stream	50,000 to 500,000
	3D hydrodynamic and salinity model	50,000 to 200,000
	TABS-2 application for sedimentation	50,000 to 200,000
	TPA application to a marina basin	1,500 to 3,000
	WASP4 application to a marina basin	15,000 to 50,000
Dams and Impoundments	WASP4 application to an estuary or a reservoir	50,000 to 150,000
	CE-QUAL-W2 application to an estuary or a reservoir	50,000 to 100,000
	Estuarine or reservoir sediment transport models	unlimited
Tidal Flow Restrictors	FESWMS-2DH application of tidal flow restriction	15,000 to 30,000
	WASP4 application of tidal flow restriction	50,000 to 150,000
Flow Regime Alterations	WASP4 application of flow regime alteration	50,000 to 150,000
Breakwaters and Wave Barriers	CAFE finite element circulation model	15,000 to 50,000
	EFDC finite difference 3D model	20,000 to 60,000
	WASP4 application to harbor system	15,000 to 50,000
Excavation of Uplands for Marina Basins or Lagoon Systems	CAFE/DISPER models	15,000 to 50,000
	EFDC 3D hydrodynamic model	20,000 to 60,000
	WASP4 application to marina/lagoon	15,000 to 50,000

B. Instream and Riparian Habitat Restoration Management Measure

- (1) Evaluate the potential effects of proposed channelization and channel modification on instream and riparian habitat in coastal areas;**
- (2) Plan and design channelization and channel modification to reduce undesirable impacts; and**
- (3) Develop an operation and maintenance program with specific timetables for existing modified channels that includes identification of opportunities to restore instream and riparian habitat in those channels.**

1. Applicability

This management measure pertains to surface waters where channelization and channel modification have altered or have the potential to alter instream and riparian habitat such that historically present fish or wildlife are adversely affected. This management measure is intended to apply to any proposed channelization or channel modification project to determine changes in instream and riparian habitat and to existing modified channels to evaluate possible improvements to instream and riparian habitat. Under the Coastal Zone Act Reauthorization Amendments of 1990, States are subject to a number of requirements as they develop coastal NPS programs in conformity with management measures and will have some flexibility in doing so. The application of this management measure by States is described more fully in *Coastal Nonpoint Pollution Control Program: Program Development and Approval Guidance*, published jointly by the U.S. Environmental Protection Agency (EPA) and the National Oceanic and Atmospheric Administration (NOAA) of the U.S. Department of Commerce.

2. Description

The purpose of this management measure is to correct or prevent detrimental changes to instream and riparian habitat from the impacts of channelization and channel modification projects. Implementation of this management measure is intended to occur concurrently with the implementation of Management Measure A (Physical and Chemical Characteristics of Surface Waters) of this section.

Contact between floodwaters and overbank soil and vegetation can be increased by a combination of setback levees and use of compound-channel designs. Levees set back away from the streambank (setback levees) can be constructed to allow for overbank flooding, which provides surface water contact to important streamside areas (including wetlands and riparian areas). Additionally, setback levees still function to protect adjacent property from flood damage. Compound-channel designs consist of an incised, narrow channel to carry surface water during low (base)-flow periods, a staged overbank area into which the flow can expand during design flow events, and an extended overbank area, sometimes with meanders, for high-flow events. Planting of the extended overbank with suitable vegetation completes the design.

Preservation of ecosystem benefits can be achieved by site-specific design to obtain predefined optimum or existing ranges of physical environmental conditions. Mathematical models can be used to assist in site-specific design.

Instream and riparian habitat alterations caused by secondary effects can be evaluated by the use of models and other decision aids in the design process of a channelization and channel modification activity. After using models to evaluate secondary effects, restoration programs can be established.

3. Management Measure Selection

Selection of this management measure was based on the following factors:

- (1) Published case studies that show that channelization projects cause instream and riparian habitat degradation. For example, wetland drainage due to hydraulic modifications was found to be significant by several researchers (Barclay, 1980; Erickson et al., 1979; Schoof, 1980; Wilcock and Essery, 1991).
- (2) Published case studies that note instream habitat changes caused by channelization and channel modifications (Reiser et al., 1985; Sandheinrich and Atchison, 1986).

4. Practices

As explained more fully at the beginning of this chapter and in Chapter 1, the following practices are described for illustrative purposes only. State programs need not require implementation of practices. However, as a practical matter, EPA anticipates that the management measure set forth above generally will be implemented by applying one or more management practices appropriate to the source, location, and climate. The practices set forth below have been found by EPA to be representative of the types of practices that can be applied successfully to achieve the management measure described above.

- a. *Use models/methodologies to evaluate the effects of proposed channelization and channel modification projects on instream and riparian habitat and to determine the effects after such projects are implemented.*

Expert Judgment and Check Lists

Approaches using expert judgment and check lists developed based on experience acquired in previous projects and case studies may be very helpful in integrating environmental goals into project development. This concept of incorporating environmental goals into project design was used by the U.S. Army Corps of Engineers (Shields and Schaefer, 1990) in the development of a computer-based system for the environmental design of waterways (ENDOW). The system is composed of three modules: streambank protection module, flood control channel module, and streamside levee module. The three modules require the definition of the pertinent environmental goals to be considered in the identification of design features.

Depending on the environmental goals selected for each module, ENDOW will display a list of comments or cautions about anticipated impacts and other precautions to be taken into account in the design.

Biological Methods/Models

To assess the biological impacts of channelization, it is necessary to evaluate both physical and biological attributes of the stream system. Assessment studies should be performed before and after channel modification, with samples being collected upstream from, within, and downstream from the modified reach to allow characterization of baseline conditions. It is also desirable to identify and sample a reference site within the same ecoregion as part of the rapid bioassessment procedures discussed below.

Habitat Evaluation Procedures

Habitat Evaluation Procedures (HEPs) can be used to document the quality and quantity of available habitat, including aquatic habitat, for selected wildlife species. HEPs provide information for two general types of instream and riparian habitat comparisons:

- (1) The relative value of different areas at the same point in time and
- (2) The relative value of the same area at future points in time.

By combining the two types of comparisons, the impact of proposed or anticipated land and water use changes on instream and riparian habitat can be quantified (USDOI-FWS, 1980).

Rapid Bioassessment Protocols - Habitat Assessment

Rapid Bioassessment Protocols (RBPs) were developed as inexpensive screening tools for determining whether a stream is supporting a designated aquatic life use (Plafkin et al., 1989). One component of these protocols is an instream habitat assessment procedure that measures physical characteristics of the stream reach (Barbour and Stribling, 1991). An assessment of instream habitat quality based on 12 instream habitat parameters is performed in comparison to conditions at a "reference" site, which represents the "best attainable" instream habitat in nearby streams similar to the one being studied. The RBP habitat assessment procedure has been used in a number of locations across the United States. The procedure typically can be performed by a field crew of one person in approximately 20 minutes per sampling site.

Rapid Bioassessment Protocol III - Benthic Macroinvertebrates

Rapid Bioassessment Protocols (Plafkin et al., 1989) were designed to be scientifically valid and cost-effective and to offer rapid return of results and assessments. Protocol III (RBP III) focuses on quantitative sampling of benthic macroinvertebrates in riffle/run habitat or on other submerged, fixed structures (e.g., boulders, logs, bridge abutments, etc.) where such riffles may not be available. The data collected are used to calculate various metrics pertaining to benthic community structure, community balance, and functional feeding groups. The metrics are assigned scores and compared to biological conditions as described by either an ecoregional reference database or site-specific reference sites chosen to represent the "best attainable" biological community in similarly sized streams. In conjunction with the instream habitat quality assessment, an overall assessment of the biological and instream habitat quality at the site is derived. RBP III can be used to determine spatial and temporal differences in the modified stream reach. Application of RBP III requires a crew of two persons; field collections and lab processing require 4 to 7 hours per station and data analysis about 3 to 5 hours, totaling 7 to 12 hours per station. The RBP III has been extensively applied across the United States.

Rosgen Stream Classification System - Fish Habitat

Rosgen (1985) has developed a stream classification system that categorizes various stream types by morphological characteristics. Based on characteristics such as gradient, sinuosity, width/depth ratio, bed particle size, channel entrenchment/valley confinement, and landform features and watershed soil types, stream segments can be placed within major categories. Subcategories can be delineated using additional factors including organic debris, riparian vegetation, stream size, flow regimen, depositional features, and meander patterns. The method is designed to be applied using aerial photographs and topographic maps, with field validation necessary for gradients, particle size, and width/depth ratios. Rosgen and Fittante (1986) have prepared guidelines for fish habitat improvement structure suitability based on Rosgen's (1985) classification system. The methods have been used in the western States and have had some application in the eastern States.

Simon and Hupp Channel Response Model - Stream Habitat

A conceptual model of channel evolution in response to channelization has been developed by Simon and Hupp (1986, 1987), Hupp and Simon (1986, 1991), and Simon (1989a, 1989b). The model identifies six geomorphic stages of channel response and was developed and extensively applied to predict empirically stream channel changes following large-scale channelization projects in western Tennessee. Data required for model application include bed elevation and gradient, channel top-width, and channel length before, during, and after modification. Gauging station data can be used to evaluate changes through time of the stage-discharge relationship and bed-level trends. Riparian vegetation is dated to provide ages of various geomorphic surfaces and thereby to deduce the temporal stability of a reach.

Temperature Predictions

Stream temperature has been widely studied, and heat transfer is one of the better-understood processes in natural watershed systems. Most available approaches use energy balance formulations based on the physical processes of heat transfer to describe and predict changes in stream temperature. The six primary processes that transfer energy in the stream environment are (1) short-wave solar radiation, (2) long-wave solar radiation, (3) convection with the air, (4) evaporation, (5) conduction to the soil, and (6) advection from incoming water sources (e.g., ground-water seepage).

Several computer models that predict instream water temperature are currently available. These models vary in the complexity of detail with which site characteristics, including meteorology, hydrology, stream geometry, and riparian vegetation, are described. An instream surface water temperature model was developed by the U.S. Fish and Wildlife Service (Theurer et al., 1984) to predict mean daily temperature and diurnal fluctuations in surface water temperatures throughout a stream system. The model can be applied to any size watershed or river system. This predictive model uses either historical or synthetic hydrological, meteorological, and stream geometry characteristics to describe the ambient conditions. The purpose of the model is to predict the longitudinal temperature and its temporal variations. The instream surface water temperature model has been used satisfactorily to evaluate the impacts of riparian vegetation, reservoir releases, and stream withdrawal and returns on surface water temperature. In the Upper Colorado River Basin, the model was used to study the impact of temperature on endangered species (Theurer et al., 1982). It also has been used in smaller ungauged watersheds to study the impacts of riparian vegetation on salmonid habitat.

Index of Biological Integrity - Fish Habitat

Karr et al. (1986) describe an Index of Biological Integrity (IBI), which includes 12 matrices in three major categories of fish assemblage attributes: species composition, trophic composition, and fish abundance and condition. Data are collected at each site and compared to those collected at regional reference sites with relatively unimpacted biological conditions. A numerical rating is assigned to each metric based on its degree of agreement with expectations of biological condition provided by the reference sites. The sum of the metric ratings yields an overall score for the site. Application of the IBI requires a crew of two persons; field collections require 2 to 15 hours per station and data analysis about 1 to 2 hours, totaling 3 to 17 hours per station. The IBI, which was originally developed for Midwestern streams, can be readily adapted for use in other regions. It has been used in over two dozen States across the country to assess a wide range of impacts in streams and rivers.

Simon and Hupp Vegetative Recovery Model - Streamside Habitat

A component of Simon and Hupp's (1986, 1987) channel response model is the identification of specific groups of woody plants associated with each of the six geomorphic channel response stages. Their findings for western Tennessee streams suggest that the site preference or avoidance patterns of selected tree species allow their use as indicators of specific bank conditions. This method might require calibration for specific regions of the United States to account for differences in riparian zone plant communities, but it would allow simple vegetative reconnaissance of an area to be used for a preliminary estimate of stream recovery stage (Simon and Hupp, 1987).

- b. *Identify and evaluate appropriate BMPs for use in the design of proposed channelization or channel modification projects or in the operation and maintenance program of existing projects. Identify and evaluate positive and negative impacts of selected BMPs and include costs.*

Operation and maintenance programs should include provisions to use one or more of the approaches described under Practice "b" of Management Measure A of this section. To prevent future impacts to instream or riparian habitat or to solve current problems caused by channelization or channel modification projects, include one or more of the following in an operation and maintenance program:

- Streambed protection;
- Levee protection;
- Channel stabilization and flow restrictors;
- Check dams;
- Vegetative cover;
- Instream sediment load control;
- Noneroding roadways; and
- Setback levees and flood walls.

Operation and maintenance programs should weigh the benefits of including practices such as these for mitigating any current or future impairments to instream or riparian habitat.

III. DAMS MANAGEMENT MEASURES

The second category of sources for which management measures and practices are presented in this chapter is dams. Dams are defined as constructed impoundments that are either (1) 25 feet or more in height *and* greater than 15 acre-feet in capacity, or (2) 6 feet or more in height *and* greater than 50 acre-feet in capacity.¹

Based on this definition, there are 7,790 dams located in coastal counties of the United States, of which 6,928 dams are located in States with approved coastal zone programs (Quick and Richmond, 1992).

The siting and construction of a dam can be undertaken for many purposes, including flood control, power generation, irrigation, livestock watering, fish farming, navigation, and municipal water supply. Some reservoir impoundments are also used for recreation and water sports, for fish and wildlife propagation, and for augmentation of low flows. Dams can adversely impact the hydraulic regime, the quality of the surface waters, and habitat in the stream or river where they are located. A variety of impacts can result from the siting, construction, and operation of these facilities.

Dams are divided into the following classes: run-of-the-river, mainstem, transitional, and storage. A run-of-the-river dam is usually a low dam, with small hydraulic head, limited storage area, short detention time, and no positive control over lake storage. The amount of water released from these dams depends on the amount of water entering the impoundment from upstream sources. Mainstem dams, which include run-of-the-river dams, are characterized by a retention time of approximately 25 days and a reservoir depth of approximately 50 to 100 feet. In mainstem dams, the outflow temperature is approximately equal to the inflow temperature plus the solar input, thus causing a "warming" effect. Transitional dams are characterized by a retention time of about 25 to 200 days and a maximum reservoir depth of between 100 and 200 feet. In transitional dams, the outflow temperature is approximately equal to the inflow temperature so that during the warmer months coldwater fish cannot survive unless the inflows are cold. The storage dam is typically a high dam with large hydraulic head, long detention time, and positive control over the volume of water released from the impoundment. Dams constructed for either flood control or hydroelectric power generation are usually of the storage class. These dams typically have a retention time of over 200 days and a reservoir depth of over 100 feet. The outflow temperature is sufficient for coldwater fish, even with warm inflows.

The siting of dams can result in the inundation of wetlands, riparian areas, and farmland in upstream areas of the waterway. Dams either reduce or eliminate the downstream flooding needed by some wetlands and riparian areas. Dams can also impede or block migration routes of fish.

Construction activities from dams can cause increased turbidity and sedimentation in the waterway resulting from vegetation removal, soil disturbance, and soil rutting. Fuel and chemical spills and the cleaning of construction equipment (particularly concrete washout) have the potential for creating nonpoint source pollution. The proximity of dams to streambeds and floodplains increases the need for sensitivity to pollution prevention at the project site in planning and design, as well as during construction.

The operation of dams can also generate a variety of types of nonpoint source pollution in surface waters. Controlled releases from dams can change the timing and quantity of freshwater inputs into coastal waters. Dam operations may lead to reduced downstream flushing, which, in turn, may lead to increased loads of BOD, phosphorus, and nitrogen; changes in pH; and the potential for increased algal growth. Lower instream flows, and lower peak flows associated with controlled releases from dams, can result in sediment deposition in the channel several miles downstream of the dam. The tendency of dam releases to be clear water, or water without sediment, can result in erosion of the streambed and scouring of the channel below the dam, especially the smaller-sized sediments. One result is the siltation of gravel bars and riffle pool complexes, which are valuable spawning and nursery habitat for fish. Dams also limit downstream recruitment of suitably-sized substrate required for the anchoring and growth of aquatic plants.

¹ This definition is consistent with the Federal definition at 33 CFR 222.8(h)(1) (1991).

Finally, reservoir releases can alter the water temperature and lower the dissolved oxygen levels in downstream portions of the waterway.

The extent of changes in downstream temperature and dissolved oxygen from reservoir releases depends on the retention time of water in the reservoir and the withdrawal depth of releases from the reservoir. Releases from mainstem projects are typically higher in dissolved oxygen than are releases from storage projects. Storage reservoir releases are usually colder than inflows, while releases from mainstem reservoirs depend on retention time and depth of releases. Reservoirs with short hydraulic residence times have reduced impacts on tailwaters (Walburg et al., 1981).

It is important to note that the operation of dams can have positive, as well as negative, effects on water quality, aquatic habitat, and fisheries within the pool and downstream (USEPA, 1989). Potential positive effects include:

- Creation of above-the-dam summer pool refuge during low flows, an effect that has been documented for small dams built in the upper stream reaches of the Willamette River in the northwest United States (Li et al., 1983);
- Creation of reservoir sport fisheries (USDOJ, 1983); and
- Less scouring and erosion of streambanks as a result of reduced velocities in downstream areas.

Once a river is dammed and a reservoir is created, processes such as stratification, seasonal overturn, chemical cycling, and sedimentation can intensify to create several NPS pollution problems. These processes occur primarily as a result of the presence of the dam, not the operation of the dam.

Stratification is the layering of a lake into an upper, well-lighted, productive, and warm layer, called the *epilimnion*; a mid-depth transitional layer, the *metalimnion*; and a lower, dark, cold, and unproductive layer, the *hypolimnion*. These layers are separated by a thermocline in the metalimnion, a sharp transition in water temperature between upper warm water and lower cold water (Figure 6-1). This stratification varies seasonally, being most pronounced in the summer and absent in the winter. Between these extremes are periods of less pronounced stratification and spring and fall overturns, when the entire waterbody mixes together. Poor mixing conditions, resulting in stratification, are estimated to occur in 40 percent of power impoundments and 37 percent of non-power impoundments (USEPA, 1989).

Dissolved oxygen levels are tied to the overturn, mixing, and stratification processes. Dissolved oxygen concentration in reservoir waters is the result of a delicate balance between both oxygen-producing and oxygen-consuming processes (Bohac and Ruane, 1990). Dissolved oxygen tends to become depleted in the hypolimnion due to decomposition of organic substances, algal respiration, and nitrification. The epilimnion, however, tends to be enriched with oxygen from the atmosphere and as a product of photosynthesis. The net difference between oxygen consumption and oxygen sources can create anoxic conditions in the lower layer (Figure 6-2).

Anoxic conditions in the hypolimnion may stimulate the formation of reduced species of iron, manganese, sulfur, and nitrogen. Chemical cycling of these elements occurs when they change from one state to another (e.g., from solid to dissolved). Many chemicals enter a reservoir attached to sediment particles or quickly become attached to sediment. As a solid, many chemicals typically are not toxic to many organisms, especially those in the water column. Some chemicals are easily reduced under anoxic conditions and become soluble. The reduced and soluble forms of many chemicals and compounds are toxic to most aquatic organisms at relatively low concentrations. For example, hydrogen sulfide is toxic to aquatic life and corrosive to construction materials at concentrations that are considerably lower than those detectable by commonly used procedures (Johnson et al., 1991). These reduced chemical compounds lead to taste and odor problems in drinking water supplies and toxicity problems for fish.

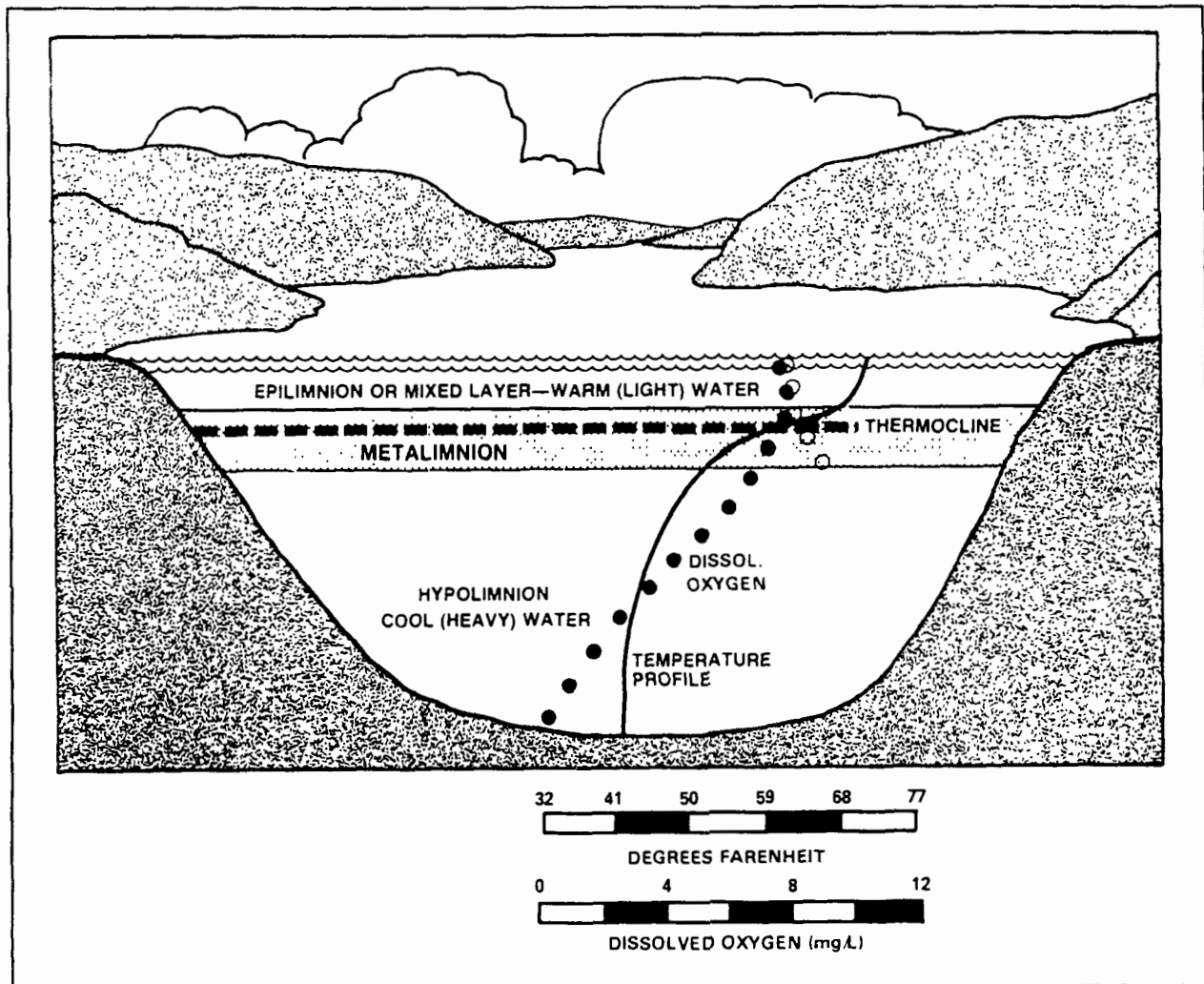

Figure 6-1. A cross-sectional view of a thermally stratified reservoir in mid-summer. The water temperature profile (curved solid line) illustrates how rapidly the water temperature decreases in the metalimnion compared to the nearly uniform temperatures in the epilimnion and hypolimnion. The solid circles represent the dissolved oxygen (DO) profile. The rate of organic matter decomposition is sufficient to deplete the DO content of the hypolimnion (USEPA, 1990).

Hydraulic residence time is defined as the average time required to completely renew a waterbody’s water volume. For example, rivers have little or no hydraulic residence time, lakes with small volumes and high flow rates have short hydraulic residence times, and lakes with large volumes and low flow rates have long hydraulic residence times. Reservoirs differ from lakes in that, among other characteristics, their flow is regulated artificially. Hydraulic residence times of reservoirs are generally shorter than those of lakes, giving the water flowing into the reservoir less time to mix with the resident water.

The longer the hydraulic residence time, the greater the potential for incoming nutrients and sediment to settle in the reservoir. Conditions that lead to eutrophication in reservoirs promote increased algal growth, which in turn lead to a greater mass of dead plant cells. In reservoirs with long residence times, a major source of organic sediment settling to the bottom can be dead plant cells. Sediment will settle to the bottom; but, where reservoir releases are taken from the lower layer, they will release colder water downstream that is rich in nutrients, low in dissolved oxygen, and higher in some dissolved species such as iron, manganese, sulfur, and nitrogen.

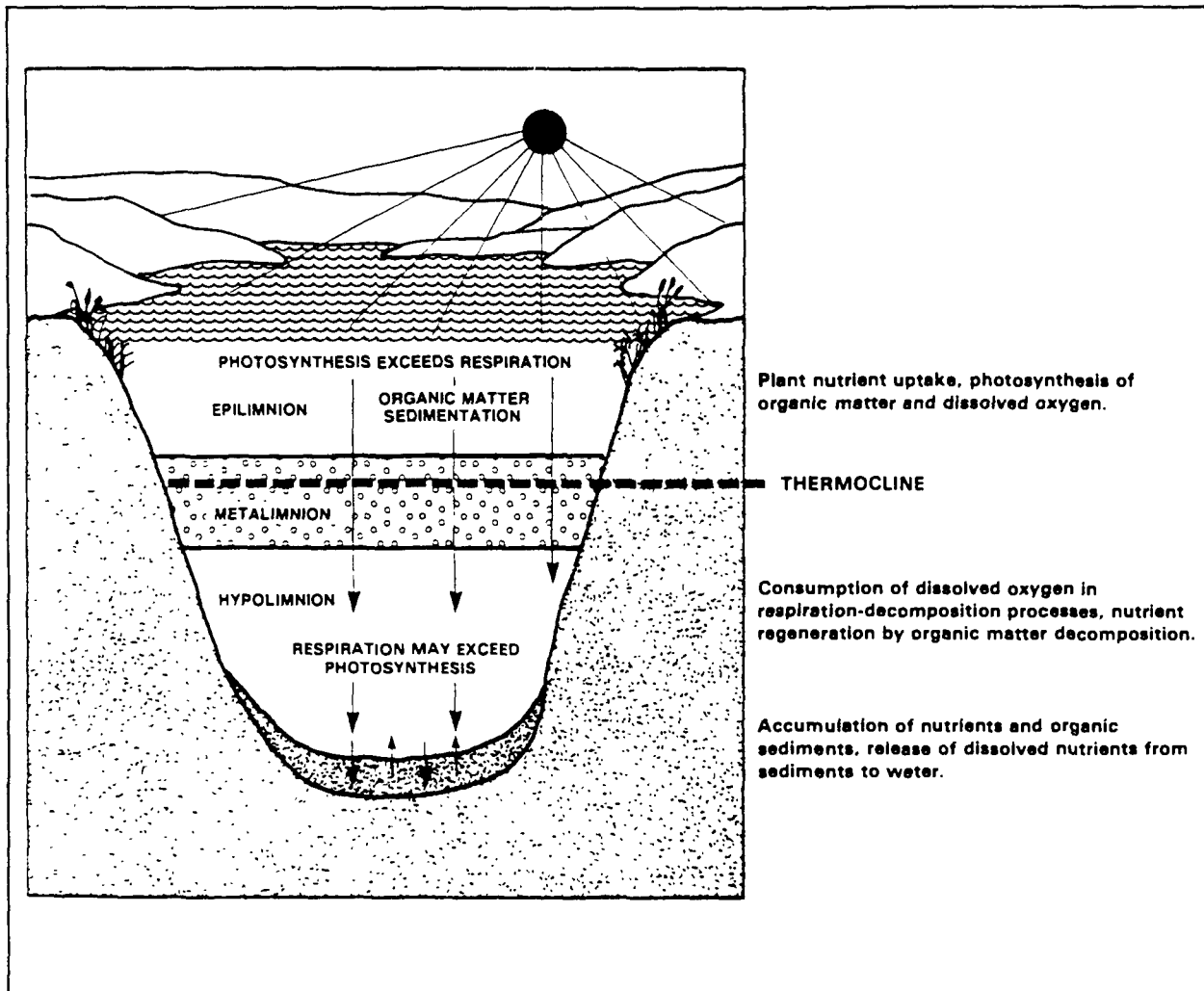

Figure 6-2. Influence of photosynthesis and respiration-decomposition processes and organic matter sedimentation on the distribution of nutrients and organic matter in a stratified reservoir (USEPA, 1990).

Management Measures A and B address two problems associated with the construction of dams:

- (1) Increases in sediment delivery downstream resulting from construction and operation activities and
- (2) Spillage of chemicals and other pollutants to the waterway during construction and operation.

The impacts of reservoir releases on the quality of surface waters and instream and riparian habitat in downstream areas is addressed in Management Measure III.C.

A. Management Measure for Erosion and Sediment Control

- (1) Reduce erosion and, to the extent practicable, retain sediment onsite during and after construction, and
- (2) Prior to land disturbance, prepare and implement an approved erosion and sediment control plan or similar administrative document that contains erosion and sediment control provisions.

1. Applicability

This management measure is intended to be applied by States to the construction of new dams, as well as to construction activities associated with the maintenance of dams. Dams are defined² as constructed impoundments which are either:

- (a) 25 feet or more in height *and* greater than 15 acre-feet in capacity, or
- (b) six feet or more in height *and* greater than 50 acre-feet in capacity.

This measure also does not apply to projects that fall under NPDES jurisdiction. Under the Coastal Zone Act Reauthorization Amendments of 1990, States are subject to a number of requirements as they develop coastal NPS programs in conformity with this measure and will have some flexibility in doing so. The application of management measures by States is described more fully in *Coastal Nonpoint Pollution Control Program: Program Development and Approval Guidance*, published jointly by the U.S. Environmental Protection Agency (EPA) and the National Oceanic and Atmospheric Administration (NOAA) of the U.S. Department of Commerce.

2. Description

The purpose of this management measure is to prevent sediment from entering surface waters during the construction or maintenance of dams. Coastal States should incorporate this measure into existing State erosion and sediment control (ESC) programs or, if such programs are lacking, should develop them. States should incorporate this measure into ESC programs at the local level also. Erosion and sediment control is intended to be part of a comprehensive land use or watershed management program. (Refer to the Watershed and Site Development Management Measures in Chapter 4.)

Runoff from construction sites is the largest source of sediment in urban areas (Maine Department of Environmental Protection, Bureau of Water Quality, and York County Soil and Water Conservation District, 1990). Eroded sediment from construction sites creates many problems in coastal areas including adverse impacts to water quality, critical instream and riparian habitats, submerged aquatic vegetation (SAV) beds, recreational activities, and navigation.

² This definition is consistent with the Federal definition at 33 CFR 222.8(h)(1) (1991).

ESC plans are important for controlling the adverse impacts of dam construction. ESC plans ensure that provisions for control measures are incorporated into the site planning stage of development and provide for prevention of erosion and sediment problems and accountability if a problem occurs (Maine Department of Environmental Protection, 1990). Chapter 4 of this guidance presents a full description of construction-related erosion problems and the value of ESC plans. Readers should refer to Chapter 4 for further information.

3. Management Measure Selection

This management measure was selected because of the importance of minimizing sediment loss to surface waters during dam construction. It is essential that proper erosion and sediment control practices be used to protect surface water quality because of the high potential for sediment loss directly to surface waters.

Two broad performance goals constitute this management measure: minimizing erosion and maximizing the retention of sediment onsite. These performance goals give States and local governments flexibility in specifying practices appropriate for local conditions.

4. Practices

As discussed more fully at the beginning of this chapter and in Chapter 1, the following practices are described for illustrative purposes only. State programs need not require the implementation of these practices. However, as a practical matter, EPA anticipates that the management measure set forth above generally will be implemented by applying one or more management practices appropriate to the source, location, and climate. The practices set forth below have been found by EPA to be representative of the types of practices that can be applied successfully to achieve the management measure described above.

Practices for the control of erosion and sediment loss are discussed in Chapter 4 of this guidance and should be considered applicable to this management measure. Erosion controls are used to reduce the amount of sediment that is lost during dam construction and to prevent sediment from entering surface waters. Erosion control is based on two main concepts: (1) minimizing the area and time of land disturbance and (2) stabilizing disturbed soils to prevent erosion. The following practices have been found to be useful in these purposes and should be incorporated into ESC plans and used during dam construction as appropriate.

Additional discussions of the practices described below can be found in Chapter 4 of this guidance and should be referred to for more information.

■ a. *Preserve trees and other vegetation that already exist near the dam construction site.*

This practice retains soil and limits runoff. The destruction of existing onsite vegetation can be minimized by initially surveying the site to plan access routes, locations of equipment storage areas, and the location and alignment of the dam. Construction workers should be encouraged to limit activities to designated areas. Reducing the disturbance of vegetation also reduces the need for revegetation after construction is completed, including the required fertilization, replanting, and grading that are associated with revegetation. Additionally, as much natural vegetation as possible should be left next to the waterbody where construction is occurring. This vegetation provides a buffer to reduce the NPS pollution effects of runoff originating from areas associated with the construction activities.

■ b. *Control runoff from the construction site and construction-related areas.*

The largest surface water pollution problem during construction is turbidity resulting from aggregate processing, excavation, and concrete work. Preventing the entry of these materials into surface waters is always the preferable alternative because runoff due to these activities can adversely affect drinking water supplies, irrigation systems, and river ecology (Peters, 1978). If onsite treatment is necessary, methods are available to control the runoff of sediment

and wastewater from the construction site. Sedimentation in settling ponds, sometimes with the addition of chemical precipitating agents, is one such method (Peters, 1978). Flocculation, the forced coagulation of fine-grained sediment through agitation to settle particles out of solution, is another method. Chemical precipitating agents can also be used in this flocculation process (Peters, 1978). Filtration with sand, anthracite, diatomaceous earth, or finely woven material, used singly or in combination, may be more useful than other methods for coarser grained materials (Peters, 1978).

■ c. *Control soil and surface water runoff during construction.*

To prevent the entry of sediment used during construction into surface waters, the following precautionary steps should be followed: identify areas with steep slopes, unstable soils, inadequate vegetation density, insufficient drainage, or other conditions that give rise to a high erosion potential; and identify measures to reduce runoff from such areas if disturbance of these areas cannot be avoided (Hynson et al., 1985). Refer to Chapter 4 for additional information.

Runoff control measures, mechanical sediment control measures, grassed filter strips, mulching, and/or sediment basins should be used to control runoff from the construction site. Scheduling construction during drier seasons, exposing areas for only the time needed for completion of specific activities, and avoiding stream fording also help to reduce the amount of runoff created during construction. Refer to Chapter 4 for additional information.

■ d. *Other practices*

Many other practices for the control of erosion and sediment loss are discussed in Chapter 4 of this guidance, which should be referred to for a complete discussion where noted. Below are brief descriptions of some of the other practices.

- **Revegetation.** Revegetation of construction sites during and after construction is the most effective way to permanently control erosion (Hynson et al., 1985). Many erosion control techniques are also intended to expedite revegetation.
- **Mulching.** Various mulching techniques are used in erosion control, such as use of straw, wood chip, or stone mulches; use of mulch nets or blankets; and hydromulching (Hynson et al., 1985). Mulching is used primarily to reduce the impact of rainfall on bare soil, to retain soil moisture, to reduce runoff, and often to protect seeded slopes (Hynson et al., 1985).
- **Soil Bioengineering.** Soil bioengineering techniques can be used to address the erosion resulting from dam operation. Grading or terracing a problem stream bank or eroding area and using interwoven vegetation mats, installed alone or in combination with structural measures, will facilitate infiltration stability. Refer to the section on shore protection in this chapter for additional information.

5. Effectiveness for All Practices

The effectiveness of erosion control practices can vary based on land slope, the size of the disturbed area, rainfall frequency and intensity, wind conditions, soil type, use of heavy machinery, length of time soils are exposed and unprotected, and other factors. In general, a system of erosion and sediment control practices can more effectively reduce offsite sediment transport than a single system. Numerous nonstructural measures such as protecting natural or newly planted vegetation, minimizing the disturbance of vegetation on steep slopes and other highly erodible areas, maximizing the distance eroded material must travel before reaching the drainage system, and locating roads away from sensitive areas may be used to reduce erosion. Chapter 4 has additional information for effectiveness of the practices listed above.

6. Costs for All Practices

Chapter 4 of this guidance contains the available cost data for most of the erosion controls listed above. Costs in Chapter 4 have been broken down into annual capital costs, annual maintenance costs, and total annual costs (including annualization of capital costs).

B. Management Measure for Chemical and Pollutant Control

- (1) Limit application, generation, and migration of toxic substances;
- (2) Ensure the proper storage and disposal of toxic materials; and,
- (3) Apply nutrients at rates necessary to establish and maintain vegetation without causing significant nutrient runoff to surface waters.

1. Applicability

This management measure is intended to be applied by States to the construction of new dams, as well as to construction activities associated with the maintenance of dams. Dams are defined³ as constructed impoundments which are either:

- (a) 25 feet or more in height *and* greater than 15 acre-feet in capacity, or
- (b) 6 feet or more in height *and* greater than 50 acre-feet in capacity.

This management measure addresses fuel and chemical spills associated with dam construction, as well as concrete washout and related construction activities. Under the Coastal Zone Act Reauthorization Amendments of 1990, States are subject to a number of requirements as they develop coastal NPS programs in conformity with this measure and will have some flexibility in doing so. The application of management measures by States is described more fully in *Coastal Nonpoint Pollution Control Program: Program Development and Approval Guidance*, published jointly by the U.S. Environmental Protection Agency (EPA) and the National Oceanic and Atmospheric Administration (NOAA) of the U.S. Department of Commerce.

2. Description

The purpose of this management measure is to prevent downstream contamination from pollutants associated with dam construction activities.

Although suspended sediment is the major pollutant generated at a construction site (USEPA, 1973), other pollutants include:

- Pesticides - insecticides, fungicides, herbicides, rodenticides;
- Petrochemicals - oil, gasoline, lubricants, asphalt;
- Solid wastes - paper, wood, metal, rubber, plastic, roofing materials;

³ This definition is consistent with the Federal definition at 33 CFR 222.8(h)(1) (1991).

- Construction chemicals - acids, soil additives, concrete-curing compounds;
- Wastewater - aggregate wash water, herbicide wash water, concrete-curing water, core-drilling wastewater, or clean-up water from concrete mixers;
- Garbage;
- Cement;
- Lime;
- Sanitary wastes; and
- Fertilizers.

A complete discussion of these pollutants can be found in Chapter 4 of this guidance.

3. Management Measure Selection

This management measure was selected because most erosion and sediment control practices are ineffective at retaining soluble NPS pollutants on a construction site. Many of the NPS pollutants, other than suspended sediment, generated at a construction site are carried offsite in solution or attached to clay particles in runoff (USEPA, 1973). Some metals (e.g., manganese, iron, and nickel) attach to sediment and usually can be retained onsite. Other metals (e.g., copper, cobalt, and chromium) attach to fine clay particles and have greater potential to be carried offsite. Insoluble pollutants (e.g., oils, petrochemicals, and asphalt) form a surface film on runoff water and can be easily washed away (USEPA, 1973).

A number of factors that influence the pollution potential of construction chemicals have been identified (USEPA, 1973). These include:

- The nature of the construction activity;
- The physical characteristics of the construction site; and
- The characteristics of the receiving water.

Dam construction sites are particularly sensitive areas and have the potential to severely impact surface waters with runoff containing construction chemical pollutants. Because dams are located on rivers or streams, pollutants generated at these construction sites have a much shorter distance to travel before entering surface waters. Therefore, chemicals and other NPS pollutants generated at a dam construction site should be controlled.

4. Practices

As explained more fully at the beginning of this chapter and in Chapter 1, the following practices are described for illustrative purposes only. State programs need not require the implementation of these practices. However, as a practical matter, EPA anticipates that the management measure set forth above generally will be implemented by applying one or more management practices appropriate to the source, location, and climate. The practices set forth below have been found by EPA to be representative of the types of practices that can be applied successfully to achieve the management measure described above.

Practices for the control of erosion and sediment loss are discussed in Chapter 4 of this guidance and should be considered applicable to this management measure.

- a. *Develop and implement a spill prevention and control plan. Agencies, contractors, and other commercial entities associated with the dam construction project that store, handle, or transport fuel, oil, or hazardous materials should have a spill response plan, especially if large quantities of oil or other polluting liquid materials are used.*

Spill procedure information should be posted, and persons trained in spill handling should be onsite or on call at all times. Materials for cleaning up spills should be kept onsite and easily available. Spills should be cleaned up immediately and the contaminated material properly disposed of. Spill control plan components should include (Peters, 1978):

- Stopping the source of the spill;
- Containing any liquid;
- Covering the spill with absorbent material such as kitty litter or sawdust, but do not use straw; and
- Disposing of the used absorbent properly.

- b. *Maintain and wash equipment and machinery in confined areas specifically designed to control runoff.*

Thinners or solvents should not be discharged into sanitary or storm sewer systems, or surface water systems, when cleaning machinery. Use alternative methods for cleaning larger equipment parts, such as high-pressure, high-temperature water washes or steam cleaning. Equipment-washing detergents can be used and wash water discharged into sanitary sewers if solids are removed from the solution first. Small parts should be cleaned with degreasing solvents that can then be reused or recycled. Do not discharge or otherwise dispose of any solvents into sewers, or into surface waters.

Washout from concrete trucks should be disposed of into:

- A designated area that will later be backfilled;
- An area where the concrete wash can harden, can be broken up, and can then be placed in a dumpster; or
- A location not subject to surface water runoff and more than 50 feet away from a receiving water.

Never dump washout directly into surface waters or into a drainage leading to surface waters.

- c. *Establish fuel and vehicle maintenance staging areas located away from surface waters and all drainages leading to surface waters, and design these areas to control runoff.*
- d. *Store, cover, and isolate construction materials, refuse, garbage, sewage, debris, oil and other petroleum products, mineral salts, industrial chemicals, and topsoil to prevent runoff of pollutants and contamination of ground water.*

C. Management Measure for Protection of Surface Water Quality and Instream and Riparian Habitat

Develop and implement a program to manage the operation of dams in coastal areas that includes an assessment of:

- (1) Surface water quality and instream and riparian habitat and potential for improvement and
- (2) Significant nonpoint source pollution problems that result from excessive surface water withdrawals.

1. Applicability

This management measure is intended to be applied by States to dam operations that result in the loss of desirable surface water quality, and of desirable instream and riparian habitat. Dams are defined⁴ as constructed impoundments which are either:

- (a) 25 feet or more in height *and* greater than 15 acre-feet in capacity, or
- (b) 6 feet or more in height *and* greater than 50 acre-feet in capacity.

This measure does not apply to projects that fall under NPDES jurisdiction. This measure also does not apply to the extent that its implementation under State law is precluded under *California v. Federal Energy Regulatory Commission*, 110 S. Ct. 2024 (1990) (addressing the supersedence of State instream flow requirements by Federal flow requirements set forth in FERC licenses for hydroelectric power plants under the Federal Power Act).

Under the Coastal Zone Act Reauthorization Amendments of 1990, States are subject to a number of requirements as they develop coastal NPS programs in conformity with this measure and will have some flexibility in doing so. The application of management measures by States is described more fully in *Coastal Nonpoint Pollution Control Program: Program Development and Approval Guidance*, published jointly by the U.S. Environmental Protection Agency (EPA) and the National Oceanic and Atmospheric Administration (NOAA) of the U.S. Department of Commerce.

2. Description

The purpose of this management measure is to protect the quality of surface waters and aquatic habitat in reservoirs and in the downstream portions of rivers and streams that are influenced by the quality of water contained in the releases (tailwaters) from reservoir impoundments. Impacts from the operation of dams to surface water quality and aquatic and riparian habitat should be assessed and the potential for improvement evaluated. Additionally, new upstream and downstream impacts to surface water quality and aquatic and riparian habitat caused by the implementation of practices should also be considered in the assessment. The overall program approach is to

⁴ This definition is consistent with the Federal definition at 33 CFR 222.8(h)(1) (1991).

evaluate a set of practices that can be applied individually or in combination to protect and improve surface water quality and aquatic habitat in reservoirs, as well as in areas downstream of dams. Then, the program should implement the most cost-effective operations to protect surface water quality and aquatic and riparian habitat and to improve the water quality and aquatic and riparian habitat where economically feasible.

A variety of approaches have been developed and tested for their effectiveness at improving or maintaining acceptable levels of dissolved oxygen, temperature, phosphorus, and other constituents in reservoirs and tailwaters.

One general method uses pumps, air diffusers, or air lifts to induce circulation and mixing of the oxygen-poor, but cold hypolimnion with the oxygen-rich, but warm epilimnion. The desired result is a more thermally uniform reservoir with increased dissolved oxygen (DO) in the hypolimnion. Reservoir mixing improves water quality both in the reservoir and in tailwaters and helps to maintain the temperatures required by warm-water fisheries.

Another approach to improving water quality in tailwaters is appropriate if trout fisheries are desired downstream. In this approach, air or oxygen is mixed with water passing through the turbines of hydropower dams to increase the concentration of DO. Air or oxygen can be selectively added to impoundment waters entering turbine intakes. Reservoir waters can also be aerated by venting turbines to the atmosphere or by injecting compressed air into the turbine chamber.

A third group of approaches include engineering modifications to the intakes, the spillway, or the tailrace, or the installation of various types of weirs downstream of the dam to improve temperature or DO levels in tailwaters. These practices rely on agitation and turbulence to mix the reservoir releases with atmospheric air in order to increase the concentrations of dissolved oxygen. Selective withdrawal of water from different depths allows dam operators to maintain desired temperatures for fish and other aquatic species in downstream surface waters.

The quality of reservoir releases can also be improved through adjustments in the operational procedures at dams. These include scheduling releases or the duration of shutoff periods, instituting procedures for the maintenance of minimum flows, and making seasonal adjustments in the pool levels and in the timing and variation of the rate of drawdown.

Dam operators such as the Tennessee Valley Authority (TVA) further recognize the need for watershed management as a valuable tool to reduce water quality problems in reservoirs and dam releases. Reducing NPS pollutants coming from watersheds surrounding reservoirs can have a beneficial effect on concentrations of DO and pollutants within a reservoir and its tailwaters.

There is also a need for riparian habitat maintenance and restoration in the areas around the impounded reservoir and downstream from a dam. Reservoir shorelines are important riparian areas, and they need to be managed or restored to realize their many riparian habitat and water quality benefits. Examples of downstream aquatic habitat improvements include maintaining minimum instream flows, providing scouring flows when and where needed, providing alternative spawning areas or fish passage, protecting streambanks from erosion, and maintaining wetlands and riparian areas.

The individual application of any particular technique, such as aeration, change in operational procedure, restoration of an aquatic or riparian habitat, or implementation of a watershed protection best management practice (BMP), will, by itself, probably not improve water quality to an acceptable level within the reservoir impoundment or in tailwaters flowing through downstream areas. The individual practices discussed in this portion of the guidance will usually have to be implemented in some combination in order to raise water quality in the impoundment or in tailwaters to acceptable levels.

One such combination of practices has addressed low DO levels at the Canyon Dam (Guadalupe River, Texas). A combination of turbine venting and a downstream weir was used to increase DO levels to acceptable levels. The concentration of dissolved oxygen in water entering the dam was measured at 0.5 mg/L. After passing through the

turbine (but still upstream of the aeration weir), the DO concentration was raised to 3.3 mg/L. The concentration of the same water after passing through the aeration weir was 6.7 mg/L (EPRI, 1990).

Another combination of practices, consisting of a vacuum breaker turbine venting system and a stream flow reregulation weir, has been implemented at Norris Dam (Clinch River, Tennessee). The vacuum breaker aeration system uses hub baffles and appears to be the most successful design (EPRI, 1990). The baffles induce enough air to add from 2 mg/L to 4 mg/L to the discharge, while reducing turbine efficiency less than 0.5 percent. The downstream weir retains part of the discharge from the turbines when they are not in operation to sustain a stream flow of about 200 cubic feet per second (cfs). Prior to these improvements, the tailwaters of the Norris Dam had DO levels below 6 mg/L an average of 131 days per year and DO levels below 3 mg/L an average of 55 days per year. After installation of the turbine venting system and reregulation weir, DO levels were below 6 mg/L only 55 days per year and were above 3 mg/L at all times (TVA, 1988).

Combinations of increased flow, stream aeration, and wasteload reduction (from municipal and industrial sources) were found to be necessary to treat releases from the Fort Patrick Henry Dam (Holston River, Tennessee). An unsteady state flow and water quality model was used to simulate concentrations of dissolved oxygen in the 20-mile downstream reach from Fort Patrick Henry Dam and to explore water quality management alternatives. Several pollution abatement options were considered to identify the most cost-effective alternative. These options included changing wasteloads of the various dischargers, varying the flows from the reservoir, and improving aeration levels in water leaving the reservoir and in areas downstream. The modeling study identified flow regime modifications as more effective in improving DO than wasteload modifications. However, a decision to increase flow from the dam when stream levels are low might result in unacceptable reservoir drawdown in dry years. Although at some projects the increased DO will persist for many miles, improvements that were predicted by aeration of dam releases diminished rapidly at this particular site because they decreased the DO deficit and reduced natural reaeration rates. No wasteload treatments short of total recycle would achieve the 5-mg/L standard under base conditions (Hauser and Ruane, 1985).

3. Management Measure Selection

Selection of this management measure was based on:

- (1) The availability and demonstrated effectiveness of practices to improve water quality in impoundments and in tailwaters of dams and
- (2) The level of improvement in water quality of impoundments and tailwaters that can be measured from implementation of engineering practices, operational procedures, watershed protection approaches, or aquatic or riparian habitat improvements.

Successful implementation of the management measure will generally involve the following categories of practices undertaken individually or in combination to improve water quality and aquatic and riparian habitat in reservoir impoundments and in tailwaters:

- Artificial destratification and hypolimnetic aeration of reservoirs with deep withdrawal points that do not have multilevel outlets to improve dissolved oxygen levels in the impoundment and to decrease levels of other types of nonpoint source pollutants, such as manganese, iron, hydrogen sulfide, methane, ammonia, and phosphorus in reservoir releases (Cooke and Kennedy, 1989; Henderson and Shields, 1984);
- Aeration of reservoir releases, through turbine venting, injection of air into turbine releases, installation of reregulation weirs, use of selective withdrawal structures, or modification of other turbine start-up or pulsing procedures (Hauser and Ruane, 1985; Henderson and Shields, 1984);
- Providing both minimum flows to enhance the establishment of desirable instream habitat and scouring flows as necessary to maintain instream habitat (Kondolf et al., 1987; Walburg et al., 1981);

- Establishing adequate fish passage or alternative spawning ground and instream habitat for fish species (Andrews, 1988); and
- Improving watershed protection by installing and maintaining BMPs in the drainage area above the dam to remove phosphorus, suspended sediment, and organic matter and otherwise improve the quality of surface waters flowing into the impoundment (Kortmann, 1989).

4. Introduction to Practices

As discussed more fully at the beginning of this chapter and in Chapter 1, the following practices are described for illustrative purposes only. State programs need not require the implementation of these practices. However, as a practical matter, EPA anticipates that the management measure set forth above generally will be implemented by applying one or more management practices appropriate to the source, location, and climate. The practices set forth below have been found by EPA to be representative of the types of practices that can be applied successfully to achieve the management measure described above.

5. Practices for Aeration of Reservoir Waters and Releases

The systems that have been developed and tested for reservoir aeration rely on atmospheric air, compressed air, or liquid oxygen to increase concentrations of dissolved oxygen in reservoir waters before they pass through the dam. Depending on the method selected, aeration can accomplish thorough mixing throughout the impoundment. However, this practice has not been used at large hydropower reservoirs because of the cost associated with aerating these large-flow reservoirs. Aeration will elevate levels of DO, but also will usually redistribute higher concentrations of algae found in the shallower depths and nutrients that are normally restricted to the deeper waters. It is not always desirable to have waters containing higher levels of algae and nutrients released into portions of the waterway below the dam (Kortmann, 1989). If the principal objective is to improve DO levels only in the reservoir releases and not throughout the entire impoundment, then aeration can be applied selectively to discrete layers of water immediately surrounding the intakes or as water passes through release structures such as hydroelectric turbines.

■ a. *Pumping and Injection Practices*

One method for deployment of circulation pumps is the U-tube design, in which water from deep in the impoundment is pumped to the surface layer. The inducement of artificial circulation through aeration of the impoundment may also provide the opportunity for a "two-story" fishery, reduce internal phosphorus loading, and eliminate problems with iron and manganese in drinking water (Cooke and Kennedy, 1989).

Air injection systems operate in a manner similar to that of pumping systems to mix water from different strata in the impoundment, except that air or pure oxygen is injected into the pumping system (Henderson and Shields, 1984). These kinds of systems are divided into two categories: partial air lift systems and full air lift systems. In the partial air lift system, compressed air is injected at the bottom of the unit; then, the air and water are separated at depth and the air is vented to the surface. In the full air lift system, compressed air is injected at the bottom of the unit (as in the partial air lift system), but the air-water mixture rises to the surface (Figure 6-3). The full air lift design has a higher efficiency than the partial-air lift and has a lesser tendency to elevate dissolved nitrogen levels (Cooke and Kennedy, 1989).

Diffused air systems provide effective transfer of oxygen to water by forcing compressed air through small pores in systems of diffusers to form bubbles (Figure 6-4). One test of a diffuser system in the Delaware River near Philadelphia, Pennsylvania, in 1969-1970 demonstrated the efficiency of this practice. Coarse-bubble diffusers were deployed at depths ranging from 13 to 38 feet. Depending on the depth of deployment, the oxygen transfer efficiency varied from 1 to 12 percent. When compared with other systems discussed below, this efficiency

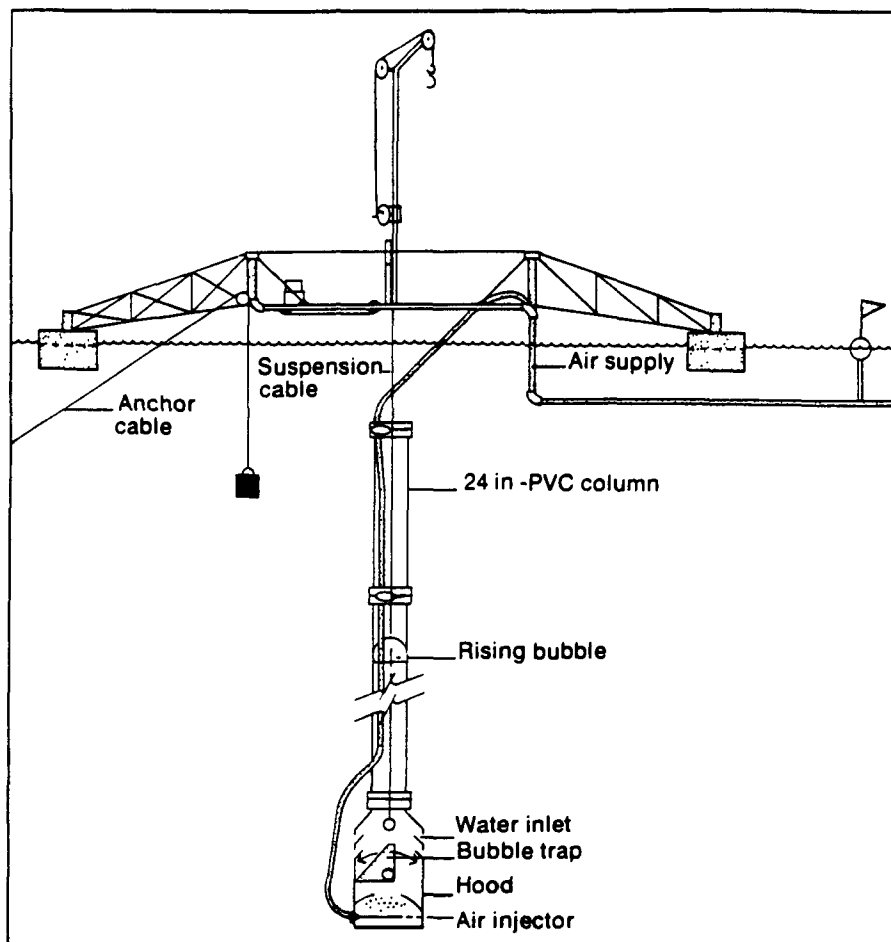

Figure 6-3. Air injection system for reservoir aeration-destratification (Nelson et al., 1978).

rate is rather low. But the results of this particular test determined that river aeration was more economical than advanced wastewater treatment as a strategy for improving the levels of DO in the river (EPRI, 1990).

Mechanical agitation systems operate by pumping water from the reservoir into a splash basin on shore, where it is aerated and then returned to the hypolimnion. Although these types of systems are comparatively inefficient, they have been used successfully (Wilhelms and Smith, 1981).

Localized mixing is a practice to improve releases of thermally stratified reservoirs by destratifying the reservoir in the immediate vicinity of the outlet structure. This practice differs from the practice of artificial destratification, where mixing is designed to destratify all or most of the reservoir volume (Holland, 1984). Localized mixing is provided by forcing a jet of high-quality surface water downward into the hypolimnion. Pumps used to create the jet generally fall into two categories, axial flow propellers and direct drive mixers (Price, 1989). Axial flow pumps usually have a large-diameter propeller (6 to 15 feet) that produces a high-discharge, low-velocity jet. Direct drive mixers have small propellers (1 to 2 feet) that rotate at high speeds and produce a high-velocity jet. The axial flow pumps are suitable for shallow reservoirs because they can force large quantities of water down to shallow depths. The high-momentum jets produced by direct drive mixers are necessary to penetrate deeper reservoirs (Price, 1989).

Water pumps have been used to move surface water containing higher concentrations of DO downward to mix with deeper waters as the two strata are entering the turbine. Aspirating surface aerators deployed in Lake Texoma

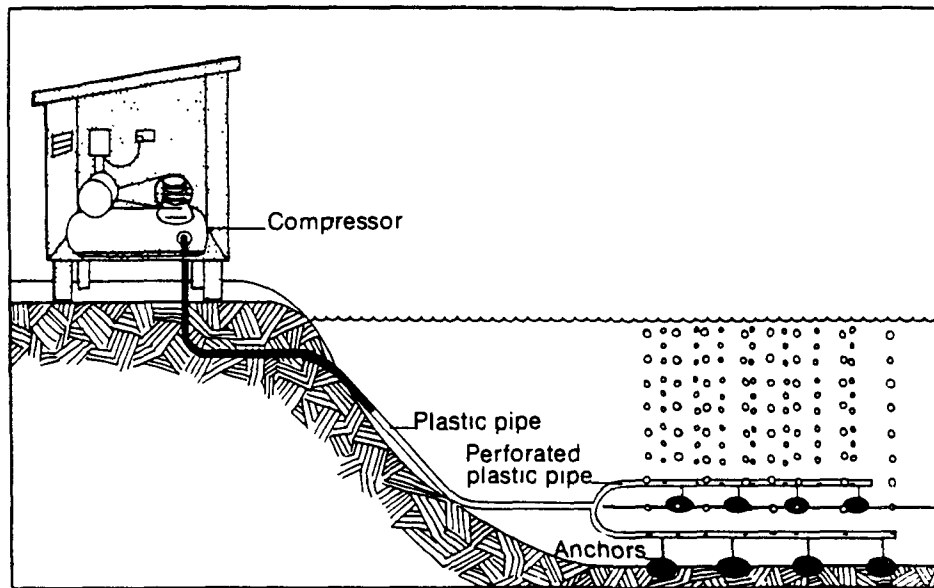

Figure 6-4. Compressed air diffusion system for reservoir aeration-destratification (Nelson et al., 1978).

(Texas/Oklahoma border) raised the levels of DO in the tailwaters from concentrations of 1.8 mg/L (without aerators) to 2.0 mg/L (with one 5-hp aeration unit in operation) and to 2.6 mg/L (with three 5-hp units operating).

A test of large-diameter axial-flow surface water pumps at Bagnell Dam (Lake of the Ozarks, Missouri) increased DO levels in the reservoir releases from 1.3 mg/L to 3.6 mg/L, before maintenance problems caused a discontinuance of use of the pumps (EPRI, 1990).

Small-diameter surface pumps, operated at the J. Percy Priest Dam (Tennessee), increased the DO levels in the tailwaters to 4.0 mg/L from a background level of 2.7 mg/L (EPRI, 1990).

Oxygen injection systems use pure oxygen to increase levels of dissolved oxygen in reservoirs. One type of design, termed side stream pumping, carries water from the impoundment onto the shore and through a piping system into which pure oxygen is injected. After passing through this system, the water is returned to the impoundment. Another type of system, which pumps gaseous oxygen into the hypolimnion through diffusers, has effectively improved DO levels in the reservoir behind the Richard B. Russell Dam (Savannah River, on the Georgia-South Carolina border). The system is operated 1 mile upstream of the dam, with occasional supplemental injection of oxygen at the dam face when DO levels are especially low. The system has successfully maintained DO levels above 6 mg/L in the releases, with an average oxygen transfer efficiency of 75 percent (EPRI, 1990; Gallagher and Mauldin, 1987).

The TVA has been testing the use of pure oxygen at the Douglas Dam (French Broad River, Tennessee) since 1988 (TVA, 1988). The absorption efficiencies measured in the downstream tailwaters range from 30 to 50 percent when the diffusers are arranged in a loose arc around the intakes. When the diffusers are placed tightly around the intakes, the efficiency range improves to 72 to 76 percent.

In another test at facilities operated by the Tennessee Valley Authority, diffusers were deployed to inject high-purity oxygen near the bottom of the 70-foot-deep reservoir at Fort Patrick Henry Dam (Holston River, Tennessee) near one of the turbine intakes. Levels of DO in the tailwaters increased from near 0 mg/L to 4 mg/L as a result of operation of this aeration system. Unfortunately, the operation costs of this kind of system were determined to be

relatively high (Harshbarger, 1987). However, these results were very site-specific and every site needs to be evaluated for the best mix of solutions.

■ b. Turbine Venting

Turbine venting is the practice of injecting air into water as it passes through a turbine. If vents are provided inside the turbine chamber, the turbine will aspirate air from the atmosphere and mix it with water passing through the turbine as part of its normal operation. In early designs, the turbine was vented through existing openings, such as the draft tube opening or the vacuum breaker valve in the turbine assembly. Air forced by compressors into the draft tube opening enriched reservoir waters with little detectable DO to concentrations of 3 to 4 mg/L. Overriding the automatic closure of the vacuum breaker valve (at high turbine discharges) increased DO by only 2 mg/L (Harshbarger, 1987).

Turbine venting makes use of the low-pressure region just below the turbine wheel to aspirate air into the discharges (Wilhelms, 1984). Autoventing turbines are constructed with hub baffles, or deflector plates placed on the turbine hub upstream of the vent holes to enhance the low-pressure zone in the vicinity of the vent and thereby increase the amount of air aspirated through the venting system (Figure 6-5). Turbine efficiency relates to the amount of energy output from a turbine per unit of water passing through the turbine. Efficiency decreases as less power is produced for the same volume of water. In systems where the water is aerated before passing through the turbine, part of the water volume is displaced by the air, thus leading to decreased efficiency. Hub baffles have also been added to autoventing turbines at the Norris Dam to further improve the DO levels in the turbine releases (Jones and March, 1991).

Recent developments in autoventing turbine technology show that it may be possible to aspirate air with no resulting decrease in turbine efficiency. In one test of an autoventing turbine at the Norris Dam (Clinch River, Tennessee), the turbine efficiency increased by 1.8 percent (March et al., 1991; Waldrop, 1992). Technologies like autoventing turbines are very site-specific and outcomes will vary considerably. Achievement of desired DO levels at specific projects may require evaluation of several different technologies.

6. Practices to Improve Oxygen Levels in Tailwaters

In addition to the pumping and injection systems for reservoir aeration discussed in the preceding section, another set of systems can accomplish the aeration of water as it passes through the dam or through the portion of the waterway immediately downstream from the dam. The systems in this category rely on agitation and turbulence to mix the reservoir releases with atmospheric air in order to increase the concentrations of dissolved oxygen. Another approach involves the increased use of spillways, which release surface water to prevent it from overtopping the dam. The third approach is to install barriers called weirs in the downstream areas. Weirs designed to allow water to overtop them can increase DO through surface agitation and increased surface area contact. Some systems create supersaturation of dissolved gases and may require additional modifications to prevent supersaturation.

Two factors should be considered when evaluating the suitability of hydraulic structures such as spillways and weirs for their application in raising the DO concentration in waterways:

- Most of the measurements of DO increases associated with hydraulic structures have been collected at low-head facilities. The effectiveness of these devices may be limited as the level of discharge increases (Wilhelms, 1988).
- The hydraulic functioning of these types of structures should be carefully considered since undesirable flow conditions may occur in some instances (Wilhelms, 1988).

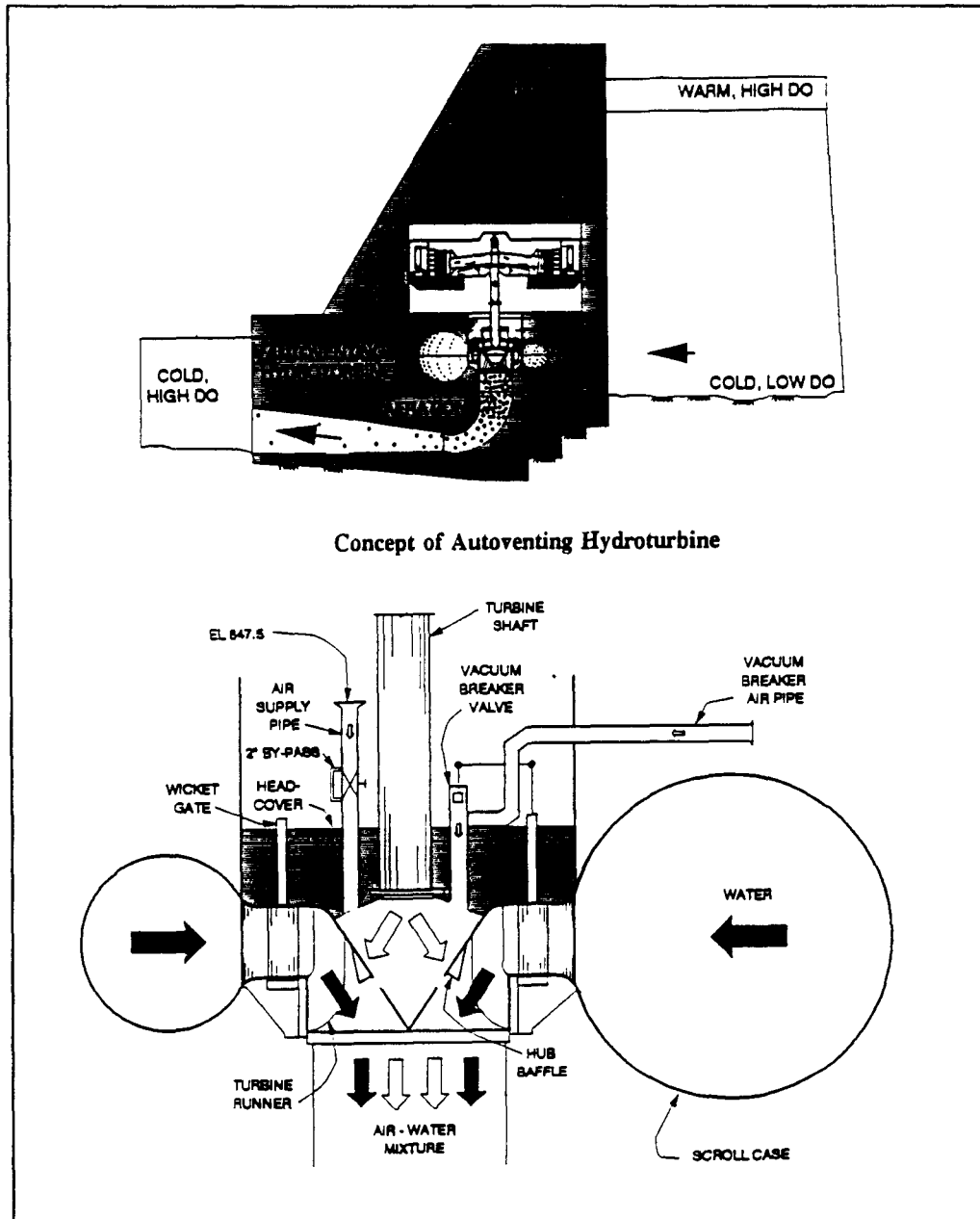

Figure 6-5. Top: Schematic drawing of an autoventing turbine. Bottom: Sketch of the hub baffle system used in the autoventing turbines at Norris Dam (French Broad River), Tennessee.(TVA-Engineering Laboratory, 1991.)

a. Gated Conduits

Gated conduits are hydraulic structures that divert the flow of water under the dam. They are designed to create turbulent mixing to enhance the rest of the oxygen transfer. Gates are used to control the cross-sectional area of flow. Gated conduits have been extensively analyzed for their performance and effectiveness (Wilhelms and Smith, 1981), although the available data are mostly from high-head projects (Wilhelms, 1988). In modeling studies, gated conduit structures have been found to achieve 90 percent aeration and a minimum DO standard of 5 mg/L (Wilhelms and Smith, 1981).

■ b. Spillways

The U.S. Army Corps of Engineers has studied the performance of spillways and overflow weirs at its facilities to determine the importance of these structures in improving DO levels. Increases in DO concentration of about 2.5 mg/L have been measured at the overflow weir of the Jonesville Lock and Dam (Ouachita River, Louisiana) (Wilhelms, 1988). Increases in DO concentrations of 3 mg/L have been measured at the overflow weir of the Columbia Lock and Dam (Ouachita River, Louisiana). Passage of water through the combinations of spillways and overflow weirs at these two facilities resulted in DO saturation levels of 85 to 95 percent in downstream waters (Wilhelms, 1988).

■ c. Spillway Modifications

At the Tellico Dam (Little Tennessee River, Tennessee), a siphon/underwater barrier dam was installed to improve DO and temperature conditions in the releases. The installed siphon draws about 8 cfs of cool water from the reservoir over the spillway into the Little Tennessee River. During the summer, the water forms a pool behind a 6-ft high underwater barrier dam and creates the temperature and oxygen concentrations needed by striped bass. The fish attracted to the pool provide a desirable sport fishery for the community (TVA, 1988).

The operation of some types of hydraulic structures has been tied to problems stemming from the supersaturation of some types of gases. An unexpected fish kill occurred in spring 1978 due to supersaturation of nitrogen gas in the Lake of the Ozarks (Missouri) within 5 miles of Truman Dam, caused by water plunging over the spillway and entraining air. The vertical drop between the spillway crest and the tailwaters was only 5 feet. The maximum saturation was 143 percent. In this case, the spillway was modified by cutting a notch to prevent water from plunging directly into the stilling basin (ASCE, 1986). At dams along the Columbia and Snake Rivers of the western United States, spillway deflectors have been found to be the most effective means for reducing nitrogen supersaturation (Bonneville Power Administration, 1991). The deflectors are designed to direct flows horizontally into the stilling basin to prevent deep plunging and air entrainment (ASCE, 1986).

Spill at hydroelectric dams is routinely required during periods of high runoff when the river discharge exceeds what can be passed through the powerhouse turbines. The Columbia River of Washington State has a series of 11 dams beginning with the Grand Coulee and ending with Bonneville. The Snake River also has four dams. If all of these dams were spilling simultaneously, the entire river would become and remain highly saturated with nitrogen gas since the water would pick up gas at each successive spilling project. The Corps of Engineers has proposed several practices for solving the gas supersaturation problem. These include (1) passing more headwater storage through turbines, installing new fish bypass structures, and installing additional power units to reduce the need for spill; (2) incorporating "flip-lip" deflectors in spillway-stilling basins (Figure 6-6), transferring power generation to high-dissolved-gas-producing dams, and altering spill patterns at individual dams to minimize nitrogen mass entrainment; and (3) collecting and transporting juvenile salmonids around affected river reaches. Only a few of these practices have been implemented (Tanovan, 1987).

■ d. Reregulation Weir

Reregulation weirs have been constructed from stone, wood, and aggregate. In addition to increasing the levels of DO in the tailwaters, reregulation weirs result in a more constant rate of flow farther downstream during periods when turbines are not in operation. A reregulation weir constructed downstream of the Canyon Dam (Guadalupe River, Texas) increased DO levels in waters leaving the turbine from 3.3 mg/L to 6.7 mg/L (EPRI, 1990).

The U.S. Army Corps of Engineers Waterways Experiment Station (Wilhelms, 1988) has compared the effectiveness with which various hydraulic structures accomplished the reaeration of reservoir releases. The study concluded that, whenever operationally feasible, more discharge should be passed over weirs to improve DO concentrations in releases. Although additional field tests are planned, current results indicate that overflow weirs aerate releases more effectively than low-sill spillways (Wilhelms, 1988).

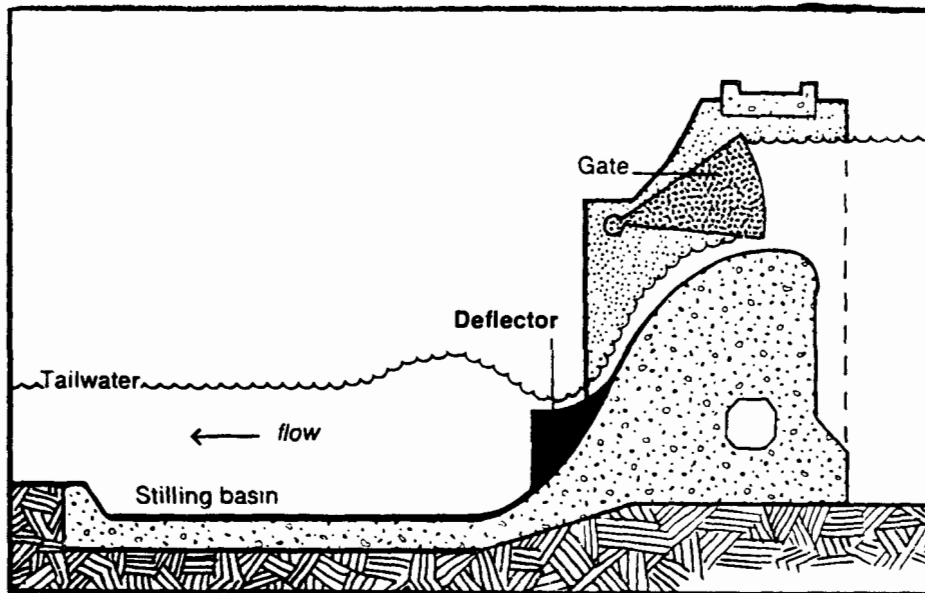

Figure 6-6. Cross section of a spillway with a "flip-lip" deflector (Nelson et al., 1978).

■ e. Labyrinth Weir

Labyrinth weirs have extended crest length and are usually W-shaped. These weirs spread the flow out to prevent dangerous undertows in the plunge pool. A labyrinth weir at South Holston Dam (Figure 6-7) was constructed for the dual purpose of providing minimum flows and improving DO in reservoir releases. The weir aerates to up to 60 percent of the oxygen deficit. For instance, projected performance at the end of the summer is an increase in the DO from 3 mg/L to 7 mg/L (or an increase of 4 mg/L) (Gary Hauser, TVA, personal communication, 1992). Actual increases in the DO will depend on the temperature and the level of DO in the incoming water.

7. Practices for Adjustments in the Operational Procedures of Dams for Improvement of Water Quality

The quality of reservoir releases can be improved through adjustments in the operational procedures at dams. These include scheduling of releases or of the duration of shutoff periods, instituting procedures for the maintenance of minimum flows, making seasonal adjustments in the pool levels or in the timing and variation of the rate of drawdown, selecting the turbine unit that most increases DO (often increasing the DO levels by 1 mg/L), and operating more units simultaneously (often increasing DO levels by about 2 mg/L). The magnitude and duration of reservoir releases also should be timed and scheduled so that the salinity regime in coastal waters is not substantially altered from historical patterns.

■ a. Selective Withdrawal

Temperature control in reservoir releases depends on the volume of water storage in the reservoir, the timing of the release relative to storage time, and the level from which the water is withdrawn. Dams capable of selectively releasing waters of different temperatures can provide cooler or warmer water temperature downstream at times that are critical for other instream resources, such as during periods of fish spawning and development of fry (Fontane et al., 1981; Hansen and Crumrine, 1991). Stratified reservoirs are operated to meet downstream temperature objectives such as to enhance a cold-water or warm-water fishery or to maintain preproject stream temperature conditions. Release temperature may also be important for irrigation (Fontane et al., 1981).

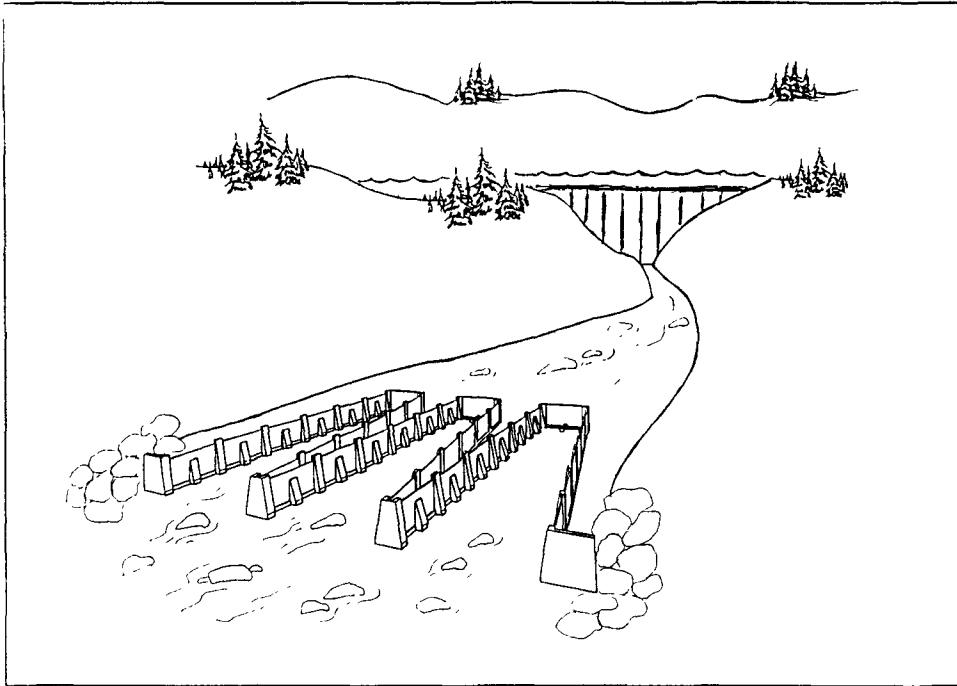

Figure 6-7. Three-bay labyrinth weir (Hauser et al., 1990).

Multilevel intake devices in storage reservoirs allow selective withdrawal of water based on temperature and DO levels. These devices minimize the withdrawal of surface water high in blue-green algae, or of deep water enriched in iron and manganese. Care should be taken in the design of these systems not to position the multilevel intakes too far apart because this will increase the difficulty with which withdrawals can be controlled, making the discharge of poor-quality hypolimnetic water more likely (Howington, 1990; Johnson and LaBounty, 1988; Smith et al., 1987).

■ b. Turbine Operation

Implementation of changes in the turbine start-up procedures can also enlarge the zone of withdrawal to include more of the epilimnetic waters in the downstream releases. Monitoring of the releases at the Walter F. George lock and dam (Chattahoochee River, Georgia), showed levels of DO declined sharply at the start-up of hydropower production. The severity and duration of the DO drop could be reduced by starting up all the generator units within a minute of each other (Findley and Day, 1987).

A useful tool for evaluating the effects of operational procedures on the quality of tailwaters is computer modeling. For instance, computer models can describe the vertical withdrawal zone that would be expected under different scenarios of turbine operation (Smith et al., 1987). Zimmerman and Dortch (1989) modeled release operations for a series of dams on a Georgia River and found that procedures that were maintaining cool temperatures in summer were causing undesirable decreases in DO and increases in dissolved iron in autumn. The suggested solution was a seasonal release plan that is flexible, depending on variations in the in-pool water quality and predicted local weather conditions. Care should be taken with this sort of approach to accommodate the needs of both the fishery resource and reservoir recreationalists, particularly in late summer.

Modeling has also been undertaken for a variety of TVA and Corps of Engineers facilities to evaluate the downstream impacts on DO and temperature that would result from changes in several operational procedures, including (Hauser et al., 1990a, 1990b; Higgins and Kim, 1982; Nestler et al., 1986b):

- Maintenance of minimum flows;
- Timing and duration of shutoff periods;

- Seasonal adjustments to the pool levels; and
- Timing and variation of the rate of drawdown.

8. Watershed Protection Practices

Most nonpoint source pollution problems in reservoirs and dam tailwaters frequently result from sources in the contributing watershed (e.g., sediment, nutrients, metals, and toxics). Management of pollution sources from a watershed has been found to be a cost-effective solution for improving reservoir and dam tailwater water quality (TVA, 1988). Practices for watershed management include land use planning, erosion control, ground-water protection, mine reclamation, NPS screening and identification, animal waste control, and failing septic tank control (TVA, 1988).

Another general watershed management practice involves the evaluation of the total watershed and the use of point/nonpoint source trading. Simply put, this practice involves the evaluation of the sources of pollution in a watershed and determination of the most cost-effective combination of practices to reduce pollution among the various point and nonpoint sources. Podar and others (1985) present an excellent example of point/nonpoint source trading as applied to the Holston River near Kingsport, Tennessee. Bender and others (1991) used modeling to evaluate the cost-effectiveness of various point/nonpoint source trading strategies for the Boone Reservoir in the upper Tennessee River Valley.

■ a. Land Use Planning

Land use plans that establish guidelines for permissible uses of land within a watershed serve as a guide for reservoir management programs addressing NPS pollution (TVA, 1988). Watershed land use plans identify suitable uses for land surrounding a reservoir, establish sites for economic development and natural resource management activities, and facilitate improved land management (TVA, 1988). Land use plans must be flexible documents that account for the needs of the landowners, State and local land use goals, the characteristics of the land and its ability to support various uses, and the control of NPS pollution (TVA, 1988). The watershed planning section of Chapter 4 contains additional information on land use planning.

■ b. Nonpoint Source Screening and Identification

The analysis and interpretation of stereoscopic color infrared aerial photographs can be used to find and map specific areas of concern where a high probability of NPS pollution exists from septic tank systems, animal wastes, soil erosion, and other similar types of NPS pollution (TVA, 1988). TVA has used this technique to survey about 25 percent of the Tennessee Valley to identify sources of nonpoint pollution in a period of less than 5 years at a cost of a few cents per acre (TVA, 1988).

■ c. Soil Erosion Control

Soil erosion has been determined to be the major source of suspended solids, nutrients, organic wastes, pesticides, and sediment that combined form the most problematic form of NPS pollution (TVA, 1988). Chapter 4 in this guidance contains an extensive selection of practices aimed at preventing soil erosion and controlling sediment from reaching surface waters in runoff.

■ d. Ground-Water Protection

Proper protection and management of ground-water resources primarily depends on the effective control of NPS pollution, particularly in ground-water recharge areas. Polluted ground water has the potential to contribute to surface-water pollution problems in reservoirs. Ground-water protection can be achieved only through public awareness of the problems associated with ground-water pollution and the potential of various activities to contaminate ground water. Identifying the ground-water resources in a watershed and developing a plan for

protection of these resources are critical in establishing a good ground-water protection program. TVA (1988) has found that an extensive public outreach program is instrumental in the development of an effective ground-water protection program and in eventual protection of the resource.

■ e. *Mine Reclamation*

Abandoned mines have the potential to contribute significant sediment, metals, acidified water, and other pollutants to reservoirs (TVA, 1988). Old mines need to be located and reclaimed to reduce the NPS pollutants emanating from them. Revegetation is a cost-effective method of reclaiming denuded strip-mined lands, and agencies such as the Soil Conservation Service can provide technical insight for revegetation practices.

■ f. *Animal Waste Control*

A major contributor to reservoir pollution in some watersheds is wastes from animal confinement facilities. TVA (1988) estimated that in the Tennessee Valley, farms produced about six times the organic wastes of the population of the valley. A cooperative program was established to address the animal waste problem in the Tennessee Valley. The results of demonstration facilities in the Tennessee Valley reduced NPS pollution from animal wastes by 25,000 tons in the Duck River basin. The program also had the benefit of reducing the additional input of 1,400 tons of nitrogen and 200 tons of phosphorus to farm fields (TVA, 1988). Refer to Chapter 2 of this guidance for additional information on animal waste control practices.

■ g. *Failing Septic Systems*

Failing septic tank or onsite sewage disposal systems (OSDS) are another source of NPS pollution in reservoirs. TVA has found septic tank failures to be a problem in some of its reservoirs and has identified them through an aerial survey (TVA, 1988). Additional information on OSDS practices can be found in Chapter 4.

9. Practices to Restore or Maintain Aquatic and Riparian Habitat

Studies like the one undertaken by the U.S. Department of the Interior (USDOI, 1988) on the Glen Canyon Dam (Colorado River, Colorado) illustrate the potential for disruption to downstream aquatic and riparian habitat resulting from the operation of dams.

Several options are available for the restoration or maintenance of aquatic and riparian habitat in the area of a reservoir impoundment or in portions of the waterway downstream from a dam. One set of practices is designed to augment existing flows that result from normal operation of the dam. These include operation of the facility to produce flushing flows, minimum flows, or turbine pulsing. Another approach to producing minimum flows is to install small turbines that operate continuously. Installation of reregulation weirs in the waterway downstream from the dam can also achieve minimum flows. Finally, riparian improvements are discussed for their importance and effectiveness in restoring or maintaining aquatic and riparian habitat in portions of the waterway affected by the location and operation of a dam.

■ a. *Flow Augmentation*

Operational procedures such as flow regulation, flood releases, or fluctuating flow releases all have a detrimental impact on downstream aquatic and riparian habitat. Confounding the problem of aquatic and riparian habitat restoration is necessary for a balance of operational procedures to address the needs of downstream aquatic and riparian habitat with the requirements of dam operation. There are often legal and jurisdictional requirements for an operational procedure at a particular dam that should be considered (USDOI, 1988).

A flushing flow is a high-magnitude, short-duration release for the purpose of maintaining channel capacity and the quality of instream habitat by scouring the accumulation of fine-grained sediments from the streambed. For example,

at Owens River in the Eastern Sierra Nevadas, California, a study found that wild salmonids prefer to deposit their eggs in streambed gravel free of fine sediments (Kondolf et al., 1987). Availability of suitable instream habitat is a key factor limiting spawning success. Flushing flows wash away the sediments without removing the gravel. Flushing flows also prevent the encroachment of riparian vegetation. According to a study of the Trinity River Drainage Basin in northwestern California (Nelson et al., 1987), remedial and maintenance flushing flows suppress riparian vegetation and maintain the stream channel dimensions necessary to provide instream habitat in addition to preventing large accumulations of sediment in river deltas. Recommendations for the use of flushing flows as part of an overall instream management program are becoming more common in areas downstream of water development projects in the western United States. For instance, Wesche and others (1987) used a sediment transport input-output model to determine the required flushing regimen for removing fine-grained sediments from portions of the Little Snake River that served as instream habitat for Colorado cutthroat trout. The flushing flows reduced the overall mass of sediment covering the channel bottom and removed the finer grained material, thereby increasing the size of the residual sediment forming the bottom streambed deposits.

However, it is important to keep in mind that flushing flows are not recommended in all cases. Flushing flows of a large magnitude may cause flooding in the old floodplain or depletion of gravel below the dam. Flushing flows are more efficient and predictable for small, shallow, high-velocity mountain streams unaltered by dams, diversions, or intensive land use. Routine maintenance generally requires a combination of practices including high flows coupled with sediment dams or channel dredging, rather than simply relying on flushing or scouring flows (Nelson et al., 1988).

Minimum flows are needed to keep streambeds wetted to an acceptable depth to support desired fish and wildlife. Since wetlands and riparian areas are linked hydrologically to adjoining streams, instream flows should be sufficient to maintain wetland or riparian habitat and function. Flushing and scouring flows may also be necessary to clean some streambeds and to provide the proper substrate for aquatic species.

In the design, construction, and operation of dams, the minimum flow requirements to support aquatic organisms and other water-dependent wildlife in downstream areas should be addressed. Minimum flow requirements are typically determined to protect or enhance one or a few harvestable species of fish (USDOI-FWS, 1976). Other fish, aquatic organisms, and riparian wildlife are usually assumed to be protected by these flows. For instance, when minimum flows at the Conowingo Dam (Susquehanna River, Maryland-Pennsylvania border) were increased from essentially zero to 5,000 cfs, up to a 100-fold increase was noted in the abundance of macroinvertebrates (USDOE, 1991). When minimum flows were increased from 1.0 cfs to 5.5 cfs at the Rob Roy Dam (Douglas Creek, Wyoming), there was a four- to six-fold increase in the number of brown trout (USDOE, 1991).

Flows at Rush Creek on the Eastern slope of the Sierra Nevadas in California have averaged about 50 percent of their prediversion levels (Stromberg and Patten, 1990). Since the construction of the Grant Lake Reservoir, the influence of flow rates and volumes on the growth of riparian trees has been studied. Stromberg and Patten (1990) found that a strong relationship exists between growth rates of riparian tree species and annual and prior-year flow volumes. If the level of growth needed to maintain populations is known, the relationship between growth and flow can be used to determine the instream flow needs of riparian vegetation. Instream models for Rush Creek suggest that requirements of riparian vegetation may be greater than requirements for fisheries.

Seasonal discharge limits can be established to prevent excessive, damaging rates of flow release. Limits can also be placed on the rate of change of flow and on the stage of the river (as measured at a point downstream of the dam facility) to further protect against damage to instream and riparian habitat.

Several options exist for establishing minimum flows in the tailwaters below dams. As indicated in the case studies described below, the selection of any particular technique as the most cost-effective depends on several factors including adequate performance to achieve the desired instream and riparian habitat characteristic, compatibility with other requirements for operation of the hydropower facility, availability of materials, and cost.

Sluicing is the practice of releasing water through the sluice gate rather than through the turbines. For portions of the waterway immediately below the dam, the steady release of water by sluicing provides minimum flows with the least amount of water expenditure. At some facilities, this practice may dictate that modifications be made to the existing sluice outlets to maintain continuous low releases.

Continuous low-level sluice releases at Eufala Lake and Fort Gibson Lake (Oklahoma) improved DO levels in tailwaters downstream of these two dams such that fish mortalities, which had been experienced in the tailwaters below these two dams prior to initiating this practice, no longer occurred (USDOE, 1991).

Turbine pulsing is a practice involving the release of water through the turbines at regular intervals to improve minimum flows. In the absence of turbine pulsing, water is released from large hydropower dams only when the turbines are operating, which is typically when the demand for power is high.

A study undertaken at the Douglas Dam (French Broad River, Tennessee) suggests some of the site-specific factors that should be considered when evaluating the advantages of practices such as turbine pulsing, sluicing, or other alternatives for providing minimum flows and improving DO levels in reservoir releases. Three options (turbine pulsing, sluicing, and operation of surface water pumps and diffusers) were evaluated for their effectiveness, advantages, and disadvantages in providing minimum flows and aeration of reservoir releases. Computer modeling indicated that either turbine pulsing or sluicing could improve DO concentrations in releases by levels ranging from 0.7 to 1.5 mg/L. (Based on studies cited in a previous section of this chapter, this is slightly below the level of improvement that might be expected from operation of a diffuser system for aeration.) A trade-off can also be expected at this facility between water saved by frequent short-release pulses and the higher maintenance costs due to setting turbines on and off frequently (Hauser et al., 1989). Hauser (1989) found that schemes of turbine pulsing ranging from 15-minute intervals to 60-minute intervals every 2 to 6 hours were found to provide fairly stable flow regimes after the first 3 to 8 miles downstream at several TVA projects. However, at points farther downstream, less overall flow would be produced by sluicing than by pulsing. Turbine pulsing may also cause waters to rise rapidly, which could endanger people wading or swimming in the tailwaters downstream of the dam (TVA, 1990).

A reregulation weir is one alternative that has been used to establish minimum flows for preservation of instream habitat. This device is installed in the streambed a short distance below a dam and captures hydropower releases. Flows through the weir can be regulated to produce the desired conditions of water level and flow velocities that are best for instream habitat. As discussed previously in this chapter, reregulation weirs can also be used in some circumstances to improve levels of dissolved oxygen in reservoir releases.

The installation of such an instream structure requires some degree of planning and design since the performance of the weir will affect both the downstream water surface elevation and the velocity of the discharge. These relationships have been investigated for the Buford Dam (Chattahoochee River, Georgia), where computer simulations of a proposed reregulation weir indicated that a discharge of 500 cfs created the best instream habitat conditions for juvenile brown trout. Instream habitat for adult brook trout, adult brown trout, and adult rainbow trout was most desirable at discharges in the vicinity of 1,000 to 2,000 cfs (Nestler et al., 1986a).

A reregulation weir was also found to be the most cost-effective alternative for providing a 90-cfs minimum flow below the Holston Dam (South Fork Holston River, Tennessee) for maintenance of instream trout habitat (Adams and Hauser, 1990). The weir was investigated as one alternative for establishing minimum flows, along with turbine pulsing and installation of a small generating unit in the existing tailrace that would operate at all times when the existing unit was not operating. The three alternatives were assessed for their effects on river hydraulics and on operation of the hydropower facility.

Small turbines are another alternative that has been evaluated for establishing minimum flows. Small turbines are capable of providing continuous generation of power using small flows, as opposed to operating large turbine units with the resultant high flows. In a study of alternatives for providing minimum flows at the Tims Ford Dam (Elk River, Tennessee), small turbines were found to represent the most attractive alternative from a cost-benefit perspective. The other alternatives evaluated included continuous operation of a sluice gate at the dam, pulsing of

the existing turbines, and construction of an instream rock gabion regulating weir downstream of the dam (TVA, 1985).

■ *b. Riparian Improvements*

Riparian improvements are another strategy that can be used to restore or maintain aquatic and riparian habitat around reservoir impoundments or along the waterways downstream from dams. In fact, Johnson and LaBounty (1988) found that riparian improvements were more effective than flow augmentation for protection of instream habitat. In the Salmon River (Idaho), a variety of instream and riparian habitat improvements have been recommended to improve the indigenous stocks of chinook salmon. These include reducing sediment loading in the watershed, improving riparian vegetation, eliminating barriers to fish migration (see sections discussing this practice below), and providing greater instream and riparian habitat diversity (Andrews, 1988).

■ *c. Aquatic Plant Management*

One study of the Cherokee Reservoir (Holston River, Tennessee) reveals the potential importance of watershed protection practices for the improvement of water quality in the reservoir (Hauser et al., 1987). An improved two-dimensional model of reservoir water quality was used to investigate the advantages and disadvantages of several practices for improving temperature and DO levels in the reservoir.

10. Practices to Maintain Fish Passage

Migrating fish populations may suffer losses when passing through the turbines of hydroelectric dams unless these facilities have been equipped with special design features to accommodate fish passage. The effect of dams and other hydraulic structures on migrating fish has been studied since the early 1950s in an effort to develop systems or identify operating conditions that would minimize mortality rates. Despite extensive research, no single device or system has received regulatory agency approval for general use (Stone and Webster, 1986).

The safe passage of fish either upstream or downstream through a dam requires a balance between operation of the facility for its intended uses and implementation of practices that will ensure safe passage of fish. Rochester and others (1984) provide an excellent discussion of some of the economic and engineering considerations necessary to address the problems associated with the safe passage of fish.

Available fish-protection systems for hydropower facilities fall into one of four categories based on their mode of action (Stone and Webster, 1986): behavioral barriers, physical barriers, collection systems, and diversion systems. These are discussed in separate sections below, along with four additional practices that have been successfully used to maintain fish passage: spill and water budgets, fish ladders, transference of fish runs, and constructed spawning beds.

■ *a. Behavioral Barriers*

Behavioral barriers use fish responses to external stimuli to keep fish away from the intakes or to attract them to a bypass. Since fish behavior is notably variable both within and between species, behavioral barriers cannot be expected to prevent all fish from entering hydropower intakes. Environmental conditions such as high turbidity levels can obscure some behavioral barriers such as lighting systems and curtains. Competing behaviors such as feeding or predator avoidance can also be a factor influencing the effectiveness of behavioral barriers at a particular time.

Electric screens, bubble and chain curtains, light, sound, and water jets have been evaluated in laboratory or field studies, with mixed results. The results with system tests of strobe lights, poppers, and hybrid systems are the most promising, but these systems are still in need of further testing (Mattice, 1990). Experiences with some kinds of behavioral barrier systems are described more fully in the following paragraphs.

Electrical screens are intended to produce an avoidance response in fish. This type of fish-protection system is designed to keep fish away from structures or to guide them into bypass areas for removal. Fish seem to respond to the electrical stimulus best when water velocities are low. Tests of an electrical guidance system at the Chandler Canal diversion (Yakima River, Washington) showed the efficiency ranged from 70 to 84 percent for velocities of less than 1 ft/sec. Efficiencies decreased to less than 50 percent when water velocities were higher than 2 ft/sec (Pugh et al., 1971). The success of this type of system may also be species-specific and size-specific. An electrical field strength suitable to deter small fish may result in injury or death to large fish, since total fish body voltage is directly proportional to fish body length (Stone and Webster, 1986). This type of system requires constant maintenance of the electrodes and the associated underwater hardware in order to maintain effectiveness. Surface water quality, in particular, can affect the life and performance of the electrodes.

Air bubble curtains are created by pumping air through a diffuser to create a continuous, dense curtain of bubbles, which can cause an avoidance response in fish. Many factors affect the response of fish to air bubble curtains, including temperature, turbidity, light intensity, water velocity, and orientation in the channel. Bubbler systems should be constructed from materials that are resistant to corrosion and rusting. Installation of bubbler systems needs to consider adequate positioning of the diffuser away from areas where siltation could clog the air ducts.

Hanging chains are used to provide a physical, visible obstacle that fish will avoid. Hanging chains are both species-specific and lifestage-specific. Their efficiency is affected by such variables as instream flow velocity, turbidity, and illumination levels. Debris can limit the performance of hanging chains; in particular, buildup of debris can deflect the chains into a nonuniform pattern and disrupt hydraulic flow patterns.

Strobe lights repel fish by producing an avoidance response. A strobe light system at Saunders Generating Station in Ontario was rated 65 to 95 percent effective at repelling or diverting eels (Stone and Webster, 1986). Turbidity levels in the water can affect strobe light efficiency. The intensity and duration of the flash can also affect the response of the fish; for instance, an increase in flash duration has been associated with less avoidance. Strobe lights also have the potential for far-field fish attraction, since they can appear to fish as a constant light source due to light attenuation over a long distance (Stone and Webster, 1986).

Mercury lights are used to attract the fish as opposed to repelling them. Studies of mercury lights suggest their effectiveness is species-specific; alewives were attracted to a zone of filtered mercury light, whereas coho salmon and rainbow trout displayed no attraction to mercury light (Stone and Webster, 1986). Insufficient data are available to determine whether mercury lights are lifestage-specific. The device shows promise, but more research is being conducted to determine factors that affect performance and efficiency.

Underwater sound broadcast at different frequencies and amplitudes has been shown to be effective in attracting or repelling fish, although the results of field tests are not consistent. Fish have been attracted, repelled, or guided by the sound, and no conclusive response to sound has been observed. Not all fish possess the ability to perceive sound or localized acoustical sources (Harris and Van Bergeijk, 1962). Fish also frequently seem to become habituated to the sound source.

Poppers are pneumatic sound generators that create a high-energy acoustic output to repel fish. Poppers have been shown to be effective in repelling warm-water fish from water intakes. Laboratory and field studies conducted in California indicate good avoidance for several freshwater species such as alewives, perch, and smelt (Stone and Webster, 1986), but salmonids do not seem to be effectively repelled by this device (Stone and Webster, 1986). One important maintenance consideration is that internal "O" rings positioned between the air chambers have been found to wear out quickly. Other considerations are air entrainment in water inlets and vibration of structures associated with the inlets.

Water jet curtains can be used to create hydraulic conditions that will repel fish. Effectiveness is influenced by the angle at which the water is jetted. Although effectiveness averages 75 percent in repelling fish (Stone and Webster, 1986), not enough is known to determine what variables affect the performance of water jet curtains. Important concerns would be clogging of the jet nozzles by debris or rust and the acceptable range of flow conditions.

Hybrid barriers, or combinations of different barriers, can enhance the effectiveness of individual behavioral barriers. A chain net barrier combined with strobe lights has been shown in laboratory studies to be 90 percent effective at repelling fish. Combinations of rope-net and chain-rope barriers have also been tested with good results. Barriers with horizontal components as well as vertical components are more effective than those with vertical components alone. Barriers having elements with a large diameter are more effective than those with a small diameter, and thicker barriers are more effective than thinner barriers. Therefore, diameter and spacing of the barriers are factors influencing performance (Stone and Webster, 1986). With hanging chains, illumination appears to be a necessary factor to ensure effectiveness. Their effectiveness was increased with the use of strobe lights (Stone and Webster, 1986). Effectiveness also increased when strobe lights were added to air bubble curtains and poppers (Stone and Webster, 1986).

■ b. *Physical Barriers*

Physical barriers such as barrier nets and stationary screens can prevent the entry of fish and other aquatic organisms into the intakes at a generating facility. However, they should not be regarded as having much potential for application to promote fish bypass at hydroelectric dams for two reasons. First, the size of the mesh and the labor-intensive maintenance required to remove water-borne trash lower the feasibility of their use. Second, these barriers do little to assist fish in bypassing dams during migration (Mattice, 1990).

■ c. *Fish Collection Systems*

Collection systems involve capture of fish by screening and/or netting followed by transport by truck or barge to a downstream location (Figure 6-8). Since the late 1970s, the Corps of Engineers has successfully implemented a program that takes juvenile salmon from the uppermost dams in the Columbia River system (Pacific Northwest) and transports them by barge or truck to below the last dam. The program improves the travel time of fish through the river system, reduces most of the exposure to reservoir predators, and eliminates the mortality associated with passing through a series of turbines (van der Borg and Ferguson, 1989). Survivability rates for the collected fish are in excess of 95 percent, as opposed to survival rates of about 60 percent had the fish remained in the river system and passed through the dams (Dodge, 1989). However, the collection efficiency can range from 70 percent to as low as 30 percent. At the McNary Dam on the Columbia River, spill budgets are implemented (see below) when the collection rate achieves less than 70 percent efficiency (Dodge, 1989).

■ d. *Fish Diversion Systems*

Diversion systems lead or force fish to bypasses that transport them to the natural waterbody below the dam (USEPA, 1979). Physical diversion structures deployed at dams include traveling screens, louvers, angled screens, drum screens, and inclined plane screens. Most of these systems have been effectively deployed at specific hydropower facilities. However, a sufficient range of performance data is not yet available for categorizing the efficiency of specific designs in a particular set of site conditions and fish population assemblages (Mattice, 1990).

Angled screens are used to guide fish to a bypass by guiding them through the channel at some angle to the flow. Coarse-mesh angled screens have been shown to be highly effective with numerous warm- and cold-water species and adult stages. Fine-mesh angled screens have been shown in laboratory studies to be highly effective in diverting larval and juvenile fish to a bypass with resultant high survival. Performance of this device can vary by species, approach velocity, fish length, screen mesh size, screen type, and temperature (Stone and Webster, 1986).

Angled rotary drum screens oriented perpendicular to the flow direction have been used extensively to lead fish to a bypass. They have not experienced major operational and maintenance problems. Maintenance typically consists of routine inspection, cleaning, lubrication, and periodic replacement of the screen mesh (Stone and Webster, 1986).

An inclined plane screen is used to divert fish upward in the water column into a bypass. Once concentrated, the fish are transported to a release point below the dam. An inclined plane pressure screen at the T.W. Sullivan

Hydroelectric Project (Willamette Falls, Oregon) is located in the penstock of one unit. The design is effective in diverting fish, with a high survival rate. However, this device has been linked to injuries in migrating fish, and it has not been accepted for routine use (Stone and Webster, 1986).

Louvers consist of an array of evenly spaced, vertical slats aligned across a channel at an angle leading to a bypass. They operate by creating turbulence that fish are able to detect and avoid (Stone and Webster, 1986).

Submerged traveling screens are used to divert downstream migrating fish out of turbine intakes to adjoining gatewell structures, where they are concentrated for release downstream (Figure 6-9). This device has been tested extensively at hydropower facilities on the Snake and Columbia Rivers. Because of their complexity, submerged traveling screens must be continually maintained. The screens must be serviced seasonally, depending on the debris load, and trash racks and bypass orifices must be kept free of debris (Stone and Webster, 1986).

■ e. Spill and Water Budgets

Although used together, spill and water budgets are independent methods of facilitating downstream fish migration.

The water budget is the mechanism for increasing flows through dams during the out-migration of anadromous fish species. It is employed to speed smolt migration through reservoirs and dams. Water that would normally be released from the impoundment during the winter period to generate power is instead released in the May-June period when it can be sold only as secondary energy. This concept has been put into practice in some regions of the United States, although quantification of the benefits is lacking (Dodge, 1989).

Spill budgets provide alternative methods for fish passage that are less dangerous than passage through turbines. Spillways are used to allow fish to leave the reservoir by passing over the dam rather than through the turbines. The spillways must be designed to ensure that hydraulic conditions do not induce injury to the passing fish from scraping and abrasion, turbulence, rapid pressure changes, or supersaturation of dissolved gases in water passing through plunge pools (Stone and Webster, 1986).

In the Columbia River basin (Pacific Northwest), the Corps of Engineers provides spill on a limited basis to pass fish around specific dams to improve survival rates. At key dams, spill is used in special operations to protect hatchery releases or provide better passage conditions until bypass systems are fully developed or, in some cases, improved (van der Borg and Ferguson, 1989). The cost of this alternative depends on the volume of water that is lost for power production (Mattice, 1990). Analyses of this practice, using a Corps of Engineers model called FISHPASS, show that the application of spill budgets in the Columbia River basin is consistently the most costly and least efficient method of improving overall downstream migration efficiency (Dodge, 1989).

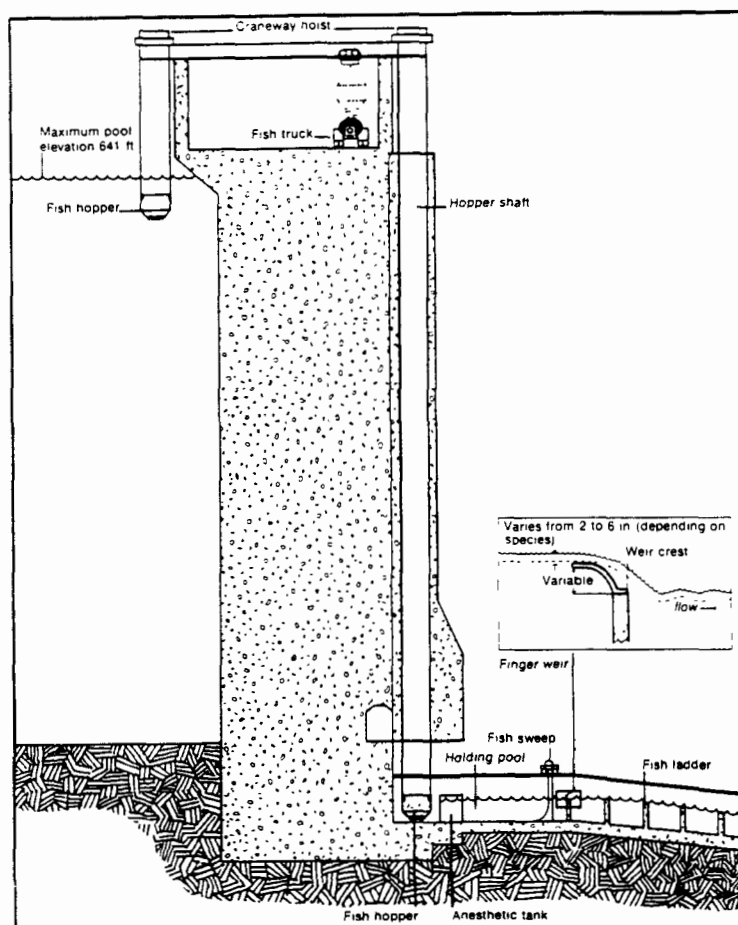

Figure 6-8. Trap and haul system for fish bypass of the Foster Dam, Oregon (Nelson et al., 1978).

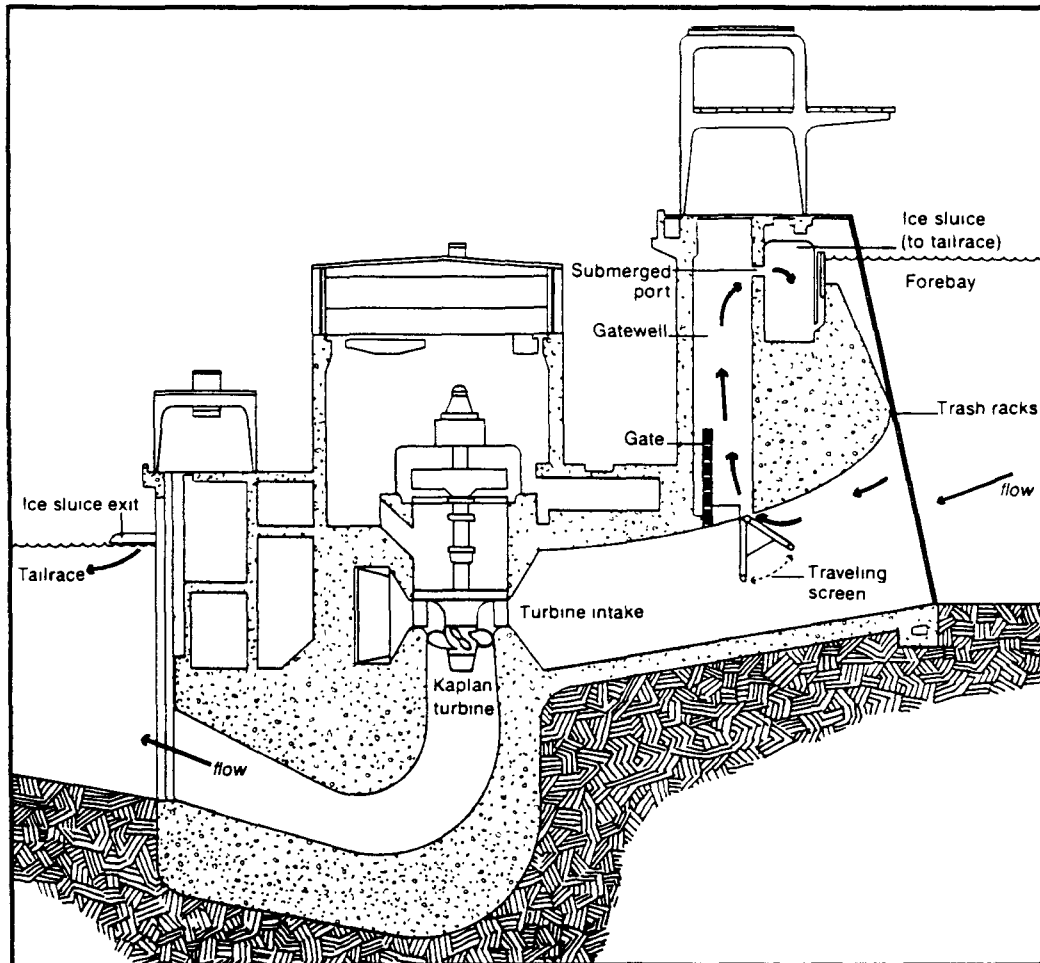

Figure 6-9. Cross section of a turbine bypass system used at Lower Granite and Little Goose Dams, Washington (Nelson et al., 1978).

The volume of a typical water budget is generally not adequate to sustain minimum desirable flows for fish passage during the entire migration period. The Columbia Basin Fish and Wildlife Authority has proposed replacement of the water budget on the Columbia River system with a minimum flow requirement to prevent problems of inadequate water volume in discharge during low-flow years (Muckleston, 1990).

■ f. Fish Ladders

Fish ladders are one type of structure that can be provided to enable the safe upstream and downstream passage of mature fish. One such installation in Maine consists of a vertical slot fishway, constructed parallel to the tailrace, which allows fish to pass from below the dam to the headwaters (ASCE, 1986). The fishway consists of a series of pools, each 8.5 feet by 10 feet in size, which ascend in 1-foot increments through the 40-foot rise from the tailwater area to the headwater area. When there is no flow in the spillway, fish can pass downstream through an 18-inch pipe. Flow is provided in the tailrace during fish migration season. Fish prefer to travel in these fishways at night under low illumination (Larinier and Boyer-Bernard, 1991).

Information on the effectiveness of these types of structures is scarce and inconclusive, according to a study by the General Accounting Office (GAO, 1990). GAO noted that many studies of bypass facilities have emphasized data collection to document the number of juvenile fish entering the bypass structures and the condition of the individuals after passage is completed. Only two studies were identified in which bypass methods were compared with alternative methods to identify the most successful approaches. The observations collected at Lower Granite Dam and at Bonneville Dam (Columbia River) indicate a higher survival rate for young fish passing through turbines than for those passing through a bypass structure.

■ g. *Transference of Fish Runs*

Transference of fish runs involves inducing anadromous fish species to use different spawning grounds in the vicinity of the impoundment. To implement this practice, the nature and extent of the spawning grounds that were lost due to the blockage in the river need to be assessed, and suitable alternative spawning grounds need to be identified. The feasibility of successfully collecting the fish and transporting them to alternative tributaries also needs to be carefully determined.

One strategy for mitigating the impacts of diversions on fisheries is the use of ephemeral streams as conveyance channels for all or a portion of the diverted water. If flow releases are controlled and uninterrupted, a perennial stream is created, along with new instream and riparian habitat. However, the biota that had been adapted to preexisting conditions in the ephemeral stream will probably be eliminated. One case where an ephemeral stream was used to convey water and create alternative instream habitat for fish is along South Fort Crow Creek, in Medicine Bow National Forest, Wyoming. After 2 years of diversion, the amount of stream channel on an 88-km reach had increased 32 percent. Some measure of the success with which alternative instream habitat has replaced the original conditions can be seen in the total area of beaver ponds, which doubled within 2 years of completion of the project (Wolff et al., 1989).

■ h. *Constructed Spawning Beds*

When the adverse effects of a dam on the aquatic habitat of an anadromous fish species are severe, one option may be to construct suitable replacement spawning beds (Virginia State Water Control Board, 1979). Additional facilities such as electric barriers, fish ladders, or bypass channels will have to be furnished to channel the fish to these spawning beds.

11. Costs for All Practices

a. *Costs for Minimum Flow Alternatives*

In a comparison of costs of minimum flows alternatives at South Fork Holston River, Adams and Hauser (1990) describe costs for a variety of practices, including an estimated total direct cost of \$539,000 for a reregulating weir and \$1,258,000 for a small hydro unit.

b. *Costs for Hypolimnetic Aeration*

The diffused air system is generally the most cost-effective method to raise low DO levels (Henderson and Shields, 1984; Cooke and Kennedy, 1989). However, the costs of air diffuser operation may be high for deep reservoirs because of hydraulic pressures that must be overcome. Any destratification that results from deployment of an air diffuser system will also mix nutrient-rich waters located deep in the impoundment into layers located closer to the surface, increasing the potential for stimulation of algal populations. The mixing must be complete to avoid problems with algal blooms (Cooke and Kennedy, 1989).

Fast and others (1976) and Lorenzen and Fast (1977) discuss costs of hypolimnetic aeration. The following are capital cost items for aeration systems: air lift devices, the compressor, the air supply lines, and the diffusers. The

costs for these items are dependent on aerator size, which in turn is dependent on the need for oxygen in the reservoir impoundment (McQueen and Lean, 1986). Cooke and Kennedy (1989) reported side stream pumping costs (adjusted to 1990 dollars) were \$347,023 (capital costs) and \$167,240 (yearly operation and maintenance costs). Partial air lift system costs (adjusted to 1990 dollars) were reported by Cooke and Kennedy (1989) as \$627,150 (capital costs) and \$105,257 (operation and maintenance costs). Capital costs for full air lift systems ranged (in 1990 dollars) from \$250,860 to \$585,340, and operation and maintenance costs (in 1990 dollars) were reported as \$44,862 (Cooke and Kennedy, 1989). In the opinion of Cooke and Kennedy (1989), the full air lift system is the least costly to operate and the most efficient. Furthermore, there is the potential for surface water quality problems caused by the supersaturation of nitrogen gas with the use of the partial air lift system (Fast et al., 1976). Accordingly, the full air lift system seems to be the overall best choice for aeration, based on cost, efficiency, and environmental impacts.

c. Costs for Diffusers

A cost-effective means of achieving better water quality for reservoir releases is to aerate discrete layers near the intakes to avoid any unnecessary release of algae and nutrients into tailwaters below the dam. In another test at facilities operated by the Tennessee Valley Authority (TVA), diffusers were deployed at the 70-foot depth of Fort Patrick Henry Dam near one of the turbine intakes. Levels of DO in the tailwaters increased from near zero to 4 mg/L as a result of operation of this aeration system. Unfortunately, the operation costs of this kind of system were determined to be relatively high. An operation system to increase the DO in the discharge from both hydroturbines at Fort Patrick Henry Dam to 5 mg/L would have an initial capital cost of \$400,000 and an annual operating cost of \$110,000 (Harshbarger, 1987).

The TVA has determined that approximately \$44 million would be required to purchase and install aeration equipment at 16 TVA facilities (TVA, 1990). The aeration of reservoir waters, combined with other practices such as turbine pulsing, would result in the recovery of over 180 miles of instream habitat in areas below TVA dams. An additional \$4 million per year in annual operating costs would also be required.

d. Costs for Aeration Weirs

The estimated costs for an aeration weir constructed downstream of the Canyon Dam (Guadalupe River, Texas) were \$60,000. However, the construction of this device occurred at the same time as other construction at the facility, resulting in a reduction in overall project costs (EPRI, 1990).

e. Costs for Fish Bypass System

The Philadelphia Electric Company installed a fish lift system on the Conowingo Dam, located on the Susquehanna River at the head of the Chesapeake Bay. The fish lift system has the capacity of lifting 750,000 shad and 5 million river herring per year. The system was completed in 1991 at a total cost (adjusted to 1990 dollars) of \$11.9 million (Nichols, 1992).

IV. STREAMBANK AND SHORELINE EROSION MANAGEMENT MEASURE

Streambank erosion is used in this guidance to refer to the loss of fastland along nontidal streams and rivers. *Shoreline erosion* is used in this guidance to refer to the loss of beach or fastland in tidal portions of coastal bays or estuaries. Erosion of ocean coastlines is not regarded as a substantial contributor of NPS pollution in coastal waterbodies and will not be considered in this guidance.

The force of water flowing in a river or stream can be regarded as the most important process causing erosion of a streambank. All of the eroded material is carried downstream and deposited in the channel bottom or in point bars located along bends in the waterway. The process is very different in coastal bays and estuaries, where waves and currents can sort the coarser-grained sands and gravels from eroded bank materials and move them in both directions along the shore, through a process called *littoral drift*, away from the area undergoing erosion. Thus, the materials in beaches of coastal bays and estuaries are derived from shore erosion somewhere else along the shore. Solving the erosion of the source area may merely create new problems with beach erosion over a much wider area of the shore.

The seepage of ground water and the overland flow of surface water runoff also contribute to the erosion of both streambanks and shorelines. The role of ground water is most important wherever permeable subsurface layers of sand or gravel are exposed in banks and high bluffs along streams, rivers, and coastal bays (Palmer, 1973; Leatherman, 1986; Figure 6-10). In these areas, the seepage of ground water into the waterway can cause erosion at the point of exit from the bank face, leading to bank failure. The surface flow of upland runoff across the bank face can also dislodge sediments through sheet flow, or through the creation of rills and gullies on the shoreline banks and bluffs.

The erosion of shorelines and streambanks is a natural process that can have either beneficial or adverse impacts on the creation and maintenance of riparian habitat. Sands and gravels eroded from streambanks are deposited in the channel and are used as instream habitat during the life stages of many benthic organisms and fish. The same materials eroded from the shores of coastal bays and estuaries maintain the beach as a natural barrier between the open water and coastal wetlands and forest buffers. Beaches are dynamic, ephemeral land forms that move back and forth onshore, offshore, and along shore with changing wave conditions (Bascom, 1964). The finer-grained silts and clays derived from the erosion of shorelines and streambanks are sorted and carried as far as the quiet waters of wetlands or tidal flats, where benefits are derived from addition of the new material.

There are also adverse impacts from shoreline and streambank erosion. Excessively high sediment loads can smother submerged aquatic vegetation (SAV) beds, cover shellfish beds and tidal flats, fill in riffle pools, and contribute to increased levels of turbidity and nutrients. However, there are few research results that can be used to identify levels below which streambank and shoreline erosion is beneficial and above which it is an NPS-related problem.

The Chesapeake Bay is one coastal waterbody for which sufficient data exist to characterize the relative importance of shore erosion as a source of sediment and nutrients (Ibison et al., 1990, 1992). Erosion of the shores above mean sea level contributes 6.9 million cubic yards of sediment per year, or 39 percent of the total annual sediment supply to the Chesapeake Bay (USACE, 1990). The contribution of nitrogen from shore erosion is estimated at 3.3 million pounds per year, which is 3.3 percent of the total nonpoint nitrogen load to the Bay. The contribution of phosphorus from shore erosion is estimated at 4.5 million pounds per year, which is approximately 46 percent of the total nonpoint phosphorus load to the Bay (USEPA-CBP, 1991).

For many watersheds, it will be necessary to consider four questions about streambank and shoreline erosion simultaneously in developing an NPS pollution reduction strategy:

- (1) Is sediment derived from coastal erosion helping to maintain aquatic habitat elsewhere in the system?

- (2) Is coastal erosion a significant contributor of nonpoint sediment and nutrients?
- (3) Is coastal erosion causing a loss of wetlands and riparian areas, with resultant loss of aquatic habitat and reduction of capacity to remove NPS pollutants from surface waters?
- (4) Are activities along the shoreline and in adjacent surface waters increasing the rate of coastal erosion above natural (background) levels?

The answers to these questions will determine the emphasis that should be given to each of the three elements in the Management Measure for Eroding Streambanks and Shorelines.

Figure 6-10. The physical processes of bluff erosion in a coastal bay. 1. Water enters the ground by infiltration of rainwater or snowmelt. 2. Nearly vertical cracks called joints aid the downward movement of water. 3. Water moves toward the cliff face upon reaching an impermeable layer of sediment formed by clay. 4. A perched water table forms above the clay layer; the overlying sandy sediments become saturated with water. 5. As water seeps out of the cliff and runs down the cliff face, it may erode the sandy sediments above the clay layer, in a process called *sapping*. 6. *Spalling* is another process by which the bluff face breaks off along a more or less planar surface roughly parallel to the face. Spalling is continuous throughout the year, but it intensifies during the winter months when freezing and thawing occur along the joints and seepage zones. 7. Wave action at the base removes fallen debris, allowing cliff failure to continue. (After Leatherman, 1986.)

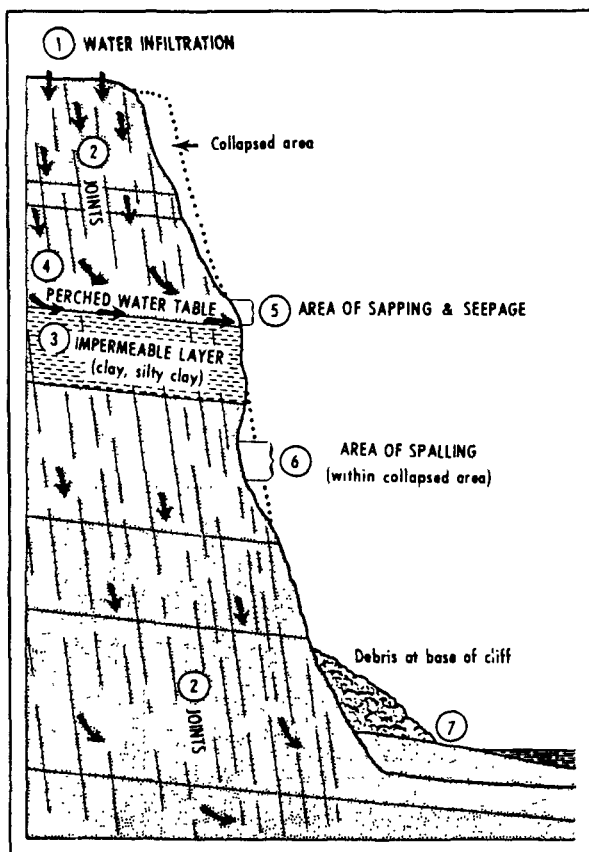

A. Management Measure for Eroding Streambanks and Shorelines

- (1) Where streambank or shoreline erosion is a nonpoint source pollution problem, streambanks and shorelines should be stabilized. Vegetative methods are strongly preferred unless structural methods are more cost-effective, considering the severity of wave and wind erosion, offshore bathymetry, and the potential adverse impact on other streambanks, shorelines, and offshore areas.
- (2) Protect streambank and shoreline features with the potential to reduce NPS pollution.
- (3) Protect streambanks and shorelines from erosion due to uses of either the shorelands or adjacent surface waters.

1. Applicability

This management measure is intended to be applied by States to eroding shorelines in coastal bays, and to eroding streambanks in coastal rivers and creeks. The measure does not imply that all shoreline and streambank erosion must be controlled. Some amount of natural erosion is necessary to provide the sediment for beaches in estuaries and coastal bays, for point bars and channel deposits in rivers, and for substrate in tidal flats and wetlands. The measure, however, applies to eroding shorelines and streambanks that constitute an NPS problem in surface waters. It is not intended to hamper the efforts of any States or localities to retreat rather than to harden the shoreline. Under the Coastal Zone Act Reauthorization Amendments of 1990, States are subject to a number of requirements as they develop coastal NPS programs in conformity with this measure and will have some flexibility in doing so. The application of management measures by States is described more fully in *Coastal Nonpoint Pollution Control Program: Program Development and Approval Guidance*, published jointly by the U.S. Environmental Protection Agency (EPA) and the National Oceanic and Atmospheric Administration (NOAA) of the U.S. Department of Commerce.

2. Description

Several streambank and shoreline stabilization techniques will be effective in controlling coastal erosion wherever it is a source of nonpoint pollution. Techniques involving marsh creation and vegetative bank stabilization ("soil bioengineering") will usually be effective at sites with limited exposure to strong currents or wind-generated waves. In other cases, the use of engineering approaches, including beach nourishment or coastal structures, may need to be considered. In addition to controlling those sources of sediment input to surface waters which are causing NPS pollution, these techniques can halt the destruction of wetlands and riparian areas located along the shorelines of surface waters. Once these features are protected, they can serve as a filter for surface water runoff from upland areas, or as a sink for nutrients, contaminants, or sediment already present as NPS pollution in surface waters.

Stabilization practices involving vegetation or coastal engineering should be properly designed and installed. These techniques should be applied only when there will be no adverse effects to aquatic or riparian river habitat, or to the stability of adjacent shorelines, from stabilizing a source of shoreline sediments. Finally, it is the intent of this

measure to promote institutional measures that establish minimum set-back requirements or measures that allow a buffer zone to reduce concentrated flows and promote infiltration of surface water runoff in areas adjacent to the shoreline.

3. Management Measure Selection

This management measure was selected for the following reasons:

- (1) Erosion of shorelines and streambanks contributes significant amounts of NPS pollution in surface waters such as in the Chesapeake Bay;
- (2) The loss of coastal land and streambanks due to shoreline and streambank erosion results in reduction of riparian areas and wetlands that have NPS pollution abatement potential; and
- (3) A variety of activities related to the use of shorelands or adjacent surface waters can result in erosion of land along coastal bays or estuaries and losses of land along coastal rivers and streams.

4. Practices

As discussed more fully at the beginning of this chapter and in Chapter 1, the following practices are described for illustrative purposes only. State programs need not require the implementation of these practices. However, as a practical matter, EPA anticipates that the management measure set forth above generally will be implemented by applying one or more management practices appropriate to the source, location, and climate. The practices set forth below have been found by EPA to be representative of the types of practices that can be applied successfully to achieve the management measure described above.

Preservation and protection of shorelines and streambanks can be accomplished through many approaches, but preference in this guidance is for nonstructural practices, such as soil bioengineering and marsh creation.

- a.** *Use soil bioengineering and other vegetative techniques to restore damaged habitat along shorelines and streambanks wherever conditions allow.*

Soil bioengineering is used here to refer to the installation of living plant material as a main structural component in controlling problems of land instability where erosion and sedimentation are occurring (USDA-SCS, 1992). Soil bioengineering largely uses native plants collected in the immediate vicinity of a project site. This ensures that the plant material will be well adapted to site conditions. While a few selected species may be installed for immediate protection, the ultimate goal is for the natural invasion of a diverse plant community to stabilize the site through development of a vegetative cover and a reinforcing root matrix (USDA-SCS, 1992).

Soil bioengineering provides an array of practices that are effective for both prevention and mitigation of NPS problems. This applied technology combines mechanical, biological, and ecological principles to construct protective systems that prevent slope failure and erosion. Adapted types of woody vegetation (shrubs and trees) are initially installed as key structural components, in specified configurations, to offer immediate soil protection and reinforcement. Soil bioengineering systems normally use cut, unrooted plant parts in the form of branches or rooted plants. As the systems establish themselves, resistance to sliding or shear displacement increases in streambanks and upland slopes (Schiechtl, 1980; Gray and Leiser, 1982; Porter, 1992).

Specific soil bioengineering practices include (USDA-SCS, 1992):

- **Live Staking.** Live staking involves the insertion and tamping of live, rootable vegetative cuttings into the ground (Figure 6-11). If correctly prepared and placed, the live stake will root and grow. A system of stakes creates a living root mat that stabilizes the soil by reinforcing and binding soil particles together and by extracting excess soil moisture. Most willow species are ideal for live staking because they root

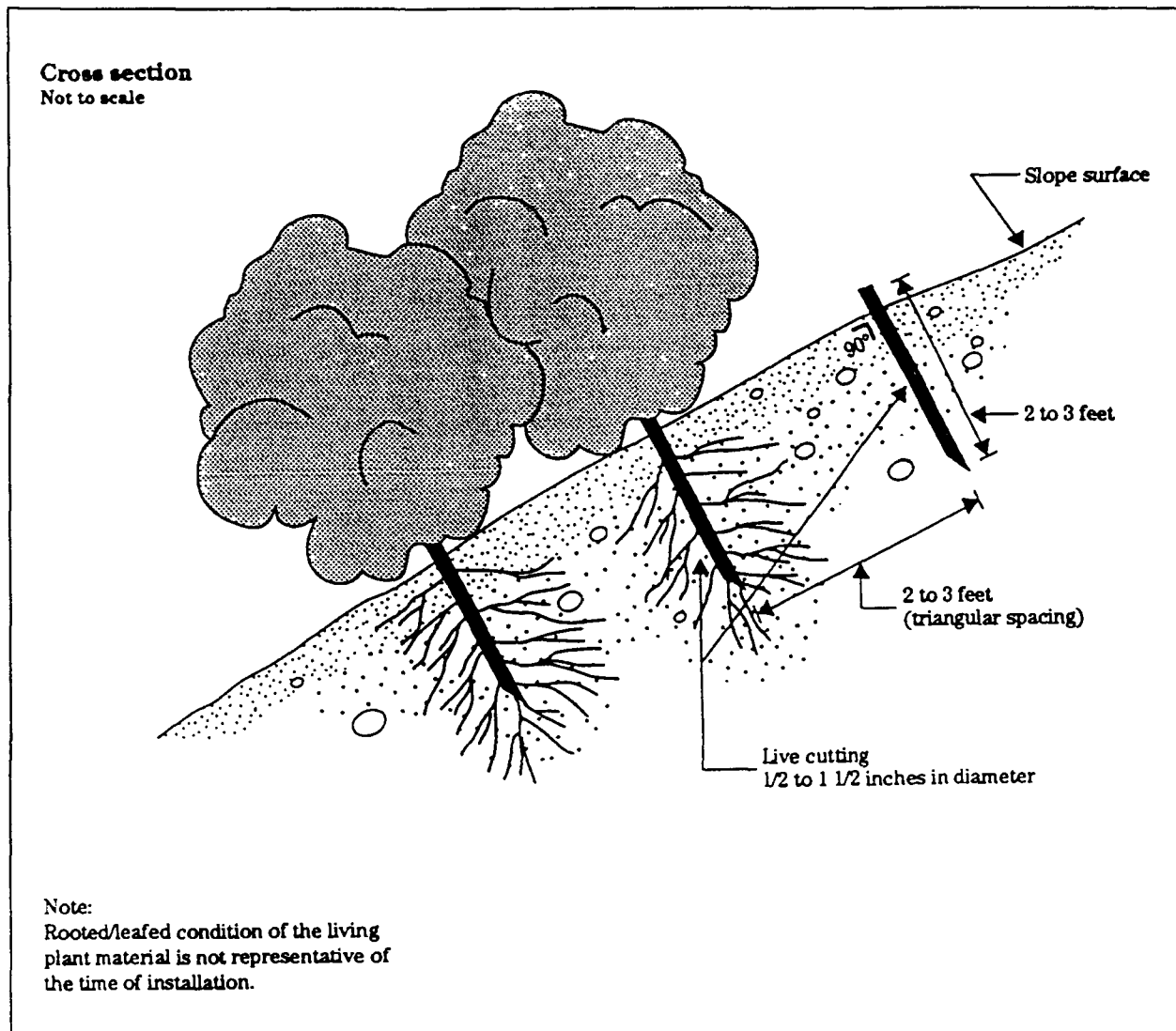

Figure 6-11. Schematic cross section of a live stake installation showing important design elements (USDA-SCS, 1992).

rapidly and begin to dry out a slope soon after installation. This is an appropriate technique for repair of small earth slips and slumps that frequently are wet.

- **Live Fascines.** Live fascines are long bundles of branch cuttings bound together into sausage-like structures (Figure 6-12). When cut from appropriate species and properly installed, they will root and immediately begin to stabilize slopes. They should be placed in shallow contour trenches on dry slopes and at an angle on wet slopes to reduce erosion and shallow face sliding. This system, installed by a trained crew, does not cause much site disturbance.
- **Brushlayering.** Brushlayering consists of placing live branch cuttings in small benches excavated into the slope. The width of the benches can range from 2 to 3 feet. The portions of the brush that protrude from the slope face assist in retarding runoff and reducing surface erosion. Brushlayering is somewhat similar to live fascine systems because both involve the cutting and placement of live branch cuttings on slopes. The two techniques differ principally in the orientation of the branches and the depth to which they are placed in the slope. In brushlayering, the cuttings are oriented more or less perpendicular to the slope

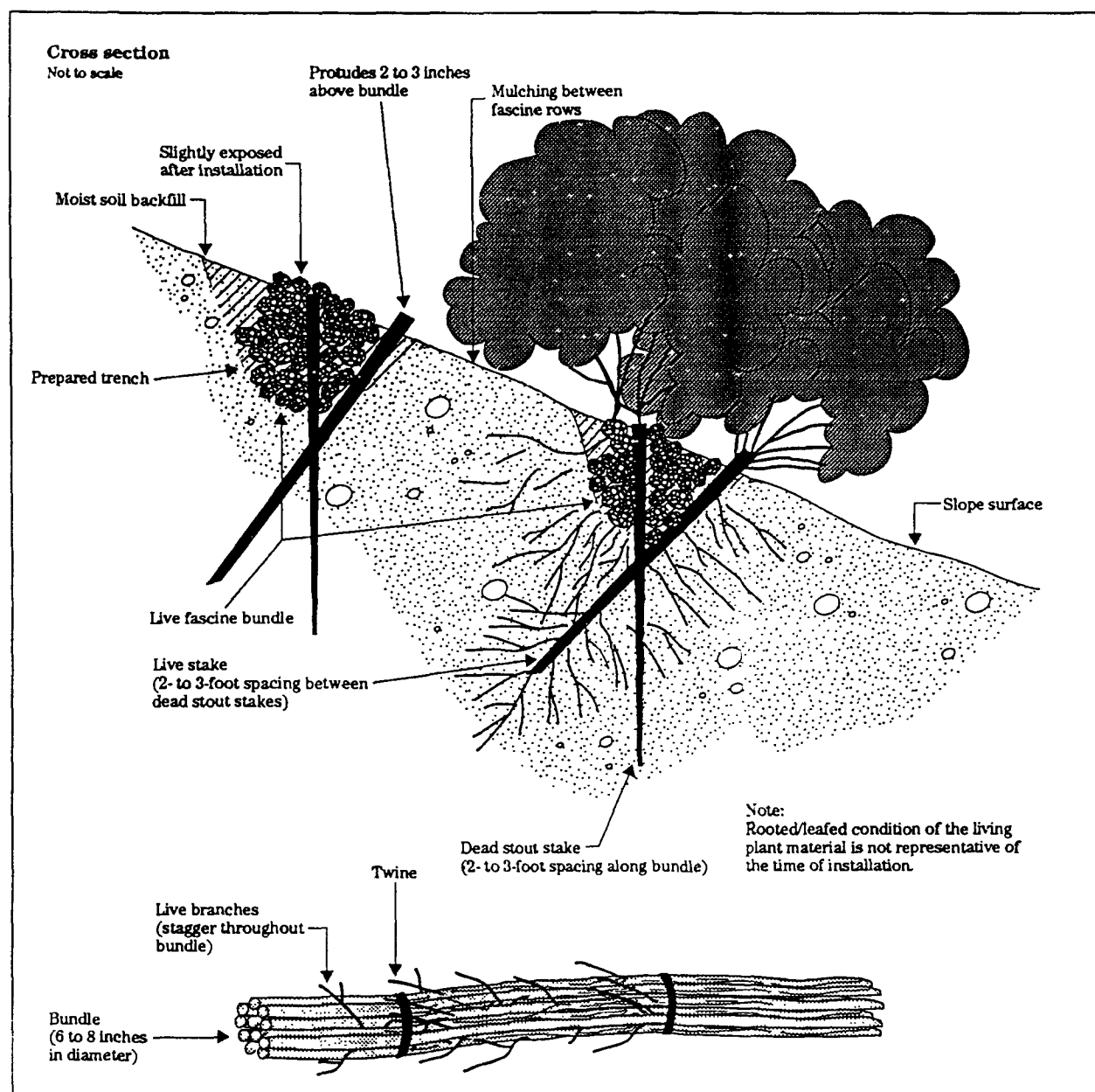

Figure 6-12. Schematic cross section of a live fascine showing important design elements (USDA-SCS, 1992).

contour. In live fascine systems, the cuttings are oriented more or less parallel to the slope contour. The perpendicular orientation is more effective from the point of view of earth reinforcement and mass stability of the slope.

- **Brush Mattressing.** Brush mattressing is commonly used in Europe for streambank protection. It involves digging a slight depression on the bank and creating a mat or mattress from woven wire or single strands of wire and live, freshly cut branches from sprouting trees or shrubs. Branches up to 2.5 inches in diameter are normally cut 3 to 10 feet long and laid in criss-cross layers with the butts in alternating directions to create a uniform mattress with few voids. The mattress is then covered with wire secured with wooden stakes up to 3 feet long. It is then covered with soil and watered repeatedly to fill voids with soil and facilitate sprouting; however, some branches should be left partially exposed on the surface. The structure may require protection from undercutting by placement of stones or burial of the lower edge. Brush

mattresses are generally resistant to waves and currents and provide protection from the digging out of plants by animals. Disadvantages include possible burial with sediment in some situations and difficulty in making later plantings through the mattress.

- **Branchpacking.** Branchpacking consists of alternating layers of live branch cuttings and compacted backfill to repair small localized slumps and holes in slopes (Figure 6-13). Live branch cuttings may range from 1/2 inch to 2 inches in diameter. They should be long enough to touch the undisturbed soil at the back of the trench and extend slightly outward from the rebuilt slope face. As plant tops begin to grow, the branchpacking system becomes increasingly effective in retarding runoff and reducing surface erosion. Trapped sediment refills the localized slumps or holes, while roots spread throughout the backfill and surrounding earth to form a unified mass.
- **Joint Planting.** Joint planting (or vegetated riprap) involves tamping live cuttings of rootable plant material into soil between the joints or open spaces in rocks that have previously been placed on a slope (Figure 6-14). Alternatively, the cuttings can be tamped into place at the same time that rock is being placed on the slope face.
- **Live Cribwalls.** A live cribwall consists of a hollow, box-like interlocking arrangement of untreated log or timber members (Figure 6-15). The structure is filled with suitable backfill material and layers of live branch cuttings, which root inside the crib structure and extend into the slope. Once the live cuttings root

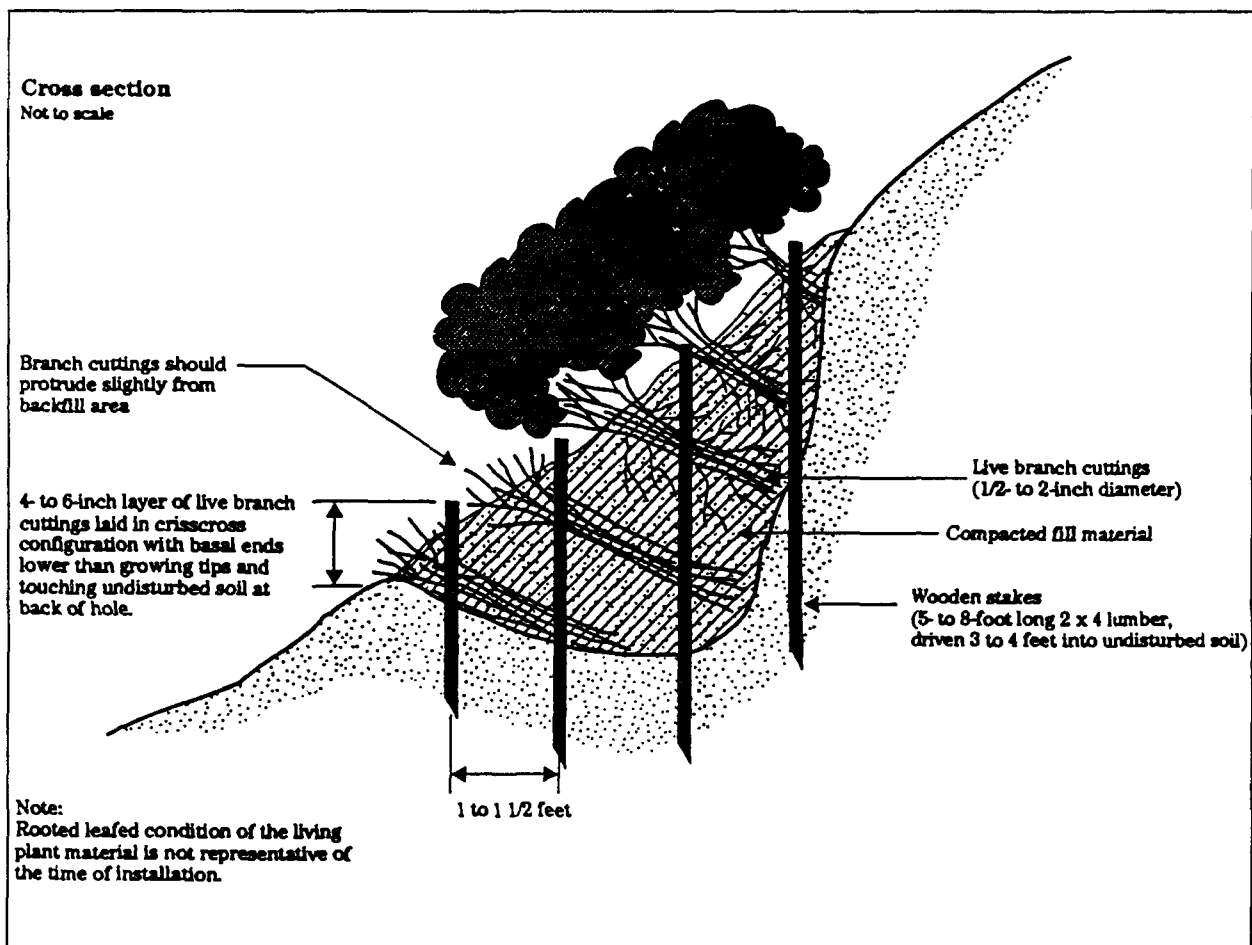

Figure 6-13. Schematic cross section of a branchpacking system showing important design details (USDA-SCS, 1992).

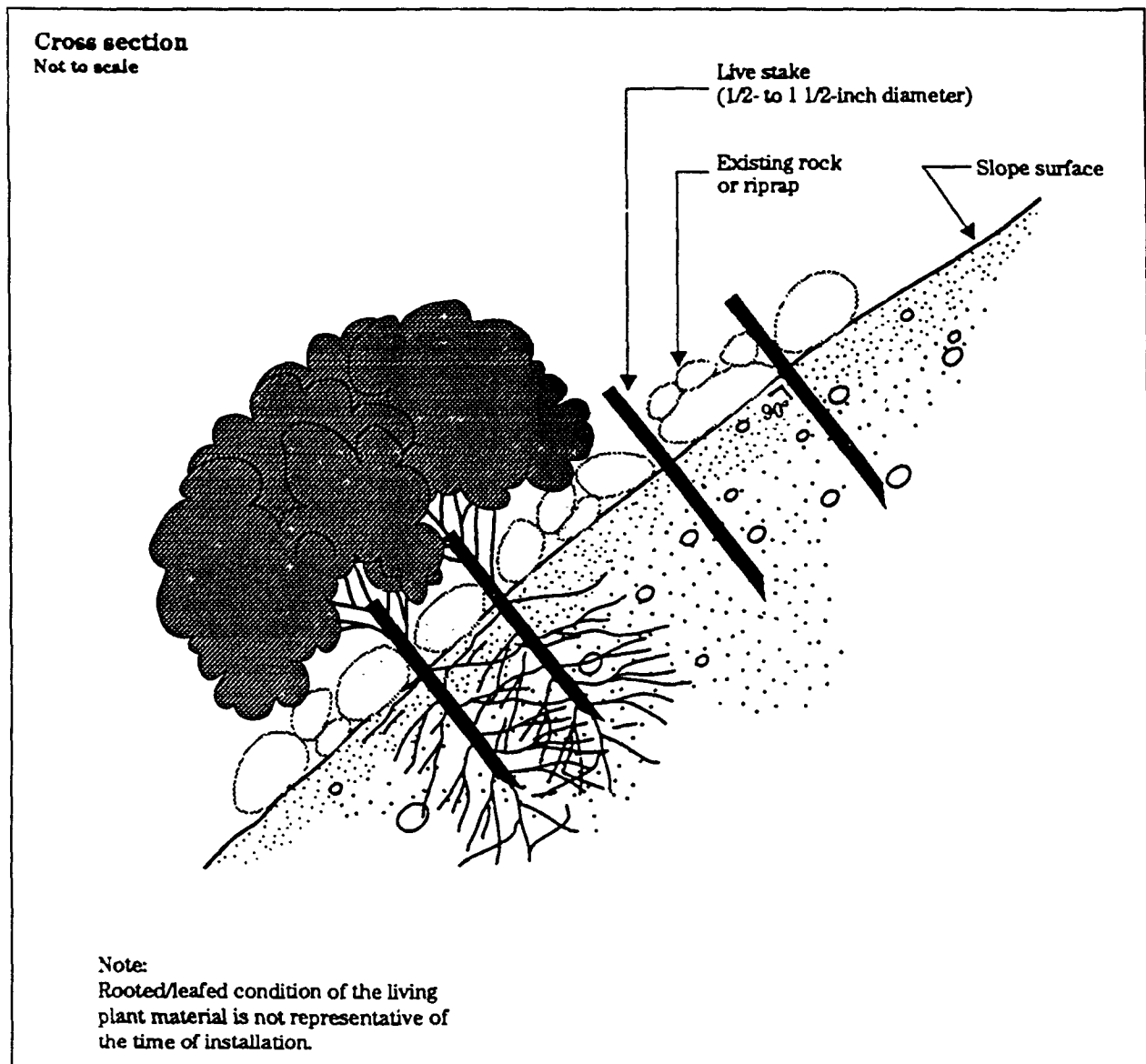

Figure 6-14. Schematic cross section of a joint planting system showing important design elements (USDA-SCS, 1992).

and become established, the subsequent vegetation gradually takes over the structural functions of the wood members.

These techniques have been used extensively in Europe for streambank and shoreline protection and for slope stabilization. They have been practiced in the United States only to a limited extent primarily because other engineering options, such as the use of riprap, have been more commonly accepted practices (Allen and Klimas, 1986). With the costs of labor, materials, and energy rapidly rising in the last two decades, however, less costly alternatives of stabilization are being pursued as alternatives to engineering structures for controlling erosion of streambanks and shorelines.

Additionally, bioengineering has the advantage of providing food, cover, and instream and riparian habitat for fish and wildlife and results in a more aesthetically appealing environment than traditional engineering approaches (Allen and Klimas, 1986).

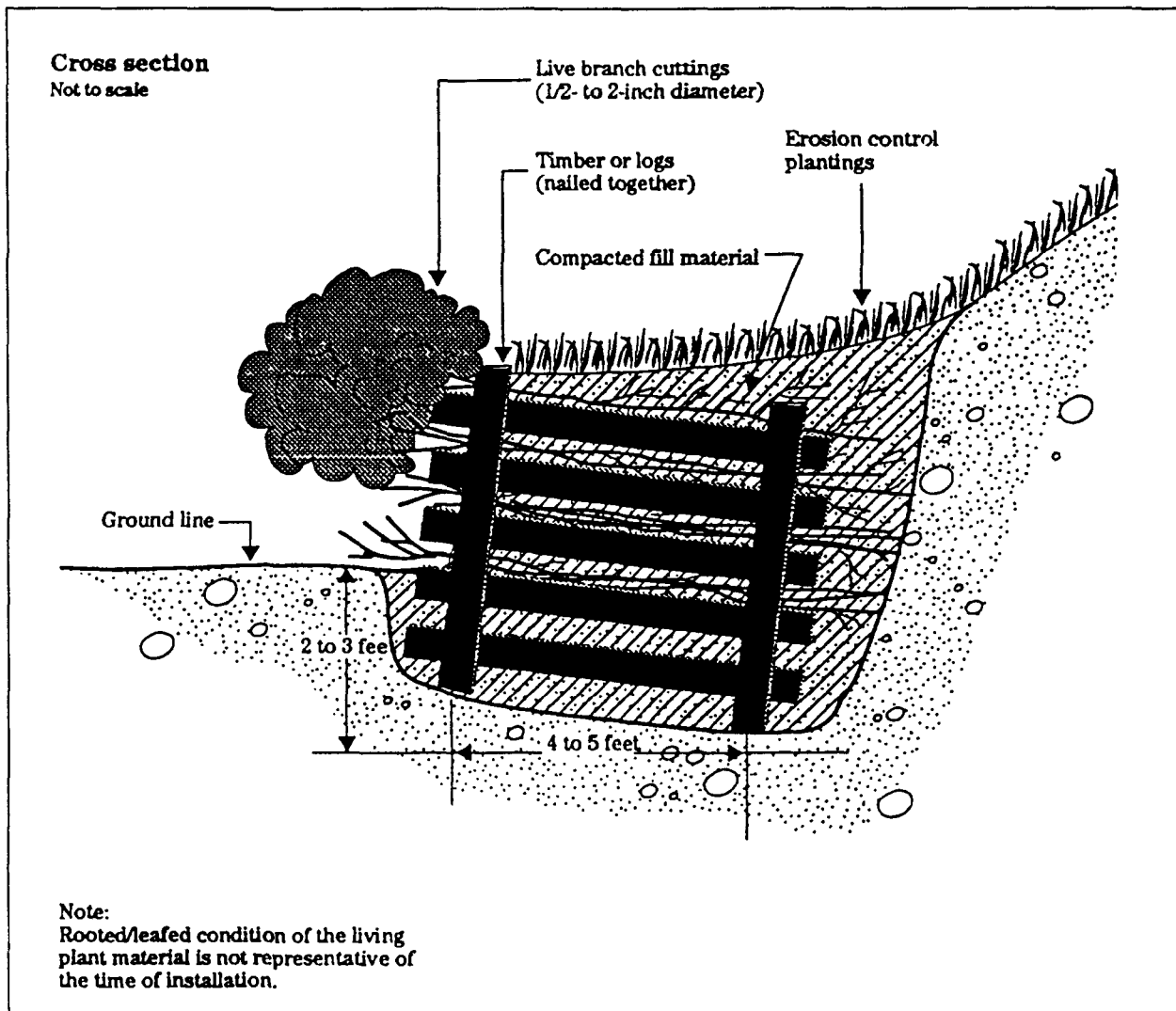

Figure 6-15. Schematic cross section of a live cribwall showing important design elements (USDA-SCS, 1992).

Local agencies such as the USDA Soil Conservation Service and Extension Service can be a useful source of information on appropriate native plant species that can be considered for use in bioengineering projects (USDA-SCS, 1992). For the Great Lakes, the U.S. Army Corps of Engineers has identified 33 upland plant species that have the potential to effectively decrease surface erosion of shorelines resulting from wind action and runoff (Hall and Ludwig, 1975). Michigan Sea Grant has also published two useful guides for shorefront property owners that provide information on vegetation and its role in reducing Great Lakes shoreline erosion (Tainter, 1982; Michigan Sea Grant College Program, 1988).

When considering a soil bioengineering approach to shoreline stabilization, several factors in addition to selection of plant materials are important. Shores subject to wave erosion will usually require structures or beach nourishment to dampen wave energy. In particular, the principles of soil bioengineering, discussed previously, will be ineffective at controlling that portion of streambank or shoreline erosion caused by wave energy. However, soil bioengineering will typically be effective on the portion of the eroding streambank or shoreline located above the zone of wave attack. Subsurface seepage and soil slumping may need to be prevented by dewatering the bank material. Steep banks may need to be reshaped to a more gentle slope to accommodate the plant material (Hall and Ludwig, 1975).

Marsh creation and restoration is another useful vegetative technique that can be used to address problems with erosion of coastal shorelines. Marsh plants perform two functions in controlling shore erosion (Knutson, 1988). First, their exposed stems form a flexible mass that dissipates wave energy. As wave energy is diminished, both the offshore transport and longshore transport of sediment are reduced. Ideally, dense stands of marsh vegetation can create a depositional environment, causing accretion of sediments along the intertidal zone rather than continued erosion of the shore. Second, marsh plants form a dense mat of roots (called rhizomes), which can add stability to the shoreline sediments.

Techniques of marsh creation for shore erosion control have been described by researchers for various coastal areas of the United States, including North Carolina (Woodhouse et al., 1972; Knutson, 1977; Knutson and Inskeep, 1982; Knutson and Woodhouse, 1983), the Chesapeake Bay (Garbisch et al., 1973; Sharp et al., undated), and Florida and the Gulf Coast (Lewis, 1982). The basic approach is to plant a shoreline area in the vicinity of the tide line with appropriate marsh grass species. Suitable fill material may be placed in the intertidal zone to create a wetlands planting terrace of sufficient width (at least 18 to 25 feet) if such a terrace does not already exist at the project site.

For shoreline sites that are highly sheltered from the effects of wind, waves, or boat wakes, the fill material is usually stabilized with small structures, similar to groins (see practice b below), which extend out into the water from the land. For shorelines with higher levels of wave energy, the newly planted marsh can be protected with an offshore installation of stone that is built either in a continuous configuration (Figure 6-16) or in a series of breakwaters (Figure 6-17).

Knutson and Woodhouse (1983) have developed a method for evaluating the suitability of shoreline sites for successful creation of marshes. The method uses a Vegetative Stabilization Site Evaluation Form (Figure 6-18) to evaluate potential for planting success on a case-by-case basis. The user measures each of four characteristics for the area in question, identifies the categories on the form that best describe the area, calculates a cumulative score, and uses the score to determine the potential success rate for installation of wetland plants in the intertidal zone. Sites with a cumulative score of 300 or greater have been correlated with 100 percent success rates at actual field planting sites (Lewis, 1982). Sites with scores between 201 and 300 generally have a success rate of 50 percent, which often constitutes an acceptable risk for undertaking a shoreline erosion control project emphasizing marsh creation (Lewis, 1982).

- *b. Use properly designed and constructed engineering practices for shore erosion control in areas where practices involving marsh creation and soil bioengineering are ineffective.*

Properly designed and constructed shore and streambank erosion control structures are used in areas where higher wave energy makes biostabilization and marsh creation ineffective. There are many sources of information

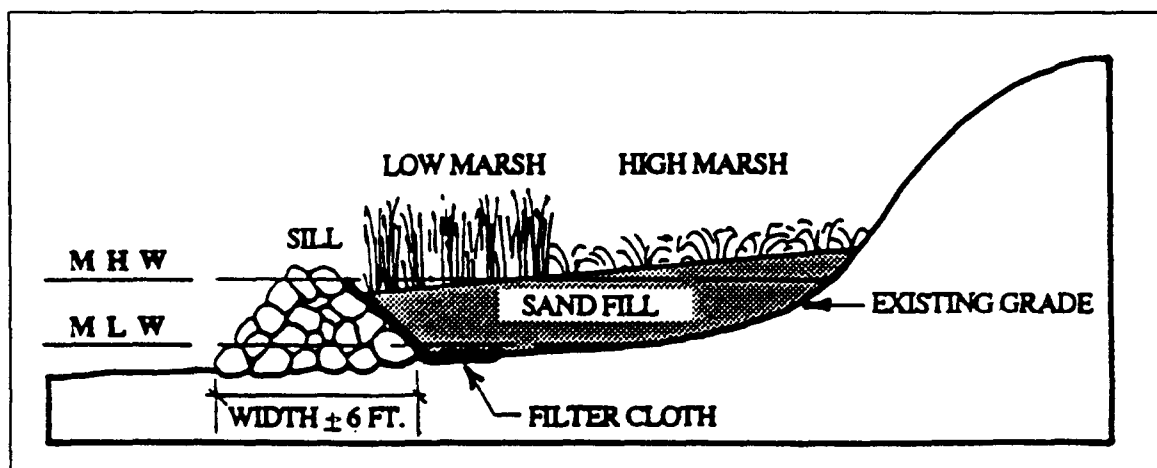

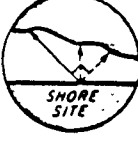





Figure 6-16. Continuous stone sill protecting a planted marsh (Environmental Concern, Inc., 1992).



Figure 6-17. Headland breakwater system at Drummonds Field, Virginia. The breakwaters control shoreline erosion and provide a community beach. (Hardaway and Gunn, 1991.)

concerning the proper design and construction of shoreline and streambank erosion control structures. Table 6-4 contains several useful sources of design information. In addition to careful consideration of the engineering design, the proper planning for a shoreline or streambank protection project will include a thorough evaluation of the physical processes causing the erosion. To complete the analysis of physical factors, the following steps are suggested (Hobbs et al., 1981):

1. SHORE CHARACTERISTICS	2. DESCRIPTIVE CATEGORIES (SCORE WEIGHTED BY PERCENT SUCCESSFUL)				3. WEIGHTED SCORE
a. FETCH-AVERAGE AVERAGE DISTANCE IN KILOMETERS (MILES) OF OPEN WATER MEASURED PERPENDICULAR TO THE SHORE AND 45° EITHER SIDE OF PERPENDICULAR 	LESS THAN 1.0 (0.6) (87)	1.1 (0.7) to 3.0 (1.9) (66)	3.1 (1.9) to 9.0 (5.6) (44)	GREATER THAN 9.0 (5.6) (37)	
b. FETCH-LONGEST LONGEST DISTANCE IN KILOMETERS (MILES) OF OPEN WATER MEASURED PERPENDICULAR TO THE SHORE OR 45° EITHER SIDE OF PERPENDICULAR 	LESS THAN 2.0 (1.2) (89)	2.1 (1.3) to 6.0 (3.7) (67)	6.1 (3.8) to 18.0 (11.2) (41)	GREATER THAN 18.0 (11.2) (17)	
c. SHORELINE GEOMETRY GENERAL SHAPE OF THE SHORELINE AT THE POINT OF INTEREST PLUS 200 METERS (660 FT) ON EITHER SIDE 	(85)	(62)	(50)		
d. SEDIMENT¹ GRAIN SIZE OF SEDIMENTS IN SWASH ZONE (mm)	less than 0.4 (84)	0.4 - 0.8 (41)	greater than 0.8 (18)		
4. CUMULATIVE SCORE					
5. SCORE INTERPRETATION					
a. CUMULATIVE SCORE	122 - 200	201 - 300	300 - 345		
b. POTENTIAL SUCCESS RATE	0 to 30%	30 to 80%	80 to 100%		

¹Grain-size scale for the Unified Soils Classification (Casagrande, 1948; U.S. Army Engineer Waterways Experiment Station, 1953):

Clay, silt, and fine sand - 0.0024 to 0.42 millimeter
 Medium sand - 0.42 to 2.0 millimeters
 Coarse sand - 2.0 to 4.76 millimeters.

Figure 6-18. Vegetative Stabilization Site Evaluation Form (Knutson and Woodhouse, 1983).

Table 6-4. Sources for Proper Design of Shoreline and Streambank Erosion Control Structures

Index	Source	Location	Practices
1	USDA, Soil Conservation Service. 1985. <i>Streambank and Shoreline Protection</i> .	United States	<ul style="list-style-type: none"> • removal of debris • reduction of slope • heavy stone placement • deflectors • vegetation protection
2	Henderson, J.E. 1986. Environmental Designs for Streambank Protection Projects. <i>Water Resources Bulletin</i> , 22 (4) 549-558.	United States	<ul style="list-style-type: none"> • vegetative shoreline stabilization • structural shoreline stabilization
3	Porter, D.L. 1992. <i>Light Touch, Low Cost, Streambank and Shoreline Erosion Control Techniques</i> . Tennessee Valley Authority.	Tennessee	<ul style="list-style-type: none"> • piling revetment • tree revetment and breakwaters • board fence revetments and dikes • tire post retards and revetments • wire cribs • floating tire breakwater • sand bag revetment • toe protection • brush mat revetment • log and cable revetment • vegetative plantings
4	U.S. Army Corps of Engineers. 1983. <i>Streambank Protection Guidelines for Landowners and Local Governments</i> . Vicksburg, MS.	United States	<ul style="list-style-type: none"> • planning/land use management • stream rerouting • removal of obstructions • bed scour control • vegetative stabilization • bank shaping • gabions and wire mattresses • rubble • sacks • blocks • fences • kellner jacks • bulkheads • dikes
5	Hill, Lambert, and Ross. 1983. <i>Best Management Practices for Shoreline Erosion Control</i> . Virginia Cooperative Extension Service. Publication 447-004.	Virginia	<ul style="list-style-type: none"> • management of shorelines to prevent erosion • vegetative covers • bank grading • marsh creation • grassed filter strips
6	Gutman, A.L. 1979. Low-cost Shoreline Protection in Massachusetts. In <i>Proceedings of the Specialty Conference on Coastal Structures 1979</i> , Alexandria, VA, March 14-16, 1979.	Massachusetts	<ul style="list-style-type: none"> • sand-filled fabric bags

Table 6-4. (Continued)

Index	Source	Location	Practices
7	Graham, J.S. 1983. Design of Pressure-treated Wood Bulkheads. In <i>Coastal Structures '83</i> . U.S. Army Corps of Engineers.	United States	<ul style="list-style-type: none"> • wood bulkheads/retaining walls
8	Cumberland County SWCD, Knox-Lincoln SWCD, Maine Department of Environmental Protection, Maine Soil and Water Conservation Commission, Portland Water District, Time and Ride RC and D, USEPA, and USDA-SCS. Fact Sheet Series (2, 3, 4, 5, 8, 9, 10, 12)	Maine	<ul style="list-style-type: none"> • vegetative dune stabilization • vegetative streambank stabilization • vegetated buffer strips • culverts • grassed swales • diversion • minimization of cut and fill • structures to channelize water down steep slopes • shoreline riprap • streambank riprap • temporary check dams
9	Gloucester County, Virginia, Department of Conservation and Recreation, Division of Soil and Water Conservation, Shoreline Programs Bureau. June 1991. <i>Gloucester County Shoreline Erosion Control Guidance (Draft)</i> .	Gloucester County, VA	<ul style="list-style-type: none"> • marsh establishment • bank grading and revegetation • riprap revetment • bulkheading • groins • gabions
10	Ehrlich, L.A., and F. Kulhawy. 1982. <i>Breakwaters, Jetties and Groins: A Design Guide</i> . New York Sea Grant Institute, Coastal Structures Handbook Series.	New York	<ul style="list-style-type: none"> • breakwaters • jetties • groins • mound structures • wall structures • longard tubes • sand-filled bags • rock mastic • precast concrete units
11	Saczynski, T.M., and F. Kulhawy. 1982. <i>Bulkheads</i> . New York Sea Grant Institute, Coastal Structures Handbook Series.	New York	<ul style="list-style-type: none"> • anchored walls • cantilevered walls • walls in clay
12	U.S. Army Corps of Engineers, Waterways Experimental Station. <i>Shoreline Protection Manual</i> , Volumes I and II. Vicksburg, MS.	United States	<ul style="list-style-type: none"> • seawalls and bulkheads • revetments • beach fill • groins • jetties • breakwaters

Table 6-4. (Continued)

Index	Source	Location	Practices
13	Fulford, E.T. 1985 <i>Reef Type Breakwaters for Shoreline Stabilization</i> . In Proceedings of Coastal Zone '85, pp. 1776-1795. American Society of Civil Engineers.	Chesapeake Bay	<ul style="list-style-type: none"> • reef-type breakwaters: low-crested rubble-mound breakwaters built parallel to the shoreline • revetments • bulkheads • groins
14	Tainter, S.P. 1982. <i>Bluff Slumping and Stability: A Consumer's Guide</i> . Michigan Sea Grant.	United States	<ul style="list-style-type: none"> • reshaping bluff face • subsurface drainage • surface water control • vegetation
15	FEMA. 1986. <i>Coastal Construction Manual</i> . Federal Emergency Management Agency, Washington, DC.	United States	<ul style="list-style-type: none"> • structural design recommendations • landscaping • dune protection • bulkheads • use of earthfill
16	Hardaway, C.S., and J.R. Gunn. 1991. <i>Headland Breakwaters in Chesapeake Bay</i> .	Chesapeake Bay	<ul style="list-style-type: none"> • headland breakwater systems: series of headlands and pocket beaches

- (1) Determine the limits of the shoreline reach;
- (2) Determine the rates and patterns of erosion and accretion and the active processes of erosion within the reach;
- (3) Determine, within the reach of the sites of erosion-induced sediment supply, the volumes of that sediment supply available for redistribution within the reach, as well as the volumes of that sediment supply lost from the reach;
- (4) Determine the direction of sediment transport and, if possible, estimation of the magnitude of the gross and net sediment transport rates; and
- (5) Estimate factors such as ground-water seepage or surface water runoff that contribute to erosion.

The most widely-accepted alternative engineering practices for streambank or shoreline erosion control are described below. These practices will have varying levels of effectiveness depending on the strength of waves, tides, and currents at the project site. They will also have varying degrees of suitability at different sites and may have varying types of secondary impacts. One important impact that must always be considered is the transfer of wave energy, which can cause erosion offshore or alongshore. Finding a satisfactory balance between these three factors (effectiveness, suitability, and secondary impacts) is often the key to a successful streambank or shore erosion control project.

Fixed engineering structures are built to protect upland areas when resources become impacted by erosive processes. Sound design practices for these structures are essential (Kraus and Pilkey, 1988). Not only are poorly designed structures typically unsuccessful in protecting the intended stretch of shoreline, but they also have a negative impact on other stretches of shoreline as well. One example of accelerated erosion of unprotected properties adjacent to shoreline erosion structures is the Siletz Spit, Oregon, site (Komar and McDougal, 1988).

For sites where soil bioengineering marsh creation would not be an effective means of streambank or shoreline stabilization, a variety of engineering approaches can be considered. One approach involves the design and installation of fixed engineering structures. Bulkheads and seawalls are two types of wave-resistant walls that are similar in design but slightly different in purpose. Bulkheads are primarily soil-retaining structures designed also to resist wave attack (Figure 6-19). Seawalls are principally structures designed to resist wave attack, but they also may retain some soil (USACE, 1984). Both bulkheads and seawalls may be built of many materials, including steel, timber, or aluminum sheet pile, gabions, or rubble-mound structures.

Although bulkheads and seawalls protect the upland area against further erosion and land loss, they often create a local problem. Downward forces of water, produced by waves striking the wall, can produce a transfer of wave energy and rapidly remove sand from the wall (Pilkey and Wright, 1988). A stone apron is often necessary to prevent scouring and undermining. With vertical protective structures built from treated wood, there are also concerns about the leaching of chemicals used in the wood preservatives (Baechler et al., 1970; Arsenault, 1975). Chromated copper arsenate (CCA), the most popular chemical used for treating the wood used in docks, pilings, and bulkheads, contains elements of chromium, copper, and arsenic, which have some value as nutrients in the marine environment but are toxic above trace levels (Weis et al., 1991; Weis et al., 1992).

A revetment is another type of vertical protective structure used for shoreline protection. One revetment design contains several layers of randomly shaped and randomly placed stones, protected with several layers of selected armor units or quarry stone (Figure 6-20). The armor units in the cover layer should be placed in an orderly manner to obtain good wedging and interlocking between individual stones. The cover layer may also be constructed of specially shaped concrete units (USACE, 1984).

Sometimes gabions (stone-filled wire baskets) or interlocking blocks of precast concrete are used in the construction of revetments. In addition to the surface layer of armor stone, gabions, or rigid blocks, successful revetment designs also include an underlying layer composed of either geotextile filter fabric and gravel or a crushed stone filter and bedding layer. This lower layer functions to redistribute hydrostatic uplift pressure caused by wave action in the foundation substrate. Precast cellular blocks, with openings to provide drainage and to allow vegetation to grow through the blocks, can be used in the construction of revetments to stabilize banks. Vegetation roots add additional strength to the bank. In situations where erosion can occur under the blocks, fabric filters can be used to prevent the erosion. Technical assistance should be obtained to properly match the filter and soil characteristics. Typically blocks are hand placed when mechanical access to the bank is limited or costs need to be minimized. Cellular block revetments have the additional benefit of being flexible to conform to minor changes in the bank shape (USACE, 1983).

Groins are structures that are built perpendicular to the shore and extend into the water. Groins are generally constructed in series, referred to as a groin field, along the entire length of shore to be protected. Groins trap sand in littoral drift and halt its longshore movement along beaches. The sand beach trapped by each groin acts as a protective barrier that waves can attack and erode without damaging previously unprotected upland areas. Unless the groin field is artificially filled with sand from other sources, sand is trapped in each groin by interrupting the natural supply of sand moving along the shore in the natural littoral drift. This frequently results in an inadequate natural supply of sand to replace that which is carried away from beaches located farther along the shore in the direction of the littoral drift. If these "downdrift" beaches are kept starved of sand for sufficiently long periods of time, severe beach erosion in unprotected areas can result.

As with bulkheads and revetments, the most durable materials used in the construction of groins are timber and stone. Less expensive techniques for building groins use sand- or concrete-filled bags or tires. It must be recognized that the use of lower-cost materials in the construction of bulkheads, revetments, or groins frequently results in less durability and reduced project life.

Breakwaters are wave energy barriers designed to protect the land or nearshore area behind them from the direct assault of waves. Breakwaters have traditionally been used only for harbor protection and navigational purposes; in recent years, however, designs of shore-parallel segmented breakwaters, such as the one shown in Figure 6-17,

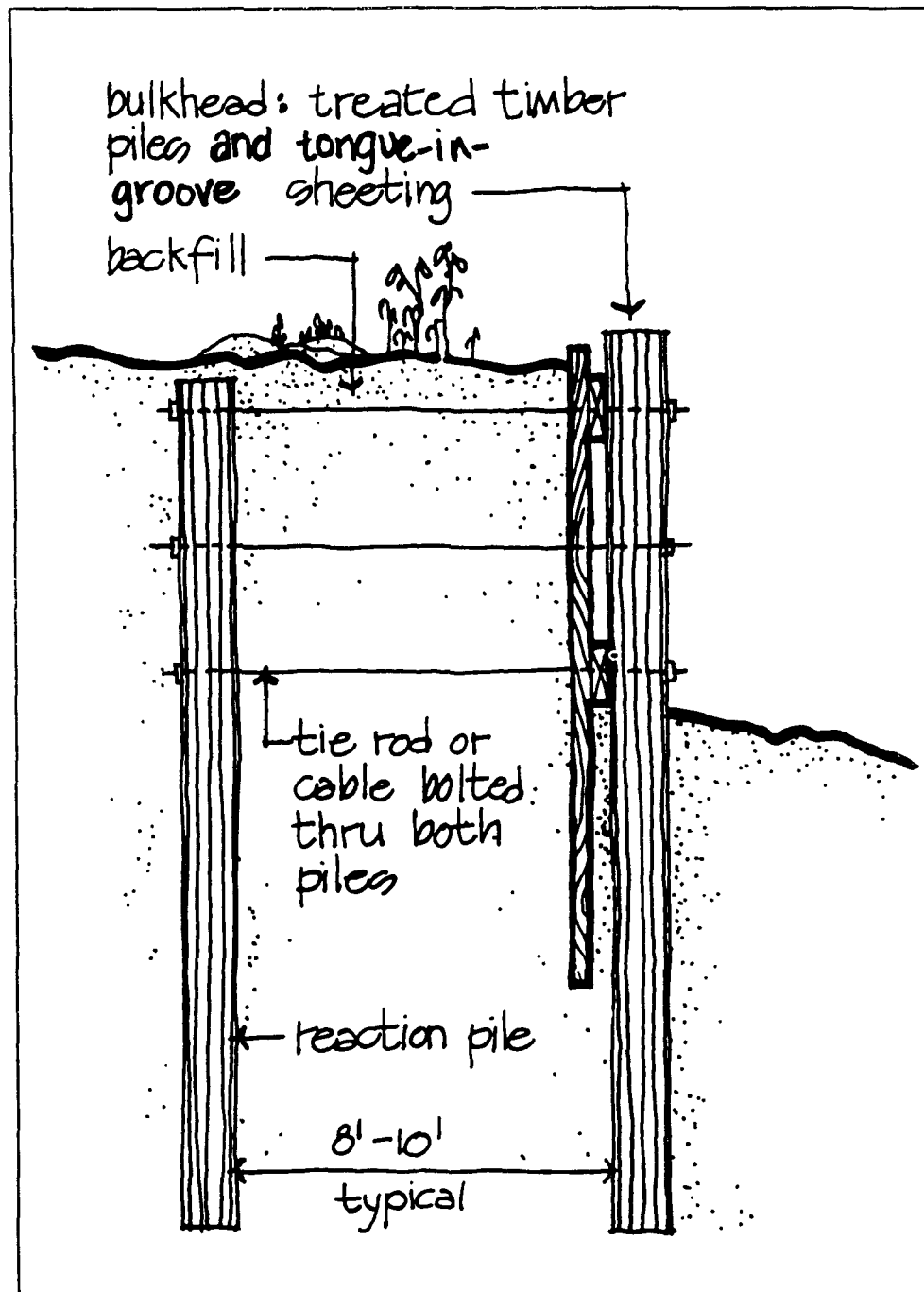

Figure 6-19. Schematic cross section of a timber bulkhead showing important design elements (FEMA, 1986).

have been used for shore protection purposes (Fulford, 1985; USACE, 1990; Hardaway and Gunn, 1989; Hardaway and Gunn, 1991). Segmented breakwaters can be used to provide protection over longer sections of shoreline than is generally affordable through the use of bulkheads or revetments. Wave energy is able to pass through the breakwater gaps, allowing for the maintenance of some level of longshore sediment transport, as well as mixing and flushing of the sheltered waters behind the structures. The cost per foot of shore for the installation of segmented

offshore breakwaters is generally competitive with the costs of stone revetments and bulkheads (Hardaway et al., 1991).

Selection of Structural Stabilization Techniques

Five factors are typically taken into consideration when choosing from among the various alternatives of engineering practices for protection of eroding shorelines (USACE, 1984):

- (1) Foundation conditions;
- (2) Level of exposure to wave action;
- (3) Availability of materials;
- (4) Initial costs and repair costs; and
- (5) Past performance.

Foundation conditions may have a significant influence on the selection of the type of structure to be used for shoreline or streambank stabilization. Foundation characteristics at the site must be compatible with the structure that is to be installed for erosion control. A structure such as a bulkhead, which must penetrate through the existing substrate for stability, will generally not be suitable for shorelines with a rocky bottom. Where foundation conditions are poor or where little penetration is possible, a gravity-type structure such as a stone revetment may be preferable. However, all vertical protective structures (revetments, seawalls, and bulkheads) built on sites with soft or unconsolidated bottom materials can experience scouring as incoming waves are reflected off the structures. In the absence of additional toe protection in these circumstances, the level of scouring and erosion of bottom sediments at the base of the structure may be severe enough to contribute to structural failure at some point in the lifetime of the installation.

Along streambanks, the force of the current during periods of high streamflow will influence the selection of bank stabilization techniques and details of the design. For coastal bays, the levels of wave exposure at the site will also generally influence the selection of shoreline stabilization techniques and details of the design. In areas of severe wave action or strong currents, light structures such as timber cribbing or light riprap revetment should not be used.

The effects of winter ice along the shoreline or streambank also need to be considered in the selection and design of erosion control projects. The availability of materials is another key factor influencing the selection of suitable

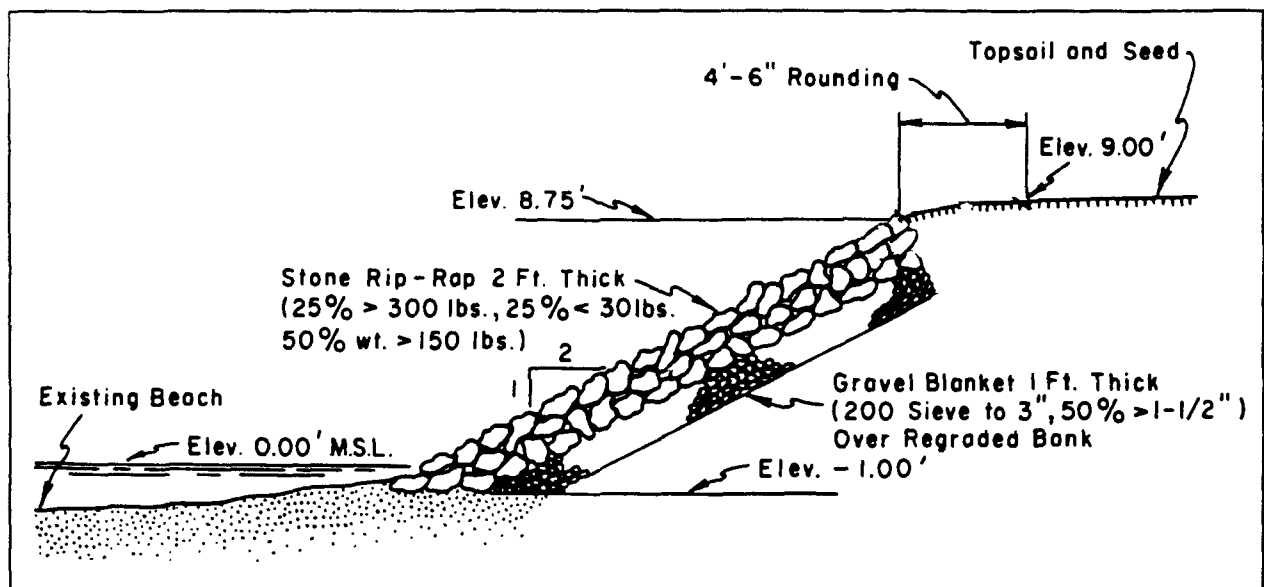

Figure 6-20. Schematic cross section of a stone revetment showing important design elements (USACE, 1984).

structures for an eroding streambank or shoreline. A particular type of bulkhead, seawall, or revetment may not be economically feasible if materials are not readily available near the construction site. Installation methods may also preclude the use of specific structures in certain situations. For instance, the installation of bulkhead pilings in coastal areas near wetlands may not always be permissible due to disruptive impacts in locating pile-driving equipment at the project site.

Costs are influenced not only by the availability of materials but also by the type of structure that is selected for protection of the shoreline. The total cost of a shoreline or streambank protection project should be viewed as including both the initial costs of materials and the annual costs of maintenance. In some parts of the country, the initial costs of timber bulkheads may be less than the cost of stone revetments. However, stone structures typically require less maintenance and have a longer life than timber structures. Other types of structures whose installation costs are similar may actually have a wide difference in overall cost when annual maintenance and the anticipated lifetime of the structure are considered (USACE, 1984).

Other engineering practices for stabilizing shorelines and streambanks rely less on fixed structures. The creation or nourishment of existing beaches provides protection to the eroding area and can also provide a riparian habitat function, particularly when portions of the finished project are planted with beach or dune grasses (Woodhouse, 1978). Beach nourishment requires a readily available source of suitable fill material that can be effectively transported to the erosion site for reconstruction of the beach (Hobson, 1977). Dredging or pumping from offshore deposits is the method most frequently used to obtain fill material for beach nourishment. A second possibility is the mining of suitable sand from inland areas and overland hauling and dumping by trucks. To restore an eroded beach and stabilize it at the restored position, fill is placed directly along the eroded sector (USACE, 1984). In most cases, plans must be made to periodically obtain and place additional fill on the nourished beach to replace sand that is carried offshore into the zone of breaking waves or alongshore in littoral drift (Houston, 1991; Pilkey, 1992).

One important task that should not be overlooked in the planning process for beach nourishment projects is the proper identification and assessment of the ecological and hydrodynamic effects of obtaining fill material from nearby submerged coastal areas (Thompson, 1973). Removal of substantial amounts of bottom sediments in coastal areas can disrupt populations of fish, shellfish, and benthic organisms. Grain size analysis should be performed on sand from both the borrow area and the beach area to be nourished. Analysis of grain size should include both size and size distribution, and fill material should match both of these parameters. Fill materials should also be analyzed for the presence of contaminants, and contaminated sediment should not be used. Turbidity levels in the overlying waters can also be raised to undesirable levels (Sherk et al., 1976; O'Connor et al., 1976). Certain coastal areas may have seasonal restrictions on obtaining fill from nearby submerged coastal areas (Profiles Research and Consulting Group, Inc., 1980). Timing of nourishment activities is frequently a critical factor since the recreational demand for beach use frequently coincides with the best months for completing the beach nourishment. These may also be the worst months from the standpoint of impacts to aquatic life and the beach community such as turtles seeking nesting sites.

Design criteria should include proper methods for stabilizing the newly created beach and provisions for long-term monitoring of the project to document the stability of the newly created beach and the recovery of the riparian habitat and wildlife in the area.

■ c. *In areas where existing protection methods are being flanked or are failing, implement properly designed and constructed shore erosion control methods such as returns or return walls, toe protection, and proper maintenance or total replacement.*

Toe Protection. A number of qualitative advantages are to be gained by providing toe protection for vertical bulkheads. Toe protection usually takes the form of a stone apron installed at the base of the vertical structure to reduce wave reflection and scour of bottom sediments during storms (Figure 6-21). The installation of rubble toe protection should include filter cloth and perhaps a bedding of small stone to reduce the possibility of rupture of the filter cloth. Ideally, the rubble should extend to an elevation such that waves will break on the rubble during storms.

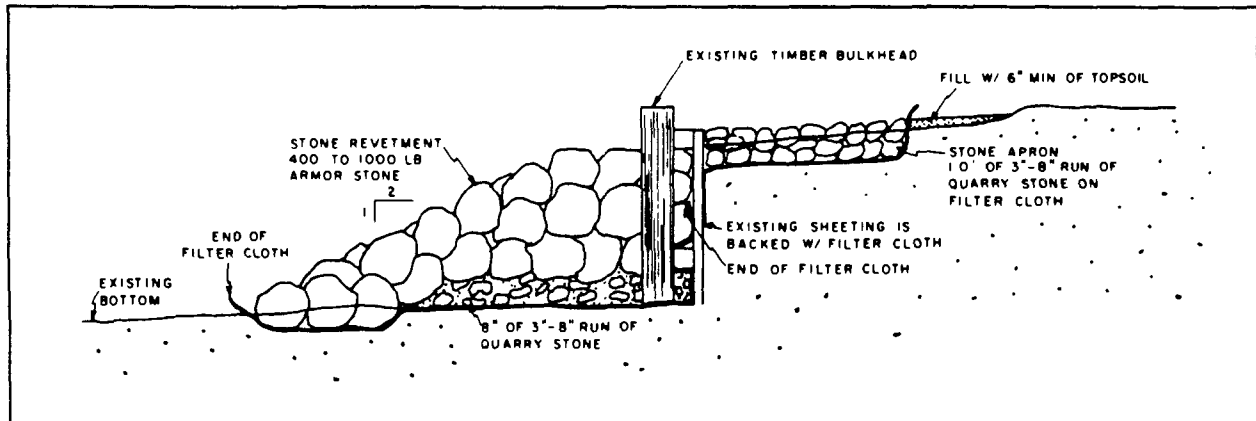

Figure 6-21. Schematic cross section of toe protection for a timber bulkhead showing important design elements (Maryland Department of Natural Resources, 1982).

Return Walls. Whenever shorelines or streambanks are "hardened" through the installation of bulkheads, seawalls, or revetments, the design process must include consideration that waves and currents can continue to dislodge the substrate at both ends of the structure, resulting in very concentrated erosion and rapid loss of fastland. This process is called flanking (Figure 6-22). To prevent flanking, return walls should be provided at either end of a vertical protective structure and should extend landward for a horizontal distance consistent with the local erosion rate and the design life of the structure.

Maintenance of Structures. Periodic maintenance of structures is necessary to repair the damage from storms and winter ice and to address the effects of flanking and off-shore profile deepening. The maintenance varies with the structural type, but annual inspections should be made by the property owners. For stone revetments, the replacement of stones that have been dislodged is necessary; timber bulkheads need to be backfilled if there has been a loss of upland material, and broken sheet pile should be replaced as necessary. Gabion baskets should be inspected for corrosion failure of the wire, usually caused either by improper handling during construction or by abrasion from the stones inside the baskets. Baskets should be replaced as necessary since waves will rapidly empty failed baskets.

Steel, timber, and aluminum bulkheads should be inspected for sheet pile failure due to active earth pressure or debris impact and for loss of backfill. For all structural types not contiguous to other structures, lengthening of flanking walls may be necessary every few years. Through periodic monitoring and required maintenance, a substantially greater percentage of coastal structures will perform effectively over their design life.

- d. *Plan and design all streambank, shoreline, and navigation structures so that they do not transfer erosion energy or otherwise cause visible loss of surrounding streambanks or shorelines.*

Many streambank or shoreline protection projects result in a transfer of energy from one area to another, which causes increased erosion in the adjacent area (USACE, 1981a). Property owners should consider the possible effects of erosion control measures on other properties located along the shore.

- e. *Establish and enforce no-wake zones to reduce erosion potential from boat wakes.*

No-wake zones should be given preference over posted speed limits in shallow coastal waters for reducing the erosion potential of boat wakes on streambanks and shorelines. Posted speed limits on waterways generally restrict the movement of recreational boating traffic to speeds in the range of 6-8 knots, but motorboats traveling at these speeds in shallow waters can be expected to throw wakes whose wave heights will be at or near the maximum size that can be produced by the boats.

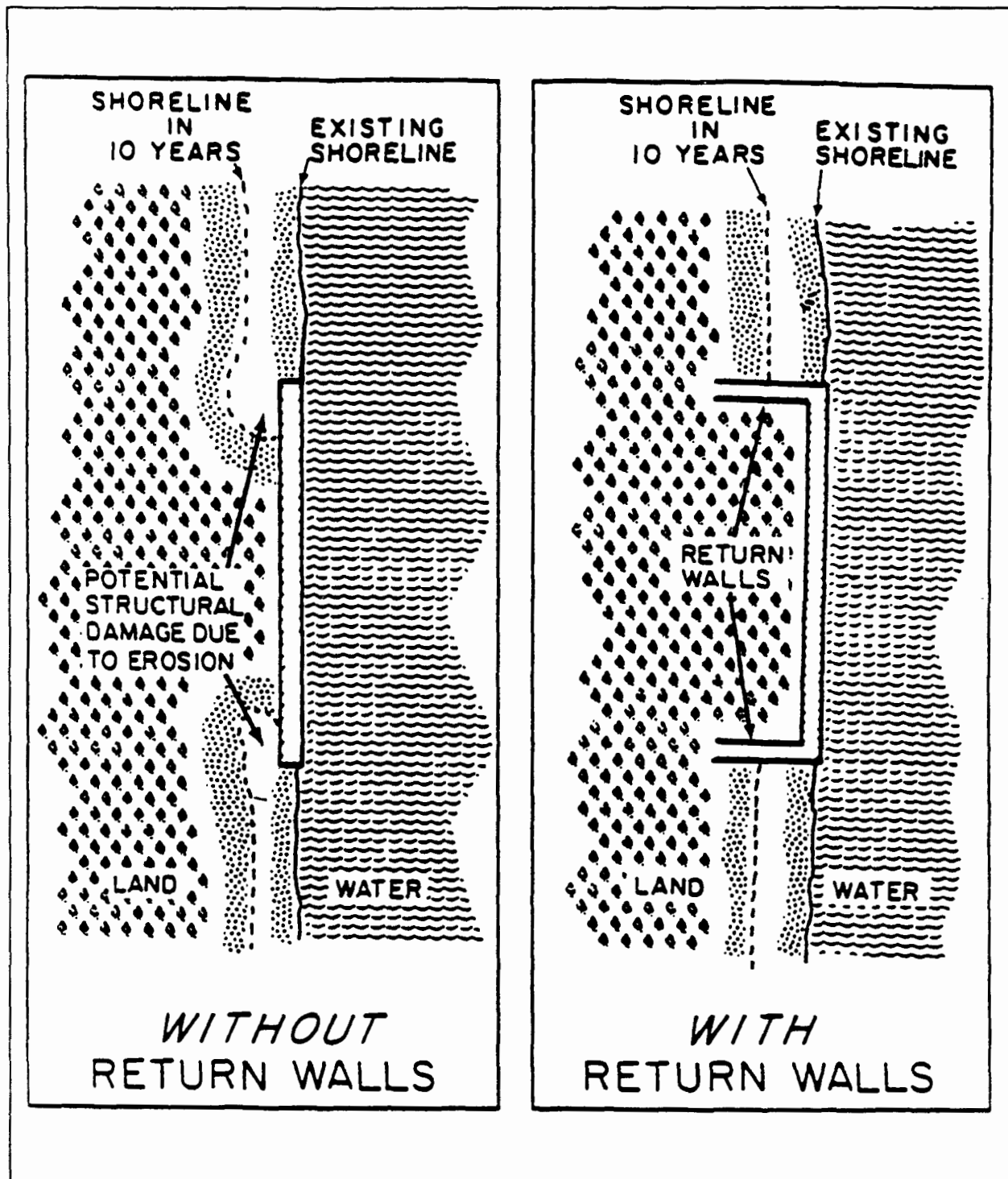

Figure 6-22. Example of return walls to prevent flanking in a bulkhead (Maryland Department of Natural Resources, 1982).

In theory, the boat speed that will produce the maximum wake depends on the depth of the water and the speed of the boat (Johnson, 1957). The ratio of these variables is called the Froude Number, named after an early scientific investigator of fluid mechanics. As the Froude Number (F) approaches 1, the wakes produced by a boat will reach

their maximum value. The relationship between the Froude Number, the boat speed, and the basin depth is described by the following equation (Johnson, 1957):

$$F = V_s / \sqrt{gd}$$

where:

- V_s = Velocity of boat speed (knots)
- g = Gravity constant (ft/sec²)
- d = Basin depth (ft)

It is important to note that this equation can be used only to describe the boat speed at which a maximum wake will occur in water of a known depth. The equation cannot be used to calculate the actual height of the maximum wake.

Table 6-5 contains values for F calculated for different combinations of boat speed and water depth, prepared as part of a study of wakes produced by recreational boating traffic on the Chesapeake Bay in Maryland (Maryland Department of Natural Resources, 1980). The dotted line drawn through this table shows those combinations for which F approximately equals 1. For instance, boats traveling 6 to 8 knots can be expected to produce their maximum wake in water depths of 4 to 6 feet, while boats traveling 10 to 12 knots can be expected to produce their maximum wake in water depths of 12 feet. These depths are typical of conditions in small creeks and coves in coastal areas where there is generally the greatest concern about shore erosion resulting from recreational motorboat traffic.

Table 6-5 was verified with field data collected in a shallow creek in Maryland's Chesapeake Bay for two types of motorboats. The results are presented in Figure 6-23. As predicted from Table 6-5, maximum wake heights were produced at speeds ranging from 6 to 8 knots. Wake heights did not increase with increasing speed.

These results show that boats can be expected to still produce damaging wakes as they slow from high speed to enter a narrow creek or cove with a posted 6-knot limit. Locating the speed reduction zones in open water, so that boats are slowing through the critical range of velocities far from shore, would reduce the potential for shore erosion from boat wakes. The designation of no-wake zones, rather than posted speed limits, would also reduce the potential for shore erosion from boat wakes.

- f. *Establish setbacks to minimize disturbance of land adjacent to streambanks and shorelines to reduce other impacts. Upland drainage from development should be directed away from bluffs and banks so as to avoid accelerating slope erosion.*

In addition to the soil bioengineering, marsh creation, beach nourishment, and structural practices discussed on the preceding pages of this guidance, another approach that should be considered in the planning process for shoreline and streambank erosion involves the designation of setbacks. Setbacks most often take the form of restrictions on the siting and construction of new standing structures along the shoreline. Where setbacks have been implemented to reduce the hazard of coastal land loss, they have also included requirements for the relocation of existing structures located within the designated setback area. Setbacks can also include restrictions on uses of waterfront areas that are not related to the construction of new buildings (Davis, 1987).

A recent report, *Managing Coastal Erosion* (NRC, 1990), summarizes the experience of coastal States in the implementation and administration of regulatory setback programs. The NRC report also discusses "the taking issue," which views setbacks as a severe restriction on the rights of private landowners to fill or build in designated setback areas. Setback regulations implemented in some States have been challenged in the courts on the grounds of "the taking issue," i.e., that the setback requirements are so restrictive that they "take" the value of the property without providing compensation to the property owners, violating the Fifth Amendment to the U.S. Constitution. The courts, however, have provided general approval of floodplain and wetlands regulations, and the NRC report concludes: "there is a strong legal basis for the broader use of setbacks for coastal construction based on the best available scientific estimates of future erosion rates."

**Table 6-5. Froude Number for Combinations of Water Depth and Boat Speed
(Maryland Department of Natural Resources, 1980)**

DEPTH (ft)	SPEED (Knots)								
	2	4	6	8	10	12	14	16	18
2	0.42	0.83	1.25	1.66	2.08	2.49	2.91	3.32	3.74
4	0.29	0.59	0.88	1.17	1.47	1.76	2.06	2.35	2.64
6	0.24	0.48	0.72	0.96	1.20	1.44	1.68	1.92	2.16
8	0.21	0.42	0.62	0.83	1.04	1.25	1.45	1.66	1.87
10	0.18	0.37	0.56	0.74	0.93	1.11	1.30	1.49	1.67
12	0.17	0.34	0.51	0.68	0.85	1.02	1.19	1.36	1.52
14	0.16	0.31	0.47	0.63	0.78	0.94	1.10	1.26	1.41
16	0.15	0.29	0.44	0.59	0.73	0.88	1.03	1.17	1.32
18	0.14	0.28	0.42	0.55	0.69	0.83	0.97	1.11	1.25

Table 6-6 contains a summary of State programs and experiences with setbacks. In most cases, States have used the local unit of government to administer the program on either a mandatory or voluntary basis. This allows local government to retain control of its land use activities and to exceed the minimum State requirements if this is deemed desirable (NRC, 1990).

Technical standards for defining and delineating setbacks also vary from State to State. One approach is to establish setback requirements for any "high hazard area" eroding at greater than 1 foot per year. Another approach is to establish setback requirements along all erodible shores because even a small amount of erosion can threaten homes constructed too close to the streambank or shoreline. Several States have general setback requirements that, while not based on erosion hazards, have the effect of limiting construction near the streambank or shoreline.

The basis for variations in setback regulations between States seems to be based on several factors, including (NRC, 1990):

- The language of the law being enacted;
- The geomorphology of the coast;
- The result of discretionary decisions;
- The years of protection afforded by the setback; and
- Other variables decided at the local level of government.

From the perspective of controlling NPS pollution resulting from erosion of shorelines and streambanks, the use of setbacks has the immediate benefit of discouraging concentrated flows and other impacts of storm water runoff from new development in areas close to the streambank or shoreline. These effects are described and discussed in Chapter 4 of this guidance document. In particular, the concentration of storm water runoff can aggravate the erosion of shorelines and streambanks, leading to the formation of gullies, which are not easily repaired. Therefore, drainage of storm water from developed areas and development activities located along the shoreline should be directed inland to avoid accelerating slope erosion.

The best NPS benefits are provided by setbacks that not only include restrictions on new construction along the shore but also contain additional provisions aimed at preserving and protecting coastal features such as beaches, wetlands,

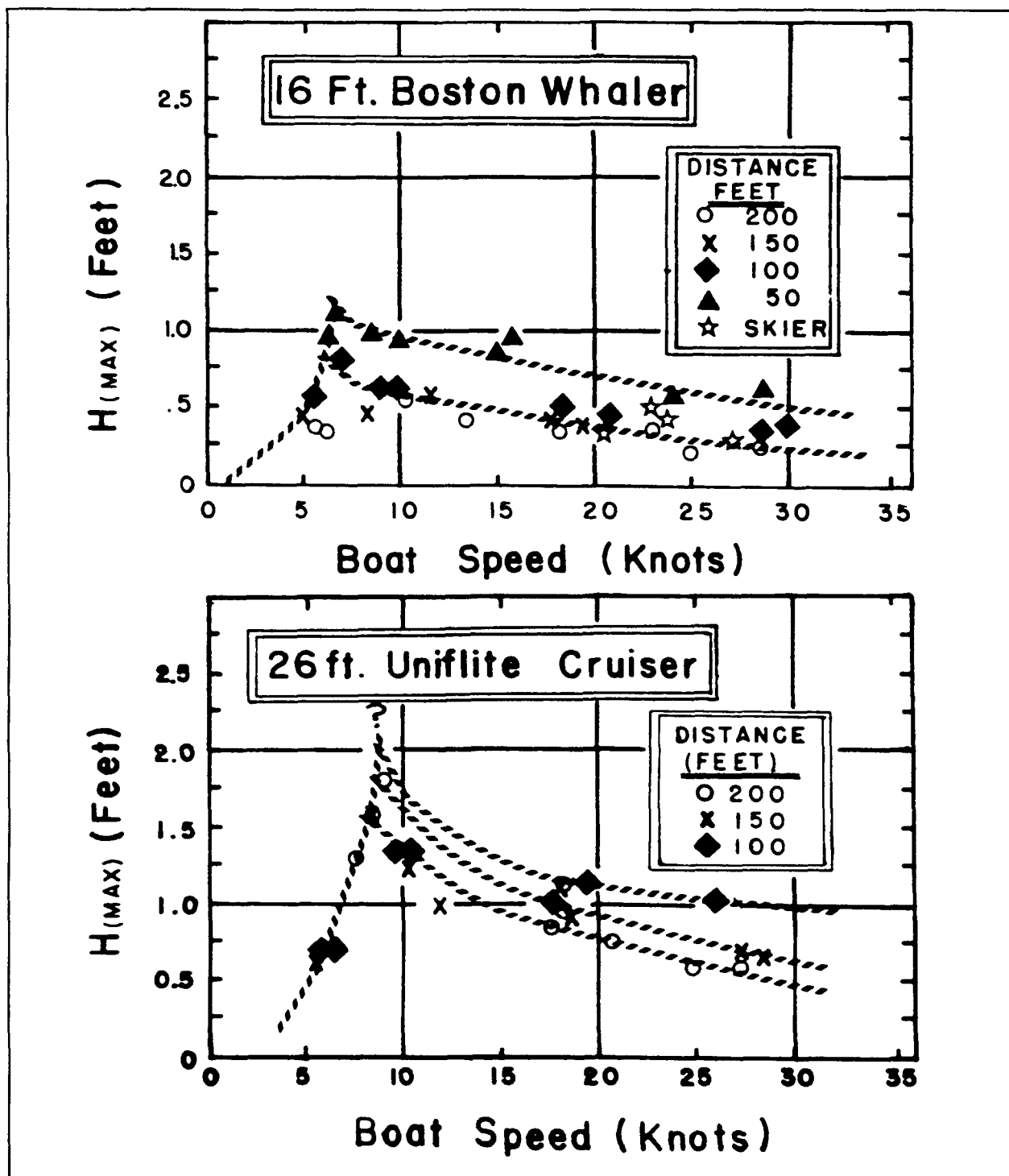

Figure 6-23. Wakes from two different types of boat hulls (Maryland Department of Natural Resources, 1980).

and riparian forests. This approach promotes the natural infiltration of surface water runoff before it passes over the edge of the bank or bluff and flows directly into the coastal waterbody. This approach also helps protect zones of naturally occurring vegetation growing along the shore. As discussed in the section on "bioengineering practices," the presence of undisturbed shoreline vegetation itself can help to control erosion by removing excess water from the bank and by anchoring the individual soil particles of the substrate.

Table 6-6. Examples of State Programs Defining Minimum Set-Backs (National Research Council, 1990)

State/Territory	Recession Rates from Aerial Photos	Recession Rates from Charts	Recession Rates from Ground Surveys	Erosion Setbacks Established ^a	Reference Feature	Years of Setback	Local Administration	One Foot per Year Standard	Fixed Setback	Floating Setback
Alabama	Y	Y	N	Y	MHW	NA	N	Y	N	
Alaska	Y	Y		N	NA	NA	NA	NA	NA	NA
American Samoa	N	N	N	N	NA	NA	NA	NA	NA	NA
California	Y	Y	Y	N	NA	NA	Y	NA	NA	NA
Connecticut	Y	Y		N	NA	NA	NA	NA	NA	NA
Delaware	Y	Y		Y4	TD	NA	Y	N	Y	N
Florida	Y	Y		Y5	NA	30	Y	N	Y	N
Georgia	Y	Y		N	NA	NA	NA	NA	NA	NA
Hawaii	N	N	N	Y	6	N	Y	N	Y	N
Indiana	Y	N	Y	N	NA	NA	NA	Y	NA	NA
Illinois	Y	Y	Y	N	NA	NA	NA		NA	NA
Louisiana	Y	Y	N	N	NA	NA	NA	NA	NA	NA
Maine	N	N	Y	N7	NA	NA	NA	NA	NA	NA
Maryland	Y	Y		N	NA	NA	NA	NA	NA	NA
Massachusetts	Y	Y	N	N	NA	NA	NA	NA	NA	NA
Michigan	Y	N	N	Y	BC2	30	Y	Y	N	Y
Minnesota	Y	N	N	N	NA	NA	NA	Y	NA	NA
Mississippi	N	N	N	N	NA	NA	NA	NA	NA	NA
New Hampshire	N	N	N	N	NA	NA	NA	NA	NA	NA
New Jersey	Y	Y	Y	Y	MHW	50				
New York	Y	Y	N	Y	BC	30-40	Y	Y	Y	N
North Carolina	Y	N		Y	DC	30-60	Y	N	N	Y
N. Mariana's	N	N	N	N	NA	NA	NA	NA	NA	NA
Ohio	Y	Y	N	N1	BC	30	NA	Y	Y	N
Oregon				N		NA	NA	NA	NA	NA
Pennsylvania	Y	N	Y	Y	BC	50+	Y	Y	N	Y
Puerto Rico	N	N	N	N	NA	NA	NA	NA		
Rhode Island	N	N	Y	Y	DC	30	N	N7	Y	N
South Carolina			Y	Y		40	BL		Y	N
Texas	Y	Y	Y	N	NA	NA	NA	NA	NA	NA
Virgin Islands	N	N	N	N	NA	NA	NA	NA	NA	NA
Virginia	Y	Y		N	MHW	NA	Y			
Washington				N	NA	NA	NA	NA	NA	NA
Wisconsin	Y	Y	N	N3	NA	NA	NA		N	Y

Note: 1 = setbacks may be established within 2 years; 2 = bluff crest or edge of active erosion; 3 = some counties have setbacks; 4 = has 100-foot setback regulation over new subdivisions and parcels where sufficient room exists landward of setback; 5 = not all counties have coastal construction control lines established; 6 = storm debris line or vegetation line; 7 = 2 feet per year standard. Y, yes; N, no; NA, not applicable; BC, bluff crest; MHW, mean high water; TD, toe of dune; DC, dune crest, toe of frontal dune or vegetation line; BL, base line. A blank means no information was available.

^aMost States have setbacks from water line but not based on an erosion hazard.

Almost all States with setback regulations have modified their original programs to improve effectiveness or correct unforeseen problems (NRC, 1990). States' experiences have shown that procedures for updating or modifying the setback width need to be included in the regulations. For instance, application of a typical 30-year setback standard in an area whose rate of erosion is 2 feet per year results in the designation of a setback width of 60 feet. This width may not be sufficient to protect the beaches, wetlands, or riparian forests whose presence improves the ability of the streambank or shoreline to respond to severe wave and flood conditions, or to high levels of surface water runoff during extreme precipitation events. A setback standard based on the landward edge of streambank or shoreline vegetation is one alternative that has been considered (NRC, 1990; Davis, 1987).

From the standpoint of NPS pollution control, the approach that best designates coastal wetlands, beaches, or riparian forests as a special protective feature, allows no development on the feature, and measures the setback from the landward side of the feature is recommended (NRC, 1990). In some cases, provisions for soil bioengineering, marsh creation, beach nourishment, or engineering structures may also be appropriate since the special protective features within the designated setbacks can continue to be threatened by uncontrolled erosion of the shoreline or streambank. Finally, setback regulations should recognize that some special features of the streambank or shoreline will change position. For instance, beaches and wetlands can be expected to migrate landward if water levels continue to rise as a result of global warming. Alternatives for managing these situations include flexible criteria for designating setbacks, vigorous maintenance of beaches and other special features within the setback area, and frequent monitoring of the rate of streambank or shoreline erosion and corresponding adjustment of the setback area.

5. Costs for All Practices

This section describes costs for representative activities that would be undertaken in support of one or more of the practices listed under this management measure. The description of the costs is grouped into the following three categories: (1) costs for streambank and shoreline stabilization with vegetation; (2) costs for streambank and shoreline stabilization with engineering structures; and (3) costs for designation and enforcement of boating speed limits.

a. *Vegetative Stabilization for Shorelines and Streambanks*

Representative costs for this practice can include costs for wetland plants and riparian area vegetation, including trees and shrubs. Additional costs could be incurred depending on the level of site preparation that is required. The items of work could include (1) clearing the site of fallen trees and debris; (2) extensive site work requiring heavy construction equipment; (3) application of seed stock or sprigging of nursery-reared plants; (4) application of fertilizer (most typically for marsh creation); and (5) postproject maintenance and monitoring. For a more extensive description of these tasks, refer to the sections of Chapter 7 describing marsh restoration efforts.

- (1) Costs reported in 1989 for bottomland forest plants using direct seeding were \$40 to \$60 per acre (NRC, 1991). If vegetation is assumed to be planted across a 50-foot width along the shoreline or streambank, the cost per linear foot of shore or streambank, in 1990 dollars, can be calculated as \$0.05 - \$0.08/foot.
- (2) Costs reported in 1990 for nursery-reared tree seedlings were \$212.50 per acre (Illinois Department of Conservation, 1990). If vegetation is assumed to be planted across a 50-foot width along the shoreline or streambank, the costs per linear foot of shore or streambank, in 1990 dollars, can be calculated as \$0.25/foot.
- (3) Costs reported for restoration of riparian areas in Utah between 1985 and 1988 included extensive site work: bank grading, installation of riprap and sediment traps in deep gullies, planting of juniper trees and willows, and fencing to protect the sites from intrusion by livestock. Assuming a 100-foot width along the shore or streambank for this work, the reported costs, in 1990 dollars, of \$2,527 per acre can be calculated as \$5.94 per foot.
- (4) Costs were reported in 1988 for vegetative erosion control projects involving creation of tidal fringe marsh, using nursery-reared *Spartina alterniflora* and *S. patens* along the shorelines of the Chesapeake

Bay in Maryland (Maryland Eastern Shore Resource Conservation and Development Area). Two projects involving marsh creation along a total of 4,650 linear feet of shoreline averaged \$20.48 per foot. Costs of 12 projects involving marsh creation combined with grading and seeding of the shoreline bank ranging in height from 5 to 12 feet averaged \$54.82 per foot along a total of 8,465 feet. These costs can be calculated in 1990 dollars as:

Marsh creation - no bank grading	\$21.44 per foot
Marsh creation - bank grading	\$57.40 per foot

b. Structural Stabilization for Shorelines and Streambanks

Representative costs for structural stabilization typically include costs for survey and design and for extensive site work, including costs to gain access for trucks and front-end loaders necessary to place the stone (for revetments) or sheet pile (for bulkheads). As indicated in the data described below for specific projects, costs frequently vary depending on the level of wave exposure at the site and on the overall length of shoreline or streambank that is being protected in a single project. In some of the examples shown below, construction costs were reported along with design and administration costs. For cases where only installation costs were reported in the source document, a total project cost was computed by adding 15 percent of first construction costs to the reported installation cost, and then dividing by the reported project length to compute cost per foot. Thus, all costs shown below include design and administration costs.

- (1) Costs for timber bulkhead on private property along 100 linear feet of shore on Cabin Creek, York County, Virginia (less than 2 miles of wave exposure), in 1990 dollars, were \$69 per foot (Virginia Department of Conservation and Recreation, undated).
- (2) Costs for replacement of timber bulkhead on private property along 375 linear feet of shore on the Rappahannock River, Middlesex County, Virginia (2 to 5 miles of wave exposure), in 1990 dollars, were \$60 per foot (Virginia Department of Conservation and Recreation, undated).
- (3) Costs for timber bulkhead at Whidbey Island Naval Air Station, Oak Harbor, Washington (more than 5 miles of wave exposure), in 1990 dollars, were \$129 per foot (USACE, 1981a).
- (4) Costs for timber and steel bulkhead along 200 feet of shoreline of a County park at Port Wing, Bayfield County, Wisconsin (more than 5 miles of exposure), in 1990 dollars, were \$356 per foot (USACE, 1981a).
- (5) Costs for stone revetment on private property along 270 feet of shoreline on Linkhorn Bay, Virginia Beach, Virginia (less than 2 miles of wave exposure), in 1990 dollars, were \$63 per foot (Virginia Department of Conservation and Recreation, undated).
- (6) Costs for stone revetment and bank grading along 420 linear feet of shoreline on James River, Surry County, Virginia (2 to 5 miles of exposure), in 1990 dollars, were \$342 per foot (Virginia Department of Conservation and Recreation, undated).
- (7) Costs for stone revetment on private community property along 2000 linear feet of shoreline on Lorain Harbor, Ohio (more than 5 miles of exposure), in 1990 dollars, were \$1,093 per foot (USACE, 1981b).
- (8) Costs for beachfill and dune construction on a city public beach along 10,000 feet of shoreline at North Nantasket Beach, Hull, Massachusetts (more than 5 miles of exposure), in 1990 dollars, were \$162 per foot (USACE, 1988).
- (9) Costs for six riprap and six gabion breakwaters with beachfill on State Wildlife Management Area property along 1250 linear feet of shore on the James River, Surry County, Virginia (2 to 5 miles of exposure), in 1990 dollars, were \$62 per foot (Hardaway et al., 1991).

- (10) Costs for breakwaters, beachfill, and beachgrass planting at a County park along 1100 feet of shoreline at Elm's Beach, Chesapeake Bay, Maryland (more than 5 miles of exposure), in 1990 dollars, were \$292 per foot (Hardaway and Gunn, 1991).
- (11) Costs for breakwaters, beachfill, and revetment along 11,000 feet of shoreline at Maumee Bay State Park, Ohio (more than 5 miles of exposure), in 1990 dollars, were \$961 per foot (USACE, 1982).

c. Designation and Enforcement of Boating Speed Limits

Representative costs for this practice can be broken down into the following two tasks:

- (1) Providing notification of a posted speed limit or "no-wake" zone in navigational channels along coastal waterways. One approach used to advise boaters of posted speed limits is the placement of marked buoys along the channel in speed reduction zones. Alternatively, signs designating speed reduction zones can be placed on pilings that are driven into the bottom of the coastal creek or bay. In narrow creeks or coves, signs can be mounted onshore along the streambank. The number of signs, buoys, or beacons that will be required will depend on the length and configuration of the channel. For a channel 1 mile in length that is fairly straight and linear, with good visibility on both the downstream and upstream approaches, three posted speed limit signs could be deployed for upstream traffic and three for downstream traffic. Representative costs for this practice, in 1990 dollars, can be estimated from data provided by the Maryland Department of Natural Resources Marine Police Administration. These costs include all labor, materials, and installation:
- (a) Costs for purchasing, marking, and setting six buoys at \$285 each are \$1,710.
 - (b) Costs for six onshore signs mounted on 2-ft by 3-ft by 8-ft posts at \$165 each are \$990.
 - (c) Costs for six channel beacons mounted on offshore 4-ft by 4-ft by 42-ft pilings at \$1,850 each are \$11,100.
- (2) The enforcement of designated boating speed limit zones, which can be expected to include costs for the acquisition and maintenance of marine police vessels and costs for marine police personnel to monitor boating patterns. Representative costs, in 1990 dollars, which are incurred for these items by the Maryland Department of Natural Resources (Gwynne Schultz, personal communication, 1992) are listed below:
- (a) One large patrol boat (suitable for areas of open water in coastal bays or rivers):

Acquisition	\$180,000
Annual maintenance per vessel per year	\$ 2,000
Crew of three marine police	\$ 90,000
 - (b) One small patrol boat (suitable for protected creeks and coves):

Acquisition	\$20,000
Annual maintenance per vessel per year	\$ 2,000
Crew of two marine police	\$60,000

These costs do not consider overtime that is provided to members of the Maryland Marine Police for any shift greater than 8 hours in length. No overtime is paid for holidays.

V. GLOSSARY

Accretion: May be either *natural* or *artificial*. Natural accretion is the buildup of land, solely by the action of the forces of nature, on a beach by deposition of waterborne or airborne material. Artificial accretion is a similar buildup of land by reason of an act of humans, such as the accretion formed by a groin, breakwater, or beach fill deposited by mechanical means. Also known as aggradation. (USACE, 1984)

Alongshore: Parallel to and near the shoreline; *longshore* (USACE, 1984).

Armor unit: A relatively large quarrystone or concrete shape that is selected to fit specified geometric characteristics and density. Armor units are usually uniform in size and usually large enough to require individual placement. In normal cases armor units are used as primary wave protection and are placed in thicknesses of at least two units. (USACE, 1984)

Artificial nourishment: The process of replenishing a beach with material (usually sand) obtained from another location (USACE, 1984).

Backshore: That zone of the shore or beach lying between the foreshore and the coastline comprising the *berm* or *berms* and acted upon by waves only during severe storms, especially when combined with exceptionally high water (USACE, 1984).

Bank: (1) The rising ground bordering a lake, river, or sea; or of a river or channel, for which it is designated as right or left as the observer is facing downstream. (2) An elevation of the sea floor or large area, located on a continental (or island) shelf and over which the depth is relatively shallow but sufficient for safe surface navigation; a group of shoals. (3) In its secondary sense, used only with a qualifying word such as "sandbank" or "gravelbank," a shallow area consisting of shifting forms of silt, sand, mud, and gravel. (USACE, 1984)

Bar: A submerged or emerged embankment of sand, gravel, or other unconsolidated material built on the sea floor in shallow water by waves and currents (USACE, 1984).

Barrier beach: A bar essentially parallel to the shore, the crest of which is above normal high water level (USACE, 1984).

Basin, boat: A naturally or artificially enclosed or nearly enclosed harbor area for small craft (USACE, 1984).

Bathymetry: The measurement of depths of water in oceans, seas, and lakes; also information derived from such measurements (USACE, 1984).

Bay: A recess in the shore or an inlet of a sea between two capes or headlands, not so large as a gulf but larger than a cove (USACE, 1984).

Bayou: A minor sluggish waterway or estuarine creek, tributary to, or connecting, other stream or bodies of water, whose course is usually through lowlands or swamps (USACE, 1984).

Beach: The zone of unconsolidated material that extends landward from the low water line to the place where there is marked change in material or physiographic form, or to the line of permanent vegetation (usually the effective limit of storm waves). The seaward limit of a beach—unless otherwise specified—is the mean low water line. A beach includes *foreshore* and *backshore*. See also *shore*. (USACE, 1984)

Beach planting: The placement of vegetation in the zone of sedimentary material that extends landward from the low water line to the place where there is marked change in material or form, or to the line of permanent vegetation.

Beach accretion: See *accretion* (USACE, 1984).

Beach berm: A nearly horizontal part of the beach or backshore formed by the deposit of material by wave action. Some beaches have no berms; others have one or several. (USACE, 1984)

Beach erosion: The carrying away of beach materials by wave action, tidal currents, littoral currents, or wind (USACE, 1984).

Beach face: The section of the beach normally exposed to the action of the wave uprush. The *foreshore* of a beach (not synonymous with *shoreface*). (USACE, 1984)

Beach fill: Material placed on a beach to renourish eroding shores (USACE, 1984).

Beach width: The horizontal dimension of the beach measured normal to the shoreline (USACE, 1984).

Bench mark: A permanently fixed point of known elevation. A primary bench mark is one close to a tide station to which the tide staff and tidal datum originally are referenced. (USACE, 1984)

Bluff: A high, steep bank or cliff (USACE, 1984).

Bottom: The ground or bed under any body of water; the bottom of the sea (USACE, 1984).

Bottom (nature of): The composition or character of the bed of an ocean or other body of water (e.g., clay, coral, gravel, mud, ooze, pebbles, rock, shell, shingle, hard, or soft) (USACE, 1984).

Boulder: A rounded rock more than 10 inches in diameter; larger than a cobblestone. See *soil classification*. (USACE, 1984)

Breakwater: A structure or partition to retain or prevent sliding of the land. A secondary purpose is to protect the upland against damage from wave action. (USACE, 1984)

Bulkhead: A structure or partition to retain or prevent sliding of the land. A secondary purpose is to protect the upland against damage from wave action. (USACE, 1984)

Bypassing, sand: Hydraulic or mechanical movement of sand from the accreting updrift side to the eroding downdrift side of an inlet or harbor entrance. The hydraulic movement may include natural movement as well as movement caused by humans. (USACE, 1984)

Canal: An artificial watercourse cut through a land area for such uses as navigation and irrigation (USACE, 1984).

Cape: A relatively extensive land area jutting seaward from a continent or large island that prominently marks a change in, or interrupts notably, the coastal trend; a prominent feature (USACE, 1984).

Channel: (1) A natural or artificial waterway or perceptible extent that either periodically or continuously contains moving water, or that forms a connecting link between two bodies of water. (2) The part of a body of water deep enough to be used for navigation through an area otherwise too shallow for navigation. (3) A large strait, as the English Channel. (4) The deepest part of a stream, bay, or strait through which the main volume or current of water flows. (USACE, 1984)

Channelization and channel modification: River and stream channel engineering for the purpose of flood control, navigation, drainage improvement, and reduction of channel migration potential; activities include the straightening, widening, deepening, or relocation of existing stream channels, clearing or snagging operations, the excavation of borrow pits, underwater mining, and other practices that change the depth, width, or location of waterways or embayments in coastal areas.

Clay: See *soil classification* (USACE, 1984).

Cliff: A high, steep face of rock; a precipice (USACE, 1984).

Coast: A strip of land of indefinite width (may be several kilometers) that extends from the shoreline inland to the first major change in terrain features (USACE, 1984).

Coastal area: The land and sea area bordering the shoreline (USACE, 1984).

Coastal plain: The plain composed of horizontal or gently sloping strata of clastic materials fronting the coast, and generally representing a strip of sea bottom that has emerged from the sea in recent geologic time (USACE, 1984).

Coastline: (1) Technically, the line that forms the boundary between the *coast* and the *shore*. (2) Commonly, the line that forms the boundary between the land and the water. (USACE, 1984)

Cobble (cobblestone): See *soil classification* (USACE, 1984).

Continental shelf: The zone bordering a continent and extending from the low water line to the depth (usually about 180 meters) where there is a marked or rather steep descent toward a greater depth.

Contour: A line on a map or chart representing points of equal elevation with relation to a datum. It is called an isobath when it connects points of equal depth below a datum. Also called depth contour. (USACE, 1984)

Controlling depth: The least depth in the navigable parts of a waterway, governing the maximum draft of vessels that can enter (USACE, 1984).

Convergence: (1) In refraction phenomena, the decreasing of the distance between orthogonals in the direction of wave travel. Denotes an area of increasing wave height and energy concentration. (2) In wind-setup phenomena, the increase in setup observed over that which would occur in an equivalent rectangular basin of uniform depth, caused by changes in plainform or depth; also the decrease in basin width or depth causing such an increase in setup (USACE, 1984).

Cove: A small, sheltered recess in a coast, often inside a larger embayment. (USACE, 1984)

Current: A flow of water (USACE, 1984).

Current, coastal: One of the offshore currents flowing generally parallel to the shoreline in the deeper water beyond and near the surf zone. Such currents are not related genetically to waves and resulting surf, but may be related to tides, winds, or distribution of mass. (USACE, 1984)

Current, drift: A broad, shallow, slow-moving ocean or lake current. Opposite of *current, stream*. (USACE, 1984)

Current, ebb: The tidal current away from shore or down a tidal stream. Usually associated with the decrease in the height of the tide. (USACE, 1984)

Current, flood: The tidal current toward shore or up a tidal stream. Usually associated with the increase in the height of the tide. (USACE, 1984)

Current, littoral: Any current in the littoral zone caused primarily by wave action; e.g., longshore current, rip current. See also *current, nearshore*. (USACE, 1984)

Current, longshore: The littoral current in the breaker zone moving essentially parallel to the shore, usually generated by waves breaking at an angle to the shoreline (USACE, 1984).

Current, nearshore: A current in the *nearshore zone* (USACE, 1984).

Current, offshore: See *offshore current* (USACE, 1984).

Current, tidal: The alternating horizontal movement of water associated with the rise and fall of the tide caused by the astronomical tide-producing forces. Also *current, periodic*. See also *current, flood* and *current, ebb*. (USACE, 1984)

Cutoff: Wall, collar, or other structure, such as a trench, filled with relatively impervious material intended to reduce seepage of water through porous strata; in river hydraulics, the new and shorter channel formed either naturally or artificially when a stream cuts through the neck of a band.

Deep water: Water so deep that surface waves are little affected by the ocean bottom. Generally, water deeper than one-half the surface wavelength is considered deep water. Compare *shallow water*. (USACE, 1984)

Delta: An alluvial deposit, roughly triangular or digitate in shape, formed at a river mouth (USACE, 1984).

Depth: The vertical distance from a specified tidal datum to the sea floor (USACE, 1984).

Depth of breaking: The still-water depth at the point where the wave breaks (USACE, 1984).

Detritus: Loose material worn or broken away from a mass, as by the action of water, usually carried from inland sources by streams (USACE, 1981a).

Dike (dyke): A channel stabilization structure sited in a river or stream perpendicular to the bank.

Downdrift: The direction of predominant movement of littoral materials (USACE, 1984).

Drift (noun): (1) Sometimes used as a short form for *littoral drift*. (2) The speed at which a current runs. (3) Floating material deposited on a beach (driftwood). (4) A deposit of a continental ice sheet; e.g., a drumlin. (USACE, 1984)

Dunes: (1) Ridges or mounds of loose, wind-blown material, usually sand. (2) Bed forms smaller than bars but larger than ripples that are out of phase with any water-surface gravity waves associated with them (USACE, 1984).

Ebb tide: The period of tide between high water and the succeeding low water; a falling tide (USACE, 1984).

Embankment: An artificial bank such as a mound or dike, generally built to hold back water or to carry a roadway (USACE, 1984).

Embayment: An indentation in the shoreline forming an open bay (USACE, 1984).

Ephemeral: Lasting for a brief time; short-lived; transitory (Morris, 1978).

Erosion: The wearing away of land by the action of natural forces. On a beach, the carrying away of beach material by wave action, tidal currents, littoral currents, or by deflation (USACE, 1984).

Estuary: (1) The part of the river that is affected by tides. (2) The region near a river mouth in which the fresh water in the river mixes with the salt water of the sea (USACE, 1984).

Eutrophication: The alteration of lake ecology through excessive nutrient input, characterized by excessive growth of aquatic plants and algae and low levels of dissolved oxygen (USEPA, 1992).

Fastland: Land near the shoreline that is safely above the erosive zone of waves and tides. The area landward of the bank.

Fetch: The area in which seas are generated by a wind having a fairly constant direction and speed. Sometimes used synonymously with fetch length (USACE, 1984).

Flood tide: The period of tide between low water and the succeeding high water; a rising tide (USACE, 1984).

Flow alteration: A category of hydromodification activities that results in either an increase or a decrease in the usual supply of fresh water to a stream, river, or estuary.

Foreshore: The part of the shore, lying between the crest of the seaward berm (or upper limit of wave wash at high tide) and the ordinary low-water mark, that is ordinarily traversed by the uprush and back rush of the waves as the tides rise and fall. See *beach face*. (USACE, 1984)

Freeboard: The additional height of a structure above design high-water level to prevent overflow. Also, at a given time, the vertical distance between the water level and the top of the structure. On a ship, the distance from the waterline to main deck or gunwale (USACE, 1984).

Froude number: The dimensionless ratio of the inertial force to the force of gravity for a given fluid flow. It may be given as $Fr = V/Lg$, where V is a characteristic velocity, L is a characteristic length, and g the acceleration of gravity—or as the square root of this number. (USACE, 1984)

Gabion: A rectangular basket or mattress made of galvanized, and sometimes PVC-coated, steel wire in a hexagonal mesh. Gabions are generally subdivided into equal-sized cells that are wired together and filled with 4- to 8-inch-diameter stone, forming a large, heavy mass that can be used as a shore-protection device. (USACE, 1990)

Generation of waves: (1) The creation of waves by natural or mechanical means. (2) The creation and growth of waves caused by a wind blowing over a water surface for a certain period of time (USACE, 1984).

Geomorphology: That branch of both physiography and geology that deals with the form of the Earth, the general configuration of its surface, and the changes that take place in the evolution of landform (USACE, 1984).

Grade stabilization structure: A structure used to control the grade and head cutting in natural or artificial channels (USDA-SCS, 1988).

Gradient (grade): See *slope*. With reference to winds or currents, the rate of increase or decrease in speed, usually in the vertical; or the curve that represents this rate (USACE, 1984).

Gravel: See *soil classification* (USACE, 1984).

Groin: A shore protection structure built (usually perpendicular to the shoreline) to trap littoral drift or retard erosion of the shore (USACE, 1984).

Groin system: A series of groins acting together to protect a section of beach. Commonly called a groin field. (USACE, 1984)

Ground water: Subsurface water occupying the zone of saturation. In a strict sense, the term is applied only to water below the water table (USACE, 1984).

Habitat: The place where an organism naturally lives or grows.

Harbor: Any protected water area affording a place of safety for vessels. See also *port*. (USACE, 1984)

Headland breakwater: A shore-connected breakwater (USACE, 1990).

Headland (head): A high, steep-faced promontory extending into the sea (USACE, 1984).

Height of wave: See *wave height* (USACE, 1984).

High tide, high water: The maximum elevation reached by each rising tide (USACE, 1984).

High water line: The intersection of the plane of mean high water with the shore. The shoreline delineated on the nautical charts of the National Ocean Service is an approximation of the high water line. For specific occurrences, the highest elevation on the shore reached during a storm or rising tide, including meteorological effects (USACE, 1984).

Hurricane: An intense tropical cyclone in which winds tend to spiral inward toward a core of low pressure, with maximum surface wind velocities that equal or exceed 33.5 meters per second (75 mph or 65 knots) for several minutes or longer at some points. *Tropical storm* is the term applied if maximum winds are less than 33.5 meters per second. (USACE, 1984)

Hydrography: (1) A configuration of an underwater surface including its relief, bottom materials, coastal structures, etc. (2) The description and study of seas, lakes, rivers, and other waters (USACE, 1984).

Hydrologic modification: The alteration of the natural circulation or distribution of water by the placement of structures or other activities (USEPA, 1992).

Hydromodification: Alteration of the hydrologic characteristics of coastal and noncoastal waters, which in turn could cause degradation of water resources.

Impoundment: The collection and confinement of water as in a reservoir or dam.

Inlet: (1) A short, narrow waterway connecting a bay, lagoon, or similar body of water with a large parent body of water. (2) An arm of the sea (or other body of water) that is long compared to its width and may extend a considerable distance inland. See also *tidal inlet*. (USACE, 1984)

Inshore (zone): In beach terminology, the zone of variable width extending from the low water line through the breaker zone. See also *shoreface*. (USACE, 1984)

Jetty: (United States usage) On open seacoasts, a structure extending into a body of water, which is designed to prevent shoaling of a channel by littoral materials and to direct and confine the stream or tidal flow. Jetties are built at the mouths of rivers or tidal inlets to help deepen and stabilize a channel. (USACE, 1984)

Lagoon: A shallow body of water, like a pond or lake, usually connected to the sea (USACE, 1984).

Levee: An embankment or shaped mound for flood control or hurricane protection (USACE, 1981a).

Littoral: Of or pertaining to a shore, especially of the sea (USACE, 1984).

Littoral current: See *current, littoral* (USACE, 1984).

Littoral drift: The sedimentary material moved in the littoral zone under the influence of waves and currents (USACE, 1984).

Littoral transport: The movement of littoral drift in the littoral zone by waves and currents. Includes movement parallel (longshore transport) and perpendicular (on-offshore transport) to the shore (USACE, 1984).

Littoral zone: In beach terminology, an indefinite zone extending seaward from the shoreline to just beyond the breaker zone (USACE, 1984).

Load: The quantity of sediment transported by a current. It includes the suspended load of small particles and the bedload of large particles that move along the bottom. (USACE, 1984)

Longshore: Parallel to and near the shoreline; *alongshore* (USACE, 1984).

Longshore current: See *current, longshore*.

Longshore transport rate: Rate of transport of sedimentary material parallel to the shore. Usually expressed in cubic meters (cubic yards) per year. Commonly synonymous with *littoral transport rate*. (USACE, 1984)

Low tide, low water: The minimum elevation reached by each falling tide. See *tide*. (USACE, 1984)

Low water datum: An approximation to the plane of mean low water that has been adopted as a standard reference plane (USACE, 1984).

Mangrove: A tropical tree with interlacing prop roots, confined to low-lying brackish areas (USACE, 1984).

Marsh: An area of soft, wet, or periodically inundated land, generally treeless and usually characterized by grasses and other low growth (USACE, 1984).

Marsh, salt: A marsh periodically flooded by salt water (USACE, 1984).

Marsh vegetation: Plants that grow naturally in a marsh.

Mean high water: The average height of the high waters over a 19-year period. For shorter periods of observations, corrections are applied to eliminate known variations and reduce the results to the equivalent of a mean 19-year value. All low-water heights are included in the average where the type of field is either semidiurnal or mixed. Only lower-low water heights are included in the average where the type of tide is diurnal. So determined, mean low water in the latter case is the same as mean lower low water.

Mean sea level: The average height of the surface of the sea for all stages of the tide over a 19-year period, usually determined from hourly height readings. Not necessarily equal to *mean tide level*. (USACE, 1984)

Mean tide level: A plane midway between *mean high water* and *mean low water*. Not necessarily equal to *mean sea level*. (USACE, 1984)

Meander: A bend in a river.

Mud: A fluid-to-plastic mixture of finely divided particles of solid material and water (USACE, 1984).

Nearshore (zone): In beach terminology an indefinite zone extending seaward from the shoreline well beyond the breaker zone. It defines the area of *nearshore currents*. (USACE, 1984)

Nearshore current system: The current system that is caused primarily by wave action in and near the breaker zone and consists of four parts: the shoreward mass transport of water; longshore currents; the seaward return flow, including rip currents; and the longshore movement of the expanding heads of rip currents (USACE, 1984).

Nourishment: The process of replenishing a beach. It may be brought about naturally by longshore transport or artificially by the deposition of dredged materials. (USACE, 1984)

Oceanography: The study of the sea, embracing and indicating all knowledge pertaining to the sea's physical boundaries, the chemistry and physics of seawater, and marine biology (USACE, 1984).

Offshore: (1) In beach terminology, the comparatively flat zone of variable width, extending from the breaker zone to the seaward edge of the Continental Shelf. (2) A direction seaward from the shore. (USACE, 1984)

Offshore current: (1) Any current in the offshore zone. (2) Any current flowing away from shore. (USACE, 1984)

Onshore: A direction landward from the sea (USACE, 1984).

Overtopping: Passing of water over the top of a structure as a result of wave runup or surge action (USACE, 1984).

Overwash: That portion of the uprush that carries over the crest of a berm or of a structure (USACE, 1984).

Oxbow: An isolated lake formed by a bend in a river that becomes disconnected from the river channel.

Parapet: A low wall built along the edge of a structure such as a seawall or quay (USACE, 1984).

Peninsula: An elongated body of land nearly surrounded by water and connected to a large body of land (USACE, 1984).

Percolation: The process by which water flows through the interstices of a sediment. Specifically, in wave phenomena, the process by which wave action forces water through the interstices of the bottom sediment and which tends to reduce wave heights. (USACE, 1984)

Pier: A structure, usually of open construction, extending out into the water from the shore, to serve as a landing place, recreational facility, etc., rather than to afford coastal protection. In the Great Lakes, a term sometimes improperly applied to jetties. (USACE, 1984)

Pile: A long, heavy timber or section of concrete or metal to be driven or jettied into the earth or seabed to serve as a support or protection (USACE, 1984).

Pile, sheet: A pile with a generally slender flat cross section to be driven into the ground or seabed and meshed or interlocked with like members to form a diaphragm, wall, or bulkhead (USACE, 1984).

Piling: A group of piles (USACE, 1984).

Plain, coastal: See *coastal plain* (USACE, 1984).

Plainform: The outline or shape of a body of water as determined by the stillwater line (USACE, 1984).

Point: The extreme end of a cape; the outer end of any land area protruding into the water, usually less prominent than a cape (USACE, 1984).

Port: A place where vessels may discharge or receive cargo; it may be the entire harbor, including its approaches and anchorages, or only the commercial part of a harbor where quays, wharves, facilities for transfer of cargo, docks, and repair shops are situated (USACE, 1984).

Preexisting: Existing before a specified time or event (Morris, 1978).

Profile, beach: The intersection of the ground surface with a vertical plane; may extend from the top of the dune line to the seaward limit of sand movement (USACE, 1984).

Quarrystone: Any stone processed from a quarry (USACE, 1984).

Recession (of a beach): (1) A continuing landward movement of the shoreline. (2) A net landward movement of the shoreline over a specified time (USACE, 1984).

Reflected wave: That part of an incident wave that is returned seaward when a wave impinges on a steep beach, barrier, or other reflecting surface (USACE, 1984).

Refraction (of water waves): (1) The process by which the direction of a wave moving in shallow water at an angle to the contours is changed; the part of the wave advancing in shallower water moves more slowly than that part still advancing in deeper water, causing the wave crest to bend toward alignment with the underwater contours. (2) The bending of wave crests by currents. (USACE, 1984)

Retreat: To move in a landward direction away from an eroding streambank or shoreline.

Revetment: A facing of stone, concrete, etc., built to protect a scarp, embankment, or shore structure against erosion by wave action or currents (USACE, 1984).

Riparian: Pertaining to the banks of a body of water (USACE, 1984).

Riparian area: Vegetated ecosystems along a waterbody through which energy, materials, and water pass. Riparian areas characteristically have a high water table and are subject to periodic flooding and influence from the adjacent waterbody. These systems encompass wetlands, uplands, or some combination of these two land forms; they will not in all cases have all of the characteristics necessary for them to be classified as wetlands. (Mitsch and Gosselink, 1986; Lowrance et al., 1988)

Riprap: A protective layer or facing of quarrystone, usually well graded within wide size limit, randomly placed to prevent erosion, scour, or sloughing of an embankment of bluff; also the stone so used. The quarrystone is placed in a layer at least twice the thickness of the 50 percent size, or 1.25 times the thickness of the largest size stone in the gradation.

Rubble: (1) Loose, angular, waterworn stones along a beach. (2) Rough, irregular fragments of broken rock. (USACE, 1984)

Rubble-mound structure: A mound of randomly-shaped and randomly-placed stones protected with a cover layer of selected stones or specially shaped concrete armor units. (Armor units in a primary cover layer may be placed in an orderly manner or dumped at random.) (USACE, 1984)

Run-of-the-river dam: Usually a low dam with small hydraulic head, limited storage area, short detention time, and no positive control over lake storage.

Runup: The rush of water up a structure or beach on the breaking of a wave. Also *uprush*, *swash*. The amount of runup is the vertical height above still-water level to which the rush of water reaches. (USACE, 1984)

Salt marsh: A marsh periodically flooded by salt water (USACE, 1984).

Sand: See *soil classification* (USACE, 1984).

Sandbar: (1) See *bar*. (2) In a river, a ridge of sand built up to or near the surface by river currents. (USACE, 1984)

Sand bypassing: See *bypassing, sand* (USACE, 1984).

Scour: Removal of underwater material by waves and currents, especially at the base or toe of a shore structure (USACE, 1984).

Seawall: A structure separating land and water areas, primarily designed to prevent erosion and other damage due to wave action (USACE, 1984).

Shoal (noun): A detached elevation of the sea bottom, composed of any material except rock or coral, which may endanger surface navigation (USACE, 1984).

Shoal (verb): (1) To become shallow gradually. (2) To cause to become shallow. (3) To proceed from a greater to a lesser depth of water. (USACE, 1984)

Shore: The narrow strip of land in immediate contact with the sea, including the zone between high and low water lines. A shore of unconsolidated material is usually called a *beach*. (USACE, 1984)

Shoreface: The narrow zone seaward from the low tide *shoreline*, covered by water, over which the beach sands and gravels actively oscillate with changing wave conditions (USACE, 1984).

Shoreline: The intersection of a specified plane of water with the shore or beach (e.g., the high water shoreline would be the intersection of the plane of mean high water with shore or beach). The line delineating the shoreline on National Ocean Service nautical charts and surveys approximates the mean high water line. (USACE, 1984)

Silt: See *soil classification* (USACE, 1984).

Slip: A berthing space between two piers (USACE, 1984).

Slope: The degree of inclination to the horizontal. Usually expressed as a ratio, such as 1:25 or 1 on 25, indicating 1 unit vertical rise in 25 units of horizontal distance, or in a decimal fraction (0.04); degrees ($2^{\circ} 18'$), or percent (4 percent). (USACE, 1984)

Soil classification (size): An arbitrary division of a continuous scale of grain sizes such that each scale unit or grade may serve as a convenient class interval for conducting the analysis or for expressing the results of an analysis (USACE, 1984).

Spit: A small point of land or a narrow shoal projecting into a body of water from the shore (USACE, 1984).

Splash zone: Area along the shoreline above the zone of influence of waves and tides that is still wetted by the spray from breaking waves.

Storage dam: Typically a high dam with large hydraulic head, long detention time, and positive control over the volume of water released from the impoundment.

Stream: (1) A course of water flowing along a bed in the earth. (2) A current in the sea formed by wind action, water density differences, etc.; e.g., the Gulf Stream. See also *current*, *stream*. (USACE, 1984)

Suspended load: (1) The material moving in suspension in a fluid, kept up by the upward components of the turbulent currents or by colloidal suspension. (2) The material collected in or computed from samples collected with a suspended load sampler. Where it is necessary to distinguish between the two meanings given above, the first one may be called the "true suspended load." (USACE, 1984)

Tailwater: Channel or stream below a dam (Walberg et al., 1981).

Tidal flats: Marshy or muddy land areas that are covered and uncovered by the rise and fall of the tide (USACE, 1984).

Tidal inlet: (1) A natural inlet maintained by tidal flow. (2) Loosely, an inlet in which the tide ebbs and flows. Also *tidal outlet*. (USACE, 1984)

Tidal period: The interval of time between two consecutive, like phases of the tide (USACE, 1984).

Tidal range: The difference in height between consecutive high and low (or higher high and lower low) waters (USACE, 1984).

Tide: The periodic rising and falling of the water that results from gravitational attraction of the Moon and Sun and other astronomical bodies acting upon the rotating Earth. Although the accompanying horizontal movement of the water resulting from the same cause is also sometimes called the tide, it is preferable to designate the latter as *tidal current*, reserving the name *tide* for the vertical movement. (USACE, 1984)

Topography: The configuration of a surface, including its relief and the positions of its streams, roads, building, etc. (USACE, 1984).

Tropical storm: A tropical cyclone with maximum winds of less than 34 meters per second (75 miles per hour). Compare *hurricane*. (USACE, 1984)

Updrift: The direction opposite that of the predominant movement of littoral materials (USACE, 1984).

Upland: Ground elevated above the lowlands along rivers or between hills (Merriam-Webster, 1991).

Waterline: A juncture of land and sea. This line migrates, changing with the tide or other fluctuation in the water level. Where waves are present on the beach, this line is also known as the limit of backrush. (Approximately, the intersection of the land with the still-water level.) (USACE, 1984)

Wave: A ridge, deformation, or undulation of the surface of a liquid (USACE, 1984).

Wave height: The vertical distance between a crest and the preceding trough (USACE, 1984).

Wave period: The time required for a wave crest to traverse a distance equal to one wavelength. The time required for two successive wave crests to pass a fixed point. (USACE, 1984)

Wave, reflected: That part of an incident wave that is returned seaward when a wave impinges on a steep beach, barrier, or other reflecting surface (USACE, 1984).

Wetlands: Those areas that are inundated or saturated by surface water or ground water at a frequency and duration to support, and that under normal circumstances do support, a prevalence of vegetation typically adapted for life in saturated soil conditions; wetlands generally include swamps, marshes, bogs, and similar areas. (This definition is consistent with the Federal definition at 40 CFR 230.3, promulgated December 24, 1980. As amendments are made to the wetland definition, they will be considered applicable to this guidance.)

Wind waves: (1) Waves being formed and built up by the wind. (2) Loosely, any waves generated by wind. (USACE, 1984)

VI. REFERENCES

A. Channelization and Channel Modification

- Anderson, S. 1992. Studies Begin on Kaneohe Bay's Toxin Problem. *Makai*, 14(2):1,3. University of Hawaii Sea Grant College Program.
- Barbour, M.T., and J.B. Stribling. 1991. Use of Habitat Assessment in Evaluating the Biological Integrity of Stream Communities. In *Biological Criteria: Research and Regulation*, ed. U.S. Environmental Protection Agency, Office of Water, pp. 25-38. Washington, DC. EPA-440/5-91-005.
- Barclay, J.S. 1980. *Impact of Stream Alterations on Riparian Communities in Southcentral Oklahoma*. U.S. Department of the Interior Fish and Wildlife Service. FWS/OBS-80/17.
- Bowie, A.J. 1981. Investigation of Vegetation for Stabilizing Eroding Streambanks. *Appendix C to Stream Channel Stability*. U.S. Department of Agriculture Sedimentation Laboratory, Oxford, MS. Original not available for examination. Cited in Henderson, 1986.
- Brocksen, R.W., M. Fraser, I. Murarka, and S.G. Hildebrand. 1982. The Effects of Selected Hydraulic Structures of Fisheries and Limnology. *CRC Critical Reviews in Environmental Control*, 12(1):69-89.
- Brookes, A. 1990. Restoration and Enhancement of Engineered River Channels: Some European Experiences. *Regulated Rivers: Research and Management*, 5:45-56. John Wiley and Sons, Ltd.
- Burch, C.W., et al. 1984. *Environmental Guidelines for Dike Fields*. U.S. Army Corps of Engineers Waterways Experiment Station, Vicksburg, MS. Technical Report E-84-4.
- Burress, R.M., D.A. Krieger, and C.H. Pennington. 1982. *Aquatic Biota of Bank Stabilization Structures on the Missouri River, North Dakota*. U.S. Army Corps of Engineers Waterways Experiment Station, Vicksburg, MS. Technical Report E-82-6.
- Erickson, R.E., R.L. Linder, and K.W. Harmon. 1979. Stream Channelization (PL 83-566) Increased Wetland Losses in the Dakotas. *Wildlife Society Bulletin*, 7(2):71-78.
- Hamilton, P. 1990. Modelling Salinity and Circulation for the Columbia River Estuary. *Progr. Oceanogr.*, 25:113-156.
- Hehnke, M., and C.P. Stone. 1978. Value of Riparian Vegetation to Avian Populations along the Sacramento River System. In *Strategies for Protection and Management of Floodplains, Wetlands, and other Riparian Ecosystems*, ed. R.R. Johnson and J.F. McCormick. U.S. Forest Service, Washington DC. GTR-WO-12. Original not available for examination. Cited in Henderson and Shields, 1984.
- Henderson, J.E. 1986. Environmental Design for Streambank Protection Projects. *Water Resources Bulletin*, 22(4):549-558.
- Henderson, J.E., and F.D. Shields, Jr. 1984. *Environmental Features for Streambank Protection Projects*. U.S. Army Corps of Engineers Waterways Experiment Station, Vicksburg, MS. Technical Report E-84-11.
- Hupp, C.R., and A. Simon. 1986. Vegetation and Bank-Slope Development. In *Proceedings of the Forest Federal Interagency Sedimentation Conference*, Las Vegas, NV, pp. 83-92. U.S. Interagency Advisory Committee on Water Data, Washington, DC.

- Hupp, C.R., and A. Simon. 1991. Bank Accretion and the Development of Vegetated Depositional Surfaces Along Modified Alluvial Channels. *Geomorphology*, 4:111-124.
- Hynson, J.R., P.R. Adamus, J.O. Elmer, T. DeWan, and F.D. Shields. 1985. *Environmental Features for Streamside Levee Projects*. U.S. Army Corps of Engineers Waterways Experiment Station, Vicksburg, MS. Technical Report E-85-7.
- James and Stokes Associates, Inc. 1976. *The Effects of Altered Streambeds on Fish and Wildlife in California*.
- Karr, J.R., K.D. Fausch, P.L. Angermeier, P.R. Yant, and I.J. Schlosser. 1986. *Assessing Biological Integrity in Running Waters: A Method and its Rationale*. Illinois Natural History Survey. Special Publication No. 5.
- Los Angeles River Watershed, Angeles National Forest, Region 5. 1973. *Evaluation of Check Dams for Sediment Control*.
- McAnally, W.H., Jr. 1987. Modeling Estuarine Sediment Transport Processes. In *Proceedings Sedimentation Control to Reduce Maintenance Dredging of Navigational Facilities in Estuaries*, ed. R.B. Krone. Marine Board, Committee on Engineering and Technical Systems, National Research Council, Washington, DC.
- McPherson, J.A. 1991. *Computation of Salinity Intrusion by One-Dimensional Analysis*. U.S. Army Corps of Engineers, Washington, DC. ETL 1110-8-7(FR).
- Orlova and Popova. 1976. Original not available for examination. Cited in Brocksen et al., 1982.
- Parrish, J.D., et al. 1978. Stream Channelization in Hawaii, Part D: Summary Report. U.S. Fish and Wildlife Service, Hawaii Cooperative Fishery Research Unit, Honolulu, Hawaii. FWS/OBS-78/19. In *Environmental Impact of Water Resources Projects*. Lewis Publishers Company, 1985.
- Pennington, E.E., and W.E. Dodge. 1982. Environmental Effects of Tennessee-Tombigbee Project Cutoff Bendways. U.S. Army Corps of Engineers Waterways Experiment Station, Vicksburg, MS. Misc. Paper E-82-4. In *Environmental Impact of Water Resources Projects*. Lewis Publishers Company, 1985.
- Petersen, J.C. 1990. Trends and Comparison of Water Quality and Bottom Material of Northern Arkansas, 1974-85. In *Effects of Planned Diversions*. U.S. Geological Survey, Little Rock, AR. USGS Water-Resources Investigation Report 90-4017.
- Plafkin, J.L., M.T. Barbour, K.D. Porter, S.K. Gross, and R.M. Hughes. 1989. *Rapid Bioassessment Protocols for Use in Streams and Rivers: Benthic Macroinvertebrates and Fish*. U.S. Environmental Protection Agency, Office of Water. Washington, DC. EPA/440/4-89/001.
- Reiser, D.W., M.P. Ramey, and T.R. Lambert. 1985. Review of Flushing Flow in Regulated Streams. Pacific Gas and Electric Company, San Ramon, CA. In *Flushing and Scouring Flows for Habitat Maintenance in Regulated Streams*, ed. W.R. Nelson, J.R. Dwyer, and W.E. Greenberg. 1988. U.S. Environmental Protection Agency, Washington, DC.
- Rosgen, D. 1985. A Stream Classification System. In *Riparian Ecosystems and Their Management: Reconciling Conflicting Issues*. First North American Riparian Conference. U.S. Forest Service, Department of Agriculture, Washington, DC. General Technical Report No. RM-120.
- Rosgen, D., and B. Fittante. 1986. Fish Habitat Structures: A Selection Guide Using Stream Classification. In *Fifth Trout Stream Habitat Improvement Workshop*, ed. J. Miller, J. Areway, and R. Carline. Loch Haven, PA.

- Roy, D., and D. Messier. 1989. A Review of the Effects of Water Transfers - the La Grange Hydroelectric Complex (Quebec, Canada). *Regulated Rivers: Research and Management*, 4:299-316.
- Sandheinrich, M.B., and G.J. Atchison. 1986. *Environmental Effects of Dikes and Revetments on Large Riverine Systems*. Prepared by U.S. Fish and Wildlife Service, Iowa Cooperative Fishery Research Unit, and the Department of Animal Ecology, Iowa State University for the U.S. Army Corps of Engineers Waterways Experiment Station, Vicksburg, MS.
- Schoof, R. 1980. Environmental Impacts of Channel Modification. *Water Resources Bulletin*, 16:697-701. In *Channelization of Streams and Rivers in Illinois: Procedural Review and Selected Case Studies*, ed. R.L. Mattingly and E.E. Herricks. Illinois Department of Energy and Natural Resources, Springfield, IL. INENR/re-WR-91/01. 1990.
- Schueler, T. 1987. *Controlling Urban Runoff: A Practical Manual for Planning and Designing Urban BMPs*. Metropolitan Washington Council of Governments, Washington, DC.
- Sherwood, C.R., D.A. Jay, R. Harvey, P. Hamilton, and C. Simenstad. 1990. Historical Changes in the Columbia River Estuary. *Progr. Oceanogr.*, 25:299-352.
- Shields, F.D., Jr., J.J. Hoover, N.R. Nunnally, K.J. Killgore, T.E. Schaefer, and T.N. Waller. 1990. *Hydraulic and Environmental Effects of Channel Stabilization, Twentymile Creek, Mississippi*. U.S. Army Corps of Engineers Waterways Experiment Station, Vicksburg, MS. EL-90-14.
- Shields, F.D., Jr., and T.E. Schaefer. 1990. *ENDOW User's Guide*. U.S. Army Corps of Engineers Waterways Experiment Station, Vicksburg, MS.
- Simon, A. 1989a. A Model of Channel Response in Disturbed Alluvial Channels. *Earth Surface Processes and Landforms*, 14:11-26.
- Simon, A. 1989b. The Discharge of Sediment in Channelized Alluvial Streams. *Water Resources Bulletin*, 25(6):1177-1187.
- Simon, A., and C.R. Hupp. 1986. Channel Evolution in Modified Tennessee Channels. In *Proceedings of the Forest Federal Interagency Sedimentation Conference*, Las Vegas, NV, pp. 71-82. U.S. Interagency Advisory Committee on Water Data, Washington, DC.
- Simon, A., and C.R. Hupp. 1987. Geomorphic and Vegetative Recovery Processes Along Modified Tennessee Streams: An Interdisciplinary Approach to Disturbed Fluvial Systems. *Forest Hydrology and Watershed Management. Proceedings of the Vancouver Symposium*. IAHS-AISH Publication No. 167.
- Spaulding, M.L., ed. 1990. *Proceeding of ASCE Estuarine and Coastal Transport Modeling Conference*. Newport, Rhode Island, November 1989.
- Swanson, S., D. Franzen, and M. Manning. 1987. Rodero Creek: Rising Water on the High Desert. *Journal of Soil and Water Conservation*, 42(6):405-407.
- Theurer, F.D., K.A. Voos, and W.J. Miller. 1984. *Instream Water Temperature Model*. Instream Flow Information Paper No. 16. U.S. Department of the Interior Fish and Wildlife Service. FWS/OBS-84/15.
- Theurer, F.D., K.A. Voos, and C.G. Prewitt. 1982. Application of IFG's Instream Water Temperature Model in the Upper Colorado River. In *Proceedings of the International Symposium on Hydrometeorology*, Denver, CO, 13-17 June 1982, pp. 287-292. American Water Resources Association.

- USACE. 1978. *Design and Construction of Levees*. U.S. Army Corps of Engineers, Washington, DC. Engineering Manual 1110-2-1913.
- USACE. 1981. *Low Cost Shore Protection*. U.S. Army Corps of Engineers, Washington, DC.
- USACE. 1983. *Streambank Protection Guidelines for Landowners and Local Governments*. U.S. Army Corps of Engineers, Vicksburg, MS.
- USACE. 1989. *Engineering and Design: Sedimentation Investigations of Rivers and Reservoirs*. U.S. Army Corps of Engineers, Washington, DC. Engineering Manual No. 1110-2-4000.
- USDOI-FWS. 1980. *Habitat Evaluation Procedure (HEP), BSM 102*. U.S. Department of the Interior Fish and Wildlife Service, Washington, DC.
- USEPA. 1985. *Coastal Marinas Assessment Handbook*. U.S. Environmental Protection Agency, Region IV, Atlanta, GA.
- Wilcock, D.N., and C.I. Essery. 1991. Environmental Impacts of Channelization of the River Main, County Antrim, North Ireland. *Journal of Environmental Management*, 32:127-143.
- Wolff, S.W., T.A. Wesche, and W.A. Hubert. 1989. Stream Channel and Habitat Changes Due to Flow Augmentation. *Regulated Rivers: Research and Management*, 4:225-233.

B. Dams

- Adams, J.S., and G.E. Hauser. 1990. *Comparison of Minimum Flow Alternatives South Fork Holston River Below South Holston Dam*. Tennessee Valley Authority, Engineering Laboratory, Norris, TN. Report No. WR28-1-21-102
- Andrews, J. 1988. *Anadromous Fish Habitat Enhancement for the Middle Fork and Upper Salmon River*. Prepared for the U.S. Department of Energy, Bonneville Power Administration, Division of Fish and Wildlife, Portland, OR. Technical Report DOE/BP/17579-2.
- ASCE. 1986. American Society of Civil Engineers. *Lessons Learned from Design, Construction, and Performance of Hydraulic Structures*. Hydraulic Structures Committee of the Hydraulics Division of the ASCE, New York, NY.
- Beecher, J.A., and A.P. Laubach. 1989. *Compendium on Water Supply, Drought, and Conservation*. The National Regulatory Research Institute, Columbus, OH. NRRI 89-15.
- Beecher, J.A., P.C. Mann, and J.R. Landers. 1990. *Cost Allocation and Rate Design for Water Utilities*. National Regulatory Research Institute and Ohio State University, Columbus, Ohio.
- Bender, M.D., G.E. Hauser, and M.C. Shiao. 1991. *Modeling Boone Reservoir to Evaluate Cost-Effectiveness of Point and Nonpoint Source Pollutant Controls*. Tennessee Valley Authority, Engineering Laboratory, Norris, TN. Report No. WR28-1-31-107.
- Bohac, C.E., and R.J. Ruane. 1990. Solving the Dissolved Oxygen Problem. *Hydro-Review: The Magazine of the North American Hydroelectric Industry*, 9(1):62-70.
- Bonneville Power Administration. 1991. *Environmental Assessment: East Fork Salmon Habitat Enhancement Project*. Bonneville Power Administration, Portland, OR.

- Cooke, G.D., and R.H. Kennedy. 1989. *Water Quality Management for Reservoirs and Tailwaters: Report 1, In-Reservoir Water Quality Management Techniques*. U.S. Army Engineering Waterways Experiment Station, Vicksburg, MS. Technical Report E-89-1.
- Dodge, N.A. 1989. Managing the Columbia River to Meet Anadromous Fish Requirements. In *Proceedings Waterpower '89*, 23-25 August 1989, Niagara Falls, NY. American Society of Civil Engineers.
- EPRI. 1990. Electric Power Research Institute. *Assessment and Guide for Meeting Dissolved Oxygen Water Quality Standards for Hydroelectric Plant Discharges*. Aquatic Systems Engineering, Wellsboro, PA. EPRI GS-7001.
- Fast, A.W., M.W. Lorenzen, and J.H. Glenn. 1976. Comparative Study with Costs of Hypolimnetic Aeration. *Journal of Environmental Engineering Division, ASCE*, 102:1175-1187.
- Findley, D.I., and K. Day. 1987. Dissolved Oxygen Studies Below Walter F. George Dam. In *Proceedings: CE Workshop on Reservoir Releases*, U.S. Army Corp of Engineers Waterways Experiment Station, Vicksburg, MS. Misc. Paper E-87-3.
- Fontane, D.G., W.J. Labadie, and B. Loftis. 1981. *Optimal Control of Reservoir Discharge Quality Through Selective Withdrawal: Hydraulic Laboratory Investigation*. Prepared by Colorado State University and the Hydraulics Laboratory, Waterways Experimental Station, for the U.S. Army Corps of Engineers Waterways Experiment Station, Vicksburg, MS. Technical Report E-82-1.
- Gallagher, J.W., and G.V. Mauldin. 1987. Oxygenation of Releases from Richard B. Russell Dam. In *Proceedings: CE Workshop on Reservoir Releases*, U.S. Army Corp of Engineers Waterways Experiment Station, Vicksburg, MS. Misc. Paper E-87-3.
- Grisham, A., and W.M. Fleming. 1989. Long-term Options for Municipal Water Conservation. *Journal of the American Water Works Association*, (March):34.
- Hansen, R.P., and M.D. Crumrine. 1991. *The Effects of Multipurpose Reservoirs on the Water Temperature of the North and South of Santiam Rivers, Oregon*. U.S. Geological Survey, prepared in cooperation with the U.S. Army Corps of Engineers, Portland, OR. Water Resources Investigations, Report 91-4007.
- Harris, G.G., and W.A. Van Bergeijk. 1962. Evidence that the Lateral-Line Organ Responds to Near-Field Displacements of Sound Sources in Water. *J. Acoust. Soc. Amer.*, 34:1831-1841.
- Harshbarger, E.D. 1987. Recent Developments in Turbine Aeration. In *Proceedings: CE Workshop on Reservoir Releases*. U.S. Army Corp of Engineers Waterways Experiment Station, Vicksburg, MS. Misc. Paper E-87-3.
- Hauser, G.E. 1989. *Turbine Pulsing for Minimum Flow Maintenance Downstream from Tributary Projects*. Tennessee Valley Authority Engineering Laboratory, Norris, TN. Technical Report No. WR28-2-590-147.
- Hauser, G.E., M.D. Bender, M.C. Shiao, and R.T. Brown. 1987. *Two-Dimensional Modelling of Water Quality in Cherokee Reservoir*. Tennessee Valley Authority, Norris, TN. Technical Report No. WR28-1-590-131.
- Hauser, G.E., M.D. Bender, and M.K. McKinnon. 1989. *Model Investigation of Douglas Tailwater Improvements*. Tennessee Valley Authority, Norris, TN. Technical Report No. WR28-1-590-143.
- Hauser, G.E., and R.J. Ruane. 1985. *Model Exploration of Holston River Water Quality Improvement Strategies*. Tennessee Valley Authority, Office of Natural Resources and Economic Development, Division of Air and Water Resources, Norris, TN. Water Systems Development Branch Report No. WR28-1-590-109.

- Hauser, G.E., M.C. Shiao, and M.D. Bender. 1990a. *Modeled Effects of Extended Pool Level Operations on Water Quality*. Tennessee Valley Authority Engineering Laboratory, Norris, TN. Technical Report No. WR28-2-590-148.
- Hauser, G.E., M.C. Shiao, and R.J. Ruane. 1990b. *Unsteady One-Dimensional Modelling of Dissolved Oxygen in Nickajack Reservoir*. Tennessee Valley Authority Engineering Laboratory, Norris, TN. Technical Report No. WR28-1-590-150.
- Henderson, J.E., and F.D. Shields, Jr. 1984. *Environmental Features for Streambank Protection Projects*. U.S. Army Corps of Engineers Waterways Experiment Station, Vicksburg, MS. Technical Report E-84-11.
- Higgins, J.M., and B.R. Kim. 1982. DO Model for Discharges from Deep Impoundments. *Journal of the Environmental Engineering Division, ASCE*, 108(E1):107-122.
- Holland, J.P. 1984. *Parametric Investigation of Localized Mixing in Reservoirs*. U.S. Army Corps of Engineers Waterways Experiment Station, Vicksburg, MS. Technical Report E-84-7. Original not available for examination. Cited in Price, 1989.
- Howington, S.E. 1990. *Simultaneous, Multilevel Withdrawal from a Density Stratified Reservoir*. U.S. Army Corps of Engineers Waterways Experiment Station, Vicksburg, MS. Technical Report W-90-1.
- Hynson, J.R., P.R. Adamus, J.O. Elmer, and T. DeWan. 1985. *Environmental Features for Streamside Levee Projects*. U.S. Army Engineer Waterways Experiment Station, Vicksburg, MS. Technical Report E-85-7.
- Johnson, J.T., R.J. Ruane, and L.H. Howe II. 1991. Hydrogen Sulfide in Hydropower Reservoirs. In *Proceedings Waterpower '91*, July 1991, Denver, CO. American Society of Civil Engineers.
- Johnson, P.L., and J.F. LaBounty. 1988. *Optimization of Multiple Reservoir Uses Through Reaeration - Lake Casitas, USA: A Case Study*. Commission Internationale des Grands Barrages. Seizième Congrès des Grands Barrages, San Francisco, 1988. Q. 60, R. 27 pp. 437-451.
- Jones, R.K., and P.A. March. 1991. Efficiency and Cavitation Effects of Hydroturbine Venting. In *Progress in Autoventing Turbine Development*. Tennessee Valley Engineering Authority, Engineering Laboratory, Norris, TN.
- Kondolf, G.M., G.F. Cada, and M.J. Sale. 1987. Assessing Flushing-Flow Requirements for Brown Trout Spawning Gravels in Steep Streams. *Water Resources Bulletin*, 23(5):927-935.
- Kortmann, R.W. 1989. Raw Water Quality Control: An Overview of Reservoir Management Techniques. *Journal NEWWA*, December 1989, pp. 197-220.
- Kushlan, J.A. 1987. External Threats and Internal Management: The Hydrologic Regulation of the Everglades, Florida, USA. *Environmental Management*, 11(1):109-119.
- Larinier, M., and S. Boyer-Bernard. 1991. Downstream Migration of Smolts and Effectiveness of a Fish Bypass Structure at Halsou Hydroelectric Powerhouse on the Nive River. *Bulletin Francais de Pêche et Pisciculture*, 321:72-92.
- Li, H. W., C. B. Schreck, R. A. Tubb, K. Rodnick, M. Ahlgren, and A. Crook. 1983. *The Impact of Small-Scale Dams on Fishes of the Willamette River, Oregon and an Evaluation of Fish Habitat Models*. Water Resources Research Institute, Oregon State University, Corvallis, OR. WRI-91.
- Lorenzen, M.W., and A. Fast. 1977. *A Guide to Aeration/Circulation Techniques for Lake Management*. U.S. Environmental Protection Agency, Washington, DC. EPA-600/3-77-004.

- Maddaus, W.O. 1989. *Water Conservation*. American Water Works Association.
- Maine Department of Environmental Protection, Bureau of Water Quality, and York County Soil and Water Conservation District. 1990. *Best Management Practices for Stormwater Management*.
- March, P.A., J. Cybularz, and B.G. Ragsdale. 1991. Model Tests for Evaluation of Auto-Venting Hydroturbines. In *Progress in Autoventing Turbine Development*. Tennessee Valley Authority, Engineering Laboratory, Norris, TN.
- Mattice, J.S. 1990. Ecological Effects of Hydropower Facilities. In *Hydropower Engineering Handbook*, pp. 8.1-8.57. McGraw-Hill, New York.
- McQueen, D.J., and D.R.S. Lean. 1986. Hypolimnetic Aeration: An Overview. *Water Pollution Resources Journal of Canada*, 21:205-217.
- "Memorandum of Understanding Regarding Urban Water Conservation in California." 1991. September. June draft. (Created California Urban Water Conservation Council including water suppliers, public advocacy organizations, and other interested groups.)
- Muckleston, K.W. 1990. Striking a Balance in the Pacific Northwest. *Environment*, 32(1): 11-15, 32-35.
- Nelson, R.W., J.R. Dwyer, and W.E. Greenberg. 1987. Regulated Flushing in a Gravel-Bed River for Channel Habitat Maintenance: A Trinity River Fisheries Case Study. *Environmental Management*, 11(4):479-493.
- Nelson, R.W., J.R. Dwyer, and W.E. Greenberg. 1988. *Flushing and Scouring Flows for Habitat Maintenance in Regulated Streams*. Final Technical Report Contract No. 68-01-6986, U.S. Environmental Protection Agency, Criteria and Standard Division, Washington, DC.
- Nelson, R.W., G.C. Horak, and J.E. Olson. 1978. *Western Reservoir and Stream Habitat Improvements Handbook*. U.S. Department of the Interior Fish and Wildlife Service, Fort Collins, CO. FWS/OBS-78/56.
- Nestler, J.M., J. Fritschen, R.T. Milhous, and J. Troxel. 1986a. *Effects of Flow Alterations on Trout, Angling, and Recreation in the Chattahoochee River Between Buford Dam and Peachtree Creek*. U.S. Army Corps of Engineers Waterways Experiment Station, Vicksburg, MS. Technical Report E-86-10.
- Nestler, J.M., C.H. Walburg, J.F. Novotny, K.E. Jacobs, and W.D. Swink. 1986b. *Handbook on Reservoir Releases for Fisheries and Environmental Quality*. U.S. Army Corps of Engineers Waterways Experiment Station, Vicksburg, MS. Instruction Report E-86-3.
- Nichols, A.B. 1992. Life System Helps Fish Overcome Dammed Waters. *Water Environment and Technology*, 4(9):40-42. Water Environment Federation, Alexandria, VA.
- Peters, J.C. 1978. Environmental Control During Dam Construction. In *Environmental Effects of Large Dams*, pp. 15-27. American Society of Civil Engineers, New York, NY.
- Podar, M.K., J.C. Crossman, D.E. Burmaster, R.J. Ruane, J.A. Jaksch, G. Hauser, and S.L. Sessions. 1985. *Optimizing Point/Nonpoint Source Tradeoff in the Holston River Near Kingsport, Tennessee*. Prepared for presentation at the National Conference on Nonpoint Sources of Pollution, Kansas City.
- Price, R.E. 1989. Evaluating Commercially Available Destratification Devices. *Water Operations Technical Support Information Exchange Bulletin*, Volume E-89-2, December 1989. U.S. Army Corps of Engineers Waterways Experiment Station, Vicksburg, MS.

- Pugh, J.R., G.L. Monan, and J.R. Smith. 1971. Effect of Water Velocity on the Fish-Guiding Efficiency of an Electrical Guidance System. *Fishery Bulletin*, 68(2):307-324
- Quick, R., and C. Richmond. 1992. *Number of Dams in the Coastal Areas*. U.S. Environmental Protection Agency, unpublished memo.
- RMI. 1991. Rocky Mountain Institute. *Water Efficiency: A Resource for Utility Managers, Community Planners, and Other Decisionmakers*. The Water Program, Rocky Mountain Institute. Snowmass, CO.
- Rochester, H. Jr., T. Lloyd, and M. Farr. 1984. *Physical Impacts of Small-Scale Hydroelectric Facilities and their Effects on Fish and Wildlife*. Prepared for Western Energy and Land Use Team, Division of Biological Services, Research and Development, U.S. Fish and Wildlife Service, Washington, DC. FWS/OBS-84/19.
- Smith, D.R., S.C. Wilhelms, J.P. Holland, M.S. Dortch, and J.E. Davis. 1987. *Improved Description of Selective Withdrawal Through Point Sinks*. U.S. Army Engineer Waterways Experiment Station, Vicksburg, MS. Technical Report E-87-2.
- Stone and Webster. 1986. Stone and Webster Engineering Corporation. *Assessment of Downstream Migrant Fish Protection Technologies for Hydroelectric Application*. Palo Alto, California, Electric Power Research Institute. Report AP-4711.
- Stromberg, J.C., and D.T. Patten. 1990. Riparian Vegetation Instream Flow Requirements: A Case Study from a Diverted Stream in the Eastern Sierra Nevada, California, USA. *Environmental Management*, 14(2):185-194.
- Tanovan, B. 1987. System Spill Allocation for the Control of Dissolved Gas Saturation on the Columbia River. In *Proceedings: CE Workshop on Reservoir Releases*. U.S. Army Corps of Engineers Waterways Experiment Station, Vicksburg, MS. Misc. Paper E-87-3.
- TVA. 1985. *Feasibility Report Tims Ford/Elk River Minimum Flows*. Tennessee Valley Authority, Office of Natural Resources and Economic Development, Division of Air and Water Resources. Report Number TVA/ONRED/A&WR-85/22.
- TVA. 1988. *The Tennessee Valley Authority's Nonpoint Source Pollution Control Activities Under the Memorandum of Understanding Between the State of Tennessee and the Tennessee Valley Authority During Fiscal Years 1983-1986*. Tennessee Valley Authority.
- TVA. 1990. *Final Environmental Impact Statement, Tennessee River and Reservoir Operation and Planning Review*. Tennessee Valley Authority. Report Number TVA/RDG/EQS-91/1.
- TVA. 1991. *Progress in Autoventing Turbine Development*. Tennessee Valley Authority, Engineering Laboratory.
- USDOE. 1991. *Environmental Mitigation at Hydroelectric Projects: Volume 1 Current Practices for Instream Flow Needs, Dissolved Oxygen, and Fish Passage*. U.S. Department of Energy. DOE/ID-10360.
- USDOI. 1983. *Central Utah Project Bonneville Unit Diamond Fork Power System Draft Environmental Statement*. U.S. Department of the Interior, Bureau of Reclamation, Upper Colorado Region.
- USDOI. 1988. *Glen Canyon Environmental Studies Final Report*. U.S. Department of the Interior, Upper Colorado Region, Salt Lake City, UT. NTIS No. PB88-183348/AS.
- USDOI-FWS. 1976. *The Effects of Altered Streamflows on Fish and Wildlife in California, Task II: Individual Case Study Results*, Western Energy and Land Use Team, Fort Collins, CO. U.S. Department of the Interior Fish and Wildlife Service.

- USEPA. 1973. *The Control of Pollution from Hydrographic Modifications*. U.S. Environmental Protection Agency, Washington, DC.
- USEPA. 1979. *Best Management Practices Guidance, Discharge of Dredged or Fill Materials*. U.S. Environmental Protection Agency, Office of Water, Washington, DC. EPA 440/3-79-028.
- USEPA. 1989. *Report to Congress: Dam Water Quality Study*. U.S. Environmental Protection Agency, Office of Water, Office of Water Regulations and Standards, Assessment and Watershed Protection Division, Washington, DC. EPA 506/2-89/002.
- USEPA. 1990. *The Lake and Reservoir Restoration Guidance Manual*. Office of Water. EPA-440/4-90-006.
- USGAO. 1990. *Hydroelectric Dams, Issues Surrounding Colombia Basin Juvenile Fish Bypasses*. Report to the Chairman, Subcommittee on Oversight and Investigations, Committee on Energy and Commerce, House of Representatives. U.S. General Accounting Office, Washington, DC. GAO/RCED-90-180.
- van der Borg, R., and J. Ferguson. 1989. Hydropower and Fish Passage Impacts. In *Proceedings Waterpower '89*, 23-25 August 1989, Niagara Falls, NY. American Society of Civil Engineers.
- Virginia State Water Control Board. 1979. *Best Management Practices Handbook - Hydrologic Modifications*, Richmond, VA. Planning Bulletin 319.
- Walburg, C.H., J.F. Novotny, K.E. Jacobs, W.D. Swink, T.M. Campbell, J. Nestler, and G.E. Saul. 1981. *Effects of Reservoir Releases on Tailwater Ecology: A Literature Review*. Prepared by U.S. Department of the Interior, Fish and Wildlife Service, National Reservoir Research Program, East Central Reservoir Investigations, and Environmental Laboratory, U.S. Army Corps of Engineers Waterways Experiment Station, Vicksburg, MS. Technical Report E-81-12.
- Waldrop, W.R. 1992. The Autoventing Turbine—A New Generation of Environmentally Improved Hydroturbines. In *Proceedings of the American Power Conference*.
- Wesche, T.A., V.R. Hasfurther, and Q.D. Skinner. 1987. Recommendation and Evaluation of a Mitigative Flushing Flow Region Below a High Mountain Diversion. In *Proceedings of the Symposium on Water Resources Related to Mining and Energy-Preparing for the Future*, pp. 281-298. American Water Resources Association, Bethesda, MD.
- Wilhelms, S.C. 1984. Turbine Venting. *Environmental & Water Quality Operational Studies*, Volume E-84-5, September 1984. U.S. Army Corps of Engineers Waterways Experiment Station, Vicksburg, MS.
- Wilhelms, S.C. 1988. Reaeration at Low-Head Gated Structures; Preliminary Results. *Water Operations Technical Support*, Volume E-88-1, July 1988. U.S. Army Corps of Engineers Waterways Experiment Station, Vicksburg, MS.
- Wilhelms, S.C., and D. R. Smith. 1981. *Reaeration Through Gated-Conduit Outlet Works*. U.S. Army Corps of Engineers Waterways Experiment Station, Vicksburg, MS. Technical Report E-81-5.
- Wolff, S.W., T.A. Wesche, and W.A. Hubert. 1989. Stream Channel and Habitat Changes Due to Flow Augmentation. *Regulated Rivers: Research and Management*, 4:235-247.
- Zimmerman, M.J., and M. S. Dortch. 1989. Modelling Water Quality of a Reregulated Stream Below a Hydropower Dam. *Regulated Rivers: Research and Management*, 4:235-247.

C. Streambank and Shoreline Erosion

Allen, H.H., and C.V. Klimas. 1986. *Reservoir Shoreline and Revegetation Guidelines*. U.S. Army Corps of Engineers Waterways Experiment Station, Vicksburg, MS. E-86-13.

Arsenault, R.D. 1975. CCA-Treated Wood Foundations: A Study of Permanence, Effectiveness, Durability, and Environmental Considerations. In *Proceedings, Annual Meeting of the American Wood Preservers Association*, San Francisco, California, pp. 1-23.

Baechler, R.H., B.R. Richards, A.P. Richards, and H.G. Roth. 1970. Effectiveness and Permanence of Several Preservatives in Wood Coupons Exposed to Sea Water. In *Proceedings, Annual Meeting of the American Wood Preservers Association*, pp. 47-62.

Bascom, W. 1964. *Waves and Beaches - The Dynamics of the Ocean Surfaces*. Anchor Books, Doubleday and Company, Inc. New York.

Cumberland County SWCD, Know-Lincoln SWCD, Maine Department of Environmental Protection, Maine Soil and Water Conservation Commission, Portland Water District, Time and Ride RC and D, U.S. Environmental Protection Agency, and U.S. Department of Agriculture-Soil Conservation Service. *Fact Sheet Series (2, 3, 4, 5, 8, 9, 10, 12)*.

Davis, C.A. 1987. A Strategy to Save the Chesapeake Shoreline. *Journal of Soil and Water Conservation*, 42(2):72-75.

Ehrlich, L. A., and F. Kulhawy. 1982. *Breakwaters, Jetties and Groins: A Design Guide*. New York Sea Grant Institute: Coastal Structures Handbook Series. New York Sea Grant Institute, Stony Brook, NY.

Environmental Concern, Inc. 1992. EC Involved in Urban Wetland Restoration in Baltimore. *Environmental Concern Newsletter*, 4(1):7.

FEMA. 1986. *Coastal Construction Manual*. Federal Emergency Management Agency, Washington, DC. FEMA-55.

Fulford, E.T. 1985. Reef Type Breakwaters for Shoreline Stabilization. In *Coastal Zone '85*, pp. 1776-1795. American Society of Civil Engineers, New York, NY.

Garbisch, E.W., P.B. Woller, W.J. Bostian, R.J. McCallum. 1973. *Biotic Techniques for Shore Stabilization*. Prepared for the International Estuarine Research Conference, Myrtle Beach, SC, 1973.

Gloucester County, Virginia, Department of Conservation and Recreation, Division of Soil and Water Conservation, Shoreline Programs Bureau. June 1991. *Gloucester County Shoreline Erosion Control Guidance (DRAFT)*.

Graham, J.S. 1983. Design of Pressure-Treated Wood Bulkheads. In *Coastal Structures '83*, pp. 286-295. American Society of Civil Engineers, New York, NY.

Gray, D.H., and A.T. Leiser. 1982. *Biotechnical Slope Protection and Erosion Control*. Van Nostrand Reinhold Company, New York.

Gutman, A.L. 1979. Low-Cost Shoreline Protection in Massachusetts. In *Proceedings of the Specialty Conference on Coastal Structures*, 14-16 March 1979, Alexandria, VA.

Hall, V.L., and J.D. Ludwig. 1975. *Evaluation of Potential Use of Vegetation for Erosion Abatement along the Great Lakes Shoreline*. U.S. Army Corps of Engineers, Coastal Engineering Research Center, Fort Belvoir, VA. MP-7-75.

- Hardaway, C.S., and J.R. Gunn. 1989. Elm's Beach Breakwater Project - St. Mary's County, Maryland. In *Proceedings Beach Technology '89*, Tampa, FL.
- Hardaway, C.S., and J.R. Gunn. 1991. Working Breakwaters. *Civil Engineering*, October 1991:64-66.
- Hardaway, C.S., G.R. Thomas, and J.-H. Li. 1991. *Chesapeake Bay Shoreline Study: Headland Breakwaters and Pocket Beaches for Shoreline Erosion Control, Final Report*. Virginia Institute of Marine Science, Gloucester Point, VA.
- Henderson, J.E. 1986. Environmental Design for Streambank Protection Projects. *Water Resources Bulletin*, 22(4):549-558.
- Hill, Lambert, and Ross. 1983. *Best Management Practices for Shoreline Erosion Control*. Virginia Cooperative Extension Service. Publication 447-004.
- Hobbs, C.H., R.J. Byrne, W.R. Kerns, and N.J. Barber. 1981. Shoreline Erosion: A Problem in Environmental Management. *Coastal Zone Management Journal*, 9(1):89-105.
- Hobson, R.D. 1977. *Review of Design Elements for Beach-Fill Evaluation*. U.S. Army Corps of Engineers Coastal Engineering Research Center, Fort Belvoir, VA. TP 77-6.
- Houston, J.R. 1991. Beachfill Performance. *Shore and Beach*, 59(3):15-24.
- Ibison, N.A., J.C. Baumer, C.L. Hill, N.H. Burger, and J.E. Frye. 1992. *Eroding Bank Nutrient Verification Study for the Lower Chesapeake Bay*. Virginia Department of Conservation and Recreation, Gloucester Point, VA.
- Ibison, N.A., C.W. Frye, J.E. Frye, C.E. Hill, and N.H. Burger. 1990. *Sediment and Nutrient Contributions of Selected Eroding Banks of the Chesapeake Bay Estuarine System*. Virginia Department of Conservation and Recreation, Gloucester Point, VA.
- Illinois Department of Conservation. 1990. *Forestry Development Cost-Share Program*. Illinois Administrative Code, Title 17, Chapter I, Subchapter d, Part 1536.
- Johnson, J.W. 1957. Ship Waves in Navigational Channels. In *Proceedings of the Sixth Conference on Coastal Engineering*, Gainesville, FA, pp. 666-690.
- Knutson, P.L. 1977. *Planting Guidelines for Marsh Development and Bank Stabilization*. U.S. Army Corps of Engineers Coastal Engineering Research Center, Fort Belvoir, VA. Coastal Engineering Technical Aid No. 77-3.
- Knutson, P.L. 1988. Role of Coastal Marshes in Energy Dissipation and Shore Protection. In *The Ecology and Management of Wetlands, Volume 1: Ecology of Wetlands*, ed. D.D. Hook, W.H. McKee, Jr., H.K. Smith, J. Gregory, V.G. Burrell, Jr., M.R. DeVoe, R.E. Sojka, S. Gilbert, R. Banks, L.H. Stolzy, C. Brooks, T.D. Matthews, and T.H. Shear, pp. 161-175. Timber Press, Portland, OR.
- Knutson, P.L., and M.R. Inskip. 1982. *Shore Erosion Control with Salt Marsh Vegetation*. Coastal Engineering Technical Aid No. 82-3. U.S. Army Corps of Engineers Coastal Engineering Research Center, Vicksburg, MS.
- Knutson, P.L., and W.W. Woodhouse, Jr. 1983. *Shore Stabilization with Salt Marsh Vegetation*. U.S. Army Corps of Engineers Coastal Engineering Research Center, Fort Belvoir, VA. Special Report No. 9.
- Komar, P.D., and W.G. McDougal. 1988. Coastal Erosion and Engineering Structures: The Oregon Experience, *Journal of Coastal Research*, Special Issue No. 4.

- Kraus, N.C., and O.H. Pilkey. 1988. Introduction: The Effects of Seawalls on the Beach, *Journal of Coastal Research*, Special Issue No. 4.
- Leatherman, S.P. 1986. Cliff Stability along Western Chesapeake Bay, Maryland. *Marine Technology Society Journal*, 20(3): 28-36.
- Lewis, R.L. III, ed. 1982. *Creation and Restoration of Coastal Plant Communities*. CRC Press, Inc., Boca Raton, FL.
- Lowrance, R.R., S. McIntyre, and C. Lance. 1988. Erosion and Deposition in a Field/Forest System Estimated Using Cesium-137 Activity, *Journal of Soil and Water Conservation*, 43(2):195-199.
- Maryland Department of Natural Resources. 1980. *Final Report on the Role of Boat Wakes in Shore Erosion in Anne Arundel County, Maryland*. Maryland DNR, Annapolis, MD.
- Maryland Department of Natural Resources. 1982. *An Assessment of Shore Erosion in Northern Chesapeake Bay and of the Performance of Erosion Control Structures*. Maryland DNR, Annapolis, MD.
- Maryland Eastern Shore Resource Conservation and Development Area. *Completion Reports*. Maryland Eastern Shore Resource Conservation and Development Area, Non-structural Shore Erosion Control Program, Easton, MD.
- Michigan Sea Grant College Program. 1988. *Vegetation and its Role in Reducing Great Lakes Shoreline Erosion: A guide for Property Owners*. MICHU-SG-700.
- Mitsch, W.J., and J. G. Gosselink. 1986. *Wetlands*. Van Nostrand Reinhold Co., New York, NY.
- Morris, W., ed. 1978. *The American Heritage Dictionary of the English Language*, Houghton Mifflin Company, Boston.
- NRC. 1990. National Research Council, Committee on Coastal Zone Erosion Management. *Managing Coastal Erosion*. National Academy Press, Washington, DC.
- NRC. 1991. National Research Council. *Restoration of Aquatic Ecosystems: Science, Technology, and Public Policy*. National Academy Press, Washington, DC.
- O'Connor, J.M., D.A. Neumann, and J.A. Sherk, Jr. 1976. *Lethal Effects of Suspended Sediments on Estuarine Fish*. U.S. Army Corps of Engineers Coastal Engineering Research Center, Fort Belvoir, VA. TP 76-20.
- Palmer, H.D. 1973. Shoreline Erosion in Upper Chesapeake Bay: The Role of Groundwater. *Shore and Beach*, 41(2):1-5.
- Pilkey, O.H. 1992. Another View of Beachfill Performance. *Shore and Beach*, 60(2):20-25.
- Pilkey, O.H., and H.L. Wright III. 1988. Seawalls Versus Beaches. *Journal of Coastal Research*, Special Issue No. 4:41-64. Coastal Education and Research Foundation, Charlottesville, VA.
- Porter, D.L. 1992. *Light Touch, Low Cost, Streambank and Shoreline Erosion Control Techniques*. Tennessee Valley Authority.
- Profiles Research and Consulting Groups, Inc. 1980. *Seasonal Restrictions on Dredging Projects by NMFS in the Northeast*. Prepared for Environmental Assessment Branch U.S. Department of Commerce, National Oceanic and Atmospheric Administration, Washington, DC. 2 vols.

- Saczynski, T. M., and F. Kulhawy. 1982. *Bulkheads*. New York Sea Grant Institute: Coastal Structures Handbook Series. New York Sea Grant Institute, Stony Brook, NY.
- Schiechtl, H. 1980. *Bioengineering for Land Reclamation and Conservation*. The University of Alberta Press, Edmonton, Alberta, Canada.
- Schultz, Gwynne. Letter to Chris Zabawa, 15 April 1992.
- Sharp, W.C., C.R. Belcher, and J. Oyler. Undated. *Vegetation for Tidal Shoreline Stabilization in the Mid-Atlantic States*. U.S. Department of Agriculture, Soil Conservation Service, Broomall, PA.
- Sherk, J.A. Jr., J.M. O'Connor, and D.A. Neumann. 1976. *Effects of Suspended Solids on Selected Estuarine Plankton*. U.S. Army Corps of Engineers Coastal Engineering Research Center, Fort Belvoir, VA. MR 76-1.
- Tainter, S.P. 1982. *Bluff Slumping and Stability: A Consumer's Guide*. Michigan Sea Grant, Ann Arbor, MI.
- Thompson, J.R. 1973. *Ecological Effects of Offshore Dredging and Beach Nourishment: A Review*. U.S. Army Corps of Engineers Coastal Engineering Research Center. MP 1-73.
- USACE. 1981a. *Low-Cost Shore Protection, Final Report on the Shoreline Erosion Control Demonstration Program (Section 54)*. Department of the Army, Office of the Chief of Engineers, U.S. Army Corps of Engineers. Washington, DC.
- USACE. 1981b. *Detailed Project Report and Environmental Assessment: Section III, Shores East of Diked Disposal Area, Lorain Harbor, Ohio*. U.S. Army Corps of Engineers, Buffalo District.
- USACE. 1982. *Maumee Bay State Park, Ohio Shoreline Beach Restoration Study: Final Feasibility Report and Final Environmental Impact Statement, Volume I Main Report*. U.S. Army Corps of Engineers, Buffalo District.
- USACE. 1983. *Streambank Protection Guidelines for Landowners and Local Governments*. U.S. Army Corps of Engineers, Vicksburg, MS.
- USACE. 1984. *Shoreline Protection Manual*. U.S. Army Corps of Engineers, Waterways Experiment Station, Vicksburg, MS. 2 vols.
- USACE. 1988. *North Nantasket Beach Shore Protection Study: Hull, Massachusetts*. U.S. Army Corps of Engineers, New England Division.
- USACE. 1990. *Chesapeake Bay Shoreline Erosion Study: Feasibility Report*. U.S. Army Corps of Engineers.
- USDA-SCS. 1992. *Engineering Field Handbook*. U.S. Department of Agriculture, Soil Conservation Service, Washington, DC.
- USDA-SCS. 1985. *Streambank and Shoreline Protection*. U.S. Department of Agriculture, Soil Conservation Service.
- USEPA-CBP. 1991. *Baywide Nutrient Reduction Strategy 1990 Progress Report*. U.S. Environmental Protection Agency Chesapeake Bay Program, Annapolis, MD.
- USEPA, 1992. *National Water Quality Inventory 1990 Report to Congress*, U.S. Environmental Protection Agency, Washington, DC.

-
- Virginia Department of Conservation and Recreation, Shore Erosion Advisory Service. Undated. *Bid Documents*. Gloucester Point, VA.
- Weis, P., J.S. Weis, and L.M. Coohill. 1991. Toxicity to Estuarine Organisms of Leachates from Chromated Copper Arsenate Treated Wood. *Archives Environmental Contamination and Toxicology*, 20(1991):118-124.
- Weis, P., J.S. Weis, A. Greenberg, and T.J. Nosker. 1992. Toxicity of Construction Materials in the Marine Environment: A Comparison of Chromated-Copper-Arsenate-Treated Wood and Recycled Plastic. *Archives Environmental Contamination and Toxicology*, 22(1992):99-106.
- Woodhouse, W.W., Jr., E.D. Seneca, and S.W. Broome. 1972. *Marsh Building with Dredge Spoil in North Carolina*. U.S. Army Corps of Engineers Coastal Research Center, North Carolina Research Center. Distributed by National Technical Information Service, U.S. Department of Commerce, Springfield, VA. COM-72-11434.
- Woodhouse, W.W., Jr. 1978. *Dune Building and Stabilization with Vegetation*. U.S. Army Corps of Engineers Coastal Engineering Center, Fort Belvoir, VA. Special Report No. 3.

CHAPTER 7: Management Measures for Wetlands, Riparian Areas, and Vegetated Treatment Systems

I. INTRODUCTION

A. What "Management Measures" Are

This chapter specifies management measures to protect and restore wetlands and riparian areas to protect coastal waters from coastal nonpoint pollution. "Management measures" are defined in section 6217 of the Coastal Zone Act Reauthorization Amendments of 1990 (CZARA) as economically achievable measures to control the addition of pollutants to our coastal waters, which reflect the greatest degree of pollutant reduction achievable through the application of the best available nonpoint pollution control practices, technologies, processes, siting criteria, operating methods, or other alternatives.

These management measures will be incorporated by States into their coastal nonpoint programs, which under CZARA are to provide for the implementation of management measures that are "in conformity" with this guidance. Under CZARA, States are subject to a number of requirements as they develop and implement their Coastal Nonpoint Pollution Control Programs in conformity with this guidance and will have some flexibility in doing so. The application of these management measures by States to activities causing nonpoint pollution is described more fully in *Coastal Nonpoint Pollution Control Program: Program Development and Approval Guidance*, published jointly by the U.S. Environmental Protection Agency (EPA) and the National Oceanic and Atmospheric Administration (NOAA).

B. What "Management Practices" Are

In addition to specifying management *measures*, this chapter also lists and describes management *practices* for illustrative purposes only. While State programs are required to specify management *measures* in conformity with this guidance, State programs need not specify or require the implementation of the particular management *practices* described in this document. However, as a practical matter, EPA anticipates that the management measures generally will be implemented by applying one or more management practices appropriate to the source, location, and climate. The practices listed in this document have been found by EPA to be representative of the types of practices that can be applied successfully to achieve the management measures. EPA has also used some of these practices, or appropriate combinations of these practices, as a basis for estimating the effectiveness, costs, and economic impacts of achieving the management measures. (Economic impacts of the management measures are addressed in a separate document entitled *Economic Impacts of EPA Guidance Specifying Management Measures for Sources of Nonpoint Pollution in Coastal Waters*.)

EPA recognizes that there is often site-specific, regional, and national variability in the selection of appropriate practices, as well as in the design constraints and pollution control effectiveness of practices. The list of practices for each management measure is not all-inclusive and does not preclude States or local agencies from using other technically and environmentally sound practices. In all cases, however, the practice or set of practices chosen by a State needs to achieve the management measure.

C. Scope of This Chapter

This chapter contains management measures that address multiple categories of nonpoint source (NPS) pollution that affect coastal waters. The primary NPS pollutants addressed are sediment, nitrogen, phosphorus, and temperature. This chapter is divided into three management measures:

- (1) Protection of Wetlands and Riparian Areas;
- (2) Restoration of Wetlands and Riparian Areas; and
- (3) Promoting the Use of Vegetated Treatment Systems, such as Constructed Wetlands and Vegetated Filter Strips.

Each category of management measure is addressed in a separate section of this guidance. Each section contains (1) the management measure; (2) an applicability statement that describes, when appropriate, specific activities and locations for which the measure is suitable; (3) a description of the management measure's purpose; (4) the basis for the management measure's selection; (5) information on management practices that are suitable, either alone or in combination with other practices, to achieve the management measure; (6) information on the effectiveness of the management measure and/or of practices to achieve the measure; and (7) information on costs of the measure and/or of practices to achieve the measure.

CZARA requires EPA to specify management measures to control nonpoint pollution from various sources. Wetlands, riparian areas, and vegetated treatment systems have important potential for reducing nonpoint pollution in coastal waters from a variety of sources. Degradation of existing wetlands and riparian areas can cause the wetlands or riparian areas themselves to become sources of nonpoint pollution in coastal waters. Such degradation can result in the inability of existing wetlands and riparian areas to treat nonpoint pollution. Therefore, management measures are presented in this chapter specifying the control of nonpoint pollution through (1) protection of the full range of functions of wetlands and riparian areas to ensure continuing nonpoint source pollution abatement, (2) restoration of degraded systems, and (3) the use of vegetated treatment systems.

The intent of the three wetlands management measures is to ensure that the nonpoint benefits of protecting and restoring wetlands and riparian areas, and of constructing vegetated treatment systems, will be considered in all coastal watershed water pollution control activities. These management measures form an essential element of any State Coastal Nonpoint Pollution Control Program.

There is substantial evidence in the literature, and from case studies, that one important function of both natural and human-made wetlands is the removal of nonpoint source pollutants from storm water. Much of this literature is cited in this chapter. These pollutants include sediment, nitrogen, and phosphorus (Whigham et al., 1988; Cooper et al., 1987; Brinson et al., 1984). Also, wetlands and riparian areas have been shown to attenuate flows from higher-than-average storm events, thereby protecting receiving waters from peak flow hydraulic impacts such as channel scour, streambank erosion, and fluctuations in temperature and chemical characteristics of surface waters (Mitsch and Gosselink, 1986; Novitzki, 1979).

A degraded wetland has less ability to remove nonpoint source pollutants and to attenuate storm water peak flows (Richardson and Davis, 1987; Bedford and Preston, 1988). Also, a degraded wetland can deliver increased amounts of sediment, nutrients, and other pollutants to the adjoining waterbody, thereby acting as a source of nonpoint pollution instead of a treatment (Brinson, 1988).

Therefore, the first management measure is intended to protect the full range of functions for wetlands and riparian areas serving a nonpoint source abatement function. This protection will preserve their value as a nonpoint source control and help to ensure that they do not become a significant nonpoint source due to degradation.

The second management measure promotes the restoration of degraded wetlands and riparian systems with nonpoint source control potential for similar reasons: the increase in pollutant loadings that can result from degradation of wetlands and riparian areas, and the substantial evidence in the literature on effectiveness of wetlands and riparian areas for nonpoint pollution abatement. In addition, there may be other benefits of restoration to wildlife and aquatic

organisms. This measure provides for evaluation of degraded wetlands and riparian systems, and for restoration if the systems will serve a nonpoint source pollution abatement function (e.g., by cost-effectively treating nonpoint source pollution or by attenuating peak flows).

The third management measure promotes the use of vegetated treatment systems because of their wide-scale ability to treat a variety of sources of nonpoint pollution. This measure will apply, as appropriate, to all other chapters in this guidance. Placing the large amount of information on vegetated treatment systems in one management measure avoids duplication in most other 6217(g) measures and thereby limits the potential for confusion. All descriptions, applications, case studies, and costs are in one measure within the CZARA 6217(g) guidance and are cross-referenced in the management measures for which these systems are a potential nonpoint pollution control. Also, all positive and negative aspects of design, construction, and operation have been included in one place to avoid confusion in applications due to potential inconsistencies from placement in multiple measures.

D. Relationship of This Chapter to Other Chapters and to Other EPA Documents

1. Chapter 1 of this document contains detailed information on the legislative background for this guidance, the process used by EPA to develop this guidance, and the technical approach used by EPA in the guidance.
2. Chapter 3 of this document contains a management measure and accompanying information on forestry practices in wetlands and protection of wetlands subject to forestry operations.
3. Chapter 8 of this document contains information on recommended monitoring techniques (1) to ensure proper implementation, operation, and maintenance of the management measures and (2) to assess over time the success of the measures in reducing pollution loads and improving water quality.
4. EPA has separately published a document entitled *Economic Impacts of EPA Guidance Specifying Management Measures for Sources of Nonpoint Pollution in Coastal Waters*.
5. NOAA and EPA have jointly published guidance entitled *Coastal Nonpoint Pollution Control Program: Program Development and Approval Guidance*. This guidance contains details on how State Coastal Nonpoint Pollution Control Programs are to be developed by States and approved by NOAA and EPA. It includes guidance on the following:
 - The basis and process for EPA/NOAA approval of State Coastal Nonpoint Pollution Control Programs;
 - How NOAA and EPA expect State programs to provide for the implementation of management measures "in conformity" with this management measures guidance;
 - How States may target sources in implementing their Coastal Nonpoint Pollution Control Programs;
 - Changes in State coastal boundaries; and
 - Requirements concerning how States are to implement their Coastal Nonpoint Pollution Control Programs.

E. Definitions and Background Information

The preceding five chapters of this guidance have specified management measures that represent the most effective systems of practices that are available to prevent or reduce coastal nonpoint source (NPS) pollution from five specific categories of sources. In this chapter, management measures that apply to a broad variety of sources, including the five categories of sources addressed in the preceding chapters, are specified. These measures promote the protection

and restoration of wetlands and riparian areas and the use of vegetated treatment systems as means to control the nonpoint pollution emanating from such nonpoint sources. Management measures for protection and restoration of wetlands and riparian areas are developed as part of NPS and coastal management programs to take into consideration the multiple functions and values these ecosystems provide to ensure continuing nonpoint source pollution abatement.

1. Wetlands and Riparian Areas

For purposes of this guidance, *wetlands* are defined as:

Those areas that are inundated or saturated by surface or ground water at a frequency and duration sufficient to support, and that under normal circumstances do support, a prevalence of vegetation typically adapted for life in saturated soil conditions. Wetlands generally include swamps, marshes, bogs, and similar areas.¹

Wetlands are usually waters of the United States and as such are afforded protection under the Clean Water Act (CWA). Although the focus of this chapter is on the function of wetlands in reducing NPS pollution, it is important to keep in mind that wetlands are ecological systems that perform a range of functions (e.g., hydrologic, water quality, or aquatic habitat), as well as a number of pollutant removal functions.

For purposes of this guidance, *riparian areas* are defined as:

Vegetated ecosystems along a waterbody through which energy, materials, and water pass. Riparian areas characteristically have a high water table and are subject to periodic flooding and influence from the adjacent waterbody. These systems encompass wetlands, uplands, or some combination of these two land forms. They will not in all cases have all of the characteristics necessary for them to be classified as wetlands.²

Figure 7-1 illustrates the general relationship between wetlands, uplands, riparian areas, and a stream channel. Identifying the exact boundaries of wetlands or riparian areas is less critical than identifying ecological systems of concern. For instance, even those riparian areas falling outside wetland boundaries provide many of the same important water quality functions that wetlands provide. In many cases, the area of concern may include an upland buffer adjacent to sensitive wetlands or riparian areas that protects them from excessive NPS impacts or pretreats the inflowing surface waters.

Wetlands and riparian areas can play a critical role in reducing NPS pollution, by intercepting surface runoff, subsurface flow, and certain ground-water flows. Their role in water quality improvement includes processing, removing, transforming, and storing such pollutants as sediment, nitrogen, phosphorus, and certain heavy metals. Thus, wetlands and riparian areas buffer receiving waters from the effects of pollutants, or they prevent the entry of pollutants into receiving waters.

The functions of wetlands and riparian areas include water quality improvement, aquatic habitat, stream shading, flood attenuation, shoreline stabilization, and ground-water exchange. Wetlands and riparian areas typically occur as natural buffers between uplands and adjacent waterbodies. Loss of these systems allows for a more direct contribution of NPS pollutants to receiving waters. The pollutant removal functions associated with wetlands and riparian area vegetation and soils combine the physical process of filtering and the biological processes of nutrient uptake and denitrification (Lowrance et al., 1983; Peterjohn and Correll, 1984). Riparian forests, for example, have been found to contribute to the quality of aquatic habitat by providing cover, bank stability, and a source of organic

¹ This definition is consistent with the Federal definition at 40 CFR 230.3, promulgated December 24, 1980. As amendments are made to the wetland definition, they will be considered applicable to this guidance.

² This definition is adapted from the definitions offered previously by Mitsch and Gosselink (1986) and Lowrance et al. (1988).

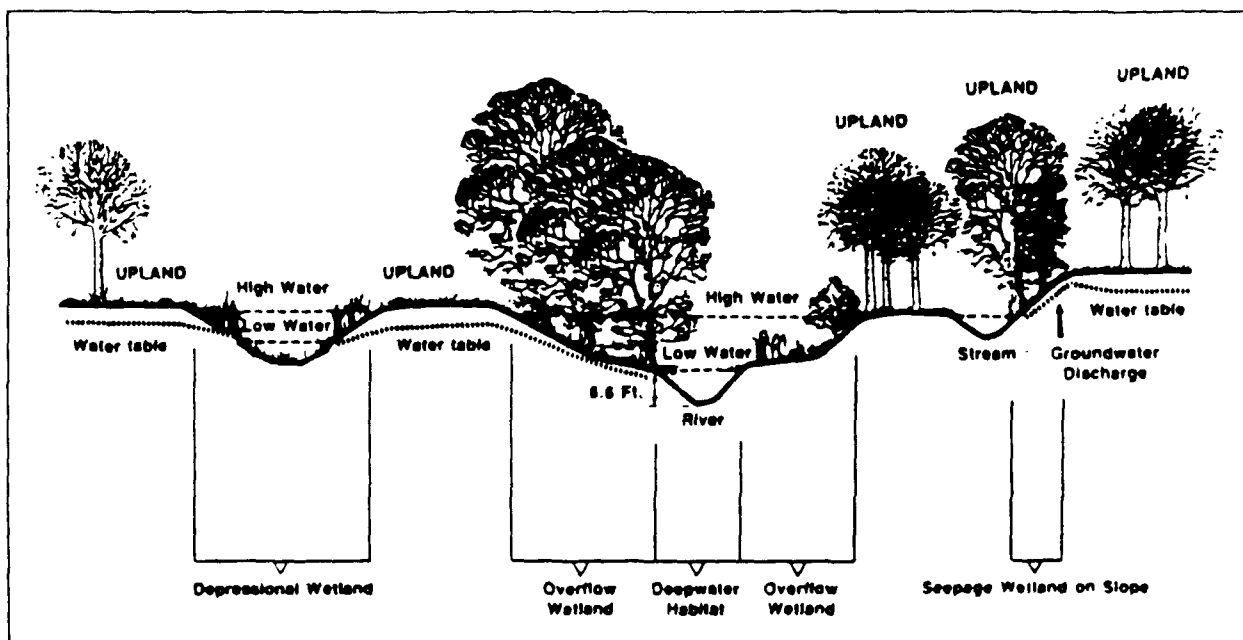

Figure 7-1. Cross section showing the general relationship between wetlands, uplands, riparian areas, and a stream channel (Burke et al., 1988).

carbon for microbial processes such as denitrification (James et al., 1990; Pinay and Decamps, 1988). Riparian forests have also been found to be effective at reducing instream pollution during flood flows (Karr and Gorman, 1975; Kleiss et al., 1989).

In highly developed urban areas, wetlands and riparian areas may be virtually destroyed by construction, filling, channelization, or other significant alteration. In agricultural areas, wetlands and riparian areas may be impacted by overuse of the area for grazing or by removal of native vegetation and replacement by annual crops or perennial cover. In addition, significant hydrologic alterations may have occurred to expedite drainage of farmland. Other significant impacts may occur as a result of various activities such as highway construction, surface mining, deposition of dredged material, and excavation of ports and marinas. All of these activities have the potential to degrade or destroy the water quality improvement functions of wetlands and riparian areas and may exacerbate NPS problems.

A wetland's position in the landscape affects its water quality functions. Some cases have been studied sufficiently to predict how an individual wetland will affect water quality on a landscape scale (Whigham et al., 1988). Wetlands that border first-order streams were found by Whigham and others (1988) to be efficient at removing nitrate from ground water and sediment from surface waters. They were not found to be as efficient in removing phosphorus. When located downstream from first-order streams, wetlands and riparian areas were found to be less effective at removing sediment and nutrient from the stream itself because of a smaller percentage of stream water coming into contact with the wetlands (Whigham et al., 1988). It has also been estimated that the portion of a wetland or riparian area immediately below the source of nonpoint pollution may be the most effective filter (Cooper et al., 1986; Lowrance et al., 1983; Phillips, 1989).

Although wetlands and riparian areas reduce NPS pollution, they do so within a definite range of operational conditions. When hydrologic changes or NPS pollutants exceed the natural assimilative capacity of these systems, wetland and riparian areas become stressed and may be degraded or destroyed. Therefore, wetlands and riparian areas should be protected from changes that would degrade their existing functions. Furthermore, degraded wetlands and riparian areas should be restored, where possible, to serve an NPS pollution abatement function.

2. Vegetated Buffers

For the purpose of this guidance, *vegetated buffers* are defined as:

Strips of vegetation separating a waterbody from a land use that could act as a nonpoint pollution source. Vegetated buffers (or simply buffers) are variable in width and can range in function from a vegetated filter strip to a wetland or riparian area.

This term is currently used in many contexts, and there is no agreement on any single concept of what constitutes a buffer, what activities are acceptable in a buffer zone, or what is an appropriate buffer width. In one usage, the term *vegetated buffer* refers to natural riparian areas that are either set aside or restored to filter pollutants from runoff and to maintain the ecological integrity of the waterbody and the land adjacent to it (Nieswand et al., 1989). In another usage, the term *vegetated buffer* refers to constructed strips of vegetation used in various settings to remove pollutants in runoff from a developed site (Nieswand et al., 1989). Finally, the term *vegetated buffer* can be used to describe a transition zone between an urbanized area and a naturally occurring riparian forest (Faber et al., 1989). In this context, buffers can be designed to provide value to wildlife as well as aesthetic value.

A vegetated buffer usually has a rough surface and typically contains a heterogeneous mix of ground cover, including herbaceous and woody species of vegetation (Stewardship Incentive Program, 1991; Swift, 1986). This mix of vegetation allows the buffer to function more like a wetland or riparian area. A vegetated filter strip (see below) can also be constructed to remove pollutants in runoff from a developed site, but a filter strip differs from a vegetated buffer in that a filter strip typically has a smooth surface and a vegetated cover made up of a homogeneous species of vegetation (Dillaha et al., 1989a).

Vegetated buffers can possess characteristics and functions ranging from those of a riparian area to those of a vegetated filter strip. To avoid confusion, the term *vegetated buffer* will not be discussed further in this chapter although the term is used in other chapters of this guidance.

3. Vegetated Treatment Systems

For purposes of this guidance, *vegetated treatment systems* (VTS) are defined to include either of the following or a combination of both: vegetated filter strips and constructed wetlands. Both of these systems have been defined in the scientific literature and have been studied individually to determine their effectiveness in NPS pollutant removal.

In this guidance, *vegetated filter strips* (VFS) are defined as (Dillaha et al., 1989a):

Created areas of vegetation designed to remove sediment and other pollutants from surface water runoff by filtration, deposition, infiltration, adsorption, absorption, decomposition, and volatilization. A vegetated filter strip is an area that maintains soil aeration as opposed to a wetland that, at times, exhibits anaerobic soil conditions.

In this guidance, *constructed wetlands* are defined as (Hammer, 1992):

Engineered systems designed to simulate natural wetlands to exploit the water purification functional value for human use and benefits. Constructed wetlands consist of former upland environments that have been modified to create poorly drained soils and wetlands flora and fauna for the primary purpose of contaminant or pollutant removal from wastewaters or runoff. Constructed wetlands are essentially wastewater treatment systems and are designed and operated as such though many systems do support other functional values.

In areas where naturally occurring wetlands or riparian areas do not exist, VTS can be designed and constructed to perform some of the same functions. When such engineered systems are installed for a specific NPS-related purpose, however, they may not offer the same range of functions that naturally occurring wetlands or riparian areas offer.

Vegetated treatment systems have been installed in a wide range of settings, including cropland, pastureland, forests, and developed, as well as developing, urban areas, where the systems can perform a complementary function of sediment control and surface water runoff management. Practices for use of vegetated treatment systems are discussed in other chapters of this guidance, and VTS should be considered to have wide-ranging applicability to various NPS categories.

When properly installed and maintained, VFS have been shown to effectively prevent the entry of sediment, sediment-bound pollutants, and nutrients into waterbodies. Vegetated filter strips reduce NPS pollutants primarily by filtering water passing over or through the strips. Properly designed and maintained vegetated filter strips can substantially reduce the delivery of sediment and some nutrients to coastal waters from nonpoint sources. With proper planning and maintenance, vegetated filter strips can be a beneficial part of a network of NPS pollution control measures for a particular site. Vegetated filter strips are often coupled with practices that reduce nutrient inputs, minimize soil erosion, or collect runoff. Where wildlife needs are factored into the design, vegetated filter strips or buffers in urban areas can add to the urban environment by providing wildlife nesting and feeding sites, in addition to serving as a pollution control measure. However, some vegetated filter strips require maintenance such as mowing of grass or removal of accumulated sediment. These and other maintenance activities may preclude much of their value for wildlife, for example by disturbing or destroying nesting sites.

Constructed wetlands are designed to mimic the pollutant-removal functions of natural wetlands but usually lack aquatic habitat functions and are not intended to provide species diversity. Pollutant removal in constructed wetlands is accomplished by several mechanisms, including sediment trapping, plant uptake, bacterial decomposition, and adsorption. Properly designed constructed wetlands filter and settle suspended solids. Wetland vegetation used in constructed wetlands converts some pollutants (i.e., nitrogen, phosphorus, and metals) into plant biomass (Watson et al., 1988). Nitrification, denitrification, and organic decomposition are bacterial processes that occur in constructed wetlands. Some pollutants, such as phosphorus and most metals, physically attach or adsorb to soil and sediment particles. Therefore, constructed wetlands, used as a management practice, could be an important component in managing NPS pollution from a variety of sources. They are not intended to replace or destroy natural wetland areas, but to remove NPS pollution before it enters a stream, natural wetland, or other waterbody.

It is important to note that aquatic plants and benthic organisms used in constructed wetlands serve primarily to remove pollutants. Constructed wetlands may or may not be designed to provide flood storage, ground-water exchange, or other functions associated with natural wetlands. In fact, if there is a significant potential for contamination or other detrimental impacts to wildlife, constructed wetlands should be designed to discourage use by wildlife.

II. MANAGEMENT MEASURES

A. Management Measure for Protection of Wetlands and Riparian Areas

Protect from adverse effects wetlands and riparian areas that are serving a significant NPS abatement function and maintain this function while protecting the other existing functions of these wetlands and riparian areas as measured by characteristics such as vegetative composition and cover, hydrology of surface water and ground water, geochemistry of the substrate, and species composition.

1. Applicability

This management measure is intended to be applied by States to protect wetlands and riparian areas from adverse NPS pollution impacts. Under the Coastal Zone Act Reauthorization Amendments of 1990, States are subject to a number of requirements as they develop coastal NPS programs in conformity with this management measure and will have flexibility in doing so. The application of management measures by States is described more fully in *Coastal Nonpoint Pollution Control Program: Program Development and Approval Guidance*, published jointly by the U.S. Environmental Protection Agency (EPA) and the National Oceanic and Atmospheric Administration (NOAA) of the U.S. Department of Commerce.

2. Description

The purpose of this management measure is to protect the existing water quality improvement functions of wetlands and riparian areas as a component of NPS programs. The overall approach is to establish a set of practices that maintains functions of wetlands and riparian areas and prevents adverse impacts to areas serving an NPS pollution abatement function. The ecosystem and water quality functions of wetlands and riparian areas serving an NPS pollution abatement function should be protected by a combination of programmatic and structural practices.

The term *NPS pollution abatement function* refers to the ability of a wetland or riparian area to remove NPS pollutants from runoff passing through the wetland or riparian area. Acting as a sink for phosphorus and converting nitrate to nitrogen gas through denitrification are two examples of the important NPS pollution abatement functions performed by wetlands and riparian areas.

This management measure provides for NPS pollution abatement through the protection of wetland and riparian functions. The permit program administered by the U.S. Army Corps of Engineers, EPA, and approved States under section 404 of the Clean Water Act regulates the discharge of dredged or fill material into waters of the United States, including wetlands. The measure and section 404 program complement each other, but the focus of the two is different.

The measure focuses on nonpoint source problems in wetlands, as well as on maintaining the functions of wetlands that are providing NPS pollution abatement. The nonpoint source problems addressed include impacts resulting from upland development and upstream channel modifications that erode wetlands, change salinity, kill existing vegetation, and upset sediment and nutrient balances. The section 404 program focuses on regulating the discharge of dredged

or fill materials in wetlands, thereby protecting wetlands from physical destruction and other pollutant problems that could result from discharges of dredged or fill material.

The nonpoint source pollution abatement functions performed by wetlands and riparian areas are most effective as parts of an integrated land management system that combines nutrient, sediment, and soil erosion control. These areas consist of a complex organization of biotic and abiotic elements. Wetlands and riparian areas are effective in removing suspended solids, nutrients, and other contaminants from upland runoff, as well as maintaining stream channel temperature (Table 7-1). In addition, some studies suggest that wetland and riparian vegetation acts as a nutrient sink (Table 7-1), taking up and storing nutrients (Richardson, 1988). This function may be related to the age of the wetland or riparian area (Lowrance et al., 1983). The processes that occur in these areas include sedimentation, microbial and chemical decomposition, organic export, filtration, adsorption, complexation, chelation, biological assimilation, and nutrient release.

Pollutant-removal efficiencies for a specific wetland or riparian area may be the result of a number of different factors linked to the various removal processes:

- (1) Frequency and duration of flooding;
- (2) Types of soils and slope;
- (3) Vegetation type;
- (4) The nitrogen-carbon balance for denitrifying activity (nitrate removal); and
- (5) The edge-to-area ratio of the wetland or riparian area.

Watershed-specific factors include land use practices and the percentage of watershed dominated by wetlands or riparian areas.

A study performed in the southeastern United States coastal plain illustrates dramatically the role that wetlands and riparian areas play in abating NPS pollutants. Lowrance and others (1983) examined the water quality role played by mixed hardwood forests along stream channels adjacent to agricultural lands. These streamside forests were shown to be effective in retaining nitrogen, phosphorus, calcium, and magnesium. It was projected that total conversion of the riparian forest to a mix of crops typically grown on uplands would result in a twenty-fold increase in nitrate-nitrogen loadings to the streams (Lowrance et al., 1983). This increase resulted from the introduction of nitrates to promote crop development and from the loss of nitrate removal functions previously performed by the riparian forest.

3. Management Measure Selection

Selection of this management measure was based on:

- (1) The opportunity to gain multiple benefits, such as protecting wetland and riparian area systems, while reducing NPS pollution;
- (2) The nonpoint pollution abatement function of wetlands and riparian areas, i.e., their effectiveness in reducing loadings of NPS pollutants, especially sediment, nitrogen, and phosphorus, and in maintaining stream temperatures; and
- (3) The localized increase in NPS pollution loadings that can result from degradation of wetlands and riparian areas.

Separate sections below explain each of these points in more detail.

Table 7-1. Effectiveness of Wetlands and Riparian Areas for NPS Pollution Control

No.	Location	Wetland/ Riparian	Summary of Observations	Source
1	Tar River Basin, North Carolina	Riparian Forests	<p>This study looks at how various soil types affect the buffer width necessary for effectiveness of riparian forests to reduce loadings of agricultural nonpoint source pollutants.</p> <ul style="list-style-type: none"> • A hypothetical buffer with a width of 30 m and designed to remove 90% of the nitrate nitrogen from runoff volumes typical of 50 acres of row crop on relatively poorly drained soils was used as a standard. • Udic upland soils and sandy entisols met or exceeded these standards. • The study also concluded that slope gradient was the most important contributor to the variation in effectiveness. 	Phillips, J.D. 1989. Nonpoint Source Pollution Control Effectiveness of Riparian Forests Along a Coastal Plain River. <i>Journal of Hydrology</i> , 110 (1989):221-237.
2	Lake Tahoe, Nevada	Riparian	<p>Three years of research on a headwaters watershed has shown this area to be capable of removing over 99% of the incoming nitrate nitrogen. Wetlands and riparian areas in a watershed appear to be able to "clean up" nitrate-containing waters with a very high degree of efficiency and are of major value in providing natural pollution controls for sensitive waters.</p>	Rhodes, J., C.M. Skau, D. Greenlee, and D. Brown. 1985. Quantification of Nitrate Uptake by Riparian Forests and Wetlands in an Undisturbed Headwaters Watershed. In <i>Riparian Ecosystems and Their Management: Reconciling Conflicting Issues</i> . USDA Forest Service GTR RM-120, pp. 175-179.
3	Atchafalaya, Louisiana	Riparian	<p>Overflow areas in the Atchafalaya Basin had large areal net exports of total nitrogen (predominantly organic nitrogen) and dissolved organic carbon but acted as a sink for phosphorus. Ammonia levels increased dramatically during the summer. The Atchafalaya Basin floodway acted as a sink for total organic carbon mainly through particulate organic carbon (POC). Net export of dissolved organic carbon was very similar to that of POC for all three areas.</p>	Lambou, V.W. 1985. Aquatic Organic Carbon and Nutrient Fluxes, Water Quality, and Aquatic Productivity in the Atchafalaya Basin, Louisiana. In <i>Riparian Ecosystems and Their Management: Reconciling Conflicting Issues</i> . USDA Forest Service GTR RM-120, pp. 180-185.

Table 7-1. (Continued)

No.	Location	Wetland/ Riparian	Summary of Observations	Source
4	Wyoming	Riparian	The Green River drains 12,000 mi ² of western Wyoming and northern Utah and incorporates a diverse spectrum of geology, topography, soils, and climate. Land use is predominantly range and forest. A multiple regression model was used to associate various riparian and nonriparian basin attributes (geologic substrate, land use, channel slope, etc.) with previous measurements of phosphorus, nitrate, and dissolved solids.	Fannin, T.E., M. Parker, and T.J. Maret. 1985. Multiple Regression Analysis for Evaluating Non-point Source Contributions to Water Quality in the Green River, Wyoming. In <i>Riparian Ecosystems and Their Management: Reconciling Conflicting Issues</i> . USDA Forest Service GTR RM-120, pp. 201-205.
5	Rhode River Subwatershed, Maryland	Riparian	<p>A case study focusing on the hydrology and below-ground processing of nitrate and sulfate was conducted on a riparian forest wetland. Nitrate and sulfate entered the wetland from cropland ground-water drainage and from direct precipitation. Data collected for 3 years to construct monthly mass balances of the fluxes of nitrate and sulfate into and out of the soils of the wetland showed:</p> <ul style="list-style-type: none"> • Averages of 86% of nitrate inputs were removed in the wetland. • Averages of 25% of sulfates were removed in the wetland. • Annual removal of nitrates varied from 87% in the first year to 84% in the second year. • Annual removal of sulfate varied from 13% in the second year to 43% in the third year. • On average, inputs of nitrate and sulfate were highest in the winter. • Nitrate outputs were always highest in the winter. • Nitrate removal was always highest in the fall (average of 96%) when input fluxes were lowest and lowest in winter (average of 81%) when input fluxes were highest. 	Correll, D.L., and D.E. Weller. 1989. Factors Limiting Processes in Freshwater: An Agricultural Primary Stream Riparian Forest. In <i>Freshwater Wetlands and Wildlife</i> , ed. R.R. Sharitz and J.W. Gibbons, pp. 9-23. U.S. Department of Energy, Office of Science and Technology, Oak Ridge, Tennessee. DOE Symposium Series #61.

Table 7-1. (Continued)

No.	Location	Wetland/ Riparian	Summary of Observations	Source
6	Carmel River, California	Riparian	Ground water is closely coupled with streamflow to maintain water supply to riparian vegetation, particularly where precipitation is seasonal. A case study is presented where Mediterranean climate and ground-water extraction are linked with the decline of riparian vegetation and subsequent severe bank erosion on the Carmel River.	Groenveld, D. P., and E. Griepentrog. 1985. Interdependence of Groundwater, Riparian Vegetation, and Streambank Stability: A Case Study. In <i>Riparian Ecosystems and their Management: Reconciling Conflicting Issues</i> . USDA Forest Service GTR RM-120, pp. 201-205.
7	Cashe River, Arkansas	Riparian	<p>A long-term study is being conducted to determine the chemical and hydrological functions of bottomland hardwood wetlands. Hydrologic gauging stations have been established at inflow and outflow points on the river, and over 25 chemical constituents have been measured. Preliminary results for the 1988 water year indicated:</p> <ul style="list-style-type: none"> • Retention of total and inorganic suspended solids and nitrate; • Exportation of organic suspended solids, total and dissolved organic carbon, inorganic carbon, total phosphorus, soluble reactive phosphorus, ammonia, and total Kjeldahl nitrogen; • All measured constituents were exported during low water when there was limited contact between the river and the wetlands; and • All measured constituents were retained when the Cypress-Tupelo part of the floodplain was inundated. 	Kleiss, B. et al. 1989. Modification of Riverine Water Quality by an Adjacent Bottomland Hardwood Wetland. In <i>Wetlands: Concerns and Successes</i> , pp. 429-438. American Water Resources Association.
8	Scotsman Valley, New Zealand	Riparian	<p>Nitrate removal in riparian areas was determined using a mass balance procedure in a small New Zealand headwater stream. The results of 12 surveys showed:</p> <ul style="list-style-type: none"> • The majority of nitrate removal occurred in riparian organic soils (56-100%) even though the soils occupied only 12% of the stream's border. • The disproportionate role of organic soils in removing nitrate was due in part to their location in the riparian zone. A high percentage (37-81%) of ground water flowed through these areas on its passage to the stream. • Anoxic conditions and high concentrations of denitrifying enzymes and available carbon in the soils also contributed to the role of the organic soils in removing nitrates. 	Cooper, A.B. 1990. Nitrate Depletion in the Riparian Zone and Stream Channel of a Small Headwater Catchment. <i>Hydrobiologia</i> , 202:13-26.

Table 7-1. (Continued)

No.	Location	Wetland/ Riparian	Summary of Observations	Source
9	Wye Island, Maryland	Riparian	<p>Changes in nitrate concentrations in ground water between an agricultural field planted in tall fescue (<i>Festuca arundinacea</i>) and riparian zones vegetated by leguminous or nonleguminous trees were measured to:</p> <ul style="list-style-type: none"> • Determine the effectiveness of riparian vegetation management practices in the reduction of nitrate concentrations in ground water; • Identify effects of leguminous and nonleguminous trees on riparian attenuation of nitrates; and • Measure the seasonal variability of riparian vegetation's effect on the chemical composition of ground water. <p>Based on the analysis of shallow ground-water samples, the following patterns were observed:</p> <ul style="list-style-type: none"> • Ground-water nitrate concentrations beneath non-leguminous riparian trees decreased toward the shoreline, and removal of the trees resulted in increased nitrate concentrations. • Nitrate concentrations did not decrease from the field to the riparian zone in ground water below leguminous trees, and removal of the trees resulted in decreased ground-water nitrate concentrations. • Maximum attenuation of nitrate concentrations occurred in the fall and winter under non-leguminous trees. 	James, B.R., B.B. Bagley, and P.H. Gallagher, P.H. 1990. Riparian Zone Vegetation Effects on Nitrate Concentrations in Shallow Groundwater. Submitted for publication in the <i>Proceedings of the 1990 Chesapeake Bay Research Conference</i> . University of Maryland, Soil Chemistry Laboratory, College Park, Maryland.
10	Little Lost Man Creek, Humboldt, California	Riparian	<p>Nitrate retention was evaluated in a third-order stream under background conditions and during four intervals of modified nitrate concentration caused by nutrient amendments or storm-enhanced discharge. Measurements of the stream response to nitrate loading and storm discharge showed:</p> <ul style="list-style-type: none"> • Under normal background conditions, nitrate was exported from the subsurface (11% greater than input). • With increased nitrate input, there was an initial 39% reduction from the subsurface followed by a steady state reduction of 14%. • During a storm event, the subsurface area exported an increase of 6%. 	Triska, F.J., V.C. Kennedy, R.J. Avanzino, G.W. Zellweger, and K.E. Bencala. 1990. In Situ Retention-Transport Response to Nitrate Loading and Storm Discharge in a Third-Order Stream. <i>Journal of North American Benthological Society</i> , 9(3):229-239.

Table 7-1. (Continued)

No.	Location	Wetland/ Riparian	Summary of Observations	Source
11	Toronto, Ontario, Canada	Riparian	<p>Field enrichments of nitrate in two spring-fed drainage lines showed an absence of nitrate depletion within the riparian zone of a woodland stream. The results of the study indicated:</p> <ul style="list-style-type: none"> • The efficiency of nitrate removal within the riparian zone may be limited by short water residence times. • The characteristics of the substrate and the routes of ground-water movement are important in determining nitrate attenuation within riparian zones. 	Warwick, J., and A.R. Hill. 1988. Nitrate Depletion in the Riparian Zone in a Small Woodland Stream. <i>Hydrobiologia</i> , 157:231-240.
12	Little River, Tifton, Georgia	Riparian	<p>A study was conducted on riparian forests located adjacent to agricultural uplands to test their ability to intercept and utilize nutrients (N, P, K, Ca) transported from these uplands. Tissue nutrient concentrations, nutrient accretion rates, and production rates of woody plants on these sites were compared to control sites. Data from this study provide evidence that young (bloom state) riparian forests within agricultural ecosystems absorb nutrients lost from agricultural uplands.</p>	Fail, J.L. Jr., Haines, B.L., and Todd, R.L. Undated. Riparian Forest Communities and Their Role in Nutrient Conservation in an Agricultural Watershed. <i>American Journal of Alternative Agriculture</i> , 11(3):114-120.
13	Chowan River Watershed, North Carolina	Riparian	<p>A study was conducted to determine the trapping efficiency for sediments deposited over a 20-year period in the riparian areas of two watersheds. ¹³⁷CS data and soil morphology were used to determine areal extent and thickness of the sediments. Results of the study showed:</p> <ul style="list-style-type: none"> • Approximately 80% of the sediment measured was deposited in the floodplain swamp. • Greater than 50% of the sediment was deposited within the first 100 m adjacent to cultivated fields. • Sediment delivery estimates indicated that 84% to 90% of the sediment removed from cultivated fields remained in the riparian areas of a watershed. 	Cooper, J.R., J.W. Gilliam, R.B. Daniels, and W.P. Robarge. 1987. Riparian Areas as Filters for Agriculture Sediment. <i>Soil Science Society of America Journal</i> , 51(6):417-420.
14	New Zealand	Riparian	<p>Several recent studies in agricultural fields and forests showed evidence of significant nitrate removal from drainage water by riparian zones. The results of these studies showed:</p> <ul style="list-style-type: none"> • A typical removal of nitrate of greater than 85% and • An increase of nitrate removal by denitrification where greater contact occurred between leaching nitrate and decaying vegetative matter. 	Schipper, L.A., A.B. Cooper, and W.J. Dyck. 1989. Mitigating Non-point Source Nitrate Pollution by Riparian Zone Denitrification. Forest Research Institute, Rotorua, New Zealand.

Table 7-1. (Continued)

No.	Location	Wetland/ Riparian	Summary of Observations	Source
15	Georgia	Riparian	A streamside, mixed hardwood, riparian forest near Tifton, Georgia, set in an agricultural watershed was effective in retaining nitrogen (67%), phosphorus (25%), calcium (42%), and magnesium (22%). Nitrogen was removed from subsurface water by plant uptake and microbial processes. Riparian land use was also shown to affect the nutrient removal characteristics of the riparian area. Forested areas were more effective in nutrient removal than pasture areas, which were more effective than croplands.	Lowrance, R.R., R.L. Todd, and L.E. Asmussen. 1983. Waterborne Nutrient Budgets for the Riparian Zone of an Agricultural Watershed. <i>Agriculture, Ecosystems and Environment</i> , 10:371-384.
16	North Carolina	Riparian	Riparian forests are effective as sediment and nutrient (N and P) filters. The optimal width of a riparian forest for effective filtering is based on the contributing area, slope, and cultural practices on adjacent fields.	Cooper, J. R., J. W. Gilliam, and T. C. Jacobs. 1986. Riparian Areas as a Control of Nonpoint Pollutants. In <i>Watershed Research Perspectives</i> , ed. D. Correll, Smithsonian Institution Press, Washington, DC.
17	Unknown	Riparian	A riparian forest acted as an efficient sediment trap for most observed flow rates, but in extreme storm events suspended solids were exported from the riparian area.	Karr, J.R., and O.T. Gorman. 1975. Effects of Land Treatment on the Aquatic Environment. In <i>U.S. EPA Non-Point Source Pollution Seminar</i> , pp. 4-1 to 4-18. U.S. Environmental Protection Agency, Washington, DC. EPA 905/9-75-007.
18	Arkansas	Riparian	The Army Corps of Engineers studied a 20-mile stretch of the Cashe River in Arkansas where floodplain deposition reduced suspended solids by 50%, nitrates by 80%, and phosphates by 50%.	Stuart, G., and J. Greis. 1991. <i>Role of Riparian Forests in Water Quality on Agricultural Watersheds</i> .

Table 7-1. (Continued)

No.	Location	Wetland/ Riparian	Summary of Observations	Source
19	Maryland	Riparian	<p>Phosphorus export from the forest was nearly evenly divided between surface runoff (59%) and ground-water flow (41%), for a total P removal of 80%. The mean annual concentration of dissolved total P changed little in surface runoff. Most of the concentration changes occurred during the first 19 m of the riparian forest for both dissolved and particulate pollutants. Dissolved nitrogen compounds in surface runoff also declined. Total reductions of 79% for nitrate, 73% for ammonium-N and 62% for organic N were observed. Changes in mean annual ground-water concentrations indicated that nitrate concentrations decreased significantly (90-98%) while ammonium-N concentrations increased in concentration greater than threefold. Again, most of the nitrate loss occurred within the first 19 m of the riparian forest. Thus it appears that the major pathway of nitrogen loss from the forest was in subsurface flow (75% of the total N), with a total removal efficiency of 89% total N.</p>	<p>Peterjohn, W.T., and D.L. Correll. 1984. Nutrient Dynamics in an Agricultural Watershed: Observations on the Role of a Riparian Forest. <i>Ecology</i>, 65:1466-1475.</p>
20	France	Riparian	<p>Denitrification explained the reduction of the nitrate load in ground water beneath the riparian area. Models used to explain the nitrogen dynamics in the riparian area of the Lounge River indicate that the frequency, intensity, and duration of flooding influence the nitrogen-removal capacity of the riparian area.</p> <p>Three management practices in riparian areas would enhance the nitrogen-removal characteristics, including:</p> <ul style="list-style-type: none"> • River flow regulation to enhance flooding in riparian areas, which increases the waterlogged soil areas along the entire stretch of river; • Reduced land drainage to raise the water table, which increases the duration and area of waterlogged soils; and • Decreased deforestation of riparian forests, which maintains the amount of carbon (i.e., the energetic input that allows for microbial denitrification). 	<p>Pinay, G., and H. Decamps. 1988. The Role of Riparian Woods in Regulating Nitrogen Fluxes Between the Alluvial Aquifer and Surface Water: A Conceptual Model. <i>Regulated Rivers: Research and Management</i>, 2:507-516.</p>

Table 7-1. (Continued)

No.	Location	Wetland/ Riparian	Summary of Observations	Source
21	Georgia	Riparian	Processes within the riparian area apparently converted primarily inorganic N (76% nitrate, 6% ammonia, 18% organic N) into primarily organic N (10% nitrate, 14% ammonia, 76% organic N).	Lowrance, R.R., R.L. Todd, and L.E. Assmusen. 1984. Nutrient Cycling in an Agricultural Watershed: Phreatic Movement. <i>Journal of Environmental Quality</i> , 13(1):22-27.
22	North Carolina	Riaparian	Subsurface nitrate leaving agricultural fields was reduced by 93% on average.	Jacobs, T.C., and J.W. Gilliam. 1985. Riparian Losses of Nitrate from Agricultural Drainage Waters. <i>Journal of Environmental Quality</i> , 14(4):472-478.
23	North Carolina	Riparian	Over the last 20 years, a riparian forest provided a sink for about 50% of the phosphate washed from cropland.	Cooper, J.R., and J.W. Gilliam. 1987. Phosphorus Redistribution from Cultivated Fields into Riparian Areas. <i>Soil Science Society of America Journal</i> , 51(6):1600-1604.
24	Illinois	Riparian	Small streams on agriculture watersheds in Illinois had the greatest water temperature problems. The removal of shade increased water temperature 10-15 degrees Fahrenheit. Slight increases in water temperature over 60 °F caused a significant increase in phosphorus release from sediments.	Karr, J.R., and I.J. Schlosser. 1977. <i>Impact of Nearstream Vegetation and Stream Morphology on Water Quality and Stream Biota</i> . Ecological Research Series, EPA-600/3-77-097. U.S. Environmental Protection Agency, Washington, DC.

a. Multiple Benefits

The preservation and protection of wetlands and riparian areas are encouraged because these natural systems have been shown to provide many benefits, in addition to providing the potential for NPS pollution reduction (Table 7-2). The basis of protection involves minimizing impacts to wetlands and riparian areas serving to control NPS pollution by maintaining the existing functions of the wetlands and riparian areas, including vegetative composition and cover, flow characteristics of surface water and ground water, hydrology and geochemical characteristics of substrate, and species composition (Azous, 1991; Hammer, 1992; Mitsch and Gosselink, 1986; Reinelt and Horner, 1990; Richter et al., 1991; Stockdale, 1991).

Wetlands and riparian areas perform important functions such as providing a source of food for a variety of wildlife, a source of nesting material, habitat for aquatic animals, and nursery areas for fish and wildlife (Atcheson et al., 1979). Animals whose development histories include an aquatic phase—amphibians, some reptiles, and invertebrates—need wetlands to provide aquatic habitat (Mitsch and Gosselink, 1986). Other important functions of wetlands and riparian areas include floodwater storage, erosion control, and ground-water recharge. Protection of wetlands and riparian areas should allow for both NPS control and other corollary benefits of these natural aquatic systems.

b. Nonpoint Pollution Abatement Function

Table 7-1 is a representative listing of the types of research results that have been compiled to document the effectiveness of wetlands and riparian areas in serving an NPS pollution abatement function. Wetlands and riparian areas remove more than 50 percent of the suspended solids entering them (Karr and Gorman, 1975; Lowrance et al., 1984; Stuart and Greis, 1991). Sixty to seventy-five percent of total nitrogen loads are typically removed from surface and ground waters by wetlands and riparian areas (Cooper, 1990; Jacobs and Gilliam, 1985; James et al., 1990; Lowrance et al., 1983; Lowrance et al., 1984; Peterjohn and Correll, 1984; Pinay and Decamps, 1988; Stuart and Greis, 1991). Phosphorus removal in wetlands and riparian areas ranges from 50 percent to 80 percent (Cooper and Gilliam, 1987; Peterjohn and Correll, 1984; Stuart and Greis, 1991).

c. Degradation Increases Pollution

Tidal wetlands perform many water quality functions; when severely degraded, however, they can be a source of nonpoint pollution (Richardson, 1988). For example, the drainage of tidal wetlands underlain by a layer of organic peat can cause the soil to rapidly decompose and release sulfuric acid, which may significantly reduce pH in surrounding waters. Removal of wetland or riparian area vegetation along the shorelines of streams, bays, or estuaries makes these areas more vulnerable to erosion from storm events, wave action, or concentrated runoff. Activities such as channelization, which modify the hydrology of floodplain wetlands, can alter the ability of these areas to retain sediment when they are flooded and result instead in erosion and a net export of sediment from the wetland (Reinelt and Horner, 1990).

4. Practices

As discussed more fully at the beginning of this chapter and in Chapter 1, the following practices are described for illustrative purposes only. State programs need not require implementation of these practices. However, as a practical matter, EPA anticipates that the management measure set forth above generally will be implemented by applying one or more management practices appropriate to the source, location, and climate. The practices set forth below have been found by EPA to be representative of the types of practices that can be applied successfully to achieve the management measure described above.

**Table 7-2. Range of Functions of Wetlands and Riparian Areas
(adapted from National Research Council, 1991)**

Function	Example
Flood conveyance	Riverine wetlands and adjacent floodplain lands often form natural floodways that convey floodwaters from upstream to downstream areas.
Protection from storm waves and erosion	Coastal wetlands and inland wetlands adjoining larger lakes and rivers reduce the impact of storm tides and waves before they reach upland areas.
Flood storage	Inland wetlands may store water during floods and slowly release it to downstream areas, lowering flood peaks.
Sediment control	Wetlands reduce flood flows and the velocity of floodwaters, reducing erosion and causing floodwaters to release sediment.
Habitat for fish and shellfish	Wetlands are important spawning and nursery areas and provide sources of nutrients for commercial and recreational fin and shellfish industries, particularly in coastal areas.
Habitat for waterfowl and other wildlife	Both coastal and inland wetlands provide essential breeding, nesting, feeding, and refuge sites for many forms of waterfowl, other birds, mammals, and reptiles.
Habitat for rare and endangered species	Almost 35 percent of all rare and endangered animal species either are located in wetland areas or are dependent on them, although wetlands constitute only about 5 percent of the coterminous United States.
Recreation	Wetlands serve as recreation sites for fishing, hunting, and observing wildlife.
Source of water supply	Wetlands are important in replacing and maintaining supplies of ground water and surface water.
Natural products	Under proper management, forested wetlands are an important source of timber, despite the physical problems of timber removal. Under selected circumstances, natural products such as timber and furs can be harvested from wetlands.
Preservation of historic, archaeological values	Some wetlands are of archaeological interest. Native American settlements were sometimes located in coastal and inland wetlands, which served as sources of fish and shellfish.
Education and research	Tidal, coastal, and inland wetlands provide educational opportunities for nature observation and scientific study.
Source of open space and contribution to aesthetic values	Both tidal and inland wetlands are areas of great diversity and beauty, and they provide open space for recreational and visual enjoyment.

■ a. *Consider wetlands and riparian areas and their NPS control potential on a watershed or landscape scale.*

Wetlands and riparian areas should be considered as part of a continuum of filters along rivers, streams, and coastal waters that together serve an important NPS abatement function. Examples of the practice were outlined by Whigham and others (1988). They found that a landscape approach can be used to make reasonable decisions about how any particular wetland might affect water quality parameters. Wetlands in the upper parts of the drainage systems in particular have a greater impact on water quality. Hanson and others (1990) used a model to determine the effect of riparian forest fragmentation on forest dynamics. They concluded that increased fragmentation would lead to lower species diversity and an increased prevalence of species that are adapted to isolated conditions. Naiman and others (1988) discussed the importance of wetlands and riparian areas as boundary ecosystems, providing a boundary between terrestrial and aquatic ecosystems. Wetlands and riparian areas are particularly sensitive to landscape changes and fragmentation. Wetland and riparian boundaries covering large areas may persist longer than those on smaller spatial scales and probably have different functional values (Mitsch, 1992).

Several States have outlined the role of wetlands and riparian areas in case studies of basinwide and statewide water quality plans. A basinwide plan for the restoration of the Anacostia River and associated tributaries considered in detail the impacts of wetlands creation and riparian plantings (USACE, 1990). In Louisiana and Washington State, EPA has conducted studies that use the synoptic approach to consider wetlands' water quality function on a landscape scale (Abbruzzese et al., 1990a, 1990b). The synoptic approach considers the environmental effects of cumulative wetlands losses. In addition, this approach involves assembling a framework that ranks watersheds according to the relative importance of wetland functions and losses. States are also encouraged to refine their water quality standards applicable to wetlands by assigning wetlands-specific designated uses to classes of wetlands.

■ b. *Identify existing functions of those wetlands and riparian areas with significant NPS control potential when implementing NPS management practices. Do not alter wetlands or riparian areas to improve their water quality function at the expense of their other functions.*

In general, the following practices should be avoided: (1) location of surface water runoff ponds or sediment retention basins in healthy wetland systems and (2) extensive dredging and plant harvesting as part of nutrient or metals management in natural wetlands. Some harvesting may be necessary to control the invasion of exotic plants. Extensive harvesting for surface water runoff or nutrient management, however, can be very disruptive to the existing plant and animal communities.

■ c. *Conduct permitting, licensing, certification, and nonregulatory NPS pollution abatement activities in a manner that protects wetland functions.*

There are many possible programs, both regulatory and nonregulatory, to protect wetland functions. Table 7-3 contains a representative listing of Federal, State, and Federal/State programs whose primary goals involve the identification, technical study, or management of wetlands protection efforts. Table 7-4 provides a list of Federal programs involved in the protection and restoration of wetlands and riparian areas on private lands. Federal programs with cost-share funds are designated as such in Table 7-4. The list of possible programmatic approaches to wetlands protection includes the following:

Acquisition. Obtain easements or full acquisition rights for wetlands and riparian areas along streams, bays, and estuaries. Numerous Federal programs, such as the U.S. Department of Agriculture (USDA) Wetlands Reserve, administered by USDA's Agricultural Stabilization and Conservation Service (USDA-ASCS) with technical assistance provided by USDA's Soil Conservation Service (USDA-SCS) and U.S. Department of the Interior - Fish and Wildlife Service (USDOI-FWS), and the Fish and Wildlife Service North American Waterfowl Management Plan can provide assistance for acquiring easements or full title. Acquisition of water rights to ensure maintenance of minimum instream flows is another means to protect riparian/wetland areas, and it can be a critical issue in the arid West. In Arizona, The Nature Conservancy has acquired an instream water rights certificate for its Ramsey Canyon preserve

Table 7-3. Federal, State, and Federal/State Programs for Wetlands Identification, Technical Study, or Management of Wetlands Protection Efforts

No.	Location	Type of Wetland	Summary of Observations	Source
1	New Mexico	Riparian/ Wetland	This Bureau of Land Management (BLM) document identifies planning strategies and needs for future planning for riparian-wetland area resource management in New Mexico.	USDOJ, BLM, New Mexico State Office. 1990. <i>New Mexico Riparian-Wetland 2000: A Management Strategy</i> . U.S. Department of the Interior, Bureau of Land Management.
2	Washington and Oregon	Riparian	Riparian areas on BLM lands in OR and WA are managed by a combination of land-use allocations and management practices designed to protect and restore their natural functions. The riparian-stream ecosystem is managed as one unit, designated as a Riparian Management Area (RMA). Riparian areas are classified by stream order. Timber harvesting is generally restricted from those riparian areas with the highest nontimber resource values. Mitigation measures are also used to reduce impacts from timber harvesting in riparian areas with minor nontimber values.	Oakely, A.L. 1988. Riparian Management Practices of the Bureau of Land Management. In <i>Streamside Management: Riparian Wildlife and Forestry Interactions</i> , pp. 191-196.
3	Pacific Northwest	Riparian	The Bureau of Indian Affairs has no formal riparian management policy because BIA management must be done in cooperation with the tribe. This situation creates tremendous variation in Indian lands management because the individual management plans must be tailored to the needs of the individual tribe.	Bradley, W.P. 1988. Riparian Management Practices on Indian Lands. In <i>Streamside Management: Riparian Wildlife and Forestry Interactions</i> , pp. 201-206.
4	Washington	Riparian	This article discusses the riparian management policies of the Washington State Dept. of Natural Resources, including design and concerns of Riparian Management Zones.	Calhoun, J.M. 1988. Riparian Management Practices of the Department of Natural Resources. In <i>Streamside Management: Riparian Wildlife and Forestry Interactions</i> , pp. 207-211.
5		Riparian	The Tennessee Valley Authority, since its inception, has promoted the protection and management of the riparian resources of the Tennessee River drainage basin. Current policies, practices, and major programs providing for protection of the riparian environment are described.	Allen, R.T., and R.J. Field. 1985. Riparian Zone Protection by TVA: An Overview of Policies and Programs. In <i>Riparian Ecosystems and Their Management: Reconciling Conflicting Issues</i> . USDA Forest Service GTR RM-120, pp. 23-26.

Table 7-3. (Continued)

No.	Location	Type of Wetland	Summary of Observations	Source
6		Riparian	Riparian zones play a major role in water quality management. Water supply considerations and maintenance of streamside zones from the municipal watershed manager's viewpoint are detailed. Management impacts affecting water quality and quantity on forested municipal watersheds are discussed in relation to the structure of the riparian zone. The impacts of management are often integrated in the channel area and in the quality of streamflow. Learning to read early signs of stress here will aid in evaluating how much "management" a watershed can take.	Corbet, E.S., and J.A. Lynch. 1985. Management of Streamside Zones on Municipal Watersheds. In <i>Riparian Ecosystems and Their Management: Reconciling Conflicting Issues</i> . USDA Forest Service GTR RM-120, pp. 187-190.
7		Riparian	Construction of small dams, suppression of woody vegetation in riparian zones, and removal of livestock from streambanks have all led to summer streamflow increase. Potential may exist to manage small valley bottoms for summer flow increase while maintaining or improving habitat, range, and watershed values.	Stabler, D.F. 1985. Increasing Summer Flow in Small Streams Through Management of Riparian Areas and Adjacent Vegetation: A Synthesis. In <i>Riparian Ecosystems and Their Management: Reconciling Conflicting Issues</i> . USDA Forest Service GTR RM-120, pp. 206-210.
8	Queen Creek, Arizona	Riparian	The interrelationships between riparian vegetation development and hydrologic regimes in an ephemeral desert stream were examined at Whitlow Ranch Dam along Queen Creek in Pinal County, Arizona. The data indicate that a flood control structure can have a positive impact on riparian ecosystem development and could be used as a mitigation tool to restore this critically threatened habitat. Only 7 years after dam completion, aerial photos documented a dramatic change in the vegetation. The riparian vegetation consisted of a vigorously expanding Sonoran deciduous forest of Gooding willow and saltcedar occupying an area of approximately 17.7 ha.	Szaro, R.C., and L.F. DeBano. 1985. The Effects of Streamflow Modification on the Development of a Riparian Ecosystem. In <i>Riparian Ecosystems and Their Management: Reconciling Conflicting Issues</i> . USDA Forest Service GTR RM-120, pp. 211-215.

Table 7-3. (Continued)

No.	Location	Type of Wetland	Summary of Observations	Source
9	Southwest	Riparian	Native American and Spanish American farmers of the arid Southwest have managed riparian vegetation adjacent to their agricultural fields for centuries. They have planted, pruned, and encouraged phreatophytic tree species for flood erosion control, soil fertility renewal, buffered field microclimate, and fuel-wood production. These practices benefit wildlife and plant genetic diversity. The benefits and stability of native riparian vegetative mosaics are difficult to assess in monetary or energetic terms, but are nonetheless significant.	Nabhan, G.P. 1985. Riparian Vegetation and Indigenous Southwestern Agriculture: Control of Erosion, Pests, and Microclimate. In <i>Riparian Ecosystems and Their Management: Reconciling Conflicting Issues</i> . USDA Forest Service GTR RM-120, pp. 232-236.
10		Riparian	Many management goals can be developed for riparian habitats. Each goal may dictate different management policies and tactics and result in different impacts on wildlife. Vegetation structure of riparian areas, expressed in terms of habitat layers, can provide a useful framework for developing effective strategies for a variety of management goals because many different land uses can be associated with habitat layers. Well-developed goals are essential both for purposeful habitat management and for monitoring the impacts of different land uses on habitats.	Short, H.L. 1985. Management Goals and Habitat Structure. In <i>Riparian Ecosystems and Their Management: Reconciling Conflicting Issues</i> . USDA Forest Service GTR RM-120, pp. 232-236.
11	Maine	Riparian	Riparian zones serve important functions for fisheries and aquatic systems: shading, bank stability, prevention of excess sedimentation, overhanging cover for fish, and energy input from invertebrates and allochthonous material. Impacts from loss of riparian areas are discussed in relation to aquatic ecosystems, and the results of two recent studies in Maine are reviewed. Intact riparian zones have inherent values to aquatic systems and though 23-m intact riparian strips are often recommended for stream protection, wildlife biologists are often recommending wider zones because of their value as animal corridors and winter deer yards.	Moring, J.R., G.C. Carman, and D.M. Mullen. 1985. The Value of Riparian Zones for Protecting Aquatic Systems: General Concerns and Recent Studies in Maine. In <i>Riparian Ecosystems and Their Management: Reconciling Conflicting Issues</i> . USDA Forest Service GTR RM-120, pp. 315-319.

Table 7-3. (Continued)

No.	Location	Type of Wetland	Summary of Observations	Source
12	Siskiyou National Forest	Riparian	The Siskiyou National Forest in Oregon has managed riparian areas along the Pacific coast where high-value conifers stand near streams bearing salmonid fisheries. Riparian areas are managed by setting objectives that allow for limited timber harvest along with stream protection. The annual sale quantity from the forest is reduced by 13% to protect riparian areas and the fishery resource. Typically, timber harvest will remove 40-50% of the standing timber volume within nonfish-bearing riparian areas and 0-10% along streams that support fish.	Anderson, M.T. 1985. Riparian Management of Coastal Pacific Ecosystems. In <i>Riparian Ecosystems and Their Management: Reconciling Conflicting Issues</i> . USDA Forest Service GTR RM-120, pp. 364-368.
13	California	Riparian	A riparian reserve has been established on the UC Davis campus. The 80-acre Putah Cr. Reserve offers the opportunity to research issues related to the typically leveed floodways that flow through California's agricultural landscape. With over 90% of the original riparian systems of California completely eliminated, the remaining "altered" systems represent environmental corridors of significant value to conservation. The key to improving the habitat value of these systems is researching floodway management alternatives that use an integrated approach.	Dawson, K.J., and G.E. Sutter. 1985. Research Issues in Riparian Landscape Planning. In <i>Riparian Ecosystems and Their Management: Reconciling Conflicting Issues</i> . USDA Forest Service GTR RM-120, pp. 408-412.
14	Pacific Northwest	Riparian	Since 1970 the National Forests in Oregon and Washington have been operating under a Regionally developed streamside management unit (SMU) concept, which is essentially a stream classification system based on the use made of the water with specific water quality objectives established for each of the four classes of streams. Inherent in the concept is the underlying premise that the land immediately adjacent to streams is key to protecting water quality. This land can be managed to protect the riparian values and in most cases still achieve a reasonable return of other resource values.	Swank, G.W. 1985. Streamside Management Units in the Pacific Northwest. In <i>Riparian Ecosystems and Their Management: Reconciling Conflicting Issues</i> . USDA Forest Service GTR RM-120, pp. 435-438.
15	Pacific Northwest	Riparian	The USDA Forest Service's concepts of multiple-use and riparian-area-dependent resources were incorporated into a district-level riparian area management policy. Identifying the degree of dependence on forest resource values and uses on specific characteristics of the riparian area is a key to determining which resources are to be emphasized during management. The linkage of riparian areas to the aquatic resource and cumulative processes is integrated into the policy designed to provide consistent direction for on-the-ground management.	Vanderhayden, J. 1985. Managing Multiple Resources in Western Cascades Forest Riparian Areas: An Example. In <i>Riparian Ecosystems and Their Management: Reconciling Conflicting Issues</i> . USDA Forest Service GTR RM-120, pp. 448-452.

Table 7-4. Federal Programs Involved in the Protection and Restoration of Wetlands and Riparian Areas on Private Lands

Agency	Type of Program	Cost Share Program	Activities and Funding
U.S. Department of the Army - Army Corps of Engineers	Dredged and fill permit program	No	<ul style="list-style-type: none"> Regulates the discharge of dredged or fill material into waters of the United States, including wetlands.
U.S. Dept. of the Interior - Fish and Wildlife Service	Private Lands Program	No	<ul style="list-style-type: none"> Provides funding to aid in the restoration of wetland functions. Many efforts are targeted at restoring wetlands that offer important habitat for migratory birds and other Federal Trust species.
USDOJ - FWS	North American Waterfowl Management Plan	No	<ul style="list-style-type: none"> The plan includes the restoration and enhancement of several million acres of wetlands for migratory birds in Canada, Mexico, and the United States. The NAWMP is being implemented through innovative Federal-State-private partnerships within and between States and Provinces. Currently, a grants program exists for acquisition, restoration, enhancement, creation, management, and other activities that conserve wetlands and fish and wildlife that depend upon such habitats. Research, planning, payment of interest, conservation education programs, and construction of buildings are activities that are ineligible for funds under this program.
USDOJ-FWS	Coastal Wetlands Conservation Grants Program	Yes	<ul style="list-style-type: none"> Provides 50% matching grants to coastal States for acquisition, restoration, and enhancement of coastal wetlands. States with established trust funds for acquiring coastal wetlands, other natural areas, or open spaces are eligible for 75% matching grants.
USDOJ - Office of Surface Mining	Experimental practices programs	No	<ul style="list-style-type: none"> Although the agency does not have a cost share program for wetlands restoration, it does assist coal companies in developing experimental practices that will provide environmental protection. The agency also pays States for the reclamation of lands previously left by coal companies.
U.S. Dept. of Agriculture Cooperative Extension Service		No	<ul style="list-style-type: none"> The national office encourages each State extension service to assist private landowners in the management and restoration of wetlands. Most State extension services provide information and technical assistance to landowners.

Table 7-4. (Continued)

Agency	Type of Program	Cost Share Program	Activities and Funding
USDA - Agricultural Stabilization and Conservation Service	Conservation Reserve Program	Yes	<ul style="list-style-type: none"> • More than 5,000 ha of wetlands have been restored under the CRP. • 380,000 ha of cropped wetlands and associated uplands have been reestablished in natural vegetation under 10-year contracts of up to \$50,000 per person per year. • The Secretary of Agriculture shares 50% of the total cost of establishing vegetative cover and 50% of the cost to maintain hardwood trees, shelterbelts, windbreaks, or wildlife corridors for a 2- to 4-year period.
USDA - ASCS	The Water Bank Program	Yes	<ul style="list-style-type: none"> • Objectives of the program are to preserve, restore, and improve the wetlands of the Nation. • The WBP applies to wetlands on designated farms identified by conservation plans developed in cooperation with Soil and Water Conservation Districts. • Protecting 190,000 ha of natural wetlands and adjacent buffer areas under 10-year rental agreements. Annual payments for 1991 ranged from \$7 to \$66 per acre. • The agency will cost-share up to 75% of the cost for cover for adjacent land only. These payments may be made to cover the costs of installing conservation practices developed to accomplish one of the following: establish or maintain vegetative cover; control erosion; establish or maintain shallow-water areas and improve habitat; conserve surface water and contribute to flood control and improve subsurface moisture; or provide bottomland hardwood management. • States participating in the 1992 Water Bank Program are Arkansas, California, Louisiana, Minnesota, Mississippi, Montana, Nebraska, North Dakota, Ohio, South Dakota, and Wisconsin.
USDA - ASCS	Wetland Reserve Program	Yes	<ul style="list-style-type: none"> • The WRP is expected to restore and protect up to 400,000 ha of wetlands in cropland on farms and ranches through easements. California, Iowa, Louisiana, Minnesota, Mississippi, Missouri, New York, North Carolina, and Wisconsin are currently the only States participating in the program although participation by all States is expected by 1993. • The program currently accepts only permanent easements and provides a 75% cost share for such. If in the future less-than-permanent easements are accepted, a 50% cost share would probably be provided.

Table 7-4. (Continued)

Agency	Type of Program	Cost Share Program	Activities and Funding
USDA - ASCS	Agricultural Conservation Program	Yes	<ul style="list-style-type: none"> • The ASCS will cost-share with farmers up to 75% of the cost of practices that help control NPS pollution. • Cost share has been provided for the restoration of 225,000 ha of wetlands over the last 30 years for the "Creation of Shallow Water Areas" practice. • Eligible cost share practices include establishment or improvement of permanent vegetative cover; installation of erosion control measures; planting of shrubs and trees for erosion control; and development of new or rehabilitation of existing shallow-water areas to support food, habitat, and cover for wildlife.
USDA - Soil Conservation Service			<ul style="list-style-type: none"> • The SCS provides technical assistance to private landowners for wetland restoration.

in the Huachuca Mountains. The certificate gives the Arizona Nature Conservancy the legal right to maintain instream flows in the stretch of Ramsey Creek along their property, which in turn preserves instream and riparian habitat and wildlife (Andy Laorenzi, personal communication, 5 October 1992). in turn preserves instream and riparian habitat and wildlife (Andy Laurenzi, personal communication, 5 October 1992).

Zoning and Protective Ordinances. Control activities with a negative impact on these targeted areas through special area zoning and transferable development rights. Identify impediments to wetland protection such as excessive street standards and setback requirements that limit site-planning options and sometimes force development into marginal wetland areas.

Baltimore County, Maryland, has adopted legislation to protect the water quality of streams, wetlands, and floodplains that requires forest buffers for any activity that is causing or contributing to pollution, including NPS pollution, of the waters of the State. Baltimore County has also developed management requirements for the forest buffers, including those located in wetlands and floodplains, that specify limitations on alteration of the natural conditions of these resources. The provisions call for public and private improvements to the forest buffer to abate and prevent water pollution, erosion, and sedimentation of stream channels and degradation of aquatic and riparian habitat.

Water Quality Standards. Almost all wetlands are *waters of the United States*, as defined in the Clean Water Act. Ensure that State water quality standards apply to wetlands. Consider natural water quality functions when specifying designated uses for wetlands, and include biological and hydrologic narrative criteria to protect the full range of wetland functions.

The State of Wisconsin has adopted specific wetlands water quality standards designed to protect the sediment and nutrient filtration or storage function of wetlands. The standards prohibit addition of those substances that would "otherwise adversely impact the quality of other waters of the State" beyond natural conditions of the affected wetland. In addition, the State has adopted criteria protecting the hydrologic conditions in wetlands to prevent significant adverse impacts on water currents, erosion or sedimentation patterns, and the chemical and nutrient regimes of the wetland. Wisconsin has also adopted a sequenced decision-making process for projects potentially

affecting wetlands that considers the wetland dependency of a project; practicable alternatives; and the direct, indirect, and cumulative impacts of the project.

Regulation and Enforcement. Establish, maintain, and strengthen regulatory and enforcement programs. Where allowed by law, include conditions in permits and licenses under CWA §401, §402, and §404; State regulations; or other regulations to protect wetlands.

Restoration. Programs such as USDA's Conservation Reserve and Wetlands Reserve Program provide opportunities to set aside and restore wetlands and riparian areas. Also, incentives that encourage private restoration of fish and wildlife productivity are more cost-effective than Federal acquisition and can in turn reduce property tax receipts by local government.

Education and Training. Educate farmers, urban dwellers, and Federal agencies on the role of wetlands and riparian areas in protecting water quality and on best management practices (BMPs) for restoring stream edges. Teach courses in simple restoration techniques for landowners.

Comprehensive Watershed Planning. Provide a mechanism for private landowners and agencies in mixed-ownership watersheds to develop, by consensus, goals, management plans, and appropriate practices and to obtain assistance from Federal and State agencies. Establish a framework for multiagency program linkage, and present opportunities to link implementation efforts aimed at protection or restoration of wetlands and riparian areas. EPA's National Estuary Program and the Fish and Wildlife Service's Bay/Estuary Program are excellent examples of this multiagency approach. A number of State and Federal agencies carry out programs with compatible NPS pollution reduction goals in the coastal zone. For example, Maryland's Nontidal Wetlands Protection Act encourages development of comprehensive watershed plans for addressing wetlands protection, mitigation, and restoration issues in conjunction with water supply issues. In addition, the U.S. Army Corps of Engineers (USACE) administers the CWA §404 program; USDA implements the Swampbuster, Conservation Reserve, and Wetlands Reserve Programs; EPA, USACE, and States work together to perform advanced identification of wetlands for special consideration (§404); and States administer both the Coastal Zone Management (CZM) program, which provides opportunity for consistency determinations, and the CWA §401 certification program, which allows for consideration of wetland protection and water quality objectives.

As an example of a linkage to protect NPS pollutant abatement and other benefits of wetlands, a State could determine under CWA §401 a proposed discharge or other activity in a wetland that is inconsistent with State water quality standards. Or, if a proposed permit is allowed contingent upon mitigation by creation of wetlands, such mitigation might be targeted in areas defined in the watershed assessment as needing restoration. Watershed- or site-specific permit conditions may be appropriate (e.g., specific widths for streamside management areas or structures based on adjacent land use activities). Similarly, USDA's Conservation Reserve Program or Wetlands Reserve Program could provide landowner assistance in areas identified by the NPS program as needing particular protection or riparian area reestablishment.

- d. *Use appropriate pretreatment practices such as vegetated treatment systems or detention or retention basins (Chapter 4) to prevent adverse impacts to wetland functions that affect NPS pollution abatement from hydrologic changes, sedimentation, or contaminants.*

For more information on the technical implementation and effectiveness of this practice, refer to Management Measure C in this chapter and Sections II.A and III.A of Chapter 4.

5. Costs for All Practices

This section describes costs for representative activities that would be undertaken in support of one or more of the practices listed under this management measure. The description of costs is grouped into the following categories:

- (1) For implementation of practice "a": costs for mapping, which aids in locating wetlands and riparian areas in the landscape and determining their relationship to land uses and their potential for NPS pollution abatement.
- (2) For implementation of practices "b" and "c": costs for wetland and riparian area protection programs.
- (3) For implementation of practice "d": costs for pretreatment such as filter strips, constructed wetlands, and detention or retention basins.

a. Mapping

The identification of wetlands within the watershed landscape, and their NPS pollution abatement potential, involves using maps to determine the characteristics as described in the management measure. These may include vegetation type and extent, soil type, distribution of fully submerged and partially submerged areas within the wetland boundary, and location of the boundary between wetlands and uplands. These types of features can be mapped through a variety of methods.

Lower levels of effort would characteristically involve the acquisition and field-checking of existing maps, such as those available for purchase from the U.S. Fish and Wildlife Service in the National Wetlands Inventory and U.S. Geological Survey (USGS) land use maps (information on these maps is available by calling 1-800-USA-MAPS). An intermediate level of effort would involve the collection and analysis of remote-sensing data, such as aerial photographs or digital satellite imagery. Depending on the size of the study area and the extent of the data to be categorized, the results of photo interpretation or of digital image analysis can be manipulated manually with a computerized database or electronically with a Geographic Information System. The most costly and labor-intensive approach involves plane-table surveys of the areas to be investigated.

Three separate costs are reported below from actual examples of recent projects involving wetland identification and assessment for purposes similar to the goal of the management measure. The examples represent different levels of effort that could be undertaken in support of practice "a" under the management measure.

- (1) A project in Clarks Fork, Montana, used remote sensing data for identification of wetlands that were potentially impaired from NPS pollution originating in adjacent portions of the watershed. In addition to identifying the type and extent of wetlands and riparian vegetation along Clarks Fork and the tributary streams, the mapping effort categorized land use in adjoining portions of the landscape. The results were used to identify areas within the watershed that could possibly be contributing NPS pollution in runoff to the wetlands and riparian areas (Lee, 1991).

Total costs for this project were estimated at \$0.06 per acre. The items of work include project management, collection of aerial photographs, film processing, and photo interpretation (Lee, 1991).

- (2) Remote sensing data have also been used as part of a statewide assessment of wetlands in Wisconsin. The purpose of the project is to determine areas within the landscape where changes are occurring in wetlands. Three or four counties are evaluated each year. The results are used to provide an ongoing update of changes to wetlands characteristics such as hydrology and vegetation (Lee, 1991).

Total costs for this project are approximately \$0.07 per acre. The items of work include collection of aerial photography, film processing, photo interpretation, and development and maintenance of a Geographic Information System (Lee, 1991).

- (3) The National Wetlands Inventory (NWI) has maps for 74 percent of the conterminous United States, 24 percent of Alaska, and all of Hawaii. Wetlands maps have been updated for wetlands assessment in three areas of the southeastern United States. The purpose of the project is to provide current data on the distribution of wetlands for project reviews, site characterizations, and ecological assessment (Kiralay et al., 1990).

Total costs reported for this work are listed in Table 7-5. The items of work include staff time, travel expenses, and per diem (Kiraly et al., 1990).

It is important to note that each of these three cases is presented for illustration purposes only. It is not necessary to acquire new data or maps to implement the practices and meet the management measure. Existing maps, surveys, or remotely sensed data (such as aerial photographs) can easily be used. These typically exist in files of State and local governments or educational institutions. Additional data on wetlands functions, locations, or ecological assessments can be culled from existing environmental impact statements, from old permit applications, or from watershed inventories. These sources of information in particular should be evaluated for their usefulness in categorizing historical conditions.

Where the need for new maps is recognized to meet the management measure, several Federal agencies provide mapping products that could be useful. Examples include the following:

- USDA aerial photography. Depending on the locality, this photography is available in black-and-white, color, or color-infrared (color-IR) formats.
- USGS aerial photography. A variety of photo products are available, for example, through the National Aerial Photography Program (NAPP).
- EPA Environmental Monitoring and Assessment Program (EMAP). Some opportunities for cost-shared projects are available to collect and analyze new imagery on the ecosystem or watershed level (Kiraly et al., 1990).

b. Wetland and Riparian Area Protection Programs

Examples of programmatic costs for implementing practices "b" and "c" under this management measure include costs for personnel, the administrative costs of processing applications for permits, and costs for public information brochures and pamphlets. Since some programs may already be in place, the need for apportionment of existing programmatic capabilities to NPS-related issues regarding wetlands and riparian areas will vary widely, depending on the size of the local jurisdiction, the nature and extent of wetland and riparian ecosystems present within the jurisdictional boundaries, and the severity of the NPS problem. Other programs may need to be adapted to include NPS-related issues regarding wetlands.

Six separate examples of costs for existing State wetland programs are shown in Table 7-6 for illustrative purposes. The costs reflect a range of low to high levels of effort, as measured through the assignment of individual full-time

Table 7-5. Total Costs for Wetlands Assessment Project Examples

Location of Project	Cost Item	Cost
Northeast Shark River near Slough, Mississippi	Four weeks of staff time	\$2,441
	Travel and per diem	<u>\$1,500</u>
	Total	\$3,941
West Broward County, Florida	Six weeks of staff time	\$3,362
	Travel and per diem	<u>\$2,400</u>
	Total	\$5,762
Swamp of Toa, Alabama	Eight weeks of staff time	\$4,882
	Travel and per diem	<u>\$2,000</u>
	Total	\$6,882

Table 7-6. Costs for Wetlands Protection Programs*

State	Staffing	Budget
Montana	One FTE	\$100,000
South Carolina	Three part-time positions	\$80,000
Alaska	Four FTEs	\$400,000
Tennessee	Eleven FTEs (Field, clerical, and administrative)	\$450,000
Oregon	Fifteen FTEs Five seasonal positions	\$300,000
New Hampshire	Fifteen FTEs Five seasonal positions	\$500,000

*All levels of staffing and budgeting were reported by States in response to a questionnaire distributed by the Association of State Wetlands Managers (ASWM).

equivalents (FTEs) and the task-specific dedication of discrete levels of clerical and administrative support. A low-level scenario consists of costs for one FTE. A high-level scenario consists of staffing of 10 or more FTEs, including clerical and administrative positions.

If the costs for individual FTEs are estimated at \$50,000 each, which includes salary plus fringe benefits, then some of the reported program budgets on the list mentioned above exceed reasonable estimates of salaries. This indicates that additional funding has been allocated for activities ranging from office support to technical assistance in the field.

c. Pretreatment

The use of appropriate pretreatment practices to prevent adverse impacts to wetlands that ultimately affect NPS pollution abatement involves the *design and installation of vegetated treatment systems* such as vegetated filter strips or constructed wetlands, or the use of structures such as detention or retention basins. These types of systems are discussed individually elsewhere in this guidance document. Refer to Chapter 4 for a discussion of detention and retention basins. See the discussion of Management Measure C later in Chapter 7 for a description of constructed wetlands and filter strips. The purpose of each of these BMPs is to remove, to the extent practicable, excessive levels of NPS pollutants and to minimize impacts of hydrologic changes. Each of these BMPs can function to reduce levels of pollutants in runoff or to attenuate runoff volume before it enters a natural wetland or riparian area.

Whether these BMPs are used individually or in series will depend on several factors, including the quantity and quality of the inflowing runoff, the characteristics of the existing hydrology, and the physical limitations of the area surrounding the wetland or riparian area to be protected.

Costs are reported below for three potential scenarios to implement practice "d" under this management measure.

- (1) One filter strip at a cost of \$129.00
 - Includes design and installation of a grass filter strip 1,000 feet long and 66 feet wide.
 - Most effective at trapping sediments and removing phosphorus from surface water runoff.
- (2) One constructed wetland at a cost of \$5,000.00

- Includes design and installation of a constructed wetland whose surface area is 0.25 acre in size. The constructed wetland is planted with commercially available emergent vegetation.
 - Most effective to remove nutrients and decrease the rate of inflow of surface water runoff into the natural wetland located further downstream.
- (3) One combined filter strip/constructed wetland \$5,129.00

B. Management Measure for Restoration of Wetland and Riparian Areas

Promote the restoration of the preexisting functions in damaged and destroyed wetlands and riparian systems in areas where the systems will serve a significant NPS pollution abatement function.

1. Applicability

This management measure is intended to be applied by States to restore the full range of wetlands and riparian functions in areas where the systems have been degraded and destroyed and where they can serve a significant NPS abatement function. Under the Coastal Zone Act Reauthorization Amendments of 1990, States are subject to a number of requirements as they develop coastal NPS programs in conformity with this management measure and will have flexibility in doing so. The application of management measures by States is described more fully in *Coastal Nonpoint Pollution Control Program: Program Development and Approval Guidance*, published jointly by the U.S. Environmental Protection Agency (EPA) and the National Oceanic and Atmospheric Administration (NOAA) of the U.S. Department of Commerce.

2. Description

Restoration of wetlands and riparian areas refers to the recovery of a range of functions that existed previously by reestablishing the hydrology, vegetation, and structure characteristics. A restoration management measure should be used in conjunction with other measures addressing the adjacent land use activities and, in some cases, water activities as well.

The term *NPS pollution abatement function* refers to the ability of a wetland or riparian area to remove NPS pollutants from waters passing through the wetland or riparian area. Acting as a sink for phosphorus and converting nitrate to nitrogen gas through denitrification are two examples of the important NPS pollution abatement functions performed by wetlands and riparian areas.

Restoration of wetlands and riparian areas is a holistic approach to water quality that addresses NPS problems while meeting the goals of the Clean Water Act to protect and restore the chemical, physical, and biological integrity of the Nation's waters. Full restoration of complex wetland and riparian functions may be difficult and expensive, depending on site conditions, the complexity of the system to be restored, the availability of native plants, and other factors. Specific practices for restoration must be tailored to the specific ecosystem type and site conditions.

3. Management Measure Selection

Selection of this management measure was based on:

- (1) The localized increase in pollutant loadings that can result from the degradation of wetlands and riparian areas (Reinelt and Horner, 1990; Richardson, 1988);
- (2) The nonpoint pollution abatement function of wetlands and riparian areas (Cooper, 1990; Cooper and Gilliam, 1987; Jacobs and Gilliam, 1985; James et al., 1990; Karr and Gorman, 1975; Lowrance et al.,

1983; Lowrance et al., 1984; Peterjohn and Correll, 1984; Pinay and Decamps, 1988; Stuart and Greis, 1991); and

- (3) The opportunity to gain multiple benefits through the restoration of wetland and riparian area systems, e.g., aquatic and riparian habitat functions for wildlife and NPS pollution reduction benefits (Atcheson et al., 1979; Mitsch and Gosselink, 1986).

Refer to Section II.A.3 of this chapter for additional information regarding the degradation, effectiveness, and multiple benefits of wetlands and riparian areas.

4. Practices

As discussed more fully at the beginning of this chapter and in Chapter 1, the following practices are described for illustrative purposes only. State programs need not require implementation of these practices. However, as a practical matter, EPA anticipates that the management measure set forth above generally will be implemented by applying one or more management practices appropriate to the source, location, and climate. The practices set forth below have been found by EPA to be representative of the types of practices that can be applied successfully to achieve the management measure described above.

- a.** *Provide a hydrologic regime similar to that of the type of wetland or riparian area being restored.*

The following list identifies some important information or considerations to address in a restoration project.

- Site history - Know the past uses of the site, including past functioning as a wetland.
- Topography - Map the surface topography, including slope and relief of the existing land surface, and elevations of levees, drainage channels, ponds, and islands.
- Tide - Determine the mean and maximum tidal range.
- Existing water control structures - Identify the location of culverts, tide gates, pumps, and outlets.
- Hydrology - Investigate the hydrologic conditions affecting the site: wave climate, currents, overland flows, ground-water dynamics, and flood events.
- Sediment budgets - Understand the rates and paths of sediment inflow, outflow, and retention.
- Soil - Describe the existing soils, including their suitability for supporting wetland plants.
- Plants - Identify the existing and, if different, native vegetation.
- Salinity - Measure the existing or planned salt level at the site.
- Consider the timing of the restoration project and the duration of the construction schedule for installation activities.
- Assess potential impacts to the site from adjacent human activities.

Restoration of hydrology, in particular, is a critical factor to gain NPS benefits and to increase the probability of successful restoration.

■ *b. Restore native plant species through either natural succession or selected planting.*

When consistent with preexisting wetland or riparian area type, plant a diversity of plant types or manage natural succession of diverse plant types rather than planting monocultures. Deeply rooted plants may work better than certain grasses for transforming nitrogen because the roots will reach the water moving below the surface of the soil. For forested systems, a simple approach to successional restoration would be to plant one native tree species, one shrub species, and one ground-cover species and then allow natural succession to add a diversity of native species over time, where appropriate and warranted by target community composition and anticipated successional development. Information on native plant species is available from Federal agencies (e.g., USDA-SCS or USDO-I-FWS), or various State or local agencies, such as the local Cooperative Extension Service Office or State departments of agriculture or natural resources. Other factors listed below need to be considered in the implementation of this practice.

Type and Quantity of Pollutant. Sediment, nitrates, phosphates, and thermal pollutants are effectively reduced by riparian areas. Riparian forests can also effectively remove nitrates from ground water. Eroded materials and attached pollutants from upslope areas are trapped on the surface. Suspended sediments and attached pollutants are removed during inundation by floodwaters (Table 7-1).

Slope. Riparian forest water quality functions have primarily been studied on cropland watersheds where slope has not been a factor. While sheet flow is not required for effective removal of NPS pollution from runoff passing through a riparian area, concentrated flows must be dispersed before upland runoff enters the riparian area.

Vegetated Area. Nonleguminous hardwoods are the most effective vegetation for nitrate removal. Where shade is critical, taller conifers may be preferred. The vegetation should be managed to retain larger trees near streams and denser, more vigorous trees on the remainder of the area. Research has also shown that a naturally rough forest floor is effective in trapping sediment (Swift, 1986).

■ *c. Plan restoration as part of naturally occurring aquatic ecosystems.*

States should factor in ecological principles when selecting sites and designing restoration. For example, seek high aquatic and riparian habitat diversity and high productivity in the river/wetland systems; look for opportunities to maximize connectedness (between different aquatic and riparian habitat types); and provide refuge or migration corridors along rivers between larger patches of uplands (animals are most likely to colonize new areas if they can move upstream and downstream under cover).

Planning to restore wetlands includes:

- Identifying sources of NPS problems;
- Considering the role of site restoration within a broader context, such as on a landscape basis;
- Setting goals for the restoration project based on location and type of NPS problem;
- Replicating multiple functions while still gaining NPS benefits; and
- Locating historic accounts (e.g., maps, descriptions, photographs) to identify sites that were previously wetland or riparian areas. These sites are likely to be more suitable for restoration if the original hydrology has not been permanently altered.

A few examples of wetland restoration are shown in Table 7-7.

Table 7-7. Review of Wetland Restoration Projects

No.	Location	Type of Wetland	Summary of Observations	Source
1	The Kattegat, Swedish west coast	Wetlands restoration Vegetation type not specified	<p>The Kattegat, a semienclosed, shallow, and strongly stratified sea area, has experienced increased effects of eutrophication caused by excessive nitrogen loading. Based on a nitrogen retention model and denitrification studies, the following hypotheses will be tested in the wetland restoration program:</p> <ul style="list-style-type: none"> • Annual nitrogen retention depends on nitrogen load. • A decrease in the active surface of a wetland causes an increase in the nitrogen load and retention per unit area. • Hydrological loading of a wetland can only be increased to a certain "critical" level. • Nitrogen retention is stabilized as a result of newly established plant communities and sediment formation. • When nitrogen retention is high, denitrification and sedimentation are the predominating mechanisms. • During the winter, high nitrogen load may counteract low-temperature-limited denitrification. • If nitrogen transport in a stream is known, retention in a future restored wetland can be predicted. <p>This 5-year wetland restoration study was just getting under way in 1991.</p>	Fleischer, S., L. Stibe, and L. Leonardson. 1991. Restoration of Wetlands as a Means of Reducing Nitrogen Transport to Coastal Waters. <i>Ambio: A Journal of the Human Environment</i> , 20(6):271-272.
2	Ballona Channel Wetlands, Marina Del Rey, Los Angeles, California	Wetlands restoration Vegetation type not specified	<p>This paper discusses the model used to plan stormwater detention for site development, and at the same time to allow wetland restoration. Flood control, restoration of wetland habitat values, and quality control of urban stormwater runoff were some objectives of the project. This paper discusses only the model used to engineer the plan.</p>	Tsihrintzis, V.A., G. Vasarhelyi, W. Trott, and J. Lipa. 1990. Stormwater Management and Wetland Restoration: Ballona Channel Wetlands. In <i>Hydraulic Engineering: Volume 2, Proceedings of the 1990 National Conference</i> , pp. 1122-1127.

Table 7-7. (Continued)

No.	Location	Type of Wetland	Summary of Observations	Source																																																									
3	Banana Lake headwater system, Lakeland, Florida	Restored headwaters (including hardwood and herbaceous wetlands)	<p>As compensation for roadway environmental impacts from the development of a belt loop around Lakeland, Florida, the restoration of Banana Lake was initiated in 1983. Development of the project was undertaken by the Polk County Engineering and Water Resources Division, the Florida Department of Transportation, and the City of Lakeland. Objectives of the restoration project include:</p> <ul style="list-style-type: none"> • Improvement of surface water quality; • Elimination of localized flooding and dangerous roadside ditches; • Restoration of hardwood wetland swamp system; • Restoration of the premining drainage and functions of the headwater system. <p>Postrestoration differences are summarized:</p> <ul style="list-style-type: none"> • Western basin (average water quality): <ul style="list-style-type: none"> - All data in mg/L unless otherwise noted. - BDL=Below detection limits. <table border="1"> <thead> <tr> <th>Parameter</th> <th>Change after restoration</th> </tr> </thead> <tbody> <tr> <td>Temperature-°C</td> <td>-0.9</td> </tr> <tr> <td>pH-units</td> <td>+0.3</td> </tr> <tr> <td>DO</td> <td>+1.1</td> </tr> <tr> <td>Specific conductance (umhos/cm)</td> <td>-54</td> </tr> <tr> <td>Nitrate-Nitrate as N</td> <td>to BDL</td> </tr> <tr> <td>N, Ammonia</td> <td>to BDL</td> </tr> <tr> <td>N, Total Kjeldahl</td> <td>-2.98</td> </tr> <tr> <td>N, Total</td> <td>-3.03</td> </tr> <tr> <td>Orthophosphate as P</td> <td>-0.974</td> </tr> <tr> <td>Phosphorus, Total</td> <td>-0.869</td> </tr> </tbody> </table> <p>Restoration of the western basin was completed in 1985. The following data compare the restored western basin water quality to the existing (1989) water quality in the unrestored eastern ditch.</p> <ul style="list-style-type: none"> • Roadside ditch quality - Lakeland Highlands Rd.: <table border="1"> <thead> <tr> <th rowspan="2">Parameter</th> <th>Western Basin</th> <th>Eastern Basin</th> </tr> <tr> <th>(Restored)</th> <th>(Unrestored)</th> </tr> </thead> <tbody> <tr> <td>Temperature (°C)</td> <td>25.3</td> <td>22.7</td> </tr> <tr> <td>pH-units</td> <td>7.1</td> <td>7.1</td> </tr> <tr> <td>DO</td> <td>7.2</td> <td>7.0</td> </tr> <tr> <td>Specific conductance (umhos/cm)</td> <td>217</td> <td>221</td> </tr> <tr> <td>Nitrate-Nitrate as N</td> <td>BDL</td> <td>0.016</td> </tr> <tr> <td>N, Ammonia</td> <td>BDL</td> <td>0.145</td> </tr> <tr> <td>N, Total Kjeldahl</td> <td>1.03</td> <td>1.48</td> </tr> <tr> <td>N, Total</td> <td>1.03</td> <td>1.58</td> </tr> <tr> <td>Orthophosphate as P</td> <td>0.233</td> <td>0.525</td> </tr> <tr> <td>Phosphorus, Total</td> <td>0.571</td> <td>1.514</td> </tr> </tbody> </table>	Parameter	Change after restoration	Temperature-°C	-0.9	pH-units	+0.3	DO	+1.1	Specific conductance (umhos/cm)	-54	Nitrate-Nitrate as N	to BDL	N, Ammonia	to BDL	N, Total Kjeldahl	-2.98	N, Total	-3.03	Orthophosphate as P	-0.974	Phosphorus, Total	-0.869	Parameter	Western Basin	Eastern Basin	(Restored)	(Unrestored)	Temperature (°C)	25.3	22.7	pH-units	7.1	7.1	DO	7.2	7.0	Specific conductance (umhos/cm)	217	221	Nitrate-Nitrate as N	BDL	0.016	N, Ammonia	BDL	0.145	N, Total Kjeldahl	1.03	1.48	N, Total	1.03	1.58	Orthophosphate as P	0.233	0.525	Phosphorus, Total	0.571	1.514	<p>Powers, R.M., and J.F. Spence. 1989. Headwater Restoration: The Key Is Integrated Project Goals. In <i>Proceedings of the Symposium on Wetlands: Concerns and Successes, Sept. 17-22, Tampa, Florida</i>, pp. 269-279</p>
Parameter	Change after restoration																																																												
Temperature-°C	-0.9																																																												
pH-units	+0.3																																																												
DO	+1.1																																																												
Specific conductance (umhos/cm)	-54																																																												
Nitrate-Nitrate as N	to BDL																																																												
N, Ammonia	to BDL																																																												
N, Total Kjeldahl	-2.98																																																												
N, Total	-3.03																																																												
Orthophosphate as P	-0.974																																																												
Phosphorus, Total	-0.869																																																												
Parameter	Western Basin	Eastern Basin																																																											
	(Restored)	(Unrestored)																																																											
Temperature (°C)	25.3	22.7																																																											
pH-units	7.1	7.1																																																											
DO	7.2	7.0																																																											
Specific conductance (umhos/cm)	217	221																																																											
Nitrate-Nitrate as N	BDL	0.016																																																											
N, Ammonia	BDL	0.145																																																											
N, Total Kjeldahl	1.03	1.48																																																											
N, Total	1.03	1.58																																																											
Orthophosphate as P	0.233	0.525																																																											
Phosphorus, Total	0.571	1.514																																																											

Table 7-7. (Continued)

No.	Location	Type of Wetland	Summary of Observations	Source
4	Creekside Park, Marin County, California	Wetland restoration; Cordgrass and pickleweed planting	<p>In 1972, the U.S. Army Corps of Engineers placed dredged spoils on the Creekside Park site in conjunction with the dredging of Corte Madera Creek. As a result of citizen pressure, a report on the feasibility of creating a salt marsh was prepared in 1973. In 1975, the site was acquired and a committee of local citizens initiated a park plan.</p> <ul style="list-style-type: none"> • In 1975, the Corps of Engineers issued a permit for a small marsh plant nursery area to provide some initial experience in transplanting cordgrass and pickleweed within the future marsh area. The permit to excavate for the entire marsh restoration project was issued in 1976. • The site plan included removing spoil for channels, grading upland areas for marsh plant colonization, depositing excess material to create islands and upland areas, and creation of public access. • After the first marsh plantings failed to germinate in 1977, a second attempt was made using a number of different species of cordgrass including seeds from Humboldt Bay and <i>Spartina marina</i> from England. • No records were kept of success or establishment of marsh plants. However, in 1979, Royston, Hanamoto, Beck and Abbey, the landscape architect responsible for the project, was given an Award of Excellence by the American Society of Landscape Architects for the restoration plan. 	Josselyn, M., and J. Buchholz. 1984. <i>Marsh Restoration in San Francisco Bay: A Guide to Design & Planning</i> . Technical Report #3. Tiburon Center for Environmental Studies, San Francisco State University. 104 pp.
5	Coyote Creek and Anza-Borrego Desert State Park, San Diego County, California	Riparian/creek restoration	<p>Until March 1988, all vehicles were allowed to travel on the 29-kilometer route of Coyote Canyon, including the riverine routes. The jeep trail passed through the three most significant riparian forests of Coyote Creek and by the early 1980s the impacts of approximately 1000 vehicles on the riparian system during busy weekends became too great. An annual seasonal closure of the entire Coyote Canyon watershed to all persons and vehicles was enacted. A bypass route now provides permanent protection to one of the three riparian sections. A ban on all vehicles that are not street legal, including dirt bikes, all-terrain cycles, and many dune buggies, has caused the traffic corridors to become filled in with thick stands of willow and tamarisk, which provide additional avian habitat.</p>	USDA, Forest Service. 1989. <i>Proceedings of the California Riparian Systems Conference, September 22-24, 1988, Davis, California</i> , pp. 149-152.

Table 7-7. (Continued)

No.	Location	Type of Wetland	Summary of Observations	Source
6	Unknown	Wetland	<p>This paper presents economically efficient policy reforms of national wetlands programs that result in enhanced maintenance of wetland stocks and accommodation of development pressures. The authors' suggestions include a fixed wetlands development fee for developers building in unprotected areas. These development tax revenues then would be used to finance a nationwide investment program to aid the replacement and management of wetlands created to offset losses to development. Alternatively, developers may choose to implement their own mitigation plans. According to the authors, this approach would offer more assurance that coastal wetlands damage will be compensated. Included in this paper are tables of summaries of costs for the following conditions:</p> <ul style="list-style-type: none"> • Wetland creation with dredged material from maintenance of navigation projects; • Wetland creation with proposed 25,000- cfs controlled sediment diversions; and • Wetland creation with uncontrolled sediment diversions. 	<p>Shabman, L.A., and S.S. Batie. 1987. <i>Mitigating Damages from Coastal Wetlands Development: Policy, Economics and Financing. Marine Resource Economics</i>, 4:227-248.</p>
7	Amana Society Farm, eastern Iowa	Poplar tree buffer strips in riparian zones	<p>This study outlines 2 years of study of Iowa's riparian corridors by the Leopold Center. <i>Populus</i> spp. (poplar) were planted in buffer strips along creeks to produce a productive crop and a more stable riparian zone ecosystem. Planting techniques were developed so that roots grew deep enough to intercept the surficial water and dense enough to uptake most available nitrogen before it leached into the stream. During the two growing seasons, the deep-rooted poplar removed soil nitrate and ammonia nitrogen from soil water well below Maximum Contaminant Limits.</p> <p>Tables or graphs for the following data can be found in the paper:</p> <ul style="list-style-type: none"> • Tree survival and stem and leaf growth; • Total Kjeldahl Nitrogen concentrations; • Nitrate nitrogen concentrations; • Ammonia nitrogen concentrations; and • Total organic carbon concentrations. 	<p>Licht, L.A., and J.L. Schnoor. 1990. <i>Poplar Tree Buffer Strips Grown in Riparian Zones for Non-point Source Pollution Control and Biomass Production</i>. Leopold Center for Sustainable Agriculture.</p>

Table 7-7. (Continued)

No.	Location	Type of Wetland	Summary of Observations	Source
8	Sweetwater River Wetlands Complex, San Diego Bay, California	Construction and enhancement of salt marsh	<p>Mitigation for lost wetland habitat is being carried out by the California Department of Transportation. The mitigation marshes include the Connector Marsh, which is a hydrologic link between Paradise Creek and the Sweetwater Marsh, and Marisma de Nacion, a 17-acre marsh excavated from the "D Street fill" in 1990. The assessment study thus far has found that:</p> <ul style="list-style-type: none"> • Concentrations of free sulfide were greater in the natural marsh compared to only trace amounts in the constructed marsh. • Nitrogen fixation rates were generally twice as high in the natural salt marsh than in the man-made salt marsh. • There were two to four times more individuals in a natural marsh at San Diego Bay than in the 4-year-old man-made marsh. Abundance of species was up to nine times greater in the natural marsh. These samplings were taken at low marsh elevations. At elevations of 0.5 m above mean sea level, the numbers of species and individuals were similar for areas with high cover. • The preliminary conclusion was that the USFWS criteria for fish species and abundance have been met by the constructed marsh. • An overall comparison indicated that the constructed marsh was less than 60% functionally equivalent to the natural reference wetland (Paradise Creek Marsh) when comparing water quality, plant biomass, and number of species and individuals. • The report contains detailed tables that provide the following quantitative data: <ul style="list-style-type: none"> - Pore water concentrations of free sulfides; - Rates of nitrogen fixation; - Total nitrogen and phosphorus in sediment core samples; - Biomass of cordgrass; - Ammonium levels of pore water samples; - Mean number of individuals per litterbag; - Mean number of species per litterbag; - Number of channel invertebrates found at sampling stations; and - Sightings of water-associated birds. 	Pacific Estuarine Research Laboratory. 1990. <i>A Manual for Assessing Restored and Natural Coastal Wetlands with Examples from Southern California</i> . California Sea Grant, La Jolla, California, pp. 19-34.

Table 7-7. (Continued)

No.	Location	Type of Wetland	Summary of Observations	Source
9	Connecticut	Created and natural wetlands	<p>This report compares five 3- to 4-year-old created wetland sites with five nearby natural wetlands of comparable size. Hydrologic, soil, and vegetation data were compiled over a 2-year period (1988-89). Results indicated that:</p> <ul style="list-style-type: none"> • Only one created site appeared to mimic the hydrology of a natural wetland because of its connection to a natural water source. • Typical wetland soils exhibiting mottling and organic accumulation were lacking in created sites. • Plant cover was higher in the natural sites because of their greater maturity. • The created sites exhibited a slightly higher number of species. This species richness can be attributed to the rapid rate of species establishment on mineral soil substrates. The small sample size also may have contributed to the high number of species in the created site. Egler's Initial Floristic Composition concept, a model of vegetation development, also explains the difference in species numbers. This model assumes a large number of species early in the development process, which may decrease over time as a result of interspecific competition. • Based on observations of bird species diversity and muskrat activity, creation of comparable wildlife habitat was achieved at more than one created site. <p>The authors concluded that the presence of invasive species threatens the future of the created wetlands.</p>	<p>Confer, S., and W.A. Niering. Undated. Comparison of Created Freshwater and Natural Emergent Wetlands in Connecticut. Submitted to <i>Wetland Ecology and Management</i>.</p>
10	Wyoming	Riparian zones	<p>Along a degraded cold desert stream in Wyoming, instream flow structures (trash collectors), willow, and beaver are being used to reclaim riparian habitat. Trash collectors are intended to decrease streamflow velocity, causing sediment to be deposited as channel bed material. Willows will be used to stabilize new channel bank deposition. Preliminary results have shown that:</p> <ul style="list-style-type: none"> • Trash collectors have survived 1 1/2 years and are trapping sediment. • Channel bed material is rising. • Beaver are using trash collectors as support for dams. • Willow plantings have survived 2 years. 	<p>Skinner, Q.D., M.A. Smith, J.L. Dodd, and J.D. Rodgers. Undated. <i>Reversing Desertification of Riparian Zones Along Cold Desert Streams</i>. pp. 1407-1414.</p>

Table 7-7. (Continued)

No.	Location	Type of Wetland	Summary of Observations	Source
11	California	Riparian	Severe storms of 1978 through 1983 caused considerable damage to streams in California. The Soil Conservation Service used several mechanical and revegetation techniques to stabilize streambanks and reestablish riparian vegetation. Results of evaluations of 29 projects are discussed, and recommendations are made to improve success.	Shultze, R.F., and G.I. Wilcox. 1985. Emergency Measures for Streambank Stabilization: An Evaluation. In <i>Riparian Ecosystems and Their Management: Reconciling Conflicting Issues</i> . USDA Forest Service GTR RM-120, pp. 54-58.
12	Rio Grande River, New Mexico	Riparian	Riparian areas continue to be drastically altered, usually by human activities. Managers have generally been unsuccessful in using conventional techniques to replace riparian trees. Experiments with Rio Grande cottonwood, narrowleaf cottonwood, and Gooding willow have shown that a simple and inexpensive method for their reestablishment is now available (i.e., placing large, dormant cuttings into holes predrilled to known depth of the growing season water table).	Swenson, E.A., and C.L. Mullins. 1985. Revegetating Riparian Trees in Southwestern Floodplains. In <i>Riparian Ecosystems and Their Management: Reconciling Conflicting Issues</i> . USDA Forest Service GTR RM-120, pp. 135-138.
13	Savannah River, South Carolina	Wetland	Principal factors that affect seedling recruitment in mature cypress-tupelo forests include seed production, microsite availability, and hydrologic regime. Studies on the Savannah River floodplain in South Carolina show that although seed production seems adequate, microsite characteristics and water level changes limit regeneration success. Management of water levels on regulated streams must account for species regeneration requirements to maintain floodplain wetland community structure.	Sharitz, R.R., and L.C. Lee. 1985. Limits on regeneration processes in southeastern riverine wetlands. In <i>Riparian Ecosystems and Their Management: Reconciling Conflicting Issues</i> . USDA Forest Service GTR RM-120, pp. 139-143.
14	Niger, West Africa	Riparian	A reforestation project in the Majjia Valley, Niger, was undertaken to improve the microclimate, to reduce water and wind erosion, and to produce fuel wood. Windbreaks were planted, wood lots were established, and trees were distributed to the inhabitants. The windbreaks were effective in reducing wind velocities and, at times, retained soil moisture. Water consumption by vegetation in the windbreaks did not affect soil moisture in the agricultural crop rooting zone. Although fuel wood has not been harvested, agricultural crop yields in the windbreaks were 125% of those in the control.	Ffolliott, P.F., and R.L. Jemison. 1985. Land use in Majjia Valley, Niger, West Africa. In <i>Riparian Ecosystems and Their Management: Reconciling Conflicting Issues</i> . USDA Forest Service GTR RM-120, pp. 470-474.

5. Costs for All Practices

This section describes costs for representative activities that would be undertaken in support of one or more of the practices listed under this management measure. The description of the costs is grouped into the following two categories:

- (1) A wetlands/riparian restoration project involving a low level of effort.

The items of work would include (a) clearing the site of fallen trees and debris; (b) application of seed stock or sprigging of nursery-reared plants; (c) application of fertilizer (most typically for marsh restoration); and (d) a minimal amount of postproject maintenance until the vegetation becomes established.

A low level of effort could also include minor adjustments to the existing hydrology, such as the installation of stop-logs to raise water levels, or improvements to the existing drainage patterns undertaken to lower water levels (e.g., pulling the plug on tile fields).

- (2) A wetlands/riparian restoration project involving a high level of effort.

The items of work would include (a) clearing the site of fallen trees and debris; (b) extensive site work requiring heavy construction equipment; (c) application of seed stock or sprigging of nursery-reared plants; (d) application of fertilizer (most typically for marsh restoration); and (e) postproject maintenance and monitoring.

A high level of effort is distinguished from a low level by the amount of site work required. A high level of effort typically will require heavy construction machinery, including graders, bulldozers, and/or dump trucks. These pieces of equipment will be used to accomplish several tasks, such as:

- Adding additional fill material to the site or removing excessive amounts of on-site material;
- Realigning the existing on-site substrate to appropriate lines and grades as shown on the design plan; and
- Realigning existing channels or constructing new channels, diversions, basins, or tidal flats as necessary to restore preexisting surface water flow characteristics.

In addition to the need for heavy construction equipment to perform the work, a restoration project involving a high level of effort typically requires more extensive analysis and evaluation of the site before work is started. Site surveys and preparation of formal design drawings and specifications are frequently necessary prior to starting the work. Periodic site visits are needed to inspect the work in progress. Spot surveys are frequently necessary to check the lines and grades of new channels and wetlands planting areas as they are being formed with the heavy construction machinery. Finally, a high-level restoration frequently requires postproject monitoring and adjustment as water begins to flow through the recreated surface water systems in the restored wetland.

The costs for items of work associated with either a low level or a high level of effort are reported below from actual examples of recent projects involving wetlands and riparian area restoration. The cases cited are representative of the levels of effort that could be undertaken in support of the practices under Management Measure II.B.

Each of the following examples contains a description of costs as they are reported in the source document. For ease of comparison, these costs are converted to 1990 dollars, using conversion factors published in the *Engineering News-Record*. A full explanation of the conversion factors is contained in Table 7-8.

**Table 7-8. Construction Cost Index
(Grogan, 1991)**

Year	Annual Average	Year	Annual Average
1975	2212	1984	4146
1976	2401	1985	4195
1977	2576	1986	4295
1978	2776	1987	4406
1979	3003	1988	4519
1980	3237	1989	4606
1981	3535	1990	4732
1982	3825	1991	4775
1983	4066	1992	4946

Note: *Engineering News Record (ENR)* builds the index as follows:

200 hours of common labor at the 20-city average of common labor rates, plus 25 cwt of standard structural steel shapes at the mill price, plus 22.56 cwt (1.128 tons) portland cement at the 20-city price, plus 1,088 board-feet of 2X4 lumber at the 20-city price.

Example: To compute a construction cost increase from 1985 to 1990

(a) Divide 1990 index by 1985 index: $4732/4195 = 1.128$

(b) Multiply 1985 cost by ratio: $1985 \text{ cost} \times 1.128 = 1990 \text{ cost}$.

a. Costs for "Low-Level" Restoration Projects

The two sources of wetland and riparian plants that should be used in restoration projects are seed and nursery-reared plant stock. Transplantation of wetland plant materials from other natural ecosystems is not recommended, but transplantation of young trees and shrubs growing in upland areas for riparian area restoration is acceptable, provided no other suitable source of plant stock is available. Transplantation of wetland plants is not recommended because digging up existing wetlands for removal of plant material can cause serious disturbance and dislocation of healthy systems. In addition, pests, disease, and contaminants can be carried along with the transplants and introduced into the area undergoing restoration. For this reason, even though it is possible to locate citations in the literature for transplantation costs, they are not included in the list below.

- (1) Costs for a 1982 tidal wetlands project in Chesapeake Bay, Maryland, included seeding and fertilizing salt marsh cordgrass at \$204.85 per acre (Earhart and Garbisch, 1983).

Cost in 1990 dollars \$253.42/acre

- (2) Costs reported in 1979 for tidal wetlands restoration in coastal California included seeding and fertilizing salt marsh cordgrass at \$300 to \$500 per acre (Jerome, 1979).
- Cost in 1990 dollars \$470 to 780/acre
- (3) Costs reported in 1992 for nontidal wetlands included purchasing and installing nursery-reared plant stock (emergents) at \$2,024 to \$2,429 per acre (Hammer, 1992).
- Cost in 1990 dollars \$1,936 to 2,323/acre
- (4) Costs reported in 1989 for bottomland forest restoration using direct seeding were \$40 to \$60 per acre (National Research Council, 1991).
- Cost in 1990 dollars \$41.20 to \$61.80/acre
- (5) Costs reported in 1990 for nursery-reared tree seedlings were \$212.50 per acre (Illinois Department of Conservation, 1990).
- Cost in 1990 dollars \$212.50/acre

As this cost information indicates, nursery-reared plant materials used in nontidal wetland restoration projects are generally more expensive than plants used in restoration of tidal wetlands. This difference seems to be partly due to the greater ease with which tidal wetland plants can be grown in nurseries in sufficient quantities for commercial distribution.

The "law of supply and demand" is another factor influencing the price of these two types of items. Mitigation requirements for tidal wetlands have been imposed in many coastal regions of the United States since the mid-1970s, and the commercial market has responded by developing the methods to produce adequate quantities of nursery stock available at the appropriate planting seasons to meet the demand. The requirements for mitigation of nontidal wetlands have only more recently been enforced. Thus, in certain geographic areas of the United States, the demand for these kinds of plant materials from nurseries probably exceeds the supply, resulting in higher unit costs.

Two other factors that influence the costs of seed or plant stock are (1) using exotic or hybrid varieties or introduced species and (2) purchasing plant stock from properly certified and inspected nurseries. When considering the use of seeds or nursery stock for restoration projects, it is best to consider only strong, nonexotic strains of plant materials. Many nurseries carry exotic strains of common species, introduced species, or hybrid varieties. These types of plant stock are intended for use in the home watergarden or in landscaping projects. Always check the genus and species of the plants found in the natural wetland and riparian systems in the locality and insist on purchasing these same varieties from the nursery. In addition, several States have inspection and certification programs for nursery-reared plant stock. For example, the State of Maryland's Department of Agriculture publishes a *Directory of Certified Nurseries, Licensed Plant Dealers, Licensed Plant Brokers* (Maryland Department of Agriculture, 1990). Likewise, the Association of Florida Native Nurseries (AFNN) publishes an annual *Plant and Service Locator* (AFNN, 1989). In these cases, plants should always be obtained from properly inspected and certified dealers. In some regions of the United States, more stringent rules and regulations apply to plant stock purchased for transport across State lines. Such laws exist in part to minimize the potential for the spread of pests and disease and should be strictly adhered to.

Obtaining strains of plant material identical to those occurring in natural ecosystems, through properly certified and inspected plant dealers, frequently results in a slightly higher product cost. However, increased benefits in environmental protection and project performance will generally justify paying the slightly higher price.

b. Costs for "High-Level" Restoration Projects

Costs for projects involving extensive site work will vary widely based on several factors, including (1) the extent and complexity of the work shown on the design drawing, (2) the local availability of construction equipment, and (3) the degree of difficulty involved in gaining access to the site. In addition, as the examples of restoration projects listed below illustrate, overall project costs can be considerably increased if the land containing the proposed restoration project must be purchased before any work is undertaken.

In compiling the restoration costs for the examples listed below, the reported costs for riparian work were frequently presented in units of linear feet of streambank. For ease of comparison with the other examples, these costs were converted to dollars per acre by assigning a width along the streambank within which work is assumed to have taken place.

- (1) Costs reported for the 1980 restoration of diked tidelands at the Elk River in Humboldt Bay, California, ranged from \$5,000 to \$7,000 per acre. The items of work included breaching of dikes to restore preexisting hydrology, construction of new dikes at a lower elevation, installation of other drainage controls, and restoration of tidal wetland vegetation (Anderson and Rockel, 1991).

Cost in 1990 dollars \$7,300 to \$10,000/acre

- (2) Costs reported for the 1986 restoration of tidal wetlands at three California coastal sites averaged \$23,700 per acre. The sites included Big Canyon in Upper Newport Bay, Freshwater Slough, and Bracut (both in Humboldt Bay). Existing fill had to be removed from the sites before wetlands restoration could be accomplished (Anderson and Rockel, 1991).

Cost in 1990 dollars \$26,070/acre

- (3) Costs reported for restoration of riparian areas in Utah between 1985 and 1988 were used to compute an average cost of approximately \$2,527 per acre, assuming a streamside width of 100 feet for the work. The items of work included bank grading, installation of riprap and sediment traps in deep gullies, planting of juniper trees and willows, and fencing of the site (Nelson and Williams, 1989).

Cost in 1990 dollars \$2,527/acre

C. Management Measure for Vegetated Treatment Systems

Promote the use of engineered vegetated treatment systems such as constructed wetlands or vegetated filter strips where these systems will serve a significant NPS pollution abatement function.

1. Applicability

This management measure is intended to be applied by States in cases where engineered systems of wetlands or vegetated treatment systems can treat NPS pollution. Constructed wetlands and vegetated treatment systems often serve a significant NPS pollution abatement function. Under the Coastal Zone Act Reauthorization Amendments of 1990, States are subject to a number of requirements as they develop coastal NPS programs in conformity with this management measure and will have flexibility in doing so. The application of management measures by States is described more fully in *Coastal Nonpoint Pollution Control Program: Program Development and Approval Guidance*, published jointly by the U.S. Environmental Protection Agency (EPA) and the National Oceanic and Atmospheric Administration (NOAA) of the U.S. Department of Commerce.

2. Description

As discussed in Section I.E of this chapter, vegetated treatment systems (VTS), by definition in this guidance, include vegetated filter strips and constructed wetlands. Although these systems are distinctly different, both are designed to reduce NPS pollution. They need to be properly designed, correctly installed, and diligently maintained in order to function properly.

The term *NPS pollution abatement function* refers to the ability of VTS to remove NPS pollutants. Filtering sediment and sediment-borne nutrients and converting nitrate to nitrogen gas are examples of the important NPS pollution abatement functions performed by vegetated treatment systems.

a. Vegetated Filter Strips

The purpose of vegetated filter strips (VFS) is to remove sediment and other pollutants from runoff and wastewater by filtration, deposition, infiltration, adsorption, decomposition, and volatilization, thereby reducing the amount of pollution entering surface waters (USDA, 1988). Vegetated filter strips are appropriate for use in areas adjacent to surface water systems that may receive runoff containing sediment, suspended solids, and/or nutrient runoff. Vegetated filter strips can improve water quality by removing nutrients, sediment, suspended solids, and pesticides. However, VFS are most effective in the removal of sediment and other suspended solids.

Vegetated filter strips are designed to be used under conditions in which runoff passes over the vegetation in a uniform sheet flow. Such a flow is critical to the success of the filter strip. If runoff is allowed to concentrate or channelize, the vegetated filter strip is easily inundated and will not perform as it was designed to function.

Vegetated filter strips need the following elements to work properly: (1) a device such as a level spreader that ensures that runoff reaches the vegetated filter strip as a sheet flow (berms can be used for this purpose if they are placed at a perpendicular angle to the vegetated filter strip area to prevent concentrated flows); (2) a dense vegetative cover of erosion-resistant plant species; (3) a gentle slope of no more than 5 percent; and (4) a length at least as long as the adjacent contributing area (Schueler, 1987). If these requirements are met, VFS have been

shown to remove a high degree of particulate pollutants. The effectiveness of VFS at removing soluble pollutants is not well documented (Schueler, 1987).

b. Constructed Wetlands

Constructed wetlands are typically engineered complexes of saturated substrates, emergent and submergent vegetation, animal life, and water that simulate wetlands for human use and benefits (Hammer et al., 1989). According to Hammer and others (1989), constructed wetlands typically have four principal components that may assist in pollutant removal:

- (1) Substrates with various rates of hydraulic conductivity;
- (2) Plants adapted to water-saturated anaerobic substrates;
- (3) A water column (water flowing through or above the substrate); and
- (4) Aerobic and anaerobic microbial populations.

3. Management Measure Selection

This management measure was selected because vegetated treatment systems have been shown to be effective at NPS pollutant removal. The effectiveness of the two types of VTS is discussed in more detail in separate sections below.

a. Effectiveness of Vegetated Filter Strips

Several studies of VFS (Table 7-9) show that they improve water quality and can be an effective management practice for the control of nonpoint pollution from silvicultural, urban, construction, and agricultural sources of sediment, phosphorus, and pathogenic bacteria. The research results reported in Table 7-9 show that VFS are most effective at sediment removal, with rates generally greater than 70 percent. The published results on the effectiveness of VFS in nutrient removal are more variable, but nitrogen and phosphorus removal rates are typically greater than 50 percent. The following are nonpoint sources for which VFS may provide some nutrient-removal capability:

- (1) **Cropland.** The primary function of grass filter strips is to filter sediment from soil erosion and sediment-borne nutrients. However, filter strips should not be relied on as the sole or primary means of preventing nutrient movement from cropland (Lanier, 1990).
- (2) **Urban Development.** Vegetated filter strips filter and remove sediment, organic material, and trace metals. According to the Metropolitan Washington Council of Governments, VFS have a low to moderate ability to remove pollutants in urban runoff and have higher efficiency for removal of particulate pollutants than for removal of soluble pollutants (Schueler, 1987).

With proper planning and maintenance, VFS can be a beneficial part of a network of NPS pollution control measures for a particular site. They can help to reduce the polluting effects of agricultural runoff when coupled with either (1) farming practices that reduce nutrient inputs or minimize soil erosion or (2) detention ponds to collect runoff as it leaves a vegetated filter strip. Properly planned VFS can add to urban settings by framing small streams, ponds, or lakes, or by delineating impervious areas. In addition to serving as a pollution control measure, VFS can add positive improvements to the urban environment by increasing wildlife and adding beauty to an area.

b. Effectiveness of Constructed Wetlands

Constructed wetlands have been considered for use in urban and agricultural settings where some sort of engineered system is suitable for NPS pollution reduction.

A few studies have also been conducted to evaluate the effectiveness of artificial wetlands that were designed and constructed specifically to remove pollutants from surface water runoff (Table 7-10). Typical removal rates for

Table 7-9. Effectiveness of Vegetated Filter Strips for Pollutant Removal

Author	Study	VFS Length (m)	Vegetation	Sediment Removal (%)	Total Nitrogen Removal (%)	Total Phosphorus Removal (%)	Other Pollutant Removal (%)
Dillaha et al., 1988	simulated feedlot runoff	4.6	orchard grass	79	64	58	
		9.1		90	74	68	
Dillaha et al., 1989a	simulated cropland runoff	4.6	orchard grass	63	50	57	
		9.1		78	67	74	
Magette et al., 1989	simulated cropland runoff	4.6	orchard grass	72	17	41	
		9.1		86	72	53	
Young et al., 1980	simulated feedlot	35-41	corn	86	92	91	Total Coliform
			orchard grass	66	87	88	70
			sorghum	82	84	81	53
			oats	75	73	70	81
			average	79	84	83	70
						NA	
Dickey and Vanderholm, 1981	pumped effluent	91	mixed fescue/alfalfa foxtail	73	80/86 ^a	78	
		61		63	NA		
		152-457		78	71/72 ^a 89/85 ^a	NA	
Dickey and Vanderholm, 1981	pumped effluent	229	NA	39	50/41 ^a	NA	
		305		59	61/63 ^a	16	
		381		56	66/64 ^a	49	
		533		80	83/83 ^a	NA	
Schwer and Clausen, 1989	milkhouse runoff	26	fescue, ryegrass, bluegrass	89	76 ^b	78	
Overman and Schanze, 1985			Bermuda grass	81	67	39	

NA = not available.

^aTotal Kjeldahl Nitrogen/ammonia nitrogen.^bTotal Kjeldahl Nitrogen.

Table 7-10. Effectiveness of Constructed Wetlands for Treatment of Surface Water Runoff

Constituent	Lake Jackson (%)	Orange County (%)	Tampa Office (%)	MWTS (%)
Total Solids				
Suspended	94	83	63	90
Organic	96			89
Nitrogen				
Total	76	30	10	50
Ammonia	37	32	34	
Nitrate	70		75	56
Nitrite	75			
Organic (TKN)		34	-8	48
Phosphorus				
Total	90	37	54	55
Ortho	78	21	63	33
Metals				
Lead		81		75
Iron			33	
Nickel			21	

Sources: **Lake Jackson:** Touvila et al. 1987. *An evaluation of the Lake Jackson (Florida) Filter System and Artificial Marsh on Nutrient and Particulate Removal from Stormwater Runoff.*

Orange County: Martin and Smoot. Undated. *Tampa Office Wet Detention Stormwater Treatment.*

Tampa Office: Rushton and Dye 1990. *Water Quality Effectiveness of a Detention/Wetland Treatment System and Its Effect on an Urban Lake.*

MWTS: Oberts and Osgood 1991. *Constituent Load Changes in Urban Stormwater Runoff Routed Through a Detention Pond-Wetland System in Central Florida.*

Notes: **Lake Jackson:** Constructed wetland system located in Tallahassee, FL. Consists of a detention pond in series with a sand filter and constructed wetland. Analysis done in 1985.

Orange County: Wetland and detention pond system in Orlando, FL. Constructed in 1980.

Tampa Office: Constructed detention pond and wetland system located in Tampa, FL. Analysis done in 1989.

MWTS: Constructed detention pond and wetland system located in Roseville, MN. Consists of a detention pond in series with six wetland cells. Constructed and studied in 1986.

suspended solids were greater than 90 percent (Table 7-10). Removal rates for total phosphorus ranged from 50 percent to 90 percent. Nitrogen removal was highly variable and ranged from 10 percent to 76 percent for total nitrogen.

Like vegetated filter strips, constructed wetlands offer an alternative to other systems that are more structural in design for NPS pollution control. In some cases, constructed wetland systems can provide limited ecological benefits in addition to their NPS control functions. In other cases, constructed wetlands offer few, if any, additional ecological benefits, either because of the type of vegetation installed in the constructed wetland or because of the quantity and type of pollutants received in runoff. In fact, constructed wetlands that receive water containing large amounts of metals or pesticides should be fenced or otherwise barricaded to discourage wildlife use.

4. Practices

As discussed more fully at the beginning of this chapter and in Chapter 1, the following practices are described for illustrative purposes only. State programs need not require implementation of these practices. However, as a practical matter, EPA anticipates that the management measure set forth above generally will be implemented by

applying one or more management practices appropriate to the source, location, and climate. The practices set forth below have been found by EPA to be representative of the types of practices that can be applied successfully to achieve the management measure described above.

■ a. *Construct VFS in areas adjacent to waterbodies that may be subject to suspended solids and/or nutrient runoff.*

A survey of the literature on the design, performance, and effectiveness of VFS shows that the following factors need to be considered on a site-specific basis before designing and constructing a vegetated filter strip:

- (1) The effectiveness of VFS varies with topography, vegetative cover, implementation, and use with other management practices. In addition, different VFS characteristics such as size and type of vegetation can result in different pollutant loading characteristics, as well as loading reductions. Table 7-9 gives some removal rates for specific NPS pollutants based on VFS size and vegetation.
- (2) Several regional differences are important to note when considering the use of VFS. Climate plays an important role in the effectiveness of VFS. The amount and duration of rainfall, the seasonal differences in precipitation patterns, and the type of vegetation suitable for local climatic conditions are examples of regional variables that can affect the performance of VFS. Soil type and land use practices are also regional differences that will affect characteristics of surface water runoff and thus of VFS performance. The sites where published research has been conducted on VFS effectiveness for pollutant removal are overwhelmingly located in the eastern United States. There is a demonstrated need for more studies located in different geographic areas in order to better categorize the effects of regional differences on the effectiveness of VFS.
- (3) *Vegetated filter strips* have been successfully used in a variety of situations where some sort of BMP was needed to treat surface water runoff. Typical locations of VFS have included:
 - Below cropland or other fields;
 - Above conservation practices such as terraces or diversions;
 - Between fields;
 - Alternating between wider bands of row crops;
 - Adjacent to wetlands, streams, ponds, or lakes;
 - Along roadways, parking lots, or other impervious areas;
 - In areas requiring filter strips as part of a waste management system; and
 - On forested land.

VFS function properly only in situations where they can accept overland sheet flow of runoff and should be designed accordingly. If existing site conditions include concentrated flows, then BMPs other than VFS should be used. Contact time between runoff and the vegetation is a critical variable influencing VFS effectiveness. Pollutant-removal effectiveness increases as the ratio of VFS area to runoff-contributing area increases.

- (4) Key elements to be considered in the design of VFS areas follow:
 - **Type and Quantity of Pollutant.** Sediment, nitrogen, phosphorus, and toxics are efficiently removed by VFS (see Table 7-9). However, removal rates are much lower for soluble nutrients and toxics.
 - **Slope.** VFS function best on slopes of less than 5 percent; slopes greater than 15 percent render them ineffective because surface runoff flow will not be sheet-like and uniform. The effectiveness of VFS is strongly site-dependent. They are ineffective on hilly plots or in terrain that allows concentrated flows.

- **Native/Noninvasive Plants.** The best species for VFS are those which will produce dense growths of grasses and legumes resistant to overland flow. Use native or at least noninvasive plants to avoid negatively impacting adjacent natural areas.
- **Length.** The length of VFS is an important variable influencing VFS effectiveness because contact time between runoff and vegetation in the VFS increases with increasing VFS length. Some sources recommend a minimum length of about 50 feet (Dillaha et al., 1989a; Nieswand et al., 1989; Schueler, 1987). USDA (1988) has prepared design criteria for VFS that take into consideration the nature of the source area for the runoff and the slope of the terrain. Another suggested design criterion that can be found in the literature is for the VFS length to be at least as long as the runoff-contributing area. Unfortunately, there are no clear guidelines available in the literature for calculating VFS lengths for specific site conditions. Accordingly, this guidance does not prescribe either a numeric value for the minimum length for an effective filter strip or a standard method to be used in the design criteria for computing the length of a VFS.
- **Detention Time.** In the design process for a vegetated filter strip, some consideration should be given to increasing the detention time of runoff as it passes over the VFS. One possibility is to design the vegetated filter strip to include small rills that run parallel to the leading edge of the vegetated filter strip. These rills would serve to trap water as runoff passes through the vegetated filter strip. Another possibility is to plant crops upslope of the vegetated filter strip in rows running parallel to the leading edge of the vegetated filter strip. Data from a study by Young and others (1980), in which corn was planted in rows parallel to the leading edge of the filter strip, show an increase in sediment trapping and nutrient removal.
- **Monitoring of Performance.** The design, placement, and maintenance of VFS are all very critical to their effectiveness, and concentrated flows should be prevented. Although intentional planting and naturalization of the vegetation will enhance the effectiveness of a larger filter strip, the strip should be inspected periodically to determine whether concentrated flows are bypassing or overwhelming the BMP, particularly around the perimeter. The vegetated filter strip should also be regularly inspected to determine whether sediment is accumulating within the vegetated filter strip in quantities that would reduce its effectiveness (Magette et al., 1989).
- **Maintenance.** For VFS that are relatively short in length, natural vegetative succession is not intended and the vegetation should be managed like a lawn. It should be mowed two or three times a year, fertilized, and weeded in an attempt to achieve dense, hearty vegetation. The goal is to increase vegetation density for maximum filtration. Accumulated sediment and particulate matter in a VFS should be removed at regular intervals to prevent inundation during runoff events. The frequency at which this type of maintenance will be required will depend on the frequency and volume of runoff flows. Also, if the soil is moderately erodible in the drainage area, additional precautions should be taken to avoid excessive buildup of sediment in the grassed area (NVPDC, 1987). Development of channels and erosion rills within the VFS must be avoided. To ensure effectiveness, sheet flow must be maintained at all times. The maintenance of VFS located adjacent to streams is especially important since sediment bypassing a VFS and entering a coastal waterbody will cause problems for the spawning and early juvenile stages of fish.

Dillaha and others (1989b) showed that many of the VFS installed in Virginia performed poorly because of poor design and maintenance. Consider including one or more of the following items in a VFS maintenance program to make the performance of any VFS more efficient:

- Adding a stone trench to spread water effectively across the surface of the filter;
- Keeping the VFS carefully shaped to ensure sheet flow;
- Inspecting for damage following major storm events; and
- Removing any accumulation of sediment.

- b. *Construct properly engineered systems of wetlands for NPS pollution control. Manage these systems to avoid negative impacts on surrounding ecosystems or ground water.*

Several factors must be considered in the design and construction of an artificial wetland to ensure the maximum performance of the facility for pollutant removal:

Hydrology. The most important variable in constructed wetland design is hydrology. If the proper hydrologic conditions are developed, the chemical and biological conditions will, to a degree, respond accordingly (Mitsch and Gosselink, 1986).

Soils. The underlying soils in a wetland vary in their ability to support vegetation, to prevent percolation of surface water into the ground water, and to provide active exchange sites for adsorption of constituents like phosphorus and metals.

Vegetation. The types of vegetation used in constructed wetlands depend on the region and climate of the constructed wetland (Mitsch, 1977). When possible, use native plant species or noninvasive species to avoid negative impacts to nearby natural wetland areas. There are several guides for the selection of wetland plants such as the *Midwestern Guide to Flora* (USDA) or the Florida Department of Environmental Regulation's list of suggested wetland species.

Influent Water Quality. Characterization of influent water quality, such as the types and magnitude of the pollutants, will determine the design characteristics of the constructed wetland.

Geometry. The size and shape of the constructed wetland will influence the detention time of the wetland, the flow rate of surface water runoff moving through the system, and the pollutant removal effectiveness under "typical" conditions.

Pretreatment. Constructed wetlands should contain forebays to trap sediment before runoff enters the vegetated area of the constructed wetland system. Baffles and diversions should be strategically placed to prevent trapped sediment from becoming resuspended during subsequent storm events prior to cleanup.

Maintenance. Constructed wetlands need to be maintained for optimal performance. Since pollutant removal is the primary objective of the constructed wetland, vegetation and sediment removal are two of the more important maintenance considerations. Properly designed constructed wetlands should not need any maintenance of vegetation. Constructed wetlands must be managed to avoid any negative impacts to wildlife and surrounding areas. For example, non-native or undesirable plant species must be kept out of adjacent wetlands or riparian areas. Contamination of sediments due to toxics entering the constructed wetland must also be controlled. The Kesterson National Wildlife Refuge in California is an excellent example of a case in which selenium contamination in wetland sediments was found to cause deaths and deformities in visiting waterfowl (Ohlendorf et al., 1986). Forebays and deep water areas should be inspected periodically, and excess sediment should be removed from the system and disposed of in an appropriate manner. Other routine maintenance requirements include wildlife management, mosquito control, and debris and litter removal (Mitsch, 1990; Schueler, 1987). As debris and litter collect in the detention basins and vegetated areas, they need to be routinely removed to prevent channelization and outflow blockage from occurring. The area around the constructed wetland should be mowed periodically to keep a healthy stand of grass or other desirable vegetation growing. Structural repairs and erosion control should also be done when needed.

Effectiveness of Constructed Wetlands

Table 7-10 summarizes the pollutant-removal effectiveness of constructed wetland systems built for treatment of surface water runoff. In general, constructed wetland systems designed for treatment of NPS pollution in surface water runoff were effective at removing suspended solids and pollutants that attach to solids and soil particles (refer to Table 7-10). The constructed wetland systems were not as effective at removing dissolved pollutants and those pollutants that dissolve under conditions found in the wetland. When the overall effectiveness data are compared

among systems, no discernible trends are apparent. Although attempts to correlate removal effectiveness with an area or volume ratio have not shown any significant trends, the constructed wetlands listed in Table 7-10 still served a valuable role in pollutant removal. Total solids removal ranged from 63 percent to 94 percent among the five systems. Nitrogen removal was not as effective, with effectiveness ranging from 10 percent to 76 percent. Phosphorus removal ranged from 37 percent to 90 percent among the constructed wetland systems compared in this document.

Whether constructed wetlands and VFS are used individually or in series will depend on several factors, including the quantity and quality of the inflowing runoff, the characteristics of the existing hydrology, and the physical limitations of the area surrounding the wetland or riparian area to be protected.

A schematic drawing of a system of filter strips and constructed wetland placed in the path of the existing surface water supply to a stream is shown in Figure 7-2.

5. Costs for All Practices

The use of appropriate practices for pretreatment of runoff and prevention of adverse impacts to wetlands and other waterbodies involves the design and installation of vegetated treatment systems such as vegetated filter strips or constructed wetlands, or the use of structures such as detention or retention basins. These types of systems are discussed individually elsewhere in this guidance document. Refer to Chapter 4 for a discussion of the costs and effectiveness of detention and retention basins. The purpose of each of these BMPs is to remove, to the extent practicable, excessive levels of NPS pollutants and to minimize impacts of hydrologic changes. Each of these BMPs can function to reduce levels of pollutants in runoff or attenuate runoff volume before the runoff enters a natural wetland or riparian area or another waterbody.

Several source documents contain information on costs for vegetated treatment systems. Nieswand and others (1989) published costs for vegetated filter strips employed as part of watershed management strategies for New Jersey. Costs varied over a wide range depending on whether the method of installation involved seeding, sodding, or hydroseeding. Another source of cost information on filter strips is EPA's NWQEP 1988 *Annual Report: Status of Agricultural Nonpoint Source Projects* (1988).

The most comprehensive source of cost data for filter strips was obtained from the USDA ASCS, which provides cost share reimbursement each year to individual farmers for a variety of practices contained in the *National Handbook of Conservation Practices* (1988). Information was obtained from USDA on the costs in each State for work performed in accordance with Specification No. 393 (Filter Strips) in the *National Handbook* for the base year of 1990. Based on these data, a total of 914 filter strip projects were installed with cost share assistance in 28 States. The total cost of these projects was \$833,871.00. The total combined length of all projects was 6,443,800 linear feet. If an average width of 66 feet is assumed for the filter strip, then an average cost per acre is calculated at \$85.41 per acre, in 1990 dollars.

For constructed wetlands, examples of cost data are as follows:

- (1) Lake Jackson, Florida: A cost of \$80,769 was reported in 1990 for design and construction of a 9.88-acre constructed wetland for treatment of urban nonpoint runoff (Mitsch, 1990).
 Cost in 1990 dollars \$ 8,175.00/acre
- (2) Greenwood Urban Wetland, Minnesota: A cost of \$20,370 was reported in 1990 for design and construction of a 27.2-acre wetland for treatment of urban nonpoint runoff (Mitsch, 1990).
 Cost in 1990 dollars \$ 748.89/acre
- (3) Broward County, Florida: A cost range of \$10,000 to \$100,000 per acre (1992) was given for constructing surface water runoff wetlands on sites of new developments. The average cost for

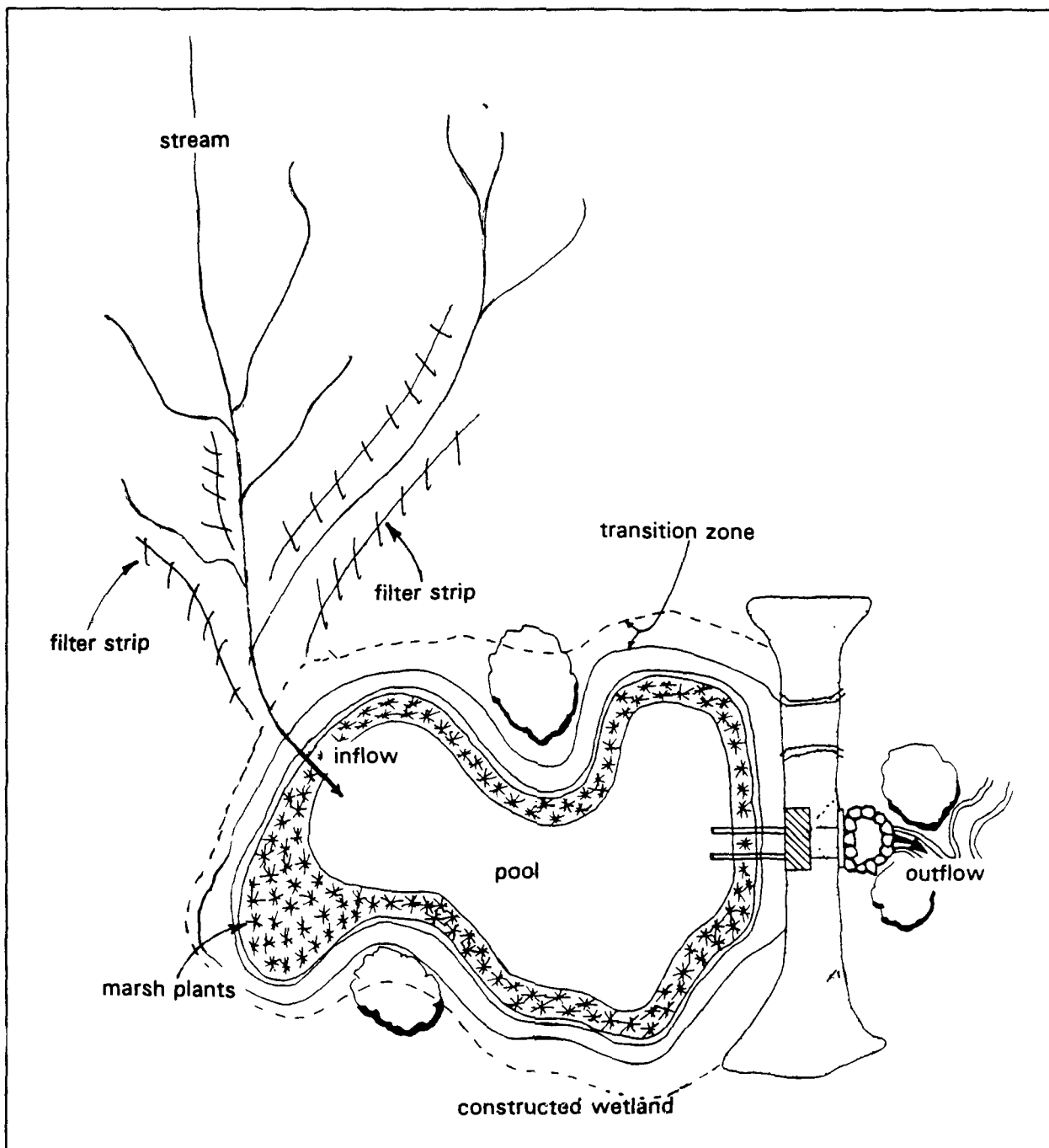

Figure 7-2. Schematic of vegetated treatment system, including a vegetated filter strip and constructed wetland. (After Schueler, 1992).

constructing a wetland was given as \$20,000. The costs represent mucking (depositing organic material substrate) and planting emergent wetlands plants. Site monitoring adds \$10,000 to \$12,000 per year for sites up to 10 acres. (Goldasich, Broward County Office of Natural Resources Protection, personal communication, July 1992).

Cost in 1990 dollars \$19,200/acre

It is important to note that the type of constructed wetland facility described in this guidance is for treatment of urban or agricultural runoff. To avoid confusion, costs of wetlands constructed for other purposes, particularly for municipal wastewater treatment, were not considered.

As illustrated by the three examples cited above, the cost per acre of constructed wetlands facilities will vary from site to site. One reason is that certain items of work have economies of scale that are rather limited. For example, costs for site surveys, design, gaining access to the site, mobilization of equipment, and installation of sediment and surface water runoff controls do not necessarily increase in proportion to the size of the project. Other factors that affect costs are regional variations in suitable plant species, treatment of existing surface water flow patterns, and detention/retention capacity.

Based on the cost data contained in the source documents, costs are reported below for three realistic hypothetical scenarios of systems of constructed wetlands and vegetated filter strips.

- (1) One filter strip at a cost of \$ 129.00
 - Includes design and installation of a grass filter strip 1,000 feet long and 66 feet wide.
 - Most effective at trapping sediments and removing phosphorus from surface water runoff.

- (2) One constructed wetland at a cost of \$ 5,000.00
 - Includes design and installation of a constructed wetland whose surface area is 0.25 acre in size. The constructed wetland is planted with commercially available emergent vegetation.
 - Most effective at removing nutrients and at decreasing the rate of inflow of surface water runoff.

- (3) One combined filter strip/constructed wetland \$ 5,129.00

III. Glossary

Abiotic: Not biological; not involving or produced by organisms (Merriam-Webster, 1991).

Adsorption: The accumulation of substances at the interface between two phases; in water treatment, the interface is between the liquid and solid surfaces that are artificially provided (Peavy et al., 1985).

Biological assimilation: The conversion of nonliving substances into living protoplasm or cells by using energy to build up complex compounds of living matter from the simple nutritive compounds obtained from food (Barnhart, 1986).

Biotic: Caused or produced by living beings (Merriam-Webster, 1991).

Chelation: The process of binding and stabilizing metallic ions by means of an inert complex compound or ion in which a metallic atom or ion is bound at two or more points to a molecule or ion so as to form a ring; the increasing complex stability of coordination compounds caused by an increasing number of attachments (usually to a metal ion) (Barnhart, 1986; Snoeyink and Jenkins, 1980; Merriam-Webster, 1991).

Chemical decomposition: Separation into elements or simpler compounds; chemical breakdown (Merriam-Webster, 1991).

Complexation: The process by which one substance is converted to another substance in which the constituents are more intimately associated than in a simple mixture; chelation is one type of complexation (Merriam-Webster, 1991).

Connectedness: Having the property of being joined or linked together, as in aquatic or riparian habitats.

Constructed wetland: Engineered systems designed to simulate natural wetlands to exploit the water purification functional value for human use and benefits. Constructed wetlands consist of former upland environments that have been modified to create poorly drained soils and wetlands flora and fauna for the primary purpose of contaminant or pollutant removal from wastewaters or runoff. Constructed wetlands are essentially wastewater treatment systems and are designed and operated as such even though many systems do support other functional values (Hammer, 1992).

Denitrification: The biochemical reduction of nitrate or nitrite to gaseous nitrogen, either as molecular nitrogen or as an oxide of nitrogen.

Ecosystem: The complex of a community and its environment functioning as an ecological unit in nature; a basic functional unit of nature comprising both organisms and their nonliving environment, intimately linked by a variety of biological, chemical, and physical processes (Merriam-Webster, 1991; Barnhart, 1986).

Filtration: The process of being passed through a filter (as in the physical removal of impurities from water) or the condition of being filtered (Barnhart, 1986).

Habitat: The place where an organism naturally lives or grows.

Riparian area: Vegetated ecosystems along a waterbody through which energy, materials, and water pass. Riparian areas characteristically have a high water table and are subject to periodic flooding and influence from the adjacent waterbody. These systems encompass wetlands, uplands, or some combination of these two land forms; they do not in all cases have all of the characteristics necessary for them to be classified as wetlands (Mitsch and Gosselink, 1986; Lowrance et al., 1988).

Sedimentation: The formation of earth, stones, and other matter deposited by water, wind, or ice (Barnhart, 1986).

Species diversity: The variations between groups of related organisms that have certain characteristics in common (Barnhart, 1986; Merriam-Webster, 1991).

Upland: Ground elevated above the lowlands along rivers or between hills (Merriam-Webster, 1991).

Vegetated buffer: Strips of vegetation separating a waterbody from a land use that could act as a nonpoint pollution source. Vegetated buffers (or simply buffers) are variable in width and can range in function from vegetated filter strips to wetlands or riparian areas.

Vegetated filter strip: Created areas of vegetation designed to remove sediment and other pollutants from surface water runoff by filtration, deposition, infiltration, adsorption, decomposition, and volatilization. A vegetated filter strip is an area that maintains soil aeration as opposed to a wetland, which at times exhibits anaerobic soil conditions (Dillaha et al., 1989a).

Vegetated treatment system: A system that consists of a vegetated filter strip, a constructed wetland, or a combination of both.

Wetlands: Those areas that are inundated or saturated by surface water or ground water at a frequency and duration to support, and that under normal circumstances do support, a prevalence of vegetation typically adapted for life in saturated soil conditions; wetlands generally include swamps, marshes, bogs, and similar areas. (This definition is consistent with the Federal definition at 40 CFR 230.3, promulgated December 24, 1980. As amendments are made to the wetland definition, they will be considered applicable to this guidance.)

IV. REFERENCES

Abbruzzese, B., S.G. Leibowitz, and R. Sumner. 1990a. *Application of the Synoptic Approach to Wetland Designation: A Case Study in Louisiana, Final Report*. Submitted to U.S. Environmental Protection Agency, Office of Wetlands Protection, Washington, DC.

Abbruzzese, B., S.G. Leibowitz, and R. Sumner. 1990b. *Application of the Synoptic Approach to Wetland Designation: A Case Study in Washington, Final Report*. Submitted to U.S. Environmental Protection Agency, Region 10, Seattle, WA.

Association of Florida Native Nurseries (AFNN). 1989. *1989-90 Plant and Service Locator*.

Allen R.T., and R.J. Field. 1985. Riparian Zone Protection by TVA: An Overview of Policies and Programs. In *Proceedings Riparian Ecosystems and their Management: Reconciling Conflicting Issues*, Tucson, AZ, 16-18 April 1985, pp. 23-26. U.S. Department of Agriculture Forest Service, Rocky Mountain Forest and Range Experiment Station, Fort Collins, CO. GTR RM-120.

Anderson, M.T. 1985. Riparian Management of Coastal Pacific Ecosystems. In *Proceedings Riparian Ecosystems and their Management: Reconciling Conflicting Issues*, Tucson, AZ, 16-18 April 1985, pp. 364-368. U.S. Department of Agriculture Forest Service, Rocky Mountain Forest and Range Experiment Station, Fort Collins, CO. GTR RM-120.

Anderson, R., and M. Rockel. 1991. *Economic Valuation of Wetlands*. American Petroleum Institute, Washington, DC.

Atcheson, J., E.T. Conrad, S. F., W. Bailey, and M. Hughes, Jr. 1979. *Analysis of Selected Functional Characteristics of Wetlands*. Prepared for the U.S. Army Coastal Engineering Research Center.

Azous, A. 1991. An Analysis of Urbanization Effects on Wetland Biological Communities. Master's thesis, University of Washington. Puget Sound Wetlands and Stormwater Management Research Program.

Barnhart, R.K. 1986. *The American Heritage Dictionary of Science*. Houghton Mifflin Company, Boston, MA.

Bedford, B.L., and E.M. Preston. 1988. Developing the Scientific Basis for Assessing Cumulative Effects of Wetland Loss and Degradation on Landscape Functions: Status, Perspectives, and Prospects. *Environmental Management*, 12(5):751-771.

Bradley, W.P. 1988. Riparian Management Practices on Indian Lands. In *Proceedings Streamside Management: Riparian Wildlife and Forestry Interactions*, ed. K. Raedeke, Seattle, WA, 11-13 February 1987, pp. 201-206. University of Washington, Institute of Forest Resources, Seattle, WA. Contribution No. 59.

Brinson, M.M. 1988. Strategies for Assessing the Cumulative Effects of Wetland Alteration on Water Quality. *Environmental Management*, 12(5):655-662.

Brinson, M.M., H.D. Bradshaw, and E.S. Kane. 1984. Nutrient Assimilative Capacity of an Alluvial Floodplain Swamp. *Journal of Applied Ecology*, 21:1041-1057.

Burke, D.G., E.J. Meyers, R.W. Tiner, Jr., and H. Groman. 1988. *Protecting Nontidal Wetlands*. American Planning Association, Washington, DC. Planning Advisory Service Report No. 412/413.

Calhoun, J.M. 1988. Riparian Management Practices of the Department of Natural Resources. In *Proceedings Streamside Management: Riparian Wildlife and Forestry Interactions*, ed. K. Raedeke, Seattle, WA, 11-13 February 1987, pp. 207-211. University of Washington, Institute of Forest Resources, Seattle, WA. Contribution No. 59.

- Confer, S., and W.A. Niering. Undated. Comparison of Created Freshwater and Natural Emergent Wetlands in Connecticut. Submitted to *Wetland Ecology and Management*.
- Cooper, A.B. 1990. Nitrate Depletion in the Riparian Zone and Stream Channel of a Small Headwater Catchment. *Hydrobiologia*, 202:13-26.
- Cooper, J.R., J.W. Gilliam, and T.C. Jacobs. 1986. Riparian Areas as a Control of Nonpoint Pollutants. In *Watershed Research Perspectives*, ed. D. Correll, pp. 166-192. Smithsonian Institution Press, Washington, DC.
- Cooper, J.R., and J.W. Gilliam. 1987. Phosphorus Redistribution from Cultivated Fields into Riparian Areas. *Soil Science Society of America Journal*, 51(6):1600-1604.
- Cooper, J.R., J.W. Gilliam, R.B. Daniels, and W.P. Robarge. 1987. Riparian Areas as Filters for Agriculture Sediment. *Soil Science Society of America Journal*, 51(6):417-420.
- Corbet, E.S., and J.A. Lynch. 1985. Management of Streamside Zones on Municipal Watersheds. In *Proceedings Riparian Ecosystems and their Management: Reconciling Conflicting Issues*, Tucson, AZ, 16-18 April 1985, pp. 187-190. U.S. Department of Agriculture Forest Service, Rocky Mountain Forest and Range Experiment Station, Fort Collins, CO. GTR RM-120.
- Correll, D.L., and D.E. Weller. 1989. Factors Limiting Processes in Freshwater: An Agricultural Primary Stream Riparian Forest. In *Freshwater Wetlands and Wildlife*, ed. R.R. Sharitz and J.W. Gibbons, pp. 9-23. U.S. Department of Energy, Office of Science and Technology Information, Oak Ridge, TN. DOE Symposium Series #61.
- Dawson, K.J., and G.E. Sutter. 1985. Research Issues in Riparian Landscape Planning. In *Proceedings Riparian Ecosystems and their Management: Reconciling Conflicting Issues*, Tucson, AZ, 16-18 April 1985, pp. 408-412. U.S. Department of Agriculture Forest Service, Rocky Mountain Forest and Range Experiment Station, Fort Collins, CO. GTR RM-120.
- Dickey, E.C., and D.H. Vanderholm. 1981. Vegetative Filter Treatment of Livestock Feedlot Runoff. *Journal of Environmental Quality*, 10(3): 279-284.
- Dillaha, T.A., J.H. Sherrard, D. Lee, S. Mostaghimi, and V.O. Shanholtz. 1988. Evaluation of Vegetative Filter Strips as a Best Management Practice for Feed Lots. *Journal of Water Pollution Control Federation*, 60(7):1231-1238.
- Dillaha, T.A., R.B. Renear, S. Mostaghimi, and D. Lee. 1989a. Vegetative Filter Strips for Agricultural Nonpoint Source Pollution Control. *Transactions of the American Society of Agricultural Engineers*, 32(2):513-519.
- Dillaha, T.A., J.H. Sherrard, and D. Lee. 1989b. Long-Term Effectiveness of Vegetative Filter Strips. *Water Environment and Technology*, November 1989:419-421.
- Earhart, H. G. and E.W. Garbisch, Jr. 1983. Habitat Development Utilizing Dredged Material at Barren Island Dorchester County Maryland. In *Wetlands*, 3:108-119.
- Faber, P.M., E. Keller, A. Sands, and B. M. Massey. 1989. *The Ecology of Riparian Habitats of the Southern California Coastal Region: A Community Profile*. U.S. Department of the Interior Fish and Wildlife Service, Washington, DC. Biological Report 85(7.27).
- Fail, J.L., Jr., B.L. Haines, and R.L. Todd. Undated. Riparian Forest Communities and Their Role in Nutrient Conservation in an Agricultural Watershed. *American Journal of Alternative Agriculture*, II(3):114-120.

- Fannin, T.E., M. Parker, and T.J. Maret. 1985. Multiple Regression Analysis for Evaluating Non-point Source Contributions to Water Quality in the Green River, Wyoming. In *Proceedings Riparian Ecosystems and Their Management: Reconciling Conflicting Issues*, Tucson, AZ, 16-18 April 1985, pp. 201-205. U.S. Department of Agriculture Forest Service, Rocky Mountain Forest and Range Experiment Station, Fort Collins, CO. GTR RM-120.
- Federal Register. 1980. 40 CFR 230.3, December 24, 1980.
- Ffolliot, P.F., and R.L. Jemison. 1985. Land Use in Majjia Valley, Niger, West Africa. In *Proceedings Riparian Ecosystems and Their Management: Reconciling Conflicting Issues*, Tucson, AZ, 16-18 April 1985, pp. 470-474. U.S. Department of Agriculture Forest Service, Rocky Mountain Forest and Range Experiment Station, Fort Collins, CO. GTR RM-120.
- Fleischer, S., L. Stibe, and L. Leonardson. 1991. Restoration of Wetlands as a Means of Reducing Nitrogen Transport to Coastal Waters. *Ambio: A Journal of the Human Environment*, 20(6):271-272.
- Groenvelt, D.P., and E. Griepentrog. 1985. Interdependence of Groundwater, Riparian Vegetation, and Streambank Stability: A Case Study. In *Proceedings Riparian Ecosystems and their Management: Reconciling Conflicting Issues*, Tucson, AZ, 16-18 April 1985, pp. 44-48. U.S. Department of Agriculture Forest Service, Rocky Mountain Forest and Range Experiment Station, Fort Collins, CO. GTR RM-120.
- Grogan, T. 1991. Cost Index History. *Engineering News-Record*, 226(12):46-51.
- Hammer, D.A. 1992. Designing Constructed Wetlands Systems to Treat Agricultural Nonpoint Source Pollution. *Ecological Engineering*, 1(1992): 49-82.
- Hammer, D.A., B.P. Pullin, and J.T. Watson. 1989. *Constructed Wetlands for Livestock Waste Treatment*. Tennessee Valley Authority, Knoxville, TN.
- Hanson, J.S., G.P. Malanson, and M.P. Armstrong. 1990. Landscape Fragmentation and Dispersal in a Model of Riparian Forest Dynamics. *Ecological Modeling*, 49(1990):277-296.
- Illinois Department of Conservation. 1990. *Forestry Development Cost-Share Program*. Illinois Administrative Code, Title 17, Chapter I, Subchapter d, Part 1536.
- Jacobs, T.C., and J.W. Gilliam. 1985. Riparian Losses of Nitrate from Agricultural Drainage Waters. *Journal of Environmental Quality*, 14(4):472-478.
- James, B.R., B.B. Bagley, and P.H. Gallagher. 1990. Riparian Zone Vegetation Effects on Nitrate Concentrations in Shallow Groundwater. Submitted for publication in the *Proceedings of the 1990 Chesapeake Bay Research Conference*. University of Maryland, Soil Chemistry Laboratory, College Park, MD.
- Jerome, L.E. 1979. Marsh Restoration: Economic Rewards of a Healthy Salt Marsh. *Oceans*, January 1979.
- Josselyn, M., and J. Buchholz. 1984. *Marsh Restoration in San Francisco Bay: A Guide to Design & Planning*. Tiburon Center for Environmental Studies, San Francisco State University. Technical Report No. 3.
- Karr, J.R., and I.J. Schlosser. 1977. *Impact of Nearstream Vegetation and Stream Morphology on Water Quality and Stream Biota*. Ecological Research Series. U.S. Environmental Protection Agency, Washington, DC. EPA-600/3-77-097.
- Karr, J.R., and O.T. Gorman. 1975. Effects of Land Treatment on the Aquatic Environment. In *U.S. Environmental Protection Agency Non-Point Source Pollution Seminar*, pp. 4-1 to 4-18. Washington, DC. EPA 905/9-75-007.

- Kiraly, S.J., F.A. Cross, and J.D. Buffington. 1990. *Federal Coastal Wetland Mapping Programs*. U.S. Department of the Interior Fish and Wildlife Service, Washington, DC. Biological Report 90(18).
- Kleiss, B.A., E.E. Morris, J.F. Nix, and J.W. Barko. 1989. Modification of Riverine Water Quality by an Adjacent Bottomland Hardwood Wetland. In *Proceedings Wetlands: Concerns and Successes*, ed. D.W. Fisk, Tampa, FL, 17-22 September 1989, pp. 429-438. American Water Resources Association, Bethesda, MD. TPS 89-3.
- Lambou, V.W. 1985. Aquatic Organic Carbon and Nutrient Fluxes, Water Quality, and Aquatic Productivity in the Atchafalaya Basin, Louisiana. In *Proceedings Riparian Ecosystems and Their Management: Reconciling Conflicting Issues*, Tucson, AZ, 16-18 April 1985, pp. 180-185. U.S. Department of Agriculture Forest Service, Rocky Mountain Forest and Range Experiment Station, Fort Collins, CO. GTR RM-120.
- Lanier, A.L. 1990. *Database for Evaluating the Water Quality Effectiveness of Best Management Practices*. North Carolina State University, Department of Biological and Agricultural Engineering, Chapel Hill, NC.
- Lee, K.H. 1991. *Wetlands Detection Methods Investigation*. Prepared for U.S. Environmental Protection Agency, Environmental Monitoring Systems Laboratory, Las Vegas, NV. EPA/600/4-91/014.
- Licht, L.A., and J.L. Schnoor. 1990. *Poplar Tree Buffer Strips Grown in Riparian Zones for Non-point Source Pollution Control and Biomass Production*. Leopold Center for Sustainable Agriculture.
- Lowrance, R.R., R.L. Todd, and L.E. Asmussen. 1983. Waterborne Nutrient Budgets for the Riparian Zone of an Agricultural Watershed. *Agriculture, Ecosystems and Environment*, 10:371-384.
- Lowrance, R.R., R.L. Todd, and L.E. Asmussen. 1984. Nutrient Cycling in an Agricultural Watershed: Phreatic Movement. *Journal of Environmental Quality*, 13(1):22-27.
- Lowrance, R.R., S. McIntyre, and C. Lance. 1988. Erosion and Deposition in a Field/Forest System Estimated Using Cesium-137 Activity. *Journal of Soil and Water Conservation*, 43(2):195-199.
- Magette, W.L., R.B. Brinsfield, R.E. Palmer, and J.D. Wood. 1989. Nutrient and Sediment Removal by Vegetated Filter Strips. *Transactions of the American Society of Agricultural Engineers*, 32(2):663-667.
- Martin, E.H. and J.L. Smoot. Undated. *Constituent Load Changes in Urban Stormwater Runoff Routed Through a Detention Pond-Wetland System in Central Florida*.
- Maryland Department of Agriculture. 1990. *Directory of Certified Nurseries Licensed Plant Dealers Licensed Plant Brokers*. Annapolis, MD.
- Merriam-Webster. 1991. *Webster's Ninth New Collegiate Dictionary*. Merriam-Webster, Inc., Springfield, MA.
- Mitsch, W.J. 1977. Water Hyacinth (*Eichhornia crassipes*) Nutrient Uptake and Metabolism in a North-Central Florida Marsh. *Archiv. fur Hydrobiologia*. 81:188-210.
- Mitsch, W.J. 1990. *Wetlands for the Control of Nonpoint Source Pollution: Preliminary Feasibility Study for Swan Creek Watershed of Northwestern Ohio*. Ohio Environmental Protection Agency, Columbus, OH.
- Mitsch, W.J. 1992. Landscape Design and the Role of Created, Restored, and Natural Riparian Wetlands in Controlling Nonpoint Source Pollution. *Ecological Engineering*, 1(1992):27-47.
- Mitsch, W.J., and J.G. Gosselink. 1986. *Wetlands*. Van Nostrand Reinhold Co., New York, NY.
- Moring, J.R., G.C. Carman, and D.M. Mullen. 1985. The Value of Riparian Zones for Protecting Aquatic Systems: General Concerns and Recent Studies in Maine. In *Proceedings Riparian Ecosystems and their Management*:

- Reconciling Conflicting Issues*, Tucson, AZ, 16-18 April 1985, pp. 315-319. U.S. Department of Agriculture Forest Service, Rocky Mountain Forest and Range Experiment Station, Fort Collins, CO. GTR RM-120.
- Nabhan, G.P. 1985. Riparian Vegetation and Indigenous Southwestern Agriculture: Control of Erosion, Pests, and Microclimate. In *Proceedings Riparian Ecosystems and their Management: Reconciling Conflicting Issues*, Tucson, AZ, 16-18 April 1985, pp. 232-236. U.S. Department of Agriculture Forest Service, Rocky Mountain Forest and Range Experiment Station, Fort Collins, CO. GTR RM-120.
- Naiman, R.J., H. Decamps, J. Pastor, and C.A. Johnston. 1988. The Potential Importance of Boundaries to Fluvial Ecosystems. *Journal of the North American Benthological Society*, 7(4):289-306.
- National Research Council. 1991. *Restoration of Aquatic Ecosystems: Science, Technology, and Public Policy*. National Academy Press, Washington, DC.
- Nelson, D.R., and R.L. Williams. 1989. Streambank Stabilization in Strawberry Valley, Utah. In *Practical Approaches to Riparian Resource Management: An Educational Workshop*, Billings, MN, 8-11 May 1989, p. 177. U.S. Department of the Interior Bureau of Land Management.
- Nieswand, G.H., B.B. Chavooshian, R.M. Hordon, T. Shelton, S. Blarr, and B. Brodeur. 1989. *Buffer Strips to Protect Water Supply Reservoirs and Surface Water Intakes: A Model and Recommendations*. Cook College Department of Environmental Resources for the New Jersey Department of Environmental Protection.
- Novitzki, R.P. 1979. Hydrologic Characteristics of Wisconsin's Wetlands and their Influence on Floods, Stream Flow and Sediment. In *Wetland Function and Values: The State of Our Understanding*, ed. Greeson, Clark, and Clark, pp. 377-388. American Water Resource Association, Minneapolis, MN.
- NVPDC. 1987. *BMP Handbook for the Occoquan Watershed*. Northern Virginia Planning District Commission.
- Oakely, A.L. 1988. Riparian Management Practices of the Bureau of Land Management. In *Proceedings Streamside Management: Riparian Wildlife and Forestry Interactions*, ed. K. Raedeke, Seattle, WA, 11-13 February 1987, pp. 191-196. University of Washington, Institute of Forest Resources, Seattle, WA. Contribution No. 59.
- Oberts, G.L., and R.A. Osgood. 1991. Water-Quality Effectiveness of a Detention/Wetland Treatment System and its Effect on an Urban Lake. *Environmental Management*, 15(1):131-138.
- Ohlendorf, H.M., R.L. Hothem, C.M. Bunck, T.W. Aldrich, and J.F. Moore. 1986. Relationships Between Selenium Concentrations and Avian Reproduction. In *Transactions of the North American Wildlife and Natural Resources Conference*, pp. 330-342.
- Overman, A.R., and T. Schanze. 1985. Runoff Water Quality from Wastewater Irrigation. *Transaction of the American Society of Agricultural Engineers*, 28:1535-1538.
- Pacific Estuarine Research Laboratory. 1990. *A Manual for Assessing Restored and Natural Coastal Wetlands with Examples from Southern California*. California Sea Grant, La Jolla, CA.
- Peavy, H.S., D.R. Rowe, and G. Tchobanoglous. 1985. *Environmental engineering*. McGraw-Hill Publishing Company, New York, NY.
- Peterjohn, W.T., and D.L. Correll. 1984. Nutrient Dynamics in an Agricultural Watershed: Observations on the Role of a Riparian Forest. *Ecology*, 65(5):1466-1475.
- Phillips, J.D. 1989. Nonpoint Source Pollution Control Effectiveness of Riparian Forests Along a Coastal Plain River. *Journal of Hydrology*, 110(1989):221-237.

- Pinay, G., and H. Decamps. 1988. The Role of Riparian Woods in Regulating Nitrogen Fluxes Between the Alluvial Aquifer and Surface Water: A Conceptual Model. *Regulated Rivers: Research and Management*, 2:507-516.
- Powers, R.M., and J.F. Spence. 1989. Headwater Restoration: The Key Is Integrated Project Goals. In *Proceedings Wetlands: Concerns and Successes*, ed. D.W. Fisk, Tampa, FL, 17-22 September 1989, pp. 269-279. American Water Resources Association, Bethesda, MD. TPS 89-3.
- Reinelt, L.E., and R.R. Horner. 1990. *Characterization of the Hydrology and Water Quality of Palustrine Wetlands Affected by Urban Stormwater*. Puget Sound Wetlands and Stormwater Management Research Program.
- Rhodes, J., C.M. Skau, D. Greenlee, and D. Brown. 1985. Quantification of Nitrate Uptake by Riparian Forests and Wetlands in an Undisturbed Headwaters Watershed. In *Proceedings Riparian Ecosystems and Their Management: Reconciling Conflicting Issues*, Tucson, AZ, 16-18 April 1985, pp. 175-179. U.S. Department of Agriculture Forest Service, Rocky Mountain Forest and Range Experiment Station, Fort Collins, CO. GTR RM-120.
- Richardson, C.J. 1988. Freshwater Wetlands: Transformers, Filters, or Sinks? *FOREM*, 11(2):3-9. School of Forestry and Environmental Studies, Duke University.
- Richardson, C.J, and J.A. Davis. 1987. Natural and Artificial Wetland Ecosystems: Ecological Opportunities and Limitations. In *Aquatic Plants for Water Treatment and Resource Recovery*, ed. K.H. Reddy and W.H. Smith, pp. 819-854. Magnolia Publishing Inc.
- Richter, K.O., A. Azous, S.S. Cooke, R. Wisseman, and R. Horner. 1991. *Effects of Stormwater Runoff on Wetland Zoology and Wetland Soils Characterization and Analysis*. King County Resource Planning Section, Washington State Department of Ecology.
- Rushton, B.T., and C.W. Dye. 1990. Tampa Office Wet Detention Stormwater Treatment. In *Annual Report for Stormwater Research Program Fiscal Year 1989-1990*, Southwest Florida Water Management District, pp. 39-74.
- Schipper, L.A., A.B. Cooper, and W.J. Dyck. 1989. *Mitigating Non-Point Source Nitrate Pollution by Riparian Zone Denitrification*. Forest Research Institute, Rotorua, New Zealand.
- Schueler, T. 1987. *Controlling Urban Runoff: A Practical Manual for Planning and Designing Urban BMPs*. Metropolitan Washington Council of Governments, Washington DC.
- Schueler, T. 1992. *A Current Assessment of Urban Best Management Practices*. Metropolitan Washington Council of Governments, Washington DC.
- Schwer, C.B., and J.C. Clausen. 1989. Vegetative Filter Treatment of Dairy Milkhouse Wastewater. *Journal of Environmental Quality*, 18:446-451.
- Shabman, L. A., and S. S. Batie. 1987. Mitigating Damages from Coastal Wetlands Development: Policy, Economics and Financing. *Marine Resource Economics*, 4:227-248.
- Sharitz, R.R., and L.C. Lee. 1985. Limits on Regeneration Processes in Southeastern Riverine Wetlands. In *Proceedings Riparian Ecosystems and their Management: Reconciling Conflicting Issues*, Tucson, AZ, 16-18 April 1985, pp. 139-143. U.S. Department of Agriculture Forest Service, Rocky Mountain Forest and Range Experiment Station, Fort Collins, CO. GTR RM-120.
- Short, H.L. 1985. Management Goals and Habitat Structure. In *Proceedings Riparian Ecosystems and Their Management: Reconciling Conflicting Issues*, Tucson, AZ, 16-18 April 1985, pp. 257-262. U.S. Department of Agriculture Forest Service, Rocky Mountain Forest and Range Experiment Station, Fort Collins, CO. GTR RM-120.

- Shultze, R.F., and G.I. Wilcox. 1985. Emergency Measures for Streambank Stabilization: An Evaluation. In *Proceedings Riparian Ecosystems and their Management: Reconciling Conflicting Issues*, Tucson, AZ, 16-18 April 1985, pp. 54-58. U.S. Department of Agriculture Forest Service, Rocky Mountain Forest and Range Experiment Station, Fort Collins, CO. GTR RM-120.
- Skinner, Q.D., M.A. Smith, J.L. Dodd, and J.D. Rodgers. Undated. Reversing Desertification of Riparian Zones along Cold Desert Streams, pp. 1407-1414.
- Snoeyink, V.L., and D. Jenkins. 1980. *Water Chemistry*. John Wiley and Sons, New York, NY.
- Stabler, D.F. 1985. Increasing Summer Flow in Small Streams Through Management of Riparian Areas and Adjacent Vegetation: A Synthesis. In *Proceedings Riparian Ecosystems and their Management: Reconciling Conflicting Issues*, Tucson, AZ, 16-18 April 1985, pp. 206-210. U.S. Department of Agriculture Forest Service, Rocky Mountain Forest and Range Experiment Station, Fort Collins, CO. GTR RM-120.
- Stewardship Incentive Program. 1991. *Riparian Forest Buffer*, pp. 29-1 and 29-2.
- Stockdale, E.C. 1991. *Freshwater Wetlands, Urban Stormwater, and Nonpoint Source Pollution Control: A Literature Review and Annotated Bibliography*. Washington State Department of Ecology.
- Stuart, G., and J. Greis. 1991. *Role of Riparian Forests in Water Quality on Agricultural Watersheds*.
- Swank, G.W. 1985. Streamside Management Units in the Pacific Northwest. In *Proceedings Riparian Ecosystems and Their Management: Reconciling Conflicting Issues*, Tucson, AZ, 16-18 April 1985, pp. 435-438. U.S. Department of Agriculture Forest Service, Rocky Mountain Forest and Range Experiment Station, Fort Collins, CO. GTR RM-120.
- Swenson, E.A., and C.L. Mullins. 1985. Revegetating Riparian Trees in Southwestern Floodplains. In *Proceedings Riparian Ecosystems and their Management: Reconciling Conflicting Issues*, Tucson, AZ, 16-18 April 1985, pp. 135-138. U.S. Department of Agriculture Forest Service, Rocky Mountain Forest and Range Experiment Station, Fort Collins, CO. GTR RM-120.
- Swift, L.W., Jr. 1986. Filter Strip Widths for Forest Roads in the Southern Appalachians. *Southern Journal of Applied Forestry*, 10(1):27-34.
- Szaro, R.C., and L.F. DeBano. 1985. The Effects of Streamflow Modification on the Development of a Riparian Ecosystem. In *Proceedings Riparian Ecosystems and Their Management: Reconciling Conflicting Issues*, Tucson, AZ, 16-18 April 1985, pp. 211-215. U.S. Department of Agriculture Forest Service, Rocky Mountain Forest and Range Experiment Station, Fort Collins, CO. GTR RM-120.
- Touvila, B.J., T.H. Johengen, P.A. LaRock, J.B. Outland, D.H. Esry, and M. Franklin. 1987. An Evaluation of the Lake Jackson (Florida) Filter System and Artificial Marsh on Nutrient and Particulate Removal from Stormwater Runoff. In *Aquatic Plants for Water Treatment and Resource Recovery*.
- Triska, F.J., V.C. Kennedy, R.J. Avanzino, G.W. Zellweger, and K.E. Bencala. 1990. In Situ Retention-Transport Response to Nitrate Loading and Storm Discharge in a Third-Order Stream. *Journal of North American Benthological Society*, 9(3):229-239.
- Tsihrintzis, V.A., G. Vasarhelyi, W. Trott, and J. Lipa. 1990. Stormwater Management and Wetland Restoration: Ballona Channel Wetlands. In *Hydraulic Engineering: Volume 2, Proceedings of the 1990 National Conference*, pp. 1122-1127.
- USACE. 1990. *Anacostia River Basin Reconnaissance Study*. U.S. Army Corps of Engineers, Baltimore District.

- USDA. 1988. *Handbook of Conservation Practices*. Supplement. U.S. Department of Agriculture, Soil Conservation Service, Washington, DC.
- USDA, Forest Service. 1989. *Proceedings of the California Riparian Systems Conference, Sept. 22-24, 1988, Davis, California*, pp. 149-152.
- USDOI-BLM, New Mexico State Office. 1990. *New Mexico Riparian-Wetland 2000: A Management Strategy*. U.S. Department of the Interior, Bureau of Land Management.
- USEPA. 1988. *NWQEP 1988 Annual Report: Status of Agricultural Nonpoint Source Projects*. U.S. Environmental Protection Agency, Office of Water, Nonpoint Source Control Branch, Washington, DC. EPA 506/9-89/002.
- Vanderhayden, J. 1985. Managing Multiple Resources in Western Cascades Forest Riparian Areas: An Example. In *Proceedings Riparian Ecosystems and their Management: Reconciling Conflicting Issues*, Tucson, AZ, 16-18 April 1985, pp. 448-452. U.S. Department of Agriculture Forest Service, Rocky Mountain Forest and Range Experiment Station, Fort Collins, CO. GTR RM-120.
- Warwick, J., and A.R. Hill. 1988. Nitrate Depletion in the Riparian Zone in a Small Woodland Stream. *Hydrobiologia*, 157:231-240.
- Watson, J.T., S.C. Reed, R. Kadlec, R.L. Knight, and A.E. Whitehouse. 1988. Performance Expectations and Loading Rates for Constructed Wetlands. In paper prepared for *International Conference on Constructed Wetlands for Wastewater Treatment*, Chattanooga, TN, 13-17 June 1988.
- Whigham, D.F., C. Chitterling, and B. Palmer. 1988. Impacts of Freshwater Wetlands on Water Quality: A Landscape Perspective. *Environmental Management*, 12(5):663-671.
- Young, R.A., T. Huntrods, and W. Anderson. 1980. Effectiveness of Vegetated Buffer Strips in Controlling Pollution and Feedlot Runoff. *Journal of Environmental Quality*, 9(3):483-487.

CHAPTER 8: Monitoring and Tracking Techniques to Accompany Management Measures

I. INTRODUCTION

Section 6217(g) calls for a description of any necessary monitoring techniques to accompany the management measures to assess over time the success of the measures in reducing pollution loads and improving water quality. This chapter provides:

- (1) Guidance for measuring changes in pollution loads and in water quality that may result from the implementation of management measures and
- (2) Guidance for ensuring that management measures are implemented, inspected, and maintained properly.

Detailed guidance specific to any particular management measure or practice is contained throughout Chapters 2 through 7 as necessary.

Under section 6217, States will apply management measures to a wide range of sources, including agriculture, forestry, urban activities, marinas and recreational boating, and hydromodification. To monitor at minimum cost the success of these management measures over time, States will need to be creative in the ways that they take advantage of existing monitoring efforts and craft new or expanded monitoring programs.

Nonpoint source monitoring is generally performed by Federal, State, and local agencies. Universities, nonprofit groups, and industry also perform nonpoint source monitoring *in a range of circumstances*. The landowner, however, rarely performs nonpoint source water quality monitoring.

Section II of this chapter is directed primarily at State agencies, which will be performing or directing the greater share of water quality monitoring under section 6217. This guidance assumes that the reader has a good understanding of basic sample collection and sample analysis methods. Section II is heavily weighted toward discussions of temporal and spatial variability, statistical considerations and techniques, and experimental designs for the purpose of providing the reader with basic information that has been found to be essential in designing and conducting a successful nonpoint source monitoring program. The level of detail in this chapter varies by design to give the reader more or less information on a given subject based on EPA's experience with nonpoint source monitoring efforts over the past 10-15 years. *References are provided for those who wish to obtain additional information regarding specific topics.*

Section III of this chapter is directed primarily at State and local agencies that are responsible for tracking the implementation, operation, and maintenance of management measures. This section is not intended to provide recommendations regarding the operation and maintenance requirements for any given management measure, but is instead intended to provide "inspectors" with ideas regarding the types of evidence to seek when determining whether implementation or operation and maintenance are being performed adequately.

By tracking management measures and water quality simultaneously, States will be in a position to evaluate the performance of those management measures implemented under section 6217. Management measure tracking will provide the necessary information to determine whether pollution controls have been implemented, operated, and maintained adequately. Without this information, States will not be able to fully interpret their water quality monitoring data. For example, States cannot determine whether the management measures have been effective unless they know the extent to which these controls were implemented, maintained, and operated. Appropriately collected water quality information can be evaluated with trend analysis to determine whether pollutant loads have been

reduced or whether water quality has improved. Valid statistical associations drawn between implementation and water quality data can be used by States to indicate:

- (1) Whether management measures have been successful in improving water quality in the coastal zone and
- (2) The need for additional management measures to meet water quality objectives in the coastal zone.

II. TECHNIQUES FOR ASSESSING WATER QUALITY AND FOR ESTIMATING POLLUTION LOADS

Water quality monitoring is the most direct and defensible tool available to evaluate water quality and its response to management and other factors (Coffey and Smolen, 1990). This section describes monitoring methods that can be used to measure changes in pollutant loads and water quality. Due to the wide range of monitoring needs and environmental conditions throughout the coastal zone it is not possible to specify detailed monitoring plans that apply to all areas within the zone. The information in this section is intended merely to guide the development of monitoring efforts at the State and local levels.

This section begins with a brief discussion of the scope and nature of nonpoint source problems, followed by a discussion of monitoring objectives as they relate to section 6217. A lengthy discussion of monitoring approaches is next, with a focus on understanding the watershed to be studied, appropriate experimental designs, sample size and frequency, site locations, parameter selection, sampling methods, and quality assurance and quality control. The intent of this discussion is to provide the reader with basic information essential to the development of effective, tailored monitoring programs that will provide the necessary data for use in statistical tests that are appropriate for evaluating the success of management measures in reducing pollutant loads and improving water quality.

After a brief discussion of data needs, an overview of statistical considerations is presented. Variability and uncertainty are described first, followed by a lengthy overview of sampling and sampling designs. This discussion is at a greater level of detail than others in the section to emphasize the importance of adequate sampling within the framework of a sound experimental design. Hypothesis testing is described next, including some examples of hypotheses that may be appropriate for section 6217 monitoring efforts. An overview of data analysis techniques is given at the end of the section.

A. Nature and Scope of Nonpoint Source Problems

Nonpoint sources may generate both conventional and toxic pollutants, just as point sources do. Although nonpoint sources may contribute many of the same kinds of pollutants, these pollutants are generated in different volumes, combinations, and concentrations. Pollutants from nonpoint sources are mobilized primarily during storm events or snowmelt, but baseflow contributions can be the major source of nonpoint source contaminants in some systems. Thus, knowledge of the hydrology of a system is critical to the design of successful monitoring programs.

Nonpoint source problems are not just reflected in the chemistry of a water resource. Instead, nonpoint source problems are often more acutely manifested in the biology and habitat of the aquatic system. Such impacts include the destruction of spawning areas, impairments to the habitat for shellfish, changes to aquatic community structure, and fish mortality. Thus, any given nonpoint source monitoring program may have to include a combination of chemical, physical, and biological components to be effective.

B. Monitoring Objectives

Monitoring is usually performed in support of larger efforts such as nonpoint source pollution control programs within coastal watersheds. As such, monitoring objectives are generally established in a way that contributes toward achieving the broader program objectives. For example, program objectives may include restoring an impaired use or protecting or improving the ecological condition of a water resource. Supporting monitoring objectives, then, might include assessing trends in use support or in key biological parameters.

The following discussion identifies the overall monitoring objectives of section 6217 and gives some examples of specific objectives that may be developed at the State or local level in support of those overall objectives. Clearly, due to the prohibitive expense of monitoring the effectiveness of every management measure applied in the coastal zone, States will need to develop a strategy for using limited monitoring information to address the broad questions

regarding the effectiveness of section 6217 implementation. A combination of watershed monitoring to track the cumulative benefits of systems of management measures and demonstrations of selected management measures of key importance in the State may be one way in which the overall section 6217 monitoring objectives can be met within the constraints imposed by limited State monitoring budgets.

1. Section 6217 Objectives

The overall management objective of section 6217 is to develop and implement management measures for nonpoint source pollution to restore and protect coastal waters. The principal monitoring objective under section 6217(g) is to assess over time the success of the management measures in reducing pollution loads and improving water quality. A careful reading of this monitoring objective reveals that there are two subobjectives: (1) to assess changes in pollution loads over time and (2) to assess changes in water quality over time.

A pollutant load is determined by multiplying the total runoff volume times the average concentration of the pollutant in the runoff. Loads are typically estimated only for chemical and some physical (e.g., total suspended solids) parameters. Water quality, however, is determined on the basis of the chemical, physical, and biological conditions of the water resource. Section 6217(g), therefore, calls for a description of pollutant load estimation techniques for chemical and physical parameters, plus a description of techniques to assess water quality on the basis of chemical, physical, and biological conditions. This section focuses on those needs.

2. Formulating Monitoring Objectives

A monitoring objective should be narrowly and clearly defined to address a specific problem at an appropriate level of detail (Coffey and Smolen, 1990). Ideally, the monitoring objective specifies the primary parameter(s), location of monitoring (and perhaps the timing), the degree of causality or other relationship, and the anticipated result of the management action. The magnitude of the change may also be expressed in the objective. Example monitoring objectives include:

- To determine the change in trends in the total nitrogen concentration in Beautiful Sound due to the implementation of nutrient management on cropland in all tributary watersheds.
- To determine the sediment removal efficiency of an urban detention basin in New City.
- To evaluate the effects of improved marina management on metals loadings from the repair and maintenance areas of Stellar Marina.
- To assess the change in weekly mean total suspended solids concentrations due to forestry harvest activities in Clean River.

C. Monitoring Approaches

1. General

a. Types of Monitoring

The monitoring program design is the framework for sampling, data analysis, and the interpretation of results (Coffey and Smolen, 1990). MacDonald (1991) identifies seven types of monitoring:

- (1) Trend monitoring;
- (2) Baseline monitoring;
- (3) Implementation monitoring;
- (4) Effectiveness monitoring;
- (5) Project monitoring;

- (6) Validation monitoring; and
- (7) Compliance monitoring.

Trend, baseline, implementation, effectiveness, and project monitoring all relate to the monitoring objectives of section 6217. These types of monitoring, in fact, are not mutually exclusive. The distinction between effectiveness monitoring and project monitoring, for example, is often simply one of scale, with effectiveness monitoring primarily directed at individual practices and project monitoring directed at entire sets of practices or activities implemented over a larger area. Since one cannot evaluate the effectiveness of a project or management measure (i.e., achievement of the desired effect) without knowing the status of implementation, implementation monitoring is an essential element of both project and effectiveness monitoring. In addition, a test for trend is typically included in the evaluation of projects and management measures, and baseline monitoring is performed prior to the implementation of pollution controls.

Meals (1991a) discussed five major points to consider in developing a monitoring system that would provide a suitable data base for watershed trend detection: (1) understand the system you want to monitor, (2) design the monitoring system to meet objectives, (3) pay attention to details at the beginning, (4) monitor source activities, and (5) build in feedback loops. These five points apply equally to both load estimation and water quality assessment monitoring efforts.

b. Section 6217 Monitoring Needs

The basic monitoring objective for section 6217 is to *assess over time the success of the measures in reducing pollution loads and improving water quality*. This objective would seem to indicate a need for establishing cause-effect relationships between management measure implementation and water quality. Although desirable, monitoring to establish such cause-effect relationships is typically beyond the scope of affordable program monitoring activities.

Mosteller and Tukey (1977) identified four criteria that must be met to show cause and effect: association, consistency, responsiveness, and a mechanism.

- **Association** is shown by demonstrating a relationship between two parameters (e.g., a correlation between the extent of management measure implementation and the level of pollutant loading).
- **Consistency** can be confirmed by observation only and implies that the association holds in different populations (e.g., management measures were implemented in several areas and pollutant loading was reduced, depending on the effect of treatment, in each case).
- **Responsiveness** can be confirmed by an experiment and is shown when the dependent variable (e.g., pollutant loading) changes predictably in response to changes in the independent variable (e.g., extent of management measure implementation).
- A **mechanism** is a plausible step-by-step explanation of the statistical relationship. For example, conservation tillage reduced the edge-of-field losses of sediment, thereby removing a known fraction of pollutant source from the stream or lake. The result was decreased suspended sediment concentration in the water column.

Clearly, the cost of monitoring needed to establish cause-effect relationships throughout the coastal zone far exceeds available resources. It may be suitable, however, to document associations between management measure implementation and trends in pollutant loads or water quality and then account for such associations with a general description of the primary mechanisms that are believed to come into play.

c. Scale, Local Conditions, and Variability

There are several approaches that can be taken to assess the effectiveness of measures in reducing loads and improving water quality. There are also several levels of scale that could be selected: individual practices, individual

measures, field scale, watershed scale, basin scale, regional scale, etc. With any given monitoring objective, the specific monitoring approach to use at any specific site is a function of the local conditions (e.g., geography, climate, water resource type) and the type of management measures implemented.

The detection and estimation of trends is complicated by problems associated with the characteristics of pollution data (Gilbert, 1987). Physical, chemical, and biological parameters in the receiving water may undergo extreme changes without the influence of human activity. Understanding and monitoring the factors responsible for variability in a local system are essential for detecting the improvements expected from the implementation of management measures.

Simple point estimates taken before and after treatment will not confirm an effect if the natural variability is typically greater than the changes due to treatment (Coffey and Smolen, 1990). Therefore, knowledge of the variability and the distribution of the parameter is important for statistical testing. Greater variability requires a larger change to imply that the observed change is not due solely to random events (Spooner et al., 1987b). Examination of a historical data set can help to identify the magnitude of natural variability and possible sources.

The impact of management actions may not be detectable as a change in a mean value but rather as a change in variability (Coffey and Smolen, 1990). Platts and Nelson (1988) found that a carefully designed study was required to isolate the large natural fluctuations in trout populations to distinguish the effects of land use management. They assumed that normal fluctuation patterns were similar between the control and the treatment area and that treatment-induced effect could be distinguished as a deviation from the historical pattern.

Meals (1991a) calls for the collection and evaluation of existing data as the first step in a monitoring effort, recognizing that additional background data may be needed to identify hot spots or fill information gaps. The results of such initial efforts should include established stage-discharge ratings and an understanding of patterns not associated with the pollution control effort.

2. Understanding the System to Be Monitored

a. The Water Resource

Options for tracking water quality vary with the type of water resource. For example, a monitoring program for ephemeral streams can be different from that for perennial streams or large rivers. Lakes, wetlands, riparian zones, estuaries, and near-shore coastal waters all present different monitoring considerations. Whereas upstream-downstream designs work on rivers and streams, they are generally less effective on natural lakes where linear flow is not so prevalent. Likewise, estuaries present difficulties in monitoring loads because of the shifting flows and changing salinity caused by the tides. A successful monitoring program recognizes the unique features of the water resources involved and is structured to either adapt to those features or avoid them.

Streams. Freshwater streams can be classified on the basis of flow attributes as intermittent or perennial streams. Intermittent streams do not flow at all times and serve as conveyance systems for runoff. Perennial streams always flow and usually have significant inputs from ground water or interflow.

For intermittent streams, seasonal variability is a very significant factor in determining pollutant loads and water quality. During some periods sampling may be impossible due to no flow. Seasonal flow variability in perennial streams can be caused by seasonal patterns in precipitation or snowmelt, reservoir discharges, or irrigation practices.

For many streams the greatest concentrations of suspended sediment and other pollutants occur during spring runoff or snowmelt periods. Concentrations of both particulate and soluble chemical parameters have been shown to vary throughout the course of a rainfall event in many studies across the Nation. This short-term variability should be considered in developing monitoring programs for flowing (lotic) waterbodies.

Spatial variability is largely lateral for both intermittent and perennial streams. Vertical variability does exist, however, and can be very important in both stream types (e.g., during runoff events, in tidal waters, and in deep,

slow-moving streams). Intake depth is often a key factor in stream sampling. For example, slow-moving, larger streams may show considerable water quality variability with depth, particularly for parameters such as suspended solids, dissolved oxygen, and algal productivity. Suspended sediment samples must be taken with an understanding of the vertical distribution of both sediment concentration and flow velocity (Brakensiek et al., 1979). When sampling bed sediment or monitoring biological parameters, it is important to recognize the potential for significant lateral and vertical variation in the toxicity and contaminant levels of bed sediments (USEPA, 1987).

Lakes. Lakes can be categorized in several ways, but a useful grouping for monitoring guidance is related to the extent of vertical and lateral mixing of the waterbody. Therefore, lakes are considered to be either mixed or stratified for the purpose of this guidance. Mixed lakes are those lakes in which water quality (as determined by measurement of the parameters and attributes of interest) is homogenous throughout, and stratified lakes are considered to be those lakes which have lateral or vertical water quality differentials in the lake parameters and attributes of interest. Totally mixed lakes, if they exist, are certainly few in number, but it may be useful to perform monitoring in selected homogenous portions of stratified lakes to simplify data interpretation. Similarly, for lakes that exhibit significant seasonal mixing, it may be beneficial to monitor during a time period in which they are mixed. For some monitoring objectives, however, it may be best to monitor during periods of peak stratification.

Temporal variability concerns are similar for mixed and stratified lakes. Seasonal changes are often obvious, but should not be assumed to be similar for all lakes or even the same for different parts of any individual lake. Due to the importance of factors such as precipitation characteristics, climate, lake basin morphology, and hydraulic retention characteristics, seasonal variability should be at least qualitatively assessed before any lake monitoring program is initiated.

Short-term variability is also an inherent characteristic of most still (lentic) waterbodies. Parameters such as pH, dissolved oxygen, and temperature can vary considerably over the course of a day. Monitoring programs targeted toward biological parameters should be structured to account for this short-term variability. It is often the case that small lakes and reservoirs respond rapidly to runoff events. This factor can be very important in cases where lake water quality will be correlated to land treatment activities or stream water quality.

In stratified lakes spatial variability can be lateral or vertical. The classic stratified lake is one in which there is an epilimnion and a hypolimnion (Wetzel, 1975). Water quality can vary considerably between the two strata, so sampling depth is an important consideration when monitoring vertically stratified lakes.

Lateral variability is probably as common as vertical variability, particularly in lakes and ponds receiving inflow of varying quality. Figure 8-1 illustrates the types of factors that contribute to lateral variability in lake water quality. In reservoir systems, storm plumes can cause significant lateral variability.

Davenport and Kelly (1984) explained the lateral variability in chlorophyll *a* concentrations in an Illinois lake based on water depth and the time period that phytoplankters spend in the photic zone. A horizontal gradient of sediment, nutrient, and chlorophyll *a* concentrations in St. Albans Bay, Vermont, was related to mixing between Lake Champlain and the Bay (Clausen, 1985). It is important to note that there frequently exists significant lateral and vertical variation in the toxicity and contaminant levels of bed sediments (USEPA, 1987).

Despite the distinction made between mixed and stratified lakes, there is considerable gray area between these groups. For example, thermally stratified lakes may be assumed to be mixed during periods of overturn, and laterally stratified lakes can sometimes be treated as if the different lateral segments are sublakes. In any case, it is important that the monitoring team knows what parcel of water is being sampled when the program is implemented. It would be inappropriate, for example, to assign the attributes of a surface sample to the hypolimnion of a stratified lake due to the differences in temperature and other parameters between the upper and lower waters.

Estuaries. Estuaries can be very complex systems, particularly large ones such as the Chesapeake Bay. Estuaries exhibit temporal and spatial variability just as streams and lakes do. Physically, the major differences between estuaries and fresh waterbodies are related to the mixing of fresh water with salt water and the influence of tides. These factors increase the complexity of spatial and temporal variability within an estuary.

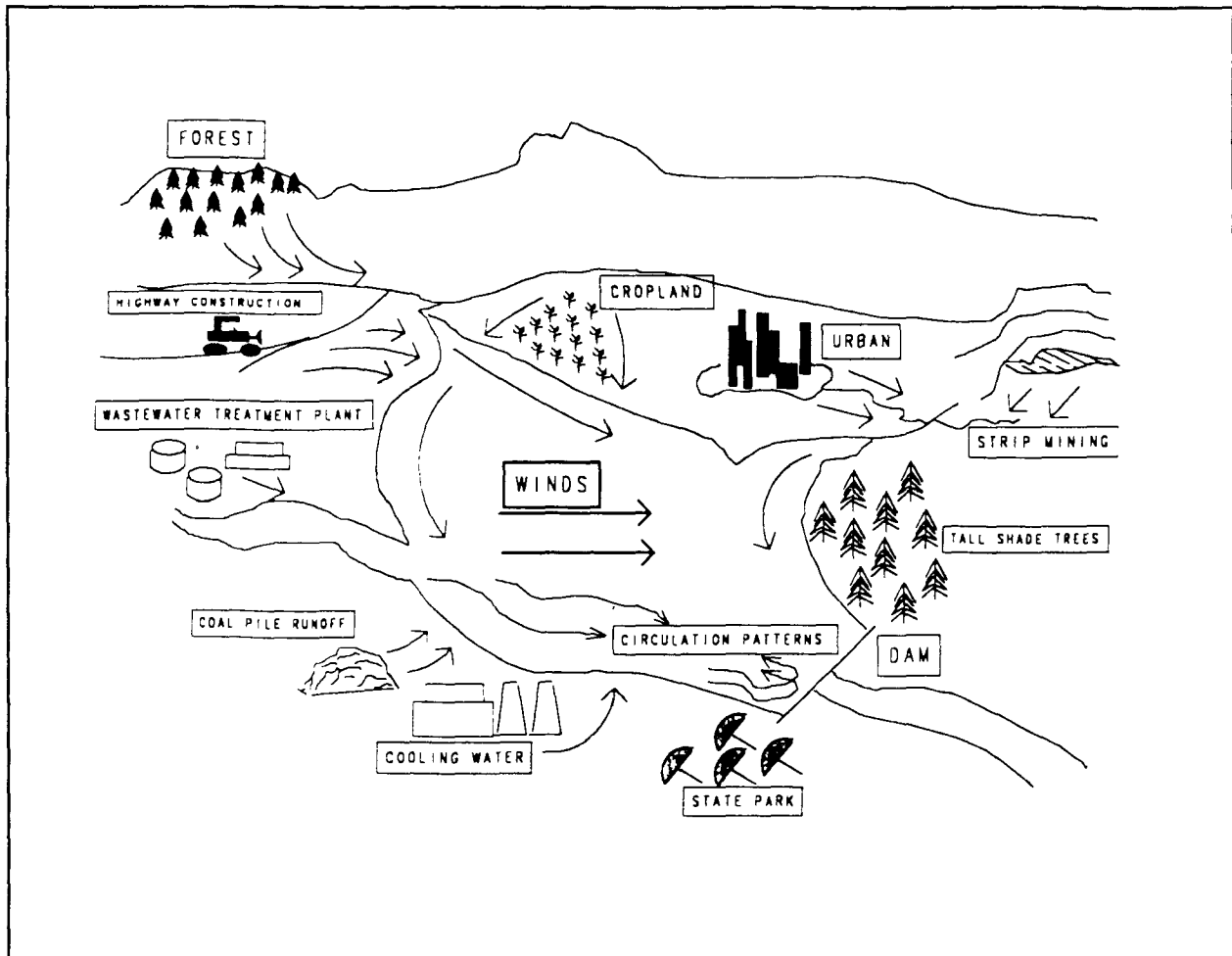

Figure 8-1. Factors contributing to lateral differences in lake quality.

Short-term variability in estuaries is related directly to the tidal cycles, which can have an effect on both the mixing of the fresh and saline waters and the position of the freshwater-saltwater interface (USEPA, 1982a). The same considerations made for lakes regarding short-term variability of parameters such as temperature, dissolved oxygen, and pH should also be made for estuaries.

Temperature profiles such as those found in stratified lakes can also change with season in estuaries. The resulting circulation dynamics must be considered when developing monitoring programs. The effects of season on the quantity of freshwater runoff to an estuary can be profound. In the Chesapeake Bay, for example, salinity is generally lower in the spring and higher in the fall due to the changes in freshwater runoff from such sources as snowmelt runoff and rainfall (USEPA, 1982a).

Spatial variability in estuaries has both significant vertical and lateral components. The vertical variability is related to both temperature and chemical differentials. In the Chesapeake Bay thermal stratification occurs during the summer, and chemical stratification occurs at all times, but in different areas at different times (USEPA, 1982a). Chemical stratification can be the result of the saltwater wedge flowing into and under the freshwater outflow or the accumulation or channeling of freshwater and saltwater flows to opposite shores of the estuary. The latter situation can be caused by a combination of tributary location, the earth's rotation, and the barometric pressure. In addition, lateral variability in salinity can be caused by different levels of mixing between saltwater and freshwater inputs. As noted for streams and lakes, the lateral and vertical variation in the toxicity and contaminant levels of bed sediments should be considered (EPA, 1987).

Coastal Waters. Researchers and government agencies are collectively devoid of significant experience in evaluating the effectiveness of nonpoint source pollution control efforts through the monitoring of near-shore and off-shore coastal waters. Our understanding of the factors to consider when performing such monitoring is therefore very limited.

As for other waterbody types, it is important to understand the hydrology, chemistry, and biology of the system in order to develop an effective monitoring program. Of particular importance is the ability to identify discrete populations to sample from. For trend analysis it is essential that the researcher is able to track over time the conditions of a clearly identifiable segment or unit of coastal water. This may be accomplished by monitoring a semienclosed near-shore embayment or similar system. Knowledge of salinity and circulation patterns should be useful in identifying such areas.

Secondly, monitoring should be focused on those segments or units of coastal water for which there is a reasonable likelihood that changes in water quality will result from the implementation of management measures. Segment size, circulation patterns, and freshwater inflows should be considered when estimating the chances for such water quality improvements.

Near-shore coastal waters may exhibit salinity gradients similar to those of estuaries due to the mixing of fresh water with salt water. Currents and circulation patterns can create temperature gradients as well. Farther from shore, salinity gradients are less likely, but gradients in temperature may occur. In addition, vertical gradients in temperature and light may be significant. These and other biological, chemical, and physical factors should be considered in the development of monitoring programs for coastal waters.

b. The Management Measures to Be Implemented

An integral part of the system to be monitored is the set of management measures to be implemented. Management measures can generally be classified with respect to their modes of control: (1) source reduction, (2) delivery reduction, or (3) the reduction of direct impacts. For example, source-reduction measures may include nutrient management, pesticide management, and marine pump-out facilities. These measures all rely on the prevention of nonpoint source pollution; trapping and treatment mechanisms are not relied upon for control. Delivery-reduction measures include those that rely on detention basins, filter strips, constructed wetlands, and similar practices for trapping or treatment prior to release or discharge to receiving waters. Measures that reduce direct impacts include wetland and riparian area protection, habitat protection, the preservation of natural stream channel characteristics, the provision of fish passage, and the provision of suitable dissolved oxygen levels below dams.

Delivery Reduction. Delivery-reduction measures lend themselves to inflow-outflow, or process, monitoring to estimate the effectiveness in reducing loads. The simple experimental approach is to take samples of inflow and outflow at appropriate time intervals to measure differences in the water quality between the two points. An example is the analysis of totals suspended solids (TSS) concentrations at the inflow and outflow of a sediment retention basin to determine the percentage of TSS removed.

Source Reduction. Source-reduction measures generally cannot be monitored using a process design because there are usually no discrete inflow and outflow points. The effectiveness of these measures will generally be determined by applying approaches such as paired-watershed studies and upstream-downstream studies.

Reduction of Direct Impacts. The effectiveness of measures intended to prevent direct impacts cannot be determined through the monitoring of loads since pollutant loads are not generated. Instead, monitoring might include reference site approaches where the conditions (e.g., habitat or macroinvertebrates) at the affected (or potentially affected) area are compared over time (as management measures are implemented) versus conditions at a representative unimpacted site or sites nearby (Ohio EPA, 1988). This approach can be taken to the point of being a paired-watershed study if the monitoring timing and protocols are the same at the impacted and reference sites.

Combinations of Management Measures. Management measures are systems of practices, technologies, processes, siting criteria, operating methods, or other alternatives. Pollution control programs generally consist of systems of

management measures applied over well-defined geographic areas. Combinations of the three types of measures described above are likely to be found in any given area to be monitored. Monitoring programs, therefore, must often be directed at measuring the cumulative effectiveness of a range of different measures applied in different areas at different times within a specified geographic area. Under these conditions, the monitoring approaches for source-reduction and direct-impact-reduction measures are typically used, while process monitoring is not generally used other than to track the effectiveness of specific delivery-reduction measures implemented in the area.

c. Point Sources and Other Significant Activities

There is often a need to isolate the effects of other activities that occur independently of the planned implementation of management measures but that have an effect on the measured parameters. For example, an upgrade from secondary to tertiary treatment at a wastewater treatment plant in a watershed could have a major effect on the measured nitrogen levels. An effective monitoring program would isolate the effects of changes in the point source contributions by measuring the discharge from these sources over time.

3. Experimental Design

a. Types of Experimental Designs

EPA has prescribed monitoring designs for use in watershed projects funded under section 319 of the Clean Water Act (USEPA, 1991b). The objective in promoting these designs is to document changes in water quality that can be related to the implementation of nonpoint source control measures in selected watersheds. The designs recommended by EPA are paired-watershed designs and upstream-downstream designs. Single downstream station designs are not recommended by EPA for section 319 watershed projects (USEPA, 1991b).

Monitoring before implementation is usually required to detect a trend or show causality (Coffey and Smolen, 1990). Two years of pre-implementation monitoring are typically needed to establish an adequate baseline. Less time may be needed for studies at the management measure or edge-of-field scale, when hydrologic variability is known to be less than that of typical agricultural systems, or when a paired-watershed design is used.

Paired-Watershed Design. In the paired-watershed design there is one watershed where the level of implementation (ideally) does not change (the control watershed) and a second watershed where implementation occurs (the study watershed). This design has been shown in agricultural nonpoint source studies to be the most powerful study design for demonstrating the effectiveness of nonpoint source control practice implementation (Spooner et al., 1985). Paired-watershed designs have a long history of application in forest hydrology studies. The paired-watershed design must be implemented properly, however, to generate useful data sets. Some of the considerations to be made in designing and implementing paired-watershed studies are described below.

In selecting watershed pairs, the watersheds should be as similar as possible in size, shape, aspect, slope, elevation, soil type, climate, and vegetative cover (Striffler, 1965). The general procedure for paired-watershed studies is to monitor the watersheds long enough to establish a statistical relationship between them. A correlation should be found between the values of the monitored parameters for the two watersheds. For example, the total nitrogen values in the control watershed should be correlated with the total nitrogen values in the study watershed. A pair of watersheds may be considered sufficiently calibrated when a parameter for the control watershed can be used to predict the corresponding value for the study watershed (or vice versa) within an acceptable margin of error.

It is important to note that the calibration period should cover all or the significant portion of the range of conditions for each of the major water quality determinants in the two watersheds. For example, the full range of hydrologic conditions should be covered (or nearly covered) during the calibration period. This may be problematic in areas where rainfall and snowmelt are highly variable from year to year or in areas subject to extended wet periods or drought. Calibration during a dry year is likely to not be adequate for establishing the relationship between the two watersheds, particularly if subsequent years include both wet and dry periods.

Similarly, some agricultural areas of the country use long-term, multiple-crop rotations. The calibration period should cover not only the range of hydrologic conditions but also the range of cropping patterns that can reasonably be expected to have an influence on the measured water quality parameters. This is not to say that the calibration period should take 5 to 10 years, but rather that States should use careful judgment in determining when the calibration period can be safely ended.

After calibration, the study watershed receives implementation of management measures, and monitoring is continued in both watersheds. The effects of the management measures are evaluated by testing for a change in the relationship between the monitored parameters (i.e., a change in the correlation). If treatment is working, then there should be a greater difference over time between the treated study watershed and the untreated (poorly managed) control watershed. Alternatively, the calibration period could be used to establish statistical relationships between a fully treated watershed (control watershed) and an untreated watershed (study watershed). After calibration under this approach, the study watershed would be treated and monitoring continued. The effects of the management measures would be evaluated, however, by testing for a change in the correlation that would indicate that the two watersheds are more similar than before treatment.

It is important to use small watersheds when performing paired-watershed studies since they are more easily managed and more likely to be uniform (Striffler, 1965). EPA recommends that paired watersheds be no larger than 5,000 acres (USEPA, 1991b).

Upstream-Downstream Studies. In the upstream-downstream design, there is one station at a point directly upstream from the area where implementation of management measures will occur and a second station directly downstream from that area. Upstream-downstream designs are generally more useful for documenting the magnitude of a nonpoint source than for documenting the effectiveness of nonpoint source control measures (Spooner et al., 1985), but they have been used successfully for the latter. This design provides for the opportunity to account for covariates (e.g., an upstream pollutant concentration that is correlated with a downstream concentration of same pollutant) in statistical analyses and is therefore the design that EPA recommends in cases where paired watersheds cannot be established (USEPA, 1991b).

Upstream-downstream designs are needed in cases where project areas are not located in headwaters or where upstream activities that are expected to confound the analysis of downstream data occur. For example, the effects of upstream point source discharges, uncontrolled nonpoint source discharges, and upstream flow regulation can be isolated with upstream-downstream designs.

Inflow-Outflow Design. Inflow-outflow, or process, designs are very similar to upstream-downstream designs. The major differences are scale and the significance of confounding activities. Process designs are generally applied in studies of individual management measures or practices. For example, sediment loading at the inflow and outflow of a detention basin may be measured to determine the pollutant removal efficiency of the basin. In general, no inputs other than the inflow are present, and the only factor affecting outflow is the management measure. As noted above (see The Management Measures to Be Implemented), process monitoring cannot generally be applied to studies of source-reduction management measures or measures that prevent direct impacts, but it can be applied successfully in the evaluation of delivery-reduction management measures.

b. Scale

Management Measure. Monitoring the inflow and outflow of a specific management measure should be the most sensitive scale since the effects of uncontrollable discharges and uncertainties in treatment mechanisms are minimized.

Edge of Field. Monitoring pollutant load from a single-field watershed should be the next most sensitive scale since the direct effects of implementation can be detected without pollutant trapping in a field border or stream channel (Coffey and Smolen, 1990).

Subwatershed. Monitoring a subwatershed can be useful to monitor the aggregate effect of implementation on a group of fields or smaller areas by taking samples close to the treatment (Coffey and Smolen, 1990). Subwatershed monitoring networks measure the aggregate effects of treatment and nontreatment runoff as it enters an upgradient tributary or the receiving waterbody. Subwatershed monitoring can also be used for targeting critical areas.

Watershed. Monitoring at the watershed scale is appropriate for assessing total project area pollutant load using a single station (Coffey and Smolen, 1990). Depending on station arrangement, both subwatershed and watershed outlet studies are very useful for water and pollutant budget determinations. Monitoring at the watershed outlet is the least sensitive of the spatial scales for detecting treatment effect. Sensitivity of the monitoring program decreases with increased basin size and decreased treatment extent or both (Coffey and Smolen, 1990).

c. Reference Systems and Standards

EPA's rapid bioassessment protocols advocate an integrated assessment, comparing habitat and biological measures with empirically defined reference conditions (Plafkin et al., 1989). Reference conditions are established through systematic monitoring of actual sites that represent the natural range of variation in "least disturbed" water chemistry, habitat, and biological condition. Reference sites can be used in monitoring programs to establish reasonable expectations for biological, chemistry, and habitat conditions. An example application of this concept is the paired-watershed design (Coffey and Smolen, 1990).

EPA's ecoregional framework can be used to establish a logical basis for characterizing ranges of ecosystem conditions or quality that are realistically attainable (Omernik and Gallant, 1986). *Ecoregions* are defined by EPA to be regions of relative homogeneity in ecological systems or in relationships between organisms and their environments. Hughes et al. (1986) have used a relatively small number of minimally impacted regional reference sites to assess feasible but protective biological goals for an entire region.

Water quality standards can be used to identify criteria that serve as reference values for biological, chemical, or habitat parameters, depending on the content of the standard. The frequency distribution of observation values can be tracked against either a water quality standard criterion or a reference value as a method for measuring trends in water quality or loads (USEPA, 1991b).

4. Site Locations

Within any given budget, site location is a function of water resource type (see *The Water Resource*), monitoring objectives (see *Monitoring Objectives*), experimental design (see *Types of Experimental Designs*), the parameters to be monitored (see *Parameter Selection*), sampling techniques (see *Sampling Techniques and Samples and Sampling*), and data analysis plans (see *Data Analysis*). Additional considerations in site selection are accessibility and landowner cooperation.

It is recommended that monitoring stations be placed near established gaging stations whenever possible due to the extreme importance of obtaining accurate discharge measurements. Where gaging stations are not available but stream discharge measurements are needed, care should be taken to select a suitable site. Brakensiek et al. (1979) provide excellent guidance regarding runoff measurement, including the following selected recommendations regarding site selection:

- Field-calibrated gaging stations should be located in straight, uniform reaches of channel having smooth beds and banks of a permanent nature whenever possible.
- Gaging stations should be located away from sewage outfall, power stations, or other installations causing flow disturbances.
- Consider the geology and contributions of ground-water flow.

- Where ice is a potential problem, locate measuring devices in a protected area that receives sunlight most of the time.
- Daily current-meter measurements may be necessary where sand shifts occur.

5. Sampling Frequency and Interval

a. Sample Size and Frequency

It is important to estimate early in a monitoring effort the number and frequency of samples required to meet the monitoring objectives. Spooner et al. (1991) report that the sampling frequency required at a given monitoring station is a function of the following:

- Monitoring goals;
- Response of the water resource to changes in pollutant sources;
- Magnitude of the minimum amount of change for which detection with trend analyses is desired (i.e., minimum detectable change);
- System variability and accuracy of the sample estimate of reported statistical parameter (e.g., confidence interval width on a mean or trend estimate);
- Statistical power (i.e., probability of detecting a true trend);
- Autocorrelation (i.e., the extent to which data points taken over time are correlated);
- Monitoring record length;
- Number of monitoring stations; and
- Statistical methods used to analyze the data.

The minimum detectable change (MDC) is the minimum change in a water quality parameter over time that is considered statistically significant. Knowledge of the MDC can be very useful in the planning of an effective monitoring program (Coffey and Smolen, 1990). The MDC can be estimated from historical records to aid in determining the required sampling frequency and to evaluate monitoring feasibility (Spooner et al., 1987a). MacDonald (1991) discusses the same concept, referring to it as the minimum detectable effect.

The larger the MDC, the greater the change in water quality that is needed to ensure that the change was not just a random fluctuation. The MDC may be reduced by accounting for covariates, increasing the number of samples per year, and increasing the number of years of monitoring.

Sherwani and Moreau (1975) stated that the desired frequency of sampling is a function of several considerations associated with the system to be studied, including:

- Response time of the system;
- Expected variability of the parameter;
- Half-life and response time of constituents;
- Seasonal fluctuation and random effects;

- Representativeness under different conditions of flow;
- Short-term pollution events;
- Magnitude of response; and
- Variability of the inputs.

Coastal waters, estuaries, ground water, and lakes will typically have longer response times than streams and rivers. Thus, sampling frequency will usually be greater for streams and rivers than for other water resource types. Some parameters such as total suspended solids and fecal coliform bacteria can be highly variable in stream systems dominated by nonpoint sources, while nitrate levels may be less volatile in systems driven by baseflow from ground water. The highly variable parameters would generally require more frequent sampling, but parameter variability should be evaluated on a site-specific basis rather than by rule of thumb.

In cases where pollution events are relatively brief, sampling periods may also be short. For example, to determine pollutant loads it may be necessary to sample frequently during a few major storm events and infrequently during baseflow conditions. Some parameters vary considerably with season, particularly in watersheds impacted primarily by nonpoint sources. Boating is typically a seasonal activity in northern climates, so intensive seasonal monitoring may be needed to evaluate the effectiveness of management measures for marinas.

The water quality response to implementation of management measures will vary considerably across the coastal zone. Pollutant loads from confined livestock operations may decline significantly in response to major improvements in runoff and nutrient management, while sediment delivery from logging areas may decline only a little if the level of pollution control prior to section 6217 implementation was already fairly good. Fewer samples will usually be needed to document water quality improvement in watersheds that are more responsive to pollution control efforts.

Sherwani and Moreau (1975) state that for a given confidence level and margin of error, the necessary sample size, and hence sampling frequency, is proportional to the variance. Since the variance of water quality parameters may differ considerably over time, the frequency requirements of a monitoring program may vary depending on the time of the year. Sampling frequency will need to be greater during periods of greater variance.

There are statistical methods for estimating the number of samples required to achieve a desired level of precision in random sampling (Cochran, 1963), stratified random sampling (Reckhow, 1979), cluster sampling (Cochran, 1977), multistage sampling (Gilbert, 1987), double sampling (Gilbert, 1987), and systematic sampling (Gilbert, 1987). For a more detailed discussion of sampling theory and statistics, see *Samples and Sampling*.

b. Sampling Interval

A method for estimating sampling interval is provided by Sherwani and Moreau (1975). They note that the least favorable sampling interval for parameters that exhibit a periodic structure is equal to the period or an integral multiple of the period. Such sampling would introduce statistical bias. Reckhow (1979) points out that, for both random and stratified random sampling, systematic sampling is acceptable only if "there is no bias introduced by incomplete design, and if there is no periodic variation in the characteristic measured." Gaugush (1986) states that monthly sampling is usually adequate to detect the annual pattern of changes with time.

c. Some Recommendations

It is generally recommended that the sampling of plankton, fish, and benthic organisms in estuaries should be seasonal, with the same season sampled in multiyear studies (USEPA, 1991a). The aerial coverage and bed density for submerged aquatic vegetation (SAV) vary from year to year due to catastrophic storms, exceptionally high precipitation and turbidity, and other poorly understood natural phenomena (USEPA, 1991a). For this reason, short-term SAV monitoring may be more reflective of infrequent impacts and may not be useful for trend assessment.

In addition, incremental losses in wetland acreage are now within the margin of error for current detection limits. It is recommended that SAV and wetland sampling be conducted during the period of peak biomass (USEPA, 1991a).

The frequency of sediment sampling in estuaries should be related to the expected rate of change in sediment contaminant concentrations (USEPA, 1991a). Because tidal and seasonal variability in the distribution and magnitude of several water column physical characteristics in estuaries is typically observed, these influences should be accounted for in the development of sampling strategies (USEPA, 1991a).

For monitoring the state of biological variables, the length of the life cycle may determine the sampling interval (Coffey and Smolen, 1990). EPA (1991b) recommends a minimum of 20 evenly spaced (e.g., weekly) samples per year to document trends in chemical constituents in watershed studies lasting 5 to 10 years. The 20 samples should be taken during the time period (e.g., season) when the benefits of implemented pollution control measures are most likely to be observed. For benthic macroinvertebrates and fish, EPA recommends at least one sample per year.

6. Load Versus Water Quality Status Monitoring

The choice between monitoring either (a) the status or condition of the water resource or (b) the pollutant load to the water resource should be made carefully (Coffey and Smolen, 1990). Loading is the rate of pollutant transport to the managed resource via overland, tributary, or ground-water flow. Load monitoring may be used to assess the change in magnitude of major pollutant sources or to assess the change in pollutant export at a fixed station. Monitoring water quality status includes measuring a physical attribute, chemical concentration, or biological condition, and may be used to assess baseline conditions, trends, or the impact of treatment on the managed resource.

Monitoring water quality status may be the most direct route to an answer on the effect of management measure implementation on designated use, but sensitivity may be low (Coffey and Smolen, 1990). When the likelihood of detecting a trend in water quality status is low, load monitoring near the source may be necessary. For example, measuring the effectiveness of nutrient management in one tributary to a large coastal embayment may require monitoring nitrogen load, since bay monitoring is unlikely to measure the change in the mean nitrogen concentration or trophic state measures for the bay.

When the basis for a choice between load or water quality status is less obvious (i.e., it is not clear whether abatement can be detected in the receiving resource), a pollutant budget may help to make the decision (Coffey and Smolen, 1990). The budget should account for mass balance of pollutant input by source, including ground-water and atmospheric deposition, all output, and changes in storage. The budget may show the magnitude and relative importance of controlled and uncontrolled sources (e.g., atmospheric deposition, resuspension from sediments, streambank erosion). Sources of error in the budget should also be evaluated. Where treatment is not likely to produce measurable change in the waterbody, load monitoring may be required.

a. Pollutant Load Monitoring

Load monitoring requires a complex, and typically expensive, sampling protocol to measure water discharge and pollutant concentration (Coffey and Smolen, 1990). Both discharge and concentration data are needed to calculate pollutant loading.

Given the variability of discharge and pollutant concentrations in watersheds impacted by nonpoint sources, the consequences of not collecting data from all storm events and baseflow over a range of conditions (e.g., season, land cover) can be major. For example, equipment failure during a single storm event can result in considerable error in estimating annual pollutant load. It is typical that data gaps will occur, requiring the application of mathematical techniques to estimate the discharge and pollutant concentrations for missed events.

Brakensiek et al. (1979) provide a detailed description of methods and equipment needed for discharge monitoring. Techniques are described for both field and watershed studies.

b. Water Quality Status Monitoring

Water quality status can be evaluated in a number of ways, including:

- Evaluating designated use attainment;
- Evaluating standards violations;
- Assessing ecological integrity; or
- Monitoring an indicator parameter.

Monitoring for designated use attainment should focus on those parameters or criteria specified in State water quality standards. Where such parameters or criteria are not specified, critical variables related to use support should be monitored. If the monitoring objective includes relating water quality improvement to the pollution control activities, then it is important that monitored parameters can be related to the management measures implemented. For example, it may be appropriate to monitor nitrogen concentrations if septic system improvements are implemented.

For violations of standards, the choice of variable is specified by the State water quality standard (Coffey and Smolen, 1990). To assess ecological integrity, the selection of parameters should be based on criteria used to evaluate such status. For trend detection the indicator parameter must be carefully selected to account for changes in treatment and system variability (Coffey and Smolen, 1990). Additional information regarding appropriate parameters to monitor can be found under Parameter Selection below.

7. Parameter Selection

Monitoring parameters should be related directly to the identified problems caused by the nonpoint sources that will be controlled, and to those principal pollutants that will be controlled through the implementation of management measures. For example, if metal loads are to be determined to be the primary pollutant of concern from marinas, then appropriate monitoring parameters will include flow and the metals of concern. If the effectiveness of improved management of repair and maintenance areas is to be determined, then implementation should be tracked as well. There should also be a mechanism for relating the management measure to the specific pollutants monitored. For example, it should be clear that improved management of repair and maintenance areas of a marina will have an effect on metals loads if such loads are monitored.

a. Relationship to Sources

MacDonald (1991) evaluates the sensitivity of various monitoring parameters to a range of management activities in forested areas in the Pacific Northwest and Alaska. Table 8-1 provides examples of parameters that could be monitored to determine the effectiveness of management measures. Some of the listed parameters (e.g., benthic macroinvertebrates) can be sampled only in waterbodies, while others (e.g., total suspended solids) can be sampled at the source or in waterbodies. This table is provided for illustrative purposes only.

b. Implementation Tracking

Land treatment and land use monitoring should relate directly to the pollutants or impacts monitored at the water quality station (Coffey and Smolen, 1990). Land use monitoring should also reflect historical impacts as well as activities during the project. Since the impact of management measures on water quality may not be immediate or implementation may not be sustained, information on relevant watershed activities will be essential for the final analysis.

EPA recommends that the reporting units used to track implementation should be reliable indicators of the extent to which the pollutant source will be controlled (USEPA, 1991b). For example, the tons of animal waste managed may be a much more useful parameter to track than the number of confined animal facilities constructed.

Table 8-1. Examples of Monitoring Parameters to Assess Impacts from Selected Sources

Source	Chemical and Physical	Biological	Habitat
Cropland	Sediment, nutrients, pesticides, temperature	Benthic macroinvertebrates	Sediment deposition, cover
Grazing Land	Nutrients, sediment, temperature	Macroinvertebrates, fish, fecal coliform	Streambank stability, spawning bed condition, cover
Urban Construction Sites	Total suspended solids, temperature	Benthic macroinvertebrates	Streambank stability, channel characteristics, cover
Highways	Metals, toxics, flow, temperature	Benthic macroinvertebrates	Channel characteristics, cover
Forestry Harvest	Sediment, temperature	Benthic macroinvertebrates	Large woody debris, cover
Forestry Road Building and Maintenance	Sediment, intergravel dissolved oxygen, temperature	Fish, benthic macroinvertebrates	Channel characteristics, embeddedness, streambank stability, cover
Marinas	Metals, dissolved oxygen, temperature	Fecal coliform	Marsh vegetation, substrate composition, cover
Channelization	Flows, temperature, sediment	Fish, benthic macroinvertebrates	Aquatic vegetation, channel sediment type, cover

c. Explanatory Variables

An effective nonpoint source monitoring program accounts for as many sources of variability as possible to increase the likelihood that the effects of the management measures can be separated from the other sources of variability. Some of this other variability can be accounted for by tracking the parameters (e.g., precipitation, flow, pH, salinity) most likely to affect the values of the principal monitored parameters (Coffey and Smolen, 1990). These explanatory variables are treated as covariates in statistical analyses that isolate the effect of the management measures from the variability, or noise, in the data caused by natural factors. In paired-watershed and upstream-downstream studies, EPA recommends that the complete set of parameters (including explanatory variables) are monitored at each monitoring site, following the same monitoring schedule and protocol (USEPA, 1991b).

8. Sampling Techniques

a. Automated Sampling to Estimate Pollutant Loads

Typical methods for estimating pollutant loads include continuous flow measurements and some form of automated sampling that is either timed or triggered by some feature of the runoff hydrograph. For example, in the Santa Clara watershed of San Francisco Bay, flow was continuously monitored at hourly intervals, wet-weather monitoring

included collection of flow-composite samples taken with automatic samplers, and dry-weather monitoring was conducted by obtaining quarterly grab samples (Mumley, 1991). Data were used to estimate annual, wet-weather, and dry-weather copper loads.

In St. Albans Bay, Vermont, continuous flow and composite samples were used to estimate nutrient loads for trend analysis (Vermont RCWP, 1984). In the Nationwide Urban Runoff Program (NURP) project in Bellevue, Washington, catchment area monitoring included continuous gaging and automatic sampling that occurred at a preset time interval (5 to 50 minutes) once the stage exceeded a preset threshold (USEPA, 1982b).

b. Grab Sampling for Pollutant Loads

Grab sampling with continuous discharge gaging can be used to estimate load in some cases. Grab sampling is usually much less expensive than automated sampling methods and is typically much simpler to manage. These significant factors of cost and ease make grab sampling an attractive alternative to automated sampling and therefore worthy of consideration even for monitoring programs with the objective of estimating pollutant loads.

Grab sampling should be carefully evaluated to determine its applicability for each monitoring situation (Coffey and Smolen, 1990). Nonpoint source pollutant concentrations generally increase with discharge. For a system with potentially lower variability in discharge, such as irrigation, grab sampling may be a suitable sampling method for estimating loads (Coffey and Smolen, 1990). Grab sampling may also be appropriate for systems in which the distribution of annual loading occurs over an extended period of several months, rather than a few events. In addition, grab sampling may be used to monitor low flows and background concentrations.

For systems exhibiting high variability in discharge or where the majority of the pollutant load is transported by a few events (such as snowmelt in some northern temperate regions), however, grab sampling is not recommended.

c. Habitat Sampling

EPA recommends a procedure for assessing habitat quality where all of the habitat parameters are related to overall aquatic life use support and are a potential source of limitation to the aquatic biota (Plafkin et al., 1989). In this procedure, EPA begins with a survey of physical characteristics and water quality at the site. Such physical factors as land use, erosion, potential nonpoint sources, stream width, stream depth, stream velocity, channelization, and canopy cover are addressed. In addition, water quality parameters such as temperature, dissolved oxygen, pH, conductivity, stream type, odors, and turbidity are observed.

Then, EPA follows with the habitat assessment, which includes a range of parameters that are weighted to emphasize the most biologically significant parameters (Plafkin et al., 1989). The procedure includes three levels of habitat parameters. The primary parameters are those that characterize the stream "microscale" habitat and have the greatest direct influence on the structure of the indigenous communities. These parameters include characterization of the bottom substrate and available cover, estimation of embeddedness, and estimation of the flow or velocity and depth regime. Secondary parameters measure the "macroscale" and include such parameters as channel alteration, bottom scouring and deposition, and stream sinuosity. Tertiary parameters include bank stability, bank vegetation, and streamside cover.

MacDonald (1991) discusses a wide range of channel characteristics and riparian parameters that can be monitored to evaluate the effects of forestry activities on streams in the Pacific Northwest and Alaska. MacDonald states that "stream channel characteristics may be advantageous for monitoring because their temporal variability is relatively low, and direct links can be made between observed changes and some key designated uses such as coldwater fisheries." He notes, however, that "general recommendations are difficult because relatively few studies have used channel characteristics as the primary parameters for monitoring management impacts on streams."

On the other hand, MacDonald concludes that the documented effects of management activities on the stability and vegetation of riparian zones, and the established linkages between the riparian zone and various designated uses, provide the rationale for including the width of riparian canopy opening and riparian vegetation as recommended

monitoring parameters. Riparian canopy opening is measured and tracked through a historical sequence of aerial photographs (MacDonald, 1991). Riparian vegetation is measured using a range of methods, including qualitative measures of vegetation type, visual estimations of vegetation cover, quantitative estimations of vegetation cover using point- or line-intercept methods, light intensity measurements to estimate forest cover density, stream shading estimates using a spherical densiometer, and estimates of vegetation density based on plot measurements.

Habitat variables to monitor grazing impacts include areas covered with vegetation and bare soil, stream width, stream channel and streambank stability, and width and area of the riparian zone (Platts et al., 1987). Ray and Megahan (1978) developed a procedure for measuring streambank morphology, erosion, and deposition. Detailed streambank inventories may be recorded and mapped to monitor present conditions or changes in morphology through time.

To assess the effect of land use changes on streambank stability, Platts et al. (1987) provide methods for evaluating and rating streambank soil alteration. Their rating system can be used to determine the conditions of streambank stability that could affect fish. Other measurements that could be important for fisheries habitat evaluations include streambank undercut, stream shore water depth, and stream channel bank angle.

d. Benthic Organism Sampling

Benthic communities in estuaries are sampled through field surveys, which are typically time-consuming and expensive (USEPA, 1991a). Sampling devices include trawls, dredges, grabs, and box corers. For more specific benthic sampling guidance, see Klemm et al. (1990).

e. Fish Sampling

For estuaries and coastal waters, a survey vessel manned by an experienced crew and specially equipped with gear to collect organisms is required (USEPA, 1991a). Several types of devices and methods can be used to collect fish samples, including traps and cages, passive nets, trawls (active nets), and photographic surveys. Since many of these devices selectively sample specific types of fish, it is not recommended that comparisons be made among data collected using different devices (USEPA, 1991a).

f. Shellfish Sampling

Pathobiological methods provide information concerning damage to organ systems of fish and shellfish through an evaluation of their altered structure, activity, and function (USEPA, 1991a). A field survey is required to collect target organisms, and numerous tissue samples may be required for pathobiological methods. In general, pathobiological methods are labor-intensive and expensive (USEPA, 1991a).

g. Plankton Sampling

Phytoplankton sampling in coastal waters is frequently accomplished with water bottles placed at a variety of depths throughout the water column, some above and some below the pycnocline (USEPA, 1991a). A minimum of four depths should be sampled. Zooplankton sampling methods vary depending on the size of the organisms. Devices used include water bottles, small mesh nets, and pumps (USEPA, 1991a).

h. Aquatic Vegetation Sampling

Attributes of emergent wetland vegetation can be monitored at regular intervals along a transect (USEPA, 1991a). Measurements include plant and mulch biomass, and foliar and basal cover. Losses of aquatic vegetation can be tracked through aerial photography and mapping.

i. Water Column Sampling

In estuaries and coastal waters, chemical samples are frequently collected using water bottles and should be taken at a minimum of four depths in the vertical profile (USEPA, 1991a). Caged organisms have also been used to monitor the bioaccumulation of toxic chemicals.

Physical sampling of the water column at selected depths in estuaries is done with bottles for temperature, salinity, and turbidity, or with probes for temperature and salinity (USEPA, 1991a). Current meters are used to characterize circulation patterns.

j. Sediment Sampling

Several types of devices can be used to collect sediment samples, including dredges, grabs, and box corers (USEPA, 1991a). Sampling depth may vary depending on the monitoring objective, but it is recommended that penetration be well below the desired sampling depth to prevent sample disturbance as the device closes (USEPA, 1991a). EPA also recommends the selection of sediment samplers that also sample benthic organisms to cut sampling costs and to permit better statistical analyses relating sediment quality to benthic organism parameters.

k. Bacterial and Viral Pathogen Sampling

For estuaries and coastal waters it is recommended that samples be taken of both the underlying waters and the thin microlayer on the surface of the water (USEPA, 1991a). This is recommended, despite the fact that standardized methods for sampling the microlayer have not been established, because research has shown bacterial levels several orders of magnitude greater in the microlayer. In no case should a composite sample be collected for bacteriological examination (USEPA, 1978).

Water samples for bacterial analyses are frequently collected using sterilized plastic bags or screw-cap, wide-mouthed bottles (USEPA, 1991a). Several depths may be sampled during one cast, or replicate samples may be collected at a particular depth by using a Kemmerer or Niskin sampler (USEPA, 1978). Any device that collects water samples in unsterilized tubes should not be used for collecting bacteriological samples without first obtaining data that support its use (USEPA, 1991a). Pumps may be used to sample large volumes of the water column (USEPA, 1978).

9. Quality Assurance and Quality Control

Effective quality assurance and quality control (QA/QC) procedures and a clear delineation of QA/QC responsibilities are essential to ensure the utility of environmental monitoring data (Plafkin et al., 1989). Quality control refers to the routine application of procedures for obtaining prescribed standards of performance in the monitoring and measurement process. Quality assurance includes the quality control functions and involves a totally integrated program for ensuring the reliability of monitoring and measurement data.

EPA's QA/QC program requires that all EPA National Program Offices, EPA Regional Offices, and EPA laboratories participate in a centrally planned, directed, and coordinated Agency-wide QA/QC program (Brossman, 1988). This requirement also applies to efforts carried out by the States and interstate agencies that are supported by EPA through grants, contracts, or other formalized agreements. The EPA QA program is based on EPA order 5360.1, which describes the policy, objectives, and responsibilities of all EPA Program and Regional Offices (USEPA, 1984).

Each office or laboratory that generates data under EPA's QA/QC program must implement, at a minimum, the prescribed procedures to ensure that precision, accuracy, completeness, comparability, and representativeness of data are known and documented. In addition, EPA QA/QC procedures apply throughout the study design, sample collection, sample custody, laboratory analysis, data review (including data editing and storage), and data analysis and reporting phases.

Specific guidance for QA/QC is provided for EPA's rapid bioassessment protocols (Plafkin et al., 1989) and for EPA's Ocean Data Evaluation System (USEPA, 1991a). Standardized procedures for field sampling and laboratory methods are an essential element of any monitoring program.

D. Data Needs

Data needs are a direct function of monitoring goals and objectives. Thus, data needs cannot be established until specific goals and objectives are defined. Furthermore, data analyses should be planned before data types and data collection protocols are agreed upon. In short, the scientific method, defined as "a method of research in which a problem is identified, relevant data gathered, an hypothesis formulated, and the hypothesis empirically tested" (Stein, 1980), should be applied to determine data needs.

Types of data generally needed for nonpoint source monitoring programs will include chemical, physical, and biological water quality data; precipitation data; topographic and morphologic data; soils data; land use data; and land treatment data. The specific parameters should be determined based on site-specific needs and the monitoring objectives that are established.

Under EPA's quality assurance and quality control (QA/QC) program (see Quality Assurance and Quality Control), a full assessment of the data quality needed to meet the intended use must be made prior to specification of QA/QC controls (Brossman, 1988). The determination of data quality is accomplished through the development of data quality objectives (DQOs), which are qualitative and quantitative statements developed by data users to specify the quality of data needed to support specific decisions or regulatory actions. Establishment of DQOs involves interaction of decision makers and the technical staff. EPA has defined a process for developing DQOs (USEPA, 1986).

E. Statistical Considerations

A significant challenge for those performing monitoring under section 6217 is to isolate the changes in loads and water quality caused by the implementation of management measures from those changes caused by the other sources of variability. In short, the task is to separate the effect, or "signal," from the noise.

Successful monitoring programs typically resemble research, complete with focused objectives, hypotheses to test, statistical analyses, thorough data interpretation, and clear reporting. Statistics are an inherent component of nearly all water quality monitoring programs (MacDonald, 1991). The capability to plan for and use statistical analyses, therefore, is essential to the development and implementation of successful monitoring programs. The following discussion provides some basic information regarding statistics that should be understood by monitoring professionals. A qualified statistician should be consulted to review the proposed monitoring design, the plan for statistical analyses, the application of statistical techniques, and the interpretation of the analytic results.

1. Variability and Uncertainty

Gilbert (1987) identifies five general sources of variability and uncertainty in environmental studies:

- (1) Environmental variability;
- (2) Measurement bias, precision, and accuracy;
- (3) Statistical bias;
- (4) Random sampling errors; and
- (5) Gross errors and mistakes.

The author describes environmental variability as "the variation in true pollution levels from one population unit to the next." There are multiple sources of environmental variability that could affect pollutant loads and water quality conditions. These sources include variability in weather patterns within and across years, natural variability in water

resource conditions, variations in biological communities, variability in loadings from point sources and other sources that may not be addressed under section 6217 programs, and variability in land use. Changing land use brings with it changes in the level of pollution control possible under section 6217. For example, a conversion from well-managed agricultural cropland to well-managed suburban development may cause decreases in nutrient and sediment loads while possibly causing increases in metal loads and changes in hydrology. Gilbert (1987) notes that existing information on environmental variability can be used to "design a plan that will estimate population parameters with greater accuracy and less cost than can otherwise be achieved."

Accuracy is a measure of how close the sample value is to the true population value, whereas precision refers to the repeatability of sample values. Measurement bias occurs when estimates are consistently higher or lower than the true population value (Gilbert, 1987). Random sampling errors (e.g., variability in sample means for different random samples from the same population) are due only to the random selection process and arise from the environmental variability of population units (Gilbert, 1987). By definition, random sampling error is zero if all population units are measured.

Statistical bias is "a discrepancy between the expected value of an estimator and the population parameter being estimated" (Gilbert, 1987). Gilbert (1987) provides examples of estimators that are biased for small sample sizes but less biased or unbiased for larger samples.

Gross mistakes can occur at any point in the process, beginning with sample collection and ending with the reporting of study results (Gilbert, 1987). Adherence to accepted sampling and laboratory protocol, combined with thorough quality control and data screening procedures, will minimize the chances for gross errors.

2. Samples and Sampling

a. Samples

A sample is defined as "a small part of anything or one of a number, intended to show the quality, style, or nature of the whole" (Stein, 1980). Environmental samples are collected for both economic and practical reasons: that is, researchers cannot afford to inspect the *whole* and researchers usually have neither the time and resources nor the capability to even try to inspect the whole. Besides, researchers often find that a sample or collection of samples will provide sufficient information about the whole to allow decisions to be made regarding actions that should or should not be taken.

In a statistical sampling program, the whole is called the *population* or *target population*, and it consists of the set of *population units* about which inferences will be made (Gilbert, 1987). As an example, population units could be defined as macroinvertebrate populations on square-meter sections of river bottom, nitrogen concentrations in 1-liter grab samples, or hourly mean-flow values at a specific gaging station. Gilbert (1987) refers to the *sampled population* as the set of population units directly available for measurement.

b. Sampling Objectives

Gaugush (1986) states that "the major objective in sampling program design is to obtain as accurate or unbiased an estimate as possible, and at the same time to reduce or explain as much of the variability as possible in order to improve the precision of the estimates." According to Cochran (1977), an estimator is unbiased if its mean value, taken over all possible samples, is equal to the population statistic that it estimates.

In the real world it is necessary to design sampling programs that meet accuracy and precision requirements while not placing unreasonable burdens on sampling personnel or sampling budgets. As stated by Gaugush (1986), budget constraints may force the issue of whether sampling results will produce information sufficient to meet the study objectives.

Gaugush (1986) describes in some detail specific points to consider in defining study objectives. He notes that "sampling is facilitated by specifying the narrowest possible set of objectives which will provide the desired

information." First, he recommends that the target population be defined as a key step in limiting the variability encountered in the sampling program. As an example, in a coastal watershed impacted by nonpoint sources, the target population could be defined as storm-event, total nitrogen concentrations at the outlets of all tributaries to the bay, thus eliminating the need to monitor at upstream and in-bay sites and during baseflow conditions. In this example, the definition of the target population also specifies the water quality parameter of interest (i.e., total nitrogen concentration). Note that both spatial and temporal limits should be established when defining the target population. With respect to the example, then, the researcher may more specifically define the population units as the total nitrogen concentrations in half-hour, composite samples taken during all storms (*storms* as defined by the researcher).

The next step, according to Gaugush (1986), is to decide whether parameter estimation or hypothesis testing is the primary analytic goal. This choice will have an impact on the sampling design. As an example, Gaugush points out that balanced designs are desirable for hypothesis testing (see Estimation and Hypothesis Testing), whereas parameter estimation may require unbalanced sample allocations to account for the spatial variability of parameter levels. Hypothesis testing is likely to be used in program evaluation (e.g., water quality before and after nonpoint source management measures are implemented), whereas parameter estimation can be applied in assessments when determining pollutant loads from various sources.

Finally, Gaugush (1986) recommends that exogenous variables and sampling strata be defined. Exogenous variables are used to explain some of the variability in the measured parameter of interest. As an example, total suspended solids (TSS) is often a covariate of total phosphorus (TP) concentration in watersheds impacted by agricultural runoff. Measurement of TSS may help increase the precision of TP estimates.

c. Sample Type and Sampling Design

The sampling program should provide representative and sufficient data to support planned analyses. Site location and sampling frequency are often considered sufficient to describe the "where" and "when" of sampling programs. While this is certainly true to a large extent, these two factors alone do not describe fully where and when samples are collected. Additional considerations include the depth of sampling and the surface-water or ground-water stratum to which the sampling depth belongs, the origins of the aliquots taken in each sample bottle, and the time frame over which measurements are made (including specific dates). These additional considerations are factors that characterize the *type* of sample collected. Site location and sampling frequency are components of sampling *design*.

In order for the data analyst to interpret sampling results appropriately, the sample type, sampling design, and target population must all be clearly described. It should be clear from these descriptions whether the data collected are representative of the target population.

Examples of sample type classifications include instantaneous and continuous; discrete and composite; surface, soil-profile, and bottom; time-integrated, depth-integrated, and flow-integrated; and biological, physical, and chemical. Specific guidance regarding the collection of these various sample types is not presented in this guidance since there are several existing guidances to address sampling protocols and equipment.

An overview of a range of basic sampling designs is provided below. Users are encouraged to consult basic statistics textbooks (e.g., Cochran, 1977) and books on applied statistics (e.g., Gilbert, 1987) to obtain additional information regarding these designs.

Simple Random Sampling. In simple random sampling, each unit of the target population has an equal chance of being selected. For example, if the target population is the macroinvertebrate population found on 100 square meters of river bottom and the population units are 1-square-meter sections of river bottom, then each unit would have a 1 percent chance of being sampled under a random sampling program.

Gilbert (1987) and Cochran (1977) both address many aspects of simple random sampling. Included in these texts are methods for estimation of the mean and total for sampling with and without replacement, equations for

determining the number of samples required for both independent and correlated data, and the impact of measurement errors.

Stratified Random Sampling. In stratified random sampling, the target population is divided into separate groups called *strata* for the purpose of obtaining a better estimate of the mean or total for the entire population (Gilbert, 19987). Simple random sampling is then used within each stratum.

Stratified random sampling could be used, for example, to monitor water quality in streams below irrigation return flows. Based on a knowledge of irrigation and precipitation patterns for the watershed, the researcher could divide the year into two or more homogenous periods. Within each period random samples could be taken to characterize the average concentration of a particular pollutant. These random samples could take the form of daily, flow-weighted composite samples, with the sampling dates randomly determined.

Cluster Sampling. In cluster sampling, the total population is divided into a number of relatively small subdivisions, or clusters, and then some of these subdivisions are randomly selected for sampling (Freund, 1973). For one-stage cluster sampling these selected clusters are sampled totally, but in two-stage cluster sampling random sampling is then performed within each cluster (Gaugush, 1986).

Cluster sampling is applied in cases where it is more practical to measure randomly selected groups of individual units than to measure randomly selected individual units (Gilbert, 1987). An example of one-stage cluster sampling is the collection of all macroinvertebrates on randomly selected rocks within a specified sampling area. The stream bottom may contain hundreds of rocks with thousands of organisms attached to them, thus making it difficult to sample the organisms as individual units. However, it may be possible to randomly select rocks and then inspect every organism on each selected rock.

Multi-stage Sampling. Two-stage sampling involves dividing the target population into primary units, randomly selecting a subset of these primary units, and then taking random samples (subunits) within each of the selected subsets (Gilbert, 1987). All of the random samples from the subunits are measured completely. Two-stage cluster sampling, described above, is one form of two-stage sampling. Cochran (1977) describes two-stage sampling in great detail, and both Gilbert (1987) and Cochran (1977) discuss three-stage sampling and compositing.

Double Sampling. Double sampling, or two-phase sampling, involves taking a large preliminary sample to gain information (e.g., population mean or frequency distribution) about an auxiliary variate (x_i) in the context of a larger sampling survey to make estimates for some other variate (y_i) (Cochran, 1977). This technique can be used for stratification, ratio estimates, and regression estimates (Cochran, 1977).

Double sampling for stratification requires a first sample to estimate the strata weights (the proportion of samples to be taken in each stratum) and a second sample to estimate the strata means (Cochran, 1977). Gilbert (1987) discusses a use of double sampling in which two techniques are used in initial sampling and subsequent sampling is performed using only the cheaper or simpler technique. The initial sampling is used to establish a linear regression between the measurements from the two techniques. This regression is then applied to the subsequent measurements made with the cheaper technique to predict the measurement result that would have been obtained with the better, more expensive technique.

Systematic Sampling. A commonly used sampling approach is systematic sampling, which entails taking samples at a preset interval of time or space, using a randomly selected time or location as the first sampling point (Gilbert, 1987). Systematic sampling is used extensively in water quality monitoring programs usually because it is relatively easy to do from a management perspective.

Cochran (1977) points out that the difference between systematic sampling and stratified random sampling with one unit per stratum is that in systematic sampling the sampled unit occurs in the same relative position within each stratum while in stratified random sampling the relative position is selected randomly. Cochran recommends systematic sampling for the following situations:

- When the ordering of the population is essentially random or it contains at most a mild stratification;
- When stratification with numerous strata is employed and an independent systematic sample is drawn from each stratum;
- When subsampling cluster units; and
- When sampling populations with variation of a continuous type, provided that an estimate of the sampling error is not regularly required.

Sampling for Regression Analysis. Regression analysis is used to predict variable values based on a mathematical relationship between a dependent variable and one or more independent variables (Gaugush, 1986). Gaugush points out that regression analysis requires that at least one quantitative independent variable be used, whereas parameter estimation and hypothesis testing can be performed for groups or classes (i.e., only the variable tested needs to be quantitative). For example, one could quantify the relationship between sediment levels and flow rates by regressing the log of total suspended solids (TSS) concentrations (dependent) against flow rates (independent), which would require quantitative measurements of both parameters. Alternatively, one could estimate average TSS levels (parameter estimation) for high, medium, and low flow conditions with quantitative measures of TSS concentrations and qualitative measures of flow (e.g., visual observation).

Gaugush (1986) discusses sampling to support regression analyses in terms of relating variables to either a spatial or a temporal gradient, the latter being for trends over time. Some key points made are explained below.

Spatial Gradient Sampling

- The gradient variable is treated as a covariant to the variable of interest.
- If the relationship is linear, only two points need to be sampled; the extreme points are preferred.
- Whenever the relationship is known, relatively few sampling points are needed along the gradient. More samples may then be used as replicates.
- Whenever the relationship is not known, more sampling points are needed along the gradient. More replicates are also needed to test the proposed model.
- It is usually acceptable to place sampling points equal distances from each other along the gradient. However, the investigator should be careful not to fall in step with some natural phenomenon, which would bias any data collected.

Time Sampling

- Time can be used either as a covariate or as a grouping variable (e.g., season). Grouping by time may be desirable when changes in the variable of interest are either small over time or occur only during short periods with long periods of little or no change.
- Considerations in using time as a covariate are similar to those above for gradients, but (1) time is usually only a surrogate for other variables (e.g., implementation of management measures) that truly affect the variable of interest, and (2) the relationship with time is likely to be complex.
- If time is to be used as a covariate, relatively frequent sampling will be needed, with some replication within sampling periods. Random sampling within the periods is also recommended.

Comparison of Sampling Designs. Both Gilbert (1987) and Cochran (1977) indicate that systematic sampling is generally superior to stratified random sampling in estimating the mean. Cochran (1977), however, found that

stratified random sampling provides a better estimate of the mean for a population with a linear trend, followed in order by systematic sampling and simple random sampling. Freund (1973) notes that estimates of the mean that are based on cluster sampling are generally not as good as those based on simple random samples, but they are better per unit cost. Table 8-2 summarizes the conditions under which each of six probabilistic sampling approaches should be used for estimating means and totals (Gilbert, 1987). Cochran (1977) states that "stratification nearly always results in a smaller variance for the estimated mean or total than is given by a comparable simple random sample." Estimates of variance from systematic samples may differ from those determined from random samples, but Cochran (1977) notes that "on average the two variances are equal." Cochran warns, however, that for any finite population for which the number of sampling units is small the variance from systematic sampling is erratic and may be smaller or larger than the variance from simple random sampling.

d. Preliminary Sampling

Preliminary sampling helps to ensure that the population of interest is being sampled and to evaluate its distribution (Coffey and Smolen, 1990). Preliminary sampling or previous testing helps avoid the problem of collecting large sets of useless data because of ineffective gear, or improper sample preparation or preservation. The target population can be easily missed, especially for biological monitoring.

e. Use of Existing Data

Existing data may be used for problem definition, or for a pre-implementation baseline data set if the collection protocol matches the monitoring objective, design, and quality assurance/quality control (QA/QC) required for the post-implementation data collection (Coffey and Smolen, 1990). Existing data may also be used for assessing parameter variability and estimating the number of samples or the time period for the monitoring survey based on the desired level of significance and error.

3. Estimation and Hypothesis Testing

There are two major types of statistical inference: estimation and hypothesis testing (Remington and Schork, 1970). In estimation it is hoped that sample information can be used to make a reasonable conclusion regarding the value of an unknown parameter. For example, the sample mean and standard deviation are used to estimate a range within which it is likely that the population mean falls. This sort of estimation can be useful in developing baseline information, developing or verifying models, estimating the nonpoint source contributions in a watershed, or determining the nitrogen load from a single runoff event.

In hypothesis testing, data are collected for the purpose of accepting or rejecting a statement made about the expected results of a study or effort. Hypothesis testing can be used to help decide whether management measures have reduced pollutant loads or improved water quality. Because of this, hypothesis testing is a recommended element of monitoring programs under section 6217.

The null hypothesis (H_0) is the root of hypothesis testing. Traditionally, null hypotheses are statements of "no change," but Remington and Schork (1970) prefer the term "tested hypothesis" since these hypotheses can take the form of expected changes, effects, or differences. The alternate hypothesis (H_a) is the counter to the null hypothesis, traditionally being a statement of change, effect, or difference. That is, upon rejection of an H_0 stating no change one would accept the H_a of change. One could, however, state an H_0 of the type "change of at least 10 percent," with an H_a of the type "no change of at least 10 percent." The choice is left to the researcher.

If the monitoring design is sound and statistical testing shows the null hypothesis to be false, then a change can be inferred (Coffey and Smolen, 1990). Otherwise, the monitoring survey should conclude that the objective was not met or that detection of change was overcome by extreme variability. In either case, with a sound objective, well-formulated hypothesis, and careful design, the monitoring survey may be expected to produce valuable information.

Table 8-2. Applications of Six Probability Sampling Designs to Estimate Means and Totals (after Gilbert, 1987)

Sampling Design	Conditions for Application
Simple Random Sampling	Population does not contain major trends, cycles, or patterns of contamination.
Stratified Random Sampling	Useful when a heterogeneous population can be broken down into parts that are internally homogenous.
Multistage Sampling	Needed when measurements are made on subsamples or aliquots of the field sample.
Cluster Sampling	Useful when population units cluster together and every unit in each randomly selected cluster can be measured.
Systematic Sampling	Usually the method of choice when estimating trends or patterns of contamination over space. Also useful for estimating the mean when trends and patterns in concentrations are not present, or they are known <i>a priori</i> , or when strictly random methods are impractical.
Double Sampling	Useful when there is a strong linear relationship between the variable of interest and a less expensive or more easily measured variable.

The following are examples of hypotheses that could be developed for section 6217 monitoring programs.

- Implementation of nutrient management on cropland in all tributary watersheds will not reduce mean total nitrogen concentrations in Beautiful Sound by at least 20 percent.
- Urban detention basins in New City will not remove 80 percent of sediment delivered to the basins.
- Improved marina management will not reduce metals loadings from the repair and maintenance areas of Stellar Marina.
- Forestry harvest activities have not increased weekly mean total suspended solids concentrations in Clean River.

F. Data Analysis

A detailed preliminary analysis using scatter plots and statistical tests of assumptions and the properties of the data set such as the distribution, homogeneity in variance, bias, independence, etc. precede formal hypothesis testing and statistical analysis (Coffey and Smolen, 1990). From the objective and the properties of the data set, the appropriate statistical test may be chosen to determine a trend, impact, or causality.

Simple scatter plots can often reveal much about the data set. For example, a scatter plot of nitrate concentrations versus depth collected at 106 monitoring wells in South Dakota (Figure 8-2) clearly shows that (Goodman et al., 1992):

- With few exceptions, nitrate concentrations above 5 parts per million (ppm) were not detected at depths greater than 20 feet below the water table;

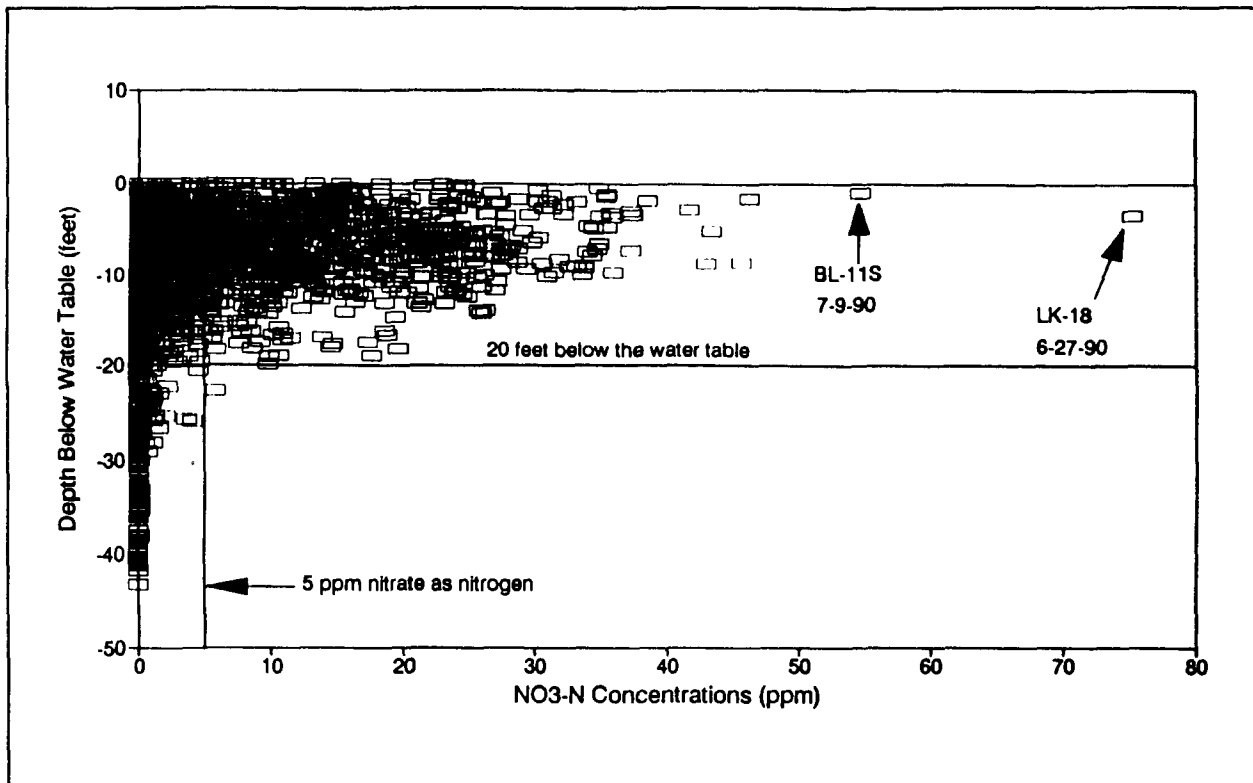

Figure 8-2. Scatter plot of nitrate concentration versus depth below water table (Goodman et al., 1992).

- Nitrate concentrations greater than 0.2 ppm were not observed at depths greater than 30 feet below the water table; and
- Nitrate concentrations exceeded 50 ppm only twice.

For trend detection some of the appropriate tests include Student's t-test, linear regression, time series, and nonparametric trend tests (Coffey and Smolen, 1990). For an assessment of impact and causality, a careful tracking of treatment is required and the two-sample Student's t-test, linear regression, and intervention time series are appropriate statistical tests (Spooner, 1990). Evidence from experimental plot studies, edge-of-field pollutant runoff monitoring, and modeling studies may be used to support the conclusion of causality (Coffey and Smolen, 1990).

A comparison of regression lines for data collected before best management practices (BMPs) were implemented (pre-BMP) and for data collected after BMPs were implemented (post-BMP) can be used to explore the presence of trends in a paired-watershed study. The example in Figure 8-3 (Meals, 1991b) shows a downward shift of the post-BMP regression line, suggesting a significant decrease in total phosphorus (TP) export from the treated (study) watershed (WS 4). In this study, pre-BMP data were collected for 3 years for calibration (see Types of Experimental Designs) of the two watersheds (control and study), followed by a post-BMP monitoring period of 5 years. Meals (1991b) explains the plot by noting that a 5-pound-per-week (lb/wk) export of TP from the control watershed (WS 3) corresponded to an 8.25-lb/wk export from the study watershed (WS 4) before BMP implementation. After BMP implementation, the same 5-lb/wk export from the control watershed corresponded to a 6-lb/wk export from the study watershed.

Lietman (1992) used cluster analysis to establish eight different storm groups based on total storm precipitation, antecedent soil-moisture conditions, precipitation duration, precipitation intensity, and crop cover. The results of analyses performed using the following clusters will be presented:

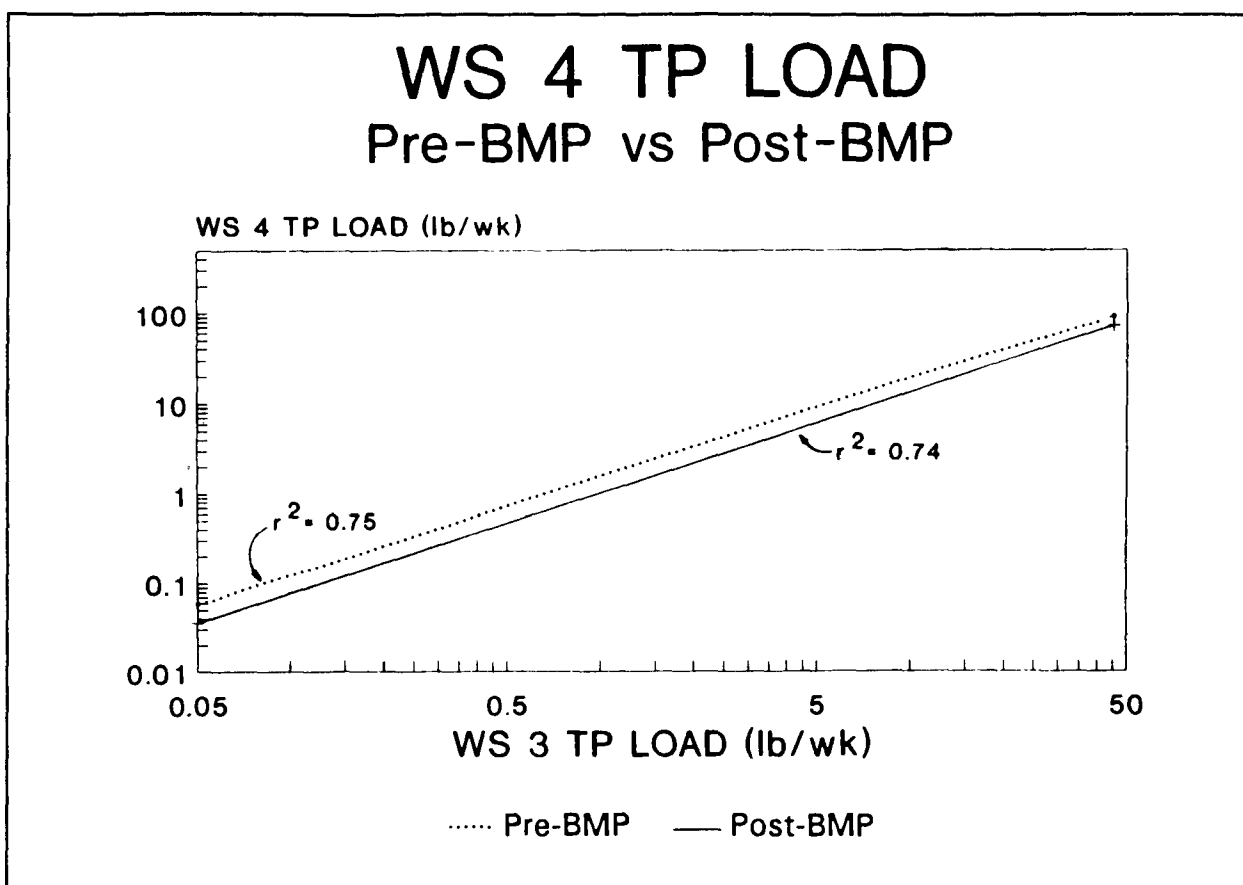

Figure 8-3. Paired regression lines of pre-BMP and post-BMP total phosphorus loads, LaPlatte River, Vermont (Meals, 1991b).

- Cluster 1: Summer showers on moist soil with crop cover.
- Cluster 3: Typical spring and fall all-day storms generally with 0.2 to 0.6 inch of precipitation on soil with little crop coverage.
- Cluster 6: Thunderstorms occurring predominantly in the summer on soil with cover crop.
- Cluster 7: Very small storms throughout the year on dry soil; most storms occurring on soil with little crop cover.
- Cluster 8: Typical spring and fall all-day storms generally with 0.8 to 1.6 inches of precipitation on soil with little crop cover.

These clusters were then used to group data for testing for significant differences between pre-BMP (Period 1, 1983-1984) and post-BMP (Period 3, 1987-1988; after terraces were installed) median runoff volume, mean suspended sediment concentrations, and mean nutrient concentrations at a 22.1-acre field site in Lancaster County, Pennsylvania. Cluster 3 had a very small number of storms producing runoff in Period 3, indicating that terracing increased the threshold at which runoff occurred (Lietman, 1992). Other results, summarized in Figure 8-4 (Lietman, 1992), indicate that terracing caused mean storm suspended sediment concentrations in runoff to decrease for storms in clusters 6, 7, and 8. Terraces also appeared to increase mean nitrate (Clusters 1, 6, 7, and 8) and mean total nitrogen concentrations (Clusters 1 and 8).

Mann-Whitney test results comparing within clusters total storm runoff and mean storm suspended sediment and nutrient concentrations between Period 1 (1983-84) and Period 3 (1987-88); storms on frozen ground excluded. † = statistically significant increase; ‡ = statistically significant decrease; ↔ = no statistically different change; (90) = significant at the 90 percent confidence interval; (95) = significant at the 95 percent interval; n = number of storms; mg/L = milligrams per liter; ft³/s = cubic foot per second; ft³/acre = cubic foot per acre; and lb/acre = pound per acre.

		CLUSTER 1	CLUSTER 6	CLUSTER 7	CLUSTER 8
		PERIOD 1/PERIOD 3	PERIOD 1/PERIOD 3	PERIOD 1/PERIOD 3	PERIOD 1/PERIOD 3
ALL STORMS¹					
Total storm runoff (ft ³ /acre)	Change	‡(90)	↔	‡(95)	↔
	median	85/0	54/400	0/0	205/260
	n	31/21	18/10	67/73	15/12
STORMS THAT PRODUCED RUNOFF					
Total storm runoff (ft ³ /acre)	Change	†(90)	↔	↔	↔
	median	120/240	102/740	24/80	260/260
	n	21/7	13/9	26/10	13/12
Mean suspended sediment concentrations (mg/L)	Change	↔	‡(95)	‡(95)	‡(95)
	median	2,870/2,030	9,040/1,850	3,530/725	1,930/470
	n	19/7	9/8	22/6	7/10
Mean total phosphorus concentration (mg/L as P)	Change	↔	↔	↔	↔
	median	2.6/2.7	4.1/3.4	3.1/3.4	3.1/4.3
	n	12/7	8/7	17/3	6/7
Mean total nitrogen concentration (mg/L as N)	Change	*†(90)	↔	↔	†(90)
	median	3.4/6.1	5.4/6.2	5.2/7.4	4.1/7.2
	n	12/7	8/7	17/3	6/7
Mean ammonia + organic nitrogen concentration (mg/L as N)	Change	↔	↔	↔	↔
	median	2.7/4.2	4.6/4.2	4.1/4.2	3.6/4.8
	n	12/7	8/7	17/3	6/7
Mean nitrate + nitrite concentration (mg/L as N)	Change	†(95)	†(95)	†(95)	‡(95)
	median	56/1.7	54/1.8	59/4.1	43/3.0
	n	12/7	8/7	17/3	6/7

¹Total and mean discharge set equal to zero if no measurable runoff occurred.

Figure 8-4. Results of analysis of clustered pre-BMP and post-BMP data from Conestoga Headwaters, Pennsylvania (Lietman, 1992).

Failure to observe improvement may mean that the problem is not carefully documented, management action is not directed properly, the strength of the treatment is inadequate, or the monitoring program is not sensitive enough to detect change (Coffey and Smolen, 1990). A mid-course evaluation, if conducted early enough, provides an opportunity for modifications in project goals or monitoring design.

Clear reporting of the results of statistical analyses is essential to effective communication with managers. Graphical techniques and simple narrative interpretations of statistical findings generally help managers obtain the level of detail they need to make decisions regarding subsequent actions. For example, Figure 8-5 illustrates the use of box-and-whisker plots to summarize fecal coliform data at the beach on St. Albans Bay, Vermont (Meals et al., 1991). The graphic clearly shows a general decline in bacteria counts in 1987-1989, as well as the fact that the water quality standard has been met during those same years. A graphic summary of trends is illustrated in Figure 8-6, also taken from the St. Albans Bay project (Meals, 1992). This simple graphic is particularly easy for managers to interpret.

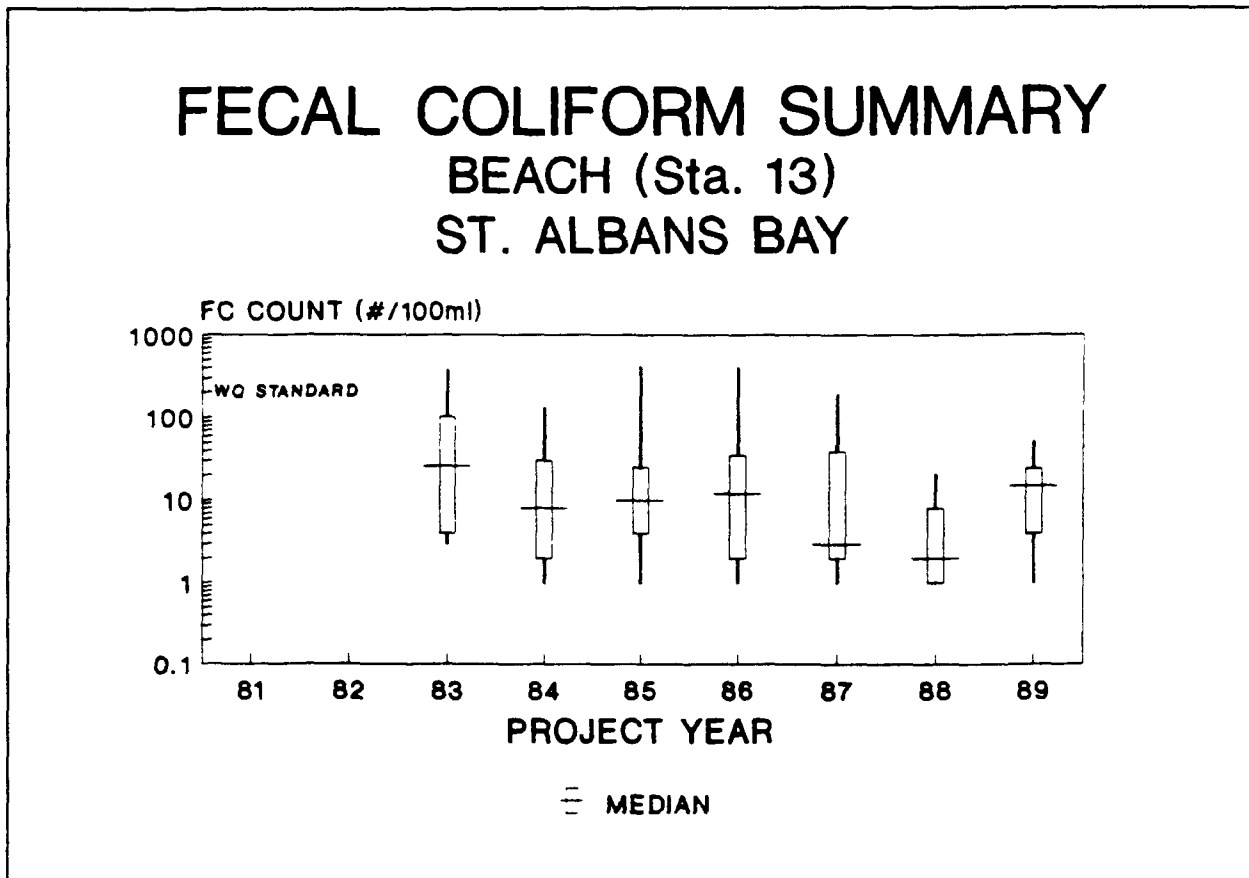

Figure 8-5. Summary of fecal coliform at the beach on St. Albans Bay, Vermont (Meals et al., 1991).

Station	TRB	TSS	VSS	TP	SRP	TKN	NH ₃ -N	CHL _a	S.D.
Off-Bridge (14)	▽	▼	●	▼	▽	●	▽	▲	●
Inner Bay (12)	▽	▽	△	△	●	●	●	▲	▽
Outer Bay (11)	●	●	●	▲	▲	▲	▲	▲	▽

● = No significant trend
 △▽ = Increasing or decreasing trend by some but not all statistical tests ($P \leq 0.10$)
 ▲▼ = Increasing or decreasing trend by all statistical tests ($P \leq 0.10$)

TRB = turbidity; TSS = total suspended solids; VSS = volatile suspended solids; TP = total phosphorus; SRP = soluble reactive phosphorus; TKN = total Kjeldahl nitrogen; NH₃-N = ammonia nitrogen; CHL_a = chlorophyll a; S.D. = Secchi disk.

Figure 8-6. Trends in St. Albans Bay water quality, 1981-1990 (Meals, 1992).

III. TECHNIQUES AND PROCEDURES FOR ASSESSING IMPLEMENTATION, OPERATION, AND MAINTENANCE OF MANAGEMENT MEASURES

A. Overview

As discussed in the introduction to this chapter, States will not be able to fully interpret their water quality monitoring data without information regarding the adequacy of management measure implementation, operation, and maintenance. Section II of this chapter provides an overview of techniques for assessing water quality and estimating pollution loads. The information presented in this section is intended to complement that provided in Section II to give State and local field personnel the basic information they need to develop sound programs for assessing over time the success of management measures in reducing pollution loads and improving water quality.

Successful management measures designed to control nonpoint source pollutants require proper planning, design and implementation, and operation and maintenance. This section presents a general discussion of the procedures involved in ensuring the successful design and implementation of various management measures, but is *not* intended to provide recommendations regarding the operation and maintenance requirements for any given management measure. Instead, this section is intended to provide "inspectors" with ideas regarding the types of evidence to seek when determining whether implementation or operation and maintenance are being performed adequately.

B. Techniques

1. Implementation

Proper planning is an essential step in implementing management measures effectively and developing procedures that ensure that the measures are achieved. During the planning stage, the optimal selection of management practices for a specific discipline, such as forestry, is made following an evaluation of several factors. Some of these factors include site conditions, the water quality goals to be achieved, and the need to meet additional objectives established by the user. In some cases, local and state measures may directly require the use of certain practices or effectively dictate the use of certain practices through the establishment of limits (e.g., application rates for fertilizers and pesticides, annual erosion rates, land use controls, or setback distances from environmentally sensitive areas). The key components of the planning stage include:

- Site investigations by qualified personnel such as soil scientists, biologists, wetlands scientists, hydrologists, and engineers;
- Collection of pertinent data relative to the source category;
- Identification of water quality goals;
- Identification of land user objectives;
- Identification of relevant State and local regulations;
- Coordination with regulatory (and at times funding) agencies as necessary; and
- Identification of an appropriate series of practices that achieve both the stated objectives and the applicable management measures.

Once the appropriate series of practices has been identified for use, it is essential that each practice be properly designed and implemented for the measures to be successful. This requires that design and installation be conducted by qualified and experienced personnel. Design of the management practices should be done in accordance with

existing design guidelines and standards outlined in technical guides, including those developed by States and the Soil Conservation Service of the U.S. Department of Agriculture. These standards include specific design criteria and specifications that, when followed, will ensure the proper design of a practice. The technical guides also include construction and implementation specifications that provide detailed guidance to the installer. It is always desirable to have a qualified person such as the designer present at certain stages during installation to ensure that the designs are being interpreted correctly and installed as specified.

2. Operation and Maintenance

A critical step in ensuring success of a management measure is proper operation and maintenance (O&M) of each practice. Once a series of practices has been designed and installed, it is crucial that the individual practices be operated and maintained to ensure that they function as intended. During the design process, an operation and maintenance plan that identifies continual procedures, schedules, and responsibility for operating and maintaining the practices should be drafted.

Examples of procedures and techniques to ensure the successful achievement of operation and maintenance are identified in the following subsections. These procedures are generally applied by the landowner or operator responsible for implementing the management measures. The examples provided below are not mandatory but rather are presented as illustrations of effective operation and maintenance practices. States may wish to develop programs that ensure that O&M is performed by the responsible individuals or entities.

a. Agriculture

Chapter 2 of this guidance identifies six major categories of agricultural nonpoint pollution sources that affect coastal waters: erosion from cropland, confined animal facilities, application of nutrients to cropland, application of pesticides to cropland, land used for grazing, and irrigation of cropland. Table 8-3 presents examples of general O&M procedures to ensure the performance of these measures.

Table 8-3. Typical Operation and Maintenance Procedures for Agricultural Management Measures

Management Measures	Management Practices	Typical Operation and Maintenance Procedures
Erosion and Sediment Control	<u>Structural and Vegetative Practices</u>	<ul style="list-style-type: none"> - Inspections are performed periodically and after large storm events to check for failure and loss of vegetative cover. Revegetation and replacement or repair of structures are performed as needed. Tree and shrub growth is removed from constructed channels and diversions unless needed for maintaining habitat.
	Terraces, diversions, sediment basins, drainage structures, vegetative cover establishment and improvement, field borders, filter strips, critical area planting, grassed waterways, tree and shrub planting, and mulching	<ul style="list-style-type: none"> - Inspections and removal of accumulated sediments are performed periodically and after large storm events. - Vegetative practices are inspected periodically, and mulch and crop residues are applied for vegetation loss, erosion, and channelization resulting from runoff. Eroded channels are regraded, revegetated, and treated with mulch as needed.
	<u>Nonstructural Practices</u>	<ul style="list-style-type: none"> - Practice implemented is compared versus specifications in design standards, and operational procedures are closely followed.
	Conservation tillage, conservation cropping sequence, delayed seedbed operation, strip-cropping, and crop rotations	

Table 8-3. (Continued)

Management Measures	Management Practices	Typical Operation and Maintenance Procedures
Confined Animal Facility Management	<u>Structural and Vegetative Practices</u>	<ul style="list-style-type: none"> - Inspections are performed periodically and after large storm events to check for failure and loss of vegetative cover. Revegetation and replacement or repair of structures are performed as needed. Tree and shrub growth is removed from constructed channels and diversions unless needed for maintaining habitat.
	Terraces, diversions, heavy use area protection, drainage structures, dikes, grassed waterways, waste storage ponds and structures, waste treatment lagoons, composting facilities, and vegetative cover establishment	<ul style="list-style-type: none"> - Waste storage structures are inspected for cracks and leaks after each use cycle. - All drainage structures including downspouts and gutters are annually inspected and repaired as needed. - Established grades for lot surfaces and conveyance channels are maintained at all times. - Holding ponds and lagoons are drawn down to design storm capacity within 14 days of a runoff event. - Solids are removed from the solid separation system after a runoff event to maintain design capacity and prevent solids from entering runoff holding facilities.
	<u>Nonstructural Practices</u>	
	Waste utilization, application of manure and runoff to agricultural land	<ul style="list-style-type: none"> - Manure transport and application equipment is cleaned with fresh water after each use in an environmentally safe area.

Table 8-3. (Continued)

Management Measures	Management Practices	Typical Operation and Maintenance Procedures
Nutrient Management	<u>Nonstructural Practices</u>	- Operational procedures in management plan are adhered to.
	Nutrient management plan	- Periodic testing of soil and plant tissue is conducted to determine nutrient needs during early growth stages, and manure sludges and irrigation water are tested if used.
		- The nutrient management plan is updated whenever crop rotation or nutrient source is changed. Nutrient needs and application rates and methods are redetermined if needed.
		- Records of nutrient use and sources are maintained along with production records for each field.
		- Application equipment is periodically inspected and calibrated, with repairs made as needed.
		- The management plan is reviewed at least every 3 years and updated if needed.
	<u>Vegetative Practices</u>	- Periodically and after large storm events cover crops are inspected for loss of vegetation, erosion, and channelization. Area is regraded and revegetated as needed. A thick, thriving cover crop is maintained.
	Vegetative cover establishment	

Table 8-3. (Continued)

Management Measures	Management Practices	Typical Operation and Maintenance Procedures
Pesticide Management	<u>Nonstructural Practices</u> Pesticide management	<ul style="list-style-type: none"> - Operational procedures and methods, such as use of proper application methods and rates, are adhered to. - Scouting for pests is conducted periodically, and spot spraying is used when needed. - Pesticide management actions are updated whenever crop rotation is changed or pesticide source is changed. - Application equipment is inspected and calibrated prior to use. - Pesticide use is tracked along with production records for each field. - Pesticide management approach is reviewed each year and updated as needed.

Table 8-3. (Continued)

Management Measures	Management Practices	Typical Operation and Maintenance Procedures
Grazing Management	<p><u>Structural and Vegetative Practices</u></p> <p>Pipelines, ponds, tanks and troughs, fencing, wells, pasture and hayland planting, seeding, mulching, and critical area planting</p>	<ul style="list-style-type: none"> - All structures are periodically inspected, including tanks, pipelines, wells, ponds, and fencing to ensure that they are structurally sound and functioning as designed. Replacement and repair are performed as needed. - Periodically and after large storm events all vegetative and mulching practices are inspected for vegetation loss, erosion, and channelization. Regrading, revegetation, and treatment with mulch are conducted as needed.
	<p><u>Grazing Management</u></p> <p>Deferred grazing, planned grazing system, proper grazing use, and livestock exclusion</p>	<ul style="list-style-type: none"> - Range land is periodically inspected on foot to identify area of erosion, channelization, and loss of vegetation. - Procedures outlined in standards on grazing management practices are adhered to. - Appropriate plant residue or grazing height is maintained to protect grazing soil from erosion. - Livestock herding is provided as needed to protect sensitive areas from excessive use at critical times. - A flexible grazing system is maintained to adjust for unexpected environmental problems.

Table 8-3. (Continued)

Management Measures	Management Practices	Typical Operation and Maintenance Procedures
Irrigation Water Management	<u>Structural and Vegetative Practices</u>	<ul style="list-style-type: none"> - All irrigation system components, such as gate weirs, valves, pipes, meters, and ditches, are annually inspected and maintained to function as designed. - Established grades for lots and conveyance channels are maintained at all times. - Vegetative cover is inspected periodically and after all large rain events for loss of vegetation, erosion, and channelization. Regrading and revegetation are conducted as needed.
	<p>All surface and subsurface irrigation systems; irrigation ditches, canal and channel lining, pipelines, water control structures, water meters, irrigation land leveling, and filter strips</p>	
	<u>Nonstructural Practices</u>	<ul style="list-style-type: none"> - Crop needs and volume of water delivered are measured for each irrigation event, and water is applied uniformly.
	Irrigation water management	

b. Forestry

Forestry-related activities such as road construction, timber harvesting, mechanical site preparation, prescribed burning, and fertilizer and pesticide application contribute to nonpoint source pollution. These operations can change water quality characteristics in waterbodies receiving drainage from forest lands. Activities such as timber harvesting, mechanical site preparation, and prescribed burning can accelerate erosion, resulting in increased sediment concentrations.

There are O&M techniques that minimize hydrological impacts, temperature elevations, the amount of sediment production, and the transport of sediment, nutrients, pesticides, and other pollutants from forest lands into waterbodies. These procedures typically involve periodic inspection and repair of the roadways, streamside management areas, and drainage structures (particularly after storm events); containment and proper use of chemicals used during forestry activities; and revegetation of the disturbed areas. A more detailed description of typical O&M procedures to ensure adequate performance of forestry management measures is presented in Table 8-4.

Table 8-4. Typical Operation and Maintenance Procedures for Forestry Management Measures

Management Measure	Management Practices	Typical Operation and Maintenance Procedures
Preharvest Planning	Develop a State process (or use an existing process) that ensures implementation of all forestry management measures. Such a process should include appropriate notification mechanisms for forestry activities with potential NPS impacts.	<ul style="list-style-type: none"> - Procedures outlined through harvesting planning process are followed. - Preharvest planning process is updated every year based on the results of new studies and Federal and State regulations.
Streamside Management Areas (SMAs)	<p>Establish streamside management zone.</p> <p>Maintain necessary canopy species for shade, bank stability, and large woody debris.</p>	<ul style="list-style-type: none"> - The SMA width is maintained with respect to each State's special management criteria. - Low-level aerial photos are used to determine whether any changes are occurring in the SMA. - Periodic soil sampling is conducted for the presence of pesticides and fertilizers. - Shade cover is tracked throughout the harvesting activity, and clumping and clustering of leave trees is used if a blowdown threat exists.
Road Construction and Reconstruction	<p>Install proper drainage/erosion control devices. Size to regional flood frequency (e.g., 25- or 50-year storms).</p> <p>Install appropriate sediment control structures.</p>	<ul style="list-style-type: none"> - Roadways are checked for flooding during storms. - Culverts and drainage devices are inspected and cleaned during fall and spring of each year and after major storm events. Drainage devices are repaired as needed. - Sediment barriers and hay bales are inspected periodically and after a major storm event. - Erosion, channelization, and any short-circuiting in the filter strips are repaired. - Diversions, terraces, and berms are inspected and repaired.

Table 8-4. (Continued)

Management Measure	Management Practices	Typical Operation and Maintenance Procedures
Road Construction and Reconstruction (continued)	Stream crossing	<ul style="list-style-type: none"> - Waterways are kept clear of debris not needed for habitat. - Stream crossings are stabilized and maintained.
Road Management	Road maintenance	<ul style="list-style-type: none"> - Roads are inspected for structural soundness and erosion after extreme weather. - Surface condition is inspected. - Design grades of roadways are maintained. - Roads are regraded and ruts are filled as needed. - Turnouts, dips, and waterbars are installed if needed. - Drainage structures are inspected, cleared, and repaired as needed.
	Proper closure and maintenance of abandoned roads.	<ul style="list-style-type: none"> - All restricted access roads are maintained and repaired. - Remaining stream-crossing structures are periodically inspected and maintained. - Where stream crossings have failed, crossing structures are removed and streambank is returned to grade. - Vegetation is established on remaining disturbed areas. - Indigenous plant species are selected for replanting.
Timber Harvesting	Landing (Practices have operational and post-operational phases where different O&M procedures may be needed)	<ul style="list-style-type: none"> - Drainage/erosion control structures are periodically inspected and repaired, and vegetation is established on remaining disturbed areas.

Table 8-4. (Continued)

Management Measure	Management Practices	Typical Operation and Maintenance Procedures
Timber Harvesting (continued)	Skidding (Practices have operational and post-operational phases where different O&M procedures may be needed)	<ul style="list-style-type: none"> - Water bar is maintained on skid trails. - Trails and stream channels are revegetated.
	Petroleum management	<ul style="list-style-type: none"> - Spill prevention and containment procedures are followed. - Petroleum products are stored away from watercourses in sealed containers. - Equipment is serviced away from watercourses. - Waste disposal containers are inspected for leaks.
Site Preparation and Forest Regeneration	Site preparation	<ul style="list-style-type: none"> - Mechanical site preparation is not applied on slopes greater than 30 percent and is not conducted in SMAs. - Slash is kept from natural drainages. - Windrows and piles are placed away from drainages.
	Regeneration	<ul style="list-style-type: none"> - Seedlings are distributed evenly across the site. - Planting machines are operated along the contour.
Fire Management	Prescribed fire	<ul style="list-style-type: none"> - Extensive blading of fire lines by heavy equipment is avoided. - Intense prescribed fire is kept away from SMAs, streamside vegetation for small ephemeral drainages, and very steep slopes with high sedimentation potential.

Table 8-4. (Continued)

Management Measure	Management Practices	Typical Operation and Maintenance Procedures
Fire Management (continued)	Wildfire suppression and rehabilitation	<ul style="list-style-type: none"> - Bladed firelines are plowed on contour or stabilized with waterbars and/or other needed techniques to prevent erosion of the fireline. - Use of fire-retardant chemicals in SMAs and over watercourses is avoided where possible.
Revegetation of Disturbed Areas	Revegetate disturbed areas, especially high erosion areas	<ul style="list-style-type: none"> - Growth is inspected until established and replaced as needed. - Mulches are inspected periodically and after rainstorms. - Vegetation is limed and fertilized if needed.
Forest Chemical Management	<p>Apply fertilizer and pesticides according to label instructions. Use a buffer area for chemical applications.</p> <p>Follow spill prevention and containment procedures to prevent products from entering the watercourses.</p> <p>Store the fertilizer and pesticides away from watercourses.</p> <p>Dispose of wastes properly, with no applications directly to water.</p> <p>Consider weather and wind conditions before application.</p>	<ul style="list-style-type: none"> - Instructions and State regulations for fertilizer and pesticide application are followed. - In case of spill, spill containment procedures are followed. - Fertilizer and pesticide storage containers are inspected for leaks. - Waste disposal containers are periodically inspected for leaks. - Workers are informed about the correct method of disposal and the harmful effects on the environment if the waste is not disposed of correctly. - The National Weather Bureau and local weather information centers are contacted for the weather and wind conditions.

Table 8-4. (Continued)

Management Measure	Management Practices	Typical Operation and Maintenance Procedures
Forest Chemical Management (continued)	Use a licensed applicator with properly calibrated equipment.	- The qualifications of the applicator are checked, and proof of the equipment calibration is inspected.
	Analyze soil and foliage prior to application of fertilizer.	- Samples are collected prior to application.
Wetlands Forest Management	Road design and construction	- Temporary roads are used in forested wetlands unless permanent roads are needed to serve large and frequently used areas.
		- Fill roads are constructed only when absolutely necessary.
		- Adequate cross-drainage is provided to maintain the natural surface and subsurface flow of the wetland.
	Harvesting	- When groundskidding, low-ground-pressure tires or tracked machines are used, and skidding is concentrated along a few primary trails.
		- Groundskidding is suspended when soils become saturated.

c. Urban Sources

Pollutants from urban sources include suspended solids, nutrients, pathogens, metals, petroleum products, and various toxics. Generally, urban nonpoint source control measures consist of nonstructural, and vegetative practices, all of which must be properly maintained to ensure pollutant removal. All of these practices should be periodically inspected. In the case of structural practices and vegetative practices, inspections are conducted to locate any structural defects and to perform cleaning operations. Nonstructural practices should be reviewed periodically as guidelines are updated or to determine the level of compliance with the guidelines. These issues are summarized in Table 8-5.

Table 8-5. Typical Operation and Maintenance Procedures for Urban Management Measures

Management Measure Category	Management Measure	Typical Operation and Maintenance Procedures
New Development, Redevelopment, and New and Relocated Roads, Highways, and Bridges	1. By design or performance: (a) the postdevelopment equivalent of at least 80 percent of the average, annual total suspended solids loading is removed, or (b) postdevelopment loadings of TSS are less than or equal to predevelopment loadings; and	- Selected practices known to achieve 80% TSS removal are designed and installed. - Selected practices are inspected and maintained to ensure operational efficiency. - Structural practices are inspected after major storms.
	2. To the greatest extent practicable, postdevelopment volume and peak runoff rates are similar to predevelopment levels.	
Watershed Protection for New Development or Redevelopment Including New and Relocated Roads, Highways, and Bridges	Develop a watershed protection program to:	- Legislative authorities establish local planning and zoning controls.
	1. Avoid conversion, to the extent practicable, of areas that are particularly susceptible to erosion and sediment loss;	- Opportunity for community group and local organization involvement is built into approval mechanisms.
	2. Preserve areas that provide water quality benefits and/or are necessary to maintain riparian and aquatic biota; and	
	3. Site development, including roads, highways, and bridges, to protect, to the extent practicable, the natural integrity of waterbodies and natural drainage systems.	

Table 8-5. (Continued)

Management Measure Category	Management Measure	Typical Operation and Maintenance Procedures
Site Development, Including Roads, Highways, and Bridges	Plan, design, and develop sites to:	- Erosion and sediment control plans are reviewed.
	1. Protect areas that provide important water quality benefits and/or are particularly susceptible to erosion and sediment loss;	- Site plans are reviewed for approval to ensure appropriate practices are included.
	2. Limit increases of impervious areas except where necessary;	
	3. Limit land disturbance activities such as clearing and grading, and cut and fill to reduce erosion and sediment loss; and	
	4. Limit disturbance of natural drainage features and vegetation.	
Construction Site Erosion and Sediment Control	1. Reduce erosion and, to the extent practicable, retain sediment onsite during and after construction and	- Site vegetation and structural practices are periodically inspected.
	2. Prior to land disturbance, prepare and implement an approved erosion and sediment control plan or similar administrative document that contains erosion and sediment control provisions.	- Area exposed to development is limited and stabilized in a reasonable period of time. - Post-storm inspections are conducted.
Construction Site Chemical Control	1. Limit application, generation, and migration of toxic substances;	- Toxic and nutrient management programs and plans, including spill prevention and control, are developed and implemented.
	2. Ensure the proper storage and disposal of toxic materials; and	
	3. Apply nutrients at rates necessary to establish and maintain vegetation without causing significant nutrient runoff to surface waters.	- Proper facilities for storage of construction equipment and machinery are maintained.
Onsite Disposal Systems	New Onsite Disposal Systems	- Postconstruction inspection is performed to ensure proper installation.

Table 8-5. (Continued)

Management Measure Category	Management Measure	Typical Operation and Maintenance Procedures
Onsite Disposal Systems (continued)	Operating Onsite Disposal Systems	<ul style="list-style-type: none"> - Failing systems are inspected and repaired or replaced before property is to be sold. - The septic tank is regularly pumped (at least once every 5 years).
Runoff from Existing Development	<p>Develop and implement watershed management programs to reduce runoff pollutant concentrations and volumes from existing development.</p> <ol style="list-style-type: none"> 1. Identify priority local and/or regional watershed pollutant reduction opportunities, e.g., improvements to existing urban runoff control structures; 2. Contain a schedule for implementing appropriate controls; 3. Limit destruction of natural conveyance systems; and 4. Where appropriate, preserve, enhance, or establish buffers along surface waterbodies and their tributaries. 	<ul style="list-style-type: none"> - Structural practices are inspected and maintained annually or more frequently. Accumulated sediment and debris are removed annually or more often if necessary. - The structural integrity of practices is inspected. - The tops of infiltration facilities are raked or removed and replaced annually or more often if needed to prevent clogging of soil pores. - Vegetative practices are mowed as needed.

Table 8-5. (Continued)

Management Measure Category	Management Measure	Typical Operation and Maintenance Procedures
Pollution Prevention	<p>Implement pollution prevention and education programs to reduce nonpoint source pollutants generated from the following activities, where applicable:</p> <ol style="list-style-type: none"> 1. Household hazardous waste; 2. Lawn and garden activities; 3. Turf management on golf courses, parks, and recreational areas; 4. Improper operation and maintenance of onsite disposal systems; 5. Discharge of pollutants into storm drains; 6. Commercial areas not under NPDES purview; and 7. Pet waste disposal. 	<ul style="list-style-type: none"> - The success of public education and level of participation are reviewed annually. - Program is improved and expanded into additional areas.
Roads, Highways, and Bridges	<p>Plan, site, and develop roads and highways to:</p> <ol style="list-style-type: none"> 1. Protect areas that provide important water quality benefits or are particularly susceptible to erosion or sediment loss; 2. Limit land disturbance to reduce erosion and sediment loss; and 3. Limit disturbance of natural drainage features and vegetation. <p>Site, design, and maintain bridge structures so that sensitive and valuable aquatic ecosystems and areas providing important water quality benefits are protected from adverse effects.</p>	<ul style="list-style-type: none"> - Selected practices known to achieve 80% TSS removal are designed and installed at post-development. - Site plans are reviewed to ensure appropriate practices are included. - Erosion and sediment control plan is implemented. - Drainage systems are inspected to ensure operational efficiency. - Entry of paint chips, abrasives, and solvents to waters during bridge maintenance is minimized.

Table 8-5. (Continued)

Management Measure Category	Management Measure	Typical Operation and Maintenance Procedures
Roads, Highways, and Bridges (continued)	1. Reduce erosion and, to the extent practicable, retain sediment onsite during and after construction; and	- Vegetation is inspected regularly and mowed as needed.
	2. Prior to land disturbance, prepare and implement an approved erosion control plan or similar administrative document that contains erosion and sediment control provisions.	- Slope cut-and-fill areas are inspected to ensure stability. - Retrofit practices are installed where needed.
	1. Limit the application, generation, and migration of toxic substances;	- Instructions and State regulations for fertilizer and pesticide application are followed.
	2. Ensure the proper storage and disposal of toxic materials; and	- Spill prevention, containment, and cleanup plans are implemented for toxics and hazardous substances.
	3. Apply nutrients at rates necessary to establish and maintain vegetation without causing significant nutrient runoff to surface water.	- Workers are informed of the correct methods of storage and disposal and of the harmful effects to the environment if storage and disposal are not done correctly.
	Incorporate pollution prevention procedures into the operation and maintenance of roads, highways, and bridges to reduce pollutant loadings to surface waters.	- Road, highway, and bridge operation and maintenance guidelines are reviewed. - An inspection program is implemented to ensure that operation and maintenance guidelines are fully implemented.

Table 8-5. (Continued)

Management Measure Category	Management Measure	Typical Operation and Maintenance Procedures
Roads, Highways, and Bridges (continued)	Develop and implement runoff management systems for existing roads, highways, and bridges to reduce runoff pollutant concentrations and volumes entering surface waters.	- Structural practices are inspected and accumulated sediment and debris are removed annually or more often if necessary.
	1. Identify priority and watershed pollutant reduction opportunities (e.g., improvements to existing urban runoff control structures) and	- Structural integrity of practices is inspected.
	2. Establish schedules for implementing appropriate controls.	- Infiltration facilities are inspected and cleaned annually to prevent clogging of soil pores.
		- Vegetative practices are mowed as needed, but not within 50-100 feet of waterways with steep banks.

d. Marinas and Recreational Boating

Potential adverse effects of recreational boating include degradation of water quality, degradation of sediment quality, destruction of habitat, increased turbidity, and shoreline and shallow area erosion. Proper design and operation of marinas can result in reductions in these adverse impacts to the environment. However, poorly designed or managed marinas can pose additional environmental hazards including dissolved oxygen deficiencies; concentration of pollutants from boat maintenance, operation, and repair; transport of runoff from impervious surfaces into coastal waters; and destruction of coastal habitat areas.

Management practices typically used to ensure proper operation and maintenance of marinas and boats include both the development of regular schedules for inspecting, cleaning, and repairing facilities and the implementation of education programs for boaters and marina owners and operators. Examples of O&M procedures and techniques for marinas and recreational boating management measures are presented in Table 8-6.

Table 8-6. Typical Operation and Maintenance Procedures for Marinas and Recreational Boating Management Measures

Management Measure	Management Practice	Typical Operation and Maintenance Procedures
Shoreline Stabilization	Structural practices	- Structures are periodically inspected, and repaired or replaced as necessary.
	Vegetative practices	- Growth is inspected periodically and after major storm events, with replanting as needed.
Decrease Turbidity and Physical Destruction of Shallow-Water Habitat Resulting from Boating Activities	Exclude motorized vessels from areas that contain important shallow-water habitat.	- Condition of signs to advise boaters against damaging habitat is inspected periodically during boating season.
	Establish and enforce no-wake zones to decrease turbidity.	- Location of speed zone signs are reviewed for potential to prevent damage to habitat.
Storm Water Runoff	Treat runoff from hull maintenance areas to remove at least 80 percent of the average annual total suspended solids. Sand filters and wet ponds are among the practice options.	- Practices are inspected frequently and appropriate maintenance is provided.
	Prevent generation of pollutants from hull maintenance areas through use of sanders with vacuum attachments, use of tarpaulins, and other practices.	- Hull maintenance areas are inspected regularly and swept/vacuumed as required.
	Prevent organic compounds from boats from entering coastal waters.	- Boats with inboard engines have oil absorbing materials placed in bilge areas. These materials are examined for replacement at least once per year. Used-pad containers are checked for presence of used pads.

Table 8-6. (Continued)

Management Measure	Management Practice	Typical Operation and Maintenance Procedures
Storm Water Runoff (continued)	Minimize boat cleaners, solvents, and paint from entering the coastal waters.	<ul style="list-style-type: none"> - In-water hull cleaning and the use of cleaners and solvents on boats in the water are minimized. Water only or phosphate-free detergents are used to clean boats. Use of detergents containing ammonia, sodium hypochlorite, chlorinated solvents, petroleum distillates, or lye is discouraged.
	Institute public education, outreach, and training programs for boaters and marina owners and operators on proper disposal methods.	<ul style="list-style-type: none"> - Promotional material and instructional signs are used to spread messages. Presentations, workshops, and seminars on pollution prevention are provided at local marinas.
Sewage Facility for New and Expanding Marinas	Pumpout facilities, dump stations for portable stations, and restroom facilities	<ul style="list-style-type: none"> - Pumpout facilities, dump stations, and restrooms are inspected, serviced, and maintained on a regular schedule. Repairs are made as needed.
		<ul style="list-style-type: none"> - Dye tablets can be placed in holding tanks to discourage illegal disposal.
Solid Waste from the Operation, Cleaning, Maintenance, and Repair of Boats	Waste disposal facilities for marina customers	<ul style="list-style-type: none"> - Waste disposal facilities are inspected and maintained routinely. - Hazardous waste containers are inspected periodically for leaks.
	Provide facilities for recycling.	<ul style="list-style-type: none"> - Use of recycling facilities is routinely inspected for appropriate separation of materials. - Receipts from pickup of materials are retained for inspection.

Table 8-6. (Continued)

Management Measure	Management Practice	Typical Operation and Maintenance Procedures
Liquid Material	Marinas should provide appropriate facilities for the storage, transfer, containment, and disposal of liquid by-products from maintenance, repair, and operation of boats.	<ul style="list-style-type: none"> - Containers are checked to see whether they are clearly marked and available for customer use at all times. - Separate containers for waste oil, waste gasoline, used antifreeze (where recycling is available), and other chemicals are provided.
	Encourage recycling.	<ul style="list-style-type: none"> - Marina educational materials are reviewed for information regarding recycling. - Site is inspected for the availability of recycling facilities.

e. Hydromodification

Operation and maintenance procedures for hydromodification management measures typically involve periodic inspection of structures and features (particularly after storm events), clearing of debris not needed for habitat, and repair or replacement of structures and features as required. Examples of procedures to ensure adequate operation and maintenance of management measures during hydromodification are presented in Table 8-7.

Table 8-7. Typical Operation and Maintenance Procedures for Hydromodification Management Measures

Management Measure	Management Practice	Typical Operation and Maintenance Procedures
Instream and Riparian Habitat Restoration for Channelization and Channel Modification	Use models/methodologies to evaluate the effects of proposed channelization and channel modification projects on habitat.	<ul style="list-style-type: none"> - Model limitations, applicability, and accuracy and precision are reviewed prior to use. Model inputs are developed and modeling is performed under an approved quality assurance/quality control program.
	Identify and evaluate appropriate BMPs for use in the design of proposed channelization or channel modification projects or in the operation and maintenance program of existing projects.	<ul style="list-style-type: none"> - BMP systems are developed that include an appropriate mix of streambank protection, levee protection, channel stabilization and flow restrictors, check dam systems, grade control structures, vegetative cover, instream sediment load control, noneroding roadways, setback levees, and flood walls. Cumulative beneficial impacts of the BMPs are evaluated.
Physical and Chemical Characteristics of Surface Waters (Channelization and Channel Modification)	Use models/methodologies to evaluate the effects of proposed channelization and channel modification projects.	<ul style="list-style-type: none"> - Model limitations, applicability, and accuracy and precision are reviewed prior to use. Model inputs are developed and modeling is performed under an approved quality assurance/quality control program.
	Identify and evaluate appropriate BMPs for use in the design of proposed channelization or channel modification projects or in the operation and maintenance programs of existing projects.	<ul style="list-style-type: none"> - BMP systems are developed that include an appropriate mix of streambank protection, levee protection, channel stabilization and flow restrictors, check dam systems, grade control structures, vegetative cover, instream sediment load control, noneroding roadways, setback levees, and flood walls. Cumulative beneficial impacts of the BMPs are evaluated.

f. Dams

Examples of typical O&M procedures for ensuring adequate performance of management measures for dams are presented in Table 8-8.

Table 8-8. Typical Operation and Maintenance Procedures for Management Measures for Dams

Management Measure	Management Practice	Typical Operation and Maintenance Procedures
Erosion and Sediment Control During and After Construction	Soil bioengineering, grading and sediment control practices, streambank and streambed erosion controls	<ul style="list-style-type: none"> - Periodic inspections are performed to determine whether disturbed areas are stabilized. - Features are repaired and replaced as needed. - Grassed waterways are mowed as needed. - Waterways are cleared of debris not needed for habitat. - Fertilizer and lime are applied only as needed.
	Prior to land disturbance, prepare and implement an approved erosion and sediment control plan or similar administrative document.	<ul style="list-style-type: none"> - Plan is reviewed for inclusion of provisions to preserve existing vegetation where possible and control sediment in runoff from the construction area.
Protection of Surface Water Quality and Instream and Riparian Habitat During Dam Operation	Turbine venting, surface water pumps, high purity oxygen injection, diffused aeration, and/or oxygenation to aerate reservoir waters and releases	<ul style="list-style-type: none"> - Back-up power supply is provided and periodically tested. - Oxygen tanks are replaced as needed. - Optimal location(s) of aeration or oxygenation are determined based on water quality monitoring.
	Re-regulation weir, small turbines, frequent pulsing, sluice modification, spillway modification to improve oxygen levels in tailwaters	<ul style="list-style-type: none"> - Site-specific O&M procedures are followed and adjusted as needed. - Debris not needed for habitat are cleared. - Periodic inspections are performed.

Table 8-8. (Continued)

Management Measure	Management Practice	Typical Operation and Maintenance Procedures
Protection of Surface Water Quality and Instream and Riparian Habitat During Dam Operation (continued)	Selective withdrawal	<ul style="list-style-type: none"> - Release water temperature is monitored to determine effectiveness of selective withdrawal.
	Watershed protection	<ul style="list-style-type: none"> - Watershed modeling is conducted. - Periodic inspections of watershed land use and management practices are performed. Adjustments to control practices are made on a site-specific basis as needed.
	Flow augmentation	<ul style="list-style-type: none"> - Minimum flows are maintained to support downstream habitat. - Gates and channels are cleared of debris not needed for habitat.
	Reduce flow fluctuations	<ul style="list-style-type: none"> - Flow fluctuations are evaluated and adjusted as needed.
	Fish ladders, screens and barriers to prevent fish from entering water pumps and turbines	<ul style="list-style-type: none"> - Gates, channels, and weirs are cleared of debris not needed for habitat.
Chemical/Pollutant Control During and After Construction	Spill containment procedures	<ul style="list-style-type: none"> - An emergency spill containment plan is prepared and evaluated. - Periodic inspections are conducted to see whether items necessary for spill containment are on-hand.
	Treatment or detention of concrete washout	<ul style="list-style-type: none"> - Treatment or detention facilities are periodically inspected and maintained.

g. Shoreline Erosion

In shoreline and streambank areas requiring erosion protection from water flow and wave action, shoreline structures such as breakwaters, jetties, groins, bulkheads, and revetments are often constructed. In addition, nonstructural measures (e.g., marsh creation and vegetative bank stabilization) are often used in protecting shorelines and streambanks from erosive forces. Typical O&M procedures for ensuring adequate performance of these measures against erosion include monitoring for erosion, making structural or nonstructural modifications as needed, performing periodic inspection of the erosion control systems, and performing repair and replacement as required. Table 8-9 presents examples of typical O&M procedures for shoreline erosion management measures.

h. Protection of Existing Wetlands and Riparian Zones

Wetlands provide many beneficial uses including habitat, flood attenuation, water quality improvement, shoreline stabilization, and ground-water recharge. Wetlands can play a critical role in reducing nonpoint source pollution problems in open bodies of water by trapping or transforming pollutants before releasing them to adjacent waters. Their role in water quality includes processing, removing, transforming, and storing such pollutants as sediment, nitrogen, phosphorus, pesticides, and certain heavy metals.

The loss of wetland and riparian areas as buffers between uplands and the parent waterbody allows for more direct contribution of nonpoint source pollutants to the aquatic ecosystem. Often, loss of these areas occurs at the same time as the alteration of land features, which increases the amount of surface water runoff. As a result, excessive fresh water, nutrients, sediments, pesticides, oils, greases, and heavy metals from nearby land use activities may be carried in runoff from storm events and discharged to surface and ground water. Without wetlands these nonpoint source pollutants travel downstream to coastal waters without the benefits of filtration and attenuation that would normally occur in the wetland or riparian area.

Wetland and riparian areas also provide important habitat functions. Protection of wetlands and riparian zones provides both nonpoint source control and other corollary benefits of these natural aquatic systems although adverse impacts on wetlands from nonpoint source pollutants can occur. Such impacts can be minimized through pretreatment with stormwater management practices. Land managers should, therefore, use proper management techniques to protect and restore the multiple benefits of these systems. Examples of typical O&M procedures for ensuring adequate performance of measures to protect existing wetlands and riparian areas are provided in Table 8-10.

i. Restoration of Wetland and Riparian Areas

Restoration of wetlands refers to reestablishing a wetland and its range of functions where one previously existed by reestablishing the hydrology, vegetation, and other habitat characteristics. Restoration of wetlands and riparian areas in the watershed have been shown to result in nonpoint source control benefits.

A combination of practices may be implemented to restore preexisting functions in damaged and destroyed wetlands and riparian systems in areas where they could serve a nonpoint source control function. Examples of typical O&M procedures for ensuring adequate performance of measures to restore wetlands and riparian areas are provided in Table 8-11.

Table 8-9. Typical Operation and Maintenance Procedures for Shoreline Erosion Management Measures

Management Measure	Management Practice	Typical Operation and Maintenance Procedures
Management Measure for Eroding Streambanks (Coastal Rivers and Creeks) and Shorelines (Coastal Bays)	Protect naturally occurring features.	<ul style="list-style-type: none"> - Changes in natural conditions resulting from installed shoreline structures are regularly evaluated. - Structures and operations are modified as necessary if detrimental changes to naturally occurring features are found.
	Biostabilization and marsh creation to restore habitat	<ul style="list-style-type: none"> - Vegetation is limed and fertilized only as needed. - Growth is inspected periodically and after major storm events, with replanting as needed.
	Shore revetment or bulkheads	<ul style="list-style-type: none"> - Structures are periodically inspected and repaired or replaced as needed.
	Minimize or prevent transfer of erosion energy.	<ul style="list-style-type: none"> - Changes in natural conditions resulting from installed shoreline structures are regularly evaluated. - Structures and operations are modified as necessary if detrimental changes to naturally occurring features are found. - Energy-dissipating structures are inspected and repaired or replaced as needed
	Return walls for bulkheads or revetments	<ul style="list-style-type: none"> - The structural integrity of tie-backs is periodically inspected. Repairs as needed.
	Minimize erosion from boat wakes.	<ul style="list-style-type: none"> - Erosion is monitored and boating speed zone designations are revised as needed.

Table 8-10. Typical Operation and Maintenance Procedures for Management Measure for Protection of Existing Wetlands and Riparian Areas

Management Measure	Management Practice	Typical Operation and Maintenance Procedures
Protect from adverse effects wetlands and riparian areas that are serving a significant NPS abatement function and maintain this function while protecting the other existing functions of these wetlands and riparian areas.	Identify existing functions of those wetlands and riparian areas with NPS control potential when implementing NPS management practices. Do not alter these systems to improve their water quality function at the expense of other functions as U.S. waters.	<ul style="list-style-type: none"> - Existing functions of wetland are maintained by limiting activities in and around wetland and riparian areas. - Periodic assessments of the wetland are conducted to document any changes in function.
	Conduct permitting, licensing, certification, and nonregulatory NPS activities to protect existing beneficial uses and meet water quality standards.	Not available.

Table 8-11. Typical Operation and Maintenance Procedures for Management Measure for Restoration of Wetlands and Riparian Areas

Management Measure	Management Practice	Typical Operation and Maintenance Procedures
Promote restoration of preexisting functions in damaged and destroyed wetlands and riparian systems in areas where they will serve a significant NPS pollution abatement function.	Provide a hydrologic regime similar to that of the type of wetland or riparian area being restored.	<ul style="list-style-type: none"> - The maintenance or restoration of NPS function and beneficial uses is assessed by monitoring such factors as water quality, vegetative cover, and structural changes. - The effectiveness of restoration is monitored by assessing the ecological health of the community and the habitat use by wildlife species.
	Restore native plant species through either natural succession or selective planting.	
	When possible, plan restoration of wetlands and riparian areas as part of naturally occurring aquatic ecosystems. Factor in ecological principles such as seeking high habitat diversity and high productivity. Maximize connectedness between different habitat types. Provide refuge or migration corridors.	

j. Vegetated Treatment Systems

Runoff water quality management methods, referred to as biofiltration methods, have been shown to provide significant reductions in pollutant delivery. These include vegetated filter strips, grassed swales or vegetated channels, and created wetlands. When properly installed and maintained, biofiltration methods have been shown to effectively prevent the entry of sediment and sediment-bound pollutants, nutrients, and oxygen-consuming substances into waterbodies.

A combination of practices can be used to manage vegetated treatment systems. Examples of typical O&M procedures for ensuring adequate performance of these systems are provided in Table 8-12.

Table 8-12. Typical Operation and Maintenance Procedures for Management Measure for Vegetated Treatment Systems

Management Measure	Management Practice	Typical Operation and Maintenance Procedures
Promote the use of engineered vegetated treatment systems such as constructed wetlands or vegetated filter strips where these systems will serve a significant NPS pollution abatement function.	Construct properly engineered systems of wetlands for NPS pollution control. Manage these systems to avoid negative impacts on surrounding ecosystems or ground water.	- Vegetation is harvested periodically and disposed of properly; forbays and deep water are inspected to determine sediment loading rate; and if sediment levels exceed design limits, excess sediment is removed from the system and disposed of appropriately. Other maintenance includes wildlife management, mosquito control, and litter and debris removal.
	Construct vegetated filter strips in areas adjacent to waterbodies that may be subject to sediment, suspended solids, and/or nutrient runoff.	- Vegetation is mowed periodically and residue harvested; filter strips are inspected periodically to determine whether concentrated flows are bypassing or overwhelming the device; accumulated sediment and particulate matter are removed at regular intervals to prevent inundation; and all traffic is limited.

IV. REFERENCES

- Brakensiek, D.L., H.B. Osborn, and W.J. Rawls, coordinators. 1979. *Field Manual for Research in Agricultural Hydrology*. U.S. Department of Agriculture, Washington, DC. Agricultural Handbook 224.
- Brossman, M.W. 1988. *The EPA Quality Assurance/Quality Control Program*. U.S. Environmental Protection Agency, Office of Water, Washington, DC.
- Clausen, J.C. 1985. The St. Albans Bay Watershed RCWP: A Case Study of Monitoring and Assessment. In *Perspectives on Nonpoint Source Pollution, Proceedings of a National Conference*, May 19-22, 1985, Kansas City, MO. U.S. Environmental Protection Agency, Washington, DC. EPA 440/5-85-001.
- Cochran, W.G. 1963. *Sampling Techniques*. John Wiley & Sons, Inc., New York.
- Cochran, W.G. 1977. *Sampling Techniques*. 3rd ed. John Wiley & Sons, Inc., New York.
- Coffey, S.W., and M.D. Smolen. 1990. *The Nonpoint Source Manager's Guide to Water Quality Monitoring - Draft*. Developed under EPA Grant Number T-9010662. U.S. Environmental Protection Agency, Water Management Division, Region 7, Kansas City, MO.
- Davenport, T.E., and M.H. Kelly. 1984. *Soil Erosion and Sediment Transport Dynamics in Blue Creek Watershed, Pike County, Illinois*. Illinois Environmental Protection Agency, Planning Section, Water Pollution Control, Springfield, IL. IEPA/WPC/83-004.
- Freund, J.E. 1973. *Modern Elementary Statistics*. Prentice-Hall, Englewood Cliffs, NJ.
- Gilbert, R.O. 1987. *Statistical Methods for Environmental Pollution Monitoring*. Van Nostrand Reinhold, New York.
- Goodman, J., J.M. Collins, and K.B. Rapp. 1992. Nitrate and Pesticide Occurrence in Shallow Groundwater During the Oakwood Lakes-Poinsett RCWP Project. In *The National Rural Clean Water Program Symposium, 10 Years of Controlling Agricultural Nonpoint Source Pollution: The RCWP Experience*, Seminar Publication. U.S. Environmental Protection Agency, Office of Research and Development and Office of Water, Washington, DC. EPA/625/R-92/006.
- Hughes, R.M., D.P. Larsen, and J.M. Omernik. 1986. Regional Reference Sites: A Method for Assessing Stream Potentials. *Environmental Management*, 10:629-635.
- Klemm, D., P.A. Lewis, F. Fulk, and J.M. Lazorchak. 1990. *Macroinvertebrate Field and Laboratory Methods for Evaluating the Biological Integrity of Surface Waters*. U.S. Environmental Protection Agency, Office of Research and Development, Washington, DC. EPA/600/4-90/030.
- Lietman, P.L. 1992. Effects of Pipe-Outlet Terracing on Runoff Water Quantity and Quality at an Agricultural Field Site, Conestoga River Headwaters, Pennsylvania. In *The National Rural Clean Water Program Symposium, 10 Years of Controlling Agricultural Nonpoint Source Pollution: The RCWP Experience*, Seminar Publication. U.S. Environmental Protection Agency, Office of Research and Development and Office of Water, Washington, DC. EPA/625/R-92/006.
- MacDonald, L.H. 1991. *Monitoring Guidelines to Evaluate Effects of Forestry Activities on Streams in the Pacific Northwest and Alaska*. U.S. Environmental Protection Agency, Region 10, Nonpoint Source Section, Seattle, WA. EPA/910/9-91-001.
- Meals, D.W. 1991a. Developing NPS Monitoring Systems for Rural Surface Waters: Watershed Trends. In *Nonpoint Source Watershed Workshop, Nonpoint Source Solutions*, Seminar Publication. U.S. Environmental Protection Agency, Office of Research and Development and Office of Water, Washington, DC. EPA/625/4-91/027.

- Meals, D.W. 1991b. Surface Water Trends and Land-use Treatment. In *Nonpoint Source Watershed Workshop, Nonpoint Source Solutions*, Seminar Publication. U.S. Environmental Protection Agency, Office of Research and Development and Office of Water, Washington, DC. EPA/625/4-91/027.
- Meals, D.W. 1992. Water Quality Trends in the St. Albans Bay, Vermont, Watershed Following RCWP Land Treatment. In *The National Rural Clean Water Program Symposium, 10 Years of Controlling Agricultural Nonpoint Source Pollution: The RCWP Experience*, Seminar Publication. U.S. Environmental Protection Agency, Office of Research and Development and Office of Water, Washington, DC. EPA/625/R-92/006.
- Meals, D.W., D. Lester, and J. Clausen. 1991. *St. Albans Bay Rural Clean Water Program Final Report 1991, Section 7.2*. Water Resources Research Institute, Vermont RCWP Coordinating Committee, University of Vermont, Burlington.
- Mosteller, F., and J. W. Tukey. 1977. *Data Analysis and Regression: A Second Course in Statistics*. Addison-Wesley, Reading, MA.
- Mumley, T.E. 1991. Monitoring Program Development in an Urban Watershed. In *Nonpoint Source Watershed Workshop, Nonpoint Source Solutions*, Seminar Publication. U.S. Environmental Protection Agency, Office of Research and Development and Office of Water, Washington, DC. EPA/625/4-91/027.
- Ohio EPA. 1988. *Biological Criteria for the Protection of Aquatic Life: Volume II: Users Manual for Biological Field Assessment of Ohio Surface Waters*. Ohio Environmental Protection Agency, Division of Water Quality Planning and Assessment, Columbus, OH.
- Omerik, J.M. and A.L. Gallant. 1986. *Ecoregions of the Pacific Northwest*. U.S. Environmental Protection Agency, Environmental Research Laboratory, Corvallis, OR. EPA/600/3-86/033.
- Plafkin, J.L. M.T. Barbour, K.D. Porter, S.K. Gross, and R.M. Hughes. 1989. *Rapid Bioassessment Protocols for Use in Streams and Rivers: Benthic Macroinvertebrates and Fish*. U.S. Environmental Protection Agency, Office of Water, Washington, DC. EPA/444/4-89-001.
- Platts, W.S., C. Armour, G.D. Booth, M. Bryant, J.L. Bufford, P. Cuplin, S.Jensen, G.W. Lienkaemper, G.W. Minshall, S.B. Monsen, R.L. Nelson, and J.S. Tuhy. 1987. *Methods for Evaluating Riparian Habitats with Applications to Management*. General Technical Report INT-221. U.S. Department of Agriculture, Forest Service, Intermountain Research Station, Ogden, UT.
- Platts, W.S., and R.L. Nelson. 1988. Fluctuations in Trout Populations and Their Implications for Land-use Evaluation. *North American Journal of Fisheries Management*, 8:333-345.
- Ray, G.A., and W.F. Megahan. 1978. *Measuring Cross Sections Using A Sag Tape: a Generalized Procedure*. General Technical Report INT-47. U.S. Department of Agriculture, Forest Service, Intermountain Forest and Range Experiment Station, Ogden, UT.
- Reckhow, K.H. 1979. Sampling Designs for Lake Phosphorus Budgets. In *Establishment of Water Quality Monitoring Programs, Proceedings of a Symposium*, San Francisco, CA, 12-14 June 1978, ed. L.G. Everett and K.D. Schmidt. American Water Resources Association, Minneapolis, MN.
- Remington, R.D., and M.A. Schork. 1970. *Statistics with Applications to the Biological and Health Sciences*. Prentice-Hall, Englewood Cliffs, NJ.
- Sherwani, J.K., and D.H. Moreau. 1975. *Strategies for Water Quality Monitoring*. Report No. 107. Water Resources Research Institute of the University of North Carolina, Raleigh, NC.

- Spooner, J. 1990. *Determining and Increasing the Statistical Sensitivity of Nonpoint Source Control Grab Sample Monitoring Programs*. Ph.D. diss., North Carolina State University, Raleigh.
- Spooner, J., R.P. Maas, S.A. Dressing, M.D. Smolen, and F.J. Humenik. 1985. Appropriate Designs for Documenting Water Quality Improvements from Agricultural Nonpoint Source Programs. In *Perspectives on Nonpoint Pollution*. U.S. Environmental Protection Agency, Washington, DC. EPA 440/5-85-001.
- Spooner, J., C.J. Jamieson, R.P. Maas, and M.D. Smolen. 1987a. Determining Statistically Significant Changes in Water Pollutant Concentrations. *Journal of Lake and Reservoir Management*, 3:195-201.
- Spooner, J., R.P. Maas, M.D. Smolen, and C.A. Jamieson. 1987b. Increasing the Sensitivity of Nonpoint Source Control Monitoring Programs. In *Symposium on Monitoring, Modeling, and Mediating Water Quality*, May 1987, pp. 242-257. American Water Resources Association, Minneapolis, MN.
- Spooner, J., S.W. Coffey, J.A. Gale, A.L. Lanier, S.L. Brichford, and M.D. Smolen. 1991. *NWQEP Report: Water Quality Monitoring Report for Agricultural Nonpoint Source Pollution Control Projects - Methods and Findings from the Rural Clean Water Program*. North Carolina State University, Biological and Agricultural Engineering Department, Raleigh.
- Stein, J., ed. 1980. *The Random House College Dictionary*. Random House, Inc., New York.
- Striffler, W.D. 1965. The Selection of Experimental Watersheds and Methods in Disturbed Forest Areas. In *Publication No. 66 of the I.A.S.H. Symposium of Budapest*.
- USACE. 1986. *Statistical Methods for Reservoir Water Quality Investigations*, technical ed. R.F. Gaugush. Instruction Report E-86-2. U.S. Army Corps of Engineers, Waterways Experiment Station, Vicksburg, MS.
- USEPA. 1978. *Microbiological Methods for Monitoring the Environment*. U.S. Environmental Protection Agency, Office of Research and Development, Cincinnati, OH. EPA-600/8-78-017.
- USEPA. 1982a. *Chesapeake Bay: Introduction to an Ecosystem*. U.S. Environmental Protection Agency, Chesapeake Bay Program, Annapolis, MD.
- USEPA. 1982b. *Results of the Nationwide Urban Runoff Program, Volume II - Appendices*. U.S. Environmental Protection Agency, Water Planning Division, Washington, DC.
- USEPA. 1984. *Policy and Program Requirements to Implement the Quality Assurance Program*. EPA Order 5360.1. U.S. Environmental Protection Agency, Washington, DC.
- USEPA. 1986. *Development of Data Quality Objectives*. EPA Quality Assurance Management Staff, U.S. Environmental Protection Agency, Washington, DC.
- USEPA. 1987. *An Overview of Sediment Quality in the United States*. U.S. Environmental Protection Agency, Office of Water, Washington, DC, and U.S. Environmental Protection Agency Region 5, Chicago IL. EPA-905/9-88-002.
- USEPA. 1991a. *Monitoring Guidance for the National Estuary Program, Interim Final*. U.S. Environmental Protection Agency, Office of Water, Washington, DC. EPA-503/8-91-002.
- USEPA. 1991b. *Watershed Monitoring and Reporting for Section 319 National Monitoring Program Projects*. U.S. Environmental Protection Agency, Office of Water, Washington, DC.
- Vermont RCWP Coordinating Committee. 1984. *St. Albans Bay Rural Clean Water Program Summary Report, 1984*. U.S. Department of Agriculture and Vermont Water Resources Research Center, Burlington, VT.
- Wetzel, R.G. 1975. *Limnology*. Saunders College Publishers, Philadelphia, PA.