



UNITED STATES ENVIRONMENTAL PROTECTION AGENCY  
GREAT LAKES NATIONAL PROGRAM OFFICE  
77 WEST JACKSON BOULEVARD  
CHICAGO, IL 60604-3590

Donald Zelazny  
Great Lakes Programs Coordinator - NYSDEC  
270 Michigan Avenue  
Buffalo, NY 14203-2915

Dear Mr. Zelazny:

Thank you for your September 13, 2022 request to remove the *Bird or Animal Deformities or Reproduction Problems* Beneficial Use Impairment (BUI) at the Rochester Embayment Area of Concern (AOC) located in Monroe County, NY. As you know, we share your desire to restore all the Great Lakes AOCs and to formally delist them.

Based upon a review of your submittal and the supporting data, the U.S. Environmental Protection Agency (EPA) approves your request to remove this BUI from the Rochester Embayment AOC. EPA will notify the International Joint Commission (IJC) of this significant positive environmental change at this AOC.

We congratulate you and your staff and the Monroe County Department of Public Health (MCDPH) as well as the many other federal, state and local partners who have been instrumental in achieving this environmental improvement. Removal of this BUI will benefit not only the people who live and work in the Rochester Embayment AOC, but all the residents of New York and the Great Lakes Basin as well.

We look forward to the continuation of this important and productive relationship with your agency and the Rochester Embayment Remedial Advisory Committee as we work together to delist this AOC in the years to come. If you have any further questions, please contact me at (312) 353-8320 or your staff can contact Leah Medley at (312) 886-1307.

Sincerely,

CHRISTOPHER  
KORLESKI

Digitally signed by CHRISTOPHER  
KORLESKI  
Date: 2022.09.16 14:12:14 -05'00'

Chris Korleski, Director  
Great Lakes National Program Office

cc: Jim Lehnen, NYSDEC  
Starr O'Neil, MCDPH  
Raj Bejankiwar, IJC

Bcc: Richard Balla, USEPA Region 2  
Kristina Heinemann, USEPA Region 2  
Christopher Seslar, USEPA Region 2

# NEW YORK STATE DEPARTMENT OF ENVIRONMENTAL CONSERVATION

## Great Lakes Programs

700 Delaware Avenue, Buffalo, NY 14209

P: (716) 851-7070 | F: (716) 851-7009

[www.dec.ny.gov](http://www.dec.ny.gov)

September 13, 2022

Chris Korleski, Director  
Great Lakes National Program Office  
U.S. Environmental Protection Agency  
77 West Jackson Boulevard  
Chicago, Illinois 60604-3507

Dear Chris Korleski:

I would like to request the U.S. Environmental Protection Agency's concurrence with the removal of the Rochester Embayment Area of Concern (AOC) *Bird or Animal Deformities or Reproduction Problems* Beneficial Use Impairment (BUI). The AOC encompasses an embayment of Lake Ontario at the mouth of the Genesee River, and the lower section of the river up to the Lower Falls in Rochester, N.Y. The Monroe County Department of Public Health (MCDPH) and the New York State Department of Environmental Conservation (NYSDEC) have determined that this impairment has been restored in the Rochester Embayment AOC to an extent that meets the criteria developed for removing the BUI designation.

The status of this BUI was originally listed as "Impaired" in the Stage I and II Remedial Action Plan (RAP) due to polychlorinated biphenyls (PCBs) detected in fish tissue samples at concentrations shown to cause reproductive failure in captive mink, and an observed absence of mink from the Rochester Embayment AOC. While there was also some evidence at the time of possible bird deformities, the reported incidences were associated with migratory birds, and it was determined that there was no way to define where exposures occur relative to the AOC boundary. As such, the removal criteria established for the BUI were limited to the impacts to mink reproduction, as follows:

- Mink are present and are reproducing, or levels of PCBs, dioxins/furans, Mirex, and mercury measured in the tissue of resident prey are below those known to be associated with mink reproductive failure.

Since the original designation of the *Bird or Animal Deformities or Reproduction Problems* BUI, many remedial and restorative efforts have been undertaken as part of regulatory and non-regulatory programs, some of which are not affiliated with the AOC program. Collectively, these efforts have addressed the underlying causes of the BUI: areas of known contaminated sediments in the lower Genesee River and soils at upland sites along the river have been or are currently being remediated; contaminant discharges are strictly regulated through state permitting programs; bans on the production of targeted chemicals (PCBs and Mirex) have been enacted; and, numerous habitat restoration projects within and adjacent to the AOC have been completed. These actions have reduced bioavailable contaminant levels and enhanced in-river and coastal wetland habitat, providing conditions more favorable to supporting mink populations.

Researchers at the State University of New York (SUNY) at Brockport conducted a series of studies in 2003 – 2007 and 2013 – 2015, that included various methods of monitoring for the presence of mink within the AOC, and also chemical analyses of mink and mink prey to determine tissue contaminant levels. The monitoring programs found direct evidence of mink presence and reproduction in the AOC, demonstrating attainment of the first component of the BUI removal criteria. And, through a combination of the tissue analyses noted above, scientific literature reviews on the potential impacts of the targeted contaminants (PCBs, dioxins/furans, Mirex, and mercury), and contaminant bioaccumulation modeling, the researchers concluded that contaminant levels in mink prey were not likely to result in mink reproductive failure, meeting the second component of the removal criteria.

Following an evaluation of the available data and evidence gathered to assess this impairment, the MCDPH as RAP Coordinator, the local Remedial Advisory Committee (RAC), and NYSDEC have determined that the conditions have been met for removal of the *Bird or Animal Deformities or Reproduction Problems* BUI from the Rochester Embayment AOC, and seek concurrence from USEPA at this time. The enclosed BUI Removal Report more fully describes the evaluation of the BUI and efforts supporting its removal, including the SUNY Brockport studies, the regulatory/remedial actions, and implementation of habitat restoration projects

On July 25, 2022, NYSDEC and MCDPH held a virtual public outreach event to present the rationale for removing the *Bird or Animal Deformities or Reproduction Problems* BUI to the public, after which time the draft BUI removal report was posted on the MCDPH website for a 30-day period. The public was encouraged to review the report and to provide comments or questions via email to MCDPH; no comments or questions were formally submitted by the public during this 30-day period.

If you need further information, please contact either Jim Lehnen, NYSDEC Statewide AOC Coordinator, at 716-851-7130 or Starr O'Neil, MCDPH/Rochester Embayment RAP Coordinator, at 585-753-5209. Thank you for your consideration of this request.

Sincerely,

*D. E. Zelazny*

Donald Zelazny  
Great Lakes Programs Coordinator

Enclosure

cc: Richard Balla, USEPA Region 2  
Kristina Heinemann, USEPA Region 2  
Christopher Seslar, USEPA Region 2  
Marc Tuchman, USEPA GLNPO  
Amy Pelka, USEPA GLNPO  
Jim Lehnen, NYSDEC  
Starr O'Neil, MCDPH





Department of  
Environmental  
Conservation

# Rochester Embayment Area of Concern

**BIRD OR ANIMAL DEFORMITIES OR REPRODUCTION PROBLEMS  
BENEFICIAL USE IMPAIRMENT REMOVAL REPORT**

**SEPTEMBER 2022**

Kathy Hochul, Governor | Basil Seggos, Commissioner





Rochester Embayment Area of Concern  
Bird or Animal Deformities or Reproduction Problems  
Beneficial Use Impairment (BUI) Removal Report

September 2022

Prepared by:

New York State Department of Environmental Conservation  
and  
Monroe County Department of Public Health

This Beneficial Use Impairment (BUI) Removal Report was prepared by the New York State Department of Environmental Conservation (NYSDEC) and the Monroe County Department of Public Health (MCDPH), and was substantially funded by the United States Environmental Protection Agency (USEPA) through the Great Lakes Restoration Initiative (GLRI). The NYSDEC and MCDPH have engaged stakeholders and the public, including the Remedial Advisory Committee (RAC), through the BUI removal process. For more information, please contact the Remedial Action Plan Coordinator at MCDPH or the AOC Coordinator at NYSDEC Division of Water.

# Table of Contents

<b>List of Abbreviations</b> .....	<b>2</b>
<b>1. Introduction and Report Purpose</b> .....	<b>3</b>
<b>2. Background and Beneficial Use Impairment</b> .....	<b>4</b>
2.1 BUI Removal Criteria .....	4
2.2 BUI Removal Considerations .....	5
2.3 Strategy and Rationale .....	5
<b>3. BUI Indicator Status Resolution</b> .....	<b>5</b>
3.1 SUNY Brockport Mink Studies (2003 – 2007) .....	5
3.2 Follow-Up SUNY Brockport Mink Studies (2013 – 2015) .....	7
3.3 Additional Information on the Mink Studies .....	8
<b>4. Additional Activities Supporting BUI Removal</b> .....	<b>8</b>
4.1 Contaminant Source Mitigation and Control .....	8
4.1.1 Remedial Program Cleanups .....	8
4.1.2 Wastewater and Stormwater Controls .....	9
4.1.3 Federal Regulation .....	9
4.2 Habitat Restoration Projects .....	9
4.2.1 Braddock Bay Ecosystem Restoration Project .....	9
4.2.2 USFWS Habitat Projects .....	10
4.2.3 Ducks Unlimited Habitat Projects .....	10
4.2.4 Kodak Natural Resource Damage Settlement Projects .....	10
<b>5. Public Outreach</b> .....	<b>11</b>
<b>6. Conclusions</b> .....	<b>11</b>
6.1 Removal Statement .....	11
6.2 BUI Removal Steps .....	12
6.3 Post-Removal Responsibilities .....	12
<b>References</b> .....	<b>13</b>
<b>Figures</b>	
Figure 1 – Rochester Embayment AOC Map .....	3
<b>Appendices</b>	
Appendix A – List of Remedial Advisory Committee Members & Letter of Support for BUI Removal	
Appendix B – RAP Progress in the Rochester Embayment of Lake Ontario: Population Monitoring, Trophic Relationships, and Levels of Bioaccumulative Chemicals of Concern in Mink, a Sentinel Species. SUNY Brockport, August 2007	
Appendix C – Final Report: BUI Delisting Studies in the Rochester Embayment AOC, 2013 – 2014. SUNY Brockport, December 2015	
Appendix D – Histological Assessment of Mink Jaws Collected during GLPF Project C30239: RAP Progress in the Rochester Embayment of Lake Ontario: Population Monitoring, Trophic Relationships, and Levels of Bioaccumulative Chemicals of Concern in Mink, a Sentinel Species (Supplemental Report)	

# List of Abbreviations

AOC	Area of Concern
BCC	Bioaccumulative Chemical Contaminant
BMP	Best Management Practice
BCP	Brownfield Cleanup Program
BUI	Beneficial Use Impairment
GLNPO	Great Lakes National Program Office
GLPF	Great Lakes Protection Fund
GLRI	Great Lakes Restoration Initiative
GLWQA	Great Lakes Water Quality Agreement
HSI	Habitat Suitability Index
IJC	International Joint Commission
LC100	Lethal Concentration-100% (the concentration of a substance that results in 100% mortality of a test species)
LOAEL	Lowest Observed Adverse Effect Level
MCDPH	Monroe County Department of Public Health
NOAA	National Oceanic and Atmospheric Administration
NOAEL	No Observed Adverse Effect Level
NYSDEC	New York State Department of Environmental Conservation
PAH	Polycyclic Aromatic Hydrocarbon
PCB	Polychlorinated Biphenyl
RAC	Remedial Advisory Committee
RAP	Remedial Action Plan
RCRA	Resource Conservation and Recovery Act
SPDES	State Pollutant Discharge Elimination System
SUNY	State University of New York
TEQ	Toxic Equivalency
USACE	United States Army Corps of Engineers
USEPA	United States Environmental Protection Agency
USFWS	United States Fish and Wildlife Service
USPC	United States Policy Committee
VCP	Voluntary Cleanup Program
WMA	Wildlife Management Area

# 1. Introduction and Report Purpose

In the Great Lakes Basin, the International Joint Commission (IJC) has identified 43 Areas of Concern (AOCs) under Annex 1 of the Great Lakes Water Quality Agreement (GLWQA) where pollution from past industrial production and waste disposal practices has caused significant ecological degradation. Up to fourteen beneficial use impairments (BUIs), or indicators of poor water quality, are used to evaluate the condition of an AOC.

The Rochester Embayment AOC encompasses the lower portion of the Genesee River from the outlet at Lake Ontario to the Lower Falls in Rochester, NY, and the portion of Lake Ontario contained within a straight line drawn from Bogus Point to Nine Mile Point (Figure 1). The Rochester Embayment was originally listed as an AOC due to the known or suspected presence of multiple

BUIs, including Bird or Animal Deformities or Reproduction Problems. According to the IJC, this BUI is generally considered impaired “When wildlife survey data confirm the presence of deformities (e.g., cross-bill syndrome) or other reproductive problems (e.g., egg-shell thinning) in sentinel wildlife species” (IJC, 1991).

Following an evaluation of the data and evidence gathered to address this impairment, the New York State Department of Environmental Conservation (NYSDEC) and the Monroe County Department of Public Health (MCDPH) have determined that the Bird or Animal Deformities or Reproduction Problems BUI can be removed in accordance with established AOC program guidance. The local Remedial Advisory Committee (RAC) fully supports the removal of this BUI (Appendix A). Accordingly, the purpose of this BUI removal report is to present the rationale and supporting data to remove the Bird or Animal Deformities or Reproduction Problems BUI from the Rochester Embayment AOC.

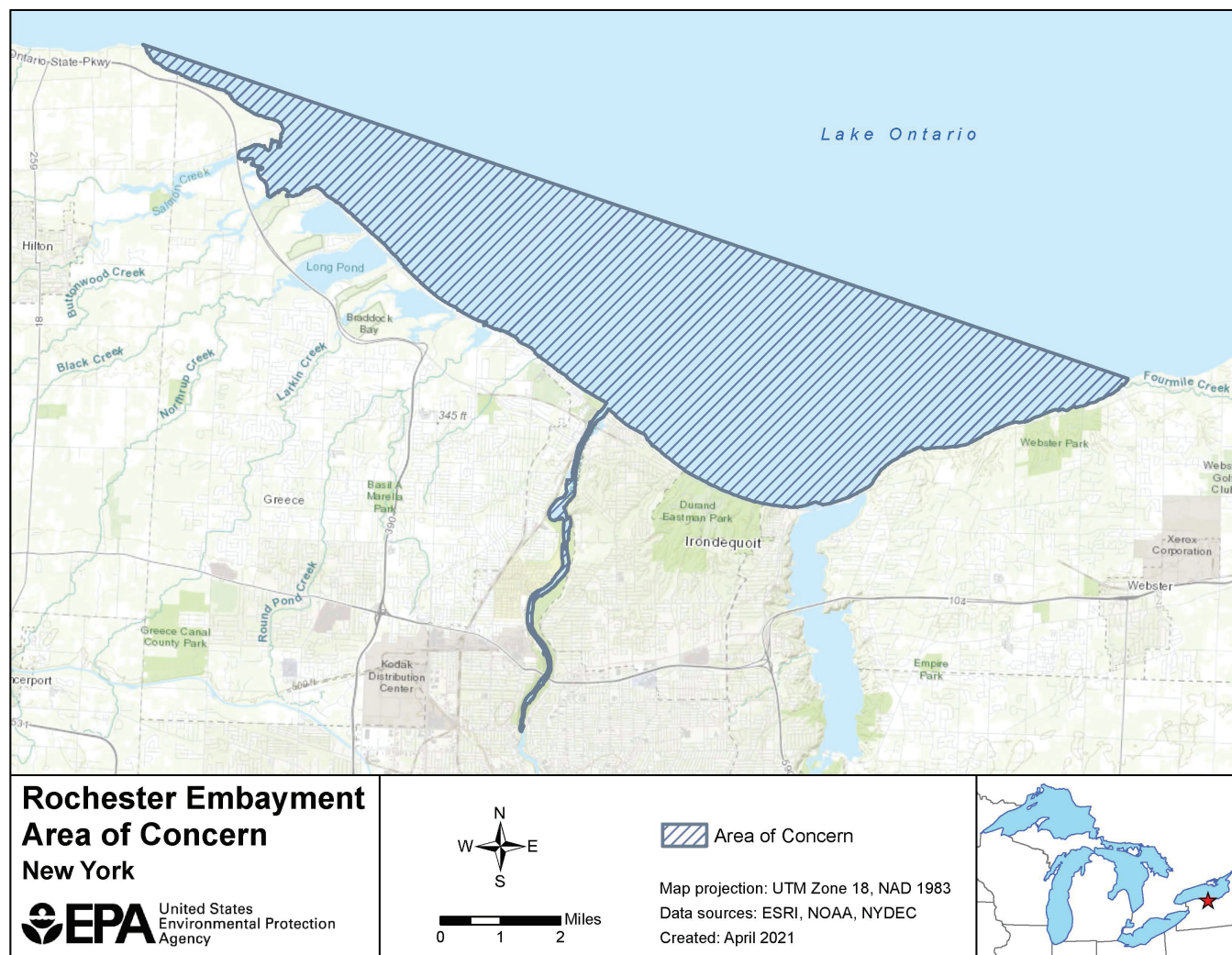


Figure 1. Map of the Rochester Embayment Area of Concern

## 2. Background and Beneficial Use Impairment

Per Annex One of the 1987 amendment to the GLWQA, all AOCs were mandated to develop a Remedial Action Plan, or RAP, in three stages. Under this framework, the Stage I RAP identifies specific BUIs and their causes, the Stage II RAP outlines the restoration work needed, and the Stage III RAP documents completion of these restoration activities and recommends the delisting of the AOC. Currently, the RAP for the *Rochester Embayment AOC consists of the Rochester Embayment Remedial Action Plan Stage I* (NYSDEC/Monroe County Department of Planning and Development, 1993) and the *Rochester Embayment Remedial Action Plan Stage II* (NYSDEC and Monroe County Department of Health, 1997). Subsequent addenda to the State II RAP have also been completed.

The Bird or Animal Deformities or Reproduction Problems BUI was originally listed as impaired in the Stage I and Stage II RAPs for both the Rochester Embayment and the lower Genesee River portions of the AOC due to:

- Polychlorinated biphenyls (PCBs) detected in fish tissue samples at concentrations shown to cause reproductive failure in captive mink; and,
- An observed absence of mink from the Rochester Embayment AOC.

Mink are piscivorous mammals that occupy a relatively high trophic (food web) position within the Rochester Embayment AOC. In the late 1980s, a study (Foley et. al, 1988) found that fish in the lower Genesee River and in the portion of Lake Ontario that comprises the Rochester Embayment AOC had PCB concentrations in their tissue at levels known to cause reproductive failure in mink.

While there was also some discussion in the Stage I RAP of possible bird deformities, reported incidences were associated with migratory birds, and there was no way to define where exposures occur. As a result, the Bird or Animal Deformities or Reproduction Problems BUI was determined to be impaired exclusively due to the conditions noted in the bulleted items above.

### 2.1 BUI Removal Criteria

The ecological indicators selected to assess the Bird or Animal Deformities or Reproduction Problems BUI resulted from the efforts of the RAC Toxics Oversight Committee and Habitat Oversight Committee. The RAC established these two committees to develop removal criteria for all BUIs identified in the RAP, based on the major ecological problems underlying each of the BUIs. The removal criteria for the Bird or Animal Deformities or Reproduction Problems BUI were originally reported in an addendum to the Stage II RAP (MCDPH/NYSDEC, 2002), and were based on the following conditions:

- Contaminants in water samples meeting established NYSDEC ambient water quality standards for the protection of aquatic life and/or for protection of wildlife; and,
- Mink are present and reproducing within the AOC, or tissue contaminant levels are below those known to be associated with mink reproductive failure.

The BUI removal criteria were revisited in 2008 and, in 2009, the criterion referencing NYSDEC ambient water quality standards was eliminated, in part, based on the difficulty detecting contaminant concentrations at the extremely low levels at which relevant water quality standards had been set. Only the second component, pertaining to mink presence/reproduction within the AOC and tissue contaminant levels, was maintained. The revised criteria, which have since been considered final, are as follows:

- Mink are present and are reproducing, or levels of PCBs, dioxins/furans, Mirex, and mercury measured in the tissue of resident prey are below those known to be associated with mink reproductive failure.



## 2.2 BUI Removal Considerations

When evaluating whether to proceed with the removal of the Bird or Animal Deformities or Reproduction Problems BUI, which included the review of technical reports, presentations, and other supporting documents, the following questions were considered:

- Are the methods and results cited in the material technically and scientifically sound?
- Does the information cited regarding restoration of the impaired beneficial use sufficiently address the removal criteria?
- Do the RAC and public concur that the removal criteria have been met?
- In the case where BUI removal criteria have not been explicitly or fully met, are any alternative removal scenarios applicable in accordance with established programs and guidance?

## 2.3 Strategy and Rationale

The USEPA guidance document, Restoring United States Great Lakes Areas of Concern: Delisting Principles and Guidelines, accepted by the United States Policy Committee (USPC, 2001), states that removal of a BUI can occur under any of these scenarios.

- A delisting target has been met through remedial actions, which confirms that the beneficial use has been restored;
- It can be demonstrated that the BUI is due to natural rather than human causes;
- It can be demonstrated that the impairment is not limited to the local geographic extent, but rather is typical of lakewide, regionwide, or area-wide conditions (under this situation, the beneficial use may not have been originally needed to be recognized as impaired); or
- The impairment is caused by sources outside the AOC. The impairment is not restored, but the impairment classification can be removed or changed to “impaired – not due to local sources.” Responsibility for addressing “out of AOC” sources is given to another party.

As described in Section 3, the removal criteria for the Bird or Animal Deformities or Reproduction Problems BUI have been met, consistent with the first bulleted scenario above – the beneficial use has been restored.

## 3. BUI Indicator Status Resolution

The root problem identified for this BUI was the presence of chemical contaminants in the environment that have the potential to bioaccumulate in the food chain and lead to deformities or reproductive problems in wildlife. The Stage II RAP lists numerous general actions that could lead to reduced bioavailability of chemical contaminants, including acceleration of PCB removal and pollution prevention; remediation of landfills and hazardous waste sites; remediation of sources within the Genesee River gorge; management of stormwater quality; impervious surface reduction; and, promotion of agricultural best management practices (BMPs). Some of the federal, state, and local initiatives that have been implemented over the past 30+ years to address chemical contaminants in the environment are described in Section 4.1. Since no specific contaminant source areas or sites were identified in the RAP as contributing directly to the Bird or Animal Deformities or Reproduction Problems BUI, no management actions such as contaminant removal or source control, including those described in Section 4.1, were implemented with the sole or primary intent to address the BUI. However, these efforts have likely resulted in reduced exposure of fish and wildlife to contaminants in the environment, and therefore are important to note within the context of removing this BUI.

Similarly, some of the habitat restoration work within the Rochester Embayment AOC is described in Section 4.2. While this work supports the restoration of fish and wildlife populations within the AOC, including mink, the projects were not specifically intended to address the BUI removal criteria. Rather, the mink studies discussed below provide the necessary supporting data to fully address the BUI removal criteria and serve as the basis for BUI removal.

### 3.1 SUNY Brockport Mink Studies (2003 – 2007)

Researchers at the State University of New York (SUNY) Brockport conducted a series of studies investigating mink within the Rochester Embayment AOC, focusing on the Braddock Bay Wildlife Management Area (WMA) in the western portion of the AOC. Inland locations and areas along the Lake Ontario shoreline outside the AOC boundary were also included, to serve as reference sites. This work built upon ongoing mink studies by SUNY Brockport researchers and was intended to assess the status of both the Degradation of Fish and Wildlife Populations and Bird or Animal Deformities or Reproduction Problems BUIs. The additional studies were made possible through funding support provided in 2004 from the

Great Lakes Protection Fund (GLPF). (Note: while citations for each of the individual studies described below are provided, the final reports for these studies are included in their entirety as appendices to a larger comprehensive final report prepared by SUNY Brockport as part of the GLPF grant, included as Appendix B to this BUI removal report, as referenced later in Section 3.1.)

The first study (Wellman and Haynes, March 2006), conducted in 2003 – 2004, involved the use of a proprietary “MustelaVision” system to attempt to document the actual presence of mink breeding within the AOC. MustelaVision was a remote-controlled video capture system developed for this project that researchers set up in wetland areas and along shorelines at locations where mink were likely to be observed. Researchers selected sites both within the Rochester Embayment AOC and at reference sites outside of the AOC to compare the relative abundance of mink. During the study period, mink families were recorded multiple times at AOC locations by the MustelaVision system, in one instance four young and one adult mink were recorded. The researchers note in their report that mink are normally solitary except for mating pairs and mothers with kits and, since some of the mink captured on video were clearly young, the researchers assumed that these were kits together with their mother. The MustelaVision video provided direct evidence that mink were not only present, but successfully reproducing within the AOC. Additionally, researchers determined that there wasn’t a statistically significant difference between mink populations within the AOC and at non-AOC reference locations along the Lake Ontario shoreline, although it was acknowledged that the statistical power the tests used was low due to relatively small sample sizes, and additional information was needed to fully meet the BUI removal criteria.

The second study (Wellman and Haynes, June 2006) centered on the development of a food web model for mink within the Rochester Embayment AOC to establish levels of mink exposure to bioaccumulative chemical contaminants (BCCs). This study involved the trapping and collection of mink for direct tissue analysis of nitrogen and carbon isotope concentrations. The relative concentrations of these isotopes in mink tissue samples were then used to evaluate the diets of mink both within the AOC and at reference locations, in terms of trophic levels and terrestrial and aquatic food sources. From this information, researchers were able to construct a food web/bioaccumulation model for mink in the AOC that could be used to predict body burdens of BCCs in mink in relation to their diets, based on the concentrations of BCCs in ambient water in Lake Ontario or the AOC. This model was subsequently tested by comparing modeled/predicted BCC concentrations in mink tissue against measured tissue concentrations. The mink tissue analyses, and model testing are further described in subse-

quent third (Pagano and Haynes, March 2007) and fourth (Wellman and Haynes, March 2007) studies, respectively, both of which are summarized below.

The third study (Pagano and Haynes, March 2007) involved the BCC analysis of tissue samples collected from lakeshore and inland populations of mink both within and outside the AOC. The BCCs included (but were not limited to) all contaminants specifically included in the BUI removal criteria - PCBs, dioxins/furans, Mirex, and mercury. From the resulting analytical data, the researchers determined there were no significant differences in BCC concentrations in tissue from mink captured inside and outside the AOC, although mean concentrations were almost always higher in those within the AOC.

While tissue contaminant levels in mink are not a direct consideration when assessing attainment of the BUI removal criteria, the results of this study are noted here because the tissue contaminant data were subsequently used as part of testing the food web model developed in the second study above. This model testing is described further below (fourth study).

The fourth study (Wellman and Haynes, March 2007) included a literature review of reports on BCCs in mink tissue corresponding with adverse effects on populations or reproduction, and the occurrence of deformities. Through a review of existing literature, researchers compiled a list of adverse endpoints (e.g., reproductive failure, kit mortality, litter size reduction, etc.) and linked them to multiple effect levels for various BCCs, including PCBs, dioxins/furans, and mercury. No existing studies were found for Mirex. Some of the effect levels considered were the lowest-observed-adverse-effect-level (LOAEL), the no-observed-adverse-effect-level (NOAEL), and the lethal concentration for 100 percent of the population (LC100). The LOAEL represents the lowest concentration of a chemical for which there are observed adverse effects to an exposed group, whereas the NOAEL represents the highest dose of a chemical for which there are no observed adverse effects. The LC100 represents the concentration for a chemical for which exposure results in mortality for the entirety of an exposed group. This endpoint is often scaled to different mortality rates; comparatively, an LC10 value would represent a concentration that would result in 10 percent mortality of an exposed group. A table of these ecological endpoints is included in the study report (Wellman and Haynes, 2007).

This fourth study also included testing the model developed in the second study discussed above (Wellman and Haynes, June 2006), by comparing the modeled/predicted BCC concentrations in mink tissue based on Lake Ontario ambient water concentrations against the actual tissue concentrations from mink tissue analyses performed in the third study. Comparisons were limited to mink captured along the lake shoreline, since these



would presumably have a diet of organisms exposed to the lake water. It was found that for PCBs and dioxins/furans, the model worked well, but it was less successful in predicting levels of mercury.

A final report was prepared by the SUNY Brockport researchers (Haynes, Wellman, and Pagano, August 2007), tying together all the information from the various studies above and assessing the status of both the Degradation of Fish and Wildlife Populations and Bird or Animal Deformities or Reproduction Problems BUIs at that time. This report is included as Appendix B of this BUI removal report and as previously noted, contains the reports from the individual studies above as appendices. The conclusions from the final August 2007 report were that the series of studies documented the presence of mink populations and mink reproduction in the AOC, and that analytical, modeling, and literature review results all suggest that mink reproduction is unlikely to be impaired in the AOC.

The final study report also included a recommendation that additional monitoring of mink be conducted to confirm the status of the BUI; this additional work is discussed in Section 3.2.

## 3.2 Follow-Up SUNY Brockport Mink Studies (2013 – 2015)

Several years after the conclusion of the studies described above, SUNY Brockport researchers conducted a follow-up project to reassess many of the same ecological indicators that had previously been studied, including the presence of reproducing mink populations within the AOC. This was based on the recommendations made as part of the previous studies, and to confirm the status of multiple BUIs, including Bird or Animal Deformities or Reproduction Problems. This follow-up project, made possible through funding support from the GLRI, was similarly comprehensive in scope. The study results below are discussed in more detail in the final report for the project (Haynes and Wellman, December 2015), included as Appendix C of this BUI removal report.

To reassess the status of mink relative to the removal criteria for the Bird or Animal Deformities or Reproduction Problems BUI, researchers placed non-lethal “black trakka” traps at 20 locations throughout the AOC where mink are likely to be found. These traps were designed to capture mink tracks and document direct evidence of mink presence within the AOC. Additionally, researchers used the U.S. Fish and Wildlife Service’s (USFWS) Habitat Suitability Index (HSI) model for mink (Allen, 1986) to estimate habitat suitability at 41 sites within the AOC. The USFWS HSI model uses three criteria (percent of surface water, percent vegetation cover within 30m of the shoreline, and percent shoreline cover within 1m of surface water) to assign a habitat score to a given site, on a scale of 0-1, with a score of 1 representing optimum habitat.

As a result of the follow-up study, definitive evidence of mink was found at 10 of the 20 “black trakka” trap locations. Additionally, field staff observed one live mink swimming across the Genesee River. The USFWS HSI model calculated an average value of 0.85 out of 1 at the sites within 100m of the shoreline of the Genesee River portion of the AOC, suggesting that habitat appears to be highly suitable for mink in these areas. Comparatively, a professional trapper hired by the researchers rated the average habitat suitability for mink at 0.43 throughout the study area, due primarily to steep, rocky slopes along the lower Genesee River and evidence of human activity along the shoreline.

The SUNY Brockport research team also re-evaluated the risk of BCCs that were noted in RAP documents (as previously described in this report) to be linked to potential reproductive failure in mink within the AOC by collecting samples of common prey organisms from the Genesee River portion of the AOC and analyzing them for chemical contaminants. Exposure of mink to BCCs was estimated through modeling several possible mink diets, which showed that:

- Using the “highest exposure” mink diet found in published literature (92% from aquatic sources) and using mean concentrations of BUI contaminants found in potential mink prey in the Genesee River portion of the AOC, the maximum dietary exposure of mink would be 81% of the LOAEL for total mercury, 23% of the LOAEL for total PCBs, and 69% of the LOAEL for toxic equivalency (TEQ, a measure of dioxin and dioxin-like compounds). These results represent the “worst case” diet scenario. For this study, TEQ included contributions from PCBs, dioxins/furans, and polycyclic aromatic hydrocarbons (PAHs), the latter of which were not identified in the RAP documents as contaminants contributing to this BUI. However, the researchers included the PAHs because of their potential adverse effects. The inclusion of PAHs further contributes to this being a “worst-case” scenario.
- Using the average of six mink diets reported in published literature (65% from aquatic sources), comparable to what mink would eat in the Genesee River portion of the AOC, and using mean concentrations of BUI-related contaminants found in potential mink prey in the study area, the dietary exposure of mink would be 48% of the LOAEL for total mercury, 13% of the LOAEL for total PCBs, and 40% of the LOAEL for total TEQ. This is the “likely” diet scenario.

These findings demonstrate that contaminant levels in mink prey within the Genesee River portion of the AOC are not likely resulting in reproductive problems in mink.

### 3.3 Additional Information on the Mink Studies

---

The studies conducted by SUNY-Brockport researchers were initiated before the final BUI removal criteria were established, and included components that are beyond the scope of, and not directly related to, the removal criteria, but are important to acknowledge. As an example, the researchers found evidence of jaw lesions on some of the captured mink, and these specimens typically had the highest tissue contaminant levels. The presence of the lesions was consistent with what researchers found in the scientific literature regarding adverse impacts of mink exposure to chemical contaminants. The report for this assessment of jaw lesions (Haynes and Wellman, 2015) is provided as Appendix D.

Also, when evaluating the evidence for both the presence/reproduction of mink (video/field observations) and the potential chemical contaminant impacts, the researchers attempted to make comparisons between lake shoreline and inland areas, and between AOC and non-AOC locations. While some differences may have been observed, at least for some components of the studies, overall, they were determined to be inconclusive or not statistically significant differences.

Additional information on these additional study components can be found in the study reports provided as appendices to this BUI report, but as noted, this information is not directly related to the BUI removal criteria and, therefore, is not discussed further in this report.

## 4. Additional Activities Supporting BUI Removal

As mentioned in Section 3, no specific management actions addressing contaminant sources were undertaken for the sole purpose of addressing the Bird or Animal Deformities or Reproduction Problems BUI. However, described below are some (but not nearly all) representative examples of efforts implemented independently of the AOC program to mitigate contaminant sources. Some of the habitat restoration efforts that were implemented to address other BUIs are also briefly described. As with the contaminant source efforts, habitat restoration projects were not a required component of addressing the Bird or Animal Deformities or Reproduction Problems BUI, but these projects will benefit a multitude of species within the AOC, including mink populations.

### 4.1 Contaminant Source Mitigation and Control

---

#### 4.1.1 Remedial Program Cleanups

Contaminated bottom sediments in the lower Genesee River have been a significant driver of ecological degradation throughout the lower Genesee River and Rochester Embayment. For well over a century, the Genesee River served as a hub for manufacturing growth and industrial development. During the 19th century, companies such as Eastman-Kodak and Bausch & Lomb were founded along the banks of the Genesee River in the city of Rochester.

Unfortunately, a consequence of this development was the persistent and pervasive discharge of toxic chemicals into the Genesee River, either directly via waste streams generated from industrial processes, or indirectly through improper waste storage and disposal. These practices resulted in some areas of heavily contaminated sediments along the river bottom and some upland areas along the shorelines, where they present a significant risk for bioaccumulation in native flora and fauna.

To address contamination at both active and inactive industrial and manufacturing facilities, there are numerous remedial programs that are administered, including federal and State Superfund programs, and the Resource Conservation and Recovery Act (RCRA), as well as New York's Brownfields Cleanup Program (BCP) and Voluntary Cleanup Program (VCP). These programs provide a structure through which the nature and extent of site-specific contamination can be investigated and understood, and subsequently, an appropriate remediation strategy can be designed and ultimately executed.

Along the lower Genesee River, there are a multitude of sites that are enrolled in remedial programs at either the state or federal level. NYSDEC keeps records of both active and legacy sites online in the Environmental Site Remediation Database and the DECinfo Locator. One of the largest and most complex remediation sites is the former Eastman-Kodak Business Park. The Business Park is a massive (1,200-acre) industrial and technology development site that was formerly the primary manufacturing center of the Eastman-Kodak photography company. The site featured several support facilities, including a power plant and a wastewater treatment plant. As a result of the significant historic manufacturing and industrial development at the site, a significant volume of hazardous waste was generated and either stored onsite or discharged to the Genesee River.

A RCRA corrective action process was employed by the NYSDEC under the Kodak Environmental Response Trust (part of a federal bankruptcy settlement) to identify a remedy to address impacted sediments in the Genesee River. In 2021, approximately 29,000 cubic yards of contaminated sediment was dredged from two localized areas of the river to support placement of clean fill (sand, stone, and soil) designed for ecological habitat enhancement and erosion protection. The cover system was designed to stabilize riverbed areas prone to scour and erosion, minimizing the potential for sediment transport under high flow events.

## 4.1.2 Wastewater and Stormwater Controls

New York's State Pollutant Discharge Elimination System (SPDES) program is designed to eliminate the pollution of New York waters and to maintain the highest quality of water possible, consistent with public health, public enjoyment of the resource, protection and propagation of fish and wildlife, and industrial development in the state. The program has been approved by the USEPA for the control of surface wastewater and stormwater discharges, in accordance with the federal Clean Water Act. The SPDES permit process has eliminated or placed strict controls on direct industrial wastewater releases, including those entering the Genesee River and Lake Ontario.

## 4.1.3 Federal Regulation

New sources of PCBs and Mirex, two of the BCCs linked to this BUI, have effectively been eliminated through federal regulatory bans on production going into effect in the late 1970s. Historical releases of these chemicals still have the potential to impact fish and wildlife, as their persistence in the environment has allowed residual levels to exist in some river and lake sediments. However, as noted previously, monitoring and modeling has demonstrated that current levels of these contaminants do not appear to be resulting in mink reproductive problems within the AOC (with the caveat that, as previously noted, Mirex was not fully assessed in past research studies relevant to this BUI).

## 4.2 Habitat Restoration Projects

While the lack of suitable habitat was not identified as a contributing cause of this BUI, and no part of the removal criteria pertains to habitat, implementation of habitat restoration projects within the AOC and adjacent areas in recent years are intended to benefit fish and wildlife populations, including mink. Some of the recent habitat restoration efforts are briefly described below.

### 4.2.1 Braddock Bay Ecosystem Restoration Project

Braddock Bay is an embayment along the Lake Ontario shoreline near the western margin of the Rochester Embayment AOC that contains one of the largest extents of coastal wetland habitat throughout the south shore of the lake. Since the late 1800s, progressive erosion of the barrier beach at the mouth of the bay has triggered significant loss of habitat as the bay has been increasingly exposed to wave energy from the lake.

The Braddock Bay Ecosystem Restoration Project was designed to address the continuing loss of coastal wetland habitat throughout the inner bay resulting from gradual erosion of the barrier beach, as well as to restore degraded and lost habitat throughout the bay itself. The project included the restoration of 1,700 feet of the lost barrier beach, providing shelter for 180 acres of emergent marsh and improving water clarity that will benefit 160 acres of submerged aquatic vegetation. This project also included 11,400 feet of channeling, 6.7 acres of potholing, and 9 acres of invasive species treatment in the central Braddock Bay marsh and created 2 acres of additional coastal marsh habitat. These efforts were intended to improve habitat suitability for fish and wildlife species, including northern pike, American mink, and black tern (USACE, 2014). The project was made possible through a partnership between the USACE Buffalo District, USEPA GLNPO, NYSDEC, MCDPH, the town of Greece, and SUNY Brockport. Restoration efforts at Braddock Bay

were initiated during the spring of 2016, and in September 2018, the Braddock Bay Ecosystem Restoration Project was substantially completed. Researchers at SUNY Brockport continue to monitor a suite of ecological indicators to determine the effectiveness of the restoration project in re-establishing native fish and wildlife habitat within Braddock Bay.

## 4.2.2 USFWS Habitat Projects

Following the publication of the 2011 Stage II RAP Addendum for the Rochester Embayment AOC, the New York Field Office of the USFWS collected and analyzed wetland habitat data to assess the condition of habitat within the AOC and to identify a suite of candidate habitat restoration projects that would maximize improvements to wetland habitat within and adjacent to the AOC. From its analysis, USFWS recommended structural habitat enhancements for tributaries to Braddock Bay, Long Pond, Buck Pond, and in the lower Genesee River (USFWS, December 2014). As a result of these recommendations, USFWS implemented the following habitat restoration projects:

- Braddock Bay at Burger Park - approximately 65 acres of wetland habitat was restored and/or enhanced, and approximately 1,800 linear feet of open water channels were restored.
- Long Pond - 5.7 acres of pothole habitat was constructed at Long Pond, and 14,075 bare root and/or live stakes were planted on created habitat mounds totaling 6 acres.
- Buck Pond East – 3.9 acres of pothole habitat was constructed at Buck Pond East, with 7,463 bare root and/or live stakes planted on the 4 acres of created habitat mounds.
- Salmon Creek Preserve – 5.8 acres of pothole habitat were constructed, and 10,068 bare root and/or live stakes were planted on the 6 acres of created habitat mounds.

Restoration at these sites primarily involved varying the vegetation and the elevation of the substrate within nearly monotypic cattail marshes by constructing channels, potholes, and habitat mounds planted with native herbaceous plants and mast-bearing shrubs. These techniques are intended to reestablish topographic and vegetative complexity within habitats, a feature common to relatively unimpacted habitat.

## 4.2.3 Ducks Unlimited Habitat Projects

Ducks Unlimited, in partnership with NYSDEC, the town of Greece, and the National Oceanic and Atmospheric Administration (NOAA), coordinated habitat restoration activities at Buck Pond, Buttonwood Creek, and Salmon Creek, all of which are within the Braddock Bay WMA. These three waterbodies are directly connected to Lake Ontario and consist primarily of coastal marsh and sedge meadow habitat. They provide critical habitat to many species of fish, amphibians, reptiles, mammals, and marsh birds.

Similar to other emergent and coastal marsh habitat regions within the Rochester Embayment AOC, Buck Pond, Buttonwood Creek, and Salmon Creek all had suffered loss of habitat value for native fish and wildlife species through the dominance of monotypic cattail mats. The primary goals of these projects were to restore approximately 175 acres of coastal marsh habitat and approximately 40 acres of sedge meadow, create approximately 7 acres of fish spawning pools, and reestablish hydrologic connectivity between the waterbodies and Lake Ontario. Habitat restoration techniques (channeling and potholing) paralleled those employed at other coastal and emergent marsh habitat restoration sites.

## 4.2.4 Kodak Natural Resource Damage Settlement Projects

Prior to the Kodak sediment remediation described in Section 4.1 above, wetland areas in the remediation footprint consisted of a monoculture of cattails that left little room for vegetation biodiversity. Vegetation biodiversity provides improved habitat for an increased number of animal species and a broader range of ecological niches. The cattail monoculture was removed during dredging and, after placement of clean substrate material, replaced with 38 different native plant species including emergent wetland, floating aquatic and submerged aquatic vegetation. The plantings included 12,000 individual wetland plugs of 20 different native species and a seed mix with an additional 18 native species. In addition, localized areas of adjacent wetlands were lowered to create varying water depths that were planted with a mix of emergent and submergent habitat types to encourage fish and amphibian spawning and reptile breeding. This work occurred in the lower section of the Genesee River, in the vicinity of the turning basin, within and adjacent to Wetland C as depicted on the figure in this fact sheet. Additional information on this remediation can be found here.

## 5. Public Outreach

On July 25, 2022, NYSDEC and MCDPH held a virtual public outreach event to present the rationale for removing the Bird or Animal Deformities or Reproduction Problems BUI. The outreach event consisted of a formal presentation followed by a question-and-answer session where local stakeholders were provided an opportunity to ask questions directly to NYSDEC and MCDPH staff regarding this BUI removal. Approximately 35 people attended the event, including 17 representatives of federal, state, and local government agencies, 15 from the general public (including members of the AOC RAC), and 3 unidentified participants.

Following the public outreach event, the draft BUI removal report was posted on the MCDPH website for a 30-day period during which the public was encouraged to review the report and to provide any comments or questions via email to MCDPH. No comments or questions were formally submitted by the public during this 30-day period.

## 6. Conclusions

### 6.1 Removal Statement

The Bird or Animal Deformities or Reproduction Problems BUI was originally listed as Impaired in the Stage I/Stage II RAPs due to: the presence of contaminants, particularly PCBs, at concentrations shown to cause reproductive failure in captive mink; and, the observed absence of mink in the vicinity of Lake Ontario. The Rochester Embayment RAC established specific removal criteria for this BUI:

- Mink are present and are reproducing, or levels of PCBs, dioxins/furans, Mirex, and mercury measured in the tissue of resident prey are below those known to be associated with mink reproductive failure.

Through a series of studies conducted from 2003 – 2007 and from 2013 – 2015, as described above, researchers from SUNY-Brockport found direct evidence that mink are present and reproducing in the AOC – thus demonstrating attainment of the first component of the removal criteria.

Through analytical testing of contaminant concentrations in mink prey within the Genesee River portion of the AOC, scientific literature searches, and the use of a food web model developed for these studies, the researchers determined that dietary LOAELs in mink, which included endpoints related to populations, reproduction, and deformities, would not be exceeded through either “highest-exposure” or “likely” diet scenarios, and therefore, contaminant levels in mink prey were not likely to result in reproductive failure – meeting the second component of the removal criteria. Collectively, the results from the studies demonstrate that the removal criteria have been met.

Habitat restoration efforts within and adjacent to the AOC, along with contaminated site remediation, have substantially addressed the root problems of the BUI, particularly within the lower Genesee River portion of the AOC. Based on all supporting information presented in this report, NYSDEC has determined that the Bird or Animal Deformities or Reproduction Problems BUI can be removed from the list of designated impairments for the Rochester Embayment AOC, in accordance with established EPA guidance and the GLWQA. The Rochester Embayment RAC fully supports the removal of this BUI (Appendix A).



## 6.2 BUI Removal Steps

	Completed	Date	Step Taken
1.	✓	8/1993	BUI first documented as "Impaired" in the Stage I RAP.
2.	✓	2002	BUI removal criteria developed and included in Stage II RAP Addendum
3.	✓	5/2012	BUI removal criteria revised with RAC consensus.
4.	✓	12/2018	RAP advisory committee agreed to proceed forward with BUI removal.
5.	✓	6/16/2022	Initial draft BUI removal report sent to EPA for review by Technical Review Lead (TRL).
6.	✓	7/25/2022	NYSDEC/MCDPH hold public outreach event and begin a 30-day period for the public to review the draft BUI removal report.
7.	✓	8/24/2022	The 30-day public review period ends. Input from the public is reviewed and incorporated as appropriate into the BUI removal report.
8.	✓	9/2022	NYSDEC submits a final report to EPA, with a request for concurrence that the BUI designation be removed.

## 6.3 Post-Removal Responsibilities

Following removal of the Bird or Animal Deformities or Reproduction Problems BUI, the organizations listed below will continue their respective missions to continue improving water quality and ecological conditions within the Rochester Embayment AOC, as applicable and feasible. The environmental programs relating to this beneficial use include, but are not necessarily limited to, adaptive monitoring and management of habitat restoration sites, continued remediation of contaminated sites, ecological quality monitoring efforts, and continued coordination of the Rochester Embayment AOC RAP.

### i. New York State Department of Environmental Conservation

NYSDEC will continue to implement regulatory programs to remediate contaminant sources and control contaminant releases into the environment. NYSDEC will also coordinate monitoring at habitat restoration sites throughout the Rochester Embayment AOC, as necessary and feasible.

### ii. United States Environmental Protection Agency

The USEPA will continue to provide funding for RAP/RAC Coordination and technical assistance to the extent that resources are available to support the removal of remaining BUIs, and ultimately the delisting of the AOC.

### iii. Monroe County Department of Public Health

With EPA/GLRI funding, MCDPH currently provides a coordinator for the AOC RAP, facilitation with RAC efforts, and technical assistance for AOC documentation and project design. With ongoing funding support, MCDPH will continue in these roles to assist the RAC and USEPA in achieving the long-term goal of delisting the Rochester Embayment AOC.

### iv. Remedial Advisory Committee

The RAC will continue to advance the objectives of the RAP by evaluating, supporting, and documenting the restoration of the Rochester Embayment AOC until all BUIs are restored and the AOC is delisted.

# References

Allen, A.W. 1986. Habitat Suitability Index Models: Mink, revised. U.S. Fish and Wildlife Service, Biological Report 82 (10.127). 23 pp.

Beckett, K.J., and Haynes, J.M. (undated). Histological Assessment of Mink Jaws Collected during GLPF Project C30239: RAP Progress in the Rochester Embayment of Lake Ontario: Population Monitoring, Trophic Relationships, and Levels of Bioaccumulative Chemicals of Concern in Mink, a Sentinel Species (Supplemental Report).

Foley, R. E., Jackling, S. J., Sloan, R. J., and Brown, M. K. 1988. Organochlorine and mercury residues in wild mink and otter: comparison with fish. *Environmental Toxicology and Chemistry* 7: 363-374.

Haynes, J.M., Wellman, S.T. December 2015. Final Report: BUI Delisting Studies in the Rochester Embayment AOC, 2013-2014.

Haynes, J.M., Wellman, S.T., and Pagano, J.J. August 2007. RAP Progress in the Rochester Embayment of Lake Ontario: Population Monitoring, Trophic Relationships, and Levels of Bioaccumulative Chemicals of Concern in Mink, a Sentinel Species. Final Report to the New York State Great Lakes Protection Fund.

International Joint Commission (IJC). 1991. Proposed listing/delisting guidelines for Great Lakes Areas of Concern. Focus on International Joint Commission Activities. Volume 14, Issue 1, Insert.

Monroe County Department of Planning and Development. August 1993. Rochester Embayment Remedial Action Plan Stage I.

Monroe County Department of Health. September 1997. Rochester Embayment Remedial Action Plan Stage II.

Monroe County Department of Public Health (MCDPH). Rochester Embayment Remedial Action Plan 2002 Addendum.

New York State Department of Environmental Conservation. October 2020. Rochester Embayment Area of Concern Restrictions on Fish and Wildlife Consumption Beneficial Use Impairment Removal Report.

Pagano, J.J, Haynes, J.T. March 2007. Levels of Bioaccumulative Chemicals of Concern in Mink In and Out of the Rochester Embayment Area of Concern and Along and Inland from the Shore of Lake Ontario.

United States Army Corps of Engineers Buffalo District. Feasibility Study: Braddock Bay Restoration, USEPA Economy Act P2#395893. September 2014.

United States Fish and Wildlife Service. Wetland Restoration Recommendations at the Rochester Embayment Area of Concern in Support of the Loss of Fish and Wildlife Habitat BUI Removal: Final Status Report. Prepared for the U.S. Environmental Protection Agency, Great Lakes National Program Office. December 2014.

United States Policy Committee (USPC). 2001. Restoring United States Areas of Concern: Delisting Principles and Guidelines. Adopted by the United States Policy Committee on December 6, 2001.

Wellman, S.T., Haynes, J.T. March 2006. Are there Differences in the Relative Abundance of Lakeshore and Inland Mink Populations In and Out of the Rochester Embayment of Lake Ontario Area of Concern? Monitoring Mink Populations Using Video Traps.

Wellman, S.T., Haynes, J.T. June 2006. Age, Size, and Stable Isotope Data of Mink Populations, and a Predictive Model of Bioaccumulation of Chemicals of Concern in the Rochester Embayment of Lake Ontario.

Wellman, S.T., Haynes, J.T. March 2007. Bioaccumulative Chemicals of Concern in Mink: Adverse Effects Levels and Results of a Predictive Model for the Rochester Embayment of Lake Ontario.

# **Appendix A**

**List of Remedial Advisory Committee Members  
& Letter of Support for BUI Removal**

---



**Appendix A - List of Remedial Advisory Committee Members and Letter of Support for BUI Removal**

Starr O'Neil  
 Rochester Embayment Area of Concern - Remedial Action Plan Coordinator  
 Monroe County Dept. of Public Health  
 111 Westfall Road – Room 828  
 Rochester, NY 14620  
 585-753-5209  
[soneil@monroecounty.gov](mailto:soneil@monroecounty.gov)

<b>Name</b>	<b>Organization</b>	<b>E-mail</b>
Anne Spaulding	City of Rochester	<a href="mailto:Anne.Spaulding@CityofRochester.Gov">Anne.Spaulding@CityofRochester.Gov</a>
Charles Valeska	General Public	<a href="mailto:CHAZVAL46@YAHOO.COM">CHAZVAL46@YAHOO.COM</a>
Charlie Knauf	General Public (MCDPH retiree)	<a href="mailto:anniebl@frontiernet.net">anniebl@frontiernet.net</a>
David Klein	The Nature Conservancy	<a href="mailto:dklein@tnc.org">dklein@tnc.org</a>
George Thomas	Genesee RiverWatch	<a href="mailto:gthomas@geneseeriverwatch.org">gthomas@geneseeriverwatch.org</a>
Jane Forbes	City of Rochester	<a href="mailto:forbesj@cityofrochester.gov">forbesj@cityofrochester.gov</a>
Jeff Wyatt	URMC	<a href="mailto:Jeff_Wyatt@URMC.Rochester.edu">Jeff_Wyatt@URMC.Rochester.edu</a>
June Summers	Genesee Valley Audubon Society	<a href="mailto:summers@frontiernet.net">summers@frontiernet.net</a>
Paul Flansburg	Great Lakes Comm., Sierra Club	<a href="mailto:pflansburg@hotmail.com">pflansburg@hotmail.com</a>
Paul Sawyko	Water Education Collaborative	<a href="mailto:psawyko@rmsc.org">psawyko@rmsc.org</a>
Stevie Adams	The Nature Conservancy	<a href="mailto:sadams@tnc.org">sadams@tnc.org</a>
Wayne D. Howard	Solara Concepts	<a href="mailto:whoward@solaraconcepts.com">whoward@solaraconcepts.com</a>
<b>Agency Staff</b>		
Peter Rightmyer	MCDPH	<a href="mailto:prightmyer@monroecounty.gov">prightmyer@monroecounty.gov</a>
Sara Madison	MCDPH	<a href="mailto:saramadison@monroecounty.gov">saramadison@monroecounty.gov</a>
Emma Antolos	NYSDEC	<a href="mailto:Emma.antolos@dec.ny.gov">Emma.antolos@dec.ny.gov</a>
James Lehnen	NYSDEC	<a href="mailto:James.lehnen@dec.ny.gov">James.lehnen@dec.ny.gov</a>
Jennifer Dunn	NYSDEC	<a href="mailto:jennifer.dunn@dec.ny.gov">jennifer.dunn@dec.ny.gov</a>
Joan Kennedy	NYSDEC	<a href="mailto:joan.kennedy@dec.ny.gov">joan.kennedy@dec.ny.gov</a>

July 10, 2022

James Lehn  
NYS Great Lakes Areas of Concern Coordinator  
New York State Department of Environmental Conservation  
700 Delaware Avenue  
Buffalo, NY 14209

Dear Jim:

This letter is to indicate the continued support of the Public Advisory Committee (PAC) for the removal of the *Bird or Animal Deformities or Reproductive Problems* beneficial use impairment (BUI) for the Rochester Embayment Area of Concern (AOC).

During a meeting of the PAC on December 10, 2018, it was documented that the removal criteria for this BUI had been met and that we were ready to move forward with preparing the removal report, with NYSDEC completing the draft.

Recently, the members of the PAC were provided a draft version of the report for review. No subsequent concerns about the report or proceeding with the BUI removal process have been raised by the PAC members. While not part of the original discussion or criteria, June Summers, PAC member and President of the Genesee Audubon Society, has also noted that both Bald Eagle and Osprey have returned to the AOC, with nesting pairs of each species documented in the Braddock Bay area.

Thank you and the rest of the NYSDEC and MCDPH staff for your continued efforts in pursuing this action.

Sincerely,



Charles Knauf, Public Advisory Committee Chair

Cc: Starr O'Neil, MCDPH

## **Appendix B**

**RAP Progress in the Rochester Embayment of Lake Ontario: Population Monitoring, Trophic Relationships, and Levels of Bioaccumulative Chemicals of Concern in Mink, a Sentinel Species. SUNY Brockport, August 2007**

---

**RAP Progress in the Rochester Embayment of Lake Ontario:  
Population Monitoring, Trophic Relationships,  
and Levels of Bioaccumulative Chemicals of Concern  
in Mink, a Sentinel Species**

Final Report

to

The New York Great Lakes Protection Fund  
NYS Dept. of Environmental Conservation  
270 Michigan Avenue  
Buffalo, NY 14203-2999

from

James M. Haynes and Sara T. Wellman  
Department of Environmental Science and Biology  
State University of New York at Brockport  
Brockport, NY 14420-2973

and

James J. Pagano  
Environmental Research Center  
State University of New York at Oswego  
Oswego, NY 13126

August 2007

## EXECUTIVE SUMMARY

This project was designed to determine if two use impairments identified in the Remedial Action Plan (RAP) for the Rochester Embayment of Lake Ontario (RELO) can be delisted: 1) bird or animal deformities or reproductive problems, and 2) degradation of fish or wildlife populations. The eight research and one management questions addressed by this study, and the answers to those questions, follow.

1. *Are there differences in the relative abundance of lakeshore and inland mink populations in and out of the RELO AOC (Area of Concern)?* Video-trapping data tentatively suggested that there are no differences in the relative abundance of mink populations in and out of the AOC or between lakeshore and inland areas.
2. *Are mink reproducing in and out of the RELO AOC?* Video observations confirmed that mink are reproducing along the lakeshore in the AOC and at other locations studied. Mink less than one year old were physically trapped in all areas, implying reproduction in all areas.
3. *Can stable isotope analysis be used to evaluate mink diets, at lakeshore and inland areas in and out of the AOC, in terms of trophic levels and terrestrial and aquatic food sources?* Mink in the study areas fed on prey at an average trophic level of 2.5 (half way between first- and second-level predators). The percent aquatic diet could not be determined.
4. *Can stable isotopes be used to construct a food web/bioaccumulation model for mink in the RELO AOC to predict body burdens of BCCs (bioaccumulative chemicals of concern) in mink in relation to their diets?* Using trophic level determinations and estimated values from literature ranging from 50% to 90% aquatic diet, a food web bioaccumulation model, modified from Sample *et al.* (1996), was used to predict the exposure of mink in the AOC to BCCs based on a BCC's concentration in the water body supporting a mink's food web.
5. *What are the current levels of BCCs in lakeshore and inland populations of mink in and out of the RELO AOC?* Highly consistent patterns of BCC concentrations were observed across tissues and chemicals. The clear signal in the chemical data are that mink captured near Lake Ontario, and presumably eating organisms exposed to Lake Ontario water and its food web, have significantly higher BCC concentrations in their tissues than mink captured inland.
6. *Which BCCs, and at what levels, are known to cause adverse effects on populations or reproduction, or to cause deformities, in mink?* The answer to this question is chemical and

tissue specific. Jaw lesions associated with 40.2 ppb TEQ (toxic equivalents of 2,3,7,8-tetrachlorodibenzo-p-dioxin)/g liver appear to be the most sensitive bioindicator of the toxic effects of BCCs on mink.

7. *Are concentrations of BCCs in RELO AOC mink high enough to cause adverse effects?* The highest measured TEQ value for AOC lakeshore mink (and in the entire study) was 47.62 pg TEQ/g liver wet weight, which is slightly higher than the lowest LOAEL (40.2 pg TEQ/g liver) at which jaw lesions have been observed in 31-week mink kits.
8. *How do predicted levels of BCCs in mink tissues (based on concentrations in Lake Ontario water) compare with measured tissue residues in lakeshore mink specimens?* The bioaccumulation model (Sample *et al.* 1996) worked well for dioxin/furan TEQs and for total PCBs. In both cases, the predicted low and high values bounded measured values, except for the low estimate for PCBs which was very close to the lowest measured value in a lakeshore mink. The model did not predict tissue levels of mercury well.
9. *What is the most reliable and efficient way to monitor the health of RELO AOC mink populations in the future?* Mink jaw lesions have the lowest reported LOAEL in relation to mink reproduction and deformities, and these lesions are a simple, inexpensive bioindicator. Only the mink with the highest total PCB concentration and adipose TEQ and the third highest liver TEQ, vs. the mink with the next highest body burden of BCCs, had jaw lesions and it came from the lakeshore-AOC area.

Conclusion— Mink are reasonably abundant in the RELO AOC, and they are reproducing. It is unlikely that BCC sources in the AOC are now contributing to “degradation of fish and wildlife populations” and “bird or animal deformities or reproductive problems.” Exposure to the Lake Ontario food web is associated with the highest levels of BCCs in mink. The bioaccumulation model used in this study should be used to predict concentrations of dioxins/furans and PCBs in mink as new data on the concentrations of these chemicals in Lake Ontario or Braddock Bay water become available. Once the model predicts concentrations below the LOAEL for jaw lesions, further mink monitoring should be done by sending teeth for aging and jaws for analysis of lesions. If age 1 mink, and older mink with no lesions, are found, confidence that mink exposed to the Lake Ontario food web are no longer at risk for population, reproductive or deformity problems will be high and delisting should proceed.

## TABLE OF CONTENTS

EXECUTIVE SUMMARY .....	i
INTRODUCTION .....	1
The mink as a sentinel species .....	2
METHODS .....	3
RESULTS AND DISCUSSION .....	4
Are there differences in the relative abundance of lakeshore and inland mink populations in and out of the RELO AOC? (Appendix 1) .....	4
Are mink reproducing in and out of the RELO AOC? (Appendix 1).....	4
Can stable isotope analysis be used to evaluate mink diets, at lakeshore and inland areas in and out of the AOC, in terms of trophic levels ( $\delta^{15}\text{N}$ ratio) and terrestrial and aquatic food sources ( $\delta^{13}\text{C}$ ratio)? (Appendix 2) .....	5
Can stable isotopes be used to construct a food web/bioaccumulation model for mink in the RELO AOC to predict body burdens of BCCs in mink in relation to their diets? (Appendix 2).....	5
What are the current levels of BCCs in lakeshore and inland populations of mink in and out of the RELO AOC? (Appendix 3) .....	5
Which BCCs, and at what levels, are known to cause adverse effects on populations or reproduction, or to cause deformities, in mink? (Appendix 4).....	6
Are concentrations of BCCs in RELO AOC mink high enough to cause adverse effects? (Appendix 4) .....	7
How do predicted levels of BCCs in mink tissues (based on concentrations in Lake Ontario water) compare with measured tissue residues in lakeshore mink specimens? (Appendix 4).....	8
What is the most reliable and efficient way to monitor the health of RELO AOC mink populations in the future? .....	9
CONCLUSION .....	10
ACKNOWLEDGMENTS .....	11
LITERATURE CITED .....	11
FIGURES .....	14
Map 1. Rochester Embayment Area of Concern .....	14
Map 2. Sub-basins considered in the RELO RAP .....	15
APPENDICES .....	16
1. Video-trapping report .....	16
2. Stable isotopes and bioaccumulation model report .....	54
3. Bioaccumulative chemicals of concern in mink tissue report .....	87
4. Literature review and bioaccumulation modeling report.....	113
5. Mink jaw deformities in relation to total PCBs and TEQs in their tissues.....	140

# RAP Progress in the Rochester Embayment of Lake Ontario: Population Monitoring, Trophic Relationships, and Levels of Bioaccumulative Chemicals of Concern in Mink, a Sentinel Species

## INTRODUCTION

In the 1980s the binational (Canada, U.S.) International Joint Commission (IJC) began the process of creating and implementing remedial action plans (RAPs) in 43 contaminated areas of concern (AOCs) throughout the Great Lakes Basin. The IJC established 14 “use impairments” that could cause a local area to be “listed” as an AOC, including “degradation of fish and wildlife populations” and “bird or animal deformities or reproductive problems.” In 1988, Foley *et al.* reported that fish in Lake Ontario and the Genesee River had PCB concentrations within the range shown to cause reproductive failure in captive mink. This evidence, coupled with the perceived absence of mink within 2 miles of the lake, led to the inclusion of these two use impairments in the RAP (1993, 1997). This study (Haynes *et al.* 2002) was designed to determine if populations of mink on the shore of the Rochester Embayment of Lake Ontario (RELO) are negatively impacted by bioaccumulative chemicals of concern (BCCs) and, if so, whether the BCCs are originating in the Embayment watershed or elsewhere. The AOC includes the Embayment, a 35 square mile portion of Lake Ontario south of a line between Bogus Point in the town of Parma and Nine Mile Point in the town of Webster (both in Monroe County, New York); adjacent wetlands and bays; and the six mile reach of the Genesee River, from the Lower Falls to the mouth at Lake Ontario (Figure 1). The RAP also includes the sub-watersheds of Salmon Creek (western sub-basin), the Genesee River, and Irondequoit Creek (central sub-basin) (Figure 2).

The questions addressed by this study were:

1. Are there differences in the relative abundance of lakeshore and inland mink populations in and out of the RELO AOC?
2. Are mink reproducing in and out of the RELO AOC?
3. Can stable isotope analysis be used to evaluate mink diets, at lakeshore and inland areas in and out of the AOC, in terms of trophic levels and terrestrial and aquatic food sources?



4. Can stable isotopes be used to construct a food web/bioaccumulation model for mink in the RELO AOC to predict body burdens of BCCs in mink in relation to their diets?
5. What are the current levels of BCCs in lakeshore and inland populations of mink in and out of the RELO AOC?
6. Which BCCs, and at what levels, are known to cause adverse effects on populations or reproduction, or to cause deformities, in mink?
7. Are concentrations of BCCs in RELO AOC mink high enough to cause adverse effects?
8. How do predicted levels of BCCs in mink tissues (based on concentrations in Lake Ontario water) compare with measured tissue residues in lakeshore mink specimens?
9. What is the most reliable and efficient way to monitor the health of RELO AOC mink populations in the future?

The purpose of this final report is to summarize the key findings related to questions 1-8 above (Appendices 1-4), and to propose a plan for monitoring RAP progress by monitoring the health of RELO AOC mink populations in the future.

### **The mink as a sentinel species**

The mink is commonly found along water edges and in wetlands wherever there is cover such as emergent vegetation, brush or forest. It is a predator and eats anything it can catch, including aquatic invertebrates, fish, frogs, birds, and small mammals (Illinois Natural History Survey 2001). Its position atop the aquatic food chain makes it highly susceptible to toxic pollutants in its environment due to the processes of bioaccumulation and biomagnification.

The sensitivity of mink to BCCs became evident in the 1960s when farmed mink exhibited reproductive problems and mortality after feeding on fish taken from the Great Lakes. In 1968, mink fed Lake Michigan coho salmon as 15% of their diet suffered 80% kit mortality (Aulerich and Ringer 1977). Feeding mink coho salmon from Lake Michigan had adverse effects almost identical to those of giving the mink 30 ppm PCBs (Aroclor mixture) in their feed (Aulerich et al. 1971). Both the PCBs and the Lake Michigan salmon caused reproductive problems such as reduced whelping and kit

survival and decreased kit weight. Other adverse effects were increased adult mortality and digestive and excretory system problems such as anorexia, bloody stools, gastric ulcers, and degeneration of liver and kidney.

Since mink are an economic resource, there was great interest in research into pollutants' effects on them, and by 1991 many lab studies had shown mink "particularly sensitive to toxic chemicals" (Wren 1991). These studies were done on laboratory animals that were otherwise healthy, well nourished, and living in a climate-controlled environment; wild populations likely are more sensitive due to stresses of hunger, weather, disease, or injury. By 1991 the accumulated evidence prompted this pronouncement from the editors of the Proceedings of the Expert Consultation Meeting on Mink and Otter: "The mink is the free-living mammal most sensitive to toxic substances such as PCBs and TCDD, and its diet provides an integrated exposure to contaminants in shoreline wetlands" (Addison *et al.* 1991). BCCs of concern in Rochester AOC (defined by G. N. Neuderfer, aquatic toxicologist, NYSDEC, Avon, NY) are PCBs, dioxins/furans, aldrin/dieldrin, chlordane, mirex/photomirex, DDT/metabolites, and methyl-mercury. Thus, the mink is an appropriate sentinel species for the RELO RAP.

## METHODS

The methods for each phase of this study are described in Appendices 1 (*Are There Differences in the Relative Abundance of Lakeshore and Inland Mink In and Out of the Rochester Embayment of Lake Ontario Area of Concern*; Wellman and Haynes 2006a), 2 (*Age, Size, and Stable Isotope Data of Mink Populations, and a Predictive Model of Biaccumulation of Chemicals of Concern in the Rochester Embayment of Lake Ontario*; Wellman and Haynes 2006b), 3 (*Levels of Bioaccumulative Chemicals of Concern in Mink In and Out of the Rochester Embayment Area of Concern and On and Off the Shoreline of Lake Ontario*; Pagano and Haynes 2007), and 4 (*Bioaccumulative Chemicals of Concern in Mink: Adverse Effects Levels and Results of a Predictive Model for the Rochester Embayment of Lake Ontario*; Wellman and Haynes 2007).

It is important to clear up one matter arising from PI Haynes' confusion and subsequent miscommunication with NYS GLPF Administrator. The original proposal

(Haynes et al. 2002) stated that “Polychlorinated Biphenyls (99 zones, 132 congeners), Mirex/Photomirex, HCB, and DDE” would be analyzed by PI Pagano and that “Columbia Analytical Services, Inc. will conduct dioxin/furan (Houston, TX) and Methyl-mercury (Kelso, WA) analyses for this project.” Because there are 209 PCB congeners, many of which do not elute in the standard total PCB analysis (including the dioxin-like, co-planar PCB congeners), and because co-planar PCB analysis is also a separate, expensive activity from dioxin-furan analysis, it was never proposed to do analyses for co-planar PCBs for this project. Using well-established values from the literature (Appendix 4), TEQs from the dioxin-furan analyses were recalculated to include estimated contributions from co-planar PCBs. Thus, the predicted toxicity of BCCs in mink was fully accounted for in the study. Finally, polybrominated diethyl ethers (PDBEs) not proposed for analysis in the original proposal also were quantified in mink tissues.

## **RESULTS AND DISCUSSION**

### **Are there differences in the relative abundance of lakeshore and inland mink populations in and out of the RELO AOC? (Appendix 1)**

Video-trapping data tentatively suggest that there are no differences in the relative abundance of mink populations in and out of the AOC or between lakeshore and inland areas. However, the statistical power (probability of avoiding a Type II error) of the analyses was low due to high variability within and between sampling sites and small sample sizes. A Type II error is the conclusion that there is no significant difference between treatments (e.g., lakeshore vs. inland relative population size) when, in fact, a difference exists. To be confident about delisting a use impairment requires high confidence that the probability of a Type II error is low (e.g., lakeshore vs. inland and AOC: in vs. out comparisons). Video-trapping data alone do not provide a high level of confidence for delisting the “degradation of fish and wildlife populations” use impairment for mink.

### **Are mink reproducing in and out of the RELO AOC? (Appendix 1)**

Video observations confirmed that mink are reproducing along the lakeshore in the AOC and at other locations studied. Mink less than one year old (based on counting annual age

rings in teeth) were physically trapped in all areas, implying reproduction in all areas. Although our observations cannot indicate whether reproduction is taking place at levels that would be considered “normal,” these data suggest that the “reproductive problems” part of the “bird or animal deformities or reproductive problems” use impairment can be delisted in the AOC.

**Can stable isotope analysis be used to evaluate mink diets, at lakeshore and inland areas in and out of the AOC, in terms of trophic levels ( $\delta^{15}\text{N}$  ratio) and terrestrial and aquatic food sources ( $\delta^{13}\text{C}$  ratio)? (Appendix 2)**

Analysis of  $\delta^{15}\text{N}$  showed that mink in the study area feed on prey at an average trophic level of 2.5 (slightly higher along the lakeshore and in the AOC than elsewhere, with the highest level (2.8) along the lakeshore in the AOC), where trophic level 1 is plants, trophic level 2 is herbivores, and trophic level 3 is primary carnivores. The percent aquatic diet could not be determined for lack of  $\delta^{13}\text{C}$  values for carbon sources (i.e., phytoplankton, submergent and emergent macrophytes) in the AOC wetlands.

**Can stable isotopes be used to construct a food web/bioaccumulation model for mink in the RELO AOC to predict body burdens of BCCs in mink in relation to their diets? (Appendix 2)**

Using trophic level determinations ( $\delta^{15}\text{N}$ ) and estimated values from literature ranging from 50% to 90% aquatic diet, a food web bioaccumulation model, modified from Sample et al. (1996), was used to predict the exposure of mink in the AOC to BCCs based on a BCC's concentration in the water body (e.g., Lake Ontario) supporting the minks' food web.

**What are the current levels of BCCs in lakeshore and inland populations of mink in and out of the RELO AOC? (Appendix 3)**

Highly consistent patterns of BCC concentrations were observed across tissues and chemicals. Correlations among concentrations of the seven most notable chemicals analyzed were mostly high and significant in adipose and liver tissue. There were no significant differences in BCC concentrations in and out of the RELO AOC but BCC concentrations in mink captured near the Lake Ontario shore were significantly ( $P < 0.05$ ) or suggestively ( $0.05 < P < 0.1$ ) greater than concentrations in mink captured inland. The clear signal in the chemical data are that mink captured near Lake Ontario,

and presumably eating organisms exposed to Lake Ontario water and its food web, have significantly higher BCC concentrations in their tissues than mink captured inland.

**Which BCCs, and at what levels, are known to cause adverse effects on populations or reproduction, or to cause deformities, in mink? (Appendix 4)**

During the literature search for this project, the lowest observed adverse effect level (LOAEL) was for dioxin (CDD); 0.053 ppb in the diet of mink was associated with reduced kit survival at three weeks (Appendix 4—Appendix A-1). For PCB TEQ (toxic equivalents in relation to TCDD), the lowest LOAEL found was 26.9 ppb in liver associated with changes in retinol and retinyl ester concentrations in 27-week juvenile mink (Appendix 4—Appendix A-2). For mercury, the lowest LOAEL found was 1.06 ppm in liver associated with smaller litter sizes (Table 1). Because the relationship between retinol and retinyl esters and problems with mink populations in terms of reproduction and deformities is unknown, more-easily-detected jaw lesions associated with 40.2 ppb TEQ/g liver appear to be the most sensitive bioindicator of the toxic effects of BCCs on mink (Table 1).

**Table 1.** Selected endpoints and effects levels reported for mercury, PCBs, and TEQs in mink diets and tissues. (Values in italics were estimated using the average brain:liver ratios from Evans *et al.* 2000, Wobeser *et al.* 1976, and Wren *et al.* 1987a, b.) CDD = chlorinated dibenzo dioxins, CDF = chlorinated dibenzo furans, HCB = hexachlorobenzene.

Impairment	Endpoint	Toxin	Effect Level	Conc. (ppm or ug/g)		Reference
				Diet	Tissue	
<b>Brain</b>						
Population	Adult mortality	Hg	LC100	5 ppm	19.9 ppm	Aulerich et al. 1974
Reproduction	Whelping reduced	Hg in fish	LOAEL	0.5 ppm	<i>23.2 ug/g</i>	Dansereau et al. 1999
Reproduction	Litter size reduced	Hg in fish	LOAEL	0.22 ppm	<i>1.06 ppm</i>	Halbrook et al. 1997
Population	Hg intoxication	MeHg	LOAEL	1.1 ppm	8.2 ppm	Wobeser et al. 1976
Reproduction	Litter size reduced	MeHg	LOAEL	1.0 ug/g	2.0 ug/g	Wren et al. 1987a,b
<b>Liver</b>						
Reproduction	Kit survival 3 & 6 wks	PCBs	LOAEL	720 pg/g	2190 pg/g	Heaton et al. 1995, Tillit et al. 1996
		CDDs	LOAEL	60 pg/g	2626 pg/g	
		CDFs	LOAEL	13 pg/g	335 pg/g	
		TEQs	LOAEL	22.4 pg/g	208.3 pg/g	
Deformities	Jaw lesion in 31-wk kits	PCBs	LOAEL	0.96 ug/g	1.698 ug/g	Bursian et al. 2006a, b
Deformities	Jaw lesion in 27-wk kits	TEQs	LOAEL	9.2 pg/g	40.2 pg/g	Bursian et al. 2006c
		PCBs	LOAEL	1.1 ug/g	16 ug/g	
		TEQs	LOAEL	47 pg/g	75 pg/g	

Reproduction	Litter size	PCBs	LOAEL	1360 ppb	7250 ppb	Halbrook et al. 1999
Reproduction	P-1 Whelping reduced	PCBs	LOAEL	0.25 ppm	860 ng/g	Restum et al. 1998
	F-2 Kit mortality	PCBs	LOAEL	0.5 ppm	464 ng/g	
					<b>Adipose</b>	
Reproduction	Kit mortality	HCB	LOAEL	1 ppm	95 ppb	Rush et al. 1983

LOAELs have been determined for many organochlorine (OC) pesticides (Appendix 4—Appendix A-4) but according to Giesy *et al.* (1994) studies in the 1970s and 1980s determined that OC pesticides did not cause the effects seen in mink that ate Great Lakes fish. Because OC pesticide levels have decreased in the environment since then, they would be even less significant today, which probably accounts for the lack of recent studies regarding them.

**Are concentrations of BCCs in RELO AOC mink high enough to cause adverse effects? (Appendix 4)**

An estimate of the total environmental TEQ exposure, based on analysis of only dioxins and furans, would range from two to ten times the dioxin/furan TEQ measured in mink tissues (Appendix 4). The highest measured TEQ value for AOC lakeshore mink in our study was 47.62 pg TEQ/g liver wet weight (Appendix 3), which is slightly higher than the lowest LOAEL (40.2 pg TEQ/g liver) at which jaw lesions were seen in 31-week kits (Table 1). The lowest measured TEQ value in lakeshore mink (0.22 pg TEQ/g), even when multiplied by ten, is still an order of magnitude smaller than the LOAEL, indicating no risk (Table 2). However, the average (excluding high and low TEQ values for the analyzed mink) of 7.8 pg TEQ/g for lakeshore mink (Table 2), if multiplied by five, approaches the LOAEL for jaw lesions. This indicates that some lakeshore mink are at risk of developing jaw lesions known to lead to jaw deformities, osteolysis, and tooth loss (Render *et al.* 2001).

The highest measured TEQ for inland mink was 4.16 pg TEQ/g (Appendix 3). When multiplied by ten, the result is approximately equal to the 40.2 pg TEQ/g LOAEL for jaw lesions, indicating that the most exposed of the inland mink may be at low risk for developing jaw lesions. However, the lowest (0.00 pg TEQ/g) and average (0.25 pg TEQ/g) TEQ values for inland mink (excluding high and low TEQ values for the analyzed mink), even when multiplied by ten, indicate that the majority of inland mink are not at risk (Table 2).

**Table 2.** TEQ values (pg/g) for dioxins and furans from Lakeshore and Inland mink livers, showing high, low and average (excluding high and low) values for each category.

<b>Location</b>	<b>Value</b>	<b>TEQ</b>	<b>TEQ*2</b>	<b>TEQ*10</b>
Lakeshore	Low	0.22	0.44	2.2
	Average (8)	7.75	15.50	77.5
	High	47.62	95.24	476.2
Inland	Low	0.00	0.00	0.00
	Average (8)	0.25	0.50	2.50
	High	4.16	8.32	41.6

Total mercury concentrations in the brains of AOC mink averaged 0.281 ppm along the lakeshore and 0.158 ppm inland (Appendix 3—Table 7), levels 3-6 times lower than lowest LOAEL of 1.06 ppm reported to cause a reduction in litter size of mink. Therefore, it is unlikely that mercury is having an adverse effect on mink in the AOC.

**How do predicted levels of BCCs in mink tissues (based on concentrations in Lake Ontario water) compare with measured tissue residues in lakeshore mink specimens? (Appendix 4)**

The bioaccumulation model (Sample *et al.* 1996) worked well for dioxin/furan TEQs and for PCBs. In both cases, the predicted low and high values bounded measured values, except for the low estimate for PCBs which was very close to the lowest measured value in a lakeshore mink (Table 3). This was expected, as the AOC is neither the most polluted nor the cleanest portion of Lake Ontario (Luckey and Litton 2005; J. Vincent, pers. comm.).

The model did not predict tissue levels of mercury well; the measured values were up to three orders of magnitude higher than predicted values. The reason for this discrepancy is not known. One possibility is the fact that the model is based on the octanol-water partition coefficient, a concept which applies only to lipophilic compounds, which mercury is not. However, Sample *et al.* (1996) apparently intended the model to be used with mercury, as they provided BAF factors for it (as well as several other heavy metals). Another possibility is that the model predicts mercury concentrations in tissue based only on aquatic exposures; mink in our study might have had exposure to mercury through terrestrial sources unaccounted for by the model.

Further investigation and development of the model will be required if it is deemed necessary to predict mercury levels in mink of the Rochester Embayment.

**Table 3.** Predicted versus measured values for tissue residues of dioxin/furans (TEQs), methylmercury, and PCBs, based on water concentrations in Lake Ontario as reported by J. Vincent (2006, Environment Canada, pers. comm..) and Luckey and Litton (2005).

Value	Water Conc.		Tissue Level	
	pg/kg	BCC	Predicted ng/g	Measured ng/g
Low	0.00006	TEQs (liver)	0.0000552	0.00022
High	0.0024		0.0621	0.0213
Low	0.0	MeHg (brain)	0.0	90
High	18.0		4.70	1,550
Low	26.0	PCBs (liver)	19.2	13.6
High	915.0		160,000	5,870

**What is the most reliable and efficient way to monitor the health of RELO AOC mink populations in the future?**

Mink jaw lesions have the lowest reported LOAEL in relation to mink reproduction and deformities (Appendix 4), and these lesions are a simple, inexpensive (~\$40/sample) bioindicator of exposure to BCCs, particularly dioxins and furans. Jaws from 12 specimens collected in this study were sent for histological preparation (Kerrie Beckett, Woodlot Alternatives, Topsham, ME) and analysis (Steven Bursian, Dept. of Animal Science, Michigan State University) including the animals with the highest, typical and lowest BCC levels at the inland and lakeshore study areas in and out of the AOC. The only mink with jaw lesions (multiple squamous epithelial cysts or cell proliferations at multiple zones along the entire dental arcade, including bone lysis and cell atypia consistent with malignancy; Beckett et al. 2005, Bursian et al. 2006) was captured along the lakeshore in the AOC. It also had the highest total PCB concentration (by a factor of 2.46) and adipose TEQ (by a factor of 8.85) and the third highest liver TEQ (by a factor of 0.45) of the animals analyzed (Appendix 5). Therefore, it is still possible for a mink in the AOC to accumulate body burdens of BCCs that produce jaw lesions, the most sensitive indicator of exposure currently known. However, there is no evidence in the literature or from our observations of juvenile mink that current levels of



exposure along the lakeshore or inland, in or out of the AOC, are adversely affecting mink populations.

## **CONCLUSION**

This study documented the presence of mink populations, and mink reproduction, in the RELO AOC. Except for a single lakeshore mink with the highest BCC concentrations in its tissues, analytical, modeling and literature review results all suggest that mink reproduction is unlikely to be impaired in the AOC. Therefore, it is unlikely that BCC sources in the AOC are now contributing to the “degradation of fish and wildlife populations” and “bird or animal deformities or reproductive problems” use impairments identified in the RAP (1993, 1997). The results make clear that exposure to the Lake Ontario food web is associated with the highest levels of BCCs in mink in the AOC and elsewhere along the lakeshore.

The bioaccumulation model used in this study should be used to predict concentrations of dioxins/furans and PCBs in mink as new data on the concentrations of these chemicals in Lake Ontario or Braddock Bay water become available. We recommend that the USEPA or NYDEC sample the waters of Braddock Bay and lower Salmon Creek, the capture location of mink #17 with the highest concentrations of BCCs, during their future monitoring of Lake Ontario. Once the model predicts concentrations below the LOAEL for jaw lesions, further biological monitoring should be done by contracting with trappers to capture mink and sending their teeth for aging and their jaws for analysis of lesions. If age 1 mink, and older mink with no lesions, are found, confidence that mink exposed to the Lake Ontario food web are no longer at risk for population, reproductive or deformity problems will be high and delisting should proceed.

## ACKNOWLEDGMENTS

Individuals who assisted the various phases of this project are acknowledged in Appendices 1-4. Support for the project was provided by the New York Great Lakes Protection Fund by grant C302399.

## LITERATURE CITED

- Addison, E.M., G.A. Fox, and M.G. Gilbertson (eds.). 1991. Proceedings of the Expert Consultation Meeting on Mink and Otter. International Joint Commission, Windsor, ONT. ISBN 1-895085-32-2.
- Aulerich, R.J., and R.K. Ringer. 1977. Current status of PCB toxicity to mink, and effect on their reproduction. *Arch. Environ. Contamination Toxicol.* 6:279-292.
- Aulerich, R.J., R.K. Ringer, H.L. Seagran and W.G. Youatt. 1971. Effects of feeding coho salmon and other Great Lakes fish on mink reproduction. *J. Reproduction and Fertility* 19: 365-376.
- Beckett, K.J., S.D. Millsap, A.L. Blankenship, M.J. Zwiernik, J.P. Giesy, and S.J. Bursian. 2005. Squamous epithelial lesion of the mandibles and maxillae of wild mink (*Mustela vison*) naturally exposed to polychlorinated biphenyls. *Env. Tox. Chem.* 24: 674-677.
- Bursian, S.J., C. Sharma, R.J. Auerlich, B. Yamini, R.R. Mitchell, K.J. Beckett, C.E. Orazio, D. Moore, S. Svirsky, and D.E. Tillitt. 2006. Dietary exposure of mink (*Mustela vison*) to fish from the Housatonic River, Berkshire County, Massachusetts, USA: Effects on organ weights and histology and hepatic concentrations of polychlorinated biphenyls and 2,3,7,8-tetrachlorodibenzo-P-dioxin toxic equivalence. *Env. Tox. Chem.* 25: 1541-1550.
- Evans, R.D., E.M. Addison, J.Y. Villeneuve, K.S. MacDonald, and D.G. Joachim. 2000. Distribution of inorganic and methylmercury among tissues in Mink (*Mustela vison*) and Otter (*Lutra canadensis*). *Environmental Research Section A* 84: 133-139.
- Foley, R.E., S.J. Jackling, R.J. Sloan and M.K. Brown. 1988. Organochlorine and mercury residues in wild mink and otter: Comparison with fish. *Env. Tox. Chem.* 7: 363-374.
- Giesy, J.P., D.A. Verbrugge, R.A. Othout, W.W. Bowerman, M.A. Mora, P.D. Jones, J.L. Newsted, C. Vandervoot, S.N. Heaton, R.J. Aulerich, S.J. Bursian, J.P. Ludwig, G.A. Dawson, T.J. Kubiak, D.A. Best, and D.E. Tillitt. 1994. Contaminants in fishes from Great Lakes-influenced sections and above dams of three Michigan rivers. II: Implications for health of mink. *Archives of Environmental Contamination and Toxicology* 27: 213-223.

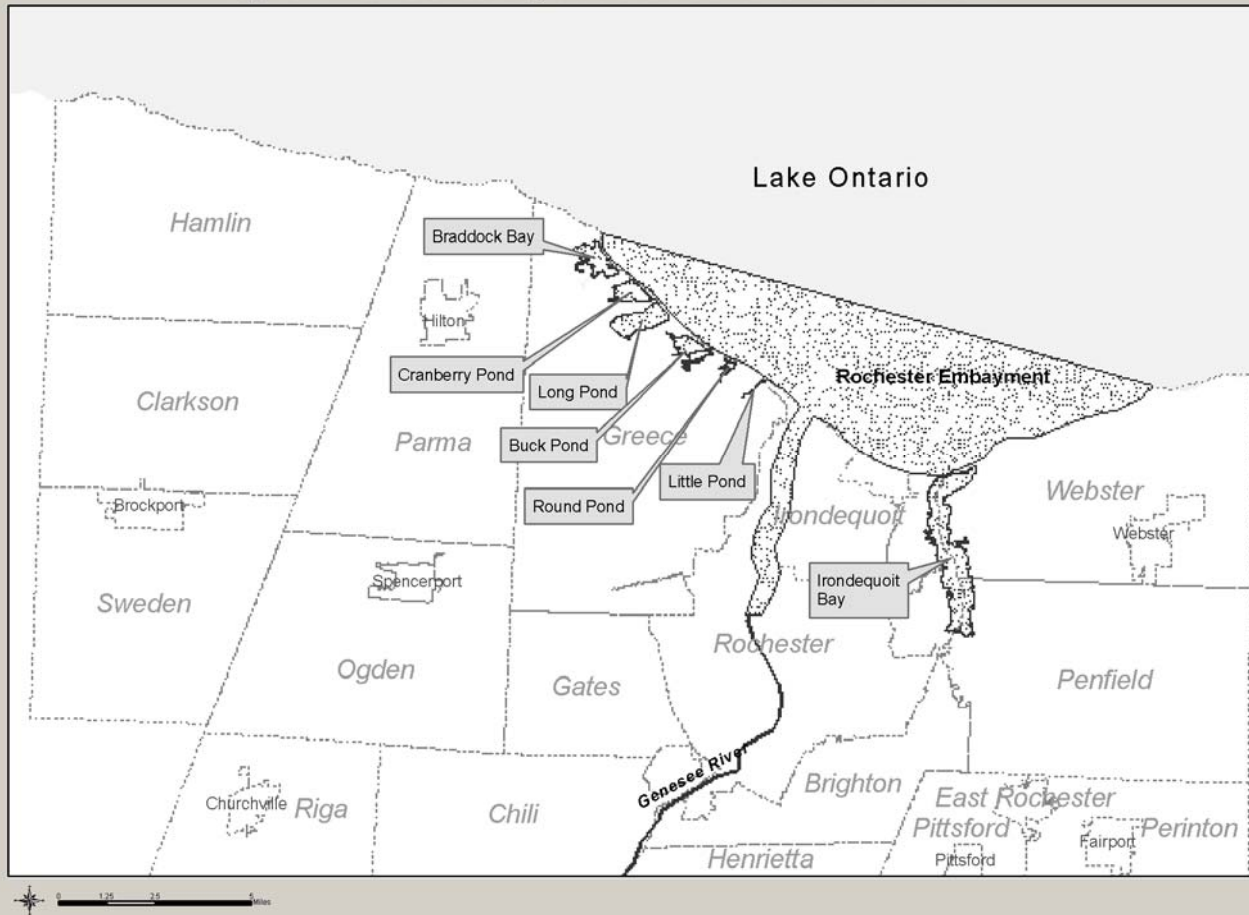
- Haynes, J.M., Pagano, J.J., and Wellman, S.T. 2002. New York State Great Lakes Protection Fund Application for State Assistance—RAP Progress in the Rochester Embayment of Lake Ontario: Population Monitoring, and Levels of Bioaccumulative Chemicals of Concern in Mink, a Sentinel Species.
- Illinois Natural History Survey. 2001. Mink Species Account.  
<http://www.inhs.uiuc.edu/dnr/fur/species/mink.html>
- Luckey, F., and S. Litten. 2005. Bioaccumulative Contaminants in Lake Ontario Surface Water, 1999. USEPA. New York, NY.
- Pagano, J.J., and J.M. Haynes. 2007. Levels of Bioaccumulative Chemicals of Concern in Mink In and Out of the Rochester Embayment Area of Concern and On and Off the Shoreline of Lake Ontario. Department of Environmental Science and Biology, State University of New York at Brockport. Brockport, N.Y.
- RAP. 1993. Stage I Remedial Action Plan for the Rochester Embayment of Lake Ontario. Monroe County Department of Health. Rochester, NY.
- RAP. 1997. Stage II Remedial Action Plan for the Rochester Embayment of Lake Ontario. Monroe County Department of Health. Rochester, NY.
- Render, J.A., S.J. Bursian, D.S. Rosenstein, and R.J. Aulerich. 2001. Squamous epithelium proliferation in the jaws of mink fed diets containing 3,3',4,4',5-pentachlorobiphenyl (PCB 126) or 2,3,7,8-tetrachlorodibenzo-p-dioxin (TCDD). *Veterinary and Human Toxicology* 43(1): 22-26
- Sample, B.E., D.M. Opresko, and G.W. Suter II. 1996. Toxicological Benchmarks for Wildlife: 1996 Revision. Oak Ridge National Laboratory. Oak Ridge, TN.
- Wellman, S.T., and Haynes, J.M. 2006a. Monitoring Mink Populations using Video Traps. Department of Environmental Science and Biology, State University of New York at Brockport. Brockport, N.Y.
- Wellman, S.T., and Haynes, J.M. 2006b. Age, Size, and Stable Isotope Data of Mink Populations, and a Predictive Model of Bioaccumulation of Chemicals of Concern in the Rochester Embayment of Lake Ontario. Department of Environmental Science and Biology, State University of New York at Brockport. Brockport, N.Y.
- Wellman, S.T., and Haynes, J.M. 2007. Bioaccumulative Chemicals of Concern in Mink: Adverse Effects Levels and Results of a Predictive Model for the Rochester Embayment of Lake Ontario. Department of Environmental Science and Biology, State University of New York at Brockport. Brockport, N.Y.
- Wobeser, G., Nielsen, N.O., Schiefer, B., 1976a. Mercury and mink. II. Experimental methyl mercury intoxication. *Canadian Journal of Comparative Medicine* 40: 34–45.
- Wren, C.D., Hunter, D.B., Leatherland, J.F., Stokes, P.M., 1987a. The effects of polychlorinated biphenyls and methylmercury, singly and in combination, on mink. I. Uptake and toxic responses. *Archives of Environmental Contamination and Toxicology* 16: 441–447.

- Wren, C.D., Hunter, D.B., Leatherland, J.F., Stokes, P.M., 1987b. The effects of polychlorinated biphenyls and methylmercury, singly and in combination on mink. II. Reproduction and kit development. Archives of Environmental Contamination and Toxicology 16: 449–454.
- Wren, C.E. 1991. Cause-effect linkages between chemicals and populations of mink (*Mustela vison*) and otter (*Lutra canadensis*) in the Great Lakes basin. J. Tox. Env. Health 33:549-585.

## FIGURES

**Figure 1.** Rochester Embayment of Lake Ontario Area of Concern (RELO AOC).

Figure 1: Rochester Embayment of Lake Ontario Area of Concern



**Figure 2.** Sub-basins considered in the Rochester Embayment of Lake Ontario Remedial Action Plan (RELO RAP).



## APPENDICES

### Appendix 1

#### **Are there Differences in the Relative Abundance of Lakeshore and Inland Mink Populations In and Out of the Rochester Embayment of Lake Ontario Area of Concern?: Monitoring Mink Populations Using Video Traps**

Sara T. Wellman and James M. Haynes

Department of Environmental Science and Biology  
State University of New York  
College at Brockport  
350 New Campus Drive  
Brockport, NY 14420-2973

March 2006

#### **OVERVIEW**

This report is the first of four from project C302399, “*RAP Progress in the Rochester Embayment of Lake Ontario: Population Monitoring, Trophic Relationships, and Levels of Bioaccumulative Chemicals of Concern in Mink, a Sentinel Species,*” funded by the New York Great Lakes Protection Fund in 2004. The project addresses use impairments related to water quality identified in the Remedial Action Plan for the Rochester Embayment of Lake Ontario (RELO RAP). This report deals with the development and use of video trapping systems that established the presence and reproduction of mink (*Mustela vison*) in and out of the RELO RAP Area of Concern (AOC). Three more reports will be written in 2006: (1) trophic positions (stable isotope analysis) and ages of mink (Wellman and Haynes, in preparation), (2) levels of bioaccumulative chemicals of concern (BCCs) in mink tissues (Pagano and Haynes, in preparation), and (3) a literature review of the effects BCCs on mink (Wellman, in preparation). Because the mink is the most sensitive species to BCCs known, the results of this study will determine if the fish and wildlife reproduction impairment for the RELO AOC can be recommended for delisting.

## TABLE OF CONTENTS

INTRODUCTION .....	18
METHODS AND MATERIALS .....	18
Locations of Study Sites .....	18
MustelaVision System .....	19
System Requirements.....	19
System Components.....	19
System Placement .....	20
Field Service .....	20
Data Recording .....	20
Data Sheets .....	20
Definitions and Formulas.....	21
Data Analysis.....	22
RESULTS AND DISCUSSION .....	23
Relative Abundances .....	23
Relationship of Mink Passage Rates to Mink Abundances .....	23
Mink Passage Rates .....	24
Changes in Passage Rates from 2003 to 2004 .....	25
Influence of Regional Descriptors .....	25
Influence of Site Descriptors .....	26
Ecological Observations .....	26
Mink Groups in the AOC.....	26
Observed Behaviors of Mink.....	27
CONCLUSION.....	29
ACKNOWLEDGMENTS .....	30
LITERATURE CITED .....	30
TABLES	
1. MustelaVision camera sites characterized by regional and site descriptors.....	33
2. Results of analysis of variance (GLM) of mink Passage Rates by Regional Descriptors .....	34
3. Results of analysis of variance (ANOVA) of mink Passage Rates by Site Descriptors .....	35
FIGURES	
1. Map showing placement of MustelaVision systems in four regions during 2003 and 2004.....	36
2. Mink Passage Rates calculated for each camera site during 2003 and 2004.....	37
3. Yearly changes (Delta Passage Rates) in mink passages for sites at which data were taken both years .....	38
APPENDICES	
A. MustelaVision Operations .....	39
B. Passage Rate Analyses .....	46
C. Regional Descriptor Analyses.....	46
D. Site Descriptor Analyses.....	50



## INTRODUCTION

In the 1980s the binational (Canada, U.S.) International Joint Commission (IJC) began the process of creating and implementing remedial action plans (RAPs) in 43 contaminated areas of concern (AOCs) throughout the Great Lakes Basin. The IJC established 14 “use impairments” that could cause a local area to be “listed” as an AOC, including “degradation of fish and wildlife populations” and “bird or animal deformities or reproductive problems.” In the Rochester AOC, both uses were defined as impaired because “very few” mink were then being trapped or observed within 2 miles of the lake (RAP 1993, 1997). This study was part of a project (Haynes *et al.* 2002) to determine whether lakeshore populations of mink along the Rochester Embayment of Lake Ontario (RELO) are negatively impacted by bioaccumulative chemicals of concern (BCCs) and, if so, whether the BCCs are originating in the embayment watershed or elsewhere.

The RELO AOC includes the Embayment, a 35 square mile portion of Lake Ontario south of a line between Bogus Point in the town of Parma and Nine Mile Point in the town of Webster (both in Monroe County, New York); adjacent wetlands and bays; and the six mile reach of the Genesee River from the Lower Falls to the mouth at Lake Ontario. The RAP also includes the subwatersheds of Salmon Creek, the Genesee River and Irondequoit Creek (RAP 1993, 1997; Figure 1).

The question addressed by this portion of the study was: Are there differences in the relative abundance of lakeshore and inland mink populations in and out of the RELO AOC? Our approach was to record the passage of mink using four “MustelaVision” videotrap systems in each of four regions designated as Lakeshore/AOC, Inland/AOC, Lakeshore/Out of AOC, and Inland/Out of AOC (Figure 1). Previous studies (cf. Gerrell 1970, Birks and Linn 1982, Eagle and Whitman 1987, Yamaguchi and MacDonald 2003) support our assumption that the number of mink passages recorded is related to relative population abundance (see Discussion). We tested the null hypothesis that there were no differences in passage rates among regions. We also went beyond the scope of our contract to look at the effect of several physical environmental variables on mink passage rates, and report on some observed mink behaviors.

## METHODS AND MATERIALS

### Locations of Study Sites

To maximize the chances of recording mink passages, we placed the Mustela-Vision systems in locations where mink were most likely to be found. Mink are semi-aquatic animals, found in wetlands and along water edges, especially with cover such as emergent vegetation, brush or forest (Linscombe *et al.* 1982, Allen 1986, Eagle and Whitman 1987, Dunstone 1993, Yamaguchi *et al.* 2003, Illinois Natural History Survey 2005, USDA Forest Service 2005).

Based on this information, the region chosen as Lakeshore/AOC was the Braddock Bay State Wildlife Management Area (BBWMA), a wetlands complex broadly connected to the RELO, separated only by narrow barrier beaches. The Inland/AOC region was around the Bergen Swamp, a smaller wetlands complex on Black Creek

(BLKCK), within the RELO watershed. The Inland/Out of AOC region was the Iroquois National Wildlife Refuge (INWR) and two connected state WMAs, a huge managed wetlands complex known to harbor abundant mink. Finally, the Lakeshore/Out of AOC region was along the Lake Ontario State Parkway (LOSPW) west of the RELO watershed, where creeks and small wetlands drain directly into Lake Ontario (Figure 1).

With the help of experienced trappers, we chose sites in each region most likely to be frequented by mink; in many cases we were guided by mink tracks or previous trappers' success. Each camera was placed near a water edge, either in a wetland or along a stream. Mink run along the edge of the water whenever possible (Burgess 1978, cited by Allen 1986; Eagle and Whitman 1987; Dunstone 1993; Yamaguchi *et al.* 2003; Yamaguchi and Macdonald 2003). Therefore, trappers usually set their traps at the corners of culverts and bridges where the minks' paths are funneled into these openings (Jamison 1983, Krause 1984, Geary 1985, National Trappers' Association 2005), and we looked for such tunnels when placing MustelaVision systems. Mink often use paths or "runways" through tall grass, cattails, and brush (Schladweiler and Storm 1969, Dunstone 1993, Racey and Euler 2003), and, according to trappers, ledges just under the water's surface along the bank, which also informed our choices of sites.

Because we were still searching for a suitable Lakeshore/Out of AOC region, no MustelaVision systems were placed in the LOSPW region in 2003. Systems were placed at 14 sites in the other three regions from June through October 2003. We considered the 2003 season our "exploratory season" during which we tried to find the best sites (i.e., most likely to observe mink passages) in each region, so either during 2003 or before the 2004 season, two systems in each of the original three regions were moved to potentially better locations. Thus, eight sites found in 2003, along with two new sites each in BBWMA and BLKCK and four new sites in the LOSP West region, were monitored from May to October 2004 (Table 1).

## **MustelaVision System**

### **System Requirements**

The MustelaVision system (Appendix A) was designed and built for this project by Jeffrey Wellman, an electrical engineer. We required a system usable in remote locations, powered by DC batteries, weatherproof, portable, lockable and affordable. To save battery power, videotape, and time for tabulating data, the system had to be triggered by the animal, rather than recording continuously. It also had to work day and night, because mink are considered predominantly nocturnal (cf. Birks and Linn 1982, Allen 1986, Eagle and Whitman 1987), and to operate quietly and invisibly to avoid disturbing the wary animals (Jamison 1983, Krause 1984, Barker 1991, Dunstone 1993).

### **System Components**

The MustelaVision system (Appendix A-1a, b) consisted of an electronic camera head (Appendix A-1a, c) designed for security applications (Model PIC-I, SpyCameras ForLess.com), a 12-volt, 2-head videocassette recorder (Jensen KVC1500), a 12-volt DC deep-discharge battery, and a custom-built circuit board (Appendix A-1d) to protect the batteries from over-discharge which would shorten their useful lives. The camera head was attached to the VCR by a 50-foot cable, and it communicated with the VCR with an IR LED (infrared light emitting diode) that emulated the VCR's remote control unit.

The black and white Sony CCD (charge-coupled device) camera had a 464 X 625 pixel array, with 8-bit resolution, and a 92-degree field of view. The camera monitored an area 3 m wide by at least 12 m deep (depending on the camera angle relative to the ground). For image capture in the dark the camera head had six IR LEDs, providing a pool of illumination on the ground about 1 m wide by 2 m deep (again depending on camera angle. However, animals could be detected up to at least 10 m from the camera at night due to eye shine and their body heat against a cooler background.

The camera head had an IR motion detector that monitored a 104-degree by 15 m field. (Motion detection outside the viewing area meant fewer missed targets but more false triggers.) When the sensor detected motion it issued a “start recording” command to the VCR and started a 30-sec timer. If further motion was detected during the 30-sec period, the timer reset and recording time was extended. If no more motion was detected, after 30 seconds the camera head issued a “stop recording” command to the VCR.

### **System Placement**

With one exception (a potential den site about 2 m from the water on Bald Eagle Creek’s west bank, LOSPW), each camera was placed on a stake within a meter of the water’s edge; often the stake was placed in the water. Each camera was aimed at the water’s edge to include in its field of view the pathway along which a mink would travel and the edge of the water in and along which it would forage. If the site included a tunnel, we aimed the camera at the opening through which mink would be forced to travel.

Along with mink habitat preferences, certain characteristics of the MustelaVision system dictated site choice and camera placement for optimal performance. Sites had to be near a road because of heavy batteries. To minimize tampering, the system had to be hidden in brush near a tree or other structure to which we could lock it. Also, we looked for high ground to avoid flooding and for shade to avoid overheating the electronics.

Camera angle was also important to avoid spurious triggers. We had to avoid sunbeams directed into the camera or reflected off water, vegetation near the camera that would trigger it during a breeze, and road and pedestrian traffic.

### **Field Service**

Each MustelaVision system was serviced once per week. The batteries and videotapes were replaced, the camera lens was cleaned, the system was checked for functionality, and the field of view was checked for mink tracks and scats.

## **Data Recording**

### **Data Sheets**

**System Log:** Each MustelaVision system was assigned a letter to identify it, and had a separate log sheet (Appendix A-2a). During each field service session, we recorded on each System Log sheet the date of service, the ID numbers of the videotape cassette and battery, and comments such as mink tracks observed or operational problems.

**Tape Log:** Before viewing each videocassette, we recorded on its Tape Log (Appendix A-2b) which system the tape had been in, system location, dates during which the tape was in the system, and the total length of videotape recorded during that time. As we viewed the tape, we recorded periods of daylight and darkness, and all animals coming into the field of view of the camera.

### **Definitions and Formulas**

**Session:** A Video Session was defined as the video recorded at one site on one cassette between service dates noted in System Log.

**Mink Passage:** A Mink Passage was defined as any time a mink came into the field of view of the camera and the camera was triggered and then turned off 30 sec after the mink left. Thus, if the mink passed out of the field of view and then back in before the camera stopped recording (no matter how many times), that was recorded as only one passage. In the rare cases in which multiple mink were recorded, their number was noted for that passage.

**Trap Nights:** Trap Nights were the number of 24-h periods observed on a video tape. In the video data log, a Trap Night was recorded for each period of contiguous dark shots, separated by daylight shots. If the camera was not triggered during a day, two consecutive nights could have been counted as one Trap Night. Thus, estimates were bounded by using Minimum and Maximum Trap Night calculations, in which the Min Trap Nights was the number of Trap Nights seen on the video during that session, and the Max Trap Nights was the number of nights between service dates in the System Log. If no nights were seen, but there were day shots, the Min Trap Nights was recorded as one. If the system triggered properly when started (recording our initial test hand wave, indicating that it was functioning properly), but otherwise did not trigger during the week (Session), the Trap Nights and Passages were recorded as zeros. If the system was non-functional throughout the Session (i.e. nothing on videotape at all, not even our hand wave), the Trap Nights and Passages were left blank and excluded from calculations.

**Day vs. Night:** A mink Passage was recorded as occurring during “Day” at any time that the natural illumination was sufficient to see outside the field of illumination of the camera head’s IR LEDs. When only objects illuminated by the camera’s LEDs could be seen, Passages were defined as “Night”. Light levels could not be used to define twilight because the camera had automatic brightness compensation, so that apparent light levels did not correspond to true ambient light levels.

**Regional Descriptors:** For the sake of easy reference during the following analyses, we define “Regional Descriptors” as those describing the four separate regions in which we worked, based on their characteristics on a landscape scale of many square kilometers. These Regional Descriptors were Inside vs. Outside the AOC (AOC In vs. Out); Inland vs. Lakeshore; and Landscape: Wetlands (large wetlands complex) vs. Mixed (habitat including uplands, streams, and small wetlands) (Table ).

**Site Descriptors:** In order to evaluate the influence of ecological factors at each site on mink Passage Indices, we classified each camera site according to four factors. Habitat was classified as wetland, upland, or mixed, based on the types of vegetation visible around each camera site (many square meters). Cover was classified as cattail, brush, or forest, based on the vegetation at the camera’s specific location and in its field of view (a few square meters). We also recorded whether the water ran through a Tunnel (i.e., culvert or bridge) and whether each site had an underwater Ledge (Table ).

### **Data Analysis**

System Log sheets, Tape Log sheets, data keeping, and non-statistical calculations were done using Microsoft ® Excel 2000 by Microsoft Corporation.

Statistical analysis was done using Minitab™ Statistical Software Release 14.13 (Minitab Inc. 2005).

Data from each year at each site were originally kept separately because the habitat quality of each site could have varied from year to year due to weather or wetland management practices. We also kept the yearly data separate because we wanted to determine the potential impact on MustelaVision results of trapping we had contracted for in the AOC to collect tissue samples for other parts of the project.

Passage Rates (PRs) were calculated by dividing the number of mink Passages by the number of Trap Nights at a site. Since the Trap Nights had minimum and maximum values, corresponding maximum (Max) and minimum (Min) PRs were calculated for each site in each year. To determine whether the PRs changed from 2003 to 2004, we calculated “Delta PRs” at each site for which we had data from both years. To estimate the maximum possible change in passage rate (Max Delta PR) for each site, we subtracted that site’s 2003 Min PR from its 2004 Max PR; to estimate the minimum possible change in passage rate (Min Delta PR) we subtracted the 2003 Max PR from the 2004 Min PR. Thus, a positive Delta PR would indicate an increase in PR from 2003 to 2004. Using the Max Delta PRs from all sites as one data set, and the Min Delta PRs as a separate data set, we used one-sample T-tests to see if the mean difference (e.g., for either Max Delta PR or Min Delta PR) between years was different from zero. Means other than zero would have indicated a change in PRs from year to year. Since no differences were found, for subsequent analyses we combined the Passage Rate data from both years into two data sets (Max and Min PR) in which values for each year at each site were used as separate observations.

The INWR (Out of AOC study area) has a long history of targeted mink trapping, whereas the AOC does not. Therefore, we were concerned that when we contracted for mink trapping in the AOC (BBWMA and BLKCK regions) we would deplete a population already thought to be small. To assess the impact of our trapping in the AOC, we used two-sample T-tests to compare Min and Max PRs between the AOC and the INWR (we had no Delta PR data for LOSP West since no work was done there in 2003).

To evaluate the effects of the Regional Descriptors (AOC: In vs. Out, and Inland vs. Lakeshore) on the PRs, we used Minitab’s General Linear Model (GLM, a 2-way ANOVA with unbalanced cells, Tukey pairwise comparisons). We did an analysis for Max and Min PR. In a preliminary analysis, the site at Route 77 in the INWR in 2004 (Inland/Out of AOC) was an outlier with a standard residual greater than 4.7 (Figure 2). Therefore, we eliminated Min and Max PRs for that site in 2004. Also, because in the preliminary analysis the interaction between the Regional Descriptors AOC: In vs. Out, and Inland vs. Lakeshore was stronger than the effect of the descriptors themselves, we included a third Regional Descriptor, Landscape: Wetlands vs. Mixed Habitat, which exactly accounted for (i.e., the P-values were identical) the interactions in the earlier test. We estimated the power of the GLM using Minitab’s 2-Level Factorial power calculator (Factors = 3, Corners = 4, Replicates = 4, Effects = the differences between the means for each Regional Descriptor). Although this calculator was not designed for use with unbalanced cells, using the minimum number of replicates present in any of our regions yielded a conservatively low estimate of the actual power (Minitab support staff 2006, personal communication).

To evaluate the influences of the Site Descriptors on the variability of the PRs within each study Region, we did a one-way ANOVA for each Site Descriptor (Habitat: wetland, upland, mixed; Cover: cattail, brush, forest; Ledge: present, absent; Tunnel: present, absent). We also compared mink Passages during Day and Night, summed over all sites and both years, using a Chi-square test to determine whether there was any significant difference between the numbers of Passages during day and night.

## RESULTS AND DISCUSSION

### Relative Abundances

#### Relationship of Mink Passage Rates to Mink Abundances

Mink population density varies with habitat type; prey density, distribution and reliability; den availability; intraspecific aggression; and predation (Birks and Linn 1982, Linscombe *et al.* 1982, Allen 1986, Eagle and Whitman 1987, Dunstone 1993, Halliwell and MacDonald 1996, Sidorovich and Macdonald 2001, Yamaguchi *et al.* 2003). The sizes of minks' home ranges likewise vary with habitat quality, especially food supply, population structure and social stability of a population (Mitchell 1961, Allen 1986, Eagle and Whitman 1987). Thus, with reliably abundant food, mink populations are more dense and home ranges smaller, although in heavily trapped areas, the remaining males may have larger home ranges (Birks and Linn 1982, Eagle and Whitman 1987).

A number of studies show that mink are not strictly territorial and that their home ranges often overlap. Eagle and Whitman (1987) reported intrasexual territoriality in which home ranges of individuals of the same sex did not overlap, but females had home ranges inside males' territories. In contrast, Mitchell (1961) observed that adult male home ranges overlapped with juvenile males (even during the breeding season) but not with adult males. Gerrell (1970) reported that the home ranges of two of the four adult males he radio-tracked were visited by other adult males and females. The other two adult males visited other minks' home ranges, with one of them using the same den and core area used by an adult female two months earlier. He found that adult male home ranges often included home ranges of females with zones of overlap and zones monopolized by each mink. Occasionally both mink were present simultaneously in the zone of overlap, but usually intrusions occurred without direct confrontations when the owner was not present at that end of the home range. Linscombe *et al.* (1982) observed no active defense of any part of minks' home ranges from other mink of the same sex. Yamaguchi and MacDonald's (2003) radio-tracking study showed home range overlap ranging from 33% for female overlapping male to 88% for male overlapping male.

Mink use multiple dens within their home ranges, and move frequently between them as they cover their home range. Birks and Linn (1982) reported that the number of dens correlated with linear distance of home range, and that most den stays lasted less than one day. Allen (1986) reported stays ranging from a single night to a maximum of 40 days, with average distance between dens ranging from less than 90 m to 234 m in the U.S. In Sweden, Gerrell (1970) observed that mink usually used the nearest available den, with an average distance between dens used on consecutive days of 544 m. A juvenile female radio-tagged in east-central Minnesota by Schladweiler and Storm (1969) used 20 different dens prior to and during a 29-day study; only once was a den used for two

consecutive days. The straight-line distance between her daily dens varied from 99 to 849 m, averaging 353 m. Stevens *et al.* (1997) radio-tracked three males on large streams in eastern Tennessee, and found that the number of dens within home ranges varied from 8 to 24, and overnight movements of up to 4300 m were recorded.

Gerell (1970) reported that mink movements showed oscillations on two scales; small-scale movements, usually within <300m, were repeated in different parts of the home range until the entire home range was covered. All mink radio-tracked by Birks and Linn (1982) twice a day revealed more than 80% of their total home range within 5 days, and their entire home range within 10 days. Furthermore, Halliwell and MacDonald's (1996) statement that "most" territories were established by November implies that territories and home ranges may have been relatively fluid during the months of our study (May through October) when transients and dispersing juveniles would have been moving about.

Given the above, if mink are abundant enough, their home ranges or territories should abut one another, if not overlap. As population densities increase, home ranges become smaller, overlaps become greater, or both. Thus, because of the peripatetic nature of mink, higher population densities should result in higher rates of passage, whether from more mink passing through the same site, the same mink passing more often, or both. Thus, we are confident that our Passage Rate indices reflect relative mink numbers.

#### **Mink Passage Rates**

Mink Passages per Trap Night (Figure 2) varied from zero to 2.21 (INWR Route 77, 2004; Inland/Out of AOC) among sites and years, with a grand mean between 0.116 (Min PRs) and 0.216 (Max PRs). PRs were zero at nine of the 30 sampling sites; a Chi-square test showed no significant difference in the proportions of zero PRs between regions (Chi-Sq = 0.883, DF = 3, P = 0.830). The Passage Rates appeared to be higher and more variable in the AOC/Lakeshore (BBWMA) and the Out of AOC/Inland (INWR) regions, both of which are large wetlands complexes managed for the benefit of wildlife.

We suspect that mink had denned very close to the MustelaVision camera located on Route 77 in the INWR in 2004 (the statistical outlier), resulting in the unusually high PRs at this site (Figure 2). Several times in mid-August we recorded multiple mink traveling together there. This led us to suspect the presence of a den, since mink are normally solitary except during mating season (January through March, when we were not recording) and when mothers are raising their young from May through late summer (Mitchell 1961, Gerell 1970, Linscombe *et al.* 1982, Dunstone 1993, Illinois Natural History Survey 2005).

We tried to establish AOC Inland sites in the large Bergen Swamp complex, but there are no roads through it, so we had to choose sites on private lands outside the swamp. The Lakeshore Marshes Wildlife Management Area east of Sodus Bay would have been a close match in many ways to the BBWMA, but again there were no roads through the wetlands, so we had to resort to the LOSP West sites. (Roads were important primarily because they provide bridges or culverts at which to place cameras, and secondarily for convenience of servicing MustelaVision systems.) Thus, the AOC: In/Inland and the AOC: Out/Lakeshore regions consisted of more upland or mixed habitat than the large wetlands complexes of the AOC: In/Lakeshore and the AOC: Out/Inland regions, a circumstance that complicated our analyses (see below).

### **Changes in Passage Rates from 2003 to 2004**

Changes in Passage Rates (Delta PRs) at sites for which we had two years' of data are shown in Figure 3. In 2003 and 2004, Delta PRs in the AOC (Lakeshore and Inland combined) were close to zero but they varied somewhat from zero in the Inland-Out of AOC area. However, the means of the Min and Max Delta PRs did not differ from zero (Min Delta PR:  $P = 0.428$ , Max Delta PR:  $P = 0.511$ ; Appendix B: Table B-1), indicating that overall Passage Rates did not change between 2003 and 2004. This lack of change in PRs from year to year allowed us to combine both years' data for subsequent analyses.

There was no difference between the AOC and the Out of AOC regions in either Min Delta PR ( $P = 0.554$ ) or Max Delta PR ( $P = 0.938$ ) (Appendix B: Table B-2). The lack of differences among the Delta PRs for the BBWMA and the INWR between 2003 and 2004 was reassuring because we had contracted for mink trapping in the AOC (where mink had not been targeted previously) to get tissue samples required for other portions of the project. We were apprehensive about trapping the populations of concern, but the results showed no negative effect on the AOC populations, either Inland or Lakeshore.

The larger variation in Delta PRs in the INWR (Inland-Out of AOC) as compared to the BBWMA (Lakeshore-In AOC) may have been due to the fact that the INWR is a managed wetlands complex in which different areas were flooded in 2004 than in 2003. This could have changed the habitat quality in the areas around the MustelaVision sites, resulting in larger or smaller numbers of mink near each site. In contrast, the water levels in the BBWMA wetlands are naturally controlled by their connections to Lake Ontario, the level of which is tightly regulated; thus, habitat quality at MustelaVision sites there should have been more consistent from 2003 to 2004.

### **Influence of Regional Descriptors: Inland vs. Lakeshore, AOC: In vs. Out, and Landscape: Wetlands vs. Mixed**

In the General Linear Model crossing the three Regional Descriptors, AOC: In vs. Out; Inland vs. Lakeshore; and Landscape: Wetlands vs. Mixed (Table 2), the descriptive statistics (Appendix C-1: Tables C-1a-c) and the main effects plots of the GLM (Appendix C-2: Figures C-1a-b) suggest that Passage Rates were lower inside the AOC than out of it, lower along the lakeshore than inland, and higher in the wetlands complexes than in mixed landscapes. However, the GLM itself (Appendix C-3: Table C-3) showed that AOC: In vs. Out had no significant effect (Max PR:  $P = 0.404$ ; Min PR:  $P = 0.446$ ), nor did Inland vs. Lakeshore (Max PR:  $P = 0.251$ ; Min PR:  $P = 0.342$ ). In contrast, the P-values for Landscape: Wetlands vs. Mixed were significant, at 0.026 and 0.042 for the Max and Min PRs, respectively.

The strong effect of Landscape (Table 2) was no surprise, as wetlands are known to be preferred habitat for mink (Allen 1986, Eagle and Whitman 1987, Dunstone 1993, Sidorovich and Macdonald 2001). The significance of the results for Landscape also make power calculations irrelevant (Chittenden 2002). The ability of the GLM to factor out this effect was important in evaluating our ability to answer the questions posed by this study.

The P-values (Table 2) for the Regional Descriptors AOC: In vs. Out (0.404-0.446) and Inland vs. Lakeshore (0.251-0.342) supported the null hypotheses of no difference between mink PRs for either descriptor. However, due to the small sample sizes the power of the GLM was low ( $\geq 0.254$  for AOC: In vs. Out and  $\geq 0.094$  for



Lakeshore vs. Inland, although the actual power was somewhat higher because these numbers were calculated assuming only four sites in each region). In order to achieve a power of 0.8 for each test, given the differences between the means the number of replications (MustelaVision sites) in each region would have to have been 17 for AOC: In vs. Out, and 71 for Lakeshore vs. Inland. Although these results suggest that it may be possible to delist the “Degradation of Fish and Wildlife Populations” use impairment for mink in the Rochester Embayment, the low power of the tests (i.e., probability of finding no significant differences among treatments when differences exist) suggests that further evidence is needed before delisting can occur, such as results from the portion of this study on the levels of bioaccumulative chemicals of concern (BCCs) in mink tissues (Pagano and Haynes, in preparation).

#### **Influence of Site Descriptors**

None of Cover (brush, cattails, forest; Appendix D-1: Table D-1a), Habitat type (wetland, upland, mixed; Appendix D-1: Table D-1b), or underwater Ledge (presence or absence; Appendix D-1: Table D-1c) significantly affected PRs, but again, because of low sample sizes, statistical power to distinguish these effects was low (Table 3). While Habitat (wetland, upland, mixed) and Cover (cattail, brush, forest) had similar definitions, they applied to larger and smaller areas, respectively, around the MustelaVision sites. That the P-values for Cover were lower than those for Habitat implies that the likelihood of observing mink passage is more heavily influenced by site choice at a small scale, particularly the type of cover present at the camera site. This is similar to Bonesi and Macdonald’s (2004) finding that the habitat characteristics closest to the water had the strongest effect upon the duration of coexistence of otter and mink in England.

The Site Descriptor Tunnel had a highly significant effect on Passage Rates (Table 3; Appendix D-1: Table D-1d). This result was not unexpected. We were repeatedly told by trappers to place the cameras at culverts and bridges where mink following the water’s edge would enter the tunnel rather than leave the water to cross a road. Examination of the sites’ characteristics showed that the lack of a tunnel was the one thing that all sites with PRs of zero had in common (although not all sites without tunnels had PRs of zero). Unfortunately, the sites with tunnels were not evenly distributed between the Wetlands and the Mixed Landscapes. In the Wetlands regions, nine of 17 sites were tunnels, but in the Mixed regions only one of 12 sites was a tunnel (Chi-square = 6.196, DF = 1, P = 0.013). Thus, the effect of Tunnels on the PRs likely confounded the Wetlands effect in the Regional Descriptors GLM, indicating that careful camera site choice is an important factor in a study of this type, especially for animals with microhabitat preferences as specific as mink. Future studies should be certain that tunnels are fully represented in all experimental treatments or blocks.

#### **Ecological Observations**

##### **Mink Groups in the AOC**

The most exciting results were a hoped-for bonus of the study. We recorded four instances of mink families in the AOC: two in the BBWMA (Lakeshore-In AOC) and two in the BLKCK (Inland-In AOC) region. (We also recorded family groups at Route 77 in the INWR Inland-Out of AOC, but none in the LOSPW Lakeshore-AOC region.) At the Sackett Road site in the BLKCK region (AOC-Inland) on 23 June 2003, we recorded

one adult and two young mink traveling together. At the same site on 30 June 2004, we recorded two mink together. At Round Pond Creek in the BBWMA (AOC-Lakeshore) on 19 July 2004, we recorded one adult and four young. About two weeks later, on 5 August 2004, we recorded two animals traveling together at that site.

As mentioned above, mink are normally solitary except for mating pairs and mothers with kits. In two of the recordings of multiple mink in the AOC, it was obvious that there was one adult and several young. Since fathers take no part in raising the young (USDA Forest Service 2005), the adults observed with young were assumed to be their mothers. In the two cases in which we recorded two mink traveling together in the AOC, and their relationship was not obvious, we assumed that they were family members because these recordings were made during summer, before the young would have dispersed, rather than during mating season. This assumption is supported by Mitchell (1961) who reported that mink often travel in pairs, either two kits or a mother and daughter, until late fall.

This proof of reproduction of mink in the AOC, especially along the lakeshore, may justify delisting the current “Bird or Animal Deformities or Reproductive Problems” use impairment for the Rochester Embayment of Lake Ontario.

### **Observed Behaviors of Mink**

#### **Nocturnality of Mink**

Many sources indicate that mink are primarily nocturnal (Birks and Linn 1982, Linscombe *et al.* 1982, Jamison 1983, Krause 1984, Geary 1985, Allen 1986, Eagle and Whitman 1987, Illinois Natural History Survey 2001, USDA Forest Service 2005). Our observations refuted this widely held belief. In 2003 and 2004, respectively, 65 of 109 mink passages (59.6%) and 71 of 116 (61.2%) were recorded as “Day,” i.e., the majority of mink passages were observed by natural light rather than the camera’s IR illumination. There was a statistical trend ( $0.05 < P < 0.1$ ) toward a greater number of day than night Passages (Chi-square = 0.058, DF = 1, P = 0.809), which would not be the case if mink were mostly nocturnal. Given the observed ratio of Day to Night passages of 3:2, even if we had missed one-third of the night passages the conclusion of non-nocturnality would not be affected. This scenario is extremely unlikely, as the infrared VCR trigger is more sensitive at night because of the surroundings being cooler and the lack of IR from the sun. Also, since most animals’ eyes are highly reflective in the IR, and warm-blooded animals emit IR, we often saw them long before they entered the pool of IR that illuminated the entire animal on camera. Finally, the frequency at which we observed mice outside the IR pool of illumination at night causes us to believe that we would not often have missed a mink.

Although our definition of “Day” could apply during the twilight hours of dawn and dusk, it was obvious when watching the videos, judging by sun and shadow angles and knowing the orientation of the camera, that most of the “Day” passages took place in broad daylight, many at midday. Linscombe *et al.* (1982) cited reports by Gerell (1969) that females with kits were primarily diurnal and by Marshall (1936) that both sexes were most active between dawn and dusk in winter. However, neither of these reports would explain our findings, as less than 4% of our observations were of family units, and we were not recording during winter. Birks and Linn (1982) reported that 75% of inter-den or long distance movements were made at night, speculating that that may be why most are trapped at night and thus thought to be nocturnal.

### **Repeated Passages**

On a number of occasions, mink were seen passing through the camera's field of view several times during the same day or night. They might then not be seen again for days or weeks, having apparently moved out of the area. At Cayuga Pool in the INWR (Inland-Out of AOC) on 27 June 2003, a mink crossed the field of view eight times while exhibiting searching behavior and covering the area thoroughly before disappearing. As it occurred in broad daylight, we were able to judge by shadow angles that this happened within a fairly short period of time (minutes rather than hours). This corresponds with Gerrell's (1970) reports of small-scale oscillatory movements superimposed upon larger-scale movements covering the home range.

### **Flight from a Predator**

At the same location on the same day, a very different behavior was seen—a mink ran fast and straight through the entire field of view, disappearing in seconds. The probable explanation for this unusual behavior was following several feet behind the fleeing mink—the shadow of a large bird such, probably a hawk, was easily visible. Eagle and Whitman (1987) and Dunstone (1993) reported that mink are preyed upon by hawks, owls and eagles.

This potential for predation from overhead may explain why Cover was such an important factor in determining Passage Rates at a camera site. Mason and Macdonald (1983), Allen (1987), Eagle and Whitman (1987) and Yamaguchi *et al.* (2003) agree that mink prefer to stay under cover and avoid open areas. In retrospect, we realized that most of the sites with zero PRs had no cover immediately adjacent to the water's edge, though it may have been less than a meter away. At one of these sites, Cole Road in the BLKCK region in 2004, we recorded a hawk taking a duck from alongside the bank.

### **Predation on a Fish**

At a stream site in the BLKCK region (Inland-In AOC) on 23 June 2004, we recorded a mink catching a fish. Although this was a night shot, and the event occurred at the edge of the IR field of illumination, recognition of the event was aided by the fact that this particular camera had a microphone. We heard a splash, and then saw the mink on the bank holding a fish; the mink had apparently dived into the water after sighting the fish, exactly as Dunstone (1993) and Eagle and Whitman (1987) reported.

### **Ice-breaking**

At Bill's Point, a site in the BBWMA (Lakeshore-In AOC) on 25 November 2002, we recorded a mink breaking up a thin film of ice which was forming over an area where mink had frequently been seen swimming before. The mink swam under the ice and butted its head up against it until it broke; it repeated this behavior many times until most of the ice film was broken up, before swimming out of view.

## **CONCLUSION**

The central question addressed by this study was: Are there differences in the relative abundance of lakeshore and inland mink populations in and out of the AOC? Our MustelaVision data tentatively suggest that there are no differences in mink populations inside and outside the AOC or between the lakeshore and inland areas, but the statistical power of our tests was low due to small sample sizes. We also showed that (1) landscape-scale features (wetland complexes) and microhabitat factors (tunnels) are key predictors

of mink presence or absence at a sampling site, (2) mink are successfully reproducing in the AOC, and (3) mink are not chiefly nocturnal. While the data in this report alone do not support delisting the RELO AOC use impairments for wildlife population degradation and reproductive problems, in combination with the chemical data also collected in this study (Pagano and Haynes, in preparation), we believe the time for delisting is approaching in the near future.

Many researchers have tried to estimate mink abundances. Some rely upon harvest records (cf. Linscombe 1982, Eagle and Whitman 1987), but this method can be confounded by trapping conditions, weather, number of trappers working the area, and other factors. Other studies rely on live-trapping (cf. Mitchell 1961, Halliwell and Macdonald 1996), but this can be fatal to mink. Mitchell reported that over 5% of trapped mink died upon capture, and Barker (1991) reported that, although released alive and apparently unharmed, mink may die of stress-related gastric hemorrhaging within a few days. Finally, some studies (cf. Mason and Macdonald 1983, Sidorovich and Macdonald 2001, Racey and Euler 2003) rely on the abundance of mink signs such as tracks, scats and scent posts, all of which can be easy to overlook and hard to relate to numbers of individuals if their home ranges overlap.

Our literature review found only two other studies that referred to the use of video cameras in population monitoring, neither of which was comparable to this study. Rutberg *et al.* (2004) used hand-held video cameras to record deer while driving around the perimeter of their study area, but this was only part of their effort, most of which focused on counting deer while “beating” or “driving” them with large numbers of people on foot. Westera *et al.* (2003) used video cameras to count fish attracted to bait stations in an effort to estimate abundances, but unlike our study they were not recording natural rates of passage. Hence we believe that we have developed a novel method that shows potential for monitoring relative population size, with appropriate care in camera placement, and has the added benefit of revealing the natural behaviors of the animals under study.

## ACKNOWLEDGMENTS

We are extremely grateful to Jeffrey Wellman who put in many hours designing, building and maintaining the MustelaVision systems. We are also very grateful to Randy Baase who spent many hours in the field servicing each MustelaVision system weekly for months and who taught us much about mink. Thanks are also due to other trappers who taught us about mink: Matt Lochner (who also helped set up and service MustelaVisions) and Dan Frey, and to the landowners near the Bergen Swamp who allowed us to place MustelaVision systems on their property: “Doc” Fink, Dick Sands, Mel Reber and Al Burkhardt. We also thank Marc Chalupnicki for tabulating data and Albert Fulton for creating Figure 1. The government personnel who graciously allowed us to work in their territories include NYS DEC: Dan Carroll, Dave Woodruff and Heidi Bogner; NYS OPRHP: James Slusarczyk, and USFWS: Bob Lamoy and Paul Hess. We gratefully acknowledge grant C302399 from the New York State Great Lakes Protection Fund which made this study possible. Finally, we thank reviewers at NYS DEC and Dr. Daniel Simberloff, University of Tennessee at Knoxville, for their feedback, especially statistical, on an earlier version of this report.

## LITERATURE CITED

- Allen, A.W. 1986. Habitat suitability index models: mink, revised. U.S. Department of the Interior Fish and Wildlife Service. Biol. Rept. 82 (10-127).
- Barker, I.H. 1991. Non-toxic Diseases of Mink and River Otter. Pages 19-20 *in* Addison, E.M., G.A. Fox, and M.G. Gilbertson (eds.), Proceedings of the Expert Consultation Meeting on Mink and Otter. International Joint Commission, Windsor ONT. ISBN 1-895085-32-2.
- Birks, J.D.S., and I.J. Linn. 1982. Studies on the home range of feral mink (*Mustela vison*). *Symposia of the Zoological Society of London* 49: 231–257.
- Bonesi, L., and D.W. Macdonald. 2004. Evaluation of sign surveys as a way to estimate the relative abundance of American mink (*Mustela vison*). *Journal of Zoology* 262(1): 65-72.
- Chittenden, M.E., Jr. 2002. Given a significance test, how large a sample size is large enough? *Fisheries* 27(8): 25-29.
- Dunstone, N. 1993. *The Mink*. T&AD Poyser. London.
- Eagle, T. C., and J. S. Whitman. 1987. Mink. Pages 614-625 *in* M. Novak, J. A. Baker, M. E. Obbard, and B. Mallock, eds. *Wild furbearer management and conservation in North America*. Ontario Trappers Assoc. and Ontario Ministry Nat. Resour.
- Geary, S.M. 1985. *Fur Trapping in North America, Revised Edition*. Winchester Press, New Century Publishers, Inc. Piscataway, NJ.
- Gerell, R. (1970). Home ranges and movements of the mink *Mustela vison* in southern Sweden. *Oikos* 21: 160-173.

- Halliwell, E.C., and D.W. Macdonald. 1996. American mink *Mustela vison* in the Upper Thames catchment: Relationship with selected prey species and den availability. *Biological Conservation* 76(1): 51-56.
- Haynes, J.M., Pagano, J.J., and Wellman, S.T. 2002. New York State Great Lakes Protection Fund Application for State Assistance—RAP Progress in the Rochester Embayment of Lake Ontario: Population Monitoring, and Levels of Bioaccumulative Chemicals of Concern in Mink, a Sentinel Species.
- Illinois Natural History Survey. 2005. Mink Species Account. <http://www.inhs.uiuc.edu/dnr/fur/species/mink.html>
- Jamison, R. 1983. *The Trapper's Handbook*. DBI Books Inc. Northfield, IL.
- Krause, T. 1984. *National Trappers' Association Trapping Handbook*. United Graphics, Inc. Mattoon, IL.
- Linscombe, G., N. Kinler, and R.J. Aulerich. 1982. Mink (*Mustela vison*). Pages 629-643 in Chapman, G.A. and J.A. Feldhamer, eds. *Wild mammals of North America—Biology, management, economics*. John Hopkins University Press. Baltimore, MD
- Mason, C.F., and S.M. Macdonald 1983. Some factors influencing the distribution of mink (*Mustela vison*). *Zoological Society of London* 200: 281-283.
- Mitchell, J.L. 1961. Mink movements and populations on a Montana river. *J. Wildlife Management* 25(1): 48-54.
- National Trappers' Association. 2005. The Mink. [www.nationaltrappers.com/Mink.html](http://www.nationaltrappers.com/Mink.html)
- Racey, G.D., and D.L. Euler. 2003. Changes in mink habitat and food selection as influenced by cottage development in central Ontario." *J. Applied Ecology* 20(2): 387-401.
- RAP. 1993. Stage I Remedial Action Plan for the Rochester Embayment of Lake Ontario. Monroe County Department of Health. Rochester, NY.
- RAP. 1997. Stage II Remedial Action Plan for the Rochester Embayment of Lake Ontario. Monroe County Department of Health. Rochester, NY.
- Rutberg, A.T., R.E. Naugle, L.A. Thiele, and I.K.M. Liu. 2004. Effects of immunocontraception on a suburban population of white-tailed deer *Odocoileus virginianus*. *Biological Conservation* 116(2): 243-250.
- Schladweiler, J.L., and G.L. Storm. 1969. Den-use by mink. *J. Wildlife Management* 33(4): 1025-1026.
- Sidorovich, V., and D.W. Macdonald. 2001. Density dynamics and changes in habitat use by the European mink and other native mustelids in connection with the American mink expansion in Belarus. *Netherlands J. Zoology* 51(1): 107-126.
- Stevens, R.T., T.L. Ashwood, and J.M. Sleeman. 1997. Fall-early winter home ranges, movements, and den use of male mink, *Mustela vison*, in Eastern Tennessee. *Canadian Field-Naturalist* 111: 312-314.

- USDA Forest Service. 2005. Fire Effects Information System, Wildlife Species: *Mustela vison*. <http://www.fs.fed.us/database/feis/wildlife/mammal/muvi/all.html>
- Westera, M., P. Lavery, and G. Hyndes. 2003. Differences in recreationally targeted fishes between protected and fished areas of a coral reef marine park. *J. Experimental Marine Biology and Ecology* 294(2): 145-168.
- Yamaguchi, N., S. Rushton, D.W. Macdonald, and J.G. Kie. 2003. Habitat preferences of feral American mink in the Upper Thames." *J. Mammalogy* 84(4): 1356-1373.
- Yamaguchi, N., and D.W. Macdonald. 2003. The burden of co-occupancy: Intraspecific resource competition and spacing patterns in American mink, *Mustela vison*. *J. Mammalogy* 84(4): 1341-1355

## Tables

**Table 1.** MustelaVision camera sites characterized by regional and site descriptors.

MustelaVision Camera Site	Region	Regional Descriptors			Site Descriptors				
		AOC: In vs. Out	Lakeshore vs. Inland	Landscape	Cover	Habitat	Ledge	Tunnel	
Bogus Creek 2003	BBWMA	In	Lakeshore	Wetlands	Forest	Upland	No	No	
Bogus Creek 2004	BBWMA	In	Lakeshore	Wetlands	Forest	Upland	No	No	
Larkin Creek A 2003	BBWMA	In	Lakeshore	Wetlands	Forest	Mix	Yes	No	
Larkin Creek B 2004	BBWMA	In	Lakeshore	Wetlands	Forest	Mix	Yes	No	
Round Pond Creek 2003	BBWMA	In	Lakeshore	Wetlands	Brush	Mix	Yes	Yes	
Round Pond Creek 2004	BBWMA	In	Lakeshore	Wetlands	Brush	Mix	Yes	Yes	
Bill's Point 2003	BBWMA	In	Lakeshore	Wetlands	Cattails	Wetland	No	Yes	
Cranberry Pond Trib 2004	BBWMA	In	Lakeshore	Wetlands	Forest	Mix	No	Yes	
Black Creek/ Rte 19 2003	BLKCK	In	Inland	Mix	Forest	Upland	Yes	No	
Black Creek/ Rte 19 2004	BLKCK	In	Inland	Mix	Forest	Upland	Yes	No	
Black Creek/ W Sweden Rd 2003	BLKCK	In	Inland	Mix	Forest	Upland	Yes	No	
Black Creek Trib/ W Sweden Rd 2004	BLKCK	In	Inland	Mix	Brush	Upland	No	No	
Black Creek/ Mud City Rd 2003	BLKCK	In	Inland	Mix	Cattails	Wetland	Yes	No	
Black Creek/ Cole Rd 2004	BLKCK	In	Inland	Mix	Brush	Upland	Yes	No	
Black Creek Trib Sackett Rd 2003	BLKCK	In	Inland	Mix	Brush	Mix	No	No	
Black Creek Trib Sackett Rd 2004	BLKCK	In	Inland	Mix	Brush	Mix	No	No	
Rte 63 2003	INWR	Out	Inland	Wetlands	Cattails	Mix	No	No	
Rt 77 2003	INWR	Out	Inland	Wetlands	Cattails	Wetland	No	Yes	
Rt 77 2004	INWR	Out	Inland	Wetlands	Cattails	Wetland	No	Yes	
Cayuga Pool 2003	INWR	Out	Inland	Wetlands	Cattails	Wetland	No	No	
Cayuga Pool 2004	INWR	Out	Inland	Wetlands	Cattails	Wetland	No	No	
Sour Springs Road 2003	INWR	Out	Inland	Wetlands	Cattails	Wetland	Yes	Yes	
Sour Springs Road 2004	INWR	Out	Inland	Wetlands	Cattails	Wetland	Yes	Yes	
Feeder Road 2003	INWR	Out	Inland	Wetlands	Cattails	Mix	No	No	
Albion Rd 2003	INWR	Out	Inland	Wetlands	Cattails	Mix	No	Yes	
Albion Rd 2004	INWR	Out	Inland	Wetlands	Cattails	Mix	No	Yes	
Bald Eagle beaver den 2004	LOSPW	Out	Lakeshore	Mix	Brush	Mix	No	No	
Yanty Creek 2004	LOSPW	Out	Lakeshore	Mix	Brush	Mix	No	No	
Bald Eagle west bank 2004	LOSPW	Out	Lakeshore	Mix	Forest	Upland	No	No	
Yanty Culvert #2 2004	LOSPW	Out	Lakeshore	Mix	Cattails	Wetland	No	Yes	



**Table 2.** Results of analysis of variance (GLM) of mink Passage Rates by Regional Descriptors: AOC: In vs. Out; Inland vs. Lakeshore; and Landscape: Wetlands Complex vs. Mixed Habitat (Full MiniTab output in Appendix C). Bold indicates a significant difference. \*The significance of the results for Landscape make those power calculations irrelevant.

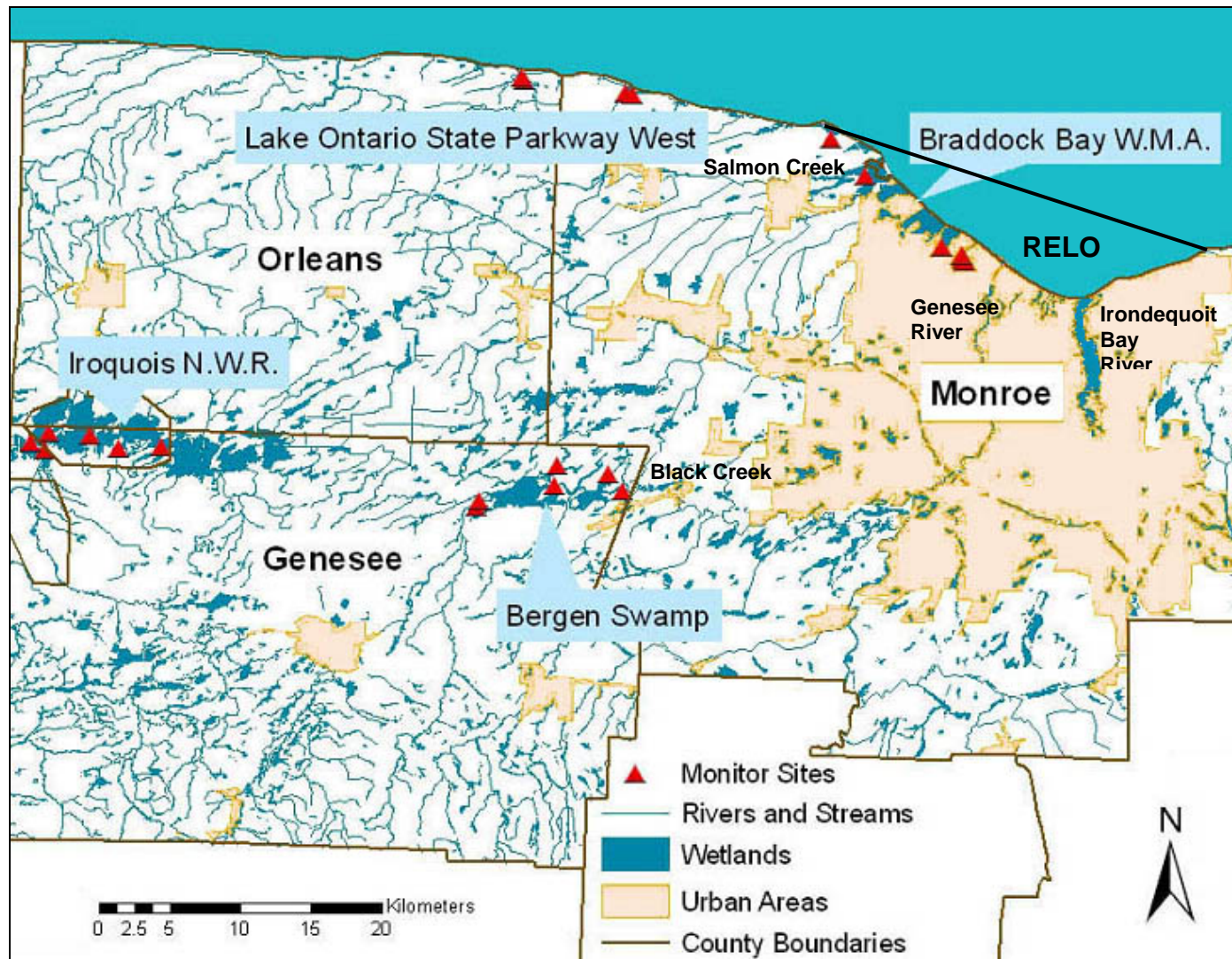
Regional Descriptor	PR Used	N	Mean (SE)	P-value	Power
AOC: In vs. Out					
	Max			0.404	0.254
AOC: In		16	0.0768 (0.0238)		
AOC: Out		13	0.1675 (0.0611)		
	Min			0.446	0.248
AOC: In		16	0.0399 (0.0130)		
AOC: Out		13	0.0859 (0.0339)		
Lakeshore vs. Inland					
	Max			0.251	0.096
Inland		17	0.1424 (0.0479)		
Lakeshore		12	0.0821 (0.0309)		
	Min			0.342	0.094
Inland		17	0.0720 (0.0266)		
Lakeshore		12	0.0443 (0.0168)		
Landscape: Wetlands vs. Mixed					
	Max			<b>0.026</b>	0.112*
Mixed Habitat		12	0.0352 (0.0106)		
Wetlands Complex		17	0.1755 (0.0479)		
	Min			<b>0.042</b>	0.112*
Mixed Habitat		12	0.0180 (0.0056)		
Wetlands Complex		17	0.0905 (0.0267)		

**Table 3.** Results of ANOVAs of mink Passage Rates by Site Descriptors: Cover, Habitat, Ledge, and Tunnel (Full MiniTab output in Appendix D). Bold indicates a significant difference.

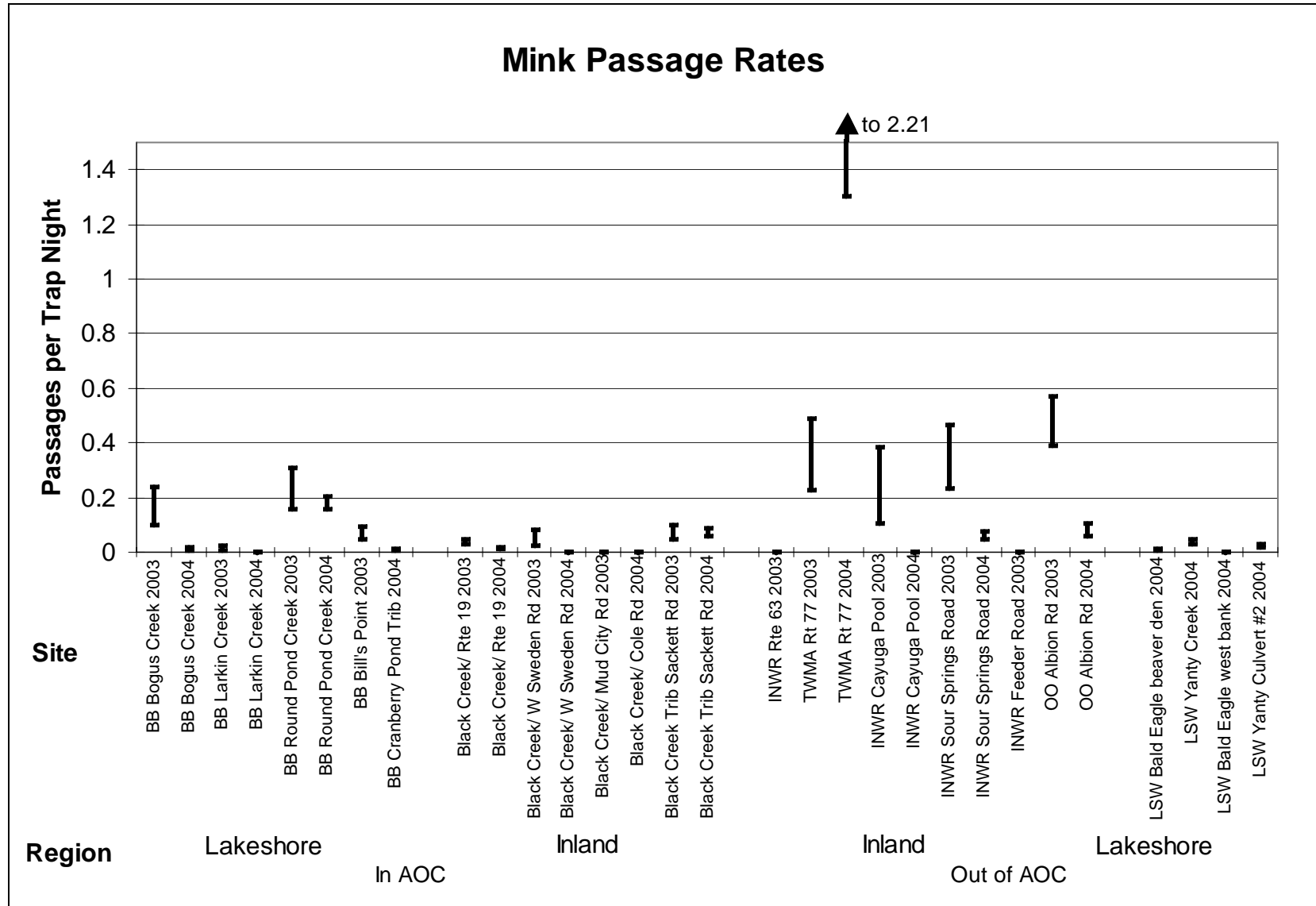
Site Descriptor	PR Used	N	Mean (SE)	P-value	Power
Cover	Max			0.166	0.268
Brush		8	0.0942 (0.0387)		
Cattails		12	0.1843 (0.0643)		
Forest		9	0.0490 (0.0255)		
	Min			0.193	0.259
Brush		8	0.0566 (0.0227)		
Cattails		12	0.0935 (0.0360)		
Forest		9	0.0200 (0.0100)		
Habitat	Max			0.245	0.279
Mix		13	0.1125 (0.0459)		
Upland		8	0.0512 (0.0289)		
Wetland		8	0.1918 (0.0757)		
	Min			0.341	0.197
Mix		13	0.0706 (0.0305)		
Upland		8	0.0204 (0.0115)		
Wetland		8	0.0842 (0.0337)		
Ledge	Max			0.872	0.052
Absent		18	0.1214 (0.0421)		
Present		11	0.1109 (0.0459)		
	Min			0.970	0.050
Absent		18	0.0610 (0.0235)		
Present		11	0.0597 (0.0244)		
Tunnel	Max			<b>0.004</b>	0.743
Absent		19	0.0557 (0.0227)		
Present		10	0.2348 (0.0658)		
	Min			<b>0.001</b>	0.874
Absent		19	0.0222 (0.0075)		
Present		10	0.1333 (0.0387)		

## Figures

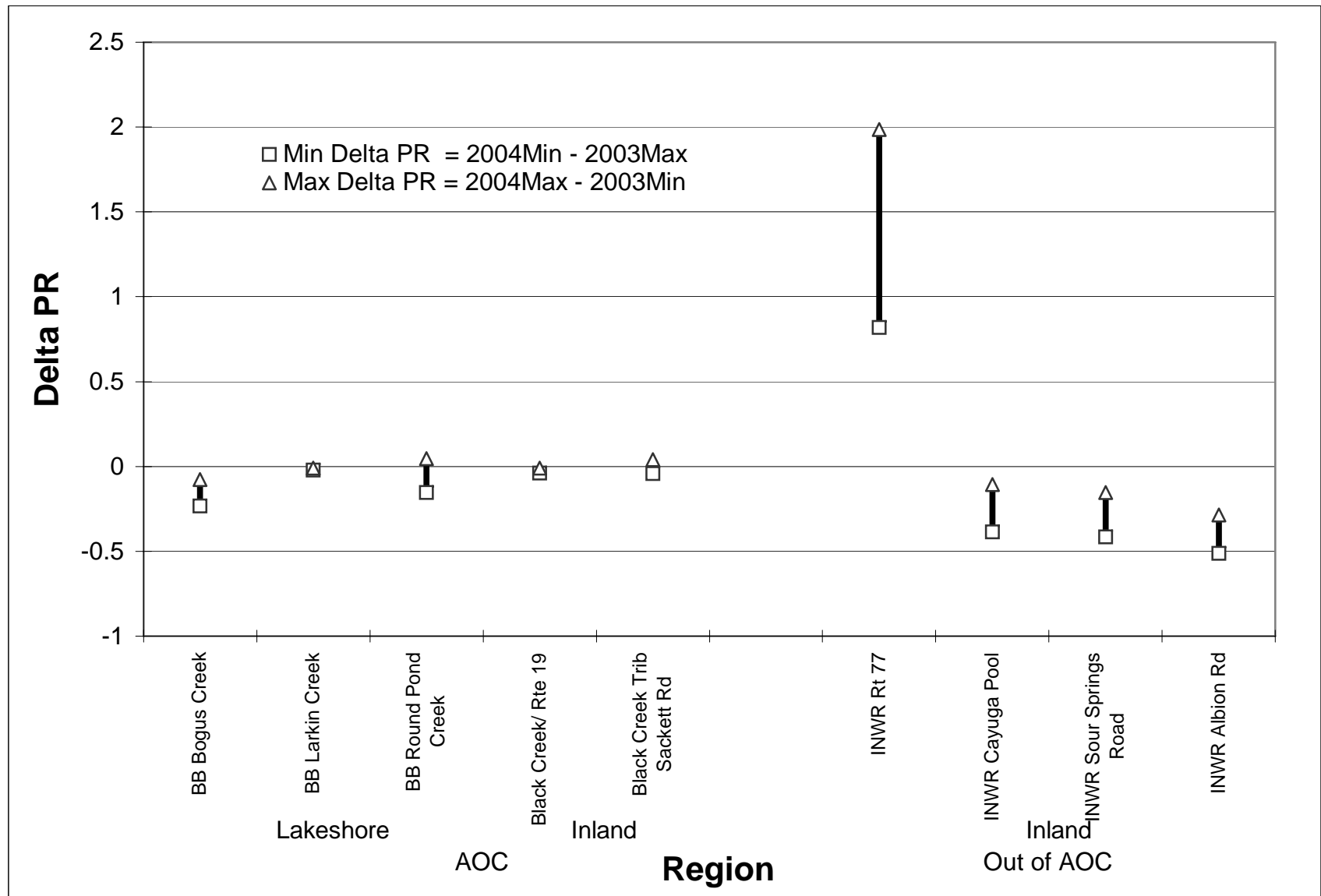
**Figure 1.** Map showing placement of MustelaVision systems in four regions during 2003 and 2004. Each red triangle is the site of one MV system. In LOSP West, there were actually four sites, but the triangle symbols are almost superimposed in pairs due to their proximity. RELO is the Rochester Embayment of Lake Ontario. (Map courtesy of Albert Fulton 2005.)



**Figure 2.** Mink Passage Rates calculated for each camera site during 2003 and 2004. The bars show the range between the Min and Max Passage Rates, based on the Max and Min number of Trap Nights, respectively, at each site. The sites are grouped by Region (In AOC vs. Out of AOC, and Inland vs. Lakeshore) labeled at the bottom. Data from both years at one site are shown side by side.



**Figure 3.** Yearly changes (Delta Passage Rates) in mink passages for sites at which data were taken both years. BB = Braddock Bay Wildlife Management Area, INWR = Iroquois National Wildlife Refuge.





## Appendices

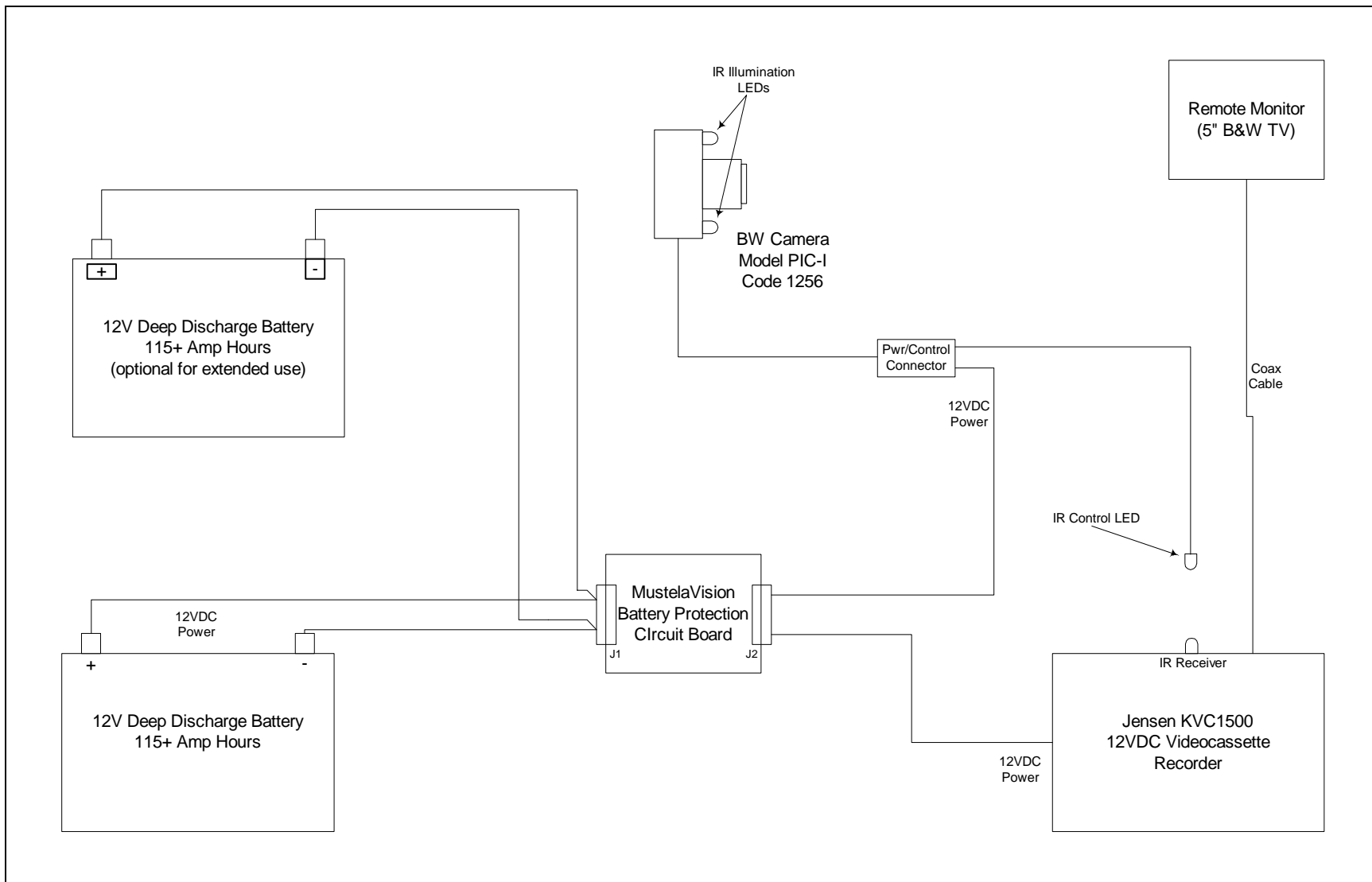
### Appendix A: MustelaVision Operations

#### Appendix A-1: MustelaVision System

**Figure A-1a.** MustelaVision system: camera head on stake at right, VCR on platform in front of battery, protective circuit board mounted underneath VCR platform.



**Figure A-1b.** Schematic of a MustelaVision system. The remote monitor is used only during field testing and camera alignment.

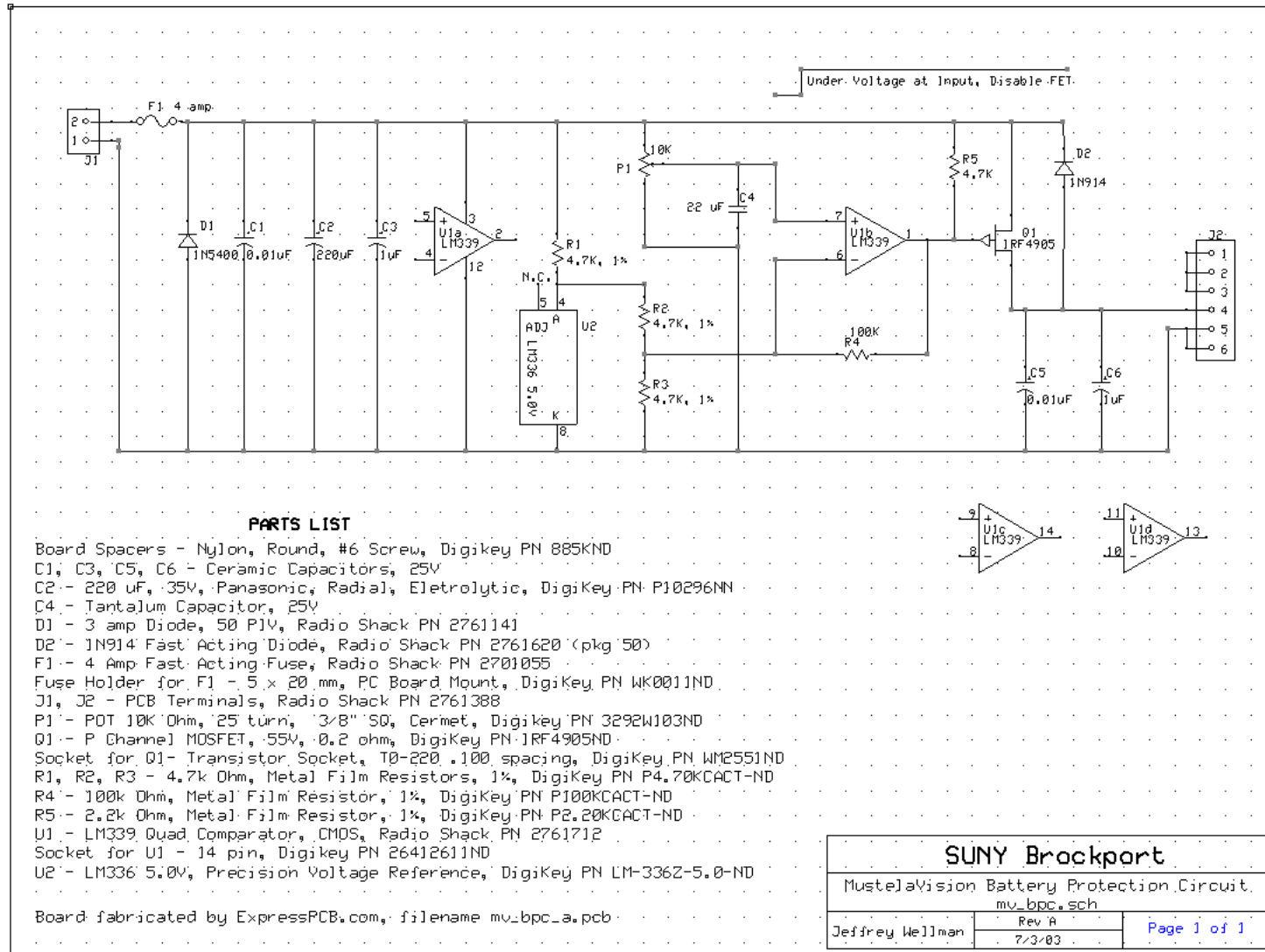


**Figure A-1c.** Back view of a MustelaVision camera head mounted on stake at the Round Pond Creek site in the BBWMA.





**Figure A-1d.** Battery protection circuit board, which protected against over discharge of battery, reversal of battery hook-up, and component fusing.



Appendix A-2: Data Record Sheets

Figure A-2a. Sample System Log. During each field service session, we recorded the date of service, the ID numbers of the videotape cassettes and batteries inserted, and any comments such as mink tracks observed, operational failures, or other pertinent information.

**MustelaVision  
System Log C**

Location (Creek/Road)	Tape #	Battery #	2003 Start Date	End Date	Tracks/Comments	# Mink Sights
RPC	5	1	6/14/03	6/21		0
	10	10	6/21	6/26		0
	20	2	6/26	7/2	mink tracks	1
	20	10	7/2	7/8		1
	39	23	7/8	7/14	battery down. VCR won't record, nil on tape 39	0
	14	3	7/14	7/20	did record (tape full of veg/wind)	0
	9	21	7/20	7/27		
	39	2	7/28	8/4	tracks: mink + weasel	2
	3	23	8/4	8/11		1
	15	12	8/11	8/18		0
	17	26	8/18	8/25		
	15	4	8/25	9/1		0
	18	26	9/1	9/8		1
	12	4	9/8	9/16		0
	3	12	9/16	9/23	weasel + small mink	1
6	26	9/23	10/1		0	
20	13	10/1	10/7		0	
12	14	10/7	10/14		1	
37	11	10/14	10/21		0	
15	13	10/21	10/27	pulled system	0	
2004			2004			
Sour Springs Rd	1	22	6/25	7/1		0
	8	28	7/1	7/8		1
	7	39	7/8	7/15		0
	39	1	7/15	7/22		0
	38	36	7/22	7/29		0
	16	47	7/29	8/5	Fuse blew	0
	18	37	8/5	8/12	Replaced fuse	?
	25	39	8/12	8/19		0
	19	66	8/19	8/26		0

System Log C

**Figure A-2b.** Sample Tape Log. The start and end dates for each session generated the Max Trap Nights (TN) for that session, and the day (D) and night (N) periods, recorded as they occurred in the video, yielded the Min TN for that session.

**MustelaVision  
Tape Log 36**

Location (Creek/Road)	System	2003 Date		Tape Counter		Trigger		Animal		
		Start	End	Session	Cue	Day	Night			
INWR Feeder Rd	H	7/7	7/13	19:				Heron		
Bojus C./LOSP	A	DD	NN	3:16:55		M1	1	Ducks		
								Heron		
								Spider		
								Carroons		
Tonawanda Rt 77	E	DDDDDD	NNNNN	1:42:	*	21:31	1	✓	Heron Iron woods (20+min)	08-14-03
					*	22:27	1	✓	Mink	" - B <sup>A</sup>
					*	26:26	1	✓	"Mink-Night-Tonawanda Rt 77	08-14-03
					*	27:57	1	✓	2 Minks 2 Minks-Night-Ton	77-08-14-03
					*	59:32	1	✓	Mink Mink-Day-Tonawanda Rt 77	08-15-03
INWR Sour Springs	G	DDDD	NNN	1:08:	*	7:40	1	✓	Ducks	
							1	✓	Mink Mink-INWR Sour Springs	08-26-03
							1	✓	Rail?	
							1	✓	Mink Mink-Tail-Night-INWR Sour Springs	08-28-03
							1	X	" Couldnt capture Ducks under attack INWR Sour Springs	08-28-03
			✓	Ducks being attacked	INWR-S-2	08-28-03				
			✓	Mink? (fur in LR corner)	Muskrat?					
Tonawanda Rt 77	E	DDDD	NNNN	29:	*	12:26	9/26	X	Weasel or Mink Mouse	
					*	13:31	9/27	✓	Mink-Tonawanda Rt 77-day-09-27-03	
					*	20:05	9/29	✓	Weasel	09-29-03
							1		Heron	

**Tape Log 36**

## Appendix B: Passage Rate Analyses (Delta PRs)

Table B-1. Mean Delta PRs

### One-Sample T: Dmin, Dmax

Test of mean Delta PR = 0 vs mean Delta PR not = 0

Variable	N	Mean	StDev	SE Mean
Dmin	9	0.159	0.693	0.231
Dmax	9	-0.109	0.392	0.131

Variable	95.0% CI	T	P
Dmin	( -0.374, 0.691)	0.69	0.511
Dmax	( -0.410, 0.192)	-0.83	0.428

Table B-2. Delta PRs: AOC: In (trapped for this study) vs. Out (trapped historically)

### Two-Sample T-Test and CI: Dmax, Area

Area	N	Mean	StDev	SE Mean
AOC	5	-0.0970	0.0919	0.041
Out	4	-0.124	0.630	0.32

Difference = mu (AOC) - mu (Out)

Estimate for difference: 0.027

95% CI for difference: (-0.984, 1.038)

T-Test of difference = 0 (vs not =): T-Value = 0.08 P-Value = 0.938 DF = 3

### Two-Sample T-Test and CI: Dmin, Area

Area	N	Mean	StDev	SE Mean
AOC	5	-0.0018	0.0497	0.022
Out	4	0.36	1.09	0.54

Difference = mu (AOC) - mu (Out)

Estimate for difference: -0.361

95% CI for difference: (-2.092, 1.369)

T-Test of difference = 0 (vs not =): T-Value = -0.66 P-Value = 0.554 DF = 3

## Appendix C: Regional Descriptor Analyses

### Appendix C-1. Descriptive Statistics: Regional Descriptors

*Table C-2a. Descriptive Statistics: AOC: In vs. Out*

		AOC:In						
Variable	vs. Out	N	N*	Mean	SE Mean	StDev	Minimum	Q1
Max	In	16	0	0.0768	0.0238	0.0950	0.00000	0.00281
	Out	13	0	0.1675	0.0611	0.2203	0.00000	0.00000
Min	In	16	0	0.0399	0.0130	0.0522	0.00000	0.00210
	Out	13	0	0.0859	0.0339	0.1222	0.00000	0.00000
Variable	AOC	Median	Q3	Maximum				
Max	In	0.0340	0.0960	0.3077				
	Out	0.0471	0.4249	0.5714				
Min	In	0.0147	0.0536	0.1552				
	Out	0.0317	0.1671	0.3902				

*Table C-2b. Descriptive Statistics: Inland vs. Lakeshore*

		Lakeshore						
Variable	vs.Inland	N	N*	Mean	SE Mean	StDev	Minimum	Q1
Max	Inland	17	0	0.1424	0.0479	0.1977	0.00000	0.0000
	Lakeshore	12	0	0.0821	0.0309	0.1069	0.00000	0.0116
Min	Inland	17	0	0.0720	0.0266	0.1097	0.00000	0.0000
	Lakeshore	12	0	0.0443	0.0168	0.0583	0.00000	0.00774
Variable	Lakeshore	Median	Q3	Maximum				
Max	Inland	0.0755	0.2449	0.5714				
	Lakeshore	0.0251	0.1751	0.3077				
Min	Inland	0.0290	0.0827	0.3902				
	Lakeshore	0.0119	0.0834	0.1552				

*Table C-2c. Descriptive Statistics: Landscape: Wetlands vs. Mix*

		Landscape						
Variable	Landscape	N	N*	Mean	SE Mean	StDev	Minimum	Q1
Max	Mix	12	0	0.0352	0.0106	0.0368	0.00000	0.00000
	Wetlands	17	0	0.1755	0.0479	0.1974	0.00000	0.00562
Min	Mix	12	0	0.01802	0.00557	0.01930	0.00000	0.00000
	Wetlands	17	0	0.0905	0.0267	0.1102	0.00000	0.00420
Variable	Landscape	Median	Q3	Maximum				
Max	Mix	0.0240	0.0744	0.0968				
	Wetlands	0.0938	0.3462	0.5714				
Min	Mix	0.01220	0.03106	0.05556				
	Wetlands	0.0494	0.1551	0.3902				

Appendix C-2: Main Effects Plots

Figure C-1a. Main effects plot showing effects of Regional Descriptors on Max PR.

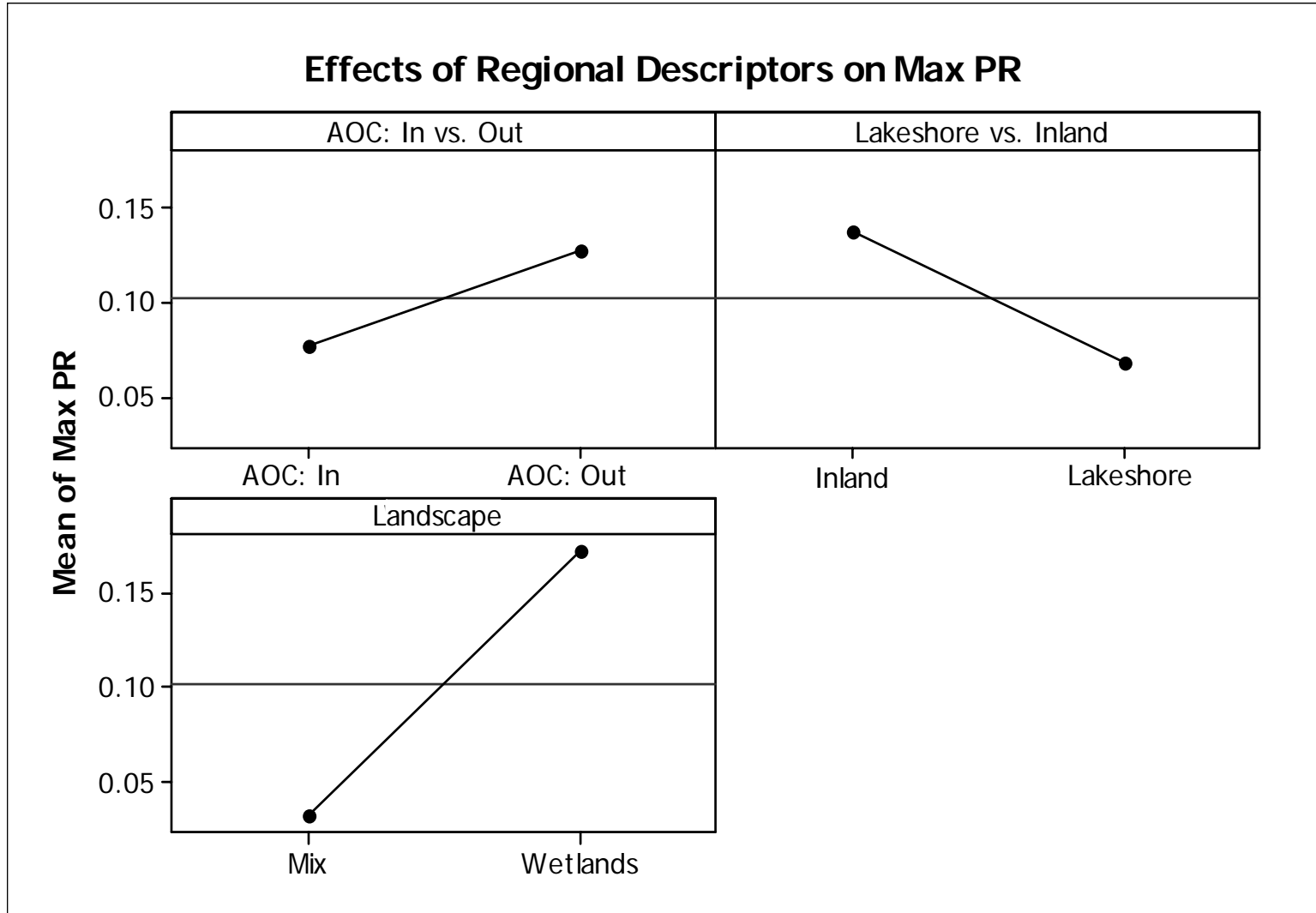
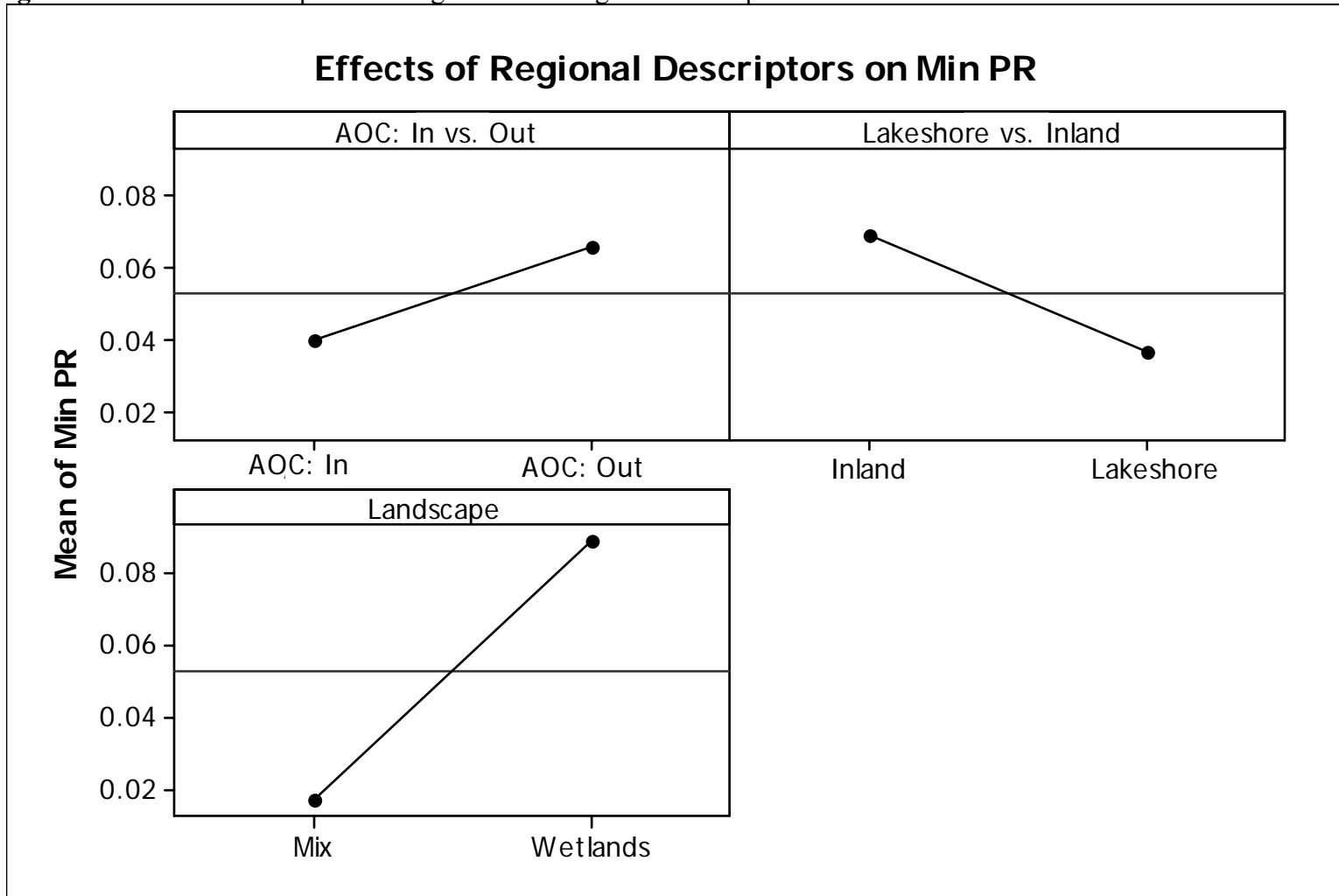


Figure C-1b. Main effects plot showing effects of Regional Descriptors on Min PR.



Appendix C-3. General Linear Model: Regional Descriptors

Table C-3. General Linear Model: Regional Descriptors

Factor	Type	Levels	Values
AOC	fixed	2	AOC, Out
Shore	fixed	2	Inland, Shore
Wetlands	fixed	2	Mix, Wetlands

***Analysis of Variance for Max, using Adjusted SS for Tests***

Source	DF	Seq SS	Adj SS	Adj MS	F	P
AOC	1	0.05893	0.01658	0.01658	0.72	0.404
Lakeshore	1	0.01323	0.03176	0.03176	1.38	0.251
Wetlands	1	0.12819	0.12819	0.12819	5.56	<b>0.026</b>
Error	25	0.57615	0.57615	0.02305		
Total	28	0.77651				

S = 0.151810    R-Sq = 25.80%    R-Sq(adj) = 16.90%

Unusual Observations for Max

Obs	Max	Fit	SE Fit	Residual	St Resid
24	0.571429	0.231957	0.050603	0.339472	2.37 R

R denotes an observation with a large standardized residual.

***Analysis of Variance for Min, using Adjusted SS for Tests***

Source	DF	Seq SS	Adj SS	Adj MS	F	P
AOC	1	0.015166	0.004399	0.004399	0.60	0.446
Shore	1	0.002547	0.006896	0.006896	0.94	0.342
Wetlands	1	0.033783	0.033783	0.033783	4.59	<b>0.042</b>
Error	25	0.183830	0.183830	0.007353		
Total	28	0.235325				

S = 0.0857507    R-Sq = 21.88%    R-Sq(adj) = 12.51%

Unusual Observations for Min

Obs	Min	Fit	SE Fit	Residual	St Resid
24	0.390244	0.117964	0.028584	0.272280	3.37 R

R denotes an observation with a large standardized residual.



## Appendix D: Site Descriptor Analyses

### Appendix D-1. Descriptive Statistics

*Table D-1a. Descriptive Statistics: Cover*

Variable	Cover	N	N*	Mean	SE Mean	StDev	Minimum	Q1
Max	Brush	8	0	0.0942	0.0387	0.1095	0.000000000	0.00313
	Cattails	12	0	0.1843	0.0643	0.2227	0.000000000	0.000000000
	Forest	9	0	0.0490	0.0255	0.0765	0.000000000	0.00562
Min	Brush	8	0	0.0566	0.0227	0.0643	0.000000000	0.00188
	Cattails	12	0	0.0935	0.0360	0.1248	0.000000000	0.000000000
	Forest	9	0	0.0200	0.0100	0.0300	0.000000000	0.00420

Variable	Cover	Median	Q3	Maximum
Max	Brush	0.0673	0.1759	0.3077
	Cattails	0.0846	0.4450	0.5714
	Forest	0.0196	0.0655	0.2407
Min	Brush	0.0397	0.1302	0.1552
	Cattails	0.0471	0.1969	0.3902
	Forest	0.00847	0.0247	0.0963

*Table D-1b. Descriptive Statistics: Habitat*

Variable	Habitat	N	N*	Mean	SE Mean	StDev	Minimum	Q1
Max	Mix	13	0	0.1125	0.0459	0.1655	0.000000000	0.00562
	Upland	8	0	0.0512	0.0289	0.0819	0.000000000	0.000000000
	Wetland	8	0	0.1918	0.0757	0.2142	0.000000000	0.00746
Min	Mix	13	0	0.0706	0.0305	0.1101	0.000000000	0.00376
	Upland	8	0	0.0204	0.0115	0.0324	0.000000000	0.000000000
	Wetland	8	0	0.0842	0.0337	0.0954	0.000000000	0.00385

Variable	Habitat	Median	Q3	Maximum
Max	Mix	0.0471	0.1538	0.5714
	Upland	0.0189	0.0744	0.2407
	Wetland	0.0846	0.4450	0.4857
Min	Mix	0.0317	0.1065	0.3902
	Upland	0.00871	0.0268	0.0963
	Wetland	0.0471	0.1969	0.2299

*Table D-1c. Descriptive Statistics: Ledge*

Variable	Ledge	N	N*	Mean	SE Mean	StDev	Minimum	Q1
Max	No	18	0	0.1214	0.0421	0.1788	0.000000000	0.000000000
	Yes	11	0	0.1109	0.0459	0.1524	0.000000000	0.000000000
Min	No	18	0	0.0610	0.0235	0.0999	0.000000000	0.000000000
	Yes	11	0	0.0597	0.0244	0.0810	0.000000000	0.000000000
Variable	Ledge	Median	Q3	Maximum				
Max	No	0.0385	0.1391	0.5714				
	Yes	0.0476	0.2022	0.4651				
Min	No	0.0236	0.0676	0.3902				
	Yes	0.0204	0.1550	0.2299				

*Table D-1d. Descriptive Statistics: Tunnel*

Variable	Tunnel	N	N*	Mean	SE Mean	StDev	Minimum	Q1
Max	No	19	0	0.0557	0.0227	0.0991	0.000000000	0.000000000
	Yes	10	0	0.2348	0.0658	0.2081	0.0112	0.0641
Min	No	19	0	0.02219	0.00753	0.03281	0.000000000	0.000000000
	Yes	10	0	0.1333	0.0387	0.1225	0.00847	0.0374
Variable	Tunnel	Median	Q3	Maximum				
Max	No	0.0182	0.0833	0.3846				
	Yes	0.1538	0.4703	0.5714				
Min	No	0.00840	0.03175	0.10753				
	Yes	0.1065	0.2275	0.3902				

Appendix D-2. One-Way ANOVAs: Site Descriptors

*Table D-2a. Cover*

**Factor Type Levels Values**  
**Cover fixed 3 Brush, Cattails, Forest**

**One-way ANOVA: Max versus Cover**

Source	DF	SS	MS	F	P
Cover	2	0.1000	0.0500	1.92	0.166
Error	26	0.6765	0.0260		
Total	28	0.7765			

S = 0.1613    R-Sq = 12.88%    R-Sq(adj) = 6.18%

**One-way ANOVA: Min versus Cover**

Source	DF	SS	MS	F	P
Cover	2	0.02794	0.01397	1.75	0.193
Error	26	0.20739	0.00798		
Total	28	0.23533			

S = 0.08931    R-Sq = 11.87%    R-Sq(adj) = 5.09%

*Table D-2b. Habitat*

**Factor Type Levels Values**  
**Habitat fixed 3 Mix, Upland, Wetland**

**One-way ANOVA: Max versus Habitat**

Source	DF	SS	MS	F	P
Habitat	2	0.0797	0.0398	1.49	0.245
Error	26	0.6968	0.0268		
Total	28	0.7765			

S = 0.1637    R-Sq = 10.26%    R-Sq(adj) = 3.36%

**One-way ANOVA: Min versus Habitat**

Source	DF	SS	MS	F	P
Habitat	2	0.01869	0.00935	1.12	0.341
Error	26	0.21663	0.00833		
Total	28	0.23533			

S = 0.09128    R-Sq = 7.94%    R-Sq(adj) = 0.86%

*Table D-2c. Ledge*

**Factor Type Levels Values**  
**Ledge fixed 2 No, Yes**

**One-way ANOVA: Max versus Shelf**

Source	DF	SS	MS	F	P
Shelf	1	0.0008	0.0008	0.03	0.872
Error	27	0.7758	0.0287		
Total	28	0.7765			

S = 0.1695 R-Sq = 0.10% R-Sq(adj) = 0.00%

**One-way ANOVA: Min versus Shelf**

Source	DF	SS	MS	F	P
Shelf	1	0.00001	0.00001	0.00	0.970
Error	27	0.23531	0.00872		
Total	28	0.23533			

S = 0.09336 R-Sq = 0.01% R-Sq(adj) = 0.00%

*Table D-2d. Tunnel*

**Factor Type Levels Values**  
**Tunnel fixed 2 No, Yes**

**One-way ANOVA: Max versus Tunnel**

Source	DF	SS	MS	F	P
Tunnel	1	0.2101	0.2101	10.02	<b>0.004</b>
Error	27	0.5664	0.0210		
Total	28	0.7765			

S = 0.1448 R-Sq = 27.06% R-Sq(adj) = 24.36%

**One-way ANOVA: Min versus Tunnel**

Source	DF	SS	MS	F	P
Tunnel	1	0.08089	0.08089	14.14	<b>0.001</b>
Error	27	0.15444	0.00572		
Total	28	0.23533			

S = 0.07563 R-Sq = 34.37% R-Sq(adj) = 31.94%

## Appendix 2

### Age, Size, and Stable Isotope Data of Mink Populations, and a Predictive Model of Bioaccumulation of Chemicals of Concern in the Rochester Embayment of Lake Ontario

Sara T. Wellman and James M. Haynes

Department of Environmental Science and Biology  
State University of New York  
College at Brockport  
350 New Campus Drive  
Brockport, NY 14420-2973

June 2006

#### OVERVIEW

This report is the second of four resulting from project C302399 funded by the New York Great Lakes Protection Fund in 2004 to address use impairments related to water quality identified in the Remedial Action Plan for the Rochester Embayment of Lake Ontario (RELO RAP). It deals with ages, sizes and trophic positions (stable isotope analysis) of mink (*Mustela vison*) in the study area, and provides a predictive model for exposure levels of mink to bioaccumulative chemicals of concern (BCCs). The previous report (Wellman and Haynes 2005) addressed the development and use of videocapture (MustelaVision) systems that established the presence and reproduction of mink in and out of the RELO RAP Area of Concern (AOC). Two more reports will be written in 2006: (1) levels of BCCs in mink tissues (Pagano and Haynes, in preparation), and (2) a literature review of the effects of BCCs on mink (Wellman, in preparation). Because mink are the most sensitive known species to BCCs, the results of this four-part project will determine whether delisting the fish and wildlife reproduction impairment for the RELO AOC can be recommended.

## TABLE OF CONTENTS

INTRODUCTION .....	56
MATERIALS AND METHODS.....	56
Specimen collection.....	57
Collection.....	57
Processing.....	57
Handling & Shipping .....	58
Isotope Analysis.....	58
Aging .....	58
Data Analysis.....	58
Modeling.....	59
RESULTS AND DISCUSSION .....	58
Mink Age, Length and Weight .....	59
Age vs. Regional Descriptors .....	60
Isotopes .....	61
Isotope Data vs. Age.....	61
Isotope Data vs. Regional Descriptors.....	61
Construction of Bioaccumulation Model.....	61
Calculation of Trophic Level.....	61
Calculation of Aquatic Portion of Diet.....	62
Modeling Exposure of Mink in the AOC to BCCs.....	63
SUMMARY .....	65
ACKNOWLEDGMENTS .....	65
LITERATURE CITED .....	65
TABLES	
Table 1. Table of Age versus Regional Descriptors.....	69
Table 2. Table of $\delta^{15}\text{N}$ versus Regional Descriptors .....	70
Table 3. Table of $\delta^{13}\text{C}$ versus Regional Descriptors.....	71
Table 4. Predicted daily exposure levels of mink in the AOC .....	72
FIGURES	
Figure 1. Map showing the four regions referred to in the study. ....	73
Figure 2. Ages of mink trapped. ....	73
Figure 3. Plot of individual mink ages in each region.....	73
Figure 4. Stable isotope values of carbon sources in a Lake Superior wetland.....	74
APPENDICES	
A. Mink age, length and weight relationships.....	76
B. Age versus Regional Descriptors .....	77
C. Isotope data versus Age. ....	81
D. Isotope Data versus Regional Descriptors .....	83

# Age, Size, and Stable Isotope Data of Mink Populations, and a Predictive Model of Bioaccumulation of Chemicals of Concern in the Rochester Embayment of Lake Ontario

## INTRODUCTION

In the 1980s, the binational (Canada, U.S.) International Joint Commission (IJC) began the process of creating and implementing remedial action plans (RAPs) in 43 contaminated areas of concern (AOCs) throughout the Great Lakes Basin. The IJC established 14 “use impairments” that could cause a local area to be “listed” as an AOC, including “degradation of fish and wildlife populations” and “bird or animal deformities or reproductive problems.” In the Rochester AOC, both uses were defined as impaired because “very few” mink were then being trapped or observed within 2 miles of the lake (RAP 1993, 1997). This study was part of a project (Haynes *et al.* 2002) to determine if populations of mink on the shore of the Rochester Embayment of Lake Ontario (RELO) are negatively impacted by bioaccumulative chemicals of concern (BCCs) and, if so, whether the BCCs are originating in the embayment watershed or elsewhere.

The RELO AOC includes the Embayment, a 35 square mile portion of Lake Ontario south of a line between Bogus Point in the town of Parma and Nine Mile Point in the town of Webster (both in Monroe County, New York); adjacent wetlands and bays; and the six mile reach of the Genesee River, from the Lower Falls to the mouth at Lake Ontario. The RAP also includes the subwatersheds of Salmon Creek, the Genesee River and Irondequoit Creek (RAP 1993, 1997; **Figure 1**).

The initial questions addressed by this portion of the study were: 1) Can stable isotope analysis be used to evaluate mink diets, at lakeshore and inland areas in and out of the AOC, in terms of trophic levels and terrestrial and aquatic food sources? 2) Can stable isotope results be used to construct a food web/bioaccumulation model for mink in the Rochester AOC to predict body burdens of BCCs in mink in relation to their diets?

Stable isotopes (SIs) of carbon and nitrogen are often used to evaluate trophic webs of ecosystems to give lifetime, integrated estimates of both trophic level and dietary sources for organisms. Both  $^{12}\text{C}$  and  $^{14}\text{N}$  have stable, heavier isotopes ( $^{13}\text{C}$  and  $^{15}\text{N}$ ) which occur naturally, and the heavier and lighter isotopes are differentially absorbed and metabolized by organisms. Usually the lighter isotopes are excreted preferentially, leading to a relative enrichment of the heavier isotopes in organisms relative to their environment or diet. These enrichments are measurable through mass spectrometry, and are reported in parts per thousand ( $\delta\text{‰}$ ) relative to a standard:

$$\delta X = [(R_{\text{sample}} - R_{\text{standard}}) / R_{\text{standard}}] \times 10^3$$

where  $X$  is  $^{13}\text{C}$  or  $^{15}\text{N}$  and  $R$  is the corresponding ratio  $^{13}\text{C}/^{12}\text{C}$  or  $^{15}\text{N}/^{14}\text{N}$ . The standard for carbon is PeeDee Belemnite (PDB) limestone, and the standard for nitrogen is atmospheric nitrogen (Fry 1991).

Selective excretion of  $^{14}\text{N}$  over  $^{15}\text{N}$  by animals results in an increase of approximately 3.4 $\text{‰}$  in the  $\delta^{15}\text{N}$  at each trophic level; thus,  $^{15}\text{N}$  analysis can determine the trophic level at which an animal feeds (Peterson and Fry 1987, Cabana and Rasmussen 1994). Carbon is also enriched between trophic levels, but at a much lower rate, between 0 and 1 $\text{‰}$ . Because freshwater algae have a much less negative  $\delta^{13}\text{C}$  than terrestrial plants (e.g., terrestrial leaves  $\delta^{13}\text{C} = -27$  to  $-31\text{‰}$  versus algae  $> -17\text{‰}$ ; Collier and Lyon 1991),  $^{13}\text{C}$  analysis can differentiate

between these as original sources of carbon in a diet, indicating whether the diet is primarily of aquatic or terrestrial origin.

Once trophic level and percent aquatic diet are known, the exposure level for each BCC can be calculated using a model adapted from Sample *et al.* (1996). The model takes into account the concentration of the BCC in the water, daily food and water ingestion rates, proportion of the diet originating from aquatic carbon sources, body weight of the animal, and bioaccumulation factors (BAF) for each BCC. The BAF is dependent upon the trophic level and the octanol-water partition coefficient of the compound (Sample *et al.* 1996).

Our approach was to conduct stable isotope analysis for  $^{13}\text{C}$  and  $^{15}\text{N}$  on tissues from the same mink collected for BCC analyses (Pagano and Haynes, in preparation). We tested the null hypotheses that there are no differences in stable isotope ratios ( $\delta^{13}\text{C}$  and  $\delta^{15}\text{N}$ ) among regions (AOC: In vs. Out, Lakeshore vs. Inland). We used our results for trophic level of prey in mink diets to model the bioaccumulation of selected BCCs in mink in the AOC for later comparison with the results of Pagano's and Haynes' (in preparation) study.

Because it was desirable to know the ages of the mink for the Pagano and Haynes study (in preparation), we had the minks' teeth aged and used those results to answer further questions, such as: How do body length and weight relate to ages of trapped mink? Do the ages of mink trapped vary in and out of the AOC and between lakeshore and inland areas? Do stable isotope values in mink vary with age?

## **MATERIALS AND METHODS**

### **Specimen collection, processing and handling**

#### **Collection**

Mink carcasses were collected from trappers (after skinning) in five areas. We divided the study area into four Regions: Inland/AOC, Lakeshore/AOC, Inland/Out of AOC, and Lakeshore/Out of AOC. Both Lakeshore regions were identical to those defined for the MustelaVision videocapture study (Wellman and Haynes 2005) — Lakeshore/AOC (Wetlands) was the Braddock Bay Wildlife Management Area (BBWMA), and Lakeshore/Out of AOC (Mixed) was the Lake Ontario State Parkway west of Route 19 (LOSPW). However, for this study Inland/AOC (Mixed) included any animals taken in the AOC watershed more than 5 km from the lakeshore, and Inland/Out of AOC included animals taken from the Tug Hill Plateau, as well as from the Iroquois National Wildlife Refuge area, to provide two presumably “clean” control areas. Thus, Inland/Out of AOC was the only region that included both Wetlands and Mixed habitats. For the purpose of analysis, we described each collection area using the Regional Descriptors AOC: In versus Out; Lakeshore versus Inland; and Landscape: Wetlands (large wetlands complex) versus Mixed Habitat.

Carcasses were put in plastic bags and frozen by the trappers as soon as possible. The trappers completed log sheets indicating the date and location of capture for each animal, as well as the trapper's name and contact information. Carcasses were assigned specimen numbers in the order in which they were collected, and the specimen number, date and location of capture were written on the plastic bags with a permanent marker.

#### **Processing**

We thawed the frozen mink carcasses overnight in a refrigerator before processing them. Because some trappers removed the tails when skinning the carcasses, we removed all other tails before weighing and measuring to obtain comparable measures of body weight and length. We



placed carcasses in hexane-rinsed aluminum pans or aluminum foil for resection, and all utensils used were rinsed with hexane before each use. We placed muscle tissue from the left thigh of each carcass into a hexane-rinsed glass specimen bottle, labeled with the specimen number and tissue type, and froze it. We extracted two canine teeth from each mink and placed them in similarly labeled specimen envelopes. We recorded the body weight, tail-less body length, and weight of each tissue sample (except teeth) on a separate sheet for each mink, along with its specimen number and collection record.

#### **Handling & Shipping**

We shipped the muscle tissue samples, frozen and packaged with dry ice, to Cornell University's Stable Isotope Laboratory (COIL). We let the teeth dry in their paper envelopes and shipped them to Matson's Laboratory (Milltown, MT) for aging.

#### **Isotope Analysis**

At COIL, stable isotope analyses for  $^{13}\text{C}$  and  $^{15}\text{N}$  were conducted using a continuous flow Elemental Analyzer (NC2500, CE Elantech, New Jersey) interfaced with an Isotope Ratio Mass Spectrometer (IRMS) (Delta Plus, Thermo Electron Corp., Germany). Strict quality control procedures included standards to: (1) test for instrument linearity and define instrument response for the determination of elemental composition, and (2) measure stability of precision and accuracy over the length of a run (Arthur Kasson, COIL, personal communication).

#### **Aging**

Matson's Laboratory aged the mink teeth using a standardized species- and tooth-specific cementum analysis. Mammalian teeth, like trees, show seasonal growth rings when properly stained (Matson 1981). Matson's assumed a birth date of April 1 for all mink, and reported ages in whole years only. We then calculated the additional partial year for each mink between April 1 and its capture date, and added that to Matson's result to obtain the age of each mink.

#### **Data Analysis**

We used Microsoft® Excel 2000 for data management and non-statistical calculations. For statistical analyses, we used Minitab™ Statistical Software Release 14.13 (2005). We conducted regression analyses to evaluate the relationships between age and both body length and weight. We computed descriptive statistics for age versus the Regional Descriptors (AOC: In vs. Out, Lakeshore vs. Inland, and Landscape: Wetland vs. Mixed Habitat) and then used Minitab's General Linear Model (GLM, a 2-way ANOVA with unbalanced cells, Tukey's pairwise comparisons) to analyze the relationships between age and the Regional Descriptors. We also estimated historical trapping pressure in each area based on our conversations with DEC employees and trappers, and assigned Trapping Pressure values as a covariate in the GLM. Trapping Pressures were: 1 = mink not previously targeted by trappers (Lakeshore/Out of AOC and Inland/AOC), 2 = mink trapped historically (Lakeshore/AOC and Inland/Out of AOC). We then conducted regression analyses for each isotope ( $\delta^{13}\text{C}$  and  $\delta\text{N}$ ) versus age, and finally computed descriptive statistics and GLMs for each isotope versus the Regional Descriptors.

We estimated the power of the GLMs using Minitab's 2-Level Factorial power calculator (Factors = 3, Corners = 4, Replicates = minimum number for any level of the factor of concern (Regional Descriptor or Trapping Pressure), Effects = the smallest differences between the means for each factor). Although this calculator is not designed for unbalanced cells, using the minimum number of replicates among treatments produced a conservatively low estimate of the actual power (Minitab support staff 2006, personal communication).

## Modeling

Trophic level is calculated by dividing the  $\delta^{15}\text{N}$  value of an organism by the change in  $\delta^{15}\text{N}$  per trophic level, usually 3.4‰ (Minigawa and Wada 1984, Vander Zanden and Rasmussen 1999, Doucett 1999). Calculating percent aquatic diet using  $\delta^{13}\text{C}$  requires 1) determining the  $\delta^{13}\text{C}$  value in tissue, 2) estimating the difference between the  $\delta^{13}\text{C}$  values in the tissue and in the diet, and 3) calculating the relative contributions of aquatic and terrestrial sources required to yield the estimated  $\delta^{13}\text{C}$  of the diet (DeNiro and Epstein 1978). COIL's analysis provided the data for step 1. Literature review provided appropriate estimated values for step 2. The equation for step 3, calculating the proportion of a diet (%<sub>A</sub>) originating from one of two dietary sources of carbon with different  $\delta^{13}\text{C}$  values, is

$$\%_A = \frac{\delta^{13}\text{C}_{\text{animal}} - \delta^{13}\text{C}_B - f \cdot x}{\delta^{13}\text{C}_A - \delta^{13}\text{C}_B} \times 100,$$

where  $\delta^{13}\text{C}_{\text{animal}}$  is the stable-isotope ratio in the animal,  $\delta^{13}\text{C}_A$  and  $\delta^{13}\text{C}_B$  are the stable-isotope ratios of the two carbon sources,  $f$  is the trophic fractionation between the animal and its diet, and  $x$  is the trophic position of the animal (adapted from Doucett 1999).

Once the trophic level and aquatic portion of an animal's diet are known, the animal's exposure to a BCC can be modeled knowing the concentration of the compound in ambient water. The equation to predict the daily exposure level of an animal to a BCC in water is

$$\text{Exp} = \frac{C_w [W + (F \times P_{\text{aq}} \times \text{BAF})]}{bw},$$

where Exp is the exposure from both food and water,  $C_w$  is the concentration of the BCC in the water,  $W$  and  $F$  are the daily water and food consumption rates in L/day and g/day, respectively,  $P_{\text{aq}}$  is the aquatic proportion of the diet, BAF is the bioaccumulation factor of the chemical of concern (based on the trophic level of the animal and the octanol-water coefficient  $k_{\text{ow}}$ , a measure of hydrophobicity of the compound), and  $bw$  is the body weight of the animal in grams (adapted from Sample *et al.* 1996).

## RESULTS AND DISCUSSION

### Mink Age, Length and Weight

Although we used 41 mink in this study, 12 were not aged due to damaged or lost teeth. The ages of the mink ranged from 0.60 to 4.75 years; 41% (12/29) of those aged were less than one year old, while only 2 mink (7%) were over 4 years old (Figures 2, 3). Eagle and Whitman (1997) stated that wild mink rarely live longer than 3 years, and cited a study (Adams and Chapman 1981) in which only one of 169 trapped mink had reached the age of four years. Mitchell (1961) reported almost complete turnover of a population in Montana within three years. In contrast, Aulerich *et al.* (1999) reported life spans of 7-11 years in ranch mink.

Neither body length ( $r = 0.007$ ,  $P = 0.655$ ) nor body weight ( $r = 0.019$ ,  $P = 0.476$ ) were correlated with the age of the mink trapped (Appendix A: Figures A1, 2), a result explained by earlier studies. Mitchell (1961) reported that juvenile females attained their adult weight by mid-August, and males sometime during their first winter. Dunstone (1993) reported that mink reach adult body size by about 10 months (their first breeding season) although males may continue to gain weight after the first year (and body weight may cycle with seasons). Aulerich *et al.* (1999) reported that mink reach 95% or more of their adult body length by 16 weeks of age (September).

Trapping season in the study area does not open until late November, except for the Tug Hill Plateau, where it opens in October (our contracted trapper for the Rochester Embayment also started in October with a special collector's permit). Thus, the mink should have been close to their adult weight by their first trapping season, and a correlation between weight and age would not be expected.

Females in our study averaged 32.6 ( $\pm$  1.0) cm body length and 456.8 ( $\pm$  42.0) g body weight, while mean male body length was 37.4 ( $\pm$  2.7) cm and mean body weight 781.5 ( $\pm$  26.8) g. These means are somewhat smaller than reported by Mitchell (1961) in Montana, where males averaged 1150 g and non-pregnant females 600 g. The average male body length and weight in our study were 15% and 71% greater, respectively, than the female means. Dunstone (1993) reported that males are typically about 75% heavier than females, and Aulerich *et al.* (1999) reported male body weights 68% and 85% higher than females of the same age.

### **Age vs. Regional Descriptors**

None of the Regional Descriptors (or their interactions) had any effect on the age of mink trapped (P-values ranged from 0.304 to 0.404; Table 1, also Appendix B: Table B2). However, in examining the ages of the mink from each area (Figure 3), and the descriptive statistics (Appendix B, Table B1), we noticed that the largest difference between the mean ages occurred for the Landscape descriptor and that none of the mink from the Iroquois National Wildlife Refuge (INWR, Inland/Out of AOC) area had reached one year of age (Appendix A, Figure A2). Also, seven of the eight mink older than three years were trapped in the Inland/AOC and Lakeshore/Out of AOC areas where, to our knowledge, mink had not previously been trapped. Despite the small sample size from INWR (only four of those five mink could be aged), we hypothesized that trapping pressure might have an effect on the ages of the mink trapped, and assigned the Trapping Pressure levels to each area, as described above, to enable further investigation.

The descriptive statistics (Appendix B, Table B1) indicated that Trapping Pressure did have an effect on the ages of mink trapped. In previously non-trapped areas (Lakeshore/Out of AOC and Inland/AOC) the mean age (and standard error) was 2.6 (0.37), the median 3.0, and the maximum 4.8 years. In trapped areas (Lakeshore/AOC, Inland/Out of AOC) the mean age was 1.4 (0.27), the median 0.8, and the maximum 3.6.

Having observed these differences, we used Trapping Pressure as a covariate in the GLM (Appendix B, Table B3), (which forced us to drop the Landscape Descriptor and the AOC X Lakeshore Interaction due to empty cells). The results were that the P-value for Trapping Pressure was 0.017, while the P-values for the Regional Descriptors rose to 0.634 or higher (Table 1). The low power levels (Table 1) calculated for AOC: In vs. Out and Lakeshore vs. Inland are due to the small differences between the means for each factor (0.4 and 0.3 years, respectively), which can be attributed to the length of the trapping season (0.2 years in western NY to 0.5 years on the Tug Hill Plateau and for our contracted trapper with his special permit). In contrast, the difference in ages between historically trapped and non-trapped mink was 1.3 years, significant especially when compared to the short (3-4 yr) life spans of wild mink.

Our conclusion that Trapping Pressure is a biologically significant factor in the ages of the mink trapped is supported by Eagle and Whitman (1997). They reported higher proportions of juveniles in heavily trapped populations than in untrapped populations and hypothesized that reproduction or juvenile survival may be suppressed in untrapped areas that may reach their carrying capacity for mink. Mitchell (1961) also found juvenile to adult female ratios higher in a

commercially trapped area than in a historically non-trapped area. Unfortunately, we have no way of knowing whether the trapped mink in heavily trapped areas truly represented the population structure, or whether older mink are more trap-wary and less likely to be caught and counted. In historically non-trapped areas, trap-wariness should not be a factor and the trapped mink might better represent the population structure.

The presence of mink less than one year old in each area implies reproduction in all areas. It is possible that the young of the year trapped in an area were recently dispersed newcomers, as Gerell (1970) reported one dispersing mink traveling 45 km and another averaging 800 m per day over 27 days. However, the MustelaVision study (Wellman and Haynes 2005) recorded family units in all areas except Lakeshore/Out of AOC, confirming reproduction in the AOC.

## **Isotopes**

### **Isotope Data vs. Age**

Although the P-value of 0.043 indicated a significant correlation between age and  $\delta^{15}\text{N}$ , the  $R^2$  of 0.144 is small enough to conclude that there is no real effect (Appendix C1). For example, Mink #58 (AOC: In/Inland/Mixed) had a high  $\delta^{15}\text{N}$  (14.85) but was only 0.87 years (10.4 months) old. Minigawa and Wada (1984) found no relationship between age and  $\delta^{15}\text{N}$  in marine mussels or in tilapia. Age also had no effect on  $\delta^{13}\text{C}$  ( $R^2 = 0.008$ ;  $P = 0.641$ ; Appendix C2). Our results were similar to, but the reverse of, Kiriluk *et al.*'s (1995) findings that the correlation between  $\delta^{15}\text{N}$  and age in lake trout was not significant, but  $\delta^{13}\text{C}$  and age were weakly correlated ( $r^2 = 0.22$ ,  $P = 0.0001$ ).

### **Isotope Data vs. Regional Descriptors**

Two Regional Descriptors, AOC: In vs. Out and Lakeshore vs. Inland, had significant effects on  $\delta^{15}\text{N}$  values of the mink (Table 2; also Appendix D2). Mink in the AOC had higher  $\delta^{15}\text{N}$  values than mink out of the AOC ( $P = 0.025$ ), and Lakeshore mink had higher  $\delta^{15}\text{N}$  values than Inland mink ( $P = 0.002$ ). Landscape had no effect ( $P = 0.613$ , power = 0.711). The highest mean  $\delta^{15}\text{N}$  of the four regions was found in the AOC (Lakeshore/Wetlands), where the mean  $\delta^{15}\text{N} = 13.2$  ‰ (SE = 0.5). The highest individual  $\delta^{15}\text{N}$  value (16.9 ‰, Mink #17) was also found in the Lakeshore/AOC area, while the lowest was found in the AOC/Inland area (9.2 ‰, Mink #24) (Appendix D1).

None of the Regional Descriptors had significant effect on the  $\delta^{13}\text{C}$  values of the mink studied (Table 3 and Appendix D2). The highest (most positive)  $\delta^{13}\text{C}$  value ( $-28.29$  ‰) was found in Mink #17 (Lakeshore/AOC) while the lowest ( $-19.89$  ‰) was Mink #5 (Inland/Out of AOC) (Appendix D2). The low power levels are due to the small differences between the means for each factor (Table 3).

## **Construction of Bioaccumulation Model**

### **Calculation of Trophic Level**

Using the  $\delta^{15}\text{N}$  value of 11.9 (grand mean of 41 mink in our study) and the commonly accepted value of 3.4‰  $\delta^{15}\text{N}$  per trophic level, the average trophic level of mink in our study was 3.50. If we use 3.5‰  $\delta^{15}\text{N}$  per trophic level, as reported by Cabana and Rasmussen (1994) for the Lake Ontario food web, the trophic level of our mink averaged 3.40. The higher mean  $\delta^{15}\text{N}$  of 13.2 for mink in Lakeshore/AOC resulted in higher values for the trophic level of those mink (3.87 or 3.76, using 3.4‰ or 3.5‰  $\delta^{15}\text{N}$  per trophic level, respectively). All of these values agree well with estimates found in the literature; USEPA (1995a) reported estimates for mink prey levels ranging from 2.5 to 2.9, which would imply the minks' trophic level to be 3.5 to 3.9.

For the purpose of the model, we chose 3.8 as the trophic level of mink, for several reasons. As the ultimate purpose of the project is to protect mink populations in the AOC, we wanted to represent the mink in the AOC at greatest risk, those along the lakeshore. We chose an intermediate value between those based on the two estimates of the change in  $\delta N$  per trophic level, because, although Cabana and Rasmussen (1994) studied Lake Ontario, they analyzed only the pelagic food web. Therefore, their estimate is not fully appropriate for the diet of mink that feed in the littoral zone of the lake, associated wetlands, or in streams.

The mean  $\delta^{15}N$  in mink from the Lakeshore was 1.5‰ higher than the mean from Inland areas. This represents almost one-half of a trophic level difference between Lakeshore and Inland mink. The mean  $\delta^{15}N$  for mink in the AOC was 1.1‰ higher than the mean out of the AOC, about one-third of a trophic level. If the Lakeshore minks' diet includes a higher proportion of aquatic-based prey, then inferring a higher trophic level for Lakeshore than Inland mink may be confounded by the fact that aquatic primary producers typically have  $\delta^{15}N$  values 1-3‰ higher than terrestrial values (Figure 4). However, the hypothesis that Lakeshore mink feed at a slightly higher trophic level than Inland mink is supported by BCC analysis of the mink tissues (James Pagano, SUNY Oswego, personal communication).

#### **Calculation of Aquatic Portion of Diet**

In reference to the three steps involved in calculating the aquatic portion of the diet of an animal using  $\delta^{13}C$ , the calculated mean  $\delta^{13}C$  in mink muscle tissue from the Lakeshore/AOC was -25 (Table 3). For step 2 of the calculation, since the mink tissue used was thigh muscle, we relied on DeNiro and Epstein's (1978) report that the  $\delta^{13}C$  of thigh muscle from mice fed two different diets was depleted (more negative) by  $1.9 \pm 0.5$  ‰ from the  $\delta^{13}C$  value of the diets. Adding this value (+1.9‰) to the  $\delta^{13}C$  value of the mink tissue (-25) yielded a value of -23.1‰  $\delta^{13}C$  for the diet of mink in BBWMA.

DeNiro and Epstein (1978) examined insects, nematodes, snails and mice, and found that  $\delta^{13}C$  values varied significantly between tissues of the same animal such that no single tissue truly represents the  $\delta^{13}C$  value of the whole animal. They also reported that  $\delta^{13}C$  values differ among conspecifics raised on different diets, but that differences between an animal and its diet are similar within a species regardless of diet. Thus, mouse  $\delta^{13}C$  values would not be applicable to mink, but since the  $^{13}C$  fractionation is due to metabolic processes that are similar in all mammals, herbivores and carnivores, our estimate for the  $^{13}C$  depletion from diet to thigh muscle should be satisfactory. Focken and Becker (1998) cautioned that the lipid content of tissue in their study had such a strong influence on  $\delta^{13}C$  ratios that the trophic shift was not constant among, or even within, species, and that within-species differences were sometimes higher than levels commonly assumed for trophic level shift. However, the mouse data was the best estimate we found.

We had several difficulties with step 3 of the calculation of the aquatic portion of the diet of mink. The formula,

$$\%_A = \frac{\delta^{13}C_{animal} - \delta^{13}C_B - f \cdot x}{\delta^{13}C_A - \delta^{13}C_B} \times 100,$$

works quite well if there are only two dietary sources of carbon with  $\delta^{13}C$  values separated by 5‰ to 10‰ (with sample sizes of 50 to 15, respectively; Doucett 1999). So, if the  $\delta^{13}C$  values of terrestrial and aquatic carbon sources in our study differed by at least 6‰, we should have had no problem in calculating the aquatic portion of the diet. For example, Balasse *et al.* (2005) were able to use the difference between terrestrial vegetation  $\delta C$  values (mean of -27 ‰) and seaweed

(ranging from  $-18.5$  to  $-13.1$ ‰) to determine that seaweed made a significant contribution to the diet of coastal sheep in Scotland.

The first problem was that wetlands have more than two sources of  $^{13}\text{C}$ , including phytoplankton,  $\text{C}_3$  vascular plants (terrestrial, emergent, floating-leaved, submersed), and epiphytic and filamentous algae. The second problem was variation within, and overlap among,  $\delta^{13}\text{C}$  values in these sources. Figure 4 shows  $\delta^{13}\text{C}$  and  $\delta^{15}\text{N}$  values of vegetation and algae in a wetland associated with Lake Superior, along with values for phytoplankton from Lake Superior (Keough *et al.* 1996). Fry (1991) reported that  $\delta^{13}\text{C}$  values for terrestrial plants range from  $-35$  to  $-25$ ‰, while algae range from  $-34$  to  $-18$ ‰. Other researchers (Peterson *et al.* 1985, France 1995, Albuquerque *et al.* 1997, Doucett 1999, Cloern *et al.* 2002, Choi *et al.* 2005) each reported different ranges of values for the sources mentioned above, with many of the ranges overlapping even in the same study. Peterson and Fry (1987) explained that the  $^{13}\text{C}$  content of freshwater organisms depends on the source of the dissolved  $\text{CO}_2$  in the water and upon the  $^{13}\text{C}$  fractionation by those organisms. Heaton (1999) reported that plant  $\delta^{13}\text{C}$  values were affected up to 2‰ by factors such as growing conditions (e.g., light, temperature, water and nutrient availability, air flow), variation between parts of the same plant, variation between individuals of the same species in the same location (genetic diversity, microhabitat, age), and seasonal or annual variations. DeNiro and Epstein (1978) noted that the  $\delta^{13}\text{C}$  values of a single plant species can vary 5‰ or more in a growing season, and Kiriluk *et al.* (1995) found that Lake Ontario net plankton  $\delta^{13}\text{C}$  values ranged from  $-33.10$  in May to  $-21.92$  in September 1992. Cloern *et al.* (2002) concluded that isotope studies to determine primary producers are confounded by overlap of the isotopic ratios of the primary producers and changes in the isotopic composition of plant matter as it degrades. They warned of the danger in applying isotopic data from one ecosystem to another, even in congeneric species. For these reasons, we reluctantly concluded that we could not use  $\delta^{13}\text{C}$  values of our mink to determine the aquatic portion of their diet without having also analyzed samples of the vegetation (and the minks' known prey species) in the AOC.

#### **Modeling Exposure of Mink in the AOC to BCCs**

Although we were unable to calculate the proportion of aquatic foods in the diet of the mink in our study, we found several estimates in the literature. Although most diet studies only report frequencies of occurrence of diet items in scats, digestive tracts, or dens (e.g., USEPA 1993 summarizes the results of 19 such studies), USEPA (1995a) points out that this is not a good representation of biomass assimilated by the mink. However, USEPA (1995b) cited a study by Alexander (1977) reporting that the aquatic portion of minks' diets was 75% to 90%, based on wet weight of stomach contents year-round. Sample and Suter (1999) averaged the results of five studies to conclude that the aquatic portion of minks' diet is 54.6%. (The standard deviation for that average was reported as  $\pm 0.21$ %, which seems in error, as the average included Alexander's 1977 study; it is much more likely that the standard deviation was 21%). USEPA (1995b) used both 90% and 50% to calculate Wildlife Values for DDT, Hg, 2,3,7,8-TCDD, and PCBs; therefore, we chose the same bounds on the aquatic portion of the diet of mink.

Other values needed for the model are the body weight of the animal (g), daily consumption rates of food (g/day) and water (L/day), the bioaccumulation factor (BAF) of the chemical of concern (which also requires knowing the  $k_{ow}$  of the compound), and the concentration of the BCC in the water. The mean body weight of females in our study was 456.8 ( $\pm 42.0$ ) g, while males averaged 781.5 ( $\pm 26.8$ ) g. Because we had six females and 35 males, we averaged the male and female means for a representative average body weight of 620 g. We then had to correct for the absence of tails and pelts on the mink, since we presumed that the body

weight in the model would have included these. The tails that we removed from mink averaged 1% of the body weight of the mink, and Aulerich *et al.* (1999) gives the weight of a mink skin as about 17% of the body weight. Those body weights from July through pelting would have included skin and tail, so taking the inverse of 0.82 gave us the multiplying factor of 1.22 to get from our tail-less, skinned carcasses to a whole body weight of about 760g.

Several sources give daily food and water consumption rates along with body weights of mink. Sample and Suter (1999) cited Bleavin and Aulerich's (1981) value of 137 g of food per day and estimated daily intakes of 0.099 L of water, using a model by Calder and Brown (1983), for mink averaging 970 g body weight. USEPA (1995b) estimated intakes of 177 g of food (using an allometric model by Nagy 1987) and 0.081 L water per day (using Calder and Brown's 1983 model) for mink with a body weight of 800 g. For captive adult males averaging 2200 g, Aulerich *et al.* (1999) reported that they drank 0.127 L/day and daily food consumption ranged from 147 g to 275 g, depending upon the caloric content of the food and the season. Since our largest mink weighed only 1111 g, and we wanted to make our model conservative (protective of the AOC mink) but not unrealistic, we discounted Aulerich's consumption rates as too high, and chose the larger of the remaining two values for daily food and water intakes. Thus, for our model, the daily food and water consumption rates were 177 g and 0.1 L (= 100g), respectively.

To demonstrate the model, we used several BCCs for which we could find literature values for the concentrations in Lake Ontario. We chose 2,3,7,8-TCDD (dioxin), with a relatively high  $k_{ow}$  of 6.53, and lindane, with a moderately low  $k_{ow}$  of 3.73, reasoning that compounds with  $k_{ow}$ s lower than lindane would have low potential for biomagnification. We also modeled benzo(a)pyrene, dieldrin, and mercury, for which Booty *et al.* (2005) reported  $k_{ow}$  values and Lake Ontario water concentrations; they also modeled the Lake Ontario concentration of TCDD. The concentration of lindane in Lake Ontario was 0.24 ng/L in 1992 (Williams *et al.* 2001, cited by Marvin *et al.* 2004). The  $k_{ow}$ s and BAFs were taken from Sample *et al.* (1996), who assumed that all fish consumed by mink are trophic level 3 (small fish). However, Melquist *et al.* 1981 reported mink feeding on kokanee (land-locked *Oncorhynchus nerka*) after their spawning, and we have reason to believe that mink feed on piscivorous salmonids in the AOC when they are available (Haynes and Pagano, in preparation). Still, the average trophic level of 3.8 for mink in BBWMA indicates that if salmonids (trophic level 4) do contribute a significant portion of the minks' diet, they are balanced by a comparable portion of level 2 aquatic prey. Thus, we used the BAF factors provided by Sample *et al.* (1996) for prey of trophic level 3, which is slightly higher (and thus more protective than) the prey from trophic level of 2.8 implied by our results.

When our results are incorporated into the equation for exposure, the equation becomes

$$Exp = \frac{C_w [100 g + (177 g \times P_{aq} \times BAF)]}{760 g}$$

Given  $C_w$  (the concentration of the BCC in the water),  $P_{aq}$  (the aquatic proportion of the diet), and BAF (the bioaccumulation factor of the chemical of concern at trophic level 3), the results of this model are the levels of BCCs to which mink in the AOC would be exposed daily. For example, if the concentration of dieldrin in water is 1.55E-9 ng/L, and a mink's diet consists of 50% aquatic prey, the mink will be exposed to 1.02E-5 ng/g body weight per day. A 760 g mink would thus be exposed to 7.8E-3 ng, or 7.8 picograms, of dieldrin per day. In contrast, if the dieldrin concentration in water is 3.4E-09 ng/L and the mink's diet is 90% aquatic, the same mink would ingest 3.1E-2 ng, or 31 picograms, of dieldrin per day (Table 4).

Confirmation of the model awaits the results of the Pagano's and Haynes' (in preparation) analyses of BCC concentrations in mink, and will require knowing BCC concentrations in Lake Ontario water. If the sample results (Pagano and Haynes, in preparation) and model results are comparable, the model can be expanded to apply to any BCC if the concentration in the ambient water is known, along with the  $k_{ow}$  and BAF of the compound (many of which are in Sample *et al.* 1996). Comparing the results of a validated model to NOAELs (No Observed Adverse Effect Levels) or LOAELs (Lowest Observed Adverse Effect Levels) for specific compounds in mink (Wellman, in preparation) is a preferable method to assess the risk to mink exposed to Lake Ontario or other waters in the AOC because it will require only measuring BCC concentrations in water, not sacrificing mink.

## SUMMARY

The first question addressed by this study was: Can stable isotope analysis be used to evaluate mink diets, at lakeshore and inland areas in and out of the AOC, in terms of trophic levels and terrestrial and aquatic food sources? Analysis of  $\delta^{15}N$  allowed us to determine that mink in the study area feed on prey at trophic level 2.5 (slightly higher along the lakeshore and in the AOC than elsewhere), with the highest level (2.8) in the Lakeshore/AOC area. We were unable to use  $\delta^{13}C$  values to determine % aquatic diet because we had no  $\delta^{13}C$  values for carbon sources in the AOC wetlands.

The second question addressed by this study was: Can stable isotope results be used to construct a food web/bioaccumulation model for mink in the Rochester AOC that can predict body burdens of BCCs in mink in relation to their diets? Using our trophic level calculation and literature values of 50% and 90% aquatic diet, we were able to create a food web bioaccumulation model to predict the exposure of mink in the AOC to BCCs, once the BCCs' concentrations in ambient water such as Lake Ontario or Braddock Bay are known. Validation of the model awaits the results of the analyses of mink tissues for BCCs (Pagano and Haynes, in preparation).

In addition, we found that the ages of mink trapped had no effect on either body weight or body length, as they were all near or at their adult size when they were trapped. The Regional Descriptors (AOC: In vs. Out, Lakeshore vs. Inland, Wetland vs. Mixed habitat) also had no effect on the ages of mink trapped. Mean ages of trapped mink were lower in historically trapped areas. Mink less than one year old were trapped in all areas, implying reproduction in all areas including the AOC. However, indications of reproduction of mink in the AOC are not sufficient to justify delisting the wildlife reproduction impairment for the Rochester Embayment. That determination will require the comparison of BCCs in mink tissues (Pagano and Haynes, in preparation) to the NOAELs and LOAELs of the BCCs in question (Wellman, in preparation).

## ACKNOWLEDGMENTS

We are very grateful to Randy Baase who for two winters spent many hours trapping mink in the worst weather, and who taught us much about mink. Thanks are also due to other trappers who contributed carcasses and taught us about mink: Matt Lochner, Dan Carroll, Dan Frey, Michael Ingham, Don Newcombe, Tom Raduns, William Schwartz, Jr., Fred Sinclair, and Chuck Tirrano; and to the landowners near the Bergen Swamp who allowed us to collect mink on their property: "Doc" Fink, Dick Sands, Mel Reber and Al Burkhart. We are grateful to Scott



Wells and Ross Abbett for dissecting the mink, and to Albert Fulton for creating Figure 1. We thank Art Kasson at COIL for doing the isotope analyses, and Matson's Lab for aging the mink teeth. Bob Gilliam of the InterLibrary Loan office of Drake Library was very helpful in acquiring requested literature. We are very grateful for Dr. Richard Aulerich's generous donation of a copy of the Handbook of Biological Data for Mink. The government personnel who graciously allowed us to work in their territories include NYS DEC: Dan Carroll, Dave Woodruff and Heidi Bogner Kennedy; NYS OPRHP: James Slusarczyk, and USFWS: Bob Lamoy and Paul Hess. Finally, we gratefully acknowledge grant C302399 from the New York State Great Lakes Protection Fund that made this study possible.

### LITERATURE CITED

- Albuquerque, A.L.S. and A.A. Mozeto. 1997. C:N:P ratios and stable carbon isotope compositions as indicators of organic matter sources in a riverine wetland system (Moji-Guaçu River, Sao Paulo-Brazil). *Wetlands* 17(1): 1-9.
- Aulerich, R.J., D.C. Powell, and S.J. Bursian. 1999. Handbook of Biological Data for Mink. Michigan State University. East Lansing, Michigan.
- Balasse, M., A. Tresset, K. Dobney, and S.H. Ambrose. 2005. The use of isotope ratios to test for seaweed eating in sheep. *Journal of Zoology* 266:283-291.
- Booty, W.G., O. Resler, and C. McCrimmon. 2005. Mass balance modelling of priority toxic chemicals within the Great Lakes toxic chemical decision support system: RateCon model results for Lake Ontario and Lake Erie. *Environmental Modelling & Software* 20:671-688.
- Cabana, G. and J. B. Rasmussen. 1994. Modelling food chain structure and contaminant bioaccumulation using stable nitrogen isotopes. *Nature* 372:255-257.
- Chittenden, M.E., Jr. 2002. Given a significance test, how large a sample size is large enough? *Fisheries* 27(8): 25-29.
- Choi, W.J., H.-M. Ro, S.X. Chang. 2005. Carbon isotope composition of *Phragmites australis* in a constructed saline wetland. *Aquatic Botany* 82: 27-38.
- Cloern, J.E., E.A. Canuel, and D. Harris. 2002. Stable carbon and nitrogen isotope composition of aquatic and terrestrial plants of the San Francisco Bay estuarine system. *Limnology and Oceanography* 47(3): 713-729.
- Collier, K.J. and G.L. Lyon. 1991. Trophic pathways and diet of blue duck (*Hymenolaimus malacorhynchos*) on Manganuiateao River; a stable carbon isotope study. *New Zealand Journal of Marine and Freshwater Research* 25(2):181-186.
- DeNiro, M.J. and S. Epstein. 1978. Influence of diet on the distribution of carbon isotopes in animals. *Geochemica et Cosmochemica Acta* 42: 495-506.
- Doucett, R.R. 1999. Food-web relationships in Catamaran Brook, New Brunswick, as revealed by stable-isotope analysis of carbon and nitrogen. Ph.D. Thesis, Biology. University of Waterloo. Waterloo, Ontario, Canada.
- Dunstone, N. (1993). The Mink. London, T & A D Poyser Ltd.
- Eagle, T. C. and J. S. Whitman. 1987. Mink. Pages 614-625 in M. Novak, J. A. Baker, M. E. Obbard, and B. Mallock, eds. Wild furbearer management and conservation in North America. Ontario Trappers Association and Ontario Ministry of Natural Resources

- Focken, U. and K. Becker. 1998. Metabolic fractionation of stable carbon isotopes: implications of different proximate compositions for studies of the aquatic food webs using  $\delta^{13}\text{C}$  data. *Oecologia* 115: 337-343.
- France, R.L. 1995. Differentiation between littoral and pelagic food webs in lakes using stable carbon isotopes. *Limnology and Oceanography* 40: 1310-1313.
- Fry, B. 1991. Stable isotope diagrams of freshwater food webs. *Ecology* 72(6): 2293-2297.
- Gerell, R. (1970). Home ranges and movements of the mink *Mustela vison* in southern Sweden. *Oikos* 21: 160-173.
- Haynes, J.M., Pagano, J.J., and Wellman, S.T. 2002. New York State Great Lakes Protection Fund Application for State Assistance—RAP Progress in the Rochester Embayment of Lake Ontario: Population Monitoring, and Levels of Bioaccumulative Chemicals of Concern in Mink, a Sentinel Species.
- Heaton, T.H.E. 1999. Spatial, species, and temporal variations in the  $^{13}\text{C}/^{12}\text{C}$  ratios of  $\text{C}_3$  plants: implications for palaeodiet studies. *Journal of Archaeological Science* 26: 637-649.
- Keough, J.R., M.E. Sierszen, and C.A. Hagley. 1996. Analysis of a Lake Superior coastal food web with stable isotope techniques. *Limnology and Oceanography* 41(1): 136-146.
- Kiriluk, R.M., M.R. Servos, D.M. Whittle, G. Cabana, and J.B. Rasmussen. 1995. Using ratios of stable nitrogen and carbon isotopes to characterize the biomagnification of DDE, mirex, and PCB in a Lake Ontario pelagic food web. *Canadian Journal of Fisheries and Aquatic Science* 52: 2660-2674.
- Marvin, C., S. Painter, D. Williams, V. Richardson, R. Rossmann, and P. Van Hoof. 2004. Spatial and temporal trends in surface water and sediment contamination in the Laurentian Great Lakes. *Environmental Pollution* 129: 131-144.
- Matson, G.M. 1981. Workbook for Cementum Analysis. Matson's Laboratory, LLC. Milltown, MT. [www.matsonslab.com](http://www.matsonslab.com).
- Melquist, W.E., J.S. Whitman and M.G. Hornocker. 1981. Resource partitioning and coexistence of sympatric mink and river otter populations. Pages 187-220 in J.A. Chapman and D. Pursley, eds. *Worldwide Furbearer Conference Proceedings*. Worldwide Furbearer Conference, Inc. Frostburg, MD.
- Minigawa, M. and E. Wada. 1984. Stepwise enrichment of  $^{15}\text{N}$  along food chains: Further evidence and the relation between  $\delta^{15}\text{N}$  and animal age. *Geochemica et Cosmochemica Acta* 48: 1135-1140.
- Mitchell, J.L. 1961. Mink movements and populations on a Montana river. *Journal of Wildlife Management* 25(1): 48-54.
- Peterson, B.J. and B. Fry. 1987. Stable isotopes in ecosystem studies. *Annual Review of Ecology and Systematics* 18: 293-320.
- Peterson, B.J., R.W. Howarth, and R.H. Garrett. 1985. Multiple stable isotopes used to trace the flow of organic matter in estuarine food webs. *Science* 227: 1361-1363.
- RAP. 1993. Stage I Remedial Action Plan for the Rochester Embayment of Lake Ontario. Monroe County Department of Health. Rochester, NY.
- RAP. 1997. Stage II Remedial Action Plan for the Rochester Embayment of Lake Ontario. Monroe County Department of Health. Rochester, NY.
- Sample, B.E., D.M. Opresko, and G.W. Suter II. 1996. Toxicological Benchmarks for Wildlife: 1996 Revision. Oak Ridge National Laboratory, Oak Ridge, TN.
- Sample, B.E. and G. W. Suter II. 1999. Ecological risk assessment in a large river-reservoir: 4. Piscivorous wildlife. *Environmental Toxicology and Chemistry* 18(4): 610-620.

- U.S. Environmental Protection Agency. 1993. Wildlife Exposure Factors Handbook: Appendix: Literature Review Database. Office of Research and Development, USEPA. Washington, D.C.
- U.S. Environmental Protection Agency. 1995a. Great Lakes Water Quality Initiative Technical Support Document for Wildlife Criteria. Office of Science and Technology, Office of Water, USEPA. Washington, D.C.
- U.S. Environmental Protection Agency. 1995b. Great Lakes Water Quality Criteria Documents for for the Protection of Wildlife. Office of Science and Technology, Office of Water, USEPA. Washington, D.C.
- Vander Zanden, M.J., and J.B. Rasmussen. 1999. Primary consumer  $\delta^{13}\text{C}$  and  $\delta^{15}\text{N}$  and the trophic position of aquatic consumers. *Ecology* 80(4):1395-1404.
- Wellman, S.T., and Haynes, J.M. 2005. Monitoring mink populations using video traps. Department of Environmental Science and Biology, State University of New York at Brockport. Brockport, N.Y.

## TABLES

**Table 1.** Table of Age versus Regional Descriptors. The General Linear Model (GLM) was run with and without Trapping Pressure (TP) as a covariate. With TP as a covariate, the Landscape Regional Descriptor was dropped due to empty cells. Significant effects are in bold. The power estimates are conservative, since Minitab’s power calculator is not built to deal with GLMs (see Methods). \*Power is not relevant since effect is significant (Chittenden 2002).

<b>Regional Descriptor</b>	<b>N</b>	<b>Mean Age (SE)</b>	<b>P-value w/o TP</b>	<b>P-value w/ TP</b>	<b>Power</b>
AOC: In vs. Out	29		0.404	0.660	0.171
AOC: In	15	2.2 (0.37)			
AOC: Out	14	1.8 (0.36)			
Lakeshore vs. Inland			0.386	0.634	0.074
Inland	17	1.9 (0.37)			
Lakeshore	12	2.2 (0.35)			
Landscape: Wetlands vs. Mixed			0.304	N/A	0.806
Mixed Habitat	19	2.4 (0.33)			
Wetlands Complex	10	1.2 (0.27)			
Trapping Pressure			N/A	<b>0.017</b>	*
None Previous	15	2.6 (0.37)			
Historically Trapped	14	1.4 (0.26)			

**Table 2.** Table of  $\delta^{15}\text{N}$  versus Regional Descriptors showing selected descriptive statistics, and the results of the GLM with estimated power. Significant effects are in bold. The power estimates are conservative, since Minitab's power calculator is not built to deal with GLMs (see Methods). \*Power is not relevant since the effect is significant (Chittenden 2002).

Area	N	Mean $\delta^{15}\text{N}$ (SE) (‰)	Min $\delta\text{N}$ (‰)	Max $\delta\text{N}$ (‰)
BBWMA	10	13.2 (0.54)	11.09	16.88
AOC : In/Inland	11	11.8 (0.48)	9.20	14.55
INWR	5	11.2 (0.18)	10.49	11.56
LOSPW	10	12.2 (0.42)	10.45	14.28
TUGHL	5	9.8 (0.12)	9.40	10.14
Entire Study	41	11.9 (0.23)	9.20	16.88
Regional Descriptor	N	Mean $\delta^{15}\text{N}$ (SE) (‰)	P-value	Power
AOC: In vs. Out	41		<b>0.025</b>	*
AOC: In	21	12.4 (0.4)		
AOC: Out	20	11.3 (0.3)		
Lakeshore vs. Inland			<b>0.002</b>	*
Inland	21	11.2 (0.3)		
Lakeshore	20	12.7 (0.3)		
Landscape: Wetlands vs. Mixed			0.613	0.711
Mixed Habitat	26	11.6 (0.3)		
Wetlands Complex	15	12.5 (0.4)		

**Table 3.** Table of  $\delta^{13}\text{C}$  versus Regional Descriptors showing selected descriptive statistics, and the results of the GLM with estimated power. The power estimates are conservative, since Minitab's power calculator is not built to deal with GLMs (see Methods).

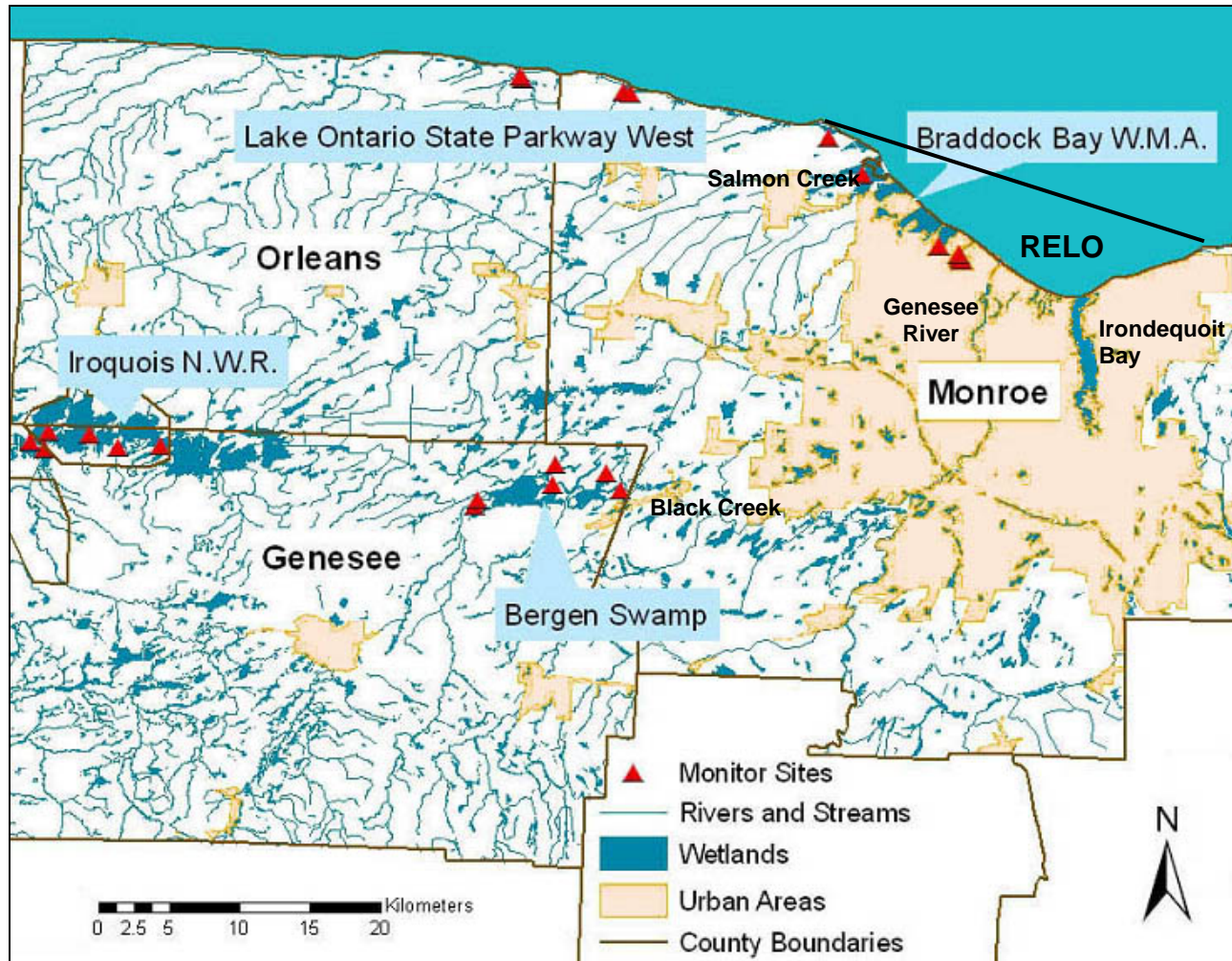
Area	N	Mean $\delta^{13}\text{C}$ (SE) (‰)	Min $\delta\text{C}$ (‰)	Max $\delta\text{C}$ (‰)
BBWMA	10	-25.0 (0.7)	-28.10	-19.98
AOC : In/Inland	11	-25.3 (0.2)	-26.56	-24.36
INWR	5	-25.7 (1.0)	-28.29	-23.14
LOSPW	10	-25.3 (0.4)	-27.03	-23.15
TUGHL	5	-26.2 (0.3)	-26.95	-25.31
Entire Study	41	-25.4 (1.5)	-28.29	-19.98
Regional Descriptor	N	Mean $\delta^{13}\text{C}$ (SE) (‰)	P-value	Power
AOC: In vs. Out	41		0.333	0.292
AOC: In	21	-25.1 (0.3)		
AOC: Out	20	-25.6 (0.3)		
Lakeshore vs. Inland			0.314	0.231
Inland	21	-25.6 (0.3)		
Lakeshore	20	-25.1 (0.4)		
Landscape: Wetlands vs. Mixed			0.963	0.091
Mixed Habitat	26	-25.5 (0.2)		
Wetlands Complex	15	-25.2 (0.6)		

**Table 4.** Predicted daily exposure levels of mink in the AOC, based on literature values for BCC concentrations in Lake Ontario. Observed values indicated by (o); estimated values by (e). BAF values are from Sample *et al.* (1996). Constants used: water intake = 0.1 L/day, food intake = 177 g/day, body weight of mink = 760 g. The concentration of 2,3,7,8-TCDD was estimated by Booty *et al.* (2005), as the compound was not detectable in their study. The concentrations for dieldrin and mercury are the minimum and maximum values observed by Booty *et al.* (2005), while the concentration for B(a)P is the maximum they observed (minimum was zero). The concentration of lindane was reported by Williams *et al.* (2001), cited by Marvin *et al.* (2004).

Compound	K(ow)	BAF: Prey Trophic Level 3	Concentration Cw (ng/L)	Daily Exposure (ng/g bw)	
				Diet 50% Aquatic	Diet 90% Aquatic
2,3,7,8-TCDD (e)	6.53	172100	1.8E-7	3.61E-03	6.49E-03
Benzo(a)pyrene (o)	6.11	293831	1.48E-09	5.06E-05	9.12E-05
Dieldrin (o)	5.37	56523	1.55E-09	1.02E-05	1.84E-05
		56523	3.40E-09	2.24E-05	4.03E-05
Lindane (o)	3.73	454	2.4E-10	1.27E-08	2.28E-08
Mercury (o)	N/A	27900	2.60E-09	8.45E-06	1.52E-05
		27900	2.50E-08	8.12E-05	1.46E-04

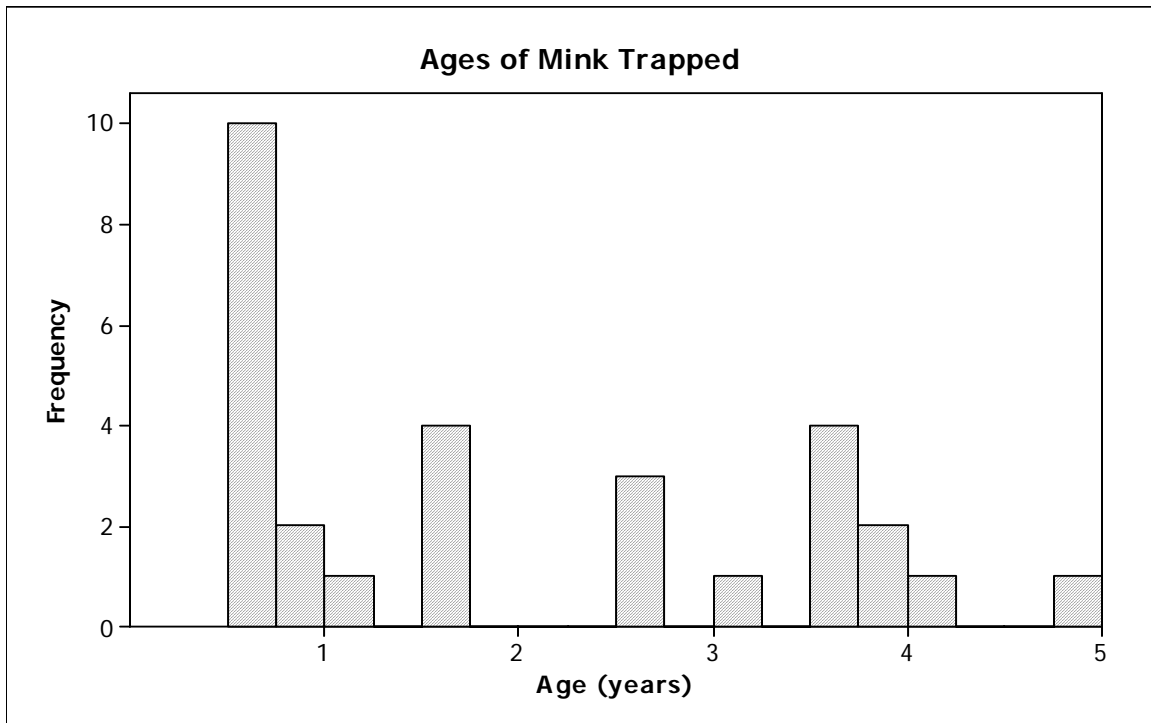
## FIGURES

**Figure 1.** Map showing the four regions referred to in the study. AOC/Lakeshore is Braddock Bay WMA, AOC/Inland is at least 3 km from Lake Ontario, Out of AOC/Lakeshore is the Lake Ontario State Parkway west of Rte.19, and Out of AOC/Inland is Iroquois NWR and the Tug Hill Plateau (not shown). RELO is the Rochester Embayment of Lake Ontario. (Map by Albert Fulton 2005.)

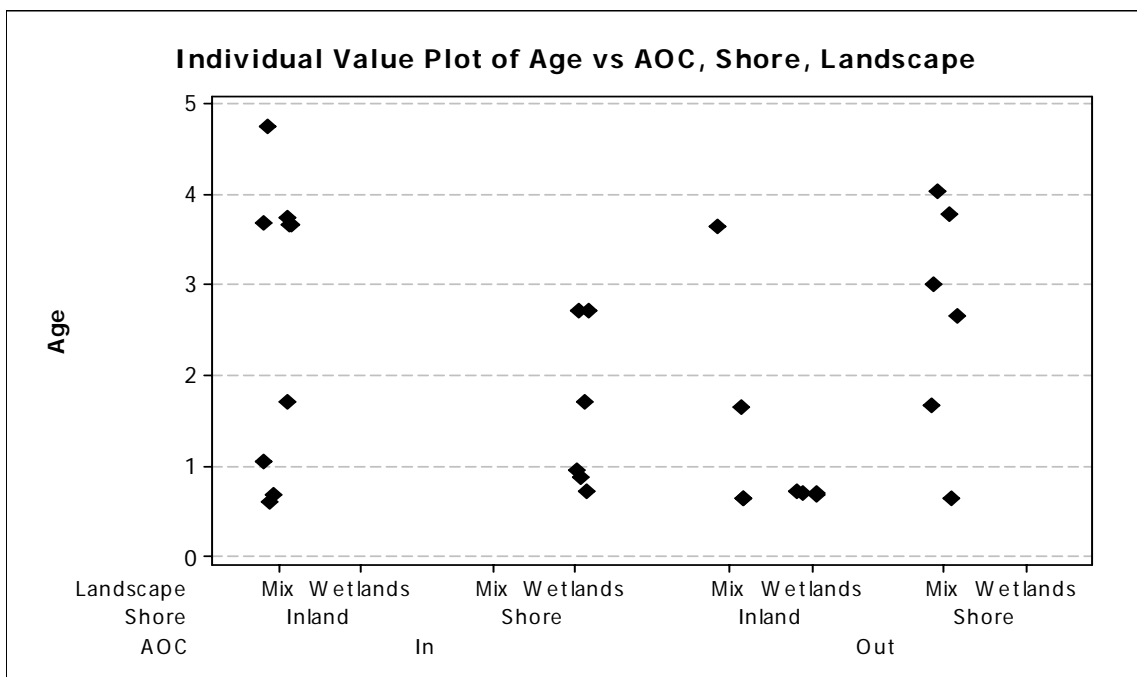




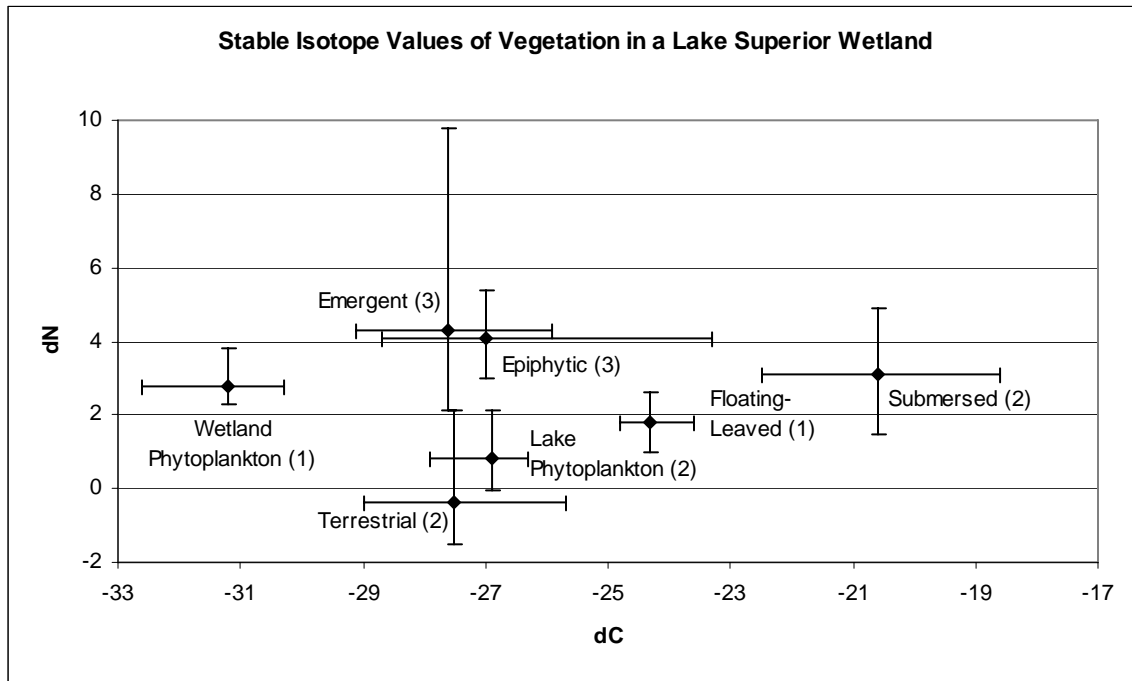
**Figure 2.** Ages of mink trapped.



**Figure 3.** Plot of individual mink ages in each region.



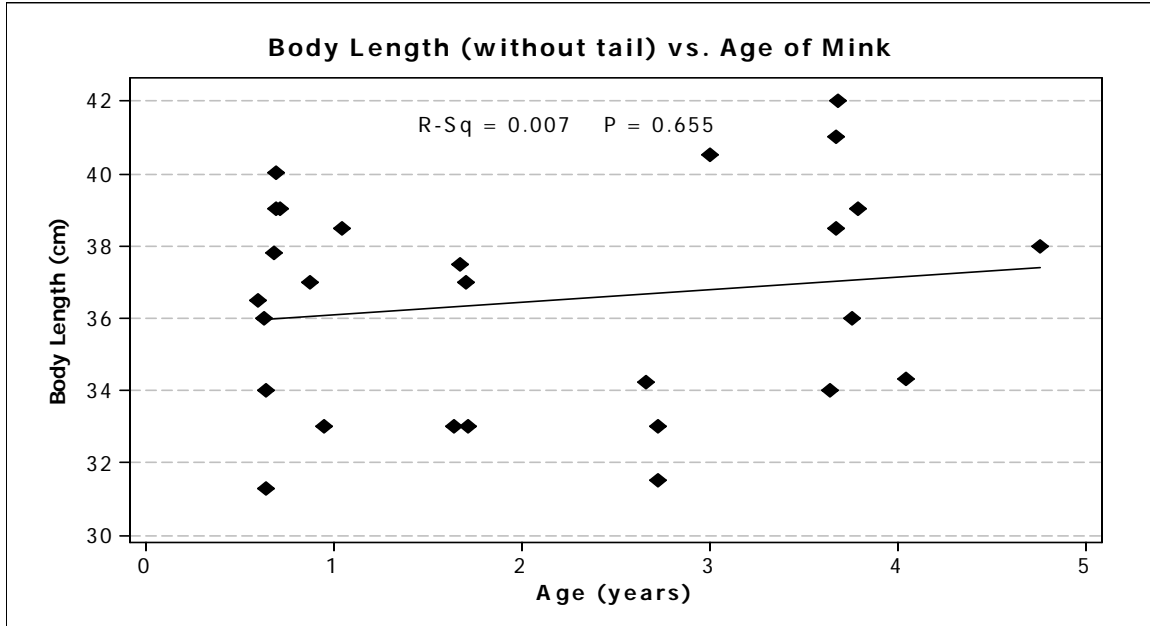
**Figure 4.** Stable isotope values of carbon sources in a Lake Superior wetland. (Constructed using values from Keough *et al.* 1996; numbers in parentheses are the number of species or types in each category).



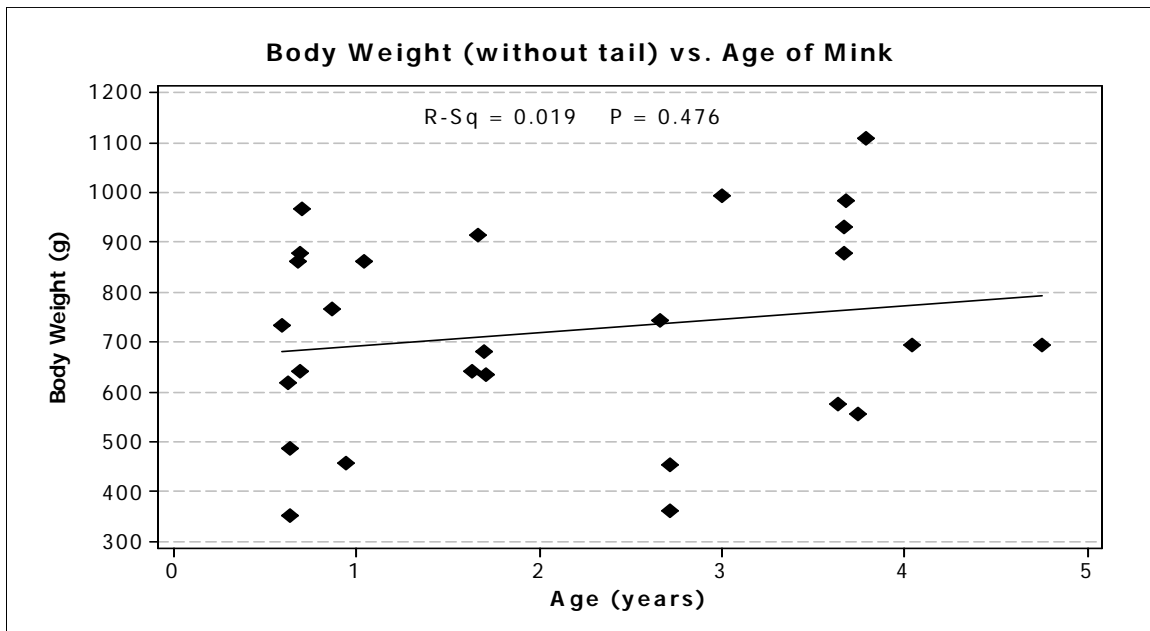
## APPENDICES

### Appendix A: Mink age, length and weight relationships.

**Figure A1:** Body length versus age of mink, showing no correlation ( $R^2 = 0.007$ ,  $P = 0.655$ ). Tails removed for consistency (see Methods).



**Figure A2.** Body weight versus age of mink, showing no correlation ( $R^2 = 0.019$ ,  $P = 0.476$ ). Tails removed for consistency (see Methods).



**Appendix B: Age versus Regional Descriptors**

**Table B1:** Descriptive statistics for Age versus Regional Descriptors

**Descriptive Statistics: AOC: In vs. Out, One-way ANOVA P = 0.442**

Variable	AOC	N	N*	Mean	SE Mean	StDev	Minimum	Q1	Median
Age	In	15	6	2.214	0.367	1.420	0.600	0.870	1.710
	Out	14	6	1.794	0.360	1.346	0.630	0.670	1.175

Variable	AOC	Q3	Maximum
Age	In	3.670	4.750
	Out	3.160	4.040

**Descriptive Statistics: Inland vs. Lakeshore, One-way ANOVA P = 0.722**

Variable	Shore	N	N*	Mean	SE Mean	StDev	Minimum	Q1	Median
Age	Inland	17	4	1.933	0.369	1.522	0.600	0.675	1.040
	Shore	12	8	2.123	0.346	1.197	0.630	0.890	2.185

Variable	Shore	Q3	Maximum
Age	Inland	3.670	4.750
	Shore	2.930	4.040

**Descriptive Statistics: Landscape: Wetlands vs. Mix, One-way ANOVA P = 0.027**

Variable	Landscape	N	N*	Mean	SE Mean	StDev	Minimum	Q1
Age	Mix	19	7	2.415	0.332	1.449	0.600	0.670
	Wetlands	10	5	1.245	0.265	0.837	0.680	0.690

Variable	Landscape	Median	Q3	Maximum
Age	Mix	2.660	3.680	4.750
	Wetlands	0.790	1.963	2.720

**Descriptive Statistics: Trapping History, One-way ANOVA P = 0.018**

Variable	Trap	N	N*	Mean	SE Mean	StDev	Minimum	Q1
Age	Pressure 0	15	6	2.621	0.370	1.433	0.600	1.040
	1	14	6	1.358	0.265	0.990	0.640	0.688

Variable	Trap	Median	Q3	Maximum
Age	Pressure 0	3.000	3.750	4.750
	1	0.790	1.963	3.640

**Table B2:** General Linear Model: Age versus AOC, Shore, Landscape (without Trapping Pressure as a covariate)

Factor	Type	Levels	Values
AOC	fixed	2	AOC: In, AOC: Out
Lakeshore	fixed	2	Inland, Lakeshore
Landscape	fixed	2	Mix, Wetlands

***Analysis of Variance for Age, using adjusted SS for Tests***

Source	DF	Seq SS	Adj SS	Adj MS	F	P
AOC	1	1.276	1.176	1.176	0.72	0.404
Lakeshore	1	0.287	1.267	1.267	0.78	0.386
AOC*Lakeshore	1	10.684	0.645	0.645	0.40	0.535
Landscape	1	1.796	1.796	1.796	1.10	0.304
Error	24	39.029	39.029	1.626		
Total	28	53.071				

S = 1.27522    R-Sq = 26.46%    R-Sq(adj) = 14.20%

**Figure B2a:** Main effects plot.

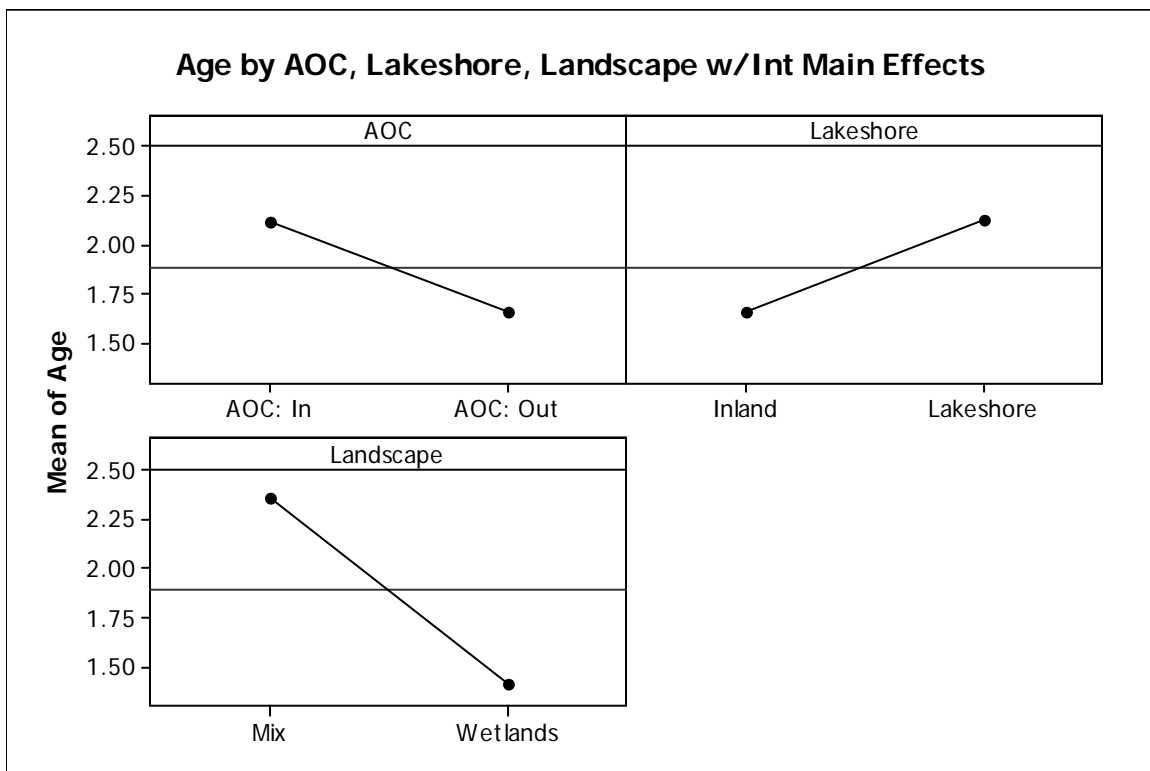
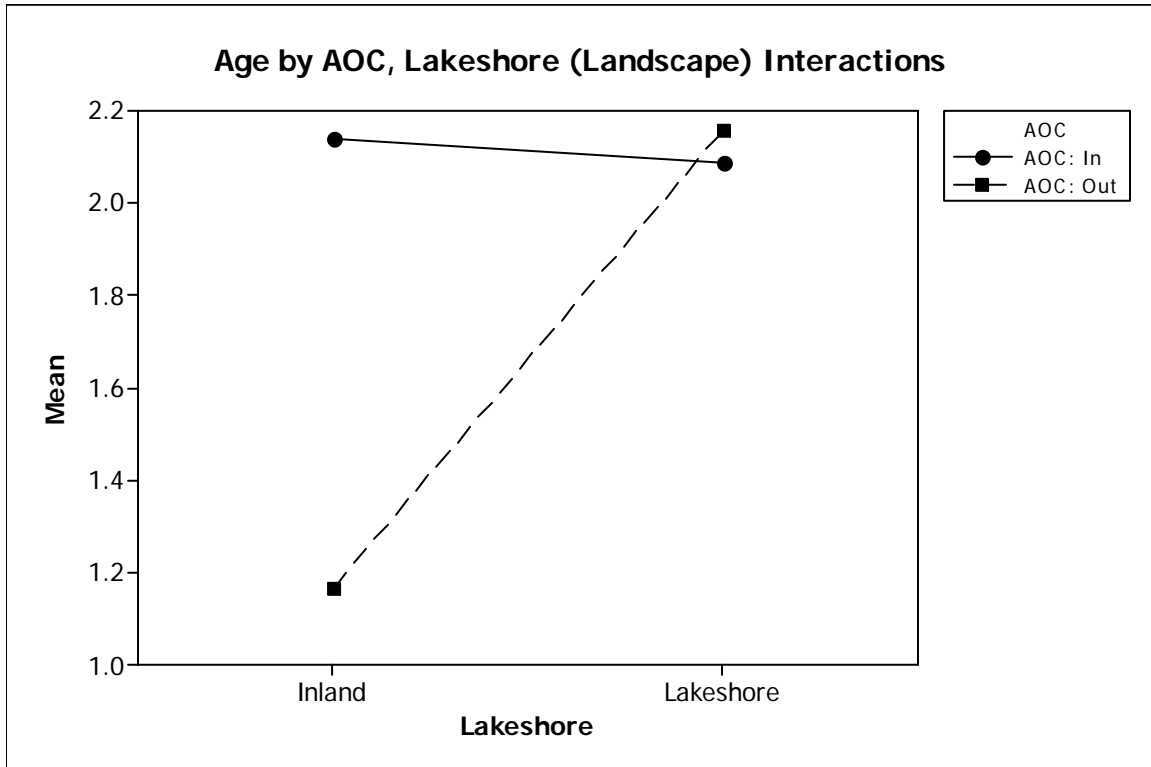


Figure B2b: Interactions plot.



**Table B3:** General Linear Model: Age versus AOC, Lakeshore with Trapping Pressure as covariate.

Factor	Type	Levels	Values
AOC	fixed	2	AOC: In, AOC: Out
Lakeshore	fixed	2	Inland, Lakeshore

***Analysis of Variance for Age, using Adjusted SS for Tests***

Source	DF	Seq SS	Adj SS	Adj MS	F	P
Trapping	1	11.560	10.684	10.684	6.54	0.017
AOC	1	0.308	0.324	0.324	0.20	0.660
Lakeshore	1	0.379	0.379	0.379	0.23	0.634
Error	25	40.824	40.824	1.633		
Total	28	53.071				

S = 1.27788    R-Sq = 23.08%    R-Sq(adj) = 13.84%

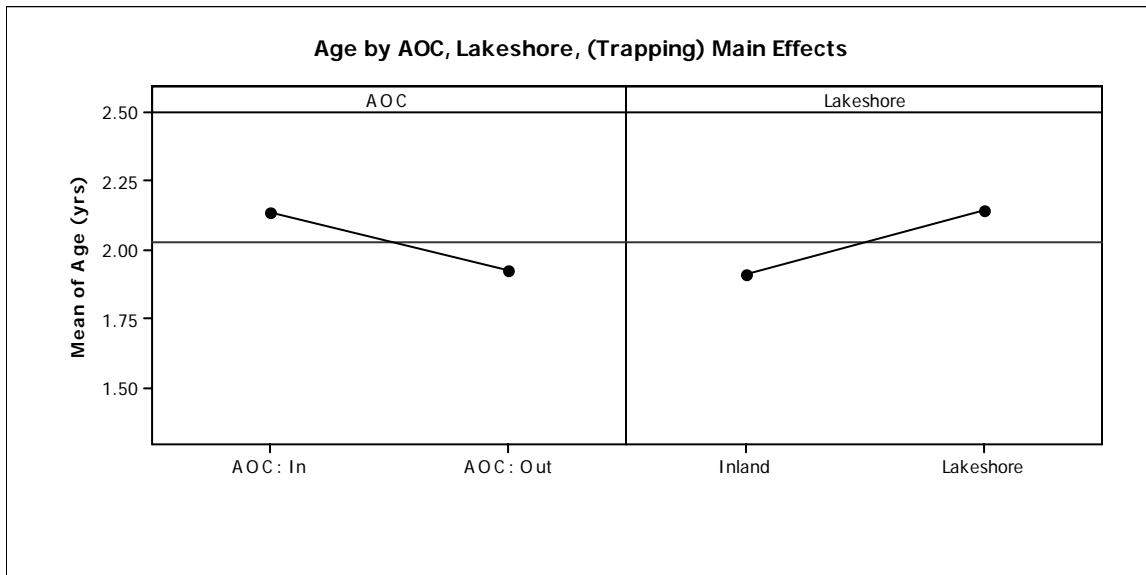
Term	Coef	SE Coef	T	P
Constant	3.8563	0.7568	5.10	0.000
Trapping	-1.2333	0.4822	-2.56	0.017

Unusual Observations for Age

Obs	Age	Fit	SE Fit	Residual	St Resid
15	3.64000	1.16625	0.45180	2.47375	2.07 R

R denotes an observation with a large standardized residual.

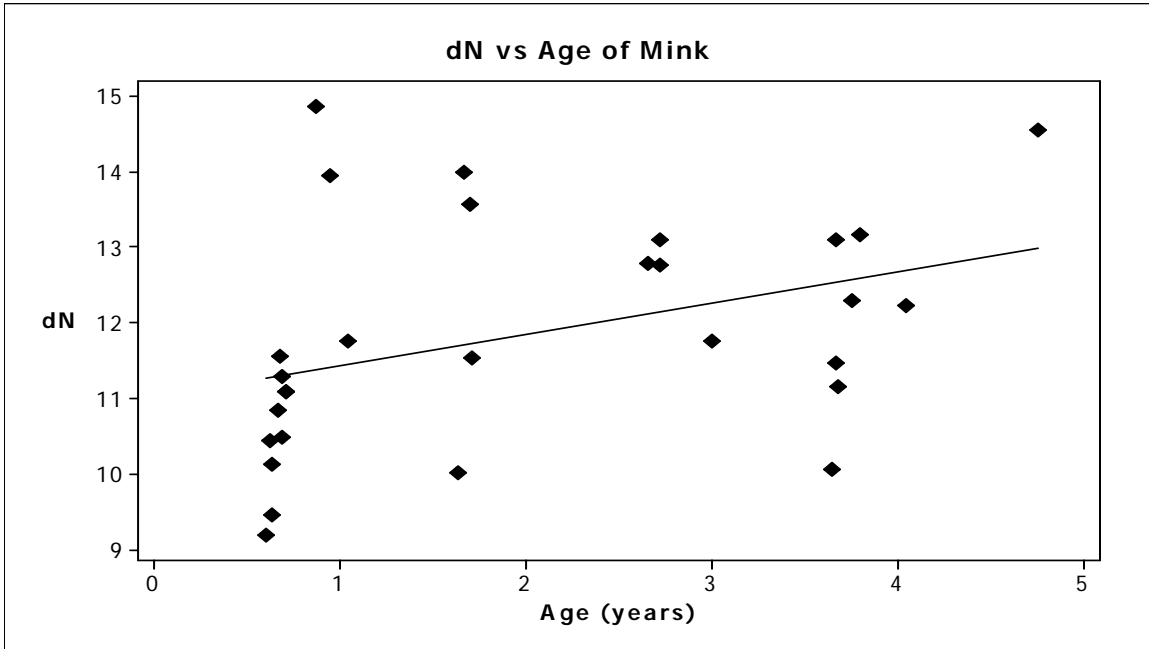
**Figure B3a:** Main effects plot.



**Appendix C: Isotope data versus Age.**

**Appendix C1:  $\delta^{15}\text{N}$  versus Age.**

**Figure C1.** Scatterplot of  $\delta^{15}\text{N}$  versus Age showing very weak correlation ( $R^2 = 0.144$ ,  $P = 0.043$ ).



**Table C1.** Regression analysis:  $\delta^{15}\text{N}$  versus Age (29 mink)

The regression equation is

$$\delta^{15}\text{N} = 11.0 + 0.417 \text{ Age}$$

29 cases used, 12 cases contain missing values

Predictor	Coef	SE Coef	T	P
Constant	11.0110	0.4752	23.17	0.000
Age	0.4173	0.1960	2.13	0.043

S = 1.42811 R-Sq = 14.4% R-Sq(adj) = 11.2%

<u>Analysis of Variance</u>					
Source	DF	SS	MS	F	P
Regression	1	9.241	9.241	4.53	0.043
Residual Error	27	55.066	2.039		
Total	28	64.307			

Unusual Observations

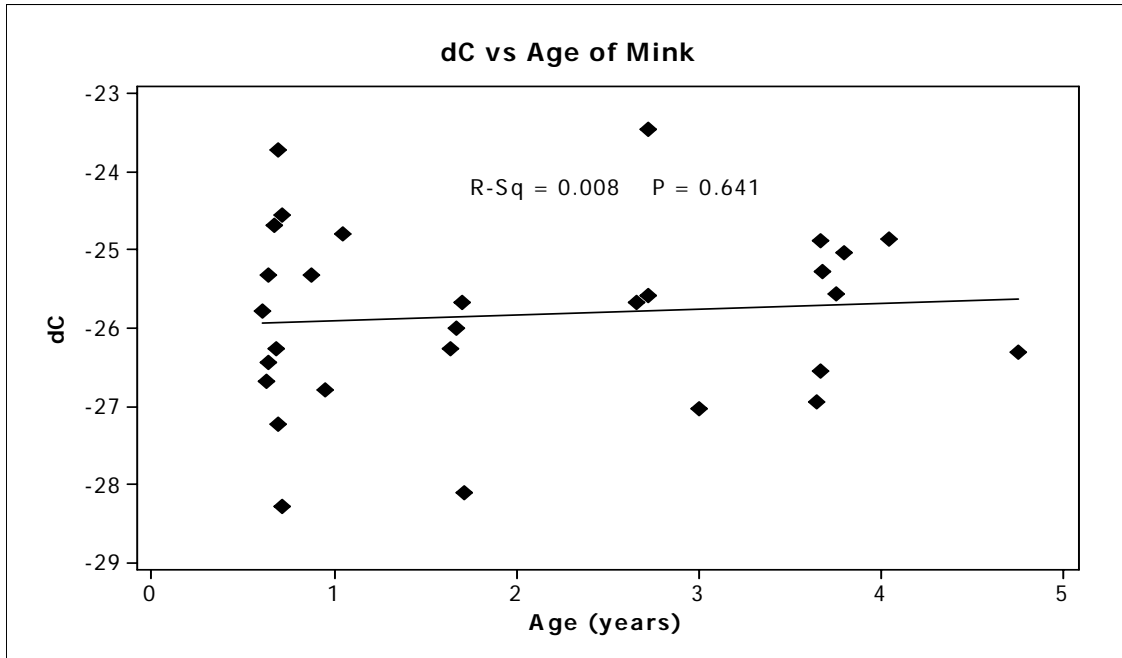
Obs	Age	$\delta\text{N}$	Fit	SE Fit	Residual	St Resid	
36	0.87	14.850	11.374	0.347	3.476	2.51R	Mink #58, Bergen

R denotes an observation with a large standardized residual.



## Appendix C2: $\delta^{13}\text{C}$ versus Age

**Figure C2.** Scatterplot of  $\delta^{13}\text{C}$  versus Age showing no correlation ( $R^2 = 0.008$ ,  $P = 0.641$ ).



**Table C2.** Regression Analysis:  $\delta^{13}\text{C}$  versus Age (29 mink)

The regression equation is  
 $\delta^{13}\text{C} = -26.0 + 0.075 \text{ Age}$

29 cases used, 12 cases contain missing values

Predictor	Coef	SE Coef	T	P
Constant	-25.9799	0.3862	-67.27	0.000
Age	0.0752	0.1593	0.47	0.641

S = 1.16071 R-Sq = 0.8% R-Sq(adj) = 0.0%

<u>Analysis of Variance</u>					
Source	DF	SS	MS	F	P
Regression	1	0.300	0.300	0.22	0.641
Residual Error	27	36.376	1.347		
Total	28	36.676			

Unusual Observations

Obs	Age	dC	Fit	SE Fit	Residual	St Resid
3	0.71	-28.290	-25.927	0.299	-2.363	-2.11R
9	2.72	-23.450	-25.775	0.243	2.325	2.05R

R denotes an observation with a large standardized residual.

**Appendix D: Isotope Data versus Regional Descriptors**

**Appendix D1:  $\delta^{15}\text{N}$  vs. Regional Descriptors**

**Table D1a.** Descriptive statistics:  $\delta^{15}\text{N}$  vs. Regional Factors

**Descriptive Statistics: AOC: In vs. Out, One-way ANOVA P = 0.035**

Variable	AOC	N	N*	Mean	SE Mean	StDev	Minimum	Q1	Median	Q3
$\delta^{15}\text{N}$	In	21	0	12.429	0.382	1.753	9.200	11.305	12.420	13.325
	Out	20	0	11.349	0.310	1.385	9.400	10.218	11.310	12.110

Variable	AOC	Maximum
$\delta^{15}\text{N}$	In	16.880
	Out	14.280

**Descriptive Statistics: Inland vs. Lakeshore, One-way ANOVA P = 0.002**

Variable	Shore	N	N*	Mean	SE Mean	StDev	Minimum	Q1	Median
$\delta^{15}\text{N}$	Inland	21	0	11.158	0.307	1.409	9.200	10.045	11.150
	Shore	20	0	12.684	0.349	1.561	10.450	11.563	12.490

Variable	Shore	Q3	Maximum
$\delta^{15}\text{N}$	Inland	11.835	14.550
	Shore	13.755	16.880

**Descriptive Statistics: Landscape: Wetlands vs. Mix, One-way ANOVA P = 0.085**

Variable	Landscape	N	N*	Mean	SE Mean	StDev	Minimum	Q1	Median
$\delta^{15}\text{N}$	Mix	26	0	11.563	0.308	1.573	9.200	10.120	11.545
	Wetlands	15	0	12.489	0.436	1.688	10.490	11.280	12.420

Variable	Landscape	Q3	Maximum
$\delta^{15}\text{N}$	Mix	12.858	14.550
	Wetlands	13.090	16.880

**Descriptive Statistics: BBWMA (AOC: In, Lakeshore, Wetlands)**

Variable	Landscape	N	N*	Mean	SE Mean	StDev	Minimum	Q1	Median
$\delta^{15}\text{N}$	Wetlands	10	0	13.157	0.536	1.694	11.090	12.200	12.650

Variable	Landscape	Q3	Maximum
$\delta^{15}\text{N}$	Wetlands	14.175	16.880

**Table D1b.** General Linear Model:  $\delta^{15}\text{N}$  versus AOC, Shore, Landscape

Factor	Type	Levels	Values
AOC	fixed	2	In, Out
Shore	fixed	2	Inland, Shore
Landscape	fixed	2	Mix, Wetlands

***Analysis of Variance for  $\delta^{15}\text{N}$ , using Adjusted SS for Tests***

Source	DF	Seq SS	Adj SS	Adj MS	F	P	
AOC	1	11.950	10.764	10.764	5.48	<b>0.025</b>	Significant effect.
Shore	1	24.692	20.780	20.780	10.57	<b>0.002</b>	Significant effect.
Landscape	1	0.510	0.510	0.510	0.26	0.613	No effect.
Error	37	72.714	72.714	1.965			
Total	40	109.866					

S = 1.40187    R-Sq = 33.82%    R-Sq(adj) = 28.45%

Unusual Observations for dN

Obs	dN	Fit	SE Fit	Residual	St Resid	
7	16.8800	13.3379	0.4258	3.5421	2.65 R	(Mink #17, BBWMA)
39	14.5500	11.6028	0.4075	2.9472	2.20 R	(Mink #61, AOC: In/Inland)

R denotes an observation with a large standardized residual.

## Appendix D2: $\delta^{13}\text{C}$ vs. Regional Factors

**Table D2a.** Descriptive statistics:  $\delta^{13}\text{C}$  vs. Regional Factors

**Descriptive Statistics: AOC: In vs. Out, One-way ANOVA P = 0.330**

Variable	AOC	N	N*	Mean	SE Mean	StDev	Minimum	Q1	Median
$\delta^{13}\text{C}$	In	21	0	-25.155	0.344	1.578	-28.100	-25.990	-25.320
	Out	20	0	-25.617	0.315	1.409	-28.290	-26.615	-25.810
Variable	AOC			Q3	Maximum				
$\delta^{13}\text{C}$	In			-24.555	-19.890				
	Out			-24.903	-23.140				

**Descriptive Statistics: Inland vs. Lakeshore, One-way ANOVA P = 0.304**

Variable	Shore	N	N*	Mean	SE Mean	StDev	Minimum	Q1
$\delta^{13}\text{C}$	Inland	21	0	-25.618	0.264	1.211	-28.290	-26.375
	Shore	20	0	-25.131	0.391	1.747	-28.100	-26.143

Variable	Shore	Median	Q3	Maximum
$\delta^{13}\text{C}$	Inland	-25.670	-24.740	-23.140
	Shore	-25.430	-24.455	-19.890

**Descriptive Statistics: Landscape: Wetlands vs. Mix, One-way ANOVA P = 0.635**

Variable	Landscape	N	N*	Mean	SE Mean	StDev	Minimum	Q1
$\delta^{13}\text{C}$	Mix	26	0	-25.466	0.190	0.971	-27.030	-26.278
	Wetlands	15	0	-25.231	0.559	2.166	-28.290	-26.780

Variable	Landscape	Median	Q3	Maximum
$\delta^{13}\text{C}$	Mix	-25.610	-24.843	-23.150
	Wetlands	-25.540	-23.710	-19.890

**Descriptive Statistics: In AOC, Lakeshore (BBWMA)**

Variable	Landscape	N	N*	Mean	SE Mean	StDev	Minimum	Q1
$\delta^{13}\text{C}$	Wetlands	10	0	-24.984	0.699	2.211	-28.100	-26.338

Variable	Landscape	Median	Q3	Maximum
$\delta^{13}\text{C}$	Wetlands	-25.430	-24.178	-19.890

**Table D2a.** General Linear Model:  $\delta^{13}\text{C}$  versus AOC, Shore, Landscape

Factor	Type	Levels	Values
AOC	fixed	2	In, Out
Shore	fixed	2	Inland, Shore
Landscape	fixed	2	Mix, Wetlands

***Analysis of Variance for  $\delta^{13}\text{C}$ , using Adjusted SS for Tests***

Source	DF	Seq SS	Adj SS	Adj MS	F	P
AOC	1	2.189	2.208	2.208	0.96	0.333
Shore	1	2.538	2.393	2.393	1.04	0.314
Landscape	1	0.005	0.005	0.005	0.00	0.963
Error	37	85.013	85.013	2.298		
Total	40	89.744				

S = 1.51580    R-Sq = 5.27%    R-Sq(adj) = 0.00%

Unusual Observations for dC

Obs	$\delta^{13}\text{C}$	Fit	SE Fit	Residual	St Resid	
7	-19.8900	-24.9033	0.4604	5.0133	3.47	R Mink #17, BBWMA
18	-28.1000	-24.9033	0.4604	-3.1967	-2.21	R Mink #38, BBWMA

R denotes an observation with a large standardized residual.

## Appendix 3

### Levels of Bioaccumulative Chemicals of Concern in Mink In and Out of the Rochester Embayment Area of Concern and Along and Inland from the Shore of Lake Ontario

James J. Pagano<sup>1</sup> and James M. Haynes<sup>2</sup>

<sup>1</sup>Environmental Research Center and Department of Chemistry  
State University of New York  
College at Oswego  
Oswego, NY 13126

<sup>2</sup>Department of Environmental Science and Biology  
State University of New York  
College at Brockport  
350 New Campus Drive  
Brockport, NY 14420-2973

March 2007

#### OVERVIEW

This report is the fourth of four resulting from project C302399 funded by the New York Great Lakes Protection Fund in 2004 to address use impairments related to water quality identified in the Remedial Action Plan for the Rochester Embayment of Lake Ontario (RELO RAP). It deals with the concentrations of bioaccumulative chemicals of concern (BCCs) in mink (*Mustela vison*) in and out of the Rochester Embayment Area of Concern (AOC) and along and inland from the shore of Lake Ontario. The previous reports addressed 1) development and use of videocapture (MustelaVision) systems that established the presence and reproduction of mink in and out of the AOC (Wellman and Haynes 2006a); 2) ages, sizes and trophic positions (stable isotope analysis) of mink in the study areas and a predictive model for bioaccumulation of BCCs by mink (Wellman and Haynes 2006b); and 3) literature review of the effects of BCCs on mink and testing of the bioaccumulation model (Wellman and Haynes 2007) against actual tissue concentrations found in this part of the study. Because mink are the most sensitive species to BCCs known, the results of this four-part project (to be integrated and summarized in a final report in early 2007) will determine whether or not delisting can be recommended for the fish and wildlife population, reproduction and deformities use impairments identified in the RELO AOC.

## Table of Contents

INTRODUCTION .....	90
MATERIALS AND METHODS .....	90
Collection .....	90
Processing .....	91
Handling and Shipping .....	91
Analytical Procedures: PCBs, Organochlorine Pesticides and PBDEs .....	91
Sample Extraction and Clean-Up .....	91
Chemical Analysis .....	91
Laboratory Quality Assurance/Quality Control .....	93
Analytical Procedures: Dioxins/Furans and Mercury .....	93
Data Analysis .....	94
RESULTS .....	94
Relationships of BCC Concentrations .....	94
BCC Concentrations vs. Regional Descriptors .....	94
Total Mercury in Brain Tissue .....	94
BCC Concentrations in Adipose Tissue .....	94
BCC Concentrations in Liver Tissue .....	95
DISCUSSION .....	96
Statistical and Other Issues .....	96
Outliers .....	96
Statistical Power .....	97
Lack of Co-planar PCB Concentration Data .....	97
ACKNOWLEDGMENTS .....	98
LITERATURE CITED .....	98
TABLES .....	100
Table 1. Primary column: PCB congeners analyzed with Agilent 25m UltraII .....	100
Table 2. Confirmation column: PCB congeners analyzed with Agilent 60m DB-XLB .....	101
Table 3. Primary analytical column: organochlorine pesticide components and polybrominated diphenyl ether congeners analyzed with 60m DB-XLB .....	102
Table 4. GLPF mink project surrogate recoveries (SR) and surrogate spike checks for various sample matrices. ....	103
Table 5. Correlations of concentrations of selected bioaccumulative chemicals of concern (BCC) in adipose and brain (total Hg only) tissue of mink .....	104
Table 6. Correlations of concentrations of selected bioaccumulative chemicals of concern (BCC) in liver and brain (Total Hg only) tissue of mink. ....	105
Table 7. Total mercury concentrations (ng/g) in the brains of mink .....	106
Table 8. Concentrations of selected BCCs in mink adipose tissue .....	107
Table 9. Concentrations of selected BCCs in mink liver tissue .....	108
FIGURE 1. Map showing the four regions referred to in the study. ....	110

APPENDICES .....111

Appendix A. Chemicals detected in this study. Names in bold were analyzed statistically and are discussed in the text. Raw data for all chemical are in Appendix B (CD).....111

Appendix B. Separate spreadsheet on a CD with all BCC data collected in this study.....112



# **Levels of Bioaccumulative Chemicals of Concern in Mink In and Out of the Rochester Embayment Area of Concern and Along and Inland from the Shore of Lake Ontario**

## **INTRODUCTION**

In the 1980s the binational (Canada, U.S.) International Joint Commission (IJC) began the process of creating and implementing remedial action plans (RAPs) in 43 contaminated areas of concern (AOCs) throughout the Great Lakes Basin. The IJC established 14 “use impairments” that could cause a local area to be “listed” as an AOC, including “degradation of fish and wildlife populations” and “bird or animal deformities or reproductive problems.” In the Rochester AOC, both uses were defined as impaired because “very few” mink were then being trapped or observed within 2 miles of the lake (RAP 1993, 1997). This study was part of a project (Haynes et al. 2002) to determine if populations of mink on the shore of the Rochester Embayment of Lake Ontario (RELO) are negatively impacted by bioaccumulative chemicals of concern (BCCs) and, if so, whether the BCCs are originating in the embayment watershed or elsewhere.

The RELO AOC includes the Embayment, a 35 square mile portion of Lake Ontario south of a line between Bogus Point in the town of Parma and Nine Mile Point in the town of Webster (both in Monroe County, New York); adjacent wetlands and bays; and the six mile reach of the Genesee River, from the Lower Falls to the mouth at Lake Ontario. The RAP also includes the subwatersheds of Salmon Creek, the Genesee River and Irondequoit Creek (RAP 1993, 1997; **Figure 1**).

The question addressed by this portion of the study was: What are the current levels of BCCs in lakeshore and inland populations of mink in and out of the AOC, and how do the levels compare between the four regions? These data are needed for comparison to levels of BCCs known to affect mink reproduction (Wellman and Haynes 2007) in order to determine if mink in the RELO AOC are potentially suffering from the “degradation of fish and wildlife populations” and “bird or animal deformities or reproductive problems” listed as use impairments in the RAP (1993, 1997).

## **MATERIALS AND METHODS**

### **Specimen Collection, Processing and Handling** **Collection**

Mink carcasses were collected from trappers (after skinning) in five areas. We divided the study area into four Regions: Inland/AOC, Lakeshore/AOC, Inland/Out of AOC, and Lakeshore/Out of AOC. Both Lakeshore regions were identical to those defined by Wellman and Haynes (2006a, 2006b)—Lakeshore/AOC was the Braddock Bay Wildlife Management Area (BBWMA), and Lakeshore/Out of AOC was along the Lake Ontario State Parkway west of Route 19 (LOSPW). Inland/AOC included any animals taken in the AOC watershed more than 5 km from the lakeshore (primarily from areas near the Bergen Swamp), and Inland/Out of AOC included animals taken from the Tug Hill Plateau and the Iroquois National Wildlife Refuge (to provide two presumably “clean” control areas). For the purpose of analysis, we described each collection area using the Regional Descriptors AOC: In vs. Out and Lakeshore vs. Inland.

Carcasses were put in plastic bags and frozen by the trappers as soon as possible. The trappers completed log sheets indicating the date and location of capture for each animal, as well as the trapper’s name and contact information. Carcasses were assigned specimen numbers in the

order in which they were collected, and the specimen number, date and location of capture were written on the plastic bags with a permanent marker.

### **Processing**

We thawed the frozen mink carcasses overnight in a refrigerator before processing them. Because some trappers removed the tails when skinning the carcasses, we removed all other tails to obtain comparable measures of body weight and length. We recorded the body weight, tail-less body length, and weight of each tissue sample on a separate sheet for each mink, along with its specimen number and collection record. We placed carcasses in hexane-rinsed aluminum pans or aluminum foil for resection, and all utensils used were rinsed with hexane before each use. Tissues collected for analyses were adipose, liver, brain, testis, kidney and thigh muscle.

### **Handling and Shipping**

Liver and adipose samples were divided into halves or thirds and shipped frozen in dry ice to Columbia Analytical Services (CAS), Inc.'s laboratory in Houston, TX for dioxin/furan analyses, and to the Environmental Research Center (ERC) at SUNY Oswego (co-PI Pagano's lab) for PCB-pesticide-PBDE analyses. If liver or adipose tissue was sufficiently large to divide into thirds, the third sample was frozen and kept at SUNY Brockport. Brain tissues for total mercury analyses were shipped to CAS's laboratory in Kelso, WA. Other tissues (testes, kidney and thigh muscle) were transferred frozen to the ERC for PCB-pesticide-PBDE analyses.

## **Analytical Procedures: PCBs, Organochlorine Pesticides and PBDEs**

### **Sample Extraction and Clean-Up**

The chemicals examined in this study are listed in Appendix A. All tissue samples were extracted for gas chromatographic analysis after methods developed at the SUNY Oswego ERC (Pagano et al. 1999). Pre-cleaned anhydrous sodium sulfate (approximately 10 times sample weight) was added, and the sample extracted three times each with 50 mL hexane using a Brinkman Polytron homogenizer (Model PT 10/35) with small generator (PTA-10S). After each extraction, the hexane extracts were transferred into a volumetric flask and brought to volume. Lipid analysis was conducted by gravimetric procedures utilizing an aliquot (subsample) of the extracted sample. The remaining sample was used for congener-specific PCB, OC pesticide and PBDE analyses. Sample cleanup for OC pesticides followed USEPA Method 3640A (1997) using a Waters Gel Permeation Chromatography (GPC) system (binary pump, Envirolgel column, UV detector and fraction collector) followed by specialized silica gel column for separation of PCBs/OCs/PBDEs from other interferences. The analytical methods used to separate PCBs, OCs and PBDEs were based on methods and standard operating procedures (SOPs) developed at the SUNY Oswego ERC and adapted from Method 3630C-USEPA (1997), Basu (1995a,b), and Harlin and Surratt (1995). In general, silica gel adsorption column cleanup utilized 5.5 grams of 4% deactivated silica gel (100-200 mesh) placed in a 10.5x250 mm chromatography column (VWR-Labglass Wilmad) with an upper layer (0.5 g) of anhydrous sodium sulfate. The sample extract was added to the silica gel column and sequentially eluted with hexane and DCM into PCB (F1) and OC/PBDE (F2) fractions, which were concentrated to 1 mL with a Kuderna-Danish (KD) apparatus using a three ball Snyder Column on a steam bath for gas chromatographic analysis.

### **Chemical Analysis**

Congener-specific PCB, hexachlorobenzene, p-p' DDE, and mirex analyses were conducted based on capillary column procedures previously described (Pagano et al. 1995,

Pagano et al. 1998, Pagano et al. 1999, Chiarenzelli et al. 2001). Briefly, analytical instruments were recalibrated every five samples, with a system blank, instrument blank, and mid-level calibration check solution analyzed during each analytical run. A Hewlett-Packard (HP) Model 5890II GC with an electron capture detector (ECD - Ni<sup>63</sup>) and autosampler was used for primary data acquisition. The capillary column utilized was a HP Ultra II, 25 meter with 0.22 mm id and 0.33  $\mu$ m film thickness. The calibration standard used was a 1:1:1:1 mixture of Aroclors 1221, 1016, 1254, and 1260 each at 200 pg/uL, hexachlorobenzene (HCB) at 5 pg/uL, and p-p' DDE (dichlorodipenyldichloroethylene) and Mirex each at 10 pg/uL (Custom Mixed Fraction #3, AccuStandard, Inc.), which allowed for the analysis of 99 chromatographic zones of 132 congeners/co-eluters (Table 1). PCB analyses were confirmed with a HP Model 5890 II gas chromatograph with an electron capture detector (Ni<sup>63</sup>) and autosampler using a 60 meter DB-XLB capillary column with 0.25 mm id and 0.25  $\mu$ m film thickness. The calibration standard used was a 1:1:1:1:1 mixture of congener mixture sets (C-CSQ-SET 1-5; 10 pg/uL per individual congener, AccuStandard, Inc., New Haven, CT) based on the work of George Frame and co-workers (1996). This analytical setup allowed for analysis of 122 chromatographic zones of 155 congeners/co-eluters (Table 2).

PCB congener nomenclature is based on the arrangement and number of chlorines (1-10) substituted per biphenyl molecule. Congener determination, assignments and accuracy of quantitation were verified for both GC-ECD analytical systems utilizing nine PCB congener mixtures (C-CSQ-SET; AccuStandard, Inc., New Haven, CT) (Frame et al. 1996). Chromatographic data were collected and processed by use of the HP ChemStation software and Microsoft Excel spreadsheet procedures developed at the SUNY Oswego Environmental Research Center (Pagano et al. 1995). The HP software system generated the identity and amount of each PCB congener, confirmed by operator reprocessing of each chromatographic run.

The complex, congener-specific PCB patterns (data) found in mink adipose and liver samples were further processed to a single number representing the average overall chlorination of all congeners in the sample based either on PCB mass or moles of PCBs measured. The unit used was average number of chlorines per biphenyl (Avg Cl/BP). The manipulation of congener-specific data allows for a direct comparison of different types of tissue samples or widely different concentration levels. In addition, congener-specific data provided by other researchers can be transformed to provide a direct comparison of PCB chlorination (qualitative assessment) and concentration (quantitative assessment) between this and previous studies.

Selected organochlorine (OC) pesticides were measured based on Methods 8081A (USEPA 1996). Single instrument/column detection was used for quantitation (DB-XLB, see conditions above). The calibration standard was a 100 pg composite mixture (Single-Column Analytes Mix, M-8081-SC, AccuStandard, Inc.) of USEPA 8081A standard analytes (Table 3). Polybrominated diethyl ethers (PBDEs) were co-analyzed with the OCs on the DB-XLB column setup. The PBDE calibration standard used was an 800 pg/uL (total PBDE - 12 components) solution using the original Great Lakes Chemical Corporation (Great Lakes DE-71, CAS 32534-81-9) technical formulation. The DE-71 technical formulation mass fractions and congener identifications were confirmed with pure PBDE congener standards (BDE-MXE) purchased from Wellington Laboratories (Guelph, ON, Canada) and by mass spectrometric confirmation.

As needed, confirmation of PCBs, OCs, PBDEs, and any co-eluting contaminants were determined utilizing a HP Model 5890II GC with a Model 5971 mass selective detector (GC/EI-MS, electron impact mode) and autosampler. The GC/MS system was set-up to complement the

GC-ECD system, utilizing the same column and temperature programming. Helium was used as the carrier gas at 55 kPa. The injection port and mass selective detector interface were maintained at 270 °C and 300 °C, respectively. Selective ion monitoring (SIM) for PCB (SIM-PCB, Cl homologs 1-10) included ions (m/z) 152, 186, 188, 190, 220, 222, 224, 254, 256, 258, 290, 292, 324, 326, 360, 362, 394, 396, 428, 430, 432, 462 and 464 (Pagano et al. 1998).

#### **Laboratory Quality Assurance/Quality Control**

The QA/QC program at the SUNY Oswego ERC is based on a program developed from USEPA protocols (USEPA 1997). The program consists of replicate analyses, surrogate analyte recoveries (IUPAC 14, 30 IS (F1+F2), 65, 166, and PCT3-F2), matrix spikes/matrix spike duplicates, and method, reagent and system blanks at prescribed intervals. Surrogate recoveries and surrogate spike checks for the various mink tissues analyzed for this project are reported in Table 4. Instrument detection limits (IDL) and detector linearity were established at the start of the project by replicate analyses (N=7) of progressively smaller serial dilutions from the quantitation standards utilized for each analytical system (acceptance criteria > 10% Relative Standard Deviation, RSD). Analytical detection limits (IDL) and practical detection limits (PDL) are provided in the PDL+IDL worksheet of Appendix B (a spreadsheet on a CD that includes all chemical data collected for this project).

Limitations associated with the accurate and bias-free measurement of low-level PCBs, OCs and PBDEs are generally not due to IDL, but are attributed to the ubiquitous background contamination found in the analytical manipulations necessary to prepare and extract samples. The qualitative nature and quantitative amount of the analytical background is of critical importance when analyzing environmental samples at part per billion levels for individual congeners (Stewart et al. 2000). The SUNY Oswego ERC has developed a methodology to determine practical detection limits (PDL) based on the assessment of the extent and congener-specific distribution of background contamination using method (procedural) blanks analyzed with every sample batch. Method blanks are used to document contamination resulting from the analytical process. Method blanks encompass all Standard Operating Procedure (SOP) sample preparation and analytical manipulations within an analyte-free matrix. PDLs are calculated by multiplying the standard deviation of a series of method blanks by the associated Student t variate (usually N=7, df=6, t=3.134) to provide a known confidence interval ( $t_{.99}$ ) for the PDL estimate. PDLs are reported in the PDL+IDL worksheet of Appendix B.

During the project, general laboratory quality assurance and silica gel method validation was determined by analysis (N=16) of National Institute of Standards and Technology (NIST) Standard Reference Material 1946 (Lake Superior Fish Tissue). Results are provided in the NIST SRM 1946 worksheet of Appendix B. Average recoveries of certified concentration values for PCBs were 92.9% and average recoveries of various organochlorine pesticides was 77.6%.

#### **Analytical Procedures: Dioxins/Furans and Mercury**

Dioxin-furan analyses were done using Method 8290A (USEPA 1998) for extractable organics in solid and chemical materials by Columbia Analytical Services, Inc., Houston, TX. Because of analytical uncertainties, because virtually all mercury in biota is methyl mercury (Me-Hg), and because the highest mercury concentrations are found in brain tissue (J. Freemyer, CAS, Houston, TX, pers. comm.), CAS (Kelso, WA) used Method 7471A (USEPA 1994) for total mercury to estimate the Me-Hg concentrations in mink brains. CAS is NELAC-certified (E87611, FAC Rule 64E-1 regulations) by the state of Florida.

### **Data Analysis**

We used Microsoft® Excel 2000 for data management and non-statistical calculations. For statistical analyses, we used SPSS® 13.0 for Windows (SPSS Inc., Chicago, IL). We conducted regression analyses to evaluate the relationships between BCC concentrations. We computed descriptive statistics for selected chemicals in selected tissues: 1) total mercury in brain, and 2) total PCBs and dioxin-furan TEQs; average number of chlorine atoms per biphenyl; dieldrin; PBDEs, mirex and DDE in liver and adipose. We used General Linear Models (GLM, a 2-way ANOVA followed by Tukey's pair-wise comparisons and estimates of statistical power) to analyze the relationships between BCC concentrations and the Regional Descriptors—AOC: In vs. Out and Lakeshore vs. Inland. Results for a number of chemicals, detected infrequently or in minute quantities in mink tissues, are not presented here, but all analytical results and calculations are presented in the NYS GLPF MINK worksheet of Appendix B.

Excluding a statistical outlier (mink 17) and results below detection limits, 36 of 40 mink had mercury in brain tissue. Excluding a statistical outlier (mink 17), one animal with insufficient adipose tissue (mink 30), and a procedural error by CAS (addition of the wrong chemical during the preparation of two samples), 33 of 40 mink had total dioxin-furan TEFs above detection limits in adipose tissue. In liver tissue, excluding statistical outliers (17, 22), 17 of 40 mink had total dioxin-furan TEQs above detection limits. For total PCBs, average chlorine number per biphenyl, mirex, dieldrin and DDE, 37 of 41 mink were used in the statistical analyses of liver. Two mink were statistical outliers for total PCBs (17, 22), one was an outlier for mirex (49), and one had insufficient adipose tissue (29). Outliers ( $> \pm 3$  SE beyond the mean) and values below detection limits (BDL) were excluded from the analyses to avoid skewing general trends high (outliers) or low (BDL  $\neq$  no chemical present in a tissue), respectively. Relationships of the highest and lowest levels of BCCs found in the tissues of mink to their lowest observed adverse effect levels (LOAEL) are addressed by Wellman and Haynes (2006a).

## **RESULTS**

### **Relationships of BCC Concentrations**

Correlations between chemical concentrations were high in adipose and liver tissue. Among the 28 comparisons of seven chemicals and average chlorine per biphenyl in adipose, 25 were highly significant ( $P < 0.01$ ;  $r = 0.441-0.905$ ), two were significant ( $P < 0.05$ ;  $r = 0.367-0.424$ ) and one was suggestive of significance ( $P = 0.088$ , dieldrin vs. average chlorine per biphenyl;  $r = 0.284$ ) (Table 5). Among the 28 comparisons of seven chemicals and average chlorine per biphenyl in liver, 19 were highly significant ( $P < 0.01$ ;  $r = 0.430-0.899$ ), four were significant ( $P < 0.05$ ;  $r = 0.358-0.408$ ) and two were suggestive of significance ( $P < 0.100$ ;  $r = 0.274-0.278$ ) (Table 6).

### **BCC Concentrations vs. Regional Descriptors**

#### **Total Mercury in Brain Tissue**

Total mercury concentrations (Table 7) did not differ (excluding outlier #17) in and out of the AOC ( $P = 0.609$ ; power = 0.079) but concentrations in mink from the Lake Ontario shore were higher than those of inland mink ( $P = 0.032$ ; power = 0.587). There was no interaction between the factors AOC: In vs. Out and Lakeshore vs. Inland ( $P = 0.835$ ; power = 0.055).

#### **BCC Concentrations in Adipose Tissue**

Total PCB concentrations (Table 8a) did not differ (excluding outlier #17) in and out of the AOC ( $P = 0.632$ ; power = 0.076) but concentrations in mink captured near Lake Ontario

were higher than those of inland mink ( $P = 0.014$ ; power = 0.708). There was no interaction between the factors AOC: In vs. Out and Lakeshore vs. Inland ( $P = 0.601$ ; power = 0.081).

The average number of chlorine atoms per biphenyl molecule (Table 8b) did not differ (excluding outlier #17) in and out of the AOC ( $P = 0.475$ ; power = 0.108) but chlorination in mink captured near the Lake Ontario shore was higher than that of inland mink ( $P = 0.006$ ; power = 0.817). There was no interaction between the factors AOC: In vs. Out and Lakeshore vs. Inland ( $P = 0.375$ ; power = 0.141).

Total dioxin-furan TEQs (Table 8c) did not differ (excluding outlier #17) in and out of the AOC ( $P = 0.354$ ; power = 0.149) but concentrations in mink captured near Lake Ontario were higher than those of inland mink ( $P = 0.010$ ; power = 0.763). There was no interaction between the factors AOC: In vs. Out and Lakeshore vs. Inland ( $P = 0.405$ ; power = 0.129).

DDE concentrations (Table 8d) did not differ (excluding outlier #17) in and out of the AOC ( $P = 0.357$ ; power = 0.148) but concentrations in mink captured near Lake Ontario were higher than those of inland mink ( $P = 0.002$ ; power = 0.916). There was no interaction between the factors AOC: In vs. Out and Lakeshore vs. Inland ( $P = 0.339$ ; power = 0.156).

Dieldrin concentrations (Table 8e) did not differ (excluding outlier #17) in and out of the AOC ( $P = 0.241$ ; power = 0.212) but concentrations in mink captured near Lake Ontario were higher than those of inland mink ( $P = 0.007$ ; power = 0.800). There was no interaction between the factors AOC: In vs. Out and Lakeshore vs. Inland ( $P = 0.614$ ; power = 0.079).

Mirex concentrations (Table 8f) did not differ (excluding outlier #17) in and out of the AOC ( $P = 0.259$ ; power = 0.200). The data suggested that concentrations in mink captured near Lake Ontario were higher than those of inland mink ( $P = 0.073$ ; power = 0.536). There was no interaction between the factors AOC: In vs. Out and Lakeshore vs. Inland ( $P = 0.136$ ; power = 0.317).

Polybrominated diphenyl ether concentrations (Table 8g) did not differ (excluding outlier #17) in and out of the AOC ( $P = 0.937$ ; power = 0.051), but concentrations in mink captured near Lake Ontario were higher than those of inland mink ( $P = 0.005$ ; power = 0.838). There was no interaction between the factors AOC: In vs. Out and Lakeshore vs. Inland ( $P = 0.266$ ; power = 0.196).

#### **BCC Concentrations in Liver Tissue**

Total PCB concentrations (Table 9a) did not differ (excluding outliers #17, 22) in and out of the AOC ( $P = 0.960$ ; power = 0.050) but concentrations in mink captured near Lake Ontario were higher than those of inland mink ( $P = 0.018$ ; power = 0.673). There was no interaction between the factors AOC: In vs. Out and Lakeshore vs. Inland ( $P = 0.232$ ; power = 0.219).

The average number of chlorine atoms per biphenyl molecule (Table 9b) did not differ (excluding outliers #17, 22) in and out of the AOC ( $P = 0.449$ ; power = 0.116) but chlorination in mink captured near Lake Ontario was higher than that of inland mink ( $P = 0.026$ ; power = 0.618). There was no interaction between the factors AOC: In vs. Out and Lakeshore vs. Inland ( $P = 0.145$ ; power = 0.306).

Total dioxin-furan TEQs (Table 9c) did not differ (excluding outliers #17, 22) in and out of the AOC ( $P = 0.547$ ; power = 0.089) or between the Lake Ontario shoreline and inland ( $P = 0.337$ ; power = 0.152), nor was there an interaction between the factors AOC: In vs. Out and Lakeshore vs. Inland ( $P = 0.423$ ; power = 0.120).

DDE concentrations (Table 9d) did not differ (excluding outliers #17, 22) in and out of the AOC ( $P = 0.193$ ; power = 0.252) but concentrations in mink captured near Lake Ontario

were higher than those of inland mink ( $P = 0.005$ ; power = 0.836). There was no interaction between the factors AOC: In vs. Out and Lakeshore vs. Inland ( $P = 0.667$ ; power = 0.071).

Dieldrin concentrations (Table 9e) did not differ (excluding outliers #17, 22) in and out of the AOC ( $P = 0.363$ ; power = 0.146) but concentrations in mink captured near Lake Ontario were higher than those of inland mink ( $P = 0.037$ ; power = 0.559). There was no interaction between the factors AOC: In vs. Out and Lakeshore vs. Inland ( $P = 0.260$ ; power = 0.200).

Mirex concentrations (Table 9e) did not differ (excluding outliers #17, 22) in and out of the AOC ( $P = 0.153$ ; power = 0.295). The data suggested differences between the Lake Ontario shore and inland ( $P = 0.066$ ; power = 0.455) and an interaction between the factors AOC: In vs. Out and Lakeshore vs. Inland ( $P = 0.068$ ; power = 0.449).

Polybrominated diethyl ether concentrations (Table 9g) did not differ (excluding outliers #17, 22) in and out of the AOC ( $P = 0.811$ ; power = 0.056) but concentrations in mink captured near Lake Ontario were higher than those of inland mink ( $P = 0.002$ ; power = 0.899). There was no interaction between the factors AOC: In vs. Out and Lakeshore vs. Inland ( $P = 0.143$ ; power = 0.308).

## DISCUSSION

The question addressed by this study was: What are the current levels of BCCs in lakeshore and inland populations of mink in and out of the AOC, and how do levels compare between the four regions? Highly consistent patterns were observed across tissues and chemicals.

- Correlations among concentrations of the seven most notable chemicals analyzed were mostly high and significant in adipose and liver tissue.
- There were no significant differences in BCC concentrations in and out of the Rochester Embayment AOC, although mean values were almost always higher (mostly by factors > 3) in the AOC.
- BCC concentrations in mink captured near the Lake Ontario shore were almost always significantly ( $P < 0.05$ ) or suggestively ( $0.05 < P < 0.1$ ) greater than concentrations in mink captured inland.
- After removing statistical outliers, there were no significant statistical interactions between the two factors analyzed—AOC: In vs. Out and Lakeshore vs. Inland.

The clear signal in these chemical data are that mink captured near Lake Ontario, and presumably eating organisms exposed to Lake Ontario water and its food web, have significantly higher BCC concentrations in their tissues than mink captured inland. Therefore, it is unlikely that BCC sources in the AOC are contributing to the “degradation of fish and wildlife populations” and “bird or animal deformities or reproductive problems” use impairments identified in the RAP (1993, 1997). Whether the data collected in the four parts of this study (Wellman and Haynes 2006a, 2006b, 2007; this report) support delisting of these two use impairments will be addressed in detail in the final report for this project (Haynes et al., in prep.).

### **Statistical and Other Issues**

#### **Outliers**

Mink #17 was excluded from statistical analyses of adipose and liver tissue, and mink #22 was excluded from analysis of liver tissue. The BCC concentrations reported for these two lakeshore-AOC mink are accurate but very high compared to the other lakeshore mink. When

statistical analyses were run including these animals, the resulting significant interaction effects made the results difficult to interpret. Excluding the data for these animals, there were no interaction effects between the treatments AOC: In vs. Out and Lakeshore vs. Inland.

Several factors may account for the high levels of BCCs in minks #17 and #22. Haynes et al. (2004) reported that one sediment sample from Salmon Creek near where mink #17 was captured had a concentration of 1.5 ppm total PCBs. Mink #17 was caught in the large Braddock Bay wetlands complex with broad access to Lake Ontario water and its food web, particularly the carcasses of migrating salmonines. The stable isotope analysis indicated that it fed on organisms about one-half trophic level higher than other mink captured in the Braddock Bay area (Wellman and Haynes 2006b), suggesting that salmonines may have been in its diet. In contrast, lakeshore mink out of the AOC were captured in the upland portion of the Yanty Creek basin south of the Lake Ontario State Parkway, an area with less direct contact to Lake Ontario.

Mink #22 was captured where Round Pond Creek crosses under the Lake Ontario State Parkway (Figure 1), upstream from an area anecdotally reported to have been a munitions factory long ago. Although not previously suspected to exist (RAP 1993, 1997), it is possible that small toxic hotspots exist in the Braddock Bay area to which mink are exposed. Alternatively, it may be that some mink store more BCCs than others due to individual physiological differences in uptake, biotransformation and excretion rates. For example, before beginning the analyses of the 40 mink discussed here, tissues of six mink from the Tug Hill Plateau (presumably a “clean” area) were analyzed to test analytical procedures. For no apparent reason, mink #28 had very high levels of BCCs (Appendix B).

#### **Statistical Power**

In each analysis in this report showing no significant difference between the AOC: In vs. Out treatments and their interactions with the Lakeshore vs. Inland treatments, statistical power was very low despite sample sizes of 8-11 mink per treatment. This result was a consequence of high variation in BCC concentrations among animals, even after eliminating statistical outliers (see above). It is notable that the non-significant differences in tissue concentrations reported for inland mink are always greater than out of the AOC (e.g., TPCB: 1552 vs. 387 ng/g wet, Table 8a; PBDE: 128 vs. 8 ng/g wet, Table 9g). Thus, it is possible that there are differences in the concentrations of BCCs in the tissues of mink in and out of the AOC not detected in our study, but a large number of additional mink would have to be captured and their tissues analyzed to test this hypothesis. Given the large differences in BCC concentrations between lakeshore and inland mink, even if enough additional mink were analyzed it is unlikely that any differences that might be found in concentrations in and out of the AOC would be biologically meaningful in comparison. Therefore, despite low power for the AOC: In vs. Out treatments, the most reasonable conclusion without much greater expense is that there are no biologically meaningful differences in the BCC concentrations of mink in and out of the AOC.

#### **Lack of Co-planar PCB Concentration Data**

Due to expense, no co-planar PCB data were collected for this project; therefore, total TEQ values reported here are low. However, it is well established that co-planar PCBs account for 50-90% of dioxin-furan TEQs in tissues (Wellman and Haynes, 2006b), and this issue was addressed in their modeling predictions for total TEQ levels in Rochester Embayment mink.



## ACKNOWLEDGMENTS

We are very grateful to Randy Baase who for two winters spent many hours trapping mink in the worst weather, and who taught us much about mink. Thanks are also due to other trappers who contributed carcasses and taught us about mink: Matt Lochner, Dan Carroll, Dan Frey, Michael Ingham, Don Newcombe, Tom Raduns, William Schwartz, Jr., Fred Sinclair and Chuck Tirrano; and to the landowners near the Bergen Swamp who allowed us to collect mink on their property: “Doc” Fink, Dick Sands, Mel Reber and Al Burkhardt. We are grateful to Scott Wells and Ross Abbett for dissecting the mink, and to Albert Fulton for creating Figure 1. The government personnel who graciously allowed us to work in their territories include NYS DEC: Dan Carroll, Dave Woodruff and Heidi Bogner Kennedy; NYS OPRHP: James Slusarczyk; and USFWS: Bob Lamoy and Paul Hess. Sara T. Wellman critically reviewed an earlier version of this document. Finally, we gratefully acknowledge grant C302399 from the New York State Great Lakes Protection Fund that made this study possible.

## LITERATURE CITED

- Basu, I. Analysis of PCBs, Pesticides, and PAHs in Air and Precipitation Samples: IADN Project: Sample Preparation Procedures, School of Public and Environmental Affairs, Indiana University, Bloomington, IN, Version 1, June 1995a.
- Basu, I. Analysis of PCBs, Pesticides, and PAHs in Air and Precipitation Samples: IADN Project: Gas Chromatography Procedure, School of Public and Environmental Affairs, Indiana University, Bloomington, IN, Version 1, June 1995b.
- Chiarenzelli, J., Pagano, J., Milligan, M., Holsen, T., Hopke, P., Scudato, R., Falanga, L., Battalagia, T., Migdal, K., Hsu, Y-K, and Hartwell, A. 2001. Enhanced airborne PCB concentrations and chlorination downwind of Lake Ontario. *Environmental Science and Technology* 35(16): 3280-3286.
- Frame, G.M., Cochran, J.W., and Bowadt, S.S. 1996. Complete PCB congener distributions for 17 Aroclor mixture determined by 3 HRGC systems optimized for comprehensive, quantitative, congener-specific analysis. *Journal High Resolution Chromatography* 19(12): 657-668.
- Harlin, K., and Surratt, K. Analysis of PCBs, Pesticides, and PAHs in Air and Precipitation Samples: Sample Preparation Procedures, Illinois State Water Survey, Office of Atmospheric Chemistry, Champaign, IL, SOP #CH-PR-001.3, Version 3, June 1995.
- Haynes, J.M., J.C. Makarewicz, and T.C. Young. 2004. Levels of Bioaccumulative Chemicals of Concern in Air, Water, Sediment and Sentinel Species in the Rochester Embayment of Lake Ontario. Final Report to the NY Great Lakes Protection Fund. SUNY College at Brockport.
- Haynes, J.M., Pagano, J.J., and Wellman, S.T. 2002. New York State Great Lakes Protection Fund Application for State Assistance—RAP Progress in the Rochester Embayment of Lake Ontario: Population Monitoring, and Levels of Bioaccumulative Chemicals of Concern in Mink, a Sentinel Species.
- Pagano, J.J., Scudato, R.J., Roberts, R.N., and Bemis, J.C. 1995. Reductive dechlorination of PCB-contaminated sediments in an anaerobic bioreactor system. *Environmental Science &*

- Technology 29(10):2584-2589.
- Pagano, J.J., Roberts, R.N., Sumner, G.S. 1998. An improved method for the separation of PCB and PCT utilizing alumina adsorption column chromatography. *In* Proceedings of the 216<sup>th</sup> National Meeting of the American Chemical Society, Boston, MA, USA. 38(2):13-16.
- Pagano, J.J., Rosenbaum, P., Roberts, R., Sumner, G., and Williamson, L. 1999. Assessment of maternal contaminant burden by analysis of snapping turtle eggs. *Journal of Great Lakes Research* 25(4):950-962.
- RAP. 1993. Stage I Remedial Action Plan for the Rochester Embayment of Lake Ontario. Monroe County Department of Health. Rochester, NY.
- RAP. 1997. Stage II Remedial Action Plan for the Rochester Embayment of Lake Ontario. Monroe County Department of Health. Rochester, NY.
- Stewart, P., Pagano, J., Darvill, T. Lonky, E., and Reihman, J. 2000. Effects of great lakes fish consumption on brain PCB pattern, concentration and progressive ratio performance. *Environmental Research, Section A* 82:18-32.
- USEPA. 1994. Method 7471A. Mercury in Solid or Semisolid Waste (Manual Cold Vapor Technique). U.S. Environmental Protection Agency. Washington, DC.
- USEPA. 1996. Methods 8081A. Organochlorine Pesticides by Gas Chromatography. U.S. Environmental Protection Agency. Washington, DC.
- USEPA 1997. Test Methods for Evaluating Solid Waste, Physical/Chemical Methods (SW-846). U.S. Environmental Protection Agency. CD-ROM Version 2, National Tech. Info. Serv.
- USEPA. 1998. Method 8290A. Polychlorinated Dibenzodioxins (PCDDs) and Polychlorinated Dibenzofurans (PCDFs) by High Resolution Gas Chromatography/High Resolution Mass Spectrometry (HRGS/HRMS). U.S. Environmental Protection Agency. Washington, DC.
- Wellman, S.T., and Haynes, J.M. 2006a. Monitoring Mink Populations using Video Traps. Department of Environmental Science and Biology, State University of New York at Brockport. Brockport, N.Y.
- Wellman, S.T., and Haynes, J.M. 2006b. Age, Size, and Stable Isotope Data of Mink Populations, and a Predictive Model of Bioaccumulation of Chemicals of Concern in the Rochester Embayment of Lake Ontario. Department of Environmental Science and Biology, State University of New York at Brockport. Brockport, N.Y.
- Wellman, S.T., and Haynes, J.M. 2007. Bioaccumulative Chemicals of Concern in Mink: Adverse Effects Levels and Results of a Predictive Model for the Rochester Embayment of Lake Ontario. Department of Environmental Science and Biology, State University of New York at Brockport. Brockport, N.Y.

## TABLES

**Table 1.** Primary column: PCB congeners analyzed with Agilent 25m UltraII.

Peak #	# Cl	IUPAC #	Peak #	# Cl	IUPAC #	Peak #	# Cl	IUPAC #
1	1	1	34	4+4+4	41+64+71	67	7	179
2	1	3	35	5	96	68	6	137
3	2+2	4+10	36	4	40	69	6+7	130+176
4	2+2	7+9	37	4	67	70	6+6+6	138+163+164
5	2	6	38	4	63	71	6	158
6	2+2	5+8	39	4	74	72	6+7	129+178
7		HCB	40	4	70	73	6	166
8	2	14	41	4+5	66+95	74	7+7	182+187
9	3	19	42	5	91	75	7	183
10	3	30	43	4+4+5	56+60+92	76	6+6	128+167
11	2+2	12+13	44	5	84	77	7	185
12	3	18	45	5+5	89+101	78	7	174
13	2+3	15+17	46	5	99	79	7	177
14	3+3	24+27	47	5	119	80	6+7+8	156+171+202
15	3+3	16+32	48	5	83	81	6+7+8	157+173+201
16	3	34	49	5	97	82	7	172
17	3+4	29+54	50	5+5+5	87+115+117	83	8	197
18	3	26	51		p-p'-DDE	84	7	180
19	3	25	52	5	85	85	7	193
20	3	31	53	6	136	86	7	191
21	3	28	54	4+5	77+110+154	87	8	200
22	3+3+4	20+33+53	55	5+6	82+151	88		mirex
23	4	51	56	5+6+6	124+135+144	89	7+7	170+190
24	3	22	57	5+6	109+147	90	8	198
25	4	45	58	5+6	123+149	91	8	199
26	4	46	59	5	118	92	8+8	196+203
27	4	52	60	6	134	93	7	189
28	4+4	43+49	61	5+6	114+133	94	8+9	195+208
29	4+4+4	47+48+75	62	5+6	122+131	95	9	207
30	4	65	63	6	146	96	8	194
31	3	35	64	6	153	97	8	205
32	4	44	65	5+6	105+132	98	9	206
33	3+4+4	37+42+59	66	6	141	99	10	209

**Table 2.** Confirmation column: PCB congeners analyzed with Agilent 60m DB-XLB.

Peak #	# Cl	IUPAC #	Peak #	# Cl	IUPAC #	Peak #	# Cl	IUPAC #
1	1	1	42	4	42	83	7	179
2	1	2	43	3	35	84	5+6	105+141
3	1	3	44	4	71	85	7	176
4	2+2	4+10	45	3+4	37+41	86	6	137
5	2	9	46	4	64	87	6	130
6	2	7	47	4+5	40+103	88	6	164
7	2	6	48	5	100	89	6	138
8	2	5	49	4	67	90	6	163
		HCB	50	4+5	63+93	91	6+7	129+178
9	2	8	51	5	95	92	6	158
10	3	19	52	4	74	93	7	175
11	2	14	53	4	70	94	7	187
12	3	30	54	4+5	66+91	95	7	183
13	3	18	55	5	92	96	6+7	128+185
14	3	17	56	4+5	56+84	97	7	174
15	2	12	57	5+5	90+101	98	6	167
16	2+3	13+27	58	4	60	99	8	202
17	3	24	59	5	99	100	7	177
18	3	16	60	5+5	83+119	101	7+8	171+201
19	2	15	61	5	97	102	7	173
20	3	32	62	5	87	103	8	197
21	3+4	34+54			p-p' DDE	104	6	156
22	3	29	63	5+6	117+136	105	7	172
23	3	26	64	5+5+6	85+115+154	106	6	157
24	3	25	65	5	110	107	7	180
25	3	31	66	4	81	108	7	193
26	4	53	67	6	151	109	8	200
27	3	28	68	5	82	110	7	191
28	3+3	20+33	69	6	135	111	7	170
29	4	51	70	4+6	77+144	112	8	199
30	4	45	71	6	147	113	7	190
31	3	22	72	6	149			Mirex
32	4	46	73	5	124	114	8	196
33	4	73	74	5+5	109+123	115	8	203
34	4	69	75	6	134	116	9	208
35	4	52	76	5	118	117	7	189
36	4	48	77	6	131	118	8+9	195+207
37	4	49	78	5+6	122+165	119	8	194
38	4+5	47+104	79	6	146	120	8	205
39	4	75	80	5	114	121	9	206
40	4	44	81	6	153	122	10	209
41	4	59	82	6	132			

**Table 3.** Primary analytical column: organochlorine pesticide components and polybrominated diphenyl ether congeners analyzed with 60m DB-XLB.

<b>Organochlorine Pesticides</b>	<b>PBDEs</b>
cis-chlordane	BDE-17
trans-chlordane	BDE-28
alpha-BHC (HCH)	BDE-47
beta-BHC	BDE-66
delta-BHC	BDE-85
gamma-BHC (Lindane)	BDE-99
dieldrin	BDE-100
endosulfan I	BDE-119
endosulfan II	BDE-138
endosulfan sulfate	BDE-153
endrin	BDE-154
hexachlorobenzene (HCB)	
heptachlor epoxide	<b>Polychlorinated biphenyls (PCBs)</b>
mirex	<b>(Dual column confirmational analysis)</b>
p-p'-DDT	
p-p'-DDD	HP UltraII (25m) 100 zones of 132 congeners/co-eluters
p-p'-DDE	DB-XLB (60m) 122 zones of 155 congeners/co-eluters

**Table 4.** GLPF mink project surrogate recoveries (SR) and surrogate spike checks for various sample matrices. F1 and F2 denote silica separation fractions.

		<b>SR14-F1</b>	<b>IS30-F1</b>	<b>IS30-F2</b>	<b>SR65-F1</b>	<b>SR166-F1</b>	<b>SRPCT3-F2</b>
<b>Adipose</b>	<b>N=42</b>	90.4%	111.6%	110.1%	89.6%	97.9%	94.2%
	<b>STDEV</b>	17.2%	6.4%	8.7%	20.8%	16.1%	15.8%
<b>Kidney</b>	<b>N=26</b>	78.9%	115.5%	97.8%	80.7%	80.8%	67.0%
	<b>STDEV</b>	11.0%	11.1%	6.5%	20.5%	12.3%	10.9%
<b>Testes</b>	<b>N=33</b>	86.6%	119.6%	110.5%	85.2%	99.2%	89.6%
	<b>STDEV</b>	14.5%	9.4%	6.0%	13.8%	20.0%	14.1%
<b>Liver</b>	<b>N=45</b>	92.0%	118.6%	106.3%	90.2%	82.4%	81.8%
	<b>STDEV</b>	10.4%	7.5%	8.6%	13.8%	26.6%	26.5%
<b>Surrogate</b>	<b>N=33</b>	107.9%	114.2%	98.4%	93.2%	97.8%	95.1%
<b>Checks</b>	<b>STDEV</b>	6.0%	7.1%	3.2%	6.4%	5.8%	3.3%

**Table 5.** Correlations of concentrations of selected bioaccumulative chemicals of concern (BCC) in adipose and brain (total Hg only) tissue of mink. PCB = polychlorinated biphenyl; DDE = dichlorodiphenyldichloroethylene; TEQ = 2,3,7,8-tetrachlorodibenzo-p-dioxin toxic equivalents; BDE = polybrominated diethyl ether. \*P < 0.05, \*\*P < 0.01; 2-tailed significance level.

BCC	Total PCB	Avg. Cl/ Biphenyl	Dieldrin	DDE	Total TEQ	Mirex	Total BDE
<b>Total Hg</b>							
r =	0.484**	0.424*	0.484**	0.530**	0.536**	0.554**	0.561**
P =	0.004	0.012	0.004	0.001	0.002	0.001	0.001
n =	34	34	34	34	31	34	34
<b>Total PCB</b>							
r =		0.468**	0.460**	0.507**	0.654**	0.809**	0.894**
P =		0.0003	0.004	0.001	<0.001	<0.001	<0.001
n =		37	37	37	30	37	37
<b>Avg. Cl/ Biphenyl</b>							
r =			0.284	0.447**	0.367*	0.464**	0.509**
P =			0.088	0.006	0.046	0.004	0.001
n =			37	37	30	37	37
<b>Dieldrin</b>							
r =				0.905**	0.529**	0.441**	0.501**
P =				<0.001	0.003	0.006	0.002
n =				37	30	37	37
<b>DDE</b>							
r =					0.607**	0.541**	0.525**
P =					<0.001	0.001	0.001
n =					30	37	37
<b>Total TEQ</b>							
r =						0.764**	0.737**
P =						<0.001	<0.001
n =						30	30
<b>Mirex</b>							
r =							0.825**
P =							<0.001
n =							37

**Table 6.** Correlations of concentrations of selected bioaccumulative chemicals of concern (BCC) in liver and brain (Total Hg only) tissue of mink. PCB = polychlorinated biphenyl; DDE = dichlorodiphenyldichloroethylene; TEQ = 2,3,7,8-tetrachlorodibenzo-p-dioxin toxic equivalents; BDE = polybrominated diethyl ether. \*P < 0.05, \*\*P < 0.01; 2-tailed significance level.

BCC	Total PCB	Avg. Cl/ Biphenyl	Dieldrin	DDE	Total TEQ	Mirex	Total BDE
<b>Total Hg</b>							
r =	0.474**	0.430**	0.480**	0.533**	0.473**	0.248	0.467**
P =	0.004	0.010	0.004	0.001	0.006	0.150	0.005
n =	35	35	35	35	32	35	35
<b>Total PCB</b>							
r =							
P =		0.479**	0.408*	0.496**	0.722**	0.621*	0.833**
n =		0.002	0.011	0.002	<0.001	*	<0.001
		38	38	33	31	<0.001	38
						38	
<b>Avg. Cl/ Biphenyl</b>							
r =			0.278	0.453**	0.379*	0.274	0.468**
P =			0.091	0.004	0.036	0.096	0.003
n =			38	38	31	38	38
<b>Dieldrin</b>							
r =				0.899**	0.399*	0.113	0.358*
P =				<0.001	0.026	0.499	0.027
n =				38	31	38	38
<b>DDE</b>							
r =					0.532**	0.251	0.450**
P =					0.002	0.129	0.005
n =					31	38	38
<b>Total TEQ</b>							
r =							
P =						0.759*	0.841**
n =						*	<0.001
						<0.001	31
						31	
<b>Mirex</b>							
r =							0.822**
P =							<0.001
n =							38

**Table 7.** Total mercury concentrations (ng/g) in the brains of mink.

<b>Location</b>	<b>N</b>	<b>Mean</b>	<b>Std. Dev.</b>	<b>P-value</b>	<b>Power</b>
AOC: In					
Lakeshore	8	0.281	0.143	AOC: In vs. Out 0.609	0.079
Inland	10	0.158	0.154		
AOC: Out					
Lakeshore vs. Inland					
Lakeshore	9	0.296	0.155	0.032	0.587
Inland	9	0.194	0.145		
Interaction					
				0.835	0.055

**Table 8a.** Total polychlorinated biphenyl (TCPCB) concentrations (ng/g wet) in the adipose tissue of mink.

<b>Location</b>	<b>N</b>	<b>Mean</b>	<b>Std. Dev.</b>	<b>P-value</b>	<b>Power</b>
AOC: In					
Lakeshore	9	3918.3	5780.1	AOC: In vs. Out 0.632	0.076
Inland	11	1552.4	2410.9		
AOC: Out					
Lakeshore vs. Inland					
Lakeshore	10	3970.4	3280.8	0.014	0.708
Inland	8	387.3	226.2		
Interaction					
				0.601	0.081

**Table 8b.** Average number of chlorine atoms per biphenyl in the adipose tissue of mink.

<b>Location</b>	<b>N</b>	<b>Mean</b>	<b>Std. Dev.</b>	<b>P-value</b>	<b>Power</b>
AOC: In					
Lakeshore	9	6.35	0.28	AOC: In vs. Out 0.475	0.108
Inland	11	6.16	0.24		
AOC: Out					
Lakeshore vs. Inland					
Lakeshore	10	6.37	0.27	0.006	0.817
Inland	8	6.10	0.37		
Interaction					
				0.808	0.141



**Table 8c.** Total TEQ values for dioxins and furans (ng/Kg) in the adipose tissue of mink.

<b>Location</b>	<b>N</b>	<b>Mean</b>	<b>Std. Dev.</b>	<b>P-value</b>	<b>Power</b>
AOC: In				AOC: In vs. Out	
Lakeshore	7	10.281	7.229	0.354	0.149
Inland	10	4.723	4.143		
AOC: Out				Lakeshore vs. Inland	
Lakeshore	9	15.436	12.159	0.010	0.763
Inland	6	5.005	5.252		
				Interaction	
				0.405	0.129

**Table 8d.** Dichlorodiphenyldichloroethylene (DDE) concentrations (ng/g wet) in the adipose tissue of mink.

<b>Location</b>	<b>N</b>	<b>Mean</b>	<b>Std. Dev.</b>	<b>P-value</b>	<b>Power</b>
AOC: In				AOC: In vs. Out	
Lakeshore	9	5612.2	6118.9	0.357	0.148
Inland	11	2600.5	2967.3		
AOC: Out				Lakeshore vs. Inland	
Lakeshore	10	5656.1	3081.7	0.002	0.916
Inland	8	276.9	452.8		
				Interaction	
				0.339	0.156

**Table 8e.** Dieldrin concentrations (ng/g wet) in the adipose tissue of mink.

<b>Location</b>	<b>N</b>	<b>Mean</b>	<b>Std. Dev.</b>	<b>P-value</b>	<b>Power</b>
AOC: In				AOC: In vs. Out	
Lakeshore	9	40.1	51.4	0.241	0.212
Inland	11	18.6	15.0		
AOC: Out				Lakeshore vs. Inland	
Lakeshore	10	33.9	17.1	0.007	0.800
Inland	8	3.2	1.7		
				Interaction	
				0.614	0.079

**Table 8f.** Mirex concentrations (ng/g wet) in the adipose tissue of mink.

<b>Location</b>	<b>N</b>	<b>Mean</b>	<b>Std. Dev.</b>	<b>P-value</b>	<b>Power</b>
AOC: In				AOC: In vs. Out	
Lakeshore	9	16.2	22.1	0.259	0.200
Inland	11	9.3	13.8		
AOC: Out				Lakeshore vs. Inland	
Lakeshore	10	72.6	123.0	0.073	0.436
Inland	8	1.3	1.2		
				Interaction	
				0.136	0.317

**Table 8g.** Polybrominated diphenyl ether (PBDE) concentrations (ng/g wet) in the adipose tissue of mink.

<b>Location</b>	<b>N</b>	<b>Mean</b>	<b>Std. Dev.</b>	<b>P-value</b>	<b>Power</b>
AOC: In				AOC: In vs. Out	
Lakeshore	9	177.9	167.3	0.937	0.051
Inland	11	87.6	99.0		
AOC: Out				Lakeshore vs. Inland	
Lakeshore	10	227.7	208.5	0.005	0.838
Inland	8	30.4	11.9		
				Interaction	
				0.266	0.196

**Table 9a.** Total polychlorinated biphenyl (PCB) concentrations (ng/g wet) in the liver tissue of mink.

<b>Location</b>	<b>N</b>	<b>Mean</b>	<b>Std. Dev.</b>	<b>P-value</b>	<b>Power</b>
AOC: In				AOC: In vs. Out	
Lakeshore	8	164.3	219.7	0.960	0.050
Inland	11	92.6	168.3		
AOC: Out				Lakeshore vs. Inland	
Lakeshore	10	230.5	227.3	0.018	0.673
Inland	10	20.6	12.7		
				Interaction	
				0.232	0.219

**Table 9b.** Average number of chlorine atoms per biphenyl in the liver tissue of mink.

<b>Location</b>	<b>N</b>	<b>Mean</b>	<b>Std. Dev.</b>	<b>P-value</b>	<b>Power</b>
AOC: In				AOC: In vs. Out	
Lakeshore	8	6.14	0.31	0.449	0.116
Inland	11	6.05	0.36		
AOC: Out				Lakeshore vs. Inland	
Lakeshore	10	6.37	0.20	0.026	0.618
Inland	10	5.97	0.37		
				Interaction	
				0.145	0.306

**Table 9c.** Total TEQ values for dioxins and furans (ng/Kg) in the liver tissue of mink.

<b>Location</b>	<b>N</b>	<b>Mean</b>	<b>Std. Dev.</b>	<b>P-value</b>	<b>Power</b>
AOC: In				AOC: In vs. Out	
Lakeshore	3	1.655	1.656	0.547	0.089
Inland	5	1.009	1.778		
AOC: Out				Lakeshore vs. Inland	
Lakeshore	5	7.201	13.772	0.337	0.152
Inland	4	0.206	0.390		
				Interaction	
				0.423	0.120

**Table 9d.** Dichlorodiphenyldichloroethylene (DDE) concentrations (ng/g wet) in the liver tissue of mink.

<b>Location</b>	<b>N</b>	<b>Mean</b>	<b>Std. Dev.</b>	<b>P-value</b>	<b>Power</b>
AOC: In				AOC: In vs. Out	
Lakeshore	8	305.0	354.0	0.193	0.252
Inland	11	128.2	216.4		
AOC: Out				Lakeshore vs. Inland	
Lakeshore	10	244.0	157.1	0.005	0.836
Inland	10	8.0	11.0		
				Interaction	
				0.667	0.071

**Table 9e.** Dieldrin concentrations (ng/g wet) in the liver tissue of mink.

<b>Location</b>	<b>N</b>	<b>Mean</b>	<b>Std. Dev.</b>	<b>P-value</b>	<b>Power</b>
AOC: In				AOC: In vs. Out	
Lakeshore	9	10.7	11.6	0.363	0.146
Inland	11	7.2	14.4		
AOC: Out				Lakeshore vs. Inland	
Lakeshore	10	11.4	9.3	0.037	0.559
Inland	8	0.3	0.2		
				Interaction	
				0.260	0.200

**Table 9f.** Mirex concentrations (ng/g wet) in the liver tissue of mink.

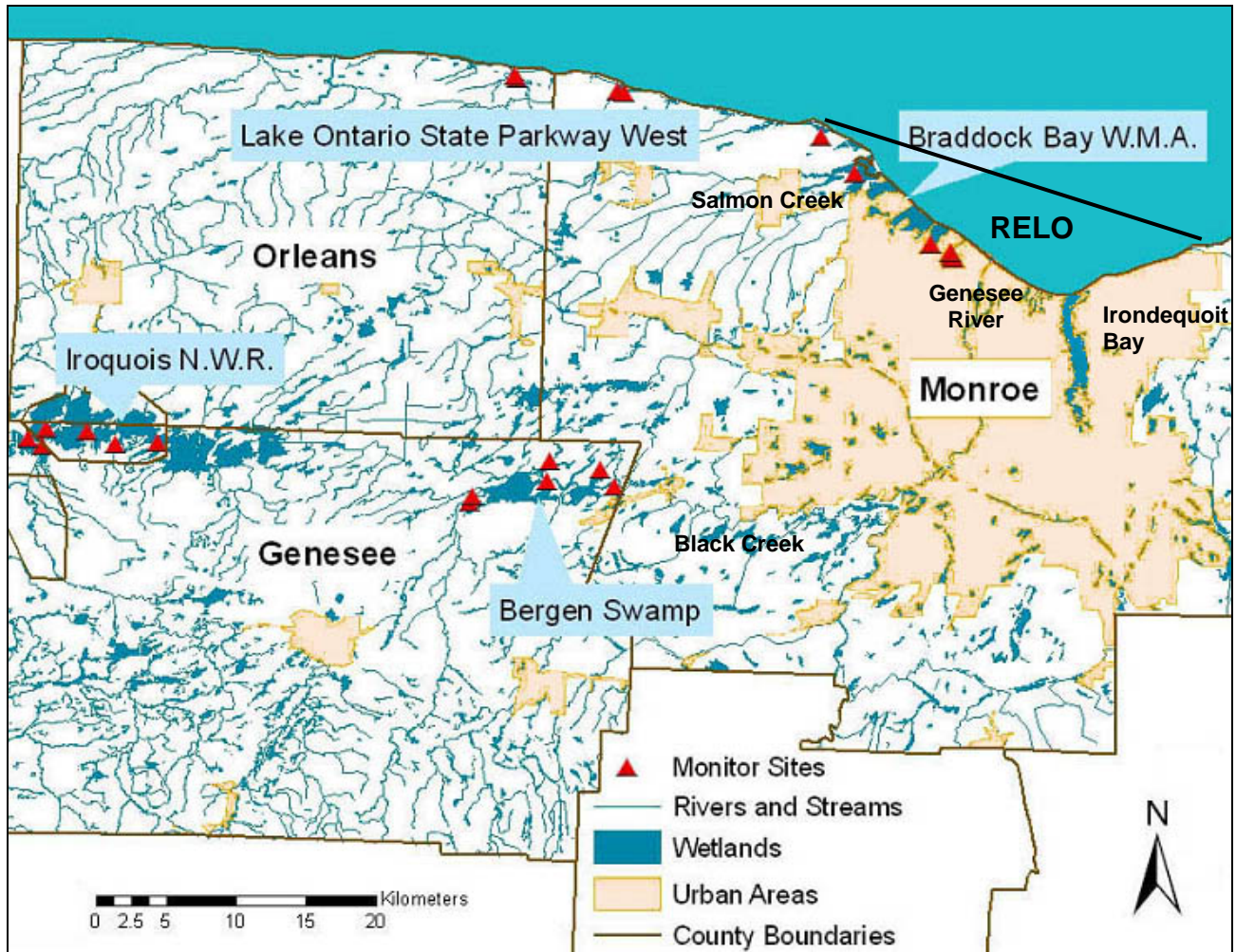
<b>Location</b>	<b>N</b>	<b>Mean</b>	<b>Std. Dev.</b>	<b>P-value</b>	<b>Power</b>
AOC: In				AOC: In vs. Out	
Lakeshore	8	3.2	5.4	0.153	0.295
Inland	11	3.1	6.4		
AOC: Out				Lakeshore vs. Inland	
Lakeshore	10	25.9	40.7	0.066	0.455
Inland	10	0.2	0.2		
				Interaction	
				0.068	0.449

**Table 9g.** Polybrominated diphenyl ether (PBDE) concentrations (ng/g wet) in the liver tissue of mink.

<b>Location</b>	<b>N</b>	<b>Mean</b>	<b>Std. Dev.</b>	<b>P-value</b>	<b>Power</b>
AOC: In				AOC: In vs. Out	
Lakeshore	8	6.1	7.5	0.811	0.056
Inland	11	3.0	3.7		
AOC: Out				Lakeshore vs. Inland	
Lakeshore	10	9.1	7.1	0.002	0.899
Inland	10	0.8	0.6		
				Interaction	
				0.143	0.308

## FIGURES

**Figure 4.** Map showing the four regions referred to in the study. AOC/Lakeshore is Braddock Bay WMA, AOC/Inland is at least 3 km from Lake Ontario, Out of AOC/Lakeshore is the Lake Ontario State Parkway west of Rte.19, and Out of AOC/Inland is Iroquois NWR and the Tug Hill Plateau (not shown). RELO is the Rochester Embayment of Lake Ontario. (Map by Albert Fulton 2005.)



## APPENDICES

Appendix A. Chemicals detected in this study. Names in bold were analyzed statistically and are discussed in the text. Raw data for all chemical are in Appendix B (CD).

<b>Chemical</b>	<b>Abbreviation</b>
<b>Total Polychlorinated Biphenyls</b> <sup>1,2</sup>	<b>TCPB</b>
Cl-1	
Cl-2	
Cl-3	
Cl-4	
Cl-5	
Cl-6	
Cl-7	
Cl-8	
Cl-9	
Cl-10	
<b>Pesticides</b>	
(cis) alpha-chlordane	ACHLOR
(trans) gamma-chlordane	GCHLOR
Aldrin	ALDRIN
alpha-BHC (HCH)	ABHC
beta-BHC	BBHC
delta-BHC	DBHC
<b>Dieldrin</b>	<b>DIELDRIN</b>
endosulfan I	ENDO1
endosulfan II	ENDO2
endosulfan sulfate	ENDOSUL
Endrin	ENDRIN
endrin aldehyde	ENDA
endrin ketone	ENDK
gamma-BHC	GBHC
Heptachlor	HEP
heptachlor epoxide	HEPEPO
Hexachlorobenzene	HCB
Methoxychlor	METH
<b>Mirex</b>	<b>MIREX</b>
p-p'-DDD	DDD
<b>p-p'-DDE</b>	<b>DDE</b>
p-p'-DDT	DDT
<b>Total Brominated Diethyl Ethers</b>	<b>TBDE</b>
BDE-17	BDE17
BDE-28	BDE28
BDE-47	BDE47

BDE-66	BDE66
BDE-85	BDE85
BDE-99	BDE99
BDE-100	BDE100
BDE-119	BDE119
BDE-138	BDE138
BDE-153	BDE153
BDE-154	BDE154

**Dibenzo-p-dioxins**

2,3,7,8-Tetrachlorodibenzo-p-dioxin (TCDD)	TCDD
1,2,3,7,8-Pentachlorodibenzo-p-dioxin (PeCDD)	PeCDD
1,2,3,4,7,8-Hexachlorodibenzo-p-dioxin (HxCDD)	HxCDD
1,2,3,6,7,8-Hexachlorodibenzo-p-dioxin (HxCDD)	HxCDD2
1,2,3,7,8,9-Hexachlorodibenzo-p-dioxin (HxCDD)	HxCDD3
1,2,3,4,6,7,8-Heptachlorodibenzo-p-dioxin (HpCDD)	HpCDD
Octachlorodibenzo-p-dioxin (OCDD)	OCDD

**Tetrachlorodibenzofurans**

2,3,7,8-Tetrachlorodibenzofuran (TCDF)	TCDF
1,2,3,7,8-Pentachlorodibenzofuran (PeCDF)	PeCDF
2,3,4,7,8-Pentachlorodibenzofuran (PeCDF)	PeCDF2
1,2,3,4,7,8-Hexachlorodibenzofuran (HxCDF)	HxCDF
1,2,3,6,7,8-Hexachlorodibenzofuran (HxCDF)	HxCDF2
1,2,3,7,8,9-Hexachlorodibenzofuran (HxCDF)	HxCDF3
2,3,4,6,7,8-Hexachlorodibenzofuran (HxCDF)	HxCDF4
1,2,3,4,6,7,8-Heptachlorodibenzofuran (HpCDF)	HpCDF
1,2,3,4,7,8,9-Heptachlorodibenzofuran (HpCDF)	HpCDF2
Octachlorodibenzofuran (OCDF)	OCDF

**Total Toxic Equivalents<sup>1</sup> (TEQ)** **Total TEQ**

**Total Mercury** **Total Hg**

<sup>1</sup>Excluding co-planar PCBs. See Discussion for explanation.

<sup>2</sup>PCB homologues were determined by spreadsheet manipulations (see NYS GLPF MINK worksheet in Appendix B) based on congener-specific PCB measurements. PCB data were further processed such that the mole percent (congener specific and homologue) and average chlorine/biphenyl (Cl/BP) values were generated. Coeluting congeners were assumed to be in equal proportions for all spreadsheet calculations (Pagano et al., 1995).

**Appendix B.** Separate spreadsheet on a CD with all BCC data collected in this study.

## Appendix 4

### **Bioaccumulative Chemicals of Concern in Mink: Adverse Effects Levels and Results of a Predictive Model for the Rochester Embayment of Lake Ontario**

Sara T. Wellman and James M. Haynes

Department of Environmental Science and Biology  
State University of New York  
College at Brockport  
350 New Campus Drive  
Brockport, NY 14420-2973

March 2007

#### **OVERVIEW**

This report is the fourth of four resulting from project C302399 funded by the New York Great Lakes Protection Fund in 2004 to address use impairments related to water quality identified in the Remedial Action Plan for the Rochester Embayment of Lake Ontario (RELO RAP). It gives a brief review of pertinent literature and reports the results of a model for bioaccumulation of selected chemicals in mink in the Rochester Embayment. Previous reports addressed the 1) development and use of videocapture (Mustelavision) systems that established the presence and reproduction of mink in and out of the RELO RAP Area of Concern (AOC); ages, sizes and trophic positions (stable isotope analysis) of mink (*Mustela vison*) in the study area; and 3) levels of BCCs in mink tissues. Because mink are the most sensitive known species to BCCs, the results of this four-part project will determine whether delisting the fish and wildlife reproduction impairment for the RELO AOC can be recommended.



## TABLE OF CONTENTS

INTRODUCTION .....	115
ADVERSE EFFECTS LEVELS.....	115
Method .....	115
Results And Discussion .....	116
Dioxins And Furans .....	116
Polychlorinated Biphenyls.....	116
Mercury.....	117
Overlaps Of PCB And Dioxin/Furan Toxicities.....	117
Conclusion .....	117
BIOACCUMULATION MODEL .....	118
Method .....	118
Results And Discussion .....	119
SUMMARY .....	120
ACKNOWLEDGMENTS .....	120
LITERATURE CITED .....	1203
Table 1. Selected endpoints and effects levels reported for mercury, PCBs and TEQs in mink diets and tissues .....	123
Table 2. TEQ values from dioxins and furans for Lakeshore and Inland mink livers, showing high, low and average values for each category .....	124
Table 3. Predicted versus measured values for tissue residues of dioxin/furans (TEQs), methylmercury, and PCBs, based on water concentrations in Lake Ontario .....	124
Table A-1. Adverse Effects Levels of Dioxin .....	125
Table A-2. Adverse Effects Levels of Polychlorinated Biphenyls.....	127
Table A-3. Adverse Effects Levels of Mercury.....	130
Table A-4. Adverse Effects Levels of Organochlorine Pesticides .....	132
Table A-5. Adverse Effects Levels of Multiple Polyhalogenated Hydrocarbons .....	133
References Used in Appendix .....	137

## INTRODUCTION

In the 1980s the binational (Canada, U.S.) International Joint Commission (IJC) began the process of creating and implementing remedial action plans (RAPs) in 43 contaminated areas of concern (AOCs) throughout the Great Lakes Basin. The IJC established 14 “use impairments” that could cause a local area to be “listed” as an AOC, including “degradation of fish and wildlife populations” and “bird or animal deformities or reproductive problems.” In the Rochester AOC, both uses were defined as impaired because “very few” mink (*Mustela vison*) were then being trapped or observed within 2 miles of the lake (RAP 1993, 1997). This study was part of a project (Haynes *et al.* 2002) to determine if populations of mink on the shore of the Rochester Embayment of Lake Ontario (RELO) are negatively impacted by bioaccumulative chemicals of concern (BCCs) and, if so, whether the BCCs originate in the embayment watershed or elsewhere.

The RELO AOC includes the Embayment, a 35 square mile portion of Lake Ontario south of a line between Bogus Point in the town of Parma and Nine Mile Point in the town of Webster (both in Monroe County, New York); adjacent wetlands and bays; and the six mile reach of the Genesee River from the Lower Falls to the mouth at Lake Ontario. The RAP also includes the subwatersheds of Salmon Creek, the Genesee River and Irondequoit Creek (RAP 1993, 1997).

The initial questions addressed by this portion of the study were: 1) Which BCCs, and at what levels, are known to cause adverse effects on populations or reproduction, or to cause deformities, in mink? 2) How do predicted levels of BCCs in mink tissues (based on concentrations in Lake Ontario water) compare with measured tissue residues in our lakeshore mink specimens?

Our approach to the first question was to do a literature search, looking for reports on the levels of BCCs in mink tissues corresponding to adverse effects. This gave us values to compare to the tissue residues we found in mink (Pagano and Haynes, in preparation). The results of the comparisons will be described in the final report for this project (Haynes *et al.*, in preparation), along with an assessment of risk to AOC and Lake Ontario shoreline mink.

To answer the second question, our approach was to provide a predictive model for the bioaccumulation and biomagnification of BCCs in AOC mink tissues based on concentrations of BCCs in the waters of Lake Ontario (Wellman and Haynes 2006). If model predictions are well correlated with actual tissue concentrations in mink, by knowing tissue residue levels that cause adverse effects we will have created a risk assessment tool for mink without the expense of tissue analyses.

## ADVERSE EFFECTS LEVELS

### Method

Basu *et al.* (2006) wrote an extensive review of the literature on the toxic effects of BCCs in mink, covering field and lab studies and the use of mink in hazard assessments. Leonards *et al.* (1995) and Kannan *et al.* (2000) reviewed the available literature on the toxicity of PCBs to mink. Rather than duplicate those efforts, we focused on studies which linked dietary levels of BCCs to tissue residues as well as to reproductive or other effects. Such studies allow direct comparisons of our tissue residue results (Pagano and Haynes, in preparation) to levels associated with adverse effects. We also concentrated on reports of

chronic exposures, as they would best represent the exposures of mink to BCCs in the environment. Search engines used included Academic Search Premier, BioOne, BasicBIOSIS, InfoTrac OneFile, JSTOR, and ScienceDirect.

## Results and Discussion

We found studies linking dietary concentrations to tissue residues for dioxins and furans, PCBs, and mercury. No studies of this type were found for any of the organo-chlorine (OC) pesticides except hexachlorobenzene (HCB). Rush *et al.* (1983) reported increased kit mortality at 1 ppm HCB, resulting in adipose residues of 95 ppb and undetectable liver residues. According to Giesy *et al.* (1994), studies in the 1970s and 1980s determined that OC pesticides were not the cause of effects seen in mink that ate Great Lakes fish. Because OC pesticide levels have decreased in the environment since then, they would be even less significant today, which probably accounts for the lack of studies regarding them.

### Dioxins and furans

The toxicity of dioxins and furans to mink is well-established (Basu *et al.* 2006, Hochstein *et al.* 1998, 2001, Render *et al.* 2000, 2001), and LOAELs (Lowest Observable Adverse Effect Levels) are frequently reported as 2,3,7,8-TCDD equivalents (TEQs) in ppb (dietary) or pg/g (tissue residue) wet weight.

Many studies evaluated toxic end points in terms of dietary concentrations but not as tissue residues in the mink. Render *et al.* (2000) reported that a dietary concentration of 5 ppb 2,3,7,8-TCDD fed to adult females for six months caused proliferation of squamous epithelial cells in bone adjacent to teeth, and Render *et al.* (2001) found the same effect in 6- and 12-week-old kits fed 2.4 ppb 2,3,7,8-TCDD for as little as 14 days. Hochstein *et al.* (1998) reported that 1 ppb caused 62.5% mortality in adult female mink fed 2,3,7,8-TCDD for 125 days. Hochstein *et al.* (2001) found that when mink dams were fed 0.053 ppb 2,3,7,8-TCDD, kit survival was reduced to 47% vs. 83% in the control group (0.0006 ppb TCDD). Unfortunately, these studies do not provide data that is directly comparable to our tissue analyses (Pagano and Haynes, in preparation).

Tissue residues as well as dietary concentrations were reported by several researchers feeding wild-caught fish to mink. Since the fish used as the source of BCCs contained PCBs as well as dioxins and furans, their total TEQ values also included contributions from the coplanar PCBs in the fish (Table 1 and Appendix A). Heaton *et al.* (1995) and Tillit *et al.* (1996) reported reduced 3- and 6-week-old kit survival at a maternal dietary concentration of 22.4 pg TEQ/g (0.72 µg/g TPCBs), which resulted in maternal liver residues of 208.3 pg TEQ/g (2.19 µg/g TPCBs). Bursian *et al.* (2006a, b) reported increased mortality in 3- to 6-week-old mink kits whose dams had been fed 68.5 pg TEQ/g (3.7 µg/g TPCBs), resulting in maternal liver residue levels of 218.4 pgTEQ/g (3.133 µg/g TPCBs). Bursian *et al.* (2006a, b, c) also found jaw lesions in 27- and 31-week-old juveniles fed 47 pg TEQ/g (1.1 µg/g TPCBs) and 9.2 pg TEQ/g (0.96 µg/g TPCBs), respectively, with corresponding juvenile liver residues of 75 pg TEQ/g (16 µg/g TPCBs) and 40.2 pg TEQ/g (1.7 µg/g TPCBs).

### Polychlorinated biphenyls

Bursian *et al.* (2006a) found that the dietary LC<sub>10</sub> and LC<sub>20</sub> for total PCBs were 0.231 and 0.984 µg/g TPCBs, and estimated a threshold dietary concentration of 33.2 pg/g TPCBs. Restum *et al.* (1998) reported reduced whelping in dams fed 0.25 ppm PCBs, resulting in a liver concentration of 860 ng/g. Halbrosk *et al.* (1999) found a trend (P = 0.069) for reduced

litter size in dams fed 1360 ppb Aroclor 1260 equivalent (EQ) PCBs in the diet, resulting in a maternal liver concentration of 7.25 ppm Aroclor 1260 EQ and a maternal adipose concentration of 129 ppm Aroclor 1260 EQ. However, these results may have been confounded by the presence of mercury in the fish used in the diet, resulting in 0.22 ppm Hg in the diet and 3.67 ppm in the maternal livers.

### **Mercury**

In 1974, Aulerich *et al.* reported that all mink fed a diet including 5 ppm mercury died after 29 days of treatment, with brain residue levels of approximately 20 ppm. Wobeser *et al.* (1976) reported that 1.1 ppm dietary MeHg caused “classic mercury intoxication,” including neurotoxicity; the corresponding brain concentration was 8.2 ppm. Wren *et al.* (1987a, b) reported that 1.0 µg/g dietary MeHg caused adult mortality as well as a reduction in litter size, with a brain residue of 15.3 µg/g. However, this dietary level is misleading because the 1 ppm chow was used only every other day after unexpected mortalities within less than three months.

Dansereau *et al.* (1999) reported a reduction in the proportion of females whelping at dietary levels of 0.5 ppm Hg, resulting in liver residues of 80.4 µg/g. Halbbrook *et al.* (1997) found reduced litter size at 0.22 ppm dietary Hg (in fish), resulting in liver residues of 3.67 ppm. Using the average of brain:liver residue ratios from Evans *et al.* (2000), Wobeser *et al.* (1976) and Wren *et al.* (1987a, b), we estimated the brain residues for the reduced whelping (Dansereau *et al.* 1999) as 23.2 µg/g, and for reduced litter size (Halbrook *et al.* 1997) as 1.06 µg/g. While these estimations are not strictly accurate, because the brain:liver ratio varies within and among studies, they should be close enough to allow comparison with our brain residue results (Pagano and Haynes, in preparation).

### **Overlaps of PCB and dioxin/furan toxicities**

Unfortunately, miscommunication between PIs Pagano and Haynes and with Columbia Analytical Services resulted in no analyses for co-planar PCBs in our study. However, several studies show distinct relationships between total TEQ, PCB TEQ and dioxin-furan TEQ. Analyses of fish from the Housatonic River used in mink diets by Bursian *et al.* (2006a) showed that approximately 91% of the dietary TEQ value was contributed by PCBs, and only about one-tenth of the TEQ value by dioxins and furans. According to Bursian (2006c), Heaton *et al.* (1995) and Tillitt *et al.* (1996) reported that PCBs accounted for 73% of the TEQ in fish from Saginaw Bay, Michigan. In contrast, PCBs made up less than 44% of the TEQ in the Saginaw Bay fish examined by Bursian *et al.* (2006c), with about half the TEQ value contributed by dioxins and furans. Thus, an estimate of the total environmental TEQ exposure, based on analysis of only dioxins and furans, would have to multiply the dioxin/furan TEQ by a correction factor between two and ten, and this is what we did.

### **Conclusion**

In our literature review, jaw lesions had the lowest LOAELs (Table 1). Table 2 shows total TEQ values (low, average, high) for lakeshore and inland mink in the AOC, based on dioxin/furan analyses, and calculated estimates including co-planar PCBs. The highest measured TEQ value for AOC lakeshore mink in our study was 47.62 pg TEQ/g wet weight (Pagano and Haynes, in preparation), which is higher than the LOAEL of 40 pg TEQ/g liver at which jaw lesions were seen (Bursian *et al.* 2006a, b). The lowest measured TEQ value in lakeshore mink, 0.22 pg TEQ/g, even when multiplied by ten is still an order of magnitude smaller than the LOAEL, indicating no risk. However, the average (excluding high and low) of 7.8 pg TEQ/g for our lakeshore mink (Pagano and Haynes, in preparation), if multiplied by a correction factor of five, approaches the LOAEL for jaw lesions. This would indicate that some

lakeshore mink are at risk of developing jaw lesions, which have been shown to lead to jaw deformities, osteolysis, and tooth loss (Render *et al.* 2001). Histological examinations of our minks' jaws for this lesion could help to determine whether to delist the RELO AOC for deformities. Further comparisons of the levels of BCCs in our mink tissues to LOAELs will be presented in our final report (Haynes *et al.* in preparation).

The highest measured TEQ value for inland mink was 4.16 pg TEQ/g. When multiplied by the correction factor of ten, the result is approximately equal to the LOAEL of 40 pg TEQ/g, indicating that the most exposed of the inland mink may be at risk for developing jaw lesions. However, the lowest value of 0.00 pg TEQ/g and the average TEQ value of 0.25 pg TEQ/g, even when multiplied by a factor of ten, indicate that the majority of inland mink are not at risk.

## BIOACCUMULATION MODEL

### Method

For modeling the bioaccumulation of chemicals in mink, we started with Equation 28 from Sample *et al.* (1996), adding the units for clarity:

$$C_w \left( \frac{mg}{L} \right) = \frac{NOAEL \left( \frac{mg}{kg \cdot d} \right) \times bw(kg)}{W \left( \frac{L}{d} \right) + \left[ F \left( \frac{kg}{d} \right) \times BAF \right]}, \quad (1)$$

where  $C_w$  is the concentration of the BCC in the water,  $NOAEL$  is the No Observed Adverse Effects Level;  $W$  and  $F$  are the daily water and food consumption rates in L/day and kg/day, respectively;  $BAF$  is the bioaccumulation factor for the chemical of concern (based on the trophic level of the animal and the octanol-water partition coefficient,  $k_{ow}$ , a measure of hydrophobicity of the compound); and  $bw$  is the body weight of the animal in kilograms (Sample *et al.* 1996).

We solved for  $NOAEL$ , and taking into account the aquatic portion of the animal's diet ( $P_{aq}$ ), got an equation to predict the exposure level of an animal to a BCC in water:

$$NOAEL \left( \frac{mg}{kg (bw) \cdot d} \right) = \frac{C_w \left( \frac{mg}{kg} \right) [W(kg) + (F(kg) \times P_{aq} \times BAF)]}{bw(kg)}. \quad (2)$$

According to Sample *et al.* (1996), the dietary concentration  $C_f$  (mg/kg) equivalent to the  $NOAEL$  is

$$C_f \left( \frac{mg}{kg} \right) = \frac{NOAEL \left( \frac{mg}{kg \cdot d} \right) \times bw(kg)}{F \left( \frac{kg}{d} \right)}. \quad (3)$$

Substituting equation (2) for  $NOAEL$  into equation (3) for  $C_f$ , the  $bw$  terms in the numerator and denominator cancel out and give a dietary concentration equivalent to the exposure level based on the BCC concentration in water, the food and water consumption rates of mink (177 g and 0.1 L as reported by Wellman and Haynes 2006), the percent aquatic diet

(between 50 and 90% as in USEPA 1995), and the bioaccumulation factor (Sample *et al.* 1996):

$$C_f \left( \frac{mg}{kg} \right) = \frac{C_w \left( \frac{mg}{kg} \right) \left[ W \left( \frac{kg}{d} \right) + F \left( \frac{kg}{d} \right) \times P_{aq} \times BAF \right]}{F \left( \frac{kg}{d} \right)}. \quad (4)$$

This dietary concentration equivalent can be directly compared to dietary concentrations of BCCs known to cause adverse effects in mink.

Using the highest and lowest values for diet-to-tissue biomagnification factors ( $BMF_t$ ) calculated from the literature (see Appendix A), we predicted levels of selected BCCs in mink tissue with the equation

$$C_t \left( \frac{\mu g}{g} \right) = C_f \left( \frac{\mu g}{g} \right) \times BMF_t. \quad (5)$$

## Results and Discussion

Table 3 compares the predicted low and high values of total PCBs and TEQs from dioxins and furans to the lowest and highest tissue levels found in the livers, and the values of MeHg in the brains, of lakeshore mink. The low predicted values were calculated using the lowest  $C_w$  found in either Luckey and Litton (2005) or in Environment Canada's 2004 survey of Lake Ontario (J. Vincent, personal communication), and assuming 50% aquatic diet and the lowest diet-to-tissue BMF calculated from the literature (Hg: Wobeser *et al.* 1976; TEQs: Heaton *et al.* 1995, Tillitt *et al.* 1996; PCBs: Bursian *et al.* 2006a, b). The high predicted values were calculated using the highest  $C_w$ , 90% aquatic diet, and highest BMF (Hg: Wobeser *et al.* 1976; TEQs: Heaton *et al.* 1995, Tillitt *et al.* 1996; PCBs: Halbrook *et al.* 1999). The measured values were provided by J. Pagano (personal communication) and will be detailed in a forthcoming report (Pagano and Haynes, in preparation).

The model worked well for dioxin/furan TEQs and for PCBs. In both cases, the predicted low and high values bounded our measured values, except for the low estimate for PCBs, which was very close to the lowest measured value in lakeshore mink. This is to be expected, as the AOC is neither the most polluted nor the cleanest portion of Lake Ontario (Luckey and Litton 2005; J. Vincent, personal communication). The model did not predict tissue levels of mercury well; the measured values were up to three orders of magnitude higher than predicted values. The reason for this discrepancy is not known. One possibility is the fact that the model is based on the octanol-water coefficient, a concept which applies only to lipophilic compounds, which mercury is not. However, Sample *et al.* (1996) apparently intended the model to be used with mercury, as they provided BAF factors for it (as well as several other heavy metals). Another possibility is that the model predicts mercury concentrations in tissue based only on aquatic exposures, while the mink in our study might have had exposure to mercury through terrestrial sources unaccounted for by the model. Further investigation and development of the model will be required if it is deemed necessary to predict mercury levels in mink of the Rochester Embayment.

## SUMMARY

The first question addressed by this study was: Which BCCs, and at what levels, are known to cause adverse effects on populations or reproduction, or to cause deformities, in mink? We found that the most sensitive endpoint for PCBs and TEQs was a squamous epithelial cell lesion in mink jawbones, corresponding to 40.2 pg TEQ/g wet weight in mink livers (Bursian *et al.* 2006a, b). We compared this level to tissue residues in Lake Ontario shoreline mink, and concluded that lakeshore mink are at risk for developing jaw lesions. We have the jaws of mink used in this study. A small amount of additional funding would permit analysis of lesions and final determination of whether mink in the Rochester Embayment AOC are adversely impacted by BCCs.

The second question addressed by this study was: How do predicted levels of BCCs in mink tissues (based on concentrations in Lake Ontario water) compare with measured tissue residues in our lakeshore mink specimens? We found that for PCBs and dioxins/furans, the model worked well, but it was less successful in predicting levels of mercury in lakeshore mink.

## ACKNOWLEDGMENTS

We are grateful to Steve Bursian, Bob Gilliam, Kurunthachalam Kannan, Fred Luckey, Gary Neuderfer, Don Tillit, Jennifer Vincent, and John Waud for providing articles or data required for this study.

## LITERATURE CITED

- Aulerich, R.J., R.K. Ringer, and S. Iwamoto. 1974. Effects of dietary mercury on mink. *Archives of Environmental Contamination and Toxicology* 2(1): 43-51
- Basu, N., A.M. Scheuhammer, S.J. Bursian, J. Elliot, K. Rouvinen-Watt, and H. M. Chan. 2006. Mink as a sentinel species in environmental health. *Environmental Research* 103: 130-144.
- Bursian, S.J., C. Sharma, R.J. Aulerich, B. Yamini, R.R. Mitchell, C.E. Orazio, D.R.J. Moore, S. Svirsky, and D.E. Tillit. 2006a. Dietary exposure of mink (*Mustela vison*) to fish from the Housatonic River, Berkshire County, Massachusetts, USA: Effects on reproduction, kit growth, and survival. *Environmental Toxicology and Chemistry* 25(6): 1533-1540.
- Bursian, S.J., C. Sharma, R.J. Aulerich, B. Yamini, R.R. Mitchell, K.J. Beckett, C.E. Orazio, D.R.J. Moore, S. Svirsky, and D.E. Tillit. 2006b. Dietary exposure of mink (*Mustela vison*) to fish from the Housatonic River, Berkshire County, Massachusetts, USA: Effects on organ weights and histology and hepatic concentrations of polychlorinated biphenyls and 2,3,7,8-tetrachlorodibenzo-*P*-dioxin toxic equivalence. *Environmental Toxicology and Chemistry* 25(6): 1541-1550.
- Bursian, S.J., K.J. Beckett, B. Yamini, P.A. Martin, K. Kannan, K.L. Shields, F.C. Mohr. 2006c. Assessment of effects in mink caused by consumption of carp collected from the Saginaw River, Michigan, USA. *Archives of Environmental Contamination and Toxicology* 50: 614-623.

- Dansereau, M., N. Lariviere, D. Du Tremblay, and D. Belanger. 1999. Reproductive performance of two generations of female semidomesticated mink fed diets containing organic mercury contaminated freshwater fish. *Archives of Environmental Contamination and Toxicology* 36: 221-226.
- Evans, R.D., E.M. Addison, J.Y. Villeneuve, K.S. MacDonald, and D.G. Joachim. 2000. Distribution of inorganic and methylmercury among tissues in Mink (*Mustela vison*) and Otter (*Lutra canadensis*). *Environmental Research Section A* 84: 133-139.
- Giesy, J.P., D.A. Verbrugge, R.A. Othout, W.W. Bowerman, M.A. Mora, P.D. Jones, J.L. Newsted, C. Vandervoot, S.N. Heaton, R.J. Aulerich, S.J. Bursian, J.P. Ludwig, G.A. Dawson, T.J. Kubiak, D.A. Best, and D.E. Tillitt. 1994. Contaminants in fishes from Great Lakes-influenced sections and above dams of three Michigan rivers. II: Implications for health of mink. *Archives of Environmental Contamination and Toxicology* 27: 213-223.
- Halbrook, R.S., L.A. Lewis, R.I. Aulerich, and S.J. Bursian. 1997. Mercury accumulation in mink fed fish collected from streams on the Oak Ridge Reservation. *Archives of Environmental Contamination and Toxicology* 33: 312-316.
- Haynes, J.M., Pagano, J.J., and Wellman, S.T. 2002. New York State Great Lakes Protection Fund Application for State Assistance—RAP Progress in the Rochester Embayment of Lake Ontario: Population Monitoring, and Levels of Bioaccumulative Chemicals of Concern in Mink, a Sentinel Species.
- Heaton, S.N., S.J. Bursian, J.P. Giesy, D.E. Tillitt, J.A. Render, P.D. Jones, D.A. Verbrugge, T.J. Kubiak, and R.J. Aulerich. 1995. Dietary exposure of mink to carp from Saginaw Bay, Michigan. 1. Effects on reproduction and survival, and the potential risks to wild mink populations. *Archives of Environmental Contamination and Toxicology* 28:334-343
- Hochstein, J.R., S.J. Bursian, and R.J. Aulerich. Effects of dietary exposure to 2,3,7,8-tetrachlorodibenzo-p-dioxin in adult female mink (*Mustela vison*). *Archives of Environmental Contamination and Toxicology* 35: 348-353.
- Hochstein, J.R., J.A. Render, S.J. Bursian, R.J. Aulerich. 2001. Chronic toxicity of dietary 2,3,7,8-tetrachlorodibenzo-P-dioxin to mink. *Veterinary and Human Toxicology* 43(3): 134-139.
- Kannan, K., A.L. Blankenship, P.D. Jones, and J.P. Giesy. 2000. Toxicity reference values for the toxic effects of polychlorinated biphenyls to aquatic mammals. *Human and Ecological Risk Assessment* 6(1): 181-201.
- Leonards, P.E.G., T.H. de Vries, W. Minnaard, and S. Stuijzand. 1995. Assessment of experimental data on PCB –induced reproduction inhibition in mink, based on an isomer- and congener-specific approach using 2,3,7,8-tetrachlorodibenzo-p-dioxin toxic equivalency. *Environmental Toxicology and Chemistry* 14(4): 639-652
- Luckey, F., and S. Litten. 2005. Bioaccumulative Contaminants in Lake Ontario Surface Water, 1999. USEPA. New York, NY.



- RAP. 1993. Stage I Remedial Action Plan for the Rochester Embayment of Lake Ontario. Monroe County Department of Health. Rochester, NY.
- RAP. 1997. Stage II Remedial Action Plan for the Rochester Embayment of Lake Ontario. Monroe County Department of Health. Rochester, NY.
- Render, J.A., J.R. Hochstein, R.J. Aulerich, and S.J. Bursian. 2000. Proliferation of periodontal squamous epithelium in mink fed 2,3,7,8-tetrachlorodibenzo-p-dioxin (TCDD). *Veterinary and Human Toxicology* 42(2): 85-86
- Render, J.A., S.J. Bursian, D.S. Rosenstein, and R.J. Aulerich. 2001. Squamous epithelium proliferation in the jaws of mink fed diets containing 3,3',4,4',5-pentachlorobiphenyl (PCB 126) or 2,3,7,8-tetrachlorodibenzo-p-dioxin (TCDD). *Veterinary and Human Toxicology* 43(1): 22-26
- Restum, J.C., S.J. Bursian, J.P. Giesy, J.A. Render, W.G. Helferich, E.B. Shipp, D.A. Verbrugge, and R.J. Aulerich. 1998. Multigenerational study of the effects of consumption of PCB-contaminated carp from Saginaw Bay, Lake Huron, on Mink. 1. Effects on mink reproduction, kit growth and survival, and selected biological parameters. *Journal of Toxicology and Environmental Health, Part A*, 54: 343-375.
- Rush, G.F., J.H. Smith, K. Maita, M. Bleavins, R.J. Aulerich, R.K. Ringer, and J.B. Hook. 1983. Perinatal hexachlorobenzene toxicity in the mink. *Env. Res.* 31:116-124.
- Sample, B.E., D.M. Opresko, and G.W. Suter II. 1996. Toxicological Benchmarks for Wildlife: 1996 Revision. Oak Ridge National Laboratory, Oak Ridge, TN.
- Tillitt, D.E., R.W. Gale, J.C. Meadows, J.L. Zajicek, P.H. Peterman, P.D. Jones, S.J. Bursian, T.J. Kubiak, J.P. Giesy, and R.J. Aulerich. 1996. Dietary exposure of mink to carp from Saginaw Bay, Michigan. 3. Characterization of dietary exposure to planar halogenated hydrocarbons, dioxin equivalents, and biomagnification. *Environmental Science and Technology* 30: 283-291.
- Wellman, S.T. and J.H. Haynes. 2006. Age, size, and stable isotope data of mink populations, and a predictive model of bioaccumulation of chemicals of concern in the Rochester embayment of Lake Ontario. Prepared for the NY Great Lakes Protection Fund, NY Department of Environmental Conservation. Buffalo, NY.
- Wobeser, G., Nielsen, N.O., Schiefer, B., 1976a. Mercury and mink. II. Experimental methyl mercury intoxication. *Canadian Journal of Comparative Medicine* 40: 34-45.
- Wren, C.D., Hunter, D.B., Leatherland, J.F., Stokes, P.M., 1987a. The effects of polychlorinated biphenyls and methylmercury, singly and in combination, on mink. I. Uptake and toxic responses. *Archiv. Env. Contamination Toxicol.* 16: 441-447.
- Wren, C.D., Hunter, D.B., Leatherland, J.F., Stokes, P.M., 1987b. The effects of polychlorinated biphenyls and methylmercury, singly and in combination on mink. II. Reproduction and kit development. *Archiv. Env. Contamination Toxicol.* 16: 449-454.

## TABLES

**Table 1.** Selected endpoints and effects levels reported for mercury, PCBs, and TEQs in mink diets and tissues. (Values in italics were estimated by the authors of this report, using the average brain:liver ratios from Evans *et al.* 2000, Wobeser *et al.* 1976, and Wren *et al.* 1987a, b.) CDD = chlorinated dibenzo dioxins, CDF = chlorinated dibenzo furans, HCB = hexachlorobenzene.

Impairment	Endpoint	Toxin	Effect Level	Conc. (ppm or ug/g)		Reference
				Diet	Tissue	
Brain						
Population	Adult mortality	Hg	LC100	5 ppm	19.9 ppm	Aulerich et al. 1974
Reproduction	Whelping reduced	Hg in fish	LOAEL	0.5 ppm	23.2 <i>ug/g</i>	Dansereau et al. 1999
Reproduction	Litter size reduced	Hg in fish	LOAEL	0.22 ppm	1.06 <i>ppm</i>	Halbrook et al. 1997
Population	Hg intoxication	MeHg	LOAEL	1.1 ppm	8.2 ppm	Wobeser et al. 1976
Reproduction	Litter size reduced	MeHg	LOAEL	1.0 ug/g	2.0 ug/g	Wren et al. 1987a,b
Liver						
Reproduction	Kit survival 3 & 6 wks	PCBs	LOAEL	720 pg/g	2190 pg/g	Heaton et al. 1995, Tillit et al. 1996
		CDDs	LOAEL	60 pg/g	2626 pg/g	
		CDFs	LOAEL	13 pg/g	335 pg/g	
		TEQs	LOAEL	22.4 pg/g	208.3 pg/g	
Deformities	Jaw lesion in 31-wk kits	PCBs	LOAEL	0.96 ug/g	1.698 ug/g	Bursian et al. 2006a, b
		TEQs	LOAEL	9.2 pg/g	40.2 pg/g	
Deformities	Jaw lesion in 27-wk kits	PCBs	LOAEL	1.1 ug/g	16 ug/g	Bursian et al. 2006c
		TEQs	LOAEL	47 pg/g	75 pg/g	
Reproduction	Litter size	PCBs	LOAEL	1360 ppb	7250 ppb	Halbrook et al. 1999
Reproduction	P-1 Whelping reduced	PCBs	LOAEL	0.25 ppm	860 ng/g	Restum et al. 1998
	F-2 Kit mortality	PCBs	LOAEL	0.5 ppm	464 ng/g	
<u>Adipose</u>						
Reproduction	Kit mortality	HCB	LOAEL	1 ppm	95 ppb	Rush et al. 1983

**Table 2.** TEQ values from dioxins and furans for Lakeshore and Inland mink livers, showing high, low and average (excluding high and low) values for each category.

Location	Value	TEQ	TEQ*2	TEQ*10
Lakeshore	Low	0.22	0.44	2.2
	Average (8)	7.75	15.50	77.5
	High	47.62	95.24	476.2
Inland	Low	0.00	0.00	0.00
	Average (8)	0.25	0.50	2.50
	High	4.16	8.32	41.6

**Table 3.** Predicted versus measured values for tissue residues of dioxin/furans (TEQs), methylmercury, and PCBs, based on water concentrations in Lake Ontario as reported by J. Vincent (2006, personal communication) and Luckey and Litton (2005).

		Water Conc.	Tissue Level	
			Predicted	Measured
BCC	Value	pg/kg	ng/g	ng/g
TEQs (liver)	Low	6.00E-05	5.52E-05	2.20E-04
	High	2.40E-02	6.21E-02	2.13E-02
MeHg (brain)	Low	0.00E+00	0.00E+00	9.00E+01
	High	1.80E+01	4.70E+00	1.55E+03
PCBs (liver)	Low	2.60E+01	1.92E+01	1.36E+01
	High	9.15E+02	1.60E+05	5.87E+03

## Appendix A: Adverse Effects Levels for Selected BCCs

**Notes**

NOAEL = No Observed Adverse Effects Level

LOAEL = Lowest Observed Adverse Effects Level

ETD = Estimated Threshold Dose; geometric mean of NOAEL and LOAEL  $=(\text{SqRt}(\text{NOAEL} \times \text{LOAEL}))$

LC10 = Concentration Lethal to 10% of population

TEQs = 2,3,7,8-Tetrachloro-dibenzi-P-dioxin equivalent units

Tissue/Diet BMF is diet-to-tissue Biomagnification Factor

*In rare cases, we have made an estimation based on reported data. Our estimations are shown in italics.*

Unless noted as "estimated by STW", all calculations are done by the authors.

NA = Not Available or Not Addressed in report

LOAELs for each report are highlighted in yellow

Estimated threshold values are highlighted in gold

<b>A-1. Adverse Effects Levels of Dioxin</b>							
<b>Endpoint</b>	<b>Toxin</b>	<b>Effect</b>	<b>Concentration</b>		<b>References</b>	<b>Notes</b>	
		<b>Level</b>	<b>Diet</b>	<b>Tissue</b>			
Adult Mortality	TCDD	NOAEL	0.1 ppb		<b>Hochstein et al. 1998</b>		
		LOAEL	1.0 ppb				
Adult Mortality	TCDD	NOAEL	0.18 ppb	N/A	<b>Hochstein et al. 2001</b>		
		LOAEL	1.40 ppb				
Kit survival @ 3 wks		NOAEL	0.0006 ppb				
		LOAEL	0.053 ppb				
Toenail deformities		NOAEL	0.18 ppb				
		LOAEL	1.40 ppb				
Jaw lesions	TCDD	NOAEL	0 ppb	N/A	<b>Render et al. 2000</b>		
		LOAEL	5 ppb				
Jaw lesions	TCDD	NOAEL	0 ppb	N/A	<b>Render et al. 2001</b>	Jaw lesions caused deformities and displacement of teeth	
		LOAEL	2.4 ppb				
Kit mortality		NOAEL	0 ppb	N/A			
		LOAEL	24 ppb				

A-2. Adverse Effects Levels of Polychlorinated Biphenyls									
Impairment	Endpoint	Toxin	Effect	Concentration		References	Notes	Tissue/Diet	
			Level	Diet	Tissue			BMF	
Reproduction	Kit survival reduced	PCBs	NOAEL	1.6 ug/g	3.083 ug/g	<b>Bursian et al. 2006i, 2006ii</b>			
		PCBs	LOAEL	3.7 ug/g	3.133 ug/g			1.9	
		PCBs	ETD	2.4 ug/g				0.8	
		PCBs	LC10	0.231 ug/g			calc. by STW from report data		
		PCBs	LC20	0.984 ug/g			estimated by regression analysis		
		TEQs	NOAEL	16.1 pg/g	55.9 pg/g		estimated by regression analysis		
		TEQs	LOAEL	68.5 pg/g	218.4 pg/g			3.5	
		TEQs	ETD	33.2 pg/g				3.2	
Deformities	Jaw lesion in 31-wk kits	PCBs	LOAEL	0.96 ug/g	1.698 ug/g			1.8	
		TEQs	LOAEL	9.2 pg/g	40.2 pg/g			4.4	
Reproduction	Reproduction and kit survivability				<b>Liver</b>	<b>Bursian et al. 2006iii</b>	Reproduction effects measured included breeding success, whelping success, gestation length, and litter size.		
		PCBs	NOAEL	1.7 ug/g	NA				
Deformities	Jaw lesion in 27-wk kits	TEQs	NOAEL	73 pg/g	NA				
		PCBs	NOAEL	0.83 ug/g	8.1 ug/g	Jaw lesions can lead to displaced and loose teeth (see Render et al 2000, 2001)	9.8		
		PCBs	LOAEL	1.1 ug/g	16 ug/g		14.5		
		TEQs	NOAEL	28 pg/g	28 pg/g		1.0		
TEQs	LOAEL	47 pg/g	75 pg/g						
Reproduction	Litter size				<b>Liver</b>	<b>Halbrook et al. 1999</b>	PCBs = Aroclor 1260 equivalents, in fish		
		PCBs	NOAEL	1009 ppb	<5 ppb				
		PCBs	LOAEL	1360 ppb	7250 ppb			Results may have been confounded by presence of Hg in fish (Halbrook et al 1997)	5.3
					<b>Adipose</b>				
			NOAEL	1009 ppb	105860 ppb		105.0		
			LOAEL	1360 ppb	128630 ppb		95.0		

					Liver	Martin et al. 2006				
Metabolic	Plasma T4 increase in 6-wk kits	TPCBs	NOAEL	0.03 mg/kg	0.19 ug/kg				6.3	
			LOAEL	0.83 mg/kg	4.38 ug/kg				5.3	
			TEQs	NOAEL	3.4 ng/kg		3.1 pg/kg			0.9
				LOAEL	27.9 ng/kg		72 pg/kg			2.6
	Plasma T3 decrease in 27- wk juveniles	TPCBs	NOAEL	1.05 mg/kg	16.25 ug/kg			Many of our mink were only a month or two older than these juveniles	15.5	
			LOAEL	1.69 mg/kg	17.79 ug/kg				10.5	
			TEQs	NOAEL	47.6 ng/kg		74.6 pg/kg			1.6
				LOAEL	73.2 ng/kg		105.6 pg/kg			1.4
	Plasma retinol and retinyl esters decreased in 6- wk kits and 27- wk juveniles	TPCBs	NOAEL	1.05 mg/kg	Kits 10.54 ug/kg juvs 16.25 ug/kg					
			LOAEL	1.69 mg/kg	kits 18.8 ug/kg juvs 17.79 ug/kg					
			TEQs	NOAEL	47.6 ng/kg		Kits 152.4 pg/kg juvs 74.6 pg/kg			
				LOAEL	73.2 ng/kg		Kits 306.6 pg/kg juvs 105.6 pg/kg			
	Kidney retinyl esters reduced in 6-wk kits and 27-wk juveniles	TPCBs	NOAEL	0.03 mg/kg	kits 0.19 ug/kg juvs 2.57 ug/kg					
				LOAEL	0.83 mg/kg	kits 4.38 ug/kg juvs 8.14 ug/kg				

		TEQs	NOAEL	3.4 ng/kg	kits 3.1 pg/kg juvs 7.6 pg/kg			
			LOAEL	27.9 ng/kg	kits 71.2 pg/kg juvs 26.9 pg/kg			
		PCBs			<b>Liver</b>	<b>Restum et al. 1998</b>	Liver concentrations here are weighted averages of male and female values given in report	
Reproduction	Delayed estrus P-1 and F-1		NOAEL	0.0 ppm	P-1 70.7 ng/g F-1 83.2 ng/g			
			LOAEL	0.25 ppm	P-1 860 ng/g F-1 635 ng/g			P-1 =3.4 F-1 = 2.5
	Reduced mating P-1 females		NOAEL	0.5 ppm	923 ng/g			1.8
			LOAEL	1.0 ppm	1580 ng/g			1.6
	Reduced whelping P-1		NOAEL	0.0 ppm	70.7 ng/g			
			LOAEL	0.25 ppm	860 ng/g			3.4
	F-1 Kit mortality		NOAEL	0.25 ppm	635 ng/g			2.5
			LOAEL	0.5 ppm	967 ng/g			1.9
	F-1 Kit body weight		NOAEL	0.0 ppm	83.2 ng/g			
			LOAEL	0.25 ppm	635 ng/g			2.5
	F-2 Kit mortality		NOAEL	0.25 ppm	275 ng/g		No F-2 males at 0.5 ppb or above, or females at 1.0 ppb, survived to 3 weeks	1.1
			LOAEL	0.5 ppm	464 ng/g			0.9
	F-2 Kit body weight		NOAEL	0.25 ppm	275 ng/g			
			LOAEL	0.5 ppm	464 ng/g			
Deformity	Jaw lesions	PCBs	NOAEL	0 ppb	N/A	<b>Render et al. 2001</b>	Jaw lesions caused deformities and displacement of teeth	
			LOAEL	24 ppb				
Population	Kit mortality		NOAEL	0 ppb	N/A			
			LOAEL	24 ppb				

A-3. Adverse Effects Levels of Mercury									
Impairment	Endpoint	Toxin	Effect	Concentration (ppm or ug/g)		Reference s	Notes	Tissue/Diet	
			Level	Diet	Tissue			BMF	
Population		Hg			<b>Brain</b>	Aulerich et al. 1974		<b>Brain</b>	
	Adult mortality		LC100	5 ppm	19.9 ± 4.55 ppm		All mink died after 30-37 days after treatment started; treatment ended on 29th day.	4.0	
Population	Adult mortality	tHg in fish			<b>Liver</b>	Dansereau et al. 1999		<b>Liver</b>	
			LC60	1.0 ppm	96.6 ppm		In 1st generation females	96.6	
Reproduction	Whelping reduced		NOAEL	0.1	28.2 ppm		In 1st and 2nd generation females	282.0	
			LOAEL	0.5 ppm	80.4 ppm			168.0	
					<b>Brain</b>			<b>Brain</b>	
			LC60	1.0 ppm	26.0 ug/g		<i>Estimated by STW using average of Liver:Brain levels in other studies = 3.7</i>		
			NOAEL	0.1	7.6 ug/g				
		LOAEL	0.5 ppm	21.6 ug/g					
		tHg in env.        MeHg in env.		N/A	<b>Brain</b>	Evans et al. 2000			
					0.34 ± 0.24 ug/g			<i>Liver:Brain Ratio =</i>	4.5
					<b>Liver</b>				
					1.53 ± 1.24 ug/g				
					<b>Fur</b>				
					17.26 ug/g				
					<b>Brain</b>				
					0.26 ± 0.19 ug/g			<i>Liver:Brain Ratio =</i>	4.7
					<b>Liver</b>				
					1.21 ± 0.85 ug/g				
			<b>Fur</b>						
			11.25 ug/g						



Reproduction	Reduced litter Size	Hg in fish			<b>Liver</b>	<b>Halbrook et al. 1997</b>		Liver	
				0.02 ppm			0.41 ppm		20.5
				0.05 ppm			0.61 ppm		12.2
				0.09 ppm			1.06 ppm		11.8
				NOAEL	0.15 ppm		1.93 ppm		12.9
				LOAEL	0.22 ppm		3.67 ppm		16.7
							<b>Fur</b>		
					0.02 ppm		3.79 ppm		
					0.05 ppm		7.43 ppm		
					0.09 ppm		7.71 ppm		
					NOAEL		13.44 ppm		
					LOAEL		19.03 ppm		
							<b>Brain</b>		
					0.02 ppm		0.11 ppm		<i>Estimated by STW using average of Liver:Brain levels in other studies = 3.4</i>
					0.05 ppm		0.18 ppm		
			0.09 ppm	0.31 ppm					
			NOAEL	0.56 ppm					
			LOAEL	1.06 ppm					
Population	Adult mortality	MeHg			<b>Liver</b>	<b>Wobeser et al. 1976</b>	Report does not specify whether total or methyl Hg in tissues, but Hg in feed was MeHg.	<b>Liver</b>	
				NOAEL	1.1 ppm			25.4 ppm	25.4
					LOAEL		21.3ppm		21.3
							<b>Brain</b>		
					NOAEL		8.2 ppm		7.5
					LOAEL		8.2 ppm		10.4
					LC40		8.2 ppm		
					Est. Threshold		10 ppm		
	Sugg. Diag. Crit.								
					5ppm				
						Suggested diagnostic criterion			

	Classic Hg intoxication (neuro-toxicity, etc.)				<b>Liver</b>		<b>Liver</b>	
			NOAEL	0.1 ppm	0.45 ppm		4.5	
			LOAEL	1.1 ppm	25.4 ppm		23.1	
						<b>Brain</b>	<b>Brain</b>	
			NOAEL	0.1 ppm	0.1 ppm		1.0	
			LOAEL	1.1 ppm	8.2 ppm		7.5	
Population	Adult mortality	MeHg				<b>Brain</b>	<b>Brain</b>	
				NOAEL	0.5 ug/g	N/A		
				LOAEL	1.0 ug/g	15.3 ug/g		15.3
							<b>Liver</b>	<b>Liver</b>
				NOAEL	0.5 ug/g	N/A		
				LOAEL	1.0 ug/g	44.1 ug/g		44.1
				LC56	1.0 ug/g			
				LC19	1.0 ug/g			
Reproduction			Kits/female mated	NOAEL	1.0 ug/g	0.84 ug/g		
				LOAEL	1.0 ug/g	2.0 ug/g		
	Kit growth	NOAEL	1.0 ug/g	2.0 ug/g				
		NOAEL	0.5 ug/g	1.32 ug/g				
		LOAEL	1.0 ug/g	0.84 ug/g				
						<i>Liver:Brain Ratio (above)</i> =	2.9	
					<b>Wren et al. 1987i, ii</b>			
					Dietary levels are somewhat misleading because after unexpected mortalities within less than 3 months, the 1.0 ppm chow was used only every other day.			
					9 of 16 in treatment group died			
					3 of 16 in treatment group died			
					Addition of PCBs decreased effect on #kits/female mated			
					Hg without PCBs had no effect			

<b>A-4. Adverse Effects Levels of Organochlorine Pesticides</b>							
<b>Impairment</b>	<b>Endpoint</b>	<b>Toxin</b>	<b>Effect Level</b>	<b>Concentration</b>		<b>References</b>	<b>Notes</b>
				<b>Diet</b>	<b>Tissue</b>		
Population	Adult Mortality	Heptachlor	NOAEL	50 mg/kg		<b>Aulerich et al. 1990</b>	
			LOAEL	100 mg/kg			
Reproduction	Reduced number of second matings	Lindane	LOAEL	1 mg/kg bw/d		<b>Beard et al. 1997, Beard and Rawlings 1998</b>	NOAEL for all is zero, as only one concentration was tested.
	Reduced whelping (incl. embryo loss)		LOAEL	1 mg/kg bw/d			
	Increase duration of pregnancy		LOAEL	1 mg/kg bw/d			
	Reduced litter size (2nd generation)		LOAEL	1 mg/kg bw/d			Effect "far greater" in 2nd gen. than in 1st gen.
	Reduced testis size		LOAEL	1 mg/kg bw/d			
Reproduction	Reduced number of second matings		PCP	LOAEL	1 mg/kg bw/d		
	Reduced whelping (incl. embryo loss)	LOAEL		1 mg/kg bw/d			

	Increase duration of pregnancy		LOAEL	1 mg/kg bw/d		
	Increased prostate hyperplasia		LOAEL	1 mg/kg bw/d		
	Increased serum progesterone	Carbofuran	LOAEL	0.05 mg/kg bw/d		NOAEL for all is zero, as only one concentration was tested.
Population	Adult Mortality	HCB	NOAEL	31 ppm	<b>Bleavins et al. 1984</b>	
			LOAEL	106 ppm		
Reproduction	Litter Size (total)		NOAEL	2 ppm,		
			LOAEL	31 ppm		
	Litter Size (live)		NOAEL	2 ppm,		
			LOAEL	31 ppm		
	Kit weight (birth)		NOAEL	0 ppm		
			LOAEL	1 ppm		
	Kit weight (3 & 6 wks)		NOAEL	1 ppm		
			LOAEL	2 ppm,		
	Kit mortality (3 & 6 wks)		NOAEL	0 ppm		
			LOAEL	1 ppm		
	Adult Mortality Female		Heptachlor	NOAEL		0 ppm
		LOAEL		5 ppm		
			LC50	10.5 ppm		
	Adult Mortality Male		NOAEL	5 ppm		
			LOAEL	12 ppm		
	% Kits stillborn		NOAEL	5 ppm		
			LOAEL	12 ppm		
	Kit weight (birth)		NOAEL	5 ppm		
			LOAEL	12 ppm		
	Kit weight (3 & 6 wks)		NOAEL	0 ppm		
			LOAEL	5 ppm		
			NOAEL	5 ppm		

	Kit mortality (3 wks)		LOAEL	12 ppm			
	Kit mortality (17 wks)	HCB			<b>Adipose</b>	<b>Rush et al. 1983</b>	Tissue levels not given here were all ND (not detected)
			NOAEL	0 ppm	36 ppb		
			<b>LOAEL</b>	<b>1 ppm</b>	<b>95 ppb</b>		
				5 ppm	626 ppb		
					<b>Brain</b>		
				5 ppm	36 ppb		
					<b>Liver</b>		
				<b>1 ppm</b>	<b>5.6 ppb</b>		
				5 ppm	37 ppb		
					<b>Kidney</b>		
				1 ppm	4 ppb		
				5 ppm	15 ppb		
					<b>Muscle</b>		
				1 ppm	1 ppb		
		5 ppm	8 ppb				
				<i>Estimated by STW, based on Liver:Adipose at 5 ppb dietary level.</i>			

<b>A-5. Adverse Effects Levels of Multiple Polyhalogenated Hydrocarbons</b>										
<b>Impairment</b>	<b>Endpoint</b>	<b>Toxin</b>	<b>Effect Level</b>	<b>Concentration</b>		<b>References</b>	<b>Notes</b>	<b>Tissue/Diet</b>		
				<b>Diet</b>	<b>Tissue</b>			<b>BMF</b>		
					<b>Liver</b>					
Reproduction	Gestation length	PCBs	NOAEL	0.015 ug/g	90 pg/g	<b>Heaton et al. 1995, Tillit et al. 1996</b>	Mink were fed fish from Saginaw Bay which contained PCBs, dioxins (CCD), and furans (CDF) (and other BCCs).	6		
		CDDs		42 pg/g	617 pg/g			14.7		
		CDFs		1 pg/g	6 pg/g			6		
		PCBs	LOAEL	.72 ug/g	2190 pg/g			3		
		CDDs		60 pg/g	2626 pg/g			43.8		
		CDFs		13 pg/g	335 pg/g			25.8		
		TEQs	NOAEL	0.9 pg/g	17.5 pg/g			10.7		
		TEQs	LOAEL	22.4 pg/g	208.3 pg/g			16.7		
		Ave. litter size	PCBs	NOAEL	1.53 ug/g			3050 pg/g	Values for TEQs calculated by STW from Table 8 of Tillit et al (1996) using WHO TEQs from van den Berg et al (1998), per D. Tillitt's suggestion (2006, pers. comm.).	2
			CDDs		46 pg/g			2329 pg/g		50.6
	CDFs			20 pg/g	551 pg/g	27.6				
	PCBs		LOAEL	2.56 ug/g	6270 pg/g	2.4				
	CDDs			84 pg/g	3002 pg/g	35.7				
	CDFs			43 pg/g	914 pg/g	21.2				
	TEQs		NOAEL	43.4 pg/g	321.6 pg/g	14.5				
	TEQs		LOAEL	86.8 pg/g	560.1 pg/g	11.1				
	No. live kits	PCBs	NOAEL	1.53 ug/g	3050 pg/g					
		CDDs		46 pg/g	2329 pg/g					
		CDFs		20 pg/g	551 pg/g					
		PCBs	LOAEL	2.56 ug/g	6270 pg/g					
		CDDs		84 pg/g	3002 pg/g					

		CDFs		43 pg/g	914 pg/g			
		TEQs	NOAEL	43.4pg/g	321.6 pg/g			
		TEQs	LOAEL	86.8pg/g	89560 pg/g			
	Kit body wt birth	PCBs	NOAEL	.72 ug/g	2190 pg/g			
		CDDs		60 pg/g	2626 pg/g			
		CDFs		13 pg/g	335 pg/g			
		PCBs	LOAEL	1.53 ug/g	3050 pg/g			
		CDDs		46 pg/g	2329 pg/g			
		CDFs		20 pg/g	551 pg/g			
		TEQs	NOAEL	22.4 pg/g	208.3 pg/g			
		TEQs	LOAEL	43.4 pg/g	321.6 pg/g			
		Kit body wt 3 & 6 wks	PCBs	NOAEL	.015 ug/g	90 pg/g		
			CDDs		42 pg/g	617 pg/g		
	CDFs			1 pg/g	6 pg/g			
	PCBs		LOAEL	.72 ug/g	2190 pg/g			
	CDDs			60 pg/g	2626 pg/g			
	CDFs			13 pg/g	335 pg/g			
	TEQs		NOAEL	0.9 pg/g	17.5 pg/g			
	TEQs		LOAEL	22.4 pg/g	208.3 pg/g			
	Kit survival 3 & 6 wks	PCBs	NOAEL	.015 ug/g	90 pg/g			
		CDDs		42 pg/g	617 pg/g			
		CDFs		1 pg/g	6 pg/g			
		PCBs	LOAEL	.72 ug/g	2190 pg/g			
		CDDs		60 pg/g	2626 pg/g			
		CDFs		13 pg/g	335 pg/g			
		TEQs	NOAEL	0.9 pg/g	17.5 pg/g			
		TEQs	LOAEL	22.4 pg/g	208.3 pg/g			

**References  
Used in  
Appendix A.**

To avoid confusion, we have used i, ii, iii, here when referring to multiple papers in the same year, as the report may have referred to them in a different order as a, b, c.

- Aulerich et al. 1974 = Aulerich, R.J., R.K. Ringer, and S. Iwamoto. 1974. Effects of dietary mercury on mink. Archives of Environmental Contamination and Toxicology 2(1): 43-51
- Aulerich et al. 1990 Aulerich, R.J., S.J. Bursian, and A.C. Napolitano. 1990. Subacute Toxicity of dietary heptachlor to min (*Mustela vison*). Archives of Environmental Contamination and Toxicology. 19: 913-916
- Beard et al. 1997 = Beard, A.P., A.C. McRae, and N.C. Rawlings. 1997. Reproductive efficiency in mink (*Mustela vison*) treated with the pesticides lindane, carbofuran, and pentachlorophenol. Journal of Reproduction and Fertility 111: 21-28.
- Beard and Rawlings 1998 = Beard, A.P., and N.C. Rawlings. 1998. Reproductive effects in mink (*Mustela vison*) exposed to the pesticides lindane, carbofuran, and pentachlorophenol in a multigeneration study. Journal of Reproduction and Fertility 113: 95-104
- Bleavins et al. 1984 = Bleavins, M.R., S.J. Bursian, J.S Brewster, and R.J. Aulerich. 1984. Effects of dietary hexachlorobenzene exposure on the reproductive performance and survivability of mink and European ferrets. Arch Environ. Contam. Toxicol. 13: 357-365.
- Bursian et al. 2006i = Bursian, S.J., C. Sharma, R.J. Aulerich, B. Yamini, R.R. Mitchell, C.E. Orazio, D.R.J. Moore, S. Svirsky, and D.E. Tillit. 2006. Dietary Exposure of mink (*Mustela vison*) to fish from the Housatonic River, Berkshire County, Massachusetts, USA: Effects on reproduction, kit growth, and survival. Environmental Toxicology and Chemistry 25(6): 1533-1540.
- Bursian et al. 2006ii = Bursian, S.J., C. Sharma, R.J. Aulerich, B. Yamini, R.R. Mitchell, K.J. Beckett, C.E. Orazio, D.R.J. Moore, S. Svirsky, and D.E. Tillit. 2006. Dietary Exposure of mink (*Mustela vison*) to fish from the Housatonic River, Berkshire County, Massachusetts, USA: Effects on organ weights and histology and hepatic concentrations of polychlorinated biphenyls and 2,3,7,8-tetrachlorodibenzo-*P*-dioxin toxic equivalence. Environmental Toxicology and Chemistry 25(6): 1541-1550.
- Bursian et al. 2006iii = Bursian, S.J., K.J. Beckett, B. Yamini, P.A. Martin, K. Kannan, K.L. Shields, F.C. Mohr. 2006. Assessment of effects in mink caused by consumption of carp collected from the Saginaw River, Michigan, USA. Arch. Environ. Contam. Toxicol. 50:614-623.



- Crum et al/ 1993 = Crum, J.A. S.J. Bursian, R.J. Aulerich, D. Polin, and W.E. Braselton. 1993. The reproductive effects of dietary heptachlor in mink (*Mustela vison*). Arch. Environ. Contam. Toxicol. 24:156-164.
- Dansereau et al. 1999 = Dansereau, M., N. Lariviere, D. Du Tremblay, and D. Belanger. 1999. Reproductive performance of two generations of female semidomesticated min fed diets containing organic mercury contaminated freshwater fish. Arch. Environ. Contam. Toxicol. 36:221-226.
- Evans et al. 2000 = Evans, R.D., E.M. Addison, J.Y. Villeneuve, K.S. MacDonald, and D.G. Joachim. 2000. Distribution of inorganic and methylmercury among tissues in Mink (*Mustela vison*) and Otter (*Lutra canadensis*). Environmental Research Section A 84: 133-139.
- Halbrook et al. 1997 = Halbrook, R.S., L.A. Lewis, R.I. Aulerich, and S.J. Bursian. 1997. Mercury accumulation in mink fed fish collected from streams on the Oak Ridge Reservation. Arch. Environ. Contam. Toxicol. 33:312-316.
- Halbrook et al. 1999 = Halbrook, R.S., R.I. Aulerich, S.J. Bursian, and L.A. Lewis. 1999. Ecological risk assessment in a large river-reservoir: 8. Experimental study of the effects of polychlorinated biphenyls on reproductive success in mink. Env. Toxicol. Chem. 18(4): 649-654.
- Heaton et al. 1995 = Heaton, S.N., S.J. Bursian, J.P. Giesy, D.E. Tillitt, J.A. Render, P.D. Jones, D.A. Verbrugge, T.J. Kubiak, and R.J. Aulerich. 1995. Dietary exposure of mink to carp from Saginaw Bay, Michigan. 1. Effects on reproduction and survival, and the potential risks to wild mink populations. Arch. Environ. Contam. Toxicol. 28:334-343
- Hochstein et al. 1998 = Hochstein, J.R., S.J. Bursian, and R.J. Aulerich. Effects of dietary exposure to 2,3,7,8-tetrachlorodibenzo-p-dioxin in adult female mink (*Mustela vison*). Arch. Environ. Cont. Toxicol. 35: 348-353.
- Hochstein et al. 2001 = Hochstein, J.R., J.A. Render, S.J. Bursian, R.J. Aulerich. 2001. Chronic toxicity of dietary 2,3,7,8-tetrachlorodibenzo-P-dioxin to mink. Vet. Human Toxicol. 43(3): 134-139.
- Martin et al 2006 = Martin, P.A., G.J. Mayne, S. Bursian, V. Palace, and K. Kannan. Changes in thyroid and vitamin A status in mink fed polyhalogenated-aromatic-hydrocarbon-contaminated carp from Saginaw River, Michigan, USA. Environmental Research 101:53-67.
- Rush et al. 1983 = Rush, G.F., J.H. Smith, K. Maita, M. Bleavins, R.J. Aulerich, R.K. Ringer, and J.B. Hook. 1983. Perinatal hexachlorobenzene toxicity in the mink. Environmental Research 31:116-124.

- Render et al.  
2000 = Render, J.A., J.R. Hochstein, R.J. Aulerich, and S.J. Bursian. 2000. Proliferation of Periodontal Squamous Epithelium in mink fed 2,3,7,8-tetrachlorodibenzo-p-dioxin (TCDD). *Veterinary and Human Toxicology* 42(2): 85-86
- Render et al.  
2001 = Render, J.A., S.J. Bursian, D.S. Rosenstein, and R.J. Aulerich. 2001. of Squamous epithelium proliferation in the jaws of mink fed diets containing 3,3',4,4',5-pentachlorobiphenyl (PCB 126) or 2,3,7,8-tetrachlorodibenzo-p-dioxin (TCDD). *Veterinary and Human Toxicology* 43(1): 22-26
- Restum et al.  
1998 = Restum, J.C., S.J. Bursian, J.P. Giesy, J.A. Render, W.G. Helferich, E.B. Shipp, D.A. Verbrugge and R.J. Aulerich. 1998. *Journal of Toxicology and Environmental Health, Part A*, 54: 343-375.
- Tillitt et al.  
1996 Tillitt, D.E., R.W. Gale, J.C. Meadows, J.L. Zajicek, P.H. Peterman, P.D. Jones, S.J. Bursian, T.J. Kubiak, J.P. Giesy, and R.J. Aulerich. 1996. Dietary exposure of mink to carp from Saginaw Bay, Michigan. 3. Characterization of dietary exposure to planar halogenated hydrocarbons, dioxin equivalents, and biomagnification. *Environ. Sci. Technol.* 30: 283-291.
- Wren 1987i = Wren, C.D., Hunter, D.B., Leatherland, J.F., Stokes, P.M., 1987. The effects of polychlorinated biphenyls and methylmercury, singly and in combination, on mink. I. Uptake and toxic responses. *Arch. Environ. Contam. Toxicol.* 16, 441-447.
- Wren 1987ii = Wren, C.D., Hunter, D.B., Leatherland, J.F., Stokes, P.M., 1987. The effects of polychlorinated biphenyls and methylmercury, singly and in combination on mink. II. Reproduction and kit development. *Arch. Environ. Contam. Toxicol.* 16, 449-454.
- Wobeser et al.  
1976 = Wobeser, G., Nielsen, N.O., Schiefer, B., 1976. Mercury and mink. II. Experimental methyl mercury intoxication. *Can. J. Comp. Med.* 40, 34-45.

**Appendix 5.** Mink jaw deformities in relation to total PCBs and TEQs in their tissues. Mink 17 had multiple proliferative squamous cysts from incisor to molar on the mandible and both maxillae. na = not analyzed, nd = not detected, us = unsuitable sample.

<b>AOC-Lakeshore</b>				<b>Deformities</b>		
	<b>Total PCB Liver</b>	<b>Adipose TEQ</b>	<b>Liver TEQ</b>	<b>Mandible</b>	<b>Left Maxilla</b>	<b>Right Maxilla</b>
<b>Mink</b>	ng/g ww	pg/g ww	pg/g ww			
17	5870.8	338.98	21.26	Yes	Yes	Yes
20	86.4	na	Na			
21	682.0	nd	3.50	us	No	No
22	2388.8	22.38	47.62			
38	213.6	10.79	0.30			
39	35.3	1.24	1.17			
41	32.2	3.59	Nd			
56	14.7	7.66	nd	us	No	No
57	153.4	10.23	nd			
58	96.4	16.07	nd			
<b>AOC-Inland</b>						
1	8.5	0.03	0.10	No	No	No
23	18.1	na	na			
24	27.3	3.99	0.64			
43	29.7	1.63	nd			
44	13.4	0.31	nd			
45	28.8	3.23	nd			
59	10.6	3.38	nd			
60	12.8	3.99	nd			
61	64.2	8.96	nd	No	No	Us
62	250.5	12.57	4.16			
63	554.4	9.13	nd	No	No	No
<b>Out of AOC- Lakeshore</b>						
46	229.8	19.63	2.09	No	No	No
47	43.4	9.35	nd			
48	184.8	na	na			
49	755.0	38.29	38.31	No	No	No
50	171.2	9.22	nd			
51	411.3	30.14	nd			
52	69.1	5.43	nd			
53	13.6	5.30	0.92	No	No	No
54	66.7	3.54	nd			
55	360.0	18.03	nd			

**Out of AOC-Inland**

3	11.7	4.78	0.00			
5	10.0	na	na			
10	8.0	0.35	0.01			
11	27.8	na	na			
14	7.0	nd	0.03	us	No	No
30	45.0	na	na	No	No	No
31	31.4	na	na			
32	14.5	na	na			
33	19.3	na	na	us	No	No
34	31.7	0.79	nd			

# **Appendix C**

**Final Report: BUI Delisting Studies in the Rochester Embayment  
AOC, 2013 – 2014. SUNY Brockport, December 2015**

---

## **Final Report: BUI Delisting Studies in the Rochester Embayment AOC, 2013-2014**

James M. Haynes and Sara T. Wellman  
The College at Brockport, SUNY  
350 New Campus Drive  
Brockport, NY 14420-2973

December 2015

### **Executive Summary**

1. Substantial evidence of live mink was observed along the shoreline of the Genesee River portion of the RE AOC, which supports delisting the “mink are present and are reproducing” criterion of the Degradation of Fish and Wildlife Populations and the Loss of Fish and Wildlife Habitat BUIs.
2. According to the USFWS Habitat Suitability Index Model, habitat appears to be highly suitable (85%) for mink along the Genesee River shoreline of the RE AOC, which supports delisting of the Loss of Fish and Wildlife Habitat BUI.
3. For total mercury chemical analysis:
  - a. No amphibian, crayfish and lower trophic level fish samples exceeded the published dietary lowest observed adverse effect level (LOAEL) for mink.
  - b. All upper trophic level fish samples exceeded the published dietary LOAEL for mink (500 ng/g), by 13% on average.
4. For PAH, PCB and dioxin (CDD)/furan (CDF) chemical analyses:
  - a. None of the 12 composited mink prey samples exceeded dietary LOAELs for total PCBs (960,000 pg/g) and TEQ for CDD/CDF (9.2 pg/g).
  - b. Ten of the 12 samples did not exceed the dietary LOAEL for PAHs, co-planar PCBs, and CDD/CDF combined (9.2 pg/g).
  - c. One upper trophic level fish sample exceeded the dietary LOAEL for PAHs by 147% because it contained ~100 times more PAHs (which accounted for 95% of total TEQ in that sample) than the other two samples.
  - d. One lower trophic level fish sample exceeded the dietary LOAEL for PCB TEQ by 4% because it contained ~90 times more PCB 126 (which accounted for 93% of total TEQ in that sample) than the other two samples.
5. Mink hazard assessment:
  - a. Using the “highest exposure” mink diet found in published literature (92% from aquatic sources), and using mean concentrations of BUI contaminants found in

potential mink prey in the Genesee River portion of the RE AOC, the maximum dietary exposure of mink would be 81% of the LOAEL for total mercury, 23% of the LOAEL for total PCBs, and 69% of the LOAEL for total TEQ (PAHs + CDD/CDF + co-planar PCBs). This is the “worst case” diet scenario.

- b. Using the average of six mink diets reported in published literature (65% from aquatic sources) comparable to what mink would eat in the Genesee River portion of the RE AOC, and using mean concentrations of BUI contaminants found in potential mink prey in the study area, the dietary exposure of mink would be 48% of the LOAEL for total mercury, 13% of the LOAEL for total PCBs, and 40% of the LOAEL for total TEQ. This is the “likely” diet scenario.
6. It would be reasonable to delist the Bird or Animal Deformities or Reproductive Problems BUI in the RE AOC because:
- a. Except for total mercury (13% above) and total TEQ (3.4% below; CDD/CDF, PAH and co-planar PCB TEQ combined) in upper trophic level fish, mean concentrations of BUI contaminants in the other three mink prey groups (crayfish, amphibians, lower trophic level fish) were far below dietary LOAELs for mink.
  - b. Using a worst case diet (92% aquatic) for mink, and the analytically-determined mean concentrations of BUI contaminants in potential prey, a hazard assessment showed that the dietary LOAELs for total mercury, total PCBs, and total TEQ would not be exceeded for mink in the Genesee River portion of the RE AOC.

## **Introduction**

The Rochester Embayment Area of Concern (RE AOC) is located north of the City of Rochester, New York, and includes the 35-mi<sup>2</sup> portion of Lake Ontario south of a line between Bogus Point in the Town of Parma and Nine Mile Point in the Town of Webster (both in Monroe County, NY), adjacent wetlands and bays, and the 6-mile reach of the Genesee River from the river’s mouth at Lake Ontario to the Lower Falls in Rochester (Figure 1). Most of the river corridor in the AOC is urban, commercial or residential but the steep gorge makes access by foot challenging. The river has high boat traffic in summer (recreation) and fall (salmon fishing). Our study focused on mink prey in the Genesee River portion of the AOC, while an earlier study (Haynes et al. 2007) focused on mink in the Braddock Bay Fish and Wildlife Management Area in the western portion of the AOC. Both studies will be used to support delisting of the “Loss of Fish and Wildlife Habitat,” “Degradation of Fish and Wildlife Populations” and “Bird or Animal Deformities or Reproductive Problems” Beneficial Use Impairments (BUI) in the RE AOC.

The known or suspected chemicals thought to cause the “Degradation of Fish and Wildlife Populations” and “Bird or Animal Deformities or Reproductive Problems” BUIs are mercury, polychlorinated biphenyls (PCBs), dioxins (CDD)/furans (CDF) and the pesticide mirex (Ecology and Environment 2009; Table 1). Polycyclic aromatic hydrocarbons (PAHs) are

also present in the RE AOC. Although they are not listed as a known or suspected BUI, their concentrations and potential for adverse effects were evaluated in this study. The approach for addressing the BUI delisting criteria for the Genesee River portion of the RE AOC was two-fold:

1. Conduct mink habitat and population assessments.
2. Determine whether “Levels of [BUI contaminants] measured in the tissue of resident prey are below those known to be associated with mink reproductive failure.” Based on current knowledge, the BUI contaminants that might impair mink reproduction in the RE AOC are total PCBs, CDDs/CDFs and mercury. Pesticide residues (e.g., mirex) are not a concern for mink reproduction (Giesey et al. 1994), while the status of PAHs was established during this study by literature review and prey tissue analysis.

The approach of sampling mink prey, but not mink, was adopted for two reasons:

1. It was uncertain whether enough mink could be trapped in the study area to obtain a statistically defensible sample size for chemical analyses of their tissues.
2. Access by boat to trapping areas along the river during the icy winter trapping season would have been dangerous for the field crew.

#### *Research questions*

1. Are mink or their signs observed in the Genesee River portion of the RE AOC?
2. What is the extent and quality of mink habitat in the Genesee River portion of the RE AOC?
3. Are concentrations of PCBs, CDDs/CDFs, PAHs and mercury measured in the tissue of resident prey below those known to be associated with mink reproductive failure?

### **Methods**

#### *Mink and their signs in the lower Genesee River portion of the RE AOC*

Twenty “black trakka” traps purchased from a supplier in New Zealand and marked with mink scent by the field crew were set out in likely mink microhabitats from August 7 through October 2, 2013 (Figure 2). These non-lethal traps are designed for animals to walk through a tunnel and leave foot prints on clean paper after stepping on inked paper. Traps and the muddy areas around them were checked once or twice weekly for mink prints.

#### *Extent and quality of mink habitat in the lower Genesee River portion of the RE AOC*

Google Earth and Pictometry.org images from the southern extent of continuous boat docks ~1.5 km upstream from Lake Ontario to the rapids ~0.5 km downstream from the Lower Falls of the Genesee River were examined to evaluate potential mink habitat in the study area. In August and September 2013 an experienced mink trapper and the project field crew leader made detailed habitat observations, by boat and on foot, within ~100m of the shoreline along the river (Figure 3). The U.S. Fish and Wildlife Service’s (USFWS) Habitat Suitability Index (HSI) model



for mink (Allen 1986) was used to estimate habitat suitability at 41 sites. In addition, the trapper gave an experience-based HSI for mink (i.e., likelihood of successfully trapping mink) for each site. Both indices were on scales of 0-1. During habitat suitability surveys each site also was checked for signs of mink (e.g., foot prints, scats, dens).

#### *Stable isotope analysis to determine mink prey trophic levels*

Stable isotopes of nitrogen are used to evaluate trophic webs of ecosystems to give lifetime, integrated estimates of trophic level for organisms (DeNiro and Epstein 1978, Cabana and Rasmussen 1994).  $^{14}\text{N}$  has a stable, heavier isotope ( $^{15}\text{N}$ ) which occurs naturally, and the heavier and lighter isotopes are differentially absorbed and metabolized by organisms (Fry 1991). Usually the lighter isotope is excreted preferentially, leading to a relative enrichment of the heavier isotope in organisms relative to their environment or diet. This enrichment is measurable through mass spectrometry, and is reported in parts per thousand ( $\delta\text{‰}$ ) relative to a standard:  $\delta X = [(R_{\text{sample}} - R_{\text{standard}}) - 1] \times 10^3$ , where  $X$  is  $^{15}\text{N}$  and  $R$  is the corresponding ratio of  $^{15}\text{N}/^{14}\text{N}$ . The standard for nitrogen is atmospheric nitrogen (Fry 1991).

Selective excretion of  $^{14}\text{N}$  over  $^{15}\text{N}$  by animals results in an increase of approximately 3.4‰ in the  $\delta^{15}\text{N}$  at each trophic level; thus,  $^{15}\text{N}$  analysis can determine the average trophic level at which an animal feeds (Peterson and Fry 1987, Cabana and Rasmussen 1994).

Trophic levels vary from 1 (herbivores) to 6 (apex predators.) Mink in riparian areas often eat amphibians, crayfish and fish (USEPA 1993). Three samples each of amphibians, crayfish, lower trophic level fish and upper trophic level fish were collected in the study area from 7 August 2013 through 2 August 2014. Frozen, composited, 10g samples of muscle tissue from amphibians (7-16 animals/sample), crayfish (52-73/sample), lower trophic level fish (10/sample) and upper trophic level fish (5/sample) were analyzed by the Cornell Stable Isotope Laboratory (COIL) for isotopic ratios of  $^{15}\text{N}/^{14}\text{N}$  ( $\delta\text{N}$ ) to determine average prey trophic levels.

#### *PCB, CDD/CDF, PAH and mercury concentrations in the tissues of potential mink prey*

Frozen, composited, >70g samples of each prey group sample (N=12: 4 prey types\*3 samples each) were sent to ALS Global Environmental. Each of the 12 prey samples was homogenized, and separate aliquots were analyzed for total mercury (USEPA Method 1631app) and PAH (USEPA Method 8270D), PCB (USEPA Method 1668A) and CDD/CDF (USEPA Method 1613B) congeners in Kelso, WA or Houston, TX. Data were reported for 18 PAH congeners, seven of which had RFP  $\geq 0.0000019$ ; total PCBs, including 15 congeners with TEQ  $\geq 0.01$ ; and total CDD/CDF, including 15 congeners with TEQ  $\geq 0.01$  (Appendix C).

#### *Mink hazard assessment*

Concentrations of total mercury, total PCBs and total toxic equivalents (TEQ for PAHs, CDDs/CDFs and co-planar PCBs combined) found in mink prey were used to estimate the maximum potential dietary exposure of mink in the Genesee River portion of the RE AOC. TEQ (where 2,3,7,8-TCDD = 1) for CDD/CDF and PCB congeners were calculated using values from

Van den Berg *et al.* (2006). TEQ for PAH congeners was calculated using relative potency (REP) values from Villeneuve *et al.* (2002). TEQ was summed separately for CDD/CDF, PCBs and PAHs then all categories were summed to yield total TEQ for each prey group sample.

USEPA (1993) reported the results of 17 studies of mink diet at 25 different locations where the portion of the diet from aquatic sources ranged from 13.4% to 92%. The maximum potential exposure of mink to BUI contaminants in RE AOC water would be represented by the study on a river in lower Michigan (Alexander 1977 cited by USEPA 1993), consisting of 57.5% upper trophic level fish, 27.5% lower trophic level fish, 4% crustaceans and 3% amphibians (total 92% aquatic), and 8% “other” (birds, mammals, vegetation, and unidentified). We used these dietary percentages to represent a realistic “worst-case” dietary exposure to total mercury, total PCBs and total TEQ for mink in the RE AOC. We then averaged the results from the six most relevant diet studies (for mink living along rivers and streams) cited by USEPA (1993; studies averaged were Hamilton 1940, Korschgen 1958, Cowan and Reilly 1973, Alexander 1977a, b, and Burgess and Bider 1980). For each prey category, we averaged the proportion of that category from all six studies to get a “typical” proportion of the diet for that category. A “typical” riparian mink’s diet consists of 35.8% upper trophic level fish, 14.6% lower trophic level fish, 10.9% crustaceans and 8.7% amphibians, with a total of 65% from aquatic sources.

Dietary exposures of mink in the RE AOC were estimated by multiplying the average concentration of each BUI contaminant in each of the four prey groups by the corresponding portion of mink diet, and summing the results. We did these calculations twice: 1) for the worst-case diet Alexander (1977, in USEPA 1993), and 2) for the typical diet represented by the average of the six studies. Maximum estimated dietary exposures were then compared to published lowest observed adverse effect levels (LOAEL) reported by Haynes *et al.* (2007). The trophic levels calculated for each prey group were multiplied by that prey group’s proportion in the diet (the non-aquatic portion of each diet was assumed to be trophic level 1), and the results were summed to estimate the trophic levels of diets 1 and 2 above. The estimated dietary trophic levels were then used in a hazard estimate by comparison with known trophic levels of mink (hence diet) determined in the western RE AOC by Haynes *et al.* (2007).

## **Results**

### *Mink and their signs in the lower Genesee River portion of the RE AOC*

Although no mink walked through the traps and left inked tracks behind, definite evidence of mink was found 15 times (9.4% of 160 trap-checking days) on (muddy tracks) or around (foot prints) 10 of the 20 traps set throughout the study area (Figure 2). Three other sets of potential mink tracks near traps could not be identified definitively. One live mink, swimming across the river, was observed by the field crew (Appendix A).

### *Extent and quality of mink habitat in the lower Genesee River portion of the RE AOC*

Much of the area within a minimum of 100m of the shoreline, on both the east and west banks of the river, appeared to be suitable mink habitat (Appendix B, Figure 3). USFWS HSI

model values averaged  $0.85 \pm 0.29$  (standard deviation), with 1 as optimum habitat. According to the three criteria used in the USFWS HSI model (percent of surface water, percent vegetation cover within 30m of the shoreline, and percent shoreline cover within 1m of surface water) nearly all habitat in the study area was suitable for mink. Based on long experience the professional trapper rated average mink habitat suitability at  $0.43 \pm 0.24$ . The trapper's lower scores ( $P < 0.0001$ , Paired T-Test; Statistix 2013) were based on steep, rocky slopes and evidence of much human disturbance (e.g., trails, fire pits, trash, fishing paraphernalia) along many sections of the shoreline.

#### *Species composition and trophic levels of samples of potential mink prey*

Three species of amphibians were collected: green frog, *Lithobates* (formerly *Rana*) *clamitans*, leopard frog, (*L. pipiens*) and American toad (*Anaxyrus americana*). Three species of crayfish were sampled: >96% were northern clearwater crayfish (*Orconectes propinguus*) and the rest were six white river crayfish (*Procambarus acutus acutus*) and one big river crayfish (*Cambarus robustus*). Lower trophic level fish species included in each composited sample were bluegill (*Lepomis macrochirus*), pumpkinseed (*L. gibbosus*) and yellow perch (*Perca flavescens*), while upper trophic level fish in each composited sample were northern pike (*Esox lucius*), largemouth bass (*Micropterus salmoides*) and smallmouth bass (*M. dolomieu*) (Table 2).

Mean trophic level ( $\delta N \pm SD$ ) was  $2.06 \pm 0.08$  for amphibians (AM),  $3.72 \pm 0.11$  for crayfish (CR),  $4.45 \pm 0.06$  for lower trophic level fish (LF), and  $4.88 \pm 0.05$  for upper trophic level (UF) fish (Table 3; Appendix C). The trophic levels of the four groups were significantly different from each other ( $P < 0.0001$ , One-way ANOVA, Tukey's HSD; Statistix 2013). Separate aliquots of the tissue samples used to determine trophic level also were analyzed by ALS Global Environmental for total mercury and PAH, PCB and CDD/CDF congeners.

#### *BUI contaminant concentrations (not lipid adjusted) in the tissue of potential mink prey*

##### Total Mercury

Concentrations of mercury in the nine samples of amphibians, crayfish and lower trophic level fish (range: 65-302 ng/g) were below (13-61%) the dietary LOAEL for mercury (500 ng/g; Dansereau *et al.* 1999). Concentrations of mercury in the three upper trophic level fish samples (range: 517-600 ng/g); all exceeded (by  $\leq 20\%$ ) the dietary LOAEL for total mercury (Table 3, Appendix C).

##### PAH Relative Potencies (REP=TEQ)

Concentrations of TEQ from PAHs (REPs from Villeneuve *et al.* 2002) in 11 of the 12 samples of amphibians, crayfish, lower trophic level fish and upper trophic level fish (range: nd-0.57 pg/g) were below (<6%) the dietary LOAEL for PAH TEQ (9.2 pg/g; Bursian *et al.* 2006). In one of the three upper trophic level fish samples (UF1) PAH TEQ (21.1 pg/g) exceeded (by 129%) the dietary LOAEL for REP/TEQ (Table 3, Appendix C).

### Total PCB

Concentrations of total PCB in the 12 samples of amphibians, crayfish, lower trophic level fish and upper trophic level fish (range: 3,950-354,000 pg/g) were below (<37%) the dietary LOAEL for total PCB (960,000 pg/g; Bursian *et al.* 2006) (Table 3, Appendix C).

### PCB TEQ

Concentrations of TEQ from PCBs in 11 of the 12 samples of amphibians, crayfish, lower trophic level fish and upper trophic level fish (range: 0.02-1.06 pg/g) were below (<12%) the dietary LOAEL for TEQ (9.2 pg/g; Bursian *et al.* 2006). In one of the three lower trophic level fish samples (LF2) PCB TEQ (9.51 pg/g) barely exceeded (3.4%) the dietary LOAEL for TEQ. One PCB congener (#126 with a toxic equivalency factor, TEF, of 0.1) was responsible for 96% (9.17 pg/g) of the PCB TEQ in sample LF2 (Table 3, Appendix C).

### CDD/CDF TEQ

Concentrations of TEQ (calculated using World Health Organization TEFs from Van den Berg *et al.* 2006) from CDD/CDF in the 12 amphibian, crayfish, lower trophic level fish and upper trophic level fish samples (range: 0.02-1.17 pg/g) were below (<13%) the dietary LOAEL for TEQ (9.2 pg/g, Bursian *et al.* 2006) (Table 3, Appendix C).

### Total TEQ

Total TEQ for 10 of the 12 samples of amphibians, crayfish, lower trophic level fish and upper trophic level fish (range: 0.21-2.16 pg/g) were below (<24%) the dietary LOAEL for TEQ (9.2 pg/g). Two samples, LF2 (10.01 pg/g) and UF1 (22.76 pg/g), exceeded dietary LOAEL for total TEQ by 9% and 147%, respectively. Samples LF2 and UF1 exceeded the 9.2 pg/g LOAEL for TEQ because of PCB 126 (95% of total TEQ) and PAHs (93% of total TEQ), respectively. On average across the three samples for each trophic level, neither lower trophic level fish ( $3.68 \pm 5.48$  pg/g) nor upper trophic level fish ( $8.95 \pm 11.96$  pg/g) exceeded the dietary LOAEL for total TEQ (Table 3, Appendix C).

### *Multivariate statistical analysis*

**Cluster Analysis:** Concentrations of all BUI contaminants found in all samples were entered into the analysis. The dendrogram (Figure 4) shows the relative distances in Euclidean space among the 12 samples. Amphibian and crayfish samples grouped together closely, although AM3 and CR3 (collected in 2014 vs. 2013, and analyzed separately from the other two samples in each prey species) were slightly separated from samples AM1&2 and CR1&2, respectively. Samples UF1 (high PAH concentrations) and LF2 (high PCB 126 concentration) were clearly separated from samples UF2&3 and LF1&3, respectively.

**Principal Component Analysis:** Principal component axes PC1 and PC2 explained 60.9% and 23.5% of the variation in BUI contaminant composition among the 12 composited prey species samples, respectively, or 84.4% of all variation in the data set, a very robust result (Table 4a). Trophic level (-0.467), total mercury (-0.551 and CDD/CDF TEQ (-0.537) had strong

associations with PC axis 1, while PAH REP (-0.644) and PCB TEQ (0.714) had strong associations with PC axis 2 (Table 4b, Figure 5). Amphibian and crayfish samples occupied the same area of multivariate space because they had very similar principal component scores, and these taxa were not strongly associated with any of the eigenvectors (important variables contributing to the distribution of samples in multivariate space) shown in Figure 5. Lower trophic level fish samples LF1&3 and upper trophic level fish samples UF2&3 each occupied their own areas in multivariate space. While samples LF1&3 were not associated with any eigenvectors, samples UF2&3 were associated with the PCB TEQ eigenvector. As in the cluster analysis, samples LF2 and UF1 each occupied a separate area of multivariate space. Sample LF2 was pulled toward the PCB TEQ eigenvector by its high PCB 126 TEQ, and sample UF1 was pulled far toward the PAH REP eigenvector. All UF samples were associated with the trophic level, total mercury and CDD/CDF TEQ eigenvectors but high PAH REP pulled sample UF1 away from samples UF2&3. In sum, the five eigenvectors all were negatively associated with PC axis 1, four of the five were negatively associated with PC axis 2, and one was positively associated with PC axis 2. Samples LF2 (PCB TEQ) and UF1, UF2 and UF3 (total mercury) had particularly strong associations with one or both of PC1 and PC2 (Table 4c, Figure 5).

#### *Mink hazard assessment*

Assuming the “worst case” mink diet: The maximum estimated dietary exposure of mink in the Genesee River portion of the RE AOC would be 407 ng/g (82% of the dietary LOAEL—500 ng/g) for total mercury, 6.2 pg/g (69% of the dietary LOAEL—9.2 pg/g) for total TEQ, and 216,071 pg/g (23% of the dietary LOAEL—960,000 pg/g) for total PCBs. The trophic level of the “worst case” diet (using average trophic levels for each prey group) would be 4.3 (Table 5).

Assuming the “typical” mink diet: The estimated actual dietary exposure in the Genesee River portion of the RE AOC would be 243 ng/g (49% of the dietary LOAEL) for total mercury, 3.6 pg/g (39% of the dietary LOAEL) for total TEQ, and 125,184 pg/g (14% of the dietary LOAEL) for total PCBs. The trophic level of the typical mink diet (using average trophic levels for each prey group) would be 3.1 (Table 5).

## **Discussion**

#### *Trophic levels of potential mink prey and estimated mink diets*

The mean trophic levels of our samples can be compared to previously measured trophic levels of Lake Ontario fish, although direct comparisons cannot be made as our samples were multiple species taken from the lower Genesee River. In Lake Ontario, the trophic levels of salmon (N= 23) averaged  $5.04 \pm 0.29$  ( $\delta N \pm SD$ ) and trophic levels of alewives (N=34) averaged  $3.75 \pm 0.18$ , respectively (Elizabeth Damaske, former SUNY Brockport M.S. student, personal communication, 2005). In the Genesee River our upper trophic level fish (UF) samples measured  $4.88 \pm 0.05$ , while lower trophic level fish (LF) measured  $4.45 \pm 0.06$ .

The trophic level of the worst-case diet, using the weighted mean of the trophic levels of mink prey taken from the Genesee River, would be 4.3. The trophic level of mink in our previous study in the western portion of the RE AOC (Haynes *et al.* 2007) ranged from 2.71 to 4.97 with an average of 3.5, corresponding to dietary trophic levels between 1.71 and 3.97 with an average of 2.5. This indicates it is unlikely that mink actually consume the worst-case diet in the AOC.

The trophic level of the literature-based typical diet, using the trophic levels of Genesee River prey, is 3.1. This agrees well with estimates found in USEPA (1995) which reported estimates for mink prey ranging from 2.5 to 2.9. Furthermore, this estimate also agrees with the results of our previous study (Haynes *et al.* 2007), falling slightly above the average for RE AOC lakeshore mink, which had a dietary trophic level of 2.8. This indicates that our “typical” diet is a good and conservative estimate of what mink are actually consuming in the RE AOC.

*BUIs: Loss of Fish and Wildlife Habitat; Degradation of Fish and Wildlife Populations*

Habitat appears to be suitable for mink along the lower Genesee River shoreline in the RE AOC, which supports delisting of the Loss of Fish and Wildlife Habitat BUI. Substantial evidence of live mink was observed along the shoreline of the study area, which supports delisting of the Degradation of Fish and Wildlife Populations.

*BUIs: Bird or Animal Deformities or Reproductive Problems, and Degradation of Fish and Wildlife Populations*

Mercury

Amphibian, crayfish and lower trophic level fish samples were all well below the dietary LOAEL for total mercury (500 ng/g), while the mean concentration of total mercury in upper trophic level fish in the Genesee River portion of the RE AOC (567 ng/g) exceeded the dietary LOAEL by 13%. Assuming that mink consume the “worst-case” diet, the maximum potential dietary exposure to total mercury would be 407 ng/g, or 81% of the dietary LOAEL. Assuming that mink consume the “typical” diet, the estimated dietary exposure to total mercury would be 48% of the dietary LOAEL.

Total PCBs and Total TEQ

Total PCB concentrations in all mink prey samples were far below the dietary LOAEL, and total TEQ was far below the dietary LOAEL in 10/12 samples. One upper trophic level fish sample (N=5 fish) exceeded the dietary TEQ (REP) LOAEL for PAHs by 129% and one lower trophic level fish sample (N=10 fish) exceeded the dietary TEQ LOAEL for PCB TEQ by 3.4%. The average total TEQ for the three upper trophic level fish samples was 97% of the dietary LOAEL (9.2 pg/g), and the average total TEQ for the three lower trophic level fish samples was 40% of the dietary LOAEL.

## Hazard Analysis

Even the worst-case estimated dietary exposure did not exceed dietary LOAELs for total mercury and total TEQ. While it is possible to construct a mink diet that would exceed the dietary LOAELs for these parameters, that diet would have a trophic level above 4.4 (all lower and upper trophic level fish in the Genesee River), which is highly unlikely (see above re: measured mink and prey trophic levels and our best estimate of mink diet in the RE AOC). Also, Haynes *et al.* (2007) found that the average concentrations of total mercury and CDD/CDF TEQ in mink caught in the Braddock Bay portion of the RE AOC, as well as in nearby sites in the Genesee River watershed and along Lake Ontario, were below the LOAEL for mink liver. These data, together with the mink prey data collected in this study, support delisting the Bird or Animal Deformities or Reproductive Problems BUI and the Degradation of Fish and Wildlife Populations BUI for mercury and total TEQ in the REAOC.

### *Evidence for point and non-point sources of BUI contaminants in the RE AOC*

According to Albers (2003) and Rice *et al.* (2003), both PAHs and CDDs/CDFs are by-products of combustion, such as in internal combustion engines, home heating systems and waste incinerators. The output of CDD/CDF from municipal waste incinerators is usually dominated by octachlorodibenzo-p-dioxin (OCDD; Rice *et al.* 2003, Gilpin *et al.* 2003). This was true for all prey samples collected in the RE AOC, in which OCDD ranged from 49-78% of the total CDD/CDF. This result strongly suggests that the majority of CDD and CDF compounds are coming from waste incinerators dispersed across the regional landscape, which amount to a non-point source for the RE AOC that cannot be remediated within the RAP context.

Because fish in the six composited samples (3 LF, 3 UF) were collected throughout the lower Genesee River study area in different months, the high concentrations of all 12 PAHs analyzed and the associated high REP in only one upper trophic level sample (UF1, 5 fish) suggests that a single fish contained the high concentrations. Two explanations may account for this finding: At least one fish in sample UF1 either 1) was exposed to a point source of PAHs, or 2) had a poorly functioning liver with regard to PAH biotransformation and excretion. PAHs do not bioaccumulate like other BUI contaminants, because higher trophic level organisms (i.e., vertebrates) are generally efficient at metabolizing PAHs (Nakata *et al.* 2003). PAH concentrations in fish are usually low (Eisler 1987), and our data show no correlation between PAH concentrations and trophic level (Figure 6). Conversely, mercury, PCBs and CDD/CDF are bioaccumulated and positively correlated with trophic level (Figure 6).

Similarly, the abundance of PCB congener 126 in sample LF2 was probably due to one fish in that composite of 10 fish after exposure to a point source or inability of the fish's liver to metabolize or excrete the congener.

## **Recommendations**

1. The Loss of Fish and Wildlife BUI delisting criterion relating to mink states that this aspect of the BUI can be considered unimpaired when it is demonstrated that:
  - Mink inhabit and reproduce within areas contiguous to the Genesee River and streams within the defined area; OR
  - Physical and biological habitat is suitable for mink.

This study found substantial evidence of live mink along the Genesee River portion of the RE AOC, and an evaluation of mink habitat using the USFWS mink Habitat Suitability Index Model found highly suitable habitat (85%) along the Genesee River shoreline of the AOC. These findings support the delisting of the Loss of Fish and Wildlife BUI. It is recommended that the Loss of Fish and Wildlife BUI be delisted if achievement of the other six delisting criteria for this BUI can also be demonstrated.

2. The Degradation of Fish and Wildlife Populations BUI delisting criterion relating to mink states that this aspect of the BUI can be considered unimpaired when it is demonstrated that:
  - Mink are present and are reproducing; OR
  - Levels of PCBs, dioxins/furans, mirex, and mercury measured in the tissue of resident mink prey are below those known to be associated with mink reproductive failure.

This study used mink diet composition assessments in literature to design a “worst-case diet” (trophic level 4.3) and a “typical diet” (trophic level 3.1) for mink in the Rochester Embayment AOC, and conducted a hazard assessment for each diet using the analytically-determined mean concentrations of BUI contaminants in the potential mink prey sampled in the AOC. Even the worst-case estimated dietary exposure did not exceed dietary LOAELs for total mercury and total TEQ. While it is possible to construct a mink diet that would exceed the dietary LOAELs for these parameters, that diet would have a trophic level above 4.4, which is highly unlikely because results of our previous study (Haynes *et al.* 2007) found that RE AOC lakeshore mink had a dietary trophic level of 2.8.

The findings of this study demonstrate the achievement of this BUI, and it is recommended that the Degradation of Fish and Wildlife Populations BUI be delisted.

3. The Bird and Animal Deformities and Reproductive Problems BUI delisting criterion is identical to the one stated above for Degradation of Fish and Wildlife Populations. It is the only delisting criterion for this BUI.

For the reasons stated above in #2, the findings of this study demonstrate the achievement of this BUI, and it is recommended that the Bird and Animal Deformities and Reproductive Problems BUI be delisted.



4. Gather information on the possible existence and determine the locations of sites near the study area with point sources of PAHs and PCB congener 126. If found, consider the feasibility of remediating the sites.

### **Acknowledgments**

We thank Anthony Marsocci who led all field activities, tabulated data collected for the RE AOC project and created Figures 2 & 3; expert mink trapper Randall Baase who evaluated mink habitat quality and found signs of live mink in the study area; Katherine Bailey who performed the multivariate statistical analyses and created Figures 4-6; and the many people who assisted field collections: Kingdon Barrett, Jennifer Curry, Kimberly Engels, Andrea Graham, Steven Hart, Christopher Hayes, Justin Hulbert, Chelsea Lipp, Nicholas Marsocci, Kelly Owens, Matthew Pavilaitis, Brendan Ryan, David Sanderson-Kilchenstein, Noelle Sofee, Tanner Squires, Anthony Tornatore, Alexander Silva, Alyssa Vogel and Cassandra Wolfanger.

### **Literature Cited**

- Albers, P. H. 2003. Petroleum and individual polycyclic aromatic hydrocarbons. Pages 341-371, *in* Hoffman, D.J., B.A Barnett, G.A.Burton, Jr., and J. Cairns, Jr. (Eds.). *Handbook of Ecotoxicology* (2<sup>nd</sup> Ed.). Boca Raton, FL: CRC Press LLC.
- Allen, A. W. 1986. Habitat Suitability Index Models: Mink, revised. U. S. Fish and Wildlife Service, Biological Report 82 (10.127). 23 pp.
- Bursian, S. J., C. Sharma, R. J. Aulerich, B. Yamini, R. R. Mitchell, C. E. Orazio, D. R. J. Moore, S. Svirsky, and D. E. Tillit. 2006. Dietary exposure of mink (*Mustela vison*) to fish from the Housatonic River, Berkshire County, Massachusetts, USA: Effects on reproduction, kit growth, and survival. *Environmental Toxicology and Chemistry* 25(6): 1533-1540.
- Cabana, G., and J. B. Rasmussen. 1994. Modeling food chain structure and contaminant bioaccumulation using stable nitrogen isotopes. *Nature* 372: 255-257.
- Dansereau, M., N. Lariviere, D. Du Tremblay, and D. Belanger. 1999. Reproductive performance of two generations of female semidomesticated mink fed diets containing organic mercury contaminated freshwater fish. *Archives of Environmental Contamination and Toxicology* 36: 221-226.
- DeNiro, M. J., and S. Epstein. 1978. Influence of diet on the distribution of carbon isotopes in animals. *Geochemica et Cosmochemica Acta* 42: 495-506.
- Ecology & Environment. 2009. Rochester Embayment Area of Concern Beneficial Use Impairment Delisting Criteria Report. Ecology & Environment, 368 Pleasant View Drive, Lancaster NY 14086.

- Eisler, R. 1987. Polycyclic aromatic hydrocarbon hazards to fish, wildlife, and invertebrates: a synoptic review. U. S. Fish and Wildlife Service, Patuxent Wildlife Research Center, Laurel, MD.
- Fry, B. 1991. Stable isotope diagrams of freshwater food webs. *Ecology* 72(6): 2293-2297.
- Giesy, J. P., D. A. Verbrugge, R. A. Othout, W. W. Bowerman, M. A. Mora, P. D. Jones, J. L. Newstead, C. Vandervoot, S. N. Heaton, R. J. Aulerich, S. J. Bursian, J. P. Ludwig, G. A. Dawson, T. J. Kubiak, D. A. Best, and D. E. Tillitt. 1994. Contaminants in fishes from Great Lakes-influenced section and above dams of three Michigan rivers. II: Implications for health of mink. *Archives of Environmental Contamination and Toxicology* 27:213-223.
- Gilpin, R.K., D.J. Wagel, and J.G. Solch. 2003. Production, distribution, and fate of polychlorinated dibenzo-*p*-dioxins, dibenzofurans, and related organohalogenes in the environment. Pages 55-87, in Schechter, A. and T.A. Gasiewicz. (Eds.), *Dioxins and Health*. Hoboken, NJ: Wiley-Interscience.
- Haynes, J. M., S. T. Wellman, and J. J. Pagano. 2007. RAP Progress in the Rochester Embayment of Lake Ontario: Population Monitoring, Trophic Relationships, and Levels of Bioaccumulative Chemicals of Concern in Mink, a Sentinel Species. Final report to the NYS Great Lakes Protection Fund. NYS Department of Environmental Conservation: Buffalo, NY. 146 pp.
- Nakata, H., Y. Sakai, T. Miyawaki, and A. Takemura. 2003. Bioaccumulation and toxic potencies of polychlorinated biphenyls and polycyclic aromatic hydrocarbons in tidal flat and coastal ecosystems of the Ariake Sea, Japan. *Environmental Science and Technology* 37: 3515-3521.
- Peterson, B. J., and B. Fry. 1987. Stable isotopes in ecosystem studies. *Annual Review of Ecology and Systematics* 18: 293-320.
- Rice, C. P., P. W. O'Keefe, and T. J. Kubiak. 2003. Sources, pathways, and effects of PCBs, dioxins, and dibenzofurans. Pages 501-573 in Hoffman, D. J., B. A. Barnett, G. A. Burton Jr., and J. Cairns Jr. (Eds.). 2003. *Handbook of Ecotoxicology* (2<sup>nd</sup> Ed.). Boca Raton, FL: CRC Press LLC.
- Statistix 10. 2013. Analytical Software. Tallahassee, FL.
- USEPA. 1993. Wildlife exposure factors handbook: Appendix: Literature review database. U. S. Environmental Protection Agency, Office of Research and Development. Washington, D.C. EPA/600/R-93/187b.
- USEPA. 1995. Great Lakes water quality criteria documents for the protection of wildlife. U. S. Environmental Protection Agency, Office of Research and Development. Washington, D.C. EPA/820/B-95/008.

- Van den Berg, M., L. S. Birnbaum, M. Denison, M. De Vito, W. Farland, M. Feeley, H. Fiedler, H. Hakansson, A. Hanberg, L. Haws, M. Rose, S. Safe, D. Schrenk, C. Tohyama, A. Tritscher, J. Tuomisto, M. Tysklind, N. Walker, and R. E. Peterson. 2006. The 2005 World Health Organization reevaluation of human and mammalian toxic equivalency factors for dioxins and dioxin-like compounds. *Toxicological Sciences* 93(2): 223-241.
- Villeneuve, D. L., J. S. Khim, K. Kannan and J. P. Giesy. 2002. Relative potencies of individual polycyclic aromatic hydrocarbons to induce dioxin-like and estrogenic responses in three cell lines. *Environmental Toxicology* 17: 128-137.

Table 1: Rochester Embayment AOC BUI Delisting Criteria related to mink (Ecology & Environment 2009).

<b>BUI</b>	<b>BUI Status</b>	<b>Delisting Criteria</b>
Bird or Animal Deformities or Reproductive Problems	Impaired	Mink are present and are reproducing, <b>OR</b> Levels of PCBs, dioxins/furans, mirex, and mercury measured in the tissue of resident prey are below those known to be associated with mink reproductive failure.
Degradation of Fish and Wildlife Populations	Impaired	SAME as above
Loss of Fish and Wildlife Habitat	Impaired	Mink inhabit and reproduce within areas contiguous to the Genesee River and streams within a defined area, <b>OR</b> Physical and biological habitat is suitable for mink.

Table 2: Sampling periods and species caught in the lower Genesee River portion of the RE AOC.

		7 Aug 2013	13-20 Aug 2013	23-28 Aug 2013	8-11 Sep 2013	15 Sep 2013	29 Sep- 5 Oct 2013	13-30 Jun 2014	26 Apr- 2 Aug 2014
<b>Amphibians</b>									
Green frog	<i>Lithobates clamitans</i>				8	9		2	
Leopard frog	<i>Lithobates pipiens</i>				4	7		3	
American toad	<i>Anaxyrus americana</i>				-	-		2	
<b>Crayfish</b>									
Northern clearwater	<i>Orconectes propinguus</i>		72				54		48
White river	<i>Procambarus a. acutus</i>		-				-		6
Big river	<i>Cambarus robustus</i>		1				-		-
<b>Lower Trophic Level Fish</b>									
Bluegill	<i>Lepomis macrochirus</i>	5		5		4			
Pumpkinseed	<i>Lepomis gibbosus</i>	4		3		5			
Yellow perch	<i>Perca flavescens</i>	1		2		1			
<b>Upper Trophic Level Fish</b>									
Northern pike	<i>Esox lucius</i>	1		1		1			
Largemouth bass	<i>Micropterus salmoides</i>	2		2		2			
Smallmouth bass	<i>Micropterus dolomieu</i>	2		2		2			

Table 3. Summary results [mean (standard deviation) of three samples] of mink prey chemical analysis. Item in bold exceeds LOAEL (lowest observed adverse effect level) from Villeneuve *et al.* 2002 and Van den Berg *et al.* 2006.

	Dietary LOAEL	Amphibian (SD)	Crayfish (SD)	Lower TL Fish (SD)	Upper TL Fish (SD)
Trophic Level ( $\delta N$ )		2.06 (0.08)	3.72 (0.11)	4.45 (0.06)	4.88 (0.05)
Total Mercury (ng/g)	500	114.67 (16.86)	74.13 (10.53)	272.00 (26.00)	<b>567.33</b> (44.23)
Total PAH REP (pg/g)	9.2	0.32 (0.22)	0.18 (0.05)	0.04 (0.07)	7.06 (12.16)
Total Dioxin/Furan TEQ (pg/g)	9.2	0.15 (0.21)	0.08 (0.06)	0.30 (0.09)	1.09 (0.08)
Total PCB (pg/g)	960,000	4,810 (1,239)	23,900 (4,468)	88,233 (15,509)	331,667 (32,808)
Total PCB TEQ (pg/g)	9.2	0.20 (0.32)	0.21 (0.25)	3.34 (5.23)	0.80 (0.29)
Total REP/TEQ (pg/g)	9.2	0.67 (0.42)	0.47 (0.30)	3.68 (5.48)	8.95 (11.96)

Table 4a: Eigenvalues for principal component axes 1 and 2 of the Principal Component Analysis of chemicals of concern in mink prey sampled in the RE AOC.

PC Axis	Eigenvalue	Percent Variation	Cumulative % Variation
1	3.05	60.9	60.9
2	1.17	23.5	84.4

Table 4b: Eigenvectors (coefficients in the linear combinations of variations making up the variables contributing to principal component axes 1 and 2) for the Principal Component Analysis of chemicals of concern in mink prey sampled in the RE AOC.

Variable	PC1	PC2
Trophic Level	-0.467	0.240
Total Mercury	-0.551	-0.059
REP for PAHs	-0.334	-0.644
TEQ for Dioxins/Furans	-0.537	-0.120
TEQ for PCBs	-0.280	0.714

Table 4c: Principal component scores for 12 mink prey samples collected in the RE AOC. Large magnitude scores strongly influencing the analysis are in bold.

Sample	PCA Score 1	PCA Score 2
Amphibian 1	1.84	-0.496
Amphibian 2	1.82	-0.535
Amphibian 3	1.30	-0.495
Crayfish 1	1.25	-0.008
Crayfish 2	1.16	-0.007
Crayfish 3	1.06	-0.002
Lower Fish 1	0.188	0.186
Lower Fish 2	<b>-0.923</b>	<b>2.32</b>
Lower Fish 3	-0.010	0.115
Upper Fish 1	<b>-3.30</b>	<b>-2.37</b>
Upper Fish 2	<b>-2.29</b>	0.581
Upper Fish 3	<b>-2.01</b>	0.836

Table 5: Trophic levels and estimated dietary exposures based on average BUI contaminant concentrations in each prey group compared to the dietary LOAEL for each BUI contaminant.

Chemical	Worst-case diet	Typical diet	LOAEL
Mercury, total, ng/g	407	242	500
TEQ, total, pg/g	6.2	3.6	9.2
TEQ, PAHs, pg/g	4.1	2.4	
TEQ, dioxins/furans, pg/g	0.7	0.4	
TEQ, PCBs, pg/g	1.4	0.8	
PCBs, total, pg/g	216,072	125,184	960,000
Trophic level	4.3	3.1	



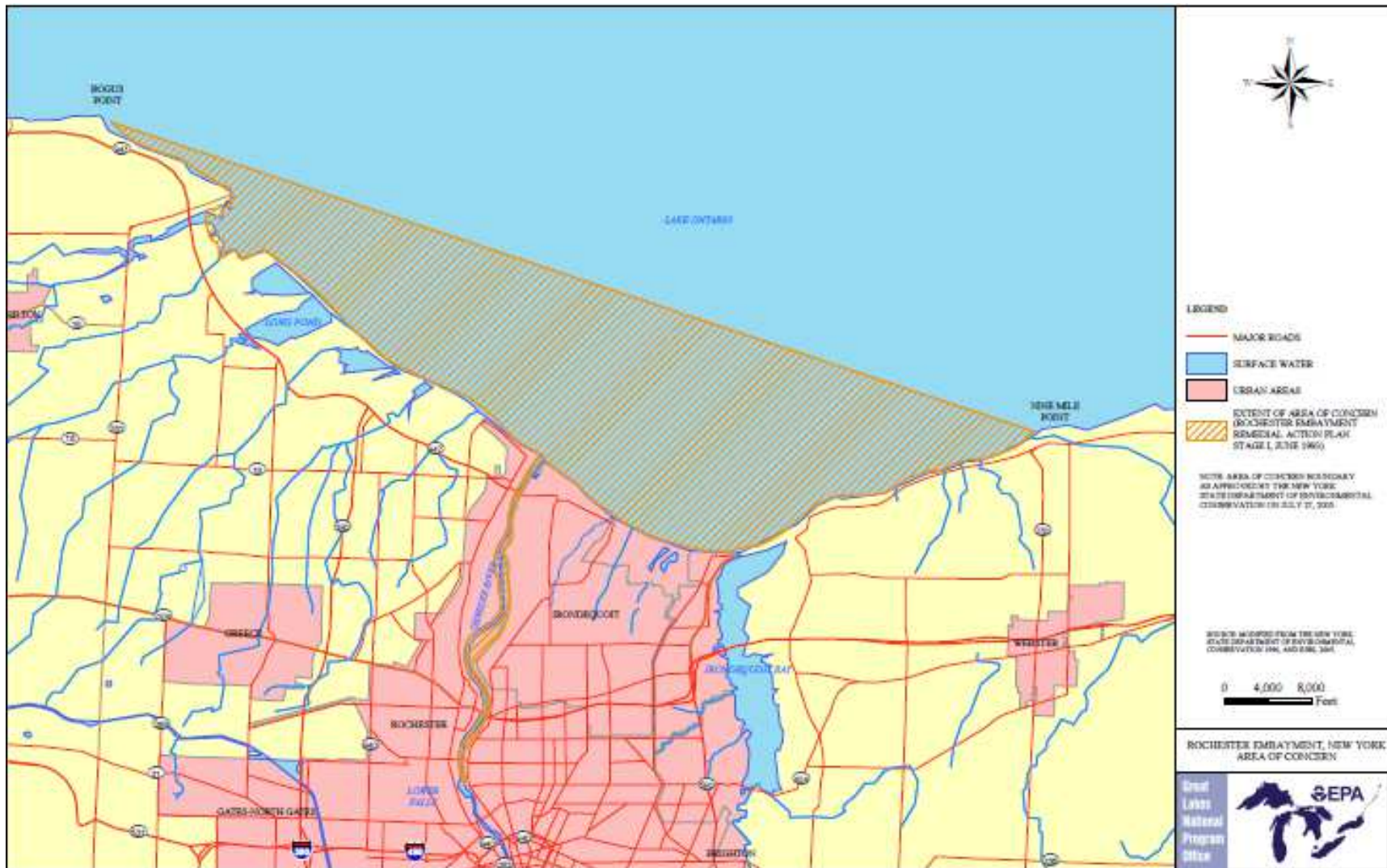


Figure 1: Rochester Embayment Area of Concern (tan). The lower Genesee River study area extends south from Lake Ontario into the City of Rochester (<http://www.epa.gov/glnpo/aoc/rochester/index.html>).

## Number of Mink Signs 2013

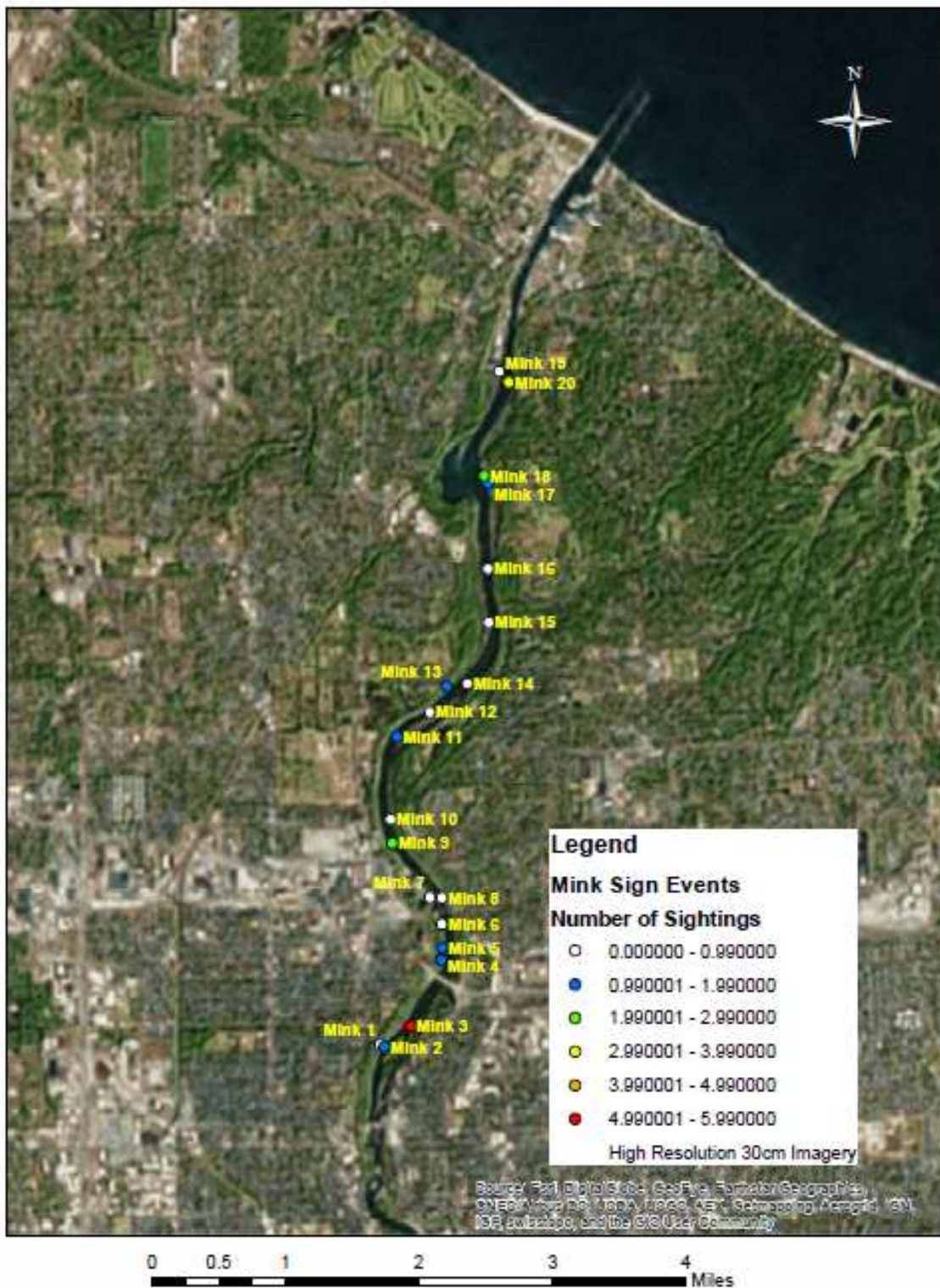


Figure 2: Sightings of mink and their signs in the lower Genesee River (see Appendix A).



# Mink HSI 2013 Full Extent



Figure 3a: Mink habitat assessment locations in the lower Genesee River (see Appendix B).

# Mink HSI 2013 Northern AOC

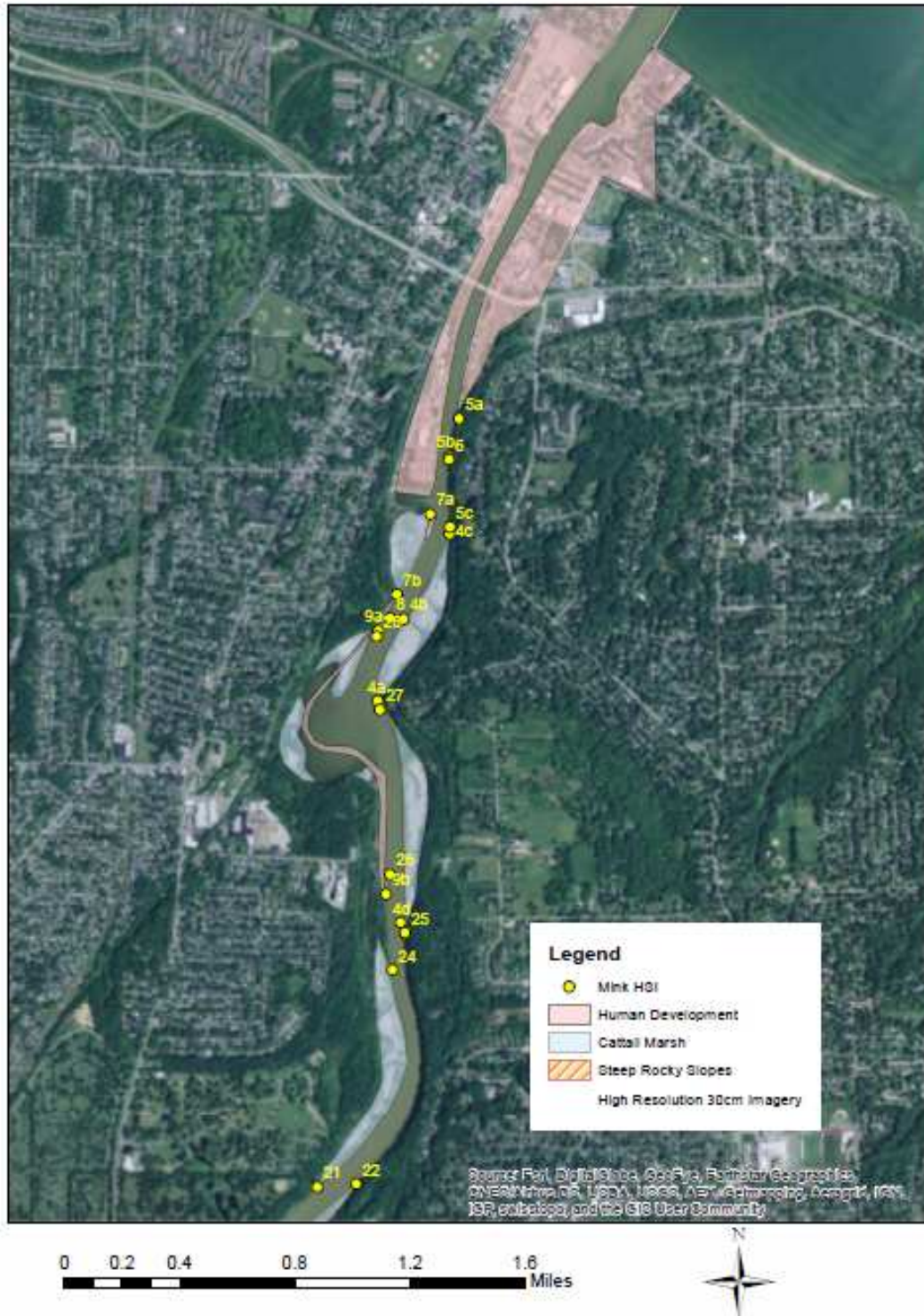


Figure 3b: Mink habitat assessment locations in the northern part of the lower Genesee River portion of the Rochester Embayment Area of Concern (see Appendix B).



# Mink HSI 2013 Southern AOC



Figure 3c: Mink habitat assessment locations in the southern part of the lower Genesee River portion of the Rochester Embayment Area of Concern (see Appendix B).

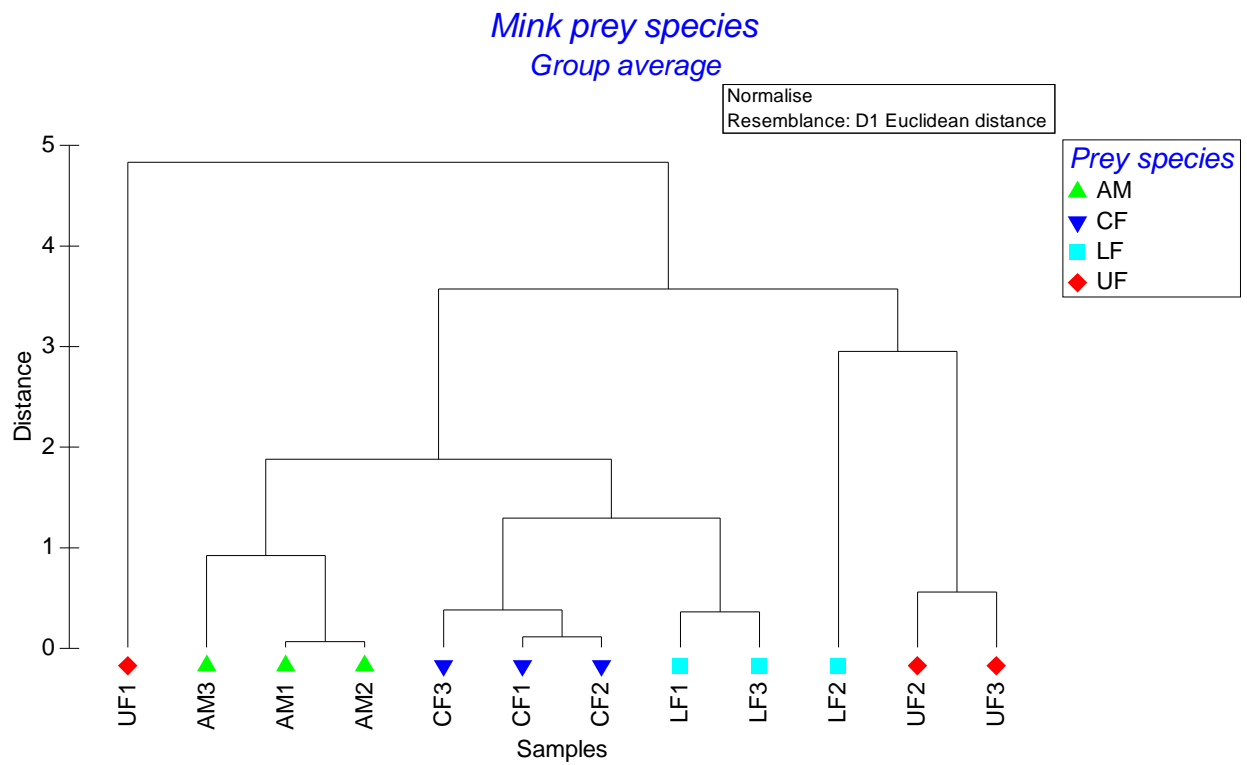


Figure 4: Cluster diagram of chemical relationships among 12 composited mink prey samples collected in 2013 and 2014.

## Mink prey trophic guilds

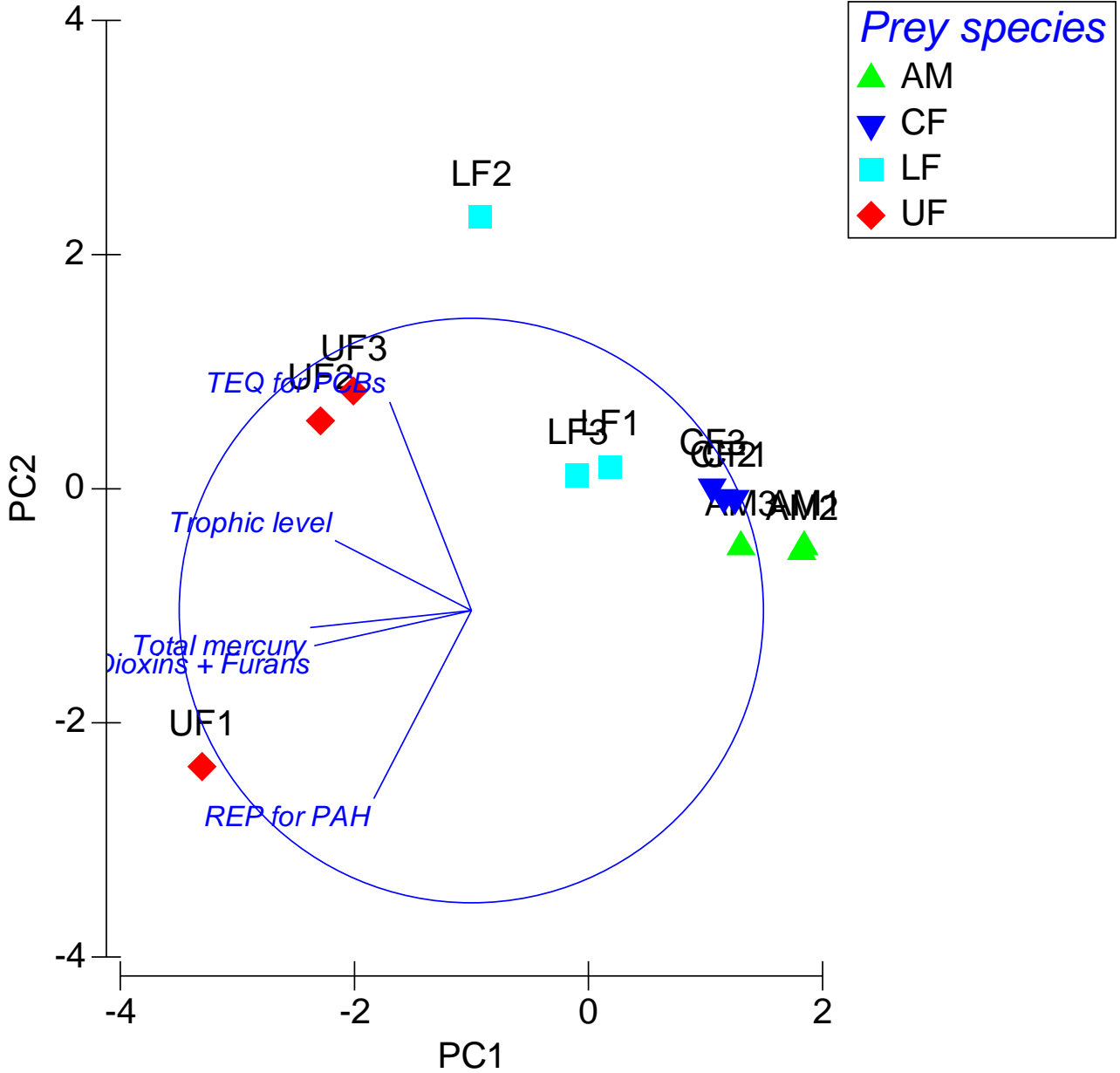


Figure 5: Principal component analysis diagram of chemical relationships in multivariate space among 12 composited mink prey samples collected in 2013 and 2014, and the variables (vectors) influencing the relationships.

*Mink prey species*

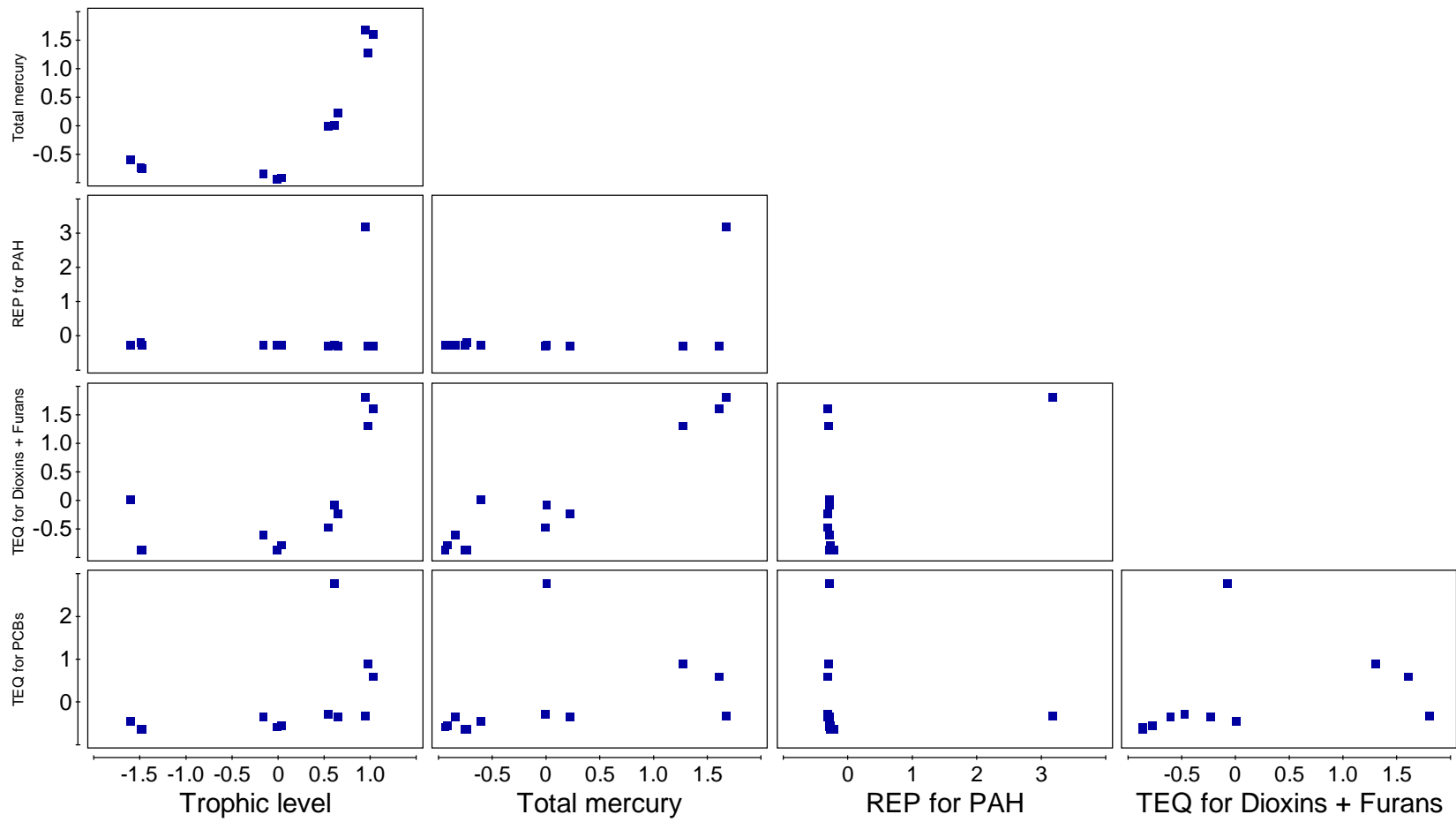


Figure 6: Relationships between pairs of variables in the multivariate analysis. Note the relatively strong relationships between PCB and CDD/CDF TEQs, and total mercury, but not for PAH REP, and trophic level.



Appendix A: Mink and their signs observed in the lower Genesee River portion of the RE AOC.

<b>Mink Sign Observations</b>	<b>Date</b>	<b>Side of River</b>	<b>Site Description</b>	<b>Signs Observed</b>
1	8/7/2013	East	Muddy Beach just before river branches around Seth Green Island	1. Trap surrounded by mink tracks
2	8/7/2013	West	Flat wooded area just before 104 bridge	2. Mink tracks on top of trap
3	8/7/2013	West	Last clump of trees upstream from Kodak WTP	3. <b>Possible</b> mink track on outside of trap
4	8/20/2013	East	Muddy Beach just before river branches around Seth Green Island	4. Multiple mink, raccoon, deer tracks in mud
5	8/20/2013	West	Last clump of trees upstream from Kodak WTP	5. Single mink track in mud 5m from trap
6	9/4/2013	East	Muddy Beach just before river branches around Seth Green Island	6. Multiple mink tracks in mud 5m from trap
7	9/4/2013	West	Small sandbar with scrubby vegetation next to wetland boat docks.	7. <b>Possible</b> mink track on trap ink card
8	9/8/2013	West	Small hardwood tree stand surrounded by cattail marsh	8. Multiple mink tracks in mud
9	9/11/2013	East	Muddy Beach just before river branches around Seth Green Island	9. <b>Probable</b> mink track in mud
10	9/25/2013	East	Muddy Beach just before river branches around Seth Green Island	10. Single mink track in mud
11	9/25/2013	West	Flat wooded area centered between Kodak bridge and 104 bridge	11. Multiple mink tracks in mud
12	9/25/2013	West	Small sandbar flat next to wetland boat docks. Scrub brush vegetation.	12. Multiple mink tracks in sand; two sizes
13	9/29/2013	East	Center of Seth Green Island. Flat wooded area with rocky beach	13. Multiple mink tracks on muddy beach
14	9/29/2013	East	Small hardwood tree stand surrounded by cattail marsh	14. Single mink track in mud
15	9/29/2013	East	Lots of woody debris and garbage accumulated in water on east side of turnaround basin. Trap on wooded shoreline	15. Multiple mink tracks in mud
16	10/2/2013	East	Small stream inlet entering east side of turnaround basin. Trap located ~100m inland along a creek bed.	16. Mink swimming across river
17	10/2/2013	East	Lots of woody debris and garbage accumulated in water on east side of turnaround basin. Trap on wooded shoreline	17. Multiple mink tracks in mud
18	10/2/2013	West	Small sandbar flat next to wetland boat docks. Scrub brush vegetation	18. Multiple mink tracks in sand

Appendix B: Extent and quality of mink habitat at 41 sites along the lower Genesee River portion of the RE AOC. USFWS HSI calculated as shown by Allen (1986). Trapper HSI estimated from 40 years of experience.

GPS Latitude	GPS Longitude	% Surface Water	% Vegetation Cover (30m)	% Shoreline Cover (1m)	USFWS HSI	Trapper HSI	Site # / Notes / Observations
4311041	7737687	100	100	10	0.32	0.30	1. ~200m downstream from Ave E bridge. No wetlands here. Sandy beach with rock rubble and woody debris.
4311058	7737650	100	95	50	0.69	0.30	2. ~150m downstream from Ave E Bridge. Gravelly beach with emergent wetland vegetation.
4311060	7737689	100	100	30	0.55	0.10	3. ~250m downstream from Ave E bridge. Rocky beach, logs, steep ~5 m embankment ~8 m from shore. Lots of trash.
4310138	7737440	100	100	30	0.55	0.20	4. ~3m cliff right at shoreline. Heavily shaded by trees, fallen logs and sparse vegetation.
4311036	7737687	100	100	80	0.89	0.30	5. Muddy beach, <i>Phragmites</i> , shrubs and tree cover.
4311099	7737686	100	100	100	1.00	0.60	6. 100% <i>Phragmites</i> , full overhead cover. ~100m cliff about ~50 m inland.
4311387	7737440	100	100	95	0.97	0.50	7. Shoreline is solid cattail with small vegetated islands of trees and shrubs. Solid ground ~10m wide. Cattail marsh ~30m wide and backs to a steep forested slope.
4313508	7736932	100	100	100	1.00	0.60	8. End of east side cattail.
4313995	7737002	100	100	100	1.00	0.50	9. 100% cattail with occasional canals about 8 feet wide. Backed up by steep forested slope after ~100m.
4314175	7736923	100	100	100	1.00	0.50	10. 100% cattail with occasional canals about 8 feet wide. Backed up by steep forested slope after ~100m.
4314363	7736786	100	100	100	1.00	0.50	11. 100% cattail with occasional canals about 8 feet wide. Backed up by steep forested slope after ~100m.
4314377	7736785	100	100	100	1.00	0.60	12. South end of habitat with dense vegetation. Steep rocky banks with plenty of fallen tree branches and other cover.
4314531	7736786	100	100	100	1.00	0.60	13. Center of habitat, rocky shelves along shoreline.
4314615	7736756	100	100	100	1.00	0.60	14. North end of eastern wooded habitat. Steep, rocky banks.

<b>GPS Latitude</b>	<b>GPS Longitude</b>	<b>% Surface Water</b>	<b>% Vegetation Cover (30m)</b>	<b>% Shoreline Cover (1m)</b>	<b>USFWS HSI</b>	<b>Trapper HSI</b>	<b>Site # / Notes / Observations</b>
4314525	7736787	100	90	100	0.95	0.60	15. Small wetland bay at the end of boat docks. Mostly shrub with human development.
4314405	7736843	100	100	100	1.00	0.60	16. Beginning of cattail marsh. Rocky shoreline about 10m behind cattails
4314229	7736944	100	100	100	1.00	0.60	17. End of cattail marsh.
4314177	7736964	100	90	50	0.67	0.40	18. Walkway bridge near turning basin. Rocky bare soil around shoreline. About 50m long. Lots of garbage
4314149	7737001	100	100	100	1.00	0.60	19. Start of cattail marsh surrounding the turning basin. Cattail marsh for about 80m then cliff with houses above.
4313570	7736977	100	100	100	1.00	0.60	20. End of the west side cattail marsh at the Stephen F. Roman concrete unloading dock.
4310931	7737689	100	100	100	1.00	0.20	21. ~30m cliffs at base of the Lower Falls. Lots of fallen trees and huge boulders.
4370928	7737681	100	100	100	1.00	0.20	22. End of rocky section between Lower Falls and Seth Green Island. Too many humans to be good mink habitat.
4311281	7737477	100	100	100	1.00	0.30	23. Seth Green Island. Muddy/rocky shore with fallen logs, overhead cover and lots of poison ivy.
4311534	7737220	100	0	0	0.00	0.00	24. 104 Bridge (Landmark Location)
4311725	7737205	100	100	100	1.00	0.80	25. POI: mink "Point of Interest" between Kodak railroad bridge and 104 bridge.
4311863	7737224	100	100	100	1.00	0.60	26. Kodak railroad bridge.
4311882	7737259	100	100	95	0.97	0.80	27. ~30 m of flat wooded area along shore with dense vegetation, plenty of cover and wet solid ground. See POI #14
4311880	7737214	100	100	100	1.00	0.80	28. Heavily wooded area with branches overhanging water's edge. Relatively steep slope with plenty of cover and possible mink denning sites. Ground dry and brushy. Rocky near water's edge.
4311882	7737259	100	100	0	0.00	0.00	29. POI: Kodak bridge and storm sewer outlet. North of #16. (For photos see #15)
4312110	7737466	100	0	0	0.00	0.00	30. Industrial infrastructure From #18 to Kodak King's Landing Wastewater Treatment Facility

<b>GPS Latitude</b>	<b>GPS Longitude</b>	<b>% Surface Water</b>	<b>% Vegetation Cover (30m)</b>	<b>% Shoreline Cover (1m)</b>	<b>USFWS HSI</b>	<b>Trapper HSI</b>	<b>Site # / Notes / Observations</b>
4312191	7737498	100	90	100	0.95	0.50	31. Heavily wooded area with branches overhanging water's edge. Relatively steep slope with plenty of cover and possible mink denning sites. Ground dry and brushy. Rocky near water's edge.
4312927	7737184	100	100	95	0.97	0.50	32. Steep heavily wooded slope.
4312933	7737066	100	100	100	1.00	0.60	33. Cattail marsh for ~30m with occasional small wooded islands, then steep wooded slope.
4312298	7737621	100	100	60	0.77	0.00	35. POI: waterfall between #19 and #21. Steep ~50m concrete storm sewer pipeline.
4313404	7736958	100	100	100	1.00	0.60	36. Cattail marsh ~50m wide backing up to steep wooded slope.
4313486	7736919	100	90	95	0.92	0.60	37. Steep wooded slope. Potential mink runways on flat rocks on shoreline
4313613	7736964	100	80	80	0.80	0.00	39. POI: Stephen F. Roman concrete delivery dock.
4313976	7736995	100	100	100	1.00	0.60	40. Cattail marsh ~30m wide backing up to steep wooded slope.
4314136	7737004	100	100	100	1.00	0.40	41. Turnaround basin with cattail marsh 10-40m wide, backing up to steep wooded slope with large docks and walking trail.
				<b>Avg. HSI</b>	<b>0.85</b>	<b>0.44</b>	
				<b>SD</b>	<b>0.29</b>	<b>0.24</b>	

Appendix C: Total mercury, PAH relative potencies (REP, Villeneuve *et al.* 2002), and CCD, CDF and PCB toxic equivalents (TEQ, Van den Berg *et al.* 1998) for twelve composite tissue samples of potential mink prey from the Genesee River portion of the RE AOC.

LOAELs taken from Dansereau et al. (1999)-Hg and Bursian et al. (2006)	Sample ID	AM1	AM2	AM3	CR1	CR2	CR3	LF1	LF2	LF3	UF1	UF2	UF3
	ALS #	-003	-004	-19.00	-001	-002	-20.00	-005	-006	-007	-008	-009	-010
	δN	7.19	7.12	6.70	12.80	12.95	12.22	14.89	15.18	15.28	16.42	16.76	16.57
	Trophic level	2.12	2.10	1.97	3.76	3.81	3.59	4.38	4.46	4.50	4.83	4.93	4.87
	% Lipid/100	0.013	0.015	0.056	0.011	0.012	0.081	0.027	0.027	0.033	0.020	0.020	0.024
Compounds													
Mercury, total (ng/g)		103.0	107.0	134.0	65.6	70.9	85.9	256	258	302	600	585	517
Dietary Hg LOAEL = 500 ng/g													
Total TEQ from PAH, CDD&F, PCB		0.29	0.61	1.12	0.21	0.38	0.80	0.47	10.01	0.55	22.76	1.93	2.16
Dietary (Prey) TEQ LOAEL = 9.2 pg/g													
PAHs (ug/kg=ng/g)	REPs												
Naphthalene		1.10	0.76	0.72	1.60	0.85	0.60	2.20	2.20	2.90	13.00	1.80	2.70
2-Methylnaphthalene		0.90	0.74	1.00	1.30	0.86	0.94	2.20	2.80	2.60	6.40	2.10	2.10
Acenaphthylene		ND	0.92	0.28	ND	ND	0.74	0.38	0.34	0.39	23.00	0.64	0.75
Acenaphthene		0.34	0.60	0.38	1.40	1.30	0.98	2.30	3.00	3.40	52.00	2.80	3.00
Dibenzofuran		0.45	0.43	0.42	ND	0.71	0.66	1.10	1.60	1.70	34.00	1.50	1.30
Fluorene		0.37	0.48	0.63	0.89	1.20	0.68	2.10	2.90	3.40	63.00	2.70	3.10
Phenanthrene		1.30	1.70	1.60	4.80	8.00	4.90	5.50	7.00	8.20	400.00	5.50	6.60
Anthracene		ND	0.53	1.00	0.69	0.94	0.53	0.76	0.86	1.50	190.00	0.85	1.20
Fluoranthene		2.40	7.10	3.20	6.00	9.20	7.30	3.70	5.00	6.10	610.00	3.30	5.80
Pyrene		2.50	11.00	2.50	4.30	6.60	4.70	1.10	1.50	6.30	380.00	1.00	3.10
Benz(a)anthracene	1.90E-06	1.40	6.20	1.00	0.98	1.70	1.20	ND	0.39	1.00	290.00	ND	1.10
Chrysene	2.30E-06	2.70	7.40	2.30	1.40	2.90	2.80	ND	1.40	1.00	260.00	ND	1.00
Benzo(b)fluoranthene	5.10E-06	2.50	8.20	2.30	1.50	2.80	2.20	ND	0.54	0.50	270.00	0.28	1.50
Benzo(k)fluoranthene	1.40E-04	1.40	3.00	0.77	0.78	1.30	0.82	ND	0.75	ND	110.00	ND	0.44
Benzo(a)pyrene	1.60E-06	1.50	5.50	1.40	0.87	1.80	2.50	ND	ND	ND	260.00	ND	0.97

LOAELs taken from Dansereau et al. (1999)-Hg and Bursian et al. (2006)	Sample ID	AM1	AM2	AM3	CR1	CR2	CR3	LF1	LF2	LF3	UF1	UF2	UF3
	ALS #	-003	-004	-19.00	-001	-002	-20.00	-005	-006	-007	-008	-009	-010
	δN	7.19	7.12	6.70	12.80	12.95	12.22	14.89	15.18	15.28	16.42	16.76	16.57
	Trophic level	2.12	2.10	1.97	3.76	3.81	3.59	4.38	4.46	4.50	4.83	4.93	4.87
	% Lipid/100	0.013	0.015	0.056	0.011	0.012	0.081	0.027	0.027	0.033	0.020	0.020	0.024
Compounds													
Indeno(1,2,3-cd)pyrene	1.50E-05	1.70	4.30	1.20	0.91	1.90	1.40	ND	0.32	ND	170.00	ND	0.79
Dibenz(a,h)anthracene	4.60E-06	0.27	1.00	0.28	ND	0.60	0.30	ND	ND	ND	45.00	ND	ND
Benzo(g,h,i)perylene		1.60	3.60	0.87	0.70	1.70	1.50	ND	0.34	ND	120.00	ND	0.76
<b>REPs from PAHs (Dietary [Prey] TEQ LOAEL = 9.2 pg/g)</b>		<b>0.25</b>	<b>0.57</b>	<b>0.15</b>	<b>0.14</b>	<b>0.24</b>	<b>0.16</b>	<b>0.00</b>	<b>0.12</b>	<b>0.01</b>	<b>21.10</b>	<b>0.00</b>	<b>0.09</b>
CDDs and CDFs (ng/kg = pg/g)	WHO TEFs												
1,2,3,4,6,7,8-Heptachlorodibenzofuran (HpCDF)	0.01	0.44	0.35	0.21	0.41	0.49	0.22	0.25	0.26	0.28	0.458	0.48	0.29
1,2,3,4,6,7,8-Heptachlorodibenzo-p-dioxin (HpCDD)	0.01	1.61	1.72	0.43	1.28	1.65	0.42	1.22	1.32	1.48	2.27	1.80	2.54
1,2,3,4,7,8,9-Heptachlorodibenzofuran (HpCDF)	0.01	ND	ND	ND	ND	ND	0.06	ND	ND	ND	ND	ND	ND
1,2,3,4,7,8-Hexachlorodibenzofuran (HxCDF)	0.1	ND	ND	0.07	ND	ND	0.05	ND	ND	ND	ND	ND	ND
1,2,3,4,7,8-Hexachlorodibenzo-p-dioxin (HxCDD)	0.1	ND	ND	0.09	ND	ND	ND	ND	ND	ND	ND	ND	ND
1,2,3,6,7,8-Hexachlorodibenzofuran (HxCDF)	0.1	ND	ND	0.06	ND	ND	ND	ND	ND	ND	ND	ND	ND
1,2,3,6,7,8-Hexachlorodibenzo-p-dioxin (HxCDD)	0.1	ND	ND	0.11	ND	ND	0.08	ND	ND	ND	0.34	ND	0.35
1,2,3,7,8,9-Hexachlorodibenzofuran (HxCDF)	0.1	ND	ND	ND	ND	0.38	ND	1.85	3.32	2.36	8.24	8.01	8.28
1,2,3,7,8,9-Hexachlorodibenzo-p-dioxin (HxCDD)	0.1	ND	ND	0.06	ND	ND	ND	ND	ND	ND	ND	ND	ND
1,2,3,7,8-Pentachlorodibenzofuran (PeCDF)	0.03	ND	ND	0.04	ND	ND	ND	ND	ND	ND	ND	ND	ND
1,2,3,7,8-Pentachlorodibenzo-p-dioxin (PeCDD)	1	ND	ND	0.13	ND	ND	0.10	ND	ND	ND	ND	ND	ND
2,3,4,6,7,8-Hexachlorodibenzofuran (HxCDF)	0.1	ND	ND	0.06	ND	ND	0.05	ND	ND	ND	ND	ND	ND
2,3,4,7,8-Pentachlorodibenzofuran (PeCDF)	0.3	ND	ND	0.09	ND	ND	ND	ND	ND	ND	0.38	0.35	ND
2,3,7,8-Tetrachlorodibenzofuran (TCDF)	0.1	ND	ND	0.09	ND	ND	0.21	ND	0.32	0.59	1.62	1.47	1.16
2,3,7,8-Tetrachlorodibenzo-p-dioxin (TCDD)	1	ND	ND	0.17	ND	ND	ND	ND	ND	ND	ND	ND	ND

LOAELs taken from Dansereau et al. (1999)-Hg and Bursian et al. (2006)	Sample ID	AM1	AM2	AM3	CR1	CR2	CR3	LF1	LF2	LF3	UF1	UF2	UF3
	ALS #	-003	-004	-19.00	-001	-002	-20.00	-005	-006	-007	-008	-009	-010
	δN	7.19	7.12	6.70	12.80	12.95	12.22	14.89	15.18	15.28	16.42	16.76	16.57
	Trophic level	2.12	2.10	1.97	3.76	3.81	3.59	4.38	4.46	4.50	4.83	4.93	4.87
	% Lipid/100	0.013	0.015	0.056	0.011	0.012	0.081	0.027	0.027	0.033	0.020	0.020	0.024
Compounds													
Octachlorodibenzofuran (OCDF)	0.0003	1.40	0.86	0.18	0.91	1.43	0.39	0.86	1.30	1.20	1.22	0.98	1.25
Octachlorodibenzo-p-dioxin (OCDD)	0.0003	13.20	8.74	2.49	12.00	17.80	5.74	7.72	11.00	13.00	27.50	15.00	19.60
Heptachlorodibenzo-p-dioxins (HpCDD), Total		11.10	0.71	0.33	1.06	1.35	1.06	0.71	2.37	2.48	4.02	1.80	2.54
Heptachlorodibenzofurans (HpCDF), Total		1.27	0.90	ND	0.41	0.88	ND	0.75	ND	0.88	1.12	1.40	0.99
Hexachlorodibenzo-p-dioxins (HxCDD), Total		ND	ND	0.24	ND	ND	0.18	ND	ND	ND	ND	ND	0.35
Hexachlorodibenzofurans (HxCDF), Total		ND	ND	0.06	ND	0.38	0.05	2.52	3.96	2.84	9.39	9.41	8.28
Pentachlorodibenzo-p-dioxin (PeCDD), Total		ND	ND	0.07	ND	ND	0.10	ND	ND	ND	ND	ND	ND
Pentachlorodibenzofurans (PeCDF), Total		ND	ND	ND	0.79	1.57	0.68	1.54	ND	ND	ND	0.66	ND
Tetrachlorodibenzo-p-dioxins (TCDD), Total		ND	ND	ND	ND	0.62	0.22	ND	ND	ND	ND	ND	ND
Tetrachlorodibenzofurans (TCDF), Total		ND	ND	ND	0.66	ND	0.46	1.06	0.32	ND	2.97	0.59	ND
<b>Total Dioxins and Furans</b>		<b>26.97</b>	<b>11.21</b>	<b>3.37</b>	<b>15.83</b>	<b>24.03</b>	<b>8.87</b>	<b>15.16</b>	<b>18.95</b>	<b>20.40</b>	<b>46.22</b>	<b>29.83</b>	<b>33.01</b>
TEQs from Dioxins and Furans		<b>0.02</b>	<b>0.02</b>	<b>0.42</b>	<b>0.02</b>	<b>0.06</b>	<b>0.14</b>	<b>0.20</b>	<b>0.38</b>	<b>0.31</b>	<b>1.24</b>	<b>1.15</b>	<b>1.01</b>
Dietary (Prey) TEQ LOAEL = 9.2 pg/g													
PCBs (ng/kg = pg/g)	WHO TEFs												
Monochlorobiphenyls, Total		ND	ND	ND	6.09	ND	ND	ND	ND	ND	ND	ND	2.55
Dichlorobiphenyls, Total		ND	ND	52.40	202.00	124.00	69.90	ND	38.60	ND	ND	167.00	185.00
Trichlorobiphenyls, Total		172	132	78	865	951	509	2230	2870	3130	5030	3700	3870
Tetrachlorobiphenyls, Total		778	720	310	3900	3680	2950	11400	14000	14900	42000	36600	43000
Pentachlorobiphenyls, Total		1030	923	1020	5410	6210	9530	22900	28800	22000	103000	94300	104000
Hexachlorobiphenyls, Total		1060	1020	2160	4560	7420	9630	25700	30600	18900	111000	91100	109000
Heptachlorobiphenyls, Total		837	805	1680	2830	5260	3650	17400	21100	11400	66000	50200	64200
Octachlorobiphenyls, Total		230	235	671	826	1320	910	4180	5800	3010	20800	13200	16600
Nonachlorobiphenyls, Total		98	84	193	208	234	218	1120	1300	804	4150	3280	4180
<b>Total PCBs</b>		<b>4250</b>	<b>3950</b>	<b>6230</b>	<b>18900</b>	<b>25300</b>	<b>27500</b>	<b>85300</b>	<b>105000</b>	<b>74400</b>	<b>354000</b>	<b>294000</b>	<b>347000</b>

LOAELs taken from Dansereau et al. (1999)-Hg and Bursian et al. (2006)	Sample ID	AM1	AM2	AM3	CR1	CR2	CR3	LF1	LF2	LF3	UF1	UF2	UF3
	ALS #	-003	-004	-19.00	-001	-002	-20.00	-005	-006	-007	-008	-009	-010
	δN	7.19	7.12	6.70	12.80	12.95	12.22	14.89	15.18	15.28	16.42	16.76	16.57
	Trophic level	2.12	2.10	1.97	3.76	3.81	3.59	4.38	4.46	4.50	4.83	4.93	4.87
	% Lipid/100	0.013	0.015	0.056	0.011	0.012	0.081	0.027	0.027	0.033	0.020	0.020	0.024
Compounds													
Dietary (Prey) TPCBs LOAEL = 960,000 pg/g													
PCB 105	0.00003	79.90	71.30	82.80	404.00	520.00	899.00	1940.00	2350.00	1580.00	ND	6030.00	6950.00
PCB 114	0.00003	8.84	7.23	15.20	ND	ND	73.80	91.40	116.00	58.50	37.90	378.00	451.00
PCB 118	0.00003	365.00	390.00	364.00	1110.00	1550.00	2520.00	5590.00	7230.00	4890.00	145.00	17200.00	22400.00
PCB 123	0.00003	6.37	7.93	11.40	ND	8.43	51.40	56.10	75.70	51.00	307.00	212.00	265.00
PCB 126	0.1	ND	ND	5.58	ND	ND	3.65	ND	91.70	ND	ND	ND	ND
PCB 167	0.00003	24.10	23.30	54.50	69.80	114.00	179.00	306.00	378.00	234.00	23.60	1040.00	1280.00
PCB 169	0.03	ND	ND	ND	ND	ND	ND	ND	ND	ND	13.40	ND	ND
PCB 189	0.00003	5.35	ND	14.00	12.70	23.90	26.90	68.80	80.00	38.80	ND	178.00	213.00
PCB 77	0.0001	4.49	ND	ND	33.50	27.10	23.50	53.60	68.60	73.40	227.00	160.00	142.00
PCB 81	0.0003	ND	ND	ND	ND	ND	ND	ND	ND	ND	ND	14.70	ND
PCBs 156 + 157	0.00003	52.60	49.90	110.00	191.00	247.00	501.00	794.00	970.00	589.00	1670.00	2680.00	3290.00
TEQs from PCBs (Dietary (Prey) TEQ LOAEL = 9.2 pg/g)		0.02	0.02	0.58	0.06	0.08	0.49	0.27	9.52	0.23	0.49	0.85	1.06



## **Appendix D**

**Histological Assessment of Mink Jaws Collected during  
GLPF Project C30239: RAP Progress in the Rochester  
Embayment of Lake Ontario: Population Monitoring, Trophic  
Relationships, and Levels of Bioaccumulative Chemicals of  
Concern in Mink, a Sentinel Species (Supplemental Report)**

---

**Histological Assessment of Mink Jaws Collected during GLPF Project C30239**  
RAP Progress in the Rochester Embayment of Lake Ontario: Population Monitoring, Trophic Relationships, and Levels of Bioaccumulative Chemicals of Concern in Mink, a Sentinel Species

A Supplementary Report by

Kerrie J. Beckett  
Stantec Consulting Services, Inc.  
30 Park Drive  
Topsham, ME 04086

and

James M. Haynes  
Department of Environmental Science and Biology  
State University of New York  
College at Brockport  
350 New Campus Drive  
Brockport, NY 14420-2973

## **1.0 Introduction**

The Lake Ontario food web is contaminated with persistent organic pollutants, including polychlorinated biphenyls (PCBs), dioxins and furans, mirex, etc. The purpose of the study for which mink were collected originally was to determine: 1) if contaminants in mink tissue come primarily from sources in the Rochester Embayment Area of Concern (AOC) or from sources in Lake Ontario, and 2) if contaminant concentrations in mink are high enough to cause reproductive impairment. While doing the literature review for the original study (Haynes et al. 2007), it was discovered that the most sensitive known indicator of mink exposure to persistent organic pollutants is jaw lesions and associated histopathology; hence, this work.

Assessment of mandibular and maxillary squamous epithelial proliferation offers one of the most sensitive methods to detect piscivorous mammalian exposure to certain environmental chemicals, including 2,3,7,8-tetrachlorodibenzo-*p*-dioxin (TCDD), polychlorinated dibenzofurans (PCDF), and TCDD-like PCBs. Environmental exposure to these pollutants manifests as a histologically detectable lesion identified as mandibular and maxillary squamous epithelial proliferation or hyperplasia in the gingival tissue of the maxilla and mandible of mink (*Mustela vison*) (Beckett et al., 2005; Render et al. 2001, 2000a, b). The lesion is characterized by proliferation of squamous cells that form nests or cords that infiltrate into the periodontal ligament and alveolar bone causing osteolysis of the mandible and maxilla (Beckett et al., 2005). The lesion, identified as squamous epithelial proliferation, appears to progress to squamous cell carcinoma (SCC) in mink gingival tissue (Bursian et al., 2006a, b; Beckett et al., 2005). This SCC is extremely invasive and destructive, meeting certain criteria of malignant carcinogenicity, and has been shown to be fatal in mink in laboratory studies. The chemical, dose, and duration of exposure will contribute to the level or stage of progression of the identified lesion. In this study, the prevalence of the oral lesion was assessed in wild, trapped mink that were naturally exposed to environmental contaminants in the Lake Ontario watershed.

## 2.0 Methods

Previously frozen mink heads were received in 10% buffered formalin. All mink heads were examined clinically prior to the decalcifying process. Mink heads were placed in Surgipath® Decalcifier II (hydrochloric acid) (Surgipath Medical Industries, Inc., Richmond, IL) and tissues were trimmed during the decalcifying process. The mandible and maxilla (i.e., lower and upper jaw, respectively) were sectioned and processed for paraffin embedding, and then sectioned to 5 microns ( $\mu\text{m}$ ), mounted on microscopic slides, and stained with hematoxylin and eosin (H & E) for subsequent histological assessment. If the histopathological assessment revealed any cellular alterations or anomalies, the lesion was rated against a severity scale (Beckett et al., 2005). Suspected lesions were verified by a certified pathologist (Dr. S. Fitzgerald, Diagnostic Center for Population and Animal Health, Michigan State University, East Lansing, MI, pers. comm.).

## 3.0 Results and Discussion

Twelve mink heads were processed and jaws were histologically analyzed for exposure to environmental contaminants (Table 1). Three mink came from each of four areas in relation to the Rochester (New York) Embayment AOC: 1) near Lake Ontario in the AOC; 2) inland (i.e., not in contact with the Lake Ontario food web) in the AOC; 3) near Lake Ontario out of the AOC; and 4) inland out of the AOC. The three mink from each area were the individuals with the highest and lowest levels of total PCBs in liver tissue and the individual closest to the average PCB concentration among 10 mink collected in each area.

One of the 12 mink (mink #17), captured near Lake Ontario within the Rochester AOC, exhibited gross and histological evidence of oral neoplasia, and also had the highest hepatic concentration of total PCBs (5870.8 ng/g-wet weight [ww]) in the original study (Haynes et al. 2007). Gross evaluation of mink #17 revealed separation of the maxillary incisors, with some missing incisors. Although both mandibular canines were broken off near or below the gum-line (due to tooth extraction for aging in the original study), there was an overall healthy appearance and condition of teeth. Both the maxilla and the mandible bones were broken also, and therefore were sectioned off-center of the midline. The lesion was grossly apparent during the processing stages, particularly in the left maxilla in which small proliferative areas containing nodular-like growths and swelling were recognized along the outside of the last premolar along the dental arcade. Mink #17 was diagnosed with severe lesions in all available jaw quadrants (right and left maxillae and mandible). Histopathologically, cellular cords and nests extended deep into the jaw bone in which the lesion was apparent. Greater than about 50% of the jaw bone had been replaced with cords and/or nests of squamous epithelial cells. This is the first report of the lesion being grossly detectable in a naturally exposed mink, and therefore suggests increased credibility for its use as a monitoring tool for exposure to TCDD-like environmental contaminants.

Three other mink (mink #21, #63, and #46) each had suspicious areas within the gingival tissue suggestive of the lesion. However, the degree of freeze/thaw artifact and tissue damage from tooth extraction for aging was too extensive to confirm the etiology of the tissue damage and whether or not it was caused by contaminant exposure.

Mink #21 had discoloration of the premolars and was missing some maxillary incisors. Additionally, there was evidence of tissue and tooth damage to some incisors in the right maxilla

that presented as ruffled edges of the teeth. No obvious squamous epithelial cysts were identified. The total hepatic PCB concentration in mink #21 was 682.0 ng/g-ww. This mink was captured near Lake Ontario within the Rochester AOC, and had the third highest PCB concentration among the 40 mink analyzed in the original study.

Mink #63 presented pronounced incisor separation in the maxilla, as well as some incisor separation in the mandible. The mandible also had clear evidence of tissue damage around the incisors, as well as increased cellular spacing in this region. No obvious cysts comprised of squamous cells were noted. However, an abnormal cellular lesion in the molar region was suspicious, but evidence of its origin was difficult to determine due to extensive freeze/thaw artifact and tissue damage. The total hepatic PCB concentration in mink #63 was 554.4 ng/g-ww. This mink was captured inland in the Rochester AOC, and had the fourth highest PCB concentration among the 40 mink analyzed in the original study.

Mink #46 had apparent tissue damage around the incisors of the mandible, with moderate freeze/thaw artifact throughout. The last mandibular molar region had suspicious tissue damage that was suggestive of a lesion, although this could not be confirmed. The total hepatic PCB concentration in mink #46 was 229.8 ng/g-ww. This mink was captured near Lake Ontario outside of the Rochester AOC, and had the fifth highest PCB concentration among the 40 mink analyzed in the original study.

#### **4.0 Conclusions**

Among the 12 mink analyzed for the jaw lesion, four of the five with the highest levels of total PCB in liver had definite (mink #17) or suspected (mink #21, #63, and #46) histopathologic appearance of the lesion that suggests squamous cell carcinoma. The characteristics of the lesion observed in mink from the current study were consistent with some of the criteria for malignant neoplasia, including invasiveness of atypical cell type, tissue destruction, increased proliferative activity, and diffuse infiltration. The data presented here and elsewhere suggest 1) a strong correlation between the presence and severity of the lesion with total PCB concentrations measured in tissue; 2) that the lesion is an extremely sensitive indicator of environmental exposure of mink to the most toxic of persistent organic pollutants; and 3) that mink near the shore of Lake Ontario and, perhaps, inland in the AOC are exposed to levels of persistent organic pollutants sufficient to cause the lesion.

#### **5.0 Acknowledgments**

Randall Baase collected most of the mink used for this study. James Pagano, SUNY College at Oswego, performed PCB analyses. Columbia Analytical Services, Houston, TX performed dioxin-furan analyses. Sara Wellman conducted the literature search that revealed jaw lesions as the most sensitive indicator of exposure to persistent organic pollutants that led to this study.

## 6.0 References

- Beckett, K.J., S.D. Millsap, A.L. Blankenship, M.J. Zwiernik, J.P. Giesy and S.J. Bursian. 2005. Squamous epithelial lesion of the mandibles and maxillae of wild mink (*Mustela vison*) naturally exposed to polychlorinated biphenyls. *Environmental Toxicology and Chemistry* **24**(3):674-677.
- Bursian, S.J., K.J. Beckett, B. Yamini, P.A. Martin, K. Kannan, K.L. Shields and F.C. Mohr. 2006a. Assessment of effects in mink caused by consumption of carp collected from the Saginaw River, Michigan, USA. *Archives of Environmental Contamination and Toxicology* **50**(4):614-623.
- Bursian, S.J., C. Sharma, R.J. Aulerich, B. Yamini, R.R. Mitchell, K.J. Beckett, C.E. Orazio, D. Moore, S. Svirsky and D.E. Tillitt. 2006b. Dietary exposure of mink (*Mustela vison*) to fish from the Housatonic River, Berkshire County, MA, USA: Effects on organ weights and histology and hepatic concentrations of polychlorinated biphenyls and 2,3,7,8-tetrachlorodibenzo-*p*-dioxin toxic equivalents. *Environmental Toxicology and Chemistry* **25**(6):1541-1550.
- Haynes, J.M., S.T. Wellman and J.J. Pagano. 2007. RAP Progress in the Rochester Embayment of Lake Ontario: Population Monitoring, Trophic Relationships, and Levels of Bioaccumulative Chemicals of Concern in Mink, a Sentinel Species. Final report to the NY Great Lakes Protection Fund. NY Department of Environmental Conservation, Buffalo, NY.
- Render, J.A., J.R. Hochstein, R.J. Aulerich and S.J. Bursian. 2000a. Proliferation of periodontal squamous epithelium in mink fed 2,3,7,8-tetrachlorodibenzo-*p*-dioxin (TCDD). *Veterinary and Human Toxicology* **42**(2):85-86.
- Render, J.A., R.J. Aulerich, S.J. Bursian and R.F. Nachreiner. 2000b. Proliferation of maxillary and mandibular periodontal squamous cells in mink fed 3,3',4,4',5-pentachlorobiphenyl (PCB 126). *J Vet Diagn Invest* **12**:477-479.
- Render, J.A., S.J. Bursian, D.S. Rosenstein and R.J. Aulerich. 2001. Squamous epithelial proliferation in the jaws of mink fed diets containing 3,3',4,4',5-pentachlorobiphenyl (PCB 126) or 2,3,7,8-tetrachlorodibenzo-*p*-dioxin (TCDD). *Veterinary and Human Toxicology* **43**(1):22-26.

**Table 1.** Tissue concentrations of selected persistent organic pollutants in liver and adipose tissue of mink collected near Lake Ontario and inland, in and out of the Rochester Embayment Area of Concern (AOC), and corresponding presence and severity of jaw lesion.

<b>Collection Location</b>	<b>Total PCB Liver (ng/g-ww)</b>	<b>Adipose TEQ (ng/kg-ww)</b>	<b>Liver TEQ (ng/kg-ww)</b>	<b>Jaw Lesion</b>
<i><b>AOC-Lake</b></i>				
Mink #17	5870.8	339.98	21.26	Severe
Mink #21	682.0	na	3.50	Suggestive
Mink #56	14.7	7.66	nd	nd
<i><b>AOC-Inland</b></i>				
Mink #1	8.5	0.03	0.10	nd
Mink #61	64.2	8.96	nd	nd
Mink #63	554.4	9.13	nd	Suggestive
<i><b>Out of AOC-Lake</b></i>				
Mink #46	229.8	19.63	2.09	Suggestive
Mink #49	755.0	38.29	38.31	nd
Mink #53	13.6	5.30	0.92	nd
<i><b>Out of AOC-Inland</b></i>				
Mink #14	7.0	nd	0.03	nd
Mink #30	45.0	na	na	nd
Mink #33	19.3	na	na	nd
na = not analyzed; nd = not detected; ww = wet weight				





Department of  
Environmental  
Conservation

