

United States Environmental Protection Agency
Region 10
1200 Sixth Avenue, Suite 155
Seattle, Washington 98101-3188

Authorization to Discharge under the
National Pollutant Discharge Elimination System

In compliance with the provisions of the Clean Water Act (CWA), 33 U.S.C. § 1251 *et seq.*, as amended by the Water Quality Act of 1987, P.L. 100-4, the “Act”,

**Concentrated Animal Feeding Operations (CAFOs) in Idaho
as defined in Section I of this permit**

are authorized to discharge in accordance with discharge point(s), effluent limitations, monitoring requirements, and other conditions set forth herein.

This permit shall become effective: June 15, 2020

This permit and the authorization to discharge shall expire at midnight: June 14, 2025

The permittee shall reapply for a permit reissuance on or before December 16, 2024, 180 days before the expiration of this permit if the permittee intends to continue operations and discharges at the facility beyond the term of this permit.

/s/

Daniel D. Opalski, Director
Water Division

This permit was modified: _____

Mathew J. Martinson
CAPT, USPHS
Branch Chief
Permitting, Drinking Water and Infrastructure

Table of Contents

I. Permit Area and Coverage.....	3
A. Permit Area and Eligibility	3
B. Application for Coverage	3
C. Permit Expiration	5
D. Change in Ownership	5
E. Termination of Permit Coverage	6
F. Individual Permit Coverage.....	6
II. Effluent Limitations and Standards.....	7
A. Effluent Limitations and Standards Applicable to the Production Area.....	7
B. Effluent Limitations and Standards Applicable to the Land Application Area	9
III.Special Conditions	11
A. Nutrient Management Plan.....	11
B. Lagoon Liner Requirements.....	16
C. Facility Closure	16
D. Requirements for the Transfer of Manure, Litter, and Process Wastewater.....	17
IV.Records, Reporting, Monitoring, and Notification	18
A. Records Management.....	18
B. Annual Reporting Requirements	19
C. Notification of Unauthorized Discharges Resulting from Manure, Litter, and Process Wastewater Storage, Handling, On-site Transport and Application.....	20
D. Monitoring Requirements for All Discharges from Wastewater or Manure Storage Structures	20
E. Monitoring Requirements for Discharges from Land Application Areas	22
F. Spills / Releases in Excess of Reportable Quantities.....	23
V. Standard Permit Conditions	24
A. General Monitoring, Recording, and Reporting Requirements	24
B. Compliance Responsibilities	26
C. General Provisions	31
VI.Definitions	34
APPENDIX A - Notice of Intent - EPA Form 2B.....	37
APPENDIX B - ID NRCS Conservation Practice Standard Code 360.....	49
APPENDIX C - ID NRCS IDAW	52
APPENDIX D - WA NRCS Engineering Technical Note #23	72
APPENDIX E - ID NRCS Water Quality Technical Note #6.....	115
APPENDIX F - University of Idaho CIS 1139	136
APPENDIX G - University of Idaho Bulletin #704 (Revised)	141
APPENDIX H - Annual Report Template	150
APPENDIX I - Idaho Phosphorus Site Index.....	165

I. PERMIT AREA AND COVERAGE**A. Permit Area and Eligibility**

This permit offers National Pollutant Discharge Elimination System (NPDES) permit coverage for discharges from facilities that meet the definition of a concentrated animal feeding operation (CAFO), as defined by 40 CFR § 122.23(b)(2), in the State of Idaho. Any facility that meets the definition of a large, medium or small CAFO, as defined in 40 CFR § 122.23(b)(4), (6), and (9), and that is not specifically excluded per one of the conditions in Section I.F.1, is eligible for coverage under this permit.

CAFO owners/operators ineligible for coverage under this permit (Section I.F.1) or who believe the terms and conditions of this permit are not appropriate for their CAFO facility, must apply for an individual permit in accordance with Section I.F.3.

B. Application for Coverage

1. Owners/operators of CAFOs seeking to be covered by this permit must submit an NOI (Appendix A) and a Nutrient Management Plan (NMP) that meets the requirements of Section III.A of this permit.
2. Signature Requirements: The NOI must be signed by the owner/operator or other authorized person in accordance with Section V.C.5 of this permit.
3. Where to Submit: A signed copy of the NOI must be sent to:

United States Environmental Protection Agency,
Region 10 Manager, NPDES Permits Section
1200 Sixth Avenue, Suite 155, WD 19-C04
Seattle, WA 98101-3188

Copies of the NOI shall also be sent to the Idaho State Department of Agriculture (ISDA), the Idaho Department of Environmental Quality (IDEQ) state office, and the appropriate IDEQ regional offices listed below.

Beginning December 21, 2020, all NOIs must be submitted electronically.

Idaho State Department of Agriculture 2270 Old Penitentiary Road P.O. Box 790
Idaho Department of Environmental Quality Water Quality Division IDEQ State Office 1410 N. Hilton Boise, ID 83706 (208) 373-0570 tambra.phares@deq.idaho.gov

<p>IDEQ Boise Regional Office 1445 N. Orchard Boise, ID 83706 (208) 373-0490 chase.cusack@deq.idaho.gov</p>	<p>Counties: Ada Adams Boise Canyon Elmore</p>	<p>Gem Owyhee Payette Valley Washington</p>
<p>IDEQ Coeur d'Alene Regional Office 2110 Ironwood Parkway Coeur d'Alene, ID 83814 (208) 666-4605 chantilly.higbee@deq.idaho.gov</p>	<p>Counties: Benewah Bonner Boundary</p>	<p>Kootenai Shoshone</p>
<p>IDEQ Idaho Falls Regional Office 900 N. Skyline, Suite B Idaho Falls, ID 83402 (208) 528-2679 alex.bell@deq.idaho.gov</p>	<p>Counties: Bonneville Butte Clark Custer Fremont</p>	<p>Jefferson Lemhi Madison Teton</p>
<p>IDEQ Lewiston Regional Office 1118 "F" St. Lewiston, ID 83501 (208) 799-4874 sujata.connell@deq.idaho.gov</p>	<p>Counties: Clearwater Idaho Latah</p>	<p>Lewis Nez Perce</p>
<p>IDEQ Pocatello Regional Office 444 Hospital Way #300 Pocatello, ID 83201 (208) 239-5007 matthew.schenk@deq.idaho.gov</p>	<p>Counties: Bannock Bear Lake Bingham Caribou</p>	<p>Franklin Oneida Power</p>
<p>IDEQ Twin Falls Regional Office 650 Addison Ave. W., Suite 110, Twin Falls, ID 83301 (208) 737-3877 sean.woodhead@deq.idaho.gov</p>	<p>Counties: Blaine Camas Cassia Gooding</p>	<p>Jerome Lincoln Minidoka Twin Falls</p>

4. Upon receipt, EPA will review the NOI and NMP for completeness. EPA may request additional information from the CAFO owner or operator if additional information is necessary to complete the NOI and NMP or to clarify, modify, or supplement previously submitted material. If EPA makes a preliminary determination that the NOI is complete, the NOI, NMP, and draft terms of the NMP to be incorporated into the permit will be made available for a thirty (30) day public review and comment period (<http://yosemite.epa.gov/r10/HOMEPAGE.NSF/Information/R10PN>). The process for submitting public comments and requests for hearing will follow the procedures

- applicable to draft permits as specified by 40 CFR §§ 124.11 through 124.13. EPA will respond to comments received during the comment period as specified in 40 CFR § 124.17 and, if necessary, require the CAFO owner or operator to revise the NMP in order to obtain permit coverage. If determined appropriate by EPA, CAFOs will be granted coverage under this general permit upon written notification by EPA. EPA will identify the terms of the NMP to be incorporated into the permit in the written notification. Each CAFO covered by this permit must comply with the site-specific permit terms established by EPA based on the CAFO's site specific NMP.
5. For new sources, the National Environmental Policy Act (NEPA) requires EPA to conduct an environmental review pursuant to 40 CFR Part 6. NEPA requirements must be complied with prior to authorizing permit coverage to new sources (i.e. Large CAFOs whose construction began after April 14, 2003). New sources seeking permit coverage must submit an Environmental Information Document (EID) or Draft Environmental Assessment (EA) along with their NOI and NMP (40 CFR § 6.200(g)(2) and 40 CFR § 6, Subpart C). Information concerning preparation of an EID or EA can be obtained by contacting the NEPA compliance officer in the EPA, Region 10, NPDES Permits Section.

These NEPA and NOI requirements also apply to expansions of existing CAFOs that meet the definition of a new source at 40 CFR § 122.2 and the new source criteria at 40 CFR § 122.29(a) and (b). In order to determine if an expansion is a new source, the applicant must submit to EPA information describing the expansion and a map showing the location of the expansion. If EPA determines the expansion meets the new source definition, the owner/operator must prepare and submit an EID or draft EA as described above. The information must be submitted to:

United States Environmental Protection Agency,
Region 10 Manager, NPDES Permits Section
1200 Sixth Avenue, Suite 155, 19-C04
Seattle, WA 98101-3188

C. Permit Expiration

This permit will expire five (5) years from the effective date. If this permit is not reissued or replaced prior to the expiration date, the permit will be administratively continued and remain in force and effect until it is replaced by a new/reissued permit. Any permittee who has submitted a NOI and been granted coverage will automatically remain covered by the administratively continued permit. Coverage under an administratively continued permit cannot be granted following the expiration date.

D. Change in Ownership

If a change in the ownership of a facility whose discharge is authorized under this permit occurs, coverage under the permit will automatically transfer if (1) the current permittee notifies EPA at least 30 days prior to the

proposed transfer date; (2) the notice includes a written agreement between the existing and new permittees containing a specific transfer date for permit responsibility, coverage, and liability between them; and (3) EPA does not notify the existing permittee and the proposed permittee that the operation is no longer eligible for coverage under the General Permit. If the new CAFO owner or operator modifies any part of the NMP, the NMP shall be submitted to EPA in accordance with Section III.A.5 of the permit. EPA will determine if the scope of changes warrants public notice and comment per the requirements of Section I.B.4.

E. Termination of Permit Coverage

1. A permittee may request to terminate coverage under this permit if the permittee makes such a request in writing and one of the following conditions is met:
 - a) The facility has ceased all operations and all wastewater or manure storage structures have been properly closed in accordance with the Idaho Natural Resources Conservation Service (NRCS) Conservation Practice Standard No. 360, Closure of Waste Impoundments (Appendix B) contained in the Natural Resources Conservation Service Field Office Technical Guide and all other remaining stockpiles of manure, litter, or process wastewater not contained in a wastewater or manure storage structure are properly disposed in accordance with Section III.C; or
 - b) The facility is no longer a CAFO that discharges manure, litter, or process wastewater to waters of the United States; or
 - c) The entire discharge is permanently terminated by elimination of the flow or by connection to a publicly owned treatment works (POTW).
2. Requests to terminate coverage under this permit must be made in writing and submitted to EPA at the following address:

United States Environmental Protection Agency,
Region 10 Manager, NPDES Permits Section
1200 Sixth Avenue, Suite 155, 19-C04
Seattle, WA 98101-3188

Beginning December 21, 2020, all requests to terminate coverage must be submitted electronically.

3. Termination of coverage will become effective 30 days after the EPA sends written notice to the permittee, unless the permittee objects within that time.

F. Individual Permit Coverage

1. The following CAFOs are not eligible for coverage under this permit, and must apply for an individual permit:
 - a) CAFOs that have been notified by EPA that they are ineligible for coverage under this general permit due to a history of non-compliance.

- b) CAFOs that are seeking coverage that will adversely affect species that are federally listed as endangered or threatened (“listed”) under the Endangered Species Act (ESA) or adversely modify critical habitat of those species.
 - c) CAFOs that are seeking coverage that will have the potential to affect historic properties. CAFO owners/operators must determine whether their permit-related activities have the potential to affect a property that is listed or eligible for listing on the National Register of Historic Places.
 - d) CAFOs with discharges to a designated Outstanding Resource Water. As of the effective date of this permit there are no Outstanding Resource Waters approved by the Idaho Legislature.
 - e) CAFOs located in Indian Country.
2. EPA may require any facility authorized by this permit to apply for, and obtain, an individual NPDES permit. EPA will notify the operator, in writing, that an application for an individual permit is required and will set a time for submission of the application. Coverage of the facility under this general NPDES permit is automatically terminated when: (1) the operator fails to submit the required individual NPDES permit application within the defined time frame; or (2) the individual NPDES permit is issued by EPA.
 3. Any owner/operator who believes that the terms and conditions of this general permit are not appropriate for his/her CAFO facility, either prior to or after obtaining coverage under this permit, may request to be covered under an individual permit pursuant to 40 CFR § 122.28(b)(3)(iii). The owner/operator shall submit an application for an individual permit (Form 1 and Form 2B) with the reasons supporting the application to EPA. If a final, individual NPDES permit is issued to an owner/operator otherwise subject to this general permit, the applicability of this NPDES CAFO general permit to the facility is automatically terminated on the effective date of the individual NPDES permit. Otherwise, the applicability of this general permit to the facility remains in full force and effect.

II. EFFLUENT LIMITATIONS AND STANDARDS

A. Effluent Limitations and Standards Applicable to the Production Area

Except as provided in Section II.A.3, there must be no discharge of manure, litter, or process wastewater into waters of the United States from the production area except as provided below.

1. Whenever precipitation causes an overflow of manure, litter, or process wastewater, pollutants in the overflow may be discharged into waters of the United States provided:
 - a) The production area is designed, constructed, operated, and maintained to contain all manure, litter, process wastewater, and the runoff and direct precipitation from the 25-year, 24-hour storm event for the location of the CAFO.

- b) The design storage volume is adequate to contain all manure, litter, and process wastewater accumulated during the storage period including, at a minimum, the following:
 - (i) The normal precipitation less evaporation during the storage period;
 - (ii) The normal runoff during the storage period;
 - (iii) The direct precipitation from a 25-year, 24-hour storm event;
 - (iv) The runoff from the 25-year, 24-hour storm event from the production area;
 - (v) The residual solids after liquid has been removed;
 - (vi) The necessary freeboard to maintain structural integrity; and
 - (vii) In the case of treatment lagoons, the necessary minimum treatment volume.
2. The production area must be operated in accordance with the additional measures and records specified below:
 - a) Visual Inspections. There must be routine visual inspections of the CAFO production area. At a minimum, the following must be visually inspected:
 - (i) Weekly visual inspections of all storm water diversion devices, runoff diversion structures, and devices channeling contaminated storm water to the wastewater or manure storage structures;
 - (ii) Daily visual inspections of all water lines, including drinking water and cooling water lines;
 - (iii) Weekly inspections of the manure, litter, and process wastewater impoundments, storage and containment structures. The inspection will note the level in liquid impoundments as indicated by the depth marker in Section II.A.2.b) in this section;
 - b) Depth Marker. All open surface liquid impoundments must have a depth marker that clearly indicates the minimum capacity necessary to contain the runoff and direct precipitation of the 25-year, 24-hour rain fall event. Install a depth marker in all open wastewater or manure storage structures. The depth marker must clearly indicate the minimum capacity necessary to contain the runoff and direct precipitation of the 25-year, 24-hour rainfall event.
 - c) Corrective Actions. Any deficiencies found as a result of the daily and weekly inspections must be corrected as soon as possible.
 - d) Mortality Handling. Mortalities shall not be disposed of in any liquid manure or process wastewater system and must be handled in such a way as to prevent the discharge of pollutants to surface waters of the United States.
 - e) Record keeping requirements for the production area. The maintenance of complete on-site records documenting the implementation of all required additional measures and corrective actions listed above must be maintained for a period of five years.

3. For all swine, poultry and veal facilities for which construction of the facility began after April 14, 2003 (New Sources), there shall not be a discharge of manure, litter or process wastewater pollutants into waters of the United States from the production area.

B. Effluent Limitations and Standards Applicable to the Land Application Area

For CAFOs where manure, litter, or process wastewater is applied to land under the control of the CAFO owner/operator, the NMP required by Section III of this permit must include the following requirements:

1. Nutrient transport potential. The NMP must incorporate elements in Section III.A.2.f) based on a field-specific assessment of the potential for nitrogen and phosphorus transport from the field.
2. Form, source, amount, timing, and method of application. The NMP must address the form, source, amount, timing, and method of application of nutrients on each field to achieve realistic production goals, while minimizing nitrogen and phosphorus movement to surface waters.
3. Determination of application rates. Application rates for manure, litter, or process wastewater must minimize phosphorus and nitrogen transport from the field to surface waters in accordance with the Section III.A.2.h).
4. Site-specific conservation practices. Identify appropriate site-specific conservation practices to be implemented, including as appropriate buffers or equivalent practices, to control runoff of pollutants to waters of the United States in accordance with Section III.A.2.f).
5. Protocols to land apply manure, litter or process wastewater. Establish protocols to land apply manure, litter or process wastewater in accordance with site specific nutrient management practices that ensure appropriate agricultural utilization of the nutrients in the manure, litter or process wastewater in accordance with Section III.A.2.h).
6. Manure and soil sampling. Manure must be analyzed at least once annually for nitrogen and phosphorus content in accordance with Section III.A.2.g)(i). Soil must be analyzed annually for nitrogen and phosphorus content in accordance with Section III.A.2.g)(ii). The results of these analyses must be used in determining application rates for manure, litter, and process wastewater;
7. Inspection of land application equipment for leaks. Equipment used for land application of manure, litter, or process wastewater must be inspected periodically for leaks;
8. Land application setback requirements. Unless the permittee exercises one of the compliance alternatives of this section as provided below in (a) or (b), manure, litter, and process wastewater may not be applied closer than 100 feet to any down-gradient

surface waters, open tile line intake structures, sinkholes, agricultural well heads, or other conduits to surface waters.

- a) **Vegetated buffer compliance alternative.** As a compliance alternative, the CAFO may substitute the 100-foot setback with a 35-foot wide vegetated buffer where applications of manure, litter, or process wastewater are prohibited.
 - b) **Alternative practices compliance alternative.** As a compliance alternative, the CAFO may demonstrate that a setback or buffer is not necessary because implementation of alternative conservation practices or field-specific conditions will provide pollutant reductions equivalent or better than the reductions that would be achieved by the 100-foot setback. Alternative conservation practices can include practices that are designed in consultation with a Professional Engineer licensed in the state of Idaho. Alternatively, an adequate demonstration may include the use of site-specific data using a tool such as the Idaho NRCS Water Quality Technical Note #6, Idaho Nutrient Transport Risk Assessment (INTRA) (Appendix E) or the Idaho Phosphorus Site Index (Appendix I) and associated implementation of alternative conservation practices recommended as a result of these tools.
9. **No Dry Weather Discharge.** There shall be no dry weather discharge of manure, litter, or process wastewater to a water of the United States from a CAFO as a result of the application of manure, litter or process wastewater to land areas under the control of the CAFO. This prohibition includes discharges to waters of the United States through tile drains, ditches or other conveyances, and irrigation return.
- a) **There shall be no application of manure, litter, or process wastewater on fields with surface irrigation (e.g., flood or furrow irrigation).**
 - b) **During any land application of liquid manure or process wastewater to a field with an INTRA or Phosphorus Site Index risk assessment rating of medium or higher, a visual inspection of the downgradient edge of the field and any other potential discharge locations (e.g., tile drains, ditches, or other conveyances) must be conducted during the land application event and after the land application event to check for field runoff and discharges. In the event of a discharge the monitoring requirements of Section IV.E.1 must be implemented.**
 - c) **During any land application of manure, litter, or process wastewater to a land application area where a land application setback or compliance alternative is required pursuant to Section II.B.8 of this permit, a visual inspection must be conducted during the land application event and after the land application event to 1) confirm that the land application setback or compliance alternative is being maintained and functioning as intended and 2) determine if there are any discharges. In the event of a discharge, the monitoring requirements of Section IV.E.1 must be implemented.**
10. **Prohibition on Land Application to Frozen, Snow-Covered and Saturated Soils.** The land application of manure, litter, or process wastewater must not occur when the land application area is:

- a) Frozen and/or snow-covered soils, or
- b) When the top two inches of soil are saturated from rainfall, snow melt, irrigation, or when current or predicted weather is capable of producing such conditions.

III. SPECIAL CONDITIONS

A. Nutrient Management Plan

The permittee shall develop, submit, and implement a site-specific Nutrient Management Plan (NMP). The NMP shall identify and describe practices that will be implemented to ensure compliance with the effluent limitations and special conditions of this permit (Sections II and III). Unless otherwise stated in this permit, the NMP must be developed in accordance with Section III.A.2 below.

1. Schedule. The completed NMP must be submitted to EPA with a NOI for CAFOs seeking coverage under this permit. The permittee shall implement its NMP upon authorization under this permit.
2. NMP Content. The NMP must include site-specific practices and procedures necessary to implement the applicable effluent limitations and standards. In addition, the NMP and each CAFO covered by this permit must, as applicable:
 - a) Ensure adequate storage of manure, litter, and process wastewater including procedures to ensure proper operation and maintenance of the wastewater and manure storage structures. All wastewater and manure storage structures shall be designed, constructed, operated, and maintained in accordance with the requirements specified in Section II.A.1 of this permit.
 - (i) The CAFO covered by this permit must determine if existing or planned wastewater and manure storage structures are adequately sized in accordance with the requirements specified in Section II.A.1 of this permit by evaluating each wastewater or manure storage structure. The CAFO may use the Idaho Animal Waste Management (IDAWM) Software, Version 4, December 2000 (Appendix C) and accompanying spreadsheet, the NRCS Animal Waste Management Software, or demonstrate that the facility is designed with adequate storage capacity as determined by runoff and design calculations followed by an as-built survey conducted by a Profession Engineer licensed in the state of Idaho. If the evaluation determines that the CAFO's existing wastewater or manure storage structures have a storage capacity less than the minimum capacity requirements specified in Section II.A.1, the CAFO's NMP must plan for measures the CAFO will take to ensure that the storage capacity specified in Section II.A.1 is met. The NMP must include the results of the wastewater and manure storage structure evaluations, including any corrective and interim measures, and a schedule for implementation.
 - (ii) The CAFO covered by this permit must ensure the proper operation and maintenance of wastewater and manure storage structures by confirming compliance with NRCS Appendix 10D and IDAPA 02.04.14.030.01 through

a Professional Engineer, or by completing the Washington NRCS Engineering Technical Note #23, January 2013 (Appendix D), for each wastewater or manure storage structure. If the evaluation of the CAFO's wastewater or manure storage structures identifies deficiencies in the operation or maintenance of the structures, the CAFO must identify measures to address those deficiencies in its NMP. If the CAFO chooses to confirm compliance through the use of a Professional Engineer, the NMP must include the results of the engineer's evaluation. If the CAFO chooses to use Technical Note #23, the NMP must include the results of the evaluation using Washington NRCS Engineering Technical Note #23, January 2013 (Appendix D).

(iii) CAFOs that choose to comply with Section III.A.2.a)(ii) above by confirming compliance with NRCS Appendix 10D and IDAPA 02.04.14.030.01 must maintain documentation demonstrating that each wastewater and manure storage structure complies with NRCS Appendix 10D and IDAPA 02.04.14.030.01. If such documentation is not available for one or more wastewater or manure storage structures, the NMP must include a plan, in accordance with the specifications in Section IV.D.6, to identify and monitor any subsurface discharges from each undocumented wastewater or manure storage structure.

(iv) For CAFOs that choose to comply with Section III.A.2.a)(ii) above by using Washington NRCS Engineering Technical Note #23, January 2013 (Appendix D), the NMP must include a plan, in accordance with the specifications in Section IV.D.6 to identify and monitor any subsurface discharges from each wastewater or manure storage structure that receives a "High Risk" rating on either the Site Assessment Form or Structure Assessment Form, regardless of repairs or additional practices implemented to mitigate risk.

- b) Ensure proper management of mortalities (i.e. dead animals) to ensure that they are not disposed of in a liquid manure, storm water, or process wastewater storage or treatment system that is not specifically designed to treat animal mortalities. Mortality handling practices must be in accordance with all applicable Federal, State, and local regulatory requirements.

The CAFO covered by this permit must include information in its NMP that addresses both typical and catastrophic mortalities. At a minimum, the NMP must identify the following:

- (i) Schedules for collecting, storing, and disposing of carcasses;
- (ii) Description of on-site storage before disposal;
- (iii) Description of final disposal method;

- (iv) Additional management practices to protect waters of the United States for on-site disposal including composting or burial; and
 - (v) Contingency plans for mass mortalities.
- c) Ensure that clean water is diverted, as appropriate, from the production area. Any clean water that is not diverted and comes into contact with raw materials, products, or byproducts including manure, litter, process wastewater, feed, milk, eggs, or bedding is subject to the effluent limitations specified in Section II.A of this permit. Where clean water is not diverted from the production area, the wastewater or manure storage structure shall include adequate storage capacity for the additional clean water. Clean water includes, but is not limited to, snow melt and/or rain falling on the roofs of facilities and runoff from adjacent land. The NMP must identify the BMPs or engineering controls, existing or needed, to exclude clean water from the production area. The NMP must include operation and maintenance procedures required to maintain the existing BMPs or engineering controls or the timing for the construction of needed BMPs or engineering controls.
- d) Prevent the direct contact of animals confined or stabled at the facility with waters of the United States. Animals confined at the CAFO must not come into direct contact with waters of the United States. At a minimum, the NMP must describe the BMPs or engineering controls the CAFO will use to prevent animals in the production area from coming into contact with waters of the United States.
- e) Ensure that chemicals and other contaminants handled on-site are not disposed of in any manure, litter, process wastewater, or storm water storage or treatment system unless specifically designed to treat such chemicals or contaminants. All wastes from dipping vats, pest and parasite control units, and other facilities utilized for the management of potentially hazardous or toxic chemicals shall be handled and disposed of in a manner sufficient to prevent pollutants from entering the manure, litter, or process wastewater storage structure or waters of the United States. The NMP must include references to any applicable chemical storage and handling protocols and incorporate specific BMPs and actions that will be taken to prevent the improper disposal of chemicals and other contaminants into any manure, litter, process wastewater, or storm water storage or treatment system. The NMP should also consider chemical handling plans for the protection of wells, water supplies, and any drainage ways that are close to chemical storage and handling areas.
- f) Identify appropriate site-specific conservation practices to be implemented on the land application areas, including as appropriate buffers or equivalent practices as stipulated in Section II.B.8, to control runoff of pollutants to waters of the United States. The NMP must include appropriate conservation practices identified by evaluating each land application area using the Idaho NRCS Water Quality Technical Note #6, Idaho Nutrient Transport Risk Assessment (INTRA) (Appendix E). CAFOs may opt to utilize the Idaho Phosphorus Site Index (P Index) (Appendix I). The NMP must include the results of the INTRA or P Index evaluations. All CAFOs must follow guidance provided by INTRA and the P

Index. If the site-specific conservation practices are NRCS conservation practice standards, the NMP must include provisions to operate and maintain those site-specific conservation practices according to the specific NRCS conservation practices standard. If the owner/operator proposes alternative practice or performance standards, the NMP must describe and cite those standards so that EPA can perform an adequate review. In addition, the NMP must include a schedule for implementation of site-specific conservation practices and proper operation and maintenance procedures.

- g) Protocols for appropriate testing of manure, litter, process wastewater, and soil.
- (i) Manure must be analyzed at least once annually for nitrogen and phosphorus content in accordance with the University of Idaho Manure and Wastewater Sampling CIS 1139 (Appendix F). The results of these analyses must be included in the NMP and be used in determining application rates for manure, litter, and process wastewater as described in Section III.A.2.h).
 - (ii) Soil samples must be taken from every field to which manure, litter and process wastewater will be applied. Soil must be analyzed annually in accordance with University of Idaho Bulletin 704 (Appendix G). At a minimum, soil samples must be analyzed for the following constituents: pH, soil organic matter (SOM), Nitrate- Nitrogen ($\text{NO}_3\text{-N}$), Ammonium-Nitrate ($\text{NH}_4\text{-N}$), and phosphorus (P). The results of these analyses must be included in the NMP and used in determining application rates for manure, litter, and process wastewater as described in Section III.A.2.h).
 - (iii) Soil samples must be analyzed by a laboratory certified by the North American Proficiency Testing Program (NAPT). Manure samples must be analyzed by a certified Manure Analysis Proficiency Laboratory.
- h) Establish protocols to land apply manure, litter, or process wastewater in accordance with site specific nutrient management practices that ensure appropriate agricultural utilization of the nutrients in the manure, litter, or process wastewater.

Annual nutrient budgets must be generated to determine land application rates for each field where manure, litter, or process wastewater is applied. The annual budget must be included in the NMP and be developed in accordance with the University of Idaho Fertilizer Guides or related University of Idaho Crop Production Guide. In the absence of an appropriate University of Idaho Fertilizer or Crop Production Guide, a fertilizer or production guide from a Pacific Northwest Land Grant University may be used (i.e. Oregon State University or Washington State University). In the absence of specific Land Grant University fertilizer or production guides, the NMP must identify and include the best available data used to determine specific land application rates for the crop. The NMP must express land application rates of nutrients in pounds per acre; and volume of manure, litter, and process wastewater in tons, gallons or cubic feet. Ensuring accurate application rates reduces probability of off-site transport. The

NMP developed to meet the requirements of this permit, and submitted to the permitting authority for review, must include all necessary calculations. Thereafter, for the remainder of the permit term, application rates may be calculated annually, or immediately prior to land application, if all data and calculations are appropriately documented in the NMP.

- i) Identify and maintain site specific records to document the implementation and management of the minimum elements described in Sections III.A.2.a)-h and in compliance with the permit.
3. Signatory. The NMP shall be signed by the owner/operator or other signatory authority in accordance with Section V.C.5 (Signatory Requirements) of this permit.
 4. NMP Availability. A current copy of the NMP shall be kept on site at the permitted facility in accordance with Section IV.A of this permit and provided to the permitting authority upon request.
 5. Changes to the NMP
 - a) When a CAFO owner or operator covered by this permit makes changes to the CAFO's NMP previously submitted to EPA, the CAFO owner or operator must provide EPA with the most current version of the CAFO's NMP and identify changes from the previous version
 - b) When changes to a NMP are submitted to EPA, EPA will review the revised NMP to ensure that it meets the requirements of Section II and Section III.A.2. If EPA determines that the changes to the NMP necessitate revision to the terms of the NMP incorporated into the permit issued to the CAFO, EPA will determine whether such changes are substantial as defined by 40 CFR 122.42(e)(6). Substantial changes to the terms of a NMP incorporated as terms and conditions of a permit include, but are not limited to:
 - (i) Addition of new land application areas not previously included in the CAFO's NMP;
 - (ii) Changes to the maximum amounts of nitrogen and phosphorus derived from all sources for each crop;
 - (iii) Addition of any crop or other uses not included in the terms of the CAFO's NMP; and
 - (iv) Changes to site specific components of the CAFO's NMP, where such changes are likely to increase the risk of nitrogen and phosphorus transport to waters of the United States.
 - c) If EPA determines that the changes to the terms of the NMP are not substantial, EPA will make the revised NMP publicly available and include it in the permit file, revise the terms of the NMP incorporated into the permit, and notify the permittee and the public of any changes to the terms of the NMP that are incorporated into the permit.

- d) If EPA determines that the changes to the terms of the NMP are substantial, EPA will provide the public with the opportunity to comment upon the changes to the NMP and the information submitted by the CAFO owner or operator as set forth in Section III.A.2. of this permit. EPA will respond to all significant comments received during the comment period. The process for public comments, hearing requests and the hearing process, if a hearing is held, will follow the procedures set forth in 40 CFR 124.11 through 124.13.

EPA may require the permittee to further revise the NMP, if necessary. Once EPA incorporates the revised terms of the NMP into the permit, EPA will notify the permittee of the revised terms and conditions of the permit.

B. Lagoon Liner Requirements

Liner Requirements: CAFOs constructing new wastewater or manure storage structures or modifying existing wastewater or manure storage structures shall have a liner that is constructed and maintained in accordance with Idaho NRCS practice standards. Any damage to the liner must be evaluated by a Professional Engineer and corrected within thirty (30) days of the damage, unless the Permitting Authority approves an alternative schedule. The permittee must submit the request within thirty (30) days of the damage, and it must include the Professional Engineer's evaluation of the risks of pollutant releases if the liner is not repaired immediately. All documentation of liner maintenance shall be kept with the NMP.

C. Facility Closure

The following conditions shall apply to the closure of lagoons and other earthen or synthetic lined basins and other manure, litter, or process wastewater storage and handling structures:

1. Closure of Lagoons and Other Surface Impoundments
 - a) No lagoon or other earthen or synthetic lined basin shall be permanently abandoned.
 - b) Lagoons and other earthen or synthetic lined basins shall be maintained at all times until closed in compliance with this section.
 - c) All lagoons and other earthen or synthetic lined basins that are no longer needed as a part of a waste management system and are to be permanently decommissioned or converted for another use must be properly closed consistent with the Idaho NRCS Practice Standard Code 360 contained in Natural Resources Conservation Service Field Office Technical Guide (Appendix B). Consistent with this standard the permittee shall remove all waste materials to the maximum extent practicable and dispose of them in accordance with the permittee's NMP, unless otherwise authorized by EPA.
 - d) For any lagoon or other earthen or synthetic lined basin that is not in use for a period of twelve (12) consecutive months but will not be permanently decommissioned or converted to another use, the permittee shall:

- (i) Maintain the structure as though it were actively in use in order to prevent compromise of structural integrity.
 - (ii) The permittee shall notify EPA, in writing, of the action taken, and shall conduct routine inspections, maintenance, and record keeping as though the structure were in use. Prior to restoration of use of the structure, the permittee shall notify EPA, in writing, and provide the opportunity for inspection. The permittee shall properly handle and dispose of the water used to preserve the integrity synthetic or earthen liner during periods of non-use in accordance with the NMP.
- e) Unless otherwise authorized by EPA, completion of closure for lagoons and other earthen or synthetic lined basins shall occur as promptly as practicable after the permittee ceases to operate or, if the permittee has not ceased operations, twelve (12) months from the date on which the use of the structure ceased, unless the lagoons or basins are being maintained for possible future use in accordance with the requirements above.
2. Closure Procedures for Other Manure, Litter, or Process Wastewater Storage and Handling Structure

No other manure, litter, or process wastewater storage and handling structure shall be abandoned. Closure of all such structures shall occur as promptly as practicable within twelve (12) months after the date on which the use of the structure ceased, unless the lagoons or basins are being maintained for possible future use in accordance with the requirements above. To close a manure, litter, or process wastewater storage and handling structure, the permittee shall remove all manure, litter, or process wastewater and dispose of it in accordance with the permittee's NMP, or document its transfer from the permitted facility in accordance with off-site transfer requirements specified in this permit Section III.D, unless otherwise authorized by EPA.

D. Requirements for the Transfer of Manure, Litter, and Process Wastewater

1. In cases where CAFO-generated manure, litter, or process wastewater is sold or given away, the permittee must comply with the following conditions:
 - a) Maintain records showing the date and amount of manure, litter, and/or process wastewater that leaves the permitted facility;
 - b) Record the name and address of the recipient;
 - c) Provide the recipient(s) with representative information on the nutrient content of the manure, litter, and/or process wastewater analyzed in accordance with Section III.A.2.g)(i); and
 - d) Retain the records on-site, for a period of five years, and submit the records to EPA, upon request.

IV. RECORDS, REPORTING, MONITORING, AND NOTIFICATION

A. Records Management

1. Record Keeping Requirements for the Production Area

The permittee must maintain on-site for a period of five (5) years from the date they are created a complete copy of the NOI, the NMP, records to document the implementation and management of Section II.A and Section III.A.2.a)-e, Section IV.D and Section IV.A.1.a)-i below. The permittee must make these records available to EPA upon request.

- a) Records documenting the inspections of all storage, containment and treatment structures as required under Section II.A.2.a) and Section III.A.2.a);
- b) Weekly records of the depth of the manure and process wastewater in storage, containment and/or treatment structure(s), as applicable, as indicated by the depth marker under Section II.A.2.b);
- c) Documentation of whether or not the wastewater level in all liquid waste storage structures is below the level required to maintain capacity to store the runoff and precipitation from a 25-year, 24-hour storm under Section II.A.2.b);
- d) Records documenting the inspections of all stormwater diversion and channel structures under Section III.A.2.c);
- e) Records documenting the inspections of all water line inspections, including drinking and cooling water lines and whether or not leaks were discovered;
- f) For all structures in Section II.A.2.a)(i)-iii, records documenting any actions taken to correct deficiencies required under Section II.A.2.c). Deficiencies not corrected with thirty (30) days must be accompanied by an explanation of the factors preventing immediate correction;
- g) Records of mortalities management and practices used by the permittee to meet the requirements of Section II.A.2.d) and Section III.A.2.b);
- h) Records documenting the current design of any wastewater or manure storage structure to meet the requirements of Section II.A.1.b). including volume for solids accumulation, design treatment volume, total design volume, and approximate number of days of storage capacity; and
- i) Records of the date, time, and estimated volume of any overflow and additional requirements of Section IV.D.

2. Record Keeping Requirements for the Land Application Area

Each permittee must maintain on-site for a period of five (5) years from the date they are created, a complete copy of the information required by Section II.B and Section III.A.2.f)-i, and the records specified in Section IV.A.2.a)-g below. The permittee must make these records available to EPA upon request. For every field, provide the following information associated with the same unique field identification used in the NMP:

- a) The date(s) manure, litter, or process waste water application was begun for each field, for each land application event and all methods associated with the application of the manure, litter or process wastewater, including application method, incorporation method, soil surface conditions, weather conditions, number of acres utilized, amounts of manure, litter and process wastewater, and total amounts of nitrogen and phosphorus applied under Sections II.B.2, 3 and 5 and Section III.A.2.h);
- b) Documentation of all manure, litter or process wastewater sample collection and analysis protocols under Section II.B.6 and Section III.A.2.g)(i);
- c) Documentation of all soil sample collection and analysis protocols under Section II.B.6 and Section III.A.2.g)(ii);
- d) Documentation that all required setbacks, buffers or approved alternatives and conservation practices identified in the NMP were observed and/or implemented, and an explanation for any deviation from these practices under Section II.B.4 and Section II.B.8;
- e) The date that the equipment used for the land application event was last inspected under Section II.B.7; and
- f) Documentation for all requirements for manure, litter and process wastewater transfers under Section III.D.
- g) Documentation of visual inspections of potential land application area discharge locations and land application setback(s) or compliance alternative(s) specified in Sections II.B.9.b) and c).

B. Annual Reporting Requirements

1. The permittee shall submit an annual report by March 1st of each year. Prior to December 20, 2020 reports must be submitted electronically or in hard copy to EPA, the appropriate IDEQ district office and Idaho State Department of Agriculture. Hard copies may be submitted to the addresses below.

U.S. EPA Region 10
Attn: ICIS Data Entry Team
1200 6th Avenue, Suite 155 ECAD-101
Seattle, Washington 98101-3188

Idaho State Department of Agriculture
Division of Animal Industries
P.O. Box 790
Boise, Idaho 83701

After December 20, 2020 annual reports must be submitted *electronically only* to IDEQ. Annual Reports must continue also be submitted to the Idaho State Department of Agriculture.

2. The permittee may seek an electronic reporting waiver by submitting a request. Prior to July 1, 2020 this request must be submitted to EPA. Beginning July 1, 2020 this

request must be submitted to IDEQ. This waiver request should contain the following details: facility name; NPDES permit number; facility address; name, address and contact information for the owner, operator, or duly authorized facility representative; and a brief written statement regarding the basis for claiming such a temporary waiver. The request will be either approved or denied within 120 days. The duration of the temporary waiver will not exceed 5 years.

3. The annual report must include all of the information detailed in the Annual Report Template in Appendix H. The permittee may use the fillable pdf template provided, or may compile all of the required information in a separate document. Completion and electronic submittal of the Annual Report template shall fulfill the electronic reporting requirements.

C. Notification of Unauthorized Discharges Resulting from Manure, Litter, and Process Wastewater Storage, Handling, On-site Transport and Application

1. If, for any reason, there is an unauthorized discharge of pollutants to a water of the United States, the permittee is required to make immediate oral notification within 24-hours to the EPA Region 10, NPDES Compliance Section, Enforcement and Compliance Assurance Division, Seattle, WA at 206-553-1846 and notify ISDA, the appropriate IDEQ regional office, and the appropriate county authorities in writing, within five (5) working days of the discharge of pollutants to a water of the United States from the facility. In addition, the permittee shall keep a copy of the notification submitted to EPA and ISDA together with the other records required by this permit. The discharge notification shall include the following information:
 - a) A description of the discharge and its cause, including a description of the flow path to the receiving water body and an estimate of the flow and volume discharged; and
 - b) The period of non-compliance, including exact dates and times, the anticipated time it is expected to continue, and steps taken or planned to reduce, eliminate and prevent recurrence of the discharge.

D. Monitoring Requirements for All Discharges from Wastewater or Manure Storage Structures

1. In the event of any overflow or other discharge, including any subsurface discharges, of pollutants to waters of the United States from a manure or wastewater storage structure, whether or not authorized by this permit the following actions shall be taken:
 - a) All discharges from wastewater or manure storage structures to waters of the United States shall be sampled and analyzed. Samples must, at a minimum, be analyzed for the following parameters: total nitrogen, nitrate nitrogen, ammonia nitrogen, total phosphorus, *E. coli*, five-day biochemical oxygen demand (BOD5), total suspended solids, pH, and temperature. The discharge must be analyzed in accordance with approved EPA methods for water analysis listed in 40 CFR Part 136;

- b) For any overflow or other discharge, including any subsurface discharge, subject to monitoring under paragraph 1, if the duration of the discharge event exceeds 24 hours, the discharge shall be monitored daily until the discharge ceases.
2. Record an estimate of the volume of the release and the date and time;
 3. Samples shall consist of grab samples collected from the point of overflow or discharge from the waste impoundment or production area. Subsurface discharges shall be sampled at the point of discharge to the receiving water. If the point of discharge to the receiving water is inaccessible, samples of subsurface discharges shall be collected at a point that provides a sample that is representative of the discharge to the receiving water. A minimum of one sample shall be collected within 30 minutes of the detection of the overflow or discharge and the sample(s) of the overflow or discharge must be collected and analyzed in accordance with EPA approved methods for water analysis listed in 40 CFR Part 136. The sample(s) collected from the overflow or discharge must be representative of the overflow or discharge;
 4. If conditions are not safe for sampling, the permittee must provide documentation of why samples could not be collected and analyzed. For example, the permittee may be unable to collect samples during dangerous weather conditions (such as local flooding, high winds, hurricane, tornadoes, electrical storms, etc.). However, once dangerous conditions have passed, the permittee shall collect a sample from the wastewater or manure storage structure from which the discharge occurred;
 5. The analytical results of the representative sample(s) taken from the overflow or discharge must be submitted to EPA Region 10, Enforcement and Compliance Assurance Division, within thirty (30) days of the overflow or discharge. Copies of the analytical results shall also be submitted to ISDA and the IDEQ state and appropriate regional office at the addresses listed in Section I.B.3 of this permit; and
 6. Subsurface Discharge Monitoring Plan. For those CAFOs required to include a subsurface discharge monitoring plan in the NMP, pursuant to Section III.A.2.a)(iii). or iv of this permit, the plan that is included in the CAFO's NMP must include site-specific information and procedures that will be implemented to address the following:
 - a) Identification of the structures and/or locations to be monitored;
 - b) Routine periodic monitoring adequate to identify leaks, damage, and other issues that could cause a subsurface discharge, including the frequency of monitoring and the specific technology or protocols that will be used;
 - c) Criteria or protocols that will be used to determine whether a subsurface discharge has occurred; and
 - d) Site specific protocols for monitoring subsurface discharges in accordance with the requirements in this Section IV.D.

E. Monitoring Requirements for Discharges from Land Application Areas

1. In the event of any runoff or discharge from a CAFO's land application area to a water of the United States, the actions specified below must be taken. Discharges subject to monitoring requirements include, but are not limited to, (1) dry weather discharges resulting from land application of manure, litter, or process wastewater, including discharges through tile drains, ditches, or other conveyances, and irrigation return, and (2) stormwater or snowmelt runoff or discharges of manure, litter, or process wastewater that has not been applied in accordance with site specific nutrient management practices that ensure appropriate agricultural utilization of the nutrients in the manure, litter or process wastewater as provided in 33 U.S.C. § 1362(14) and 40 CFR § 122.23(e).
 - a) All discharges that meet either of the two criteria specified in Section E.1 above from land application areas to waters of the United States shall be sampled and analyzed as follows.
 - (i) Grab samples of the discharge must be collected at a location prior to mixing with the receiving waters, that will provide for a representative sample of the discharge. The specific sampling location(s) must be documented.
 - (ii) Samples shall be collected in accordance with the protocols described in [Section 3 of EPA's Industrial Stormwater Monitoring and Sampling Guide](#) (EPA 832-B-09-003, April 2021). For sheet flow discharges that are too shallow to collect with a sample bottle, the protocols in the Industrial Stormwater Monitoring and Sampling Guide may be supplemented with procedures for installing a temporary barrier device or similar structure to intercept runoff flow.
 - (iii) Samples must, at a minimum, be analyzed for the following parameters: total Kjeldahl nitrogen (TKN), nitrate nitrogen, nitrite nitrogen, total phosphorus, E. coli, fecal coliform, and five-day biochemical oxygen demand (BOD₅).
 - (iv) The discharge samples must be analyzed in accordance with approved EPA methods for water analysis listed in 40 CFR Part 136.
 - b) Samples of the receiving water shall be collected upstream and downstream of the point of discharge to the receiving stream as follows.
 - (i) Upstream samples must be collected at a location that provides a representative sample of the water quality immediately upstream of the discharge, prior to mixing with the discharge. Downstream samples must be collected at a location that provides a representative sample of the water quality after mixing with the discharge and prior to the introduction of other pollutant sources. The specific sampling locations must be documented.
 - (ii) Samples shall be collected in accordance with EPA Region 4's Surface Water Sampling procedures (LSASDPROC-201-R5, December 2021).

- (iii) Grab samples of ambient receiving waters must, at a minimum, be analyzed for the following parameters: total Kjeldahl nitrogen (TKN), nitrate nitrogen, nitrite nitrogen, total phosphorus, E. coli, fecal coliform, and five-day biochemical oxygen demand (BOD₅).
- (iv) The receiving water samples must be analyzed in accordance with approved EPA methods for water analysis listed in 40 CFR Part 136.
- c) A log shall be kept of the receiving water conditions throughout the reach bounded by the upstream and downstream sampling locations during the discharge event. The log must document any discoloration; bottom deposits; condition of any aquatic life observed; presence of visible films, sheens or coatings; fungi, slimes or objectionable growths; and potential nuisance conditions.
- d) For any discharge subject to monitoring under Section E.1, if the duration of the discharge event exceeds 24 hours, the discharge and receiving water shall be monitored daily until the discharge ceases.
- e) An estimate of the volume of the discharge and the date and time must be recorded;
- f) If conditions are not safe for sampling, the permittee must provide documentation of why samples could not be collected and analyzed. For example, the permittee may be unable to collect samples during dangerous weather conditions (such as local flooding, high winds, hurricane, tornadoes, electrical storms, etc.). However, once dangerous conditions have passed, the permittee shall collect a sample of the discharge. If the discharge stops before dangerous conditions have passed, and therefore cannot be sampled, the permittee shall record the estimated time, duration, and volume of the discharge, and the reason the sample could not be collected, and include this information in the Notification of Unauthorized Discharge submitted in accordance with Section IV.C of this permit.
- g) The analytical results of the representative sample(s) taken from the discharge and receiving water must be submitted to EPA Region 10, Enforcement and Compliance Assurance Division, within thirty (30) days of the discharge. Copies of the analytical results shall also be submitted to ISDA and the IDEQ state and appropriate regional office at the addresses listed in Section I.B.3 of this permit.

F. Spills / Releases in Excess of Reportable Quantities

1. This permit does not relieve the permittee of the federal reporting requirements of 40 CFR §§ 110, 117 and 302 relating to spills or other releases of oils or hazardous substances.

Where a release containing a hazardous substance or oil in an amount equal to or in excess of a reportable quantity established under either 40 CFR § 110, 40 CFR § 117 or 40 CFR § 302, occurs during a 24-hour period:

- a) The permittee must provide notice to the National Response Center (NRC) (800-424-8802; in the Washington, DC, metropolitan area, call 202-267-2675) in

accordance with the requirements of 40 CFR §§ 110, 117 and 302 as soon as site staff have knowledge of the discharge; and

- b) The permittee must, within 7 calendar days of knowledge of the release, provide a description of the release, the circumstances leading to the release, and the date of the release. The permittee must also implement measures to prevent the reoccurrence of such releases and to respond to such releases.
2. Any spill of hazardous material must be immediately reported to the appropriate IDEQ regional office (see table below). Spills of petroleum products that exceed 25 gallons or that cause a visible sheen on nearby surface waters should be reported to IDEQ within 24-hours. Petroleum product spills of less than 25 gallons that do not cause a sheen on nearby surface waters shall only be reported to IDEQ if clean-up cannot be accomplished within 24-hours.

IDEQ Regional Office contact information for reporting spills

Regional Office	Phone #	Regional Office	Phone #
Boise	(208) 373-0550	Lewiston	(208) 799-4370
Coeur d’Alene	(208) 769-1422	Pocatello	(208) 236-6160
Idaho Falls	(208) 528-2650	Twin Falls	(208) 736-2190

Outside of regular business hours, qualified spills should be reported to the IDEQ 24-hour reporting hotline at 1-833-IPDES24.

V. STANDARD PERMIT CONDITIONS

A. General Monitoring, Recording, and Reporting Requirements

1. Representative Sampling

Samples and measurements must be representative of the volume and nature of the monitored discharge.

2. Reporting of Monitoring Results

If applicable, the permittee must submit the legible originals of the monitoring results to the Director of the Enforcement and Compliance Assurance Division with copies to ISDA at the following addresses:

US EPA Region 10
 Attn: ICIS Data Entry Team
 1200 Sixth Avenue, Suite 155 ECAD 20-C04
 Seattle, Washington 98101-3140

Idaho State Department of Agriculture
Division of Animal Industries
P.O. Box 790
Boise, ID 83701

3. Monitoring Procedures

Monitoring must be conducted according to test procedures approved under 40 CFR § 136, unless other test procedures have been specified in this permit or approved by EPA as an alternate test procedure under 40 CFR § 136.5.

4. Additional Monitoring by Permittee

If the permittee monitors any pollutant more frequently than required by this permit, using test procedures approved under 40 CFR § 136 or as specified in this permit, the permittee must include the results of this monitoring in the calculation and reporting of the data submitted to EPA.

Upon request by EPA, the permittee must submit results of any other sampling, regardless of the test method used.

5. Records Contents.

Records of monitoring information must include:

- a) The date, exact place, and time of sampling or measurements;
- b) The name(s) of the individual(s) who performed the sampling or measurements;
- c) The date(s) analyses were performed;
- d) The names of the individual(s) who performed the analyses;
- e) The analytical techniques or methods used; and
- f) The results of such analyses.

6. Retention of Records

The permittee must retain records of all monitoring information, including, all calibration and maintenance records and all original strip chart recordings for continuous monitoring instrumentation, copies of all reports required by this permit, a copy of the NPDES permit, and records of all data used to complete the application for this permit, for a period of at least five years from the date of the sample, measurement, report or application. This period may be extended by request of EPA or State/Tribal agency at any time.

7. Other Noncompliance Reporting

The permittee must report all instances of noncompliance, not required to be reported within 24 hours, at the time that monitoring reports for Section V.A.2 (Reporting of Monitoring Results) are submitted. The reports must contain the information listed in Section IV.B of this permit ("Notification of Discharges Resulting from Manure,

Litter, and Process Wastewater Storage, Handling, On- site Transport and Application”).

8. Changes in Discharge of Toxic Pollutant

The permittee must notify the Director of the Water Division and IDEQ as soon as it knows, or has reason to believe:

- a) That any activity has occurred or will occur that would result in the discharge, on a routine or frequent basis, of any toxic pollutant that is not limited in the permit, if that discharge may reasonably be expected to exceed the highest of the following “notification levels”:
 - (i) One hundred micrograms per liter (100 ug/l);
 - (ii) Two hundred micrograms per liter (200 ug/l) for acrolein and acrylonitrile; five hundred micrograms per liter (500 ug/l) for 2,4- dinitrophenol and for 2-methyl-4, 6-dinitrophenol; and one milligram per liter (1 mg/l) for antimony;
 - (iii) Five (5) times the maximum concentration value reported for that pollutant in the permit application in accordance with 40 CFR § 122.21(g)(7); or
 - (iv) The level established by EPA in accordance with 40 CFR § 122.44(f).
- b) That any activity has occurred or will occur that would result in any discharge, on a non-routine or infrequent basis, of any toxic pollutant that is not limited in the permit, if that discharge may reasonably be expected to exceed the highest of the following “notification levels”:
 - (i) Five hundred micrograms per liter (500 ug/l);
 - (ii) One milligram per liter (1 mg/l) for antimony;
 - (iii) Ten (10) times the maximum concentration value reported for that pollutant in the permit application in accordance with 40 CFR § 122.21(g)(7); or
 - (iv) The level established by EPA in accordance with 40 CFR § 122.44(f).
- c) The permittee must submit the notification to the Water Division at the following address:

US EPA Region 10
Attn: NPDES Permits Section Manager
1200 Sixth Avenue, Suite 155, 19-C04
Seattle, Washington 98101-3188

B. Compliance Responsibilities

1. Duty to Comply

The permittee must comply with all conditions of this permit. Any permit noncompliance constitutes a violation of the Act and is grounds for enforcement action, for permit termination, revocation and reissuance, or modification, or for denial of a permit renewal application.

2. Penalties for Violations of Permit Conditions

- a) **Civil and Administrative Penalties.** Pursuant to 40 CFR § 19 and the Act, any person who violates section 301, 302, 306, 307, 308, 318 or 405 of the Act, or any permit condition or limitation implementing any such sections in a permit issued under section 402, or any requirement imposed in a pretreatment program approved under sections 402(a)(3) or 402(b)(8) of the Act, is subject to a civil penalty not to exceed the maximum amounts authorized by Section 309(d) of the Act and the Federal Civil Penalties Inflation Adjustment Act (28 U.S.C. § 2461 note) as amended by the Debt Collection Improvement Act (31 U.S.C. § 3701 note) (currently \$64,618 per day for each violation).
- b) **Administrative Penalties.** Any person may be assessed an administrative penalty by the Administrator for violating section 301, 302, 306, 307, 308, 318 or 405 of this Act, or any permit condition or limitation implementing any of such sections in a permit issued under section 402 of this Act. Pursuant to 40 CFR 19 and the Act, administrative penalties for Class I violations are not to exceed the maximum amounts authorized by Section 309(g)(2)(A) of the Act and the Federal Civil Penalties Inflation Adjustment Act (28 U.S.C. § 2461 note) as amended by the Debt Collection Improvement Act (31 U.S.C. § 3701 note) (currently \$25,847 per violation, with the maximum amount of any Class I penalty assessed not to exceed \$64,618). Pursuant to 40 CFR 19 and the Act, penalties for Class II violations are not to exceed the maximum amounts authorized by Section 309(g)(2)(B) of the Act and the Federal Civil Penalties Inflation Adjustment Act (28 U.S.C. § 2461 note) as amended by the Debt Collection Improvement Act (31 U.S.C. § 3701 note) (currently \$25,847 per day for each day during which the violation continues, with the maximum amount of any Class II penalty not to exceed \$323,081).
- c) **Criminal Penalties:**
 - (i) **Negligent Violations.** The Act provides that any person who negligently violates sections 301, 302, 306, 307, 308, 318, or 405 of the Act, or any condition or limitation implementing any of such sections in a permit issued under section 402 of the Act, or any requirement imposed in a pretreatment program approved under section 402(a)(3) or 402(b)(8) of the Act, is subject to criminal penalties of \$2,500 to \$25,000 per day of violation, or imprisonment of not more than 1 year, or both. In the case of a second or subsequent conviction for a negligent violation, a person shall be subject to criminal penalties of not more than \$50,000 per day of violation, or by imprisonment of not more than 2 years, or both.
 - (ii) **Knowing Violations.** Any person who knowingly violates such sections, or such conditions or limitations is subject to criminal penalties of \$5,000 to \$50,000 per day of violation, or imprisonment for not more than 3 years, or both. In the case of a second or subsequent conviction for a knowing violation, a person shall be subject to criminal penalties of not more than

\$100,000 per day of violation, or imprisonment of not more than 6 years, or both.

- (iii) **Knowing Endangerment.** Any person who knowingly violates section 301, 302, 303, 306, 307, 308, 318 or 405 of the Act, or any permit condition or limitation implementing any of such sections in a permit issued under section 402 of the Act, and who knows at that time that he thereby places another person in imminent danger of death or serious bodily injury, shall, upon conviction, be subject to a fine of not more than \$250,000 or imprisonment of not more than 15 years, or both. In the case of a second or subsequent conviction for a knowing endangerment violation, a person shall be subject to a fine of not more than \$500,000 or by imprisonment of not more than 30 years, or both. An organization, as defined in section 309(c)(3)(B)(iii) of the Act, shall, upon conviction of violating the imminent danger provision, be subject to a fine of not more than \$1,000,000 and can be fined up to \$2,000,000 for second or subsequent convictions.
- (iv) **False Statements.** The Act provides that any person who falsifies, tampers with, or knowingly renders inaccurate any monitoring device or method required to be maintained under this permit shall, upon conviction, be punished by a fine of not more than \$10,000, or by imprisonment for not more than 2 years, or both. If a conviction of a person is for a violation committed after a first conviction of such person under this paragraph, punishment is a fine of not more than \$20,000 per day of violation, or by imprisonment of not more than 4 years, or both. The Act further provides that any person who knowingly makes any false statement, representation, or certification in any record or other document submitted or required to be maintained under this permit, including monitoring reports or reports of compliance or non-compliance shall, upon conviction, be punished by a fine of not more than \$10,000 per violation, or by imprisonment for not more than 6 months per violation, or by both.

3. Need to Halt or Reduce Activity not a Defense

It shall not be a defense for the permittee in an enforcement action that it would have been necessary to halt or reduce the permitted activity in order to maintain compliance with this permit.

4. Duty to Mitigate

The permittee must take all reasonable steps to minimize or prevent any discharge in violation of this permit that has a reasonable likelihood of adversely affecting human health or the environment.

5. Proper Operation and Maintenance

The permittee must at all times properly operate and maintain all facilities and systems of treatment and control (and related appurtenances) which are installed or

used by the permittee to achieve compliance with the conditions of this permit. Proper operation and maintenance also includes adequate laboratory controls and appropriate quality assurance procedures. This provision requires the operation of back-up or auxiliary facilities or similar systems which are installed by the permittee only when the operation is necessary to achieve compliance with the conditions of the permit.

6. Bypass of Treatment Facilities

- a) Bypass not exceeding limitations. The permittee may allow any bypass to occur that does not cause effluent limitations to be exceeded, but only if it also is for essential maintenance to assure efficient operation. These bypasses are not subject to the provisions of paragraphs b and c of this Part.
- b) Notice.
 - (i) Anticipated bypass. If the permittee knows in advance of the need for a bypass, it must submit prior written notice, if possible at least 10 days before the date of the bypass.
 - (ii) Unanticipated bypass. The permittee must submit notice of an unanticipated bypass as required under Section IV.C. (“Notification of Discharges Resulting from Manure, Litter, and Process Wastewater Storage, Handling, On-site Transport and Application”).
- c) Prohibition of bypass.
 - (i) Bypass is prohibited, and the Director of the Enforcement and Compliance Assurance Division may take enforcement action against the permittee for a bypass, unless:
 - (a) The bypass was unavoidable to prevent loss of life, personal injury, or severe property damage;
 - (b) There were no feasible alternatives to the bypass, such as the use of auxiliary treatment facilities, retention of untreated wastes, or maintenance during normal periods of equipment downtime. This condition is not satisfied if adequate back-up equipment should have been installed in the exercise of reasonable engineering judgment to prevent a bypass that occurred during normal periods of equipment downtime or preventive maintenance; and
 - (c) The permittee submitted notices as required under paragraph b of this Section.
 - (ii) The Director of the Enforcement and Compliance Assurance Division may approve an anticipated bypass, after considering its adverse effects, if the Director determines that it will meet the three conditions listed above in paragraph c.i. of this Part.

7. Upset Conditions

- a) Effect of an upset. An upset constitutes an affirmative defense to an action brought for noncompliance with such technology-based permit effluent limitations if the permittee meets the requirements of paragraph b of this Section. No determination made during administrative review of claims that noncompliance was caused by upset, and before an action for noncompliance, is final administrative action subject to judicial review.
 - b) Conditions necessary for a demonstration of upset. To establish the affirmative defense of upset, the permittee must demonstrate, through properly signed, contemporaneous operating logs, or other relevant evidence that:
 - (i) An upset occurred and that the permittee can identify the cause(s) of the upset;
 - (ii) The permitted facility was at the time being properly operated;
 - (iii) The permittee submitted notice of the upset as required under Section IV.C, "Notification of Discharges Resulting from Manure, Litter, and Process Wastewater Storage, Handling, On- site Transport and Application;" and
 - (iv) The permittee complied with any remedial measures required under Section V.B.4, "Duty to Mitigate."
 - c) Burden of proof. In any enforcement proceeding, the permittee seeking to establish the occurrence of an upset has the burden of proof.
8. Toxic Pollutants

The permittee must comply with effluent standards or prohibitions established under Section 307(a) of the Act for toxic pollutants within the time provided in the regulations that establish those standards or prohibitions, even if the permit has not yet been modified to incorporate the requirement.

9. Planned Changes

The permittee must give written notice to the Director of the Water Division as specified in Section III.A.5.b). as soon as possible of any planned physical alterations or additions to the permitted facility whenever:

- a) The alteration or addition to a permitted facility may meet one of the criteria for determining whether a facility is a new source as determined in 40 CFR § 122.29(b); or
- b) The alteration or addition could significantly change the nature or increase the quantity of pollutants discharged. This notification applies to pollutants that are subject neither to effluent limitations in the permit, nor to notification requirements under Section V.A.8. ("Changes in Discharge of Toxic Substances").

10. Anticipated Noncompliance

The permittee must give written advance notice to the Director of the Enforcement and Compliance Assurance Division any planned changes in the permitted facility or activity that may result in noncompliance with this permit.

C. General Provisions

1. Permit Actions

This permit may be modified, revoked and reissued, or terminated for cause as specified in 40 CFR §§ 122.62, 122.64, or 124.5. The filing of a request by the permittee for a permit modification, revocation and reissuance, termination, or a notification of planned changes or anticipated noncompliance does not stay any permit condition.

2. Duty to Reapply

If the permittee intends to continue an activity regulated by this permit after the expiration date of this permit, the permittee must apply for and obtain a new permit. In accordance with 40 CFR § 122.21(d), and unless permission for the application to be submitted at a later date has been granted by the Regional Administrator, the permittee must submit a new application at least 180 days before the expiration date of this permit.

3. Duty to Provide Information

The permittee must furnish to EPA, within the time specified in the request, any information that EPA may request to determine whether cause exists for modifying, revoking and reissuing, or terminating this permit, or to determine compliance with this permit. The permittee must also furnish to EPA, upon request, copies of records required to be kept by this permit.

4. Other Information

When the permittee becomes aware that it failed to submit any relevant facts in a permit application, or that it submitted incorrect information in a permit application or any report to EPA, it must promptly submit the omitted facts or corrected information in writing.

5. Signatory Requirements

All applications, reports or information submitted to EPA must be signed and certified as follows.

- a) All permit applications must be signed as follows:
 - (i) For a corporation: by a responsible corporate officer.
 - (ii) For a partnership or sole proprietorship: by a general partner or the proprietor, respectively.

- (iii) For a municipality, state, federal, Indian tribe, or other public agency: by either a principal executive officer or ranking elected official.
- b) All reports required by the permit and other information requested by EPA must be signed by a person described above or by a duly authorized representative of that person. A person is a duly authorized representative only if:
 - (i) The authorization is made in writing by a person described above;
 - (ii) The authorization specifies either an individual or a position having responsibility for the overall operation of the regulated facility or activity, such as the position of plant manager, operator of a well or a well field, superintendent, position of equivalent responsibility, or an individual or position having overall responsibility for environmental matters for the company; and
 - (iii) The written authorization is submitted to the Director of the Enforcement and Compliance Assurance Division.
- c) Changes to authorization. If an authorization under Section V.C.5.b) is no longer accurate because a different individual or position has responsibility for the overall operation of the facility, a new authorization satisfying the requirements of Section V.C.5.b) must be submitted to the Director of the Enforcement and Compliance Assurance Division and the Idaho State Department of Agriculture prior to or together with any reports, information, or applications to be signed by an authorized representative.
- d) Certification. Any person signing a document under this Section must make the following certification:

“I certify under penalty of law that this document and all attachments were prepared under my direction or supervision in accordance with a system designed to assure that qualified personnel properly gather and evaluate the information submitted. Based on my inquiry of the person or persons who manage the system, or those persons directly responsible for gathering the information, the information submitted is, to the best of my knowledge and belief, true, accurate, and complete. I am aware that there are significant penalties for submitting false information, including the possibility of fine and imprisonment for knowing violations.”

6. Availability of Reports

In accordance with 40 CFR § 2, information submitted to EPA pursuant to this permit may be claimed as confidential by the permittee. In accordance with the Act, permit applications, permits and effluent data are not considered confidential. Any confidentiality claim must be asserted at the time of submission by stamping the words “confidential business information” on each page containing such information. If no claim is made at the time of submission, EPA may make the information available to the public without further notice to the permittee. If a claim is asserted,

the information will be treated in accordance with the procedures in 40 CFR § 2, Subpart B (Public Information) and 41 Fed. Reg. 36902 through 36924 (September 1, 1976), as amended.

7. Inspection and Entry

The permittee must allow the Director of the Enforcement and Compliance Assurance Division, EPA Region 10; State/Tribal agency; or an authorized representative (including an authorized contractor acting as a representative of the Administrator), upon the presentation of credentials and other documents as may be required by law, to:

- a) Enter upon the permittee's premises where a regulated facility or activity is located or conducted, or where records must be kept under the conditions of this permit;
- b) Have access to and copy, at reasonable times, any records that must be kept under the conditions of this permit;
- c) Inspect at reasonable times any facilities, equipment (including monitoring and control equipment), practices, or operations regulated or required under this permit; and
- d) Sample or monitor at reasonable times, for the purpose of assuring permit compliance or as otherwise authorized by the Act, any substances or parameters at any location.

8. Property Rights

The issuance of this permit does not convey any property rights of any sort, or any exclusive privileges, nor does it authorize any injury to persons or property or invasion of other private rights, nor any infringement of federal, tribal, state or local laws or regulations.

9. Transfers

This permit is not transferable to any person except after written notice to the Director of the Water Division as specified in Part I.D. The Director may require modification or revocation and reissuance of the permit to change the name of the permittee and incorporate such other requirements as may be necessary under the Act. (See 40 CFR § 122.61; in some cases, modification or revocation and reissuance is mandatory).

10. State Laws

Nothing in this permit shall be construed to preclude the institution of any legal action or relieve the permittee from any responsibilities, liabilities, or penalties established pursuant to any applicable state law or regulation under authority preserved by Section 510 of the Act.

VI. DEFINITIONS

1. **Animal feeding operation (AFO)** means a lot or facility (other than an aquatic animal production facility) where the following conditions are met: (i) animals (other than aquatic animals) have been, are, or will be stabled or confined and fed or maintained for a total of forty-five (45) days or more in any twelve (12) month period, and (ii) crops, vegetation, forage growth, or post-harvest residues are not sustained in the normal growing season over any portion of the lot or facility.
2. **Application** means the EPA standard national forms for seeking coverage under for an NPDES permit, including any additions, revisions or modifications to the forms; or forms approved by EPA for use in “approved States,” including any approved modifications or revisions [e.g. for NPDES general permits, a written “notice of intent” pursuant to 40 CFR § 122.28; for NPDES individual permits, Form 1 and 2B pursuant to 40 CFR § 122.1(d)].
3. **Concentrated animal feeding operation (CAFO)** means an AFO which is defined as a Large CAFO or Medium CAFO by 40 CFR § 122.23 (b)(4) and (b)(6), or that is designated as a CAFO per 40 CFR § 122.23(b)(9)(c).
4. **Grab sample** means a sample which is taken from a waste stream on a one-time basis without consideration of the flow rate of the waste stream and without consideration of time.
5. **Land application** means the application of manure, litter, or process wastewater onto or incorporated into the soil.
6. **Land application area** means land under the control of a CAFO owner or operator, whether it is owned, rented, or leased, to which manure, litter, or process wastewater from the production area is or may be applied.
7. **Large CAFO** means an AFO that stables or confines as many as or more than the numbers of animals specified in any of the following categories: (i) 700 mature dairy cattle, whether milked or dry; (ii) 1,000 veal calves; (iii) 1,000 cattle other than mature dairy cows or veal calves. Cattle includes but is not limited to heifers, steers, bulls and cow/calf pairs; (iv) 2,500 swine each weighing 55 pounds or more; (v) 10,000 swine each weighing less than 55 pounds; (vi) 500 horses; (vii) 10,000 sheep or lambs; (viii) 55,000 turkeys; (ix) 30,000 laying hens or broilers, if the AFO uses a liquid manure handling system; (x) 125,000 chickens (other than laying hens), if the AFO uses other than a liquid manure handling system; (xi) 82,000 laying hens, if the AFO uses other than a liquid manure handling system; (xii) 30,000 ducks (if the AFO uses other than a liquid manure handling system); or (xiii) 5,000 ducks (if the AFO uses a liquid manure handling system).
8. **Liquid manure handling system** means a system that collects and transports or moves waste material with the use of water, such as in washing of pens and flushing of confinement facilities. This would include the use of water impoundments for manure and/or wastewater treatment.

9. **Manure** is defined to include manure, litter, bedding, compost and raw materials or other materials commingled with manure or set aside for land application or other use.
10. **Medium CAFO** means any AFO that stables or confines as many or more than the numbers of animals specified in any of the following categories: (i) 200 to 699 mature dairy cattle, whether milked or dry cows; (ii) 300 to 999 veal calves; (iii) 300 to 999 cattle other than mature dairy cows or veal calves. Cattle includes but is not limited to heifers, steers, bulls and cow/calf pairs; (iv) 750 to 2,499 swine each weighing 55 pounds or more; (v) 3,000 to 9,999 swine each weighing less than 55 pounds; (vi) 150 to 499 horses, (vii) 3,000 to 9,999 sheep or lambs, (viii) 16,500 to 54,999 turkeys, (ix) 9,000 to 29,999 laying hens or broilers, if the AFO uses a liquid manure handling system; (x) 37,500 to 124,999 chickens (other than laying hens), if the AFO uses other than a liquid manure handling system; (xi) 25,000 to 81,999 laying hens, if the AFO uses other than a liquid manure handling system; (xii) 10,000 to 29,999 ducks (if the AFO uses other than a liquid manure handling system); or (xiii) 1,500 to 4,999 ducks (if the AFO uses a liquid manure handling system) **and** either one of the following conditions are met (a) pollutants are discharged into waters of the United States through a man-made ditch, flushing system, or other similar man-made device; or (b) pollutants are discharged directly into waters of the United States which originate outside of and pass over, across, or through the facility or otherwise come into direct contact with the animals confined in the operation.
11. **Notice of Intent (NOI)** is a form submitted by the owner/operator applying for coverage under a general permit. It requires the applicant to submit the information necessary for adequate program implementation, including, at a minimum, the legal name and address of the owner or operator, the facility name and address, type of facility or discharges, and the receiving stream(s). [40 CFR § 122.28(b)(2)(ii)].
12. **Process wastewater** means water directly or indirectly used in the operation of the CAFO for any or all of the following: spillage or overflow from animal or poultry watering systems; washing, cleaning, or flushing pens, barns, manure pits, or other AFO facilities; direct contact swimming, washing, or spray cooling of animals; or dust control. Process wastewater also includes any water which comes into contact with or is a constituent of raw materials, products, or byproducts including manure, litter, feed, milk, eggs, or bedding.
13. **Production area** means that part of an AFO that includes the animal confinement area, the manure storage area, the raw materials storage area, and the waste containment areas. The animal containment area includes but is not limited to open lots, housed lots, feedlots, confinement houses, stall barns, free stall barns, milkrooms, milking centers, cowyards, barnyards, medication pens, walkers, animal walkways, and stables. The manure storage area includes but is not limited to lagoons, runoff ponds, storage sheds, stockpiles, under house or pit storages, liquid impoundments, static piles, and composting piles. The raw materials storage area

- includes but is not limited to feed silos, silage bunkers, and bedding materials. The waste containment area includes but is not limited to settling basins, and areas within berms and diversions which separate uncontaminated storm water. Also included in the definition of production area is any egg washing or egg processing facility, and any area used in the storage, handling, treatment, or disposal of mortalities.
14. **Small CAFO** means an AFO that is designated as a CAFO and is not a Medium CAFO.
 15. **Setback** means a specified distance from waters of the United States or potential conduits to waters of the United States where manure, litter, and process wastewater may not be land applied. Examples of conduits to surface waters include but are not limited to: Open tile line intake structures, sinkholes, and agricultural well heads.
 16. **The Act** means Federal Water Pollution Control Act as amended, also known as the Clean Water Act as amended, found at 33 USC 1251 et seq.
 17. **Vegetated buffer** means a narrow, permanent strip of dense perennial vegetation established parallel to the contours of and perpendicular to the dominant slope of the field for the purposes of slowing water runoff, enhancing water infiltration, and minimizing the risk of any potential nutrients or pollutants from leaving the field and reaching waters of the United States.
 18. **Waters of the United States** means: waters as defined in 40 CFR Part 122.2.

APPENDIX A - NOTICE OF INTENT - EPA FORM 2B

Water Permits Division



Application Form 2B

Concentrated Animal Feeding Operations and Concentrated Aquatic Animal Production Facilities

NPDES Permitting Program

Note: Complete this form *and* Form 1 if your facility is a new or existing concentrated animal feeding operation or concentrated aquatic animal production facility.

Paperwork Reduction Act Notice

The U.S. Environmental Protection Agency (EPA) estimates the average burden for concentrated animal feeding operation respondents to collect information and complete Form 2B to be 9.2 hours (8.7 hours to complete and submit the application and 0.5 hours to complete and submit a nutrient management plan). EPA estimates the average burden for concentrated aquatic animal production respondents to collect information and complete Form 2B to be 5.5 hours. These estimates include time for reviewing instructions, searching existing data sources, gathering and maintaining the needed data, and completing and reviewing the collection of information. Send comments about the burden estimates or any other aspect of this collection of information to the Chief, Information Policy Branch (PM-223), U.S. Environmental Protection Agency, 1200 Pennsylvania Avenue, NW, Washington, DC 20460, and to the Office of Information and Regulatory Affairs, Office of Management and Budget, 725 17th Street, NW, Washington, DC 20503, marked "Attention: Desk Officer for EPA."

FORM 2B—INSTRUCTIONS

General Instructions

Who Must Complete Form 2B?

You must complete Form 2B if you answered “Yes” to Item 1.2.1 on Form 1—that is, if you are a concentrated animal feeding operation (CAFO) or a concentrated aquatic animal production (CAAP) facility.

Where to File Your Completed Form

Submit your completed application package (Forms 1 and 2B) to your National Pollutant Discharge Elimination System (NPDES) permitting authority. Consult Exhibit 1–1 of Form 1’s “General Instructions” to identify your NPDES permitting authority.

Public Availability of Submitted Information

The U.S. Environmental Protection Agency (EPA) will make information from NPDES permit application forms available to the public for inspection and copying upon request. You may not claim any information on Form 2B (or related attachments) as confidential.

You may make a claim of confidentiality for any information that you submit to EPA that goes beyond the information required by Form 2B. Note that NPDES authorities will deny claims for treating any effluent data as confidential. If you do not assert a claim of confidentiality at the time you submit your information to the NPDES permitting authority, EPA may make the information available to the public without further notice to you. EPA will handle claims of confidentiality in accordance with the Agency’s business confidentiality regulations at Part 2 of Title 40 of the *Code of Federal Regulations* (CFR).

Completion of Forms

Print or type in the specified areas only. If you do not have enough space on the form to answer a question, you may continue on additional sheets, as necessary, using a format consistent with the form.

Provide your EPA Identification Number from the Facility Registry Service, NPDES permit number, and facility name at the top of each page of Form 2B and any attachments. If your facility is new (i.e., not yet constructed), write or type “New Facility” in the space provided for the EPA Identification Number and NPDES permit number. If you do not know your EPA Identification Number, contact your NPDES permitting authority. See Exhibit 1–1 of the “General Instructions” of Form 1 for contact information.

Do not leave any response areas blank unless the form directs you to skip them. If the form directs you to respond to an item that does not apply to your facility or activity, enter “NA” for “not applicable” to show that you considered the item and determined a response was not necessary for your facility.

The NPDES permitting authority will consider your application complete when it and any supplementary material are received and completed according to the authority’s satisfaction. The NPDES permitting authority will judge the completeness of any application independently of the status of any other permit application or permit for the same facility or activity.

Definitions

The legal definitions of all key terms used in these instructions and Form 2B are in the “Glossary” at the end of the “General Instructions” in Form 1.

Line-by-Line Instructions

Section 1. General Information

Item 1.1. Mark whether your facility/business type is a CAFO or a CAAP.

- For a CAFO, you must complete Sections 1 through 6 and Section 8.
- For a CAAP, you must complete Sections 1, 7, and 8.

Item 1.2. Indicate whether your facility is an existing or proposed facility. Mark “Proposed Facility” if your facility is presently not in operation or is expanding to meet the definition of a CAFO in accordance with the regulations at 40 CFR 122.23.

Section 2. CAFO Owner/Operator Contact Information

Item 2.1. Provide the name, title, telephone number, and email address of the owner/operator of the facility/business.

Item 2.2. Provide the complete mailing address of the owner/operator of the facility/business.

Section 3. CAFO Location and Contact Information

Item 3.1. Provide the legal name and location (complete mailing address) of the facility. Also indicate whom the NPDES permitting authority should contact about the application, including a telephone number and email address.

Item 3.2. Provide the latitude and longitude of the entrance to the production area (i.e., the part of the operation that includes the animal confinement area, the manure storage area, the raw materials storage area, and the waste containment areas). Latitude and longitude coordinates may be obtained in a variety of ways, including use of hand held devices (e.g., a GPS enabled smartphone), internet mapping tools (e.g., <https://mynasadata.larc.nasa.gov/latitudelongitude-finder/>), geographic information systems (e.g., ArcView), or paper maps from trusted sources (e.g., U.S. Geological Survey or USGS). For further guidance, refer to <http://www.epa.gov/geospatial/latitudelongitude-data-standard>.

Item 3.3. If the facility uses a contract grower, provide the name and complete mailing address of the integrator.

Section 4. CAFO Topographic Map

Item 4.1. Provide a topographic map of the geographic area in which the facility is located, showing the specific location of the production area(s). You are not required to provide the topographic map required by Section 7 of Form 1.

On each map, include the map scale, a meridian arrow showing north, and latitude and longitude to the nearest second. Latitude and longitude coordinates may be obtained in a variety of ways, including use of hand held devices (e.g., a GPS enabled smartphone), internet mapping tools (e.g., <https://mynasadata.larc.nasa.gov/latitudelongitude-finder/>),

FORM 2B—INSTRUCTIONS CONTINUED

geographic information systems (e.g., ArcView), or paper maps from trusted sources (e.g., USGS).

On all maps of rivers, show the direction of the current. In tidal waters, show the directions of ebb and flow tides.

You may develop your map by going to the United States USGS's National Map website at <http://nationalmap.gov/>. (For a map from this site, use the traditional 7.5-minute quadrangle format. If none is available, use a USGS 15-minute series map.) You may also use a plat or other appropriate map. Briefly describe land uses in the map area (e.g., residential, commercial.). Note that you have completed your topographic map and attached it to the application.

Section 5. CAFO Characteristics

Supply all information in Section 5 if you checked "Existing facility" in response to Item 1.2.

Item 5.1. Provide the maximum number of each type of animal in open confinement or housed under roof (either partially or totally) that are held at your facility for a total of 45 days or more in any 12-month period. Provide the total number of animals confined at the facility.

Item 5.2. Identify the applicable types of containment and storage for manure, litter, and process wastewater at the facility and indicate the capacity of storage in days and gallons or tons.

Item 5.3. Indicate the total number of acres that are drained and collected in the containment and storage structure(s).

Item 5.4. Specify the tons of manure or litter and the gallons of process wastewater generated at the facility on an annual basis.

Item 5.5. Indicate whether the manure, litter, and/or process wastewater is land applied. If yes, continue to Item 5.6. If no, skip to Item 5.8.

Item 5.6. Indicate the number of acres of land under the control of the applicant that are available for land application of the manure, litter, or process wastewater.

Item 5.7. Check any of the identified best management practices that are being implemented at the facility to control runoff and protect water quality.

Item 5.8. Indicate if the manure, litter, and/or process wastewater is transferred to any other persons. If yes, continue to Item 5.9. If no, skip to Item 5.10.

Item 5.9. Specify the tons of manure or litter or the gallons of process wastewater transferred annually to other people.

Item 5.10. Describe any alternative uses of manure, litter, or process wastewater, if any (e.g., composting, pelletizing, energy generation).

Section 6. CAFO Nutrient Management Plans

Item 6.1. Indicate if you have submitted a nutrient management plan that satisfies the requirements at 40 CFR 122.42(e) and, if applicable, the requirements at 40 CFR 412.4(c).

Item 6.2. If you have not yet submitted a nutrient management plan, explain why not.

Item 6.3. Indicate if a nutrient management plan is being implemented at the CAFO. If not land applying, describe the alternative uses of the manure, litter, and wastewater (e.g., composting, pelletizing, energy generation).

Item 6.4. Indicate the date of the last review or revision of the nutrient management plan.

Note: A permit application is not complete until a nutrient management plan is submitted to the NPDES permitting authority.

Section 7. CAAP Facility Characteristics

Item 7.1. Indicate if the CAAP facility is located on land. If the facility is located in water (e.g., a net pen or submerged cage system), check "No" and skip to Item 7.3. If yes, continue to Item 7.2.

Item 7.2. Provide the maximum daily and maximum average monthly discharge at the CAAP facility by outfall number. Outfall numbers should correspond with the outfall numbers provided on the map submitted in Section 7 of Form 1. Values given for flow should be representative of your normal operation. The maximum daily flow is the maximum measured flow occurring over a calendar day. The maximum average monthly flow is the average of measured daily flow over the calendar month of highest flow.

Item 7.3. Indicate the number of ponds, raceways, net pens, submerged cages, or similar structures at your facility that result in discharges to waters of the United States. Describe each type and provide the name of the associated receiving water and intake water source.

Item 7.4. List the species of fish or aquatic animals held and fed at your facility. Distinguish between cold-water and warm-water species. The names of fish species should be proper, common, or scientific names as given in Special Publication 34 of the American Fisheries Society, *Common and Scientific Names of Fishes from the United States, Canada, and Mexico*.

For each species, provide the total harvestable weight in pounds (lbs.) for a typical calendar year. Also indicate the maximum weight present at any one time at your facility.

Item 7.5. Indicate the maximum monthly pounds of food given at your facility. Also indicate the month given. The amounts should be representative of your normal operations.

Section 8. Checklist and Certification Statement

Item 8.1. Review the checklist provided. In Column 1, mark the sections of Form 2B that you have completed and are submitting with your application. For each section in Column 2, indicate whether you are submitting attachments.

Item 8.2. The Clean Water Act provides for severe penalties for submitting false information on this application form. CWA Section 309(c)(2) provides that, "Any person who knowingly makes any false statement, representation, or certification in any application, ... shall upon conviction, be punished by a fine of no more than \$10,000 or by imprisonment for not more than six months, or both."

FORM 2B—INSTRUCTIONS CONTINUED

FEDERAL REGULATIONS AT 40 CFR 122.22 REQUIRE THIS APPLICATION TO BE SIGNED AS FOLLOWS:

- A. For a corporation, by a responsible corporate officer. For the purpose of this section, a responsible corporate officer means: (1) a president, secretary, treasurer, or vice-president of the corporation in charge of a principal business function, or any other person who performs similar policy- or decision-making functions for the corporation, or (2) the manager of one or more manufacturing, production, or operating facilities, provided the manager is authorized to make management decisions which govern the operation of the regulated facility including having the explicit or implicit duty of making major capital investment recommendations, and initiating and directing other comprehensive measures to assure long term environmental compliance with environmental laws and regulations; the manager can ensure that the necessary systems are established or actions taken to gather complete and accurate information for permit application requirements; and where authority to sign documents has been assigned or delegated to the manager in accordance with corporate procedures.
- B. For a partnership or sole proprietorship, by a general partner or the proprietor, respectively.
- C. For a municipality, state, federal, or other public facility, by either a principal executive officer or ranking elected official. For purposes of this section, a principal executive officer of a federal agency includes: (1) The chief executive officer of the agency, or (2) a senior executive officer having responsibility for the overall operations of a principal geographic unit of the agency (e.g., Regional Administrators of EPA).

END

**Submit your completed Form 1, Form 2B, and
all associated attachments
(and any other required NPDES application forms)
to your NPDES permitting authority.**

This page intentionally left blank.

EPA Identification Number

NPDES Permit Number

Facility Name

Form Approved 03/05/19
OMB No. 2040-0004Form
2B
NPDES

U.S. Environmental Protection Agency
Application for NPDES Permit to Discharge Wastewater
CONCENTRATED ANIMAL FEEDING OPERATIONS and
CONCENTRATED AQUATIC ANIMAL PRODUCTION FACILITIES

SECTION 1. GENERAL INFORMATION (40 CFR 122.21(l)(1))

General Information	1.1	Indicate the facility/business type. (Check only one response.) <input type="checkbox"/> CAFO → Complete Sections 1 through 6 and Section 8. <input type="checkbox"/> CAAP → Complete Sections 1, 7, and 8.
	1.2	Indicate the operational status of the facility. (Check one.) <input type="checkbox"/> Existing facility <input type="checkbox"/> Proposed facility

SECTION 2. CAFO OWNER/OPERATOR CONTACT INFORMATION (40 CFR 122.21(f)(2) and (4) and 122.21(i)(1)(i))

CAFO Owner/Operator Contact Information	2.1	Owner/Operator Contact		
		Name (first and last)		Title
		Phone number		Email address
	2.2	Owner/Operator Mailing Address		
		Street or P.O. box		
		City or town	State	Zip code

SECTION 3. CAFO LOCATION AND CONTACT INFORMATION (40 CFR 122.21(i)(1)(ii and iii))

CAFO Location and Contact Information	3.1	CAFO Location and Contact		
		Name		
		Address (street, route number, or other specific identifier)		County
		City or town	State	Zip code
		Facility contact name	Phone number	Email address
	3.2	Latitude/Longitude of Entrance to Production Area (see instructions)		
		Latitude		Longitude
		° ' "		° ' "

EPA Identification Number

NPDES Permit Number

Facility Name

Form Approved 03/05/19
OMB No. 2040-0004CAFO Location and Contact
Information Continued

3.3	Integrator Name and Address		
	Name		
	Street address		
City or town	State	Zip code	

SECTION 4. CAFO TOPOGRAPHIC MAP (40 CFR 122.21(i)(1)(iv))CAFO
Topographic
Map

4.1	Have you attached a topographic map containing all required information to this application? (See instructions for specific requirements.)
<input type="checkbox"/>	Yes → SKIP to Section 5.
<input type="checkbox"/>	No

SECTION 5. CAFO CHARACTERISTICS (40 CFR 122.21(i)(1)(v ix))

CAFO Characteristics

5.1	Provide information on the type and number of animals in the table below.						
	Animal Type	Number in Open Confinement	Number Housed Under Roof	Animal Type	Number in Open Confinement	Number Housed Under Roof	
	<input type="checkbox"/> Mature dairy cows			<input type="checkbox"/> Sheep or lambs			
	<input type="checkbox"/> Dairy heifers			<input type="checkbox"/> Chickens (broilers)			
	<input type="checkbox"/> Veal calves			<input type="checkbox"/> Chickens (layers)			
	<input type="checkbox"/> Cattle (not dairy or veal calves)			<input type="checkbox"/> Ducks			
	<input type="checkbox"/> Swine (55 lbs. or more)			<input type="checkbox"/> Other (specify)			
	<input type="checkbox"/> Swine (under 55 lbs.)			<input type="checkbox"/> Other (specify)			
	<input type="checkbox"/> Horses			<input type="checkbox"/> Other (specify)			
	<input type="checkbox"/> Turkeys			Total Animals			
	5.2	Indicate the type of containment and storage, total number of days, and total capacity for manure, litter, and process wastewater storage in the table below.					
		Type of Containment and Storage	Total Number of Days	Total Capacity (specify gallons or tons)	Type of Containment and Storage	Total Number of Days	Total Capacity (specify gallons or tons)
		<input type="checkbox"/> Anaerobic lagoon			<input type="checkbox"/> Belowground storage tanks		
		<input type="checkbox"/> Evaporation			<input type="checkbox"/> Roofed storage shed		
		<input type="checkbox"/> Aboveground storage tanks			<input type="checkbox"/> Concrete pad		
		<input type="checkbox"/> Storage pond			<input type="checkbox"/> Impervious soil pad		
		<input type="checkbox"/> Underfloor pit			<input type="checkbox"/> Other (specify)		
5.3	Indicate the total number of acres drained and collected in the containment and storage structure(s) reported under Item 5.2. _____ acres						

EPA Identification Number

NPDES Permit Number

Facility Name

Form Approved 03/05/19

OMB No. 2040-0004

CAFO Characteristics Continued

Manure, Litter, and/or Process Wastewater Production and Use

5.4	How many tons of manure or litter and gallons of process wastewater are generated annually at the CAFO?	
	Manure	tons
	Litter	tons
	Process wastewater	gallons
5.5	Is manure, litter, and/or process wastewater generated at the CAFO land applied? <input type="checkbox"/> Yes <input type="checkbox"/> No → SKIP to Item 5.8.	
5.6	How many acres of land under the control of the applicant are available for applying the CAFO's manure, litter, or process wastewater? _____ acres	
5.7	Check all land application best management practices that are being implemented.	
	<input type="checkbox"/> Buffers	<input type="checkbox"/> Infiltration field
	<input type="checkbox"/> Setbacks	<input type="checkbox"/> Grass filter
	<input type="checkbox"/> Conservation tillage	<input type="checkbox"/> Terrace
	<input type="checkbox"/> Constructed wetlands	<input type="checkbox"/> Other (specify)
5.8	Is manure, litter, and/or process wastewater transferred to any other persons? <input type="checkbox"/> Yes <input type="checkbox"/> No → SKIP to Item 5.10.	
5.9	How many tons of manure or litter and gallons of process wastewater, produced by the CAFO, are transferred annually to other people?	
	Manure	tons
	Litter	tons
	Process wastewater	gallons
5.10	Describe alternative use(s) of manure, litter, or process wastewater, if any.	

SECTION 6. CAFO NUTRIENT MANAGEMENT PLANS (40 CFR 122.21(i)(1)(x))

CAFO Nutrient Management Plans

6.1	Has the applicant attached a nutrient management plan that satisfies the requirements at 40 CFR 122.42(e) and, if applicable, the requirements at 40 CFR 412.4(c)? Note: A permit application is not complete until a nutrient management plan is submitted to the NPDES permitting authority. <input type="checkbox"/> Yes → SKIP to Item 6.3. <input type="checkbox"/> No	
6.2	Explain why a nutrient management plan is not attached to the application.	
6.3	Is a nutrient management plan being implemented at the CAFO? <input type="checkbox"/> Yes <input type="checkbox"/> No	
6.4	What was the date of the last review or revision of the nutrient management plan? Date _____	

EPA Identification Number

NPDES Permit Number

Facility Name

Form Approved 03/05/19
OMB No. 2040-0004**SECTION 7. CAAP FACILITY CHARACTERISTICS (40 CFR 122.21(i)(2))**

CAAP Facility Characteristics

7.1	Is the CAAP facility located on land? <input type="checkbox"/> Yes <input type="checkbox"/> No → SKIP to Item 7.3.					
7.2	Provide the maximum daily and maximum average monthly discharge at CAAP by outfall.					
	Outfall Number	Discharge				
		Maximum Daily Discharge		Maximum Average Monthly Discharge		
		gpd		gpd		
		gpd		gpd		
		gpd		gpd		
7.3	Indicate the type and number of discharge structures at the CAAP. Provide a brief description of each structure. Also note the name of the receiving water and the source of the intake water for each structure.					
	Structure Type	Number of Each	Description	Receiving Water Name	Source of Intake Water	
	Ponds					
	Raceways					
	Net pens				Not applicable	
	Submerged cages				Not applicable	
	Similar structures (specify)					
7.4	List the cold-water and/or warm-water aquatic species raised/produced in the table below. For each species listed, indicate the total yearly and maximum harvestable weight (in pounds).					
	Cold Water Species			Warm Water Species		
	Species	Harvestable Weight		Species	Harvestable Weight	
		Total Yearly	Maximum		Total Yearly	Maximum
		lbs.	lbs.		lbs.	lbs.
		lbs.	lbs.		lbs.	lbs.
		lbs.	lbs.		lbs.	lbs.
		lbs.	lbs.		lbs.	lbs.
7.5	Indicate the calendar month of maximum feeding and the total mass of food fed (in pounds) during that month.					
	Month of Maximum Feeding			Total Mass of Food Fed		
				lbs.		

EPA Identification Number

NPDES Permit Number

Facility Name

Form Approved 03/05/19
OMB No. 2040-0004**SECTION 8. CHECKLIST AND CERTIFICATION STATEMENT (40 CFR 122.22(a) and (d))**

Checklist and Certification Statement	8.1	In Column 1, below, mark the sections of Form 2B that you have completed and are submitting with your application. For each section, specify in Column 2 any attachments that you are enclosing to alert the permitting authority. Note that not all applicants are required to provide attachments.	
		Column 1	Column 2
		<input type="checkbox"/> Section 1: General Information	<input type="checkbox"/> w/ attachments
		<input type="checkbox"/> Section 2: CAFO Owner/Operator Contact Information	<input type="checkbox"/> w/ attachments
		<input type="checkbox"/> Section 3: CAFO Location and Contact Information	<input type="checkbox"/> w/ attachments
		<input type="checkbox"/> Section 4: CAFO Topographic Map	<input type="checkbox"/> w/ topographic map <input type="checkbox"/> w/ additional attachments
		<input type="checkbox"/> Section 5: CAFO Characteristics	<input type="checkbox"/> w/ attachments
		<input type="checkbox"/> Section 6: CAFO Nutrient Management Plans	<input type="checkbox"/> w/ nutrient management plan <input type="checkbox"/> w/ attachments
		<input type="checkbox"/> Section 7: CAAP Facility Characteristics	<input type="checkbox"/> w/ attachments
		<input type="checkbox"/> Section 8: Checklist and Certification Statement	<input type="checkbox"/> w/ attachments
	8.2	<p>Certification Statement</p> <p><i>I certify under penalty of law that this document and all attachments were prepared under my direction or supervision in accordance with a system designed to assure that qualified personnel properly gather and evaluate the information submitted. Based on my inquiry of the person or persons who manage the system, or those persons directly responsible for gathering the information, the information submitted is, to the best of my knowledge and belief, true, accurate, and complete. I am aware that there are significant penalties for submitting false information, including the possibility of fine and imprisonment for knowing violations.</i></p>	
		Name (print or type first and last name)	Official title
		Signature	Date signed

APPENDIX B - ID NRCS CONSERVATION PRACTICE STANDARD CODE 360

**NATURAL RESOURCES CONSERVATION SERVICE
CONSERVATION PRACTICE STANDARD**

CLOSURE OF WASTE IMPOUNDMENTS

(No.)

CODE 360

DEFINITION

The closure of waste impoundments (treatment lagoons and liquid storage facilities), that are no longer used for their intended purpose, in an environmentally safe manner.

PURPOSE

- Protect the quality of surface water and groundwater resources
- Eliminate a safety hazard for humans and livestock
- Safeguard the public health

CONDITIONS WHERE PRACTICE APPLIES

This practice applies to agricultural waste impoundments that are no longer needed as a part of a waste management system and are to be permanently closed or converted.

The structure must be constructed to meet NRCS standards or show structural integrity if these impoundments are to be converted to fresh water storage ponds. Investigations for structural integrity must be conducted as specified in the National Engineering Manual (NEM) 501.23.

CRITERIA

General Criteria Applicable to All Purposes

The closure shall comply with all federal, state and local laws, rules and regulations including pollutant discharge elimination system requirements.

All structures used to convey waste to waste impoundments or to provide drainage from the impoundment area shall be removed and

replaced with compacted earth material or otherwise rendered unable to convey waste.

Liquid and slurry wastes shall be agitated and pumped to the extent conventional pumping will allow. Clean water shall be added as necessary to facilitate the agitation and pumping. The wastewater shall be utilized in accordance with Waste Utilization (633), as well as Nutrient Management (590). The sludge remaining on the bottom and sides of the waste treatment lagoon or waste storage facility may remain in place if it will not pose a threat to the environment. If leaving the sludge in place would pose a threat, it shall be removed to the fullest extent practical and utilized in accordance with Waste Utilization (633), as well as Nutrient Management (590).

Land Reclamation. Impoundments with embankments may be breached so that they will no longer impound water, and excavated impoundments may be backfilled so that these areas may be reclaimed for other uses. Waste impoundments that have water impounded against the embankment are considered embankment structures if the depth of water is three feet or more above natural ground.

(1) Embankment Impoundments. Waste shall be removed from the site before the embankment is breached. The slopes and bottom of the breach shall be stable for the soil material involved; however, the side slopes shall be no steeper than three horizontal to one vertical (3:1).

(2) Excavated Impoundments. The backfill height shall exceed the design finished grade by 5 percent to allow for settlement. The top one foot of the backfill shall be constructed of soil with greater than 20% clay content and mounded to shed rainfall

runoff. Incorporate available topsoil where feasible to aid establishment of vegetation.

Closed waste storage structures shall be demolished or disassembled or otherwise altered to such an extent that no water can be impounded. Disassembled materials such as pieces of metal shall be temporarily stored until their final disposition in such a manner that they do not pose a hazard to animals or humans.

Demolished materials shall be buried on-site, as allowed by local regulation of landfills or moved off-site to locations designated by state or local officials. If buried on-site, the materials are to be covered with soil to a settled depth of one foot, and the backfill be sufficiently mounded such that runoff will be diverted from the site after the backfill settles.

Conversion to Fresh Water Storage. The converted impoundment shall meet the requirements as set forth in the appropriate NRCS practice standard for the intended purpose.

Safety. When sludge is not removed from a waste impoundment that is being converted to fresh water storage, the impoundment shall not be used for fish production, swimming or livestock watering until water quality is adequate for these purposes. Precautions such as fencing and warning signs shall be used to ensure that the facility is not used for purposes incompatible with the current quality of water.

Personnel shall not enter an enclosed waste impoundment without breathing apparatus or taking other appropriate measures.

Protection. All disturbed areas shall be re-vegetated or other suitable measures used to control erosion and restore the esthetic value of the site. Sites not suitable for re-vegetation through normal cropping practices shall be vegetated using Critical Area Planting (342).

Measures shall be taken during construction to minimize site erosion and pollution of downstream water resources. This may include such items as silt fences, hay bale barriers, temporary vegetation and mulching.

CONSIDERATIONS

Reduce pumping effort to empty waste impoundments where the surface is covered

NRCS, IDAHO

April 2006

by a dense mat of floating vegetation by first applying herbicide to the vegetation and then burning the residue. Appropriate permits must be obtained before burning.

Minimize the impact of odors associated with emptying and land applying wastewater and sludge from a waste impoundment by using an incorporation application method at a time when the humidity is low, winds are calm and wind direction is away from populated areas.

Soil to fill excavated ponds should not come from important farmlands (prime, statewide, local and/or unique).

Breeched embankments may detract from the overall esthetics of the operation. Embankments should be removed and the site returned to its original grade.

Keep sludge left in place covered with water to prevent its aerobic decomposition with the potential release of nutrients to surface and ground water.

Disassembled structural facilities may be suitable for assembly at another site. Care should be taken during closure to minimize damage to the pieces of the facility, particularly coatings that prevent corrosion of metal pieces.

PLANS AND SPECIFICATIONS

Plans and specifications for closure of abandoned waste treatment lagoons and waste storage facilities shall be in keeping with this standard and shall describe the requirements for applying the practice to achieve its intended purpose. The plans and specifications shall also be consistent with the requirements of that standard.

OPERATION AND MAINTENANCE

The proper closure of a waste treatment lagoon or waste storage facility should require little or no operation and maintenance; however, if it is converted to another use, such as a fresh water facility, operation and maintenance shall be in accordance with the needs as set forth in the appropriate NRCS conservation practice standard for the intended purpose.

APPENDIX C - ID NRCS IDAW

United States Department of Agriculture
Natural Resource Conservation Service

IDAWM

Computer Program

Version 4.00 DECEMBER 2000

Computer Program for Animal Waste Computations

Title: IDAWM

Version: 4.00

Date: May 1991

Last Revision: December 2000

Programmed by: Bruce D. Wilson
NRCS Assistant State Conservation Engineer
Portland, Oregon

Modified for Idaho by: Clare J. Prestwich, NRCS
Idaho State Irrigation Engineer

References:

- Oregon Department of Agriculture, Natural Resources Division, Oregon Animal Waste Installation Guidebook, Salem, Oregon, March, 1991
- USDA NRCS, Agricultural Waste Management Field Handbook, US Government Printing Office, Washington, D.C., 1991.
- Economic Worksheet for Animal Waste Utilization, Hal Gordon, NRCS State Economist, Portland, OR, 1992
- Idaho Department of Health and Welfare, Division of Environmental Quality, Idaho Waste Management Guidelines for Confined Feeding Operations, 1993.
- USDA, NRCS, Idaho FOTG Practice Standards 313, 359 and 590.

Table of Contents	Page
A. Program Description	3
B. Equipment	3
C. Instructions to Load and Run Program	3
D. User Instruction	4
Inventory Information	5
Wash Water/Storm Water Area	6
Solids Storage	8
Liquid Storage	8
Nutrient Evaluation	9
Default Data Input	13
E. Program Limits	15

Idawm

A. PROGRAM DESCRIPTION

This program can be used as a tool for computing animal waste volumes, nutrient amounts, sizing storage facilities, and/or determining nutrient application area requirements based upon plant uptake. The program uses data and procedural guidelines from the Idaho Waste Management Guidelines for Confined Feeding Operations (IDWMG) and the NRCS Agricultural Waste Management Field Handbook. The data input screens will display reference page numbers in the IDWMG where a description of data and procedures used can be found.

The program was created using version 4.5 of the Microsoft QuickBASIC interpreter. The program consists of 13 executable modules. Each module represents an input screen of the program. Since the program consists of executable modules, the program requires the BRUN45.EXE program file be in the same directory as the program modules in order to run properly.

Four data files are also needed to run the program. The data files consist of animal, crop, climatic and default information. The information in the data files from the OAWG (Oregon Animal Waste Guidebook) was modified for Idaho and can be updated as needed. The default data file has been created but can be altered to save the following information:

- landowner/operator
- climatic station
- type of operation
- animal descriptions
- animal weights
- months of animal confinement
- days animals are confined
- days animals are grazed
- liquid storage period
- solid storage period
- crops selected for nutrient uptake
- nutrient on which to base acreage calculations
- dollar value of nutrients
- selected printer for printing data
- data path and disk drive and path where data is to be stored.

The economics of determining the break even cost and nutrient balance of waste application was developed by Hal Gordon, NRCS Oregon State Economists, and adapted to this program.

B. EQUIPMENT

This program is designed to run on the AT&T PC 6300 series computer or compatible with 640K or RAM memory and running MS-DOS version 2.11 or higher. A single disk drive is required to run the program and a printer is required to print a paper copy of the program output. The program can be provided on 360K, 1.2 MB 5 1/4 inch diskettes or 720K/1.44MB 3 1/2 inch diskettes.

C. INSTRUCTIONS TO LOAD AND RUN PROGRAM

If your computer is equipped with a hard disk, you can load the program onto the hard disk by creating a subdirectory and copying all the files from the diskette or diskettes into the subdirectory created on the hard disk or by downloading the program from the NRCS Idaho web page <<http://id.nrcs.usda.gov>> and clicking on "TECHNICAL RESOURCES", "ENGINEERING TECHNICAL RESOURCE DOWNLOAD PAGE", "COMPUTER PROGRAMS", then "idawm". To run the program from the subdirectory, simply use the change directory command (CD) to change to the subdirectory and type Idawm followed by the enter key. To avoid problems loading or saving data files add the following to the autotexec.bat file in the c:\ directory "path=c:\subdirectory where you loaded the program". If the path statement already exists just add it on to the end of the line. This can be done using any text editor.

If you wish to run the program using the floppy drive, insert diskette number one into the A: or B: disk drive, type

A: or **B:** for the drive the diskette is located in and press the enter key. Type Idawm followed by the enter key to run the program. If you are prompted to "Input run-time module path:", type **A:** or **B:** for the disk drive containing the program diskette and press the enter key.

Important-- The first time you run the program;

1. Press the [F3] key to save the default settings.
2. Follow the instructions on page 13 to customize the data for the default screens paying special attention to the printer type and data storage disk drive and data path. Save the defaults by pressing the [PgDn] key at the last input screen so the next time you run the program the defaults will be set up the way you want them for your computer. The program is initially set up to use the Genicom Dot Matrix printer for printouts and the A: disk drive for data storage.

If you have trouble running the program on your computer, call your IRM staff to insure you have the proper equipment and MSDOS version described in section B.

D. USER INSTRUCTIONS

The Idawm program is "user friendly" to the extent that all the input data needed is asked for in a logical manner. The data field that is activated for the user to enter new or to change default data is identified by that data field being shaded. The entire data field is shaded when the data field is empty and the length of the shaded area is reduced as each character is entered. If the data field is full, the program will provide one extra shaded space to indicate the current location for data input.

The following is a description of editing keys that can help enter and manipulate data in the program:

[ESC]	Pressing the escape key in any input field in the program will allow the user to save data entered and exit the program returning to the DOS operating system. See page 13 for instructions on saving data.
[DEL]	Pressing the delete key will clear all of the data from the data field in which the cursor is located .
[<---]	Pressing the backspace key will delete one character to the left of the shaded area.
[Tab]	Pressing the tab key will move the cursor from current data field to the next.
Shift [Tab]	Pressing the shift key along with the tab key will move the cursor from the current data field to the previous data field.
[PgDn]	Pressing the page down key will move the cursor to the next data entry screen in the program.
[PgUp]	Pressing the page up key will move the cursor to the previous data entry screen in the program.
[>-]	Pressing the right cursor key will move the cursor to the next data field to the right.
[<-]	Pressing the left cursor key will move the cursor to the next data field to the left.
[UP]	Pressing the up cursor key will move the cursor to the next data field above the current data field.
[DOWN]	Pressing the down cursor key will move the cursor to the next data field below the current data field location.
[Enter]	Pressing the enter key or carriage return key (<CR>) will move to the next data field.
[Ctrl] [L]	Pressing the [Ctrl] and [L] keys together where indicated will provide a list of items from which to select.
[F1]	Pressing the [F1] function key will allow the user to load a previously saved data file. See page 13 for instructions on how to load a data file.
[F2]	Pressing the [F2] function key will allow the user to save entered data to a data file. See page 13 for instructions on how to save data to a file.
[F3]	Pressing the [F3] function key will allow the user to save data to a default data file that is used each time the program is run. See pages 13-15 for instructions on how to enter and save default data.
[F4]	Pressing the [F4] function key in the solids storage facility or liquid storage facility input screen allows the user to print the graphic display to a dot matrix printer. The user must have loaded the graphics print routine by typing GRAPHICS before running the program and selecting this option. If you are running the program through SIMULTASK on a UNIX operating system, this option may not give the desired results. This option is not available if you have specified a laser printer for the printer type in the default settings.

D. User Instructions Continued

The following provides a description of each data entry screen in the program:

SCREEN 1. PROGRAM DEVELOPMENT INFORMATION

The program will display information about the version of the program and a telephone number for help. No data entry is required on SCREEN 1. Press any key to proceed to SCREEN 2. The program will indicate that it is loading data from the default data file. The program will automatically proceed to SCREEN 2 once all of the necessary data is loaded. If the required data files are missing the program will not run.

SCREEN 2. ANIMAL WASTE MANAGEMENT PLANNING WORKSHEET OPERATOR/LANDOWNER

Enter the name of the operator or landowner. As a default the file will be saved under this input. This data field will accept 1-40 characters. If manure for different animal groups is handled differently in storage or utilization you should make a separate idawm computer evaluation for the different groups. Example – milking cows manure stored and land applied, heifers and calves manure stored in corral in manure pack for several years; evaluate with separate analysis. Multiple computer runs can be used to evaluate alternatives for handling and/or utilizing the manure. Options for runs i.e. John Smith storage milkers, John Smith all animals.

LOCATION

Enter the location of the confined animal feeding operation (CAFO). This data field will accept 1-40 characters.

ASSISTED BY

Enter the name of the person providing assistance to the landowner. This data field will accept 1-40 characters.

CLIMATIC STATION

Enter the climatic station that best represents the location of the CAFO operation. Pressing [Ctrl] [L] will display an alphabetical list of 79 climatic stations to choose from (2 pages). Use the up and down cursor keys to choose the climatic station you want and press [Enter]. A correct entry in this data field is required to move to the next data entry screen. This data field will accept 1-20 characters. Other climatic station can be added by editing the file rf.awm with any text editor. The format is given at the top of the file. Data must be entered in this format. The 1 in 5 monthly precipitation is used for determining runoff from corrals/barns during the December through March period and the average monthly precipitation for the April through November period.

TYPE OF OPERATION

Enter the type of CAFO. Pressing [Ctrl] [L] will display a list of CAFO's to choose from. Use the up and down cursor keys to select the type of CAFO desired and press [Enter]. A correct entry is required in this data field to move to the next data field. This data field will accept 1-9 characters.

DATE

If the date displayed is not correct it may be edited to enter the correct month, day, and year. This data field will accept 1-2 characters.

DESCRIPTION

The animal descriptions displayed may be edited to reflect a more accurate description of the breed and other characteristics of the animals. Care must be taken to maintain similar descriptions or the related volume and nutrient production factors will not be correct. Press [Ctrl] [C] to copy the line of the current data field to the next line. Press [Ctrl] [D] to delete a line that has been copied. The default data lines may not be deleted. These data fields will accept 1-24 characters.

NUMBER

Enter the number of animals associated with each animal description. An entry into at least one of the data fields is required in order to move to the next data entry screen of the program. These data fields will accept 1-6 characters.

WEIGHT LBS

Enter the average weight of each animal described. An entry into at least one of the data fields is required in order to move to the next data entry page of the program. These data fields will accept 1-4 characters.

CONFINEMENT-START

Select the first month of confinement by pressing the [Shift] and the [<] or [>] keys together. If the animals are not confined, use the [Shift] and the [<] keys to select NONE. This data field will not allow data to be entered directly. . To copy the entry to the data field directly below, press [Ctrl] [C].

CONFINEMENT-END

Select the last month of confinement by pressing the [Shift] and the [<] or [>] keys. If the animals are not confined, use the [Shift] and the [<] keys to select none. This data field will not allow data to be entered directly. To copy the entry to the data field directly below, press [Ctrl] [C].

CONFINEMENT-DAYS

This is an automatic calculation by the program. For a JAN starting month and a DEC ending month of a confinement period of 365 days is used. If NONE is entered for both the starting and ending confinement period, 0 days are used for the confinement. Partial month confinement can be reflected by entering two lines for the animal group and adjusting the number of animals per line to reflect partial month conditions. As an example a Oct 15 to April 30 confinement period can be reflected by showing one-half of the animals being confined Oct-Apr and one-half confined Nov-Apr.

DAYS GRAZED

This is an automatic program calculation = 365 days – confinement days.

DAYS LIQUID STORAGE

Enter the planned liquid storage period in days not to exceed 365. To copy the current entry to the data field directly below, press [Ctrl] [C]. This data field will accept 1-3 characters.

DAYS SOLID STORAGE

Enter the planned solid storage period in days not to exceed 365. If all of the waste is handled as a liquid, enter 0. To copy the current entry to the data field directly below, press [Ctrl] [C]. This data field will accept 1-3 characters.

SCREEN 3, DAILY BEDDING FACTOR

This table shows typical daily bedding factors (first value) and calculates daily volume of bedding for the confined animal units (second value). When actual bedding use is known equate use to a daily animal unit rate. Bedding increases the size of the storage required for holding solid waste.

TYPE

Enter the type of bedding material used (informational description only). This description is printed on the output. This data field will accept 1-30 characters.

SELECTED FACTOR

Enter the appropriate bedding factor using the displayed list as a guide or enter an appropriate bedding factor for the type and volume of bedding used. Leave blank if a separator factor is to be entered which accounts for all solids and bedding separated. If bedding is planned to be used that will not be processed over the separator, enter the appropriate value. This data field will accept 1-5 characters.

SOLID SEPARATION FACTORS

SELECTED SEPARATOR FACTOR OR PERCENT OF TOTAL MANURE TREATED AS A SOLID

One of the first three lines is applicable if a separator structure is used. Enter the appropriate separator factor using the displayed list as a guide or manufacture ratings for separator type. Where manure is handle by scraping of waste to a stockpiled or allowed to accumulate in a corral move to the next data field and enter the total percentage of manure treated or handled as a solid. These data fields will accept 1-5 or 3 characters respectively. **The program will not allow entries into both data fields.** Refer to IWMG, Table 2 for general information on where manure is deposited.

Does Feed Seepage Enter Liquid Storage Facility (Y/N)-? YES If feed seepage enters the liquid storage facility, enter Y for yes. If feed seepage does not enter the liquid storage facility, enter “N” for no. Feed seepage is estimated by assuming 30 cubic feet of seepage per 1000-pound animal unit per year. This data field will accept 1-3 characters.

SCREEN 3A, SOLID OPTIONS

If the type of operation is a dairy, then another screen is shown to allow the user to designate how the manure is handled individually for milkers, dry cows, heifers and calves.

SCREEN 4, VOLUME WASH WATER

Note: If the type of operation is not a dairy, not all of the data entry fields described below will be displayed. For operations other than dairies simply refer to the data fields below displayed on the data entry screen. Refer to the IDWMG or the AWMFH for more information on volumes of wash water.

Cow Preparation Manual

If manual wash cow preparation is used, enter the daily wash volume per cow in gallons or cubic feet per day. These data fields will accept 1-6 characters.

Automatic Stall Wash

If automatic stall wash cow preparation is done, enter the daily wash volume per cow in gallons or cubic feet per day. These data fields will accept 1-6 characters.

Sprinkler

If automatic sprinkler wash cow preparation is done, enter the daily wash volume per cow in gallons or cubic feet per day. These data field will accept 1-6 characters.

Total Daily Volume= (number) Cows X Total Selected Amount=

The default number of cows for the daily volume of wash water is based on the animal numbers from screen 3, inventory data. If you wish to change the number of cows the daily volume of wash water is based on, simply press the left cursor key while in the sprinkler wash field and enter the desired number. Editing this field will not affect the numbers shown on data entry screen 3, inventory data. This data field will accept 1-6 characters. The program computes the total amount of wash water based on the number of cows washed per day and displays the amount.

Bulk Tank-Automatic

If a automatic bulk tank wash is used, enter the gallons or cubic feet used per wash. These data fields will accept 1-6 characters.

Manual

If a manual bulk tank wash is used, enter the gallons or cubic feet used per wash. These data fields will accept 1-6 characters.

Miscellaneous Equipment

Enter the daily amount of wash water used for miscellaneous equipment in gallons or cubic feet per wash. These data fields will accept 1-6 characters.

Pipelines

Enter the daily amount of wash water used for flushing pipelines in gallons or cubic feet per wash. These data fields will accept 1-6 characters.

Milkhouse And Parlor

Enter the daily amount of wash water used for the milkhouse and parlor in gallons or cubic feet per wash. These data fields will accept 1-6 characters.

Holding Area

Enter the daily amount of wash water used for washing the holding area in gallons or cubic feet per wash. These data fields will accept 1-6 characters.

Total Daily Volumes = {number} Washes X Total Selected Amount = If the number of washes shown is not correct, simply press the left cursor key while in the holding area data field and enter the correct number of washes used per day. This data field will accept 1-2 characters. The program will compute the total amount of wash water based on the number of washes per day and display the amount. When categories have different numbers of wash cycles per day, adjust the wash water per category to total water per day and change the number of washes to 1 per day.

LOT RUNOFF AREA

Roof

Enter the roof area, in square feet, that drains into the liquid storage facility. This data field will accept 1-7 characters.

Concrete Slab, Scraped Daily (Y/N) ? YES

Enter the unroofed concrete slab area, in square feet, that drains into the liquid storage facility. This data field will accept 1-7 characters. The default response for the unroofed concrete slab area being scrapped daily is yes. If the unroofed concrete slab area is not scrapped daily, simply press the left cursor key while in the concrete slab area data field and press 'N' for no. If the concrete slab is scrapped daily, the program will assume 100% of the monthly rainfall as runoff from the slab. If the concrete slab is not scrapped daily, the program will apply concrete slab runoff factors to compute the runoff from the slab. This data field will accept 1-3 characters. Concrete and roof runoff have been disabled to match values given in IDWMG.

Unsurfaced Lot

Enter the unroofed unsurfaced lot area, in square feet, that drains into the liquid storage facility. This data field will accept 107 characters.

Total

The program will compute the total amount of surface area contributing to the liquid storage facility and display the amount. For the months of December through March the 1 in 5 year precipitation values are used to calculate runoff. Average Precipitation is used for April through November. Refer to pages 65-67 of the IDWMG.

SCREEN 5, RUNOFF OPTIONS

This screen allows the user to select whether to use the maximum or just the winter precipitation for the design storage period. Use the right or left arrow keys to toggle back and forth and make a selection. Winter precipitation is the default value.

SCREEN 6, IDAHO ANIMAL WASTE OPTION PAGE

At this page the user can (1) recycle through inventory input (2) proceed to storage facility sizing screens (3) proceed to the nutrient evaluation screens. Arrow down to desired option and [Enter] or [PgDn].

SCREEN 7, SOLIDS STORAGE AREA

Width, W= FT

Enter the width of the solid storage facility desired in feet. **For in corral storage, W=0.** This data field will accept 1-3 characters.

Height, H= FT

Enter the total height of the solid storage stack in feet. **For in corral storage, H=0.** This data field will accept 1-4 characters.

Wall Height, h= FT

Enter the wall height of the solid storage facility desired in feet. This data field will accept 1-4 characters.

Stack Slope, z= 2;1

The default stack slope ratio is 2. If a different stack slope ratio is desired, delete the default value and enter the desired stack slope ratio. This data field will accept 1-3 characters.

Covered, (Y/N) ? NO

The default response to the question of whether the tank is covered or not is NO. If the solids storage facility is covered, enter "Y" for yes. If the response is NO, the program will add the surface area of the solids storage facility to the lot runoff area when computing the total runoff entering the liquid storage facility. This data field will accept 1-3 characters.

Note: Press [Ctrl] [X] keys at the same time to compute the length of the solids storage facility "L" in feet and required storage capacity in cubic feet. The program will add 1 gallon per day of seepage per 100-pound animal unit from the solids storage facility to the total seepage entering the liquid storage facility. Refer to page 35 of the IDWMG for more information on seepage from solid storage facilities.

SCREEN 8, SELECT LIQUID STORAGE FACILITY

1- ANAEROBIC LAGOON

2- WASTE HOLDING POND

3- TWO CELL WASTE HOLDING POND

4- CIRCULAR HOLDING TANK

5- EVAPORATION POND

Press the number associated with the type of liquid storage facility desired. If there is not enough annual evaporation to size an evaporation pond, the program will display NOT ENOUGH EVAPORATION TO DESIGN POND and return to this data input screen.

CHOICE->

OK-? (Y/N)

If you have previously made a liquid storage facility selection, the program will show the choice you have made. If you wish to select another type of liquid storage facility, press "N" and then the number of the storage facility desired. If the highlighted type of liquid storage facility is okay, press "Y", [PgUp] or [PgDn] to continue.

SCREEN 9A, ANAEROBIC LAGOON or WASTE HOLDING POND or EVAPORATION POND

SCREENS 9B and 9C, TWO CELL WASTE HOLDING POND

Side Slope, Z=3:1

The default side slope ratio is 3. If a different side slope ratio is desired, delete the default value and enter the side slope ratio desired. This data field will accept 1-3 characters.

Bottom Width, BW = ft

Enter the bottom width planned or estimated for the holding pond. This data field will accept 1-3 characters.

Bottom Length = ft

Enter the bottom length planned or estimated for the holding pond. This data field will accept 1-4 characters.

Sludge Duration = 10 Yrs

The default duration for sludge accumulation is 10 years. If a different duration is desired, delete the default value and enter the desired duration for sludge accumulation in years. Sludge accumulation is based on a percentage of total solids produced annually per 1000-pound animal unit. This data field will accept 1-2 characters.

Existing Storage = 0 AF

The default value for the amount of existing storage available is 0 acre-feet. If there is existing storage available, delete the default value and enter the amount in acre feet of existing storage. This data field will accept 1-5 characters.

Surface Area = O SF

The default value for the surface area of the existing storage is 0 square feet. If there is an existing storage facility that is not covered, delete the default value and enter the surface area in square feet of the existing storage facility. This data field will accept 1-7 characters.

Note: Press the [Ctrl] [X] keys to compute the capacity in acre feet, depth of pond needed, “d” in feet, the top width “TW” in feet, and the top length in feet.

SCREEN 9D, CIRCULAR HOLDING TANK

Diameter, DIA= FT

Enter the desired inside diameter of the circular holding tank in feet. This data field will accept 1-4 characters.

Tank Covered (Y/N) ? YES

The default value for the tank being covered is yes. If the tank is not covered, enter “N” for no. If the tank is not covered, the amount of rainfall storage needed in inches and feet will be displayed. This data field will accept 3 characters.

Existing Storage = O CF

The default value for the amount of existing storage available is 0 cubic feet. If existing storage exists, enter the amount in cubic feet. This data field will accept 1-7 characters.

Surface Area = O SF

The default value for the surface area of the existing storage is 0 square feet. If there is an existing storage facility that is not covered, delete the default value and enter the surface area in square feet of the existing storage facility. This data field will accept 1-7 characters.

NOTE: press the [Ctrl] [X] keys to compute the depth of the circular holding tank “d” in feet and the volume of the tank in cubic feet. If the tank depth is greater than 20 feet, the program will indicate that the tank depth computed is unrealistic.

SCREEN 10, IDAHO ANIMAL WASTE OPTION PAGE

This is a repeat of SCREEN 7. At this page the user can (1) recycle through inventory input (2) proceed to storage facility sizing screens (3) proceed to the nutrient evaluation screens. Arrow down to desired option and [Enter] or [PgDn].

SCREEN 11, NUTRIENT LOSSES DURING STORAGE FOR XXXXX

SELECTED VALUES

***LIQUIDS>>>>**

SOLIDS>>>>

GRAZING>>>>

Use the up and down cursor keys to select the storage method category for the type of waste indicated by the asterisk (*LIQUIDS>>>>). Pressing the key that represents the first letter of the type of waste stored displays the storage loss category for that type of waste (e.g. [L] for liquids, [S] for solids). There are no storage losses for grazing. Pressing the [Enter] key while selecting a storage method category will allow the user to edit the percent retained values for nitrogen, phosphorous and potassium. These data fields will allow up to 3 characters. The program will not allow the data fields for grazing to be edited. To return to the loss category selection process, use the up cursor key.

SCREEN 12, NUTRIENT LOSSES DURING APPLICATION

SELECTED VALUES;

***LIQUIDS>>>>**

SOLIDS>>>>

GRAZING>>>>

Use the up and down cursor keys to select the application category for the application method for the type of waste indicated by an asterisk (*LIQUIDS>>>>). Pressing the key that represents the first letter of the type of waste stored displays the storage loss category for that type of waste (e.g. [L] for liquids, [S] for solids). The application category for grazing cannot be edited. Pressing the [Enter] key while selecting a application method category will allow you to edit the percent retained values for nitrogen, phosphorous and potassium. These data fields will allow up to 3 characters. To return to the loss category selection process, use the up cursor key.

SCREEN 13, DENITRIFICATION LOSSES FOR XXXXX

SELECTED VALUES;

***LIQUIDS>>>>**

SOLIDS>>>

GRAZING>>>

In the Soil Drainage Class, section use the up and down cursor keys to select the soil drainage class for the type of waste indicated by an asterisk (*LIQUIDS>>>). Pressing the key that represents the first letter of the type of waste stored displays the storage loss category for that type of waste (e.g. [L] for liquids, [S] for solids, [G] for grazing). Pressing the [Enter] key while selecting a soil drainage class will allow you to edit the percent retained values for nitrogen. These data fields will allow up to 3 characters. To return to the drainage class selection process, use the up cursor key.

SCREEN 14, CROP INVENTORY AND TARGET YIELDS FOR XXXXX

Crop

If the crops grown are not displayed, press the [Ctrl] [L] keys to display the crop selection list. The hay/pasture crops include options for evaluating the nutrients based upon stage of growth at harvest. Use the up and down cursor keys to move through the list to find the crops desired. The [PgDn] and [PgUp] keys can be used to go from page to page of the crop list. A crop can be selected by pressing the [Enter] key. A selected crop is indicated by it being highlighted and can be unselected by pressing the [Ctrl] [D] keys. The last page of the crop selection list allows you to enter additional crops that are not listed in the *Idawm*. Be careful to enter nutrient uptake values in their elemental form for any additional crops added. Refer to NRCS Agricultural Waste Management Field Handbook, Chapter Six for information on the crops listed. To return to the data input screen once all of the desired crop have been selected, press the [Ctrl] [X] key. For some crops several values are shown. Use the values which represent the planned harvest time in relation to stage of growth/maturity of crop. Only include grain straw as a crop when the straw is exported from the farm (not reused in the corrals and recycled back to the fields). The crops applicable to the utilization of the nutrients from the liquids, solids and grazing are entered separately for each of these categories.

Target Yield

Move to the data field adjacent to the crop desired and enter the yield in the units for the crop selected. This data field will accept 1-5 characters.

Years In Rotation

The program defaults to a rotation of 1 year for each crop listed. Edit year of respective crops to reflect the actual crop rotation. The nutrient utilization is based upon the crop, yield and years in the rotation.

SCREEN 15, CONTROLLING NUTRIENTS AND ECONOMICS

Nutrient-

Use the left and right arrow keys to select the nutrient on which the nutrient balance will be computed and press enter. Phosphorous is the default nutrient for the nutrient budget. The nutrient selected is used to compute application management data and acres needed for the crops previously selected for nutrient utilization. For information on nutrient uptake data, refer the NRCS Agricultural Waste Management Field Handbook, Chapter Six.

Value in Dollars-

If the default dollar values for nitrogen, phosphorous and/or potassium are incorrect, use the left and right arrow keys to move to the proper input field and enter the correct dollar value. The data field will accept 1-5 characters.

Fertilizer Application Cost-

If the default value for fertilizer application cost is incorrect, enter the correct dollar value. This data field will accept 1-5 characters.

Manure Application Cost-

If the default value for manure application cost is incorrect, enter the correct dollar value. This data field will accept 1-5 characters.

System Life-

If the default value for the overall waste management system life is incorrect, enter the correct value for the expected life of the waste management system. This data field will accept 1-5 characters.

Annual Percentage Rate-

If the default value for the annual percentage rate at which money can be borrowed is incorrect, enter the correct annual percentage rate. This data field will accept 1-5 characters.

SCREEN 16, ACRES NEEDED FOR UTILIZATION BASED UPON XXXXX

The program calculates the required acres for the crop rotation specified to utilize the nutrients in the liquid and solid wastes and waste deposited from grazing animals. This computation is based on the utilization of the nutrient

indicated. The default analysis proportions the nutrients by the number of years that each crop is in the rotation. **The manure distribution can be altered or adjusted for numerous management/cropping alternatives.**

The break even cost value for dollars invested into a waste management system and nutrient balance will be computed and displayed. The break even cost value is based on nutrient dollar values as they relate to commercial fertilizer costs needed to produce the target yields for the crop grown and take into account differences in application costs for commercial fertilizer and manure.

A nutrient balance will be computed for the nutrient selected and the total acres needed, nutrients utilized, nutrients in excess or still needed will be displayed along with cost data. Negative values indicate excess nutrients are available and positive values indicate additional nutrients may be needed to meet target yields.

SCREEN 17, WHICH TYPE OF IRRIGATION SYSTEM DO YOU USE

Use the arrow key to select the appropriate type of sprinkler, center pivot, Big Gun, wheel line, hand line. This screen appears when sprinkler application of liquid waste is selected in SCREEN 12, if broadcast application is selected SCREEN 19B will appear.

SCREEN 18A, XXXXXX

Enter requested data for the type of sprinkler system being used and/or planned.

SCREEN 19A, MANAGEMENT CRITERIA FOR SPRINKLING APPLICATION OF LIQUIDS

XXXXX Concentration in Storage = XXX PPM or X.XX LBS/ 1000 GAL

The program will compute and display the nutrient concentration in parts per million and pounds per thousand gallons in storage for the nutrient specified for uptake calculations. If the nutrient concentration in storage is known in either parts per million or pounds per 1000 gallons, move to the appropriate data field, delete the displayed value and enter the known value. These data fields will accept 1-5 characters.

Application

(LBS)

XXX

The maximum pounds to be applied of the nutrient specified for uptake calculations will be displayed along with other application data. If the pounds applied per application is incorrect, delete the amount displayed and enter the correct amount in pounds. This data field will accept 1-4 characters.

SCREEN 19B, MANAGEMENT CRITERIA FOR Broadcast APPLICATION OF LIQUIDS

Tank Wagon Capacity = 4000 Gallons

The default value for the tank wagon capacity is 4000 gallons. If the default value is incorrect for the equipment used, delete the default value and enter the correct capacity in gallons. This data field will accept 1-5 characters.

Spread Width = 15 Feet

The default value for the spread width of a tank wagon is 15 feet. If the default value is incorrect for the equipment being used delete the default value and enter the correct spread width in feet. This data field will accept 1-3 characters.

XXXXX Concentration in Storage = XXX PPM or X.XX LBS/1000 Gal

The program will compute and display the nutrient concentration in parts per million and pounds per thousand gallons in storage for the nutrient specified for uptake calculations. If the nutrient concentration in storage is known in either parts per million or pounds per 1000 gallons, move to the appropriate data field, delete the displayed value and enter the known value. These data fields will accept 1-5 characters.

Application

(LBS)

XXX

The maximum pounds to be applied of the nutrient specified for uptake calculations will be displayed along with other application data. If the pounds applied per application is incorrect, delete the amount displayed and enter the correct amount in pounds. This data field will accept 1-4 characters.

SCREEN 20, MANAGEMENT CRITERIA FOR XXXXXXXX APPLICATION OF SOLIDS

Management data will be presented for the application method chosen for solids.

For Tractor Spreader Application of Solids

Tractor Spreader Capacity = 160 Bushels or 199 Cubic Feet

The default value for the tractor spreader capacity is 160 bushels or 200 cubic feet. If the default values are incorrect for the equipment used, move to the appropriate data field, delete the default value and enter the correct capacity in bushels or cubic feet. These data fields will accept 1-4 characters.

Spread Width = 15 Feet

The default value for the spread width of the tractor spreader is 15 feet. If the default value is incorrect for the equipment being used, delete the default value and enter the correct spread width in feet. This data field will accept 1-3 characters.

XXXXX Concentration in Storage = XXX PPM or X.XX LBS/1000 Gal

The program will compute and display the nutrient concentration in parts per million and pounds per thousand gallons in storage for the nutrient specified for uptake calculations. If the nutrient concentration for uptake calculations. If the nutrient concentration in storage is known in either parts per million or pounds per 1000 gallons, move to the appropriate data field, delete the displayed value and enter the known value. These data fields will accept 1-5 characters.

Application**(LBS)****XXX**

The maximum pounds to be applied of the nutrient specified for uptake calculations will be displayed along with other application data. If the pounds applied per application is incorrect, delete the amount displayed and enter the correct amount in pounds. This data field will accept 1-4 characters.

SCREEN 21, IDAHO ANIMAL WASTE OPTION PAGE

This is a repeat of SCREEN 7. At this page the user can (1) recycle through inventory input (2) proceed to storage facility sizing screens (3) proceed to the nutrient evaluation screens. Arrow down to desired option and [Enter] or [PgDn].

SCREEN 22, PRINT OUT OPTIONS

Press [I] To print only the Inventory

Press [S] To print Inventory plus Sizing

Press [N] To print Inventory plus Nutrient Use

Press[A] To print All

SCREEN 23, Printed Output-

Press [S] To Send Output to Screen

Press [P] to Send Output to Printer

Press [F] to Send Output to a File

To send the output to the screen, press the [S] key. Use the [PgUp] and the [PgDn] keys to move between output screens.

To send the output to an attached printer, press the [P] key. The type of printers the program supports will be display with the default printer highlighted. If you wish to print to a printer other than the default printer highlighted, use the up and down cursor keys to select the printer desired and press the [Enter] key.

To send the output to a file, press the [F] key. Indicate the data path the program will use to store the output file to. The output file will have a .OUT extension and will be formatted as an ASCII file.

[F1] DATA FILE RETRIEVAL-

Note: The program may automatically go to the save input data screen on page 13 if the input data had not been previously saved before selecting to retrieve data.

**SCREEN #1, ENTER DISK DRIVE AND PATH TO RETRIEVE DATA FROM:
DATA FILE PATH . . .**

The default disk drive and data path where data files are stored is displayed. If the data files are not stored in the default data path, enter the disk drive and data path where data files are to be retrieved from. Press the [Enter] key to retrieve the data files.

SCREEN #2, FILE NAME

Use the [PgDn] and [PgUp] keys to search for the data file to retrieve input data from and use the [Up] and [Down] cursor keys to move between data files. Press the [Enter] key to select the highlighted data file for data retrieval.

The program will indicate that it is loading data and return to input data screen 3.

**[F2] SAVE INPUT DATA-
SCREEN#1, ENTER DATA PATH AND FILE NAME TO STORE DATA TO:
DATA FILE PATH . . .**

The default data path is displayed. To save the input data to a data path other than the default data path, delete the default data path and enter the disk drive and path desired. Press the [Esc] key to exit this data entry screen without making changes or saving data.

DISK FILENAME . . .

To change the displayed disk filename, press the [,-] key to remove the unwanted characters or the [Del] key to clear the entire data entry field. This data field will accept 8 characters. Press the [Esc] key to exit this data entry screen without making changes or saving data.

LANDOWNER/OPERATOR . . .

To accept the landowner/operator name displayed and save data, press the [PgDn] key. To change the landowner/operator name displayed, press the [Backspace] key to remove unwanted characters or the [Del] key to clear the entire data entry field and enter the landowner/operator name desired. This data field will accept 40 characters. Press [Esc] to exit this data entry screen without making changes or saving data. Press the [PgDn] key to save the input data to a data file.

Saving Data . . .

The program will indicate it is saving the data and return to the input data screen from which the [F2] key was pressed or continue to the operation selected if the input data had not previously been saved.

[F3] DEFAULT DATA ENTRY-

Note: Press the [PgDn] and [PgUp] keys to move between default data entry screens. The program may automatically go to the save input data screen if the input data had not been previously saved before pressing [F3] to save defaults.

SCREEN #1, ENTER AND/OR SELECT DEFAULTS

ASSISTED BY:

Enter the name of the person who will be using the program the most. This data field will accept 1-40 characters.

CLIMATIC STATION:

Enter the climatic station that best represents the location of the CAFO operation to be assisted as shown on page 150 of the IDAWM. Pressing [Ctrl] [L] will display a list of climatic stations to choose from. Use the up and down cursor keys to choose the climatic station you want and press [Enter]. A correct entry in this data field is required to move to the next data entry screen. This data field will accept 1-20 characters.

TYPE OF OPERATION:

Enter the type of CAFO as describe on pages 71 of the IDWGM that best represents the majority of CAFO's to the assisted. Pressing [Ctrl] [L] will display a list of CAFO's to choose from. Use the up and down cursor keys to choose the type of CAFO you want and press [Enter]. A correct entry is required in this data field to move to the next data entry screen. This data field will accept 1-9 characters.

DESCRIPTION

The animal descriptions displayed may be edited to reflect a more accurate description of the breed and other characteristics of the CAFO. Care must be taken to maintain similar descriptions as described on page 71 in the IDWGM or the related volume and nutrient production factors will not be correct. Press [Ctrl] [C] to copy the line of the current data field and insert it directly below the current line. Press [Ctrl] [D] to delete a line that has been copied. The default data lines may not be deleted. These data fields will accept 1-24 characters.

WEIGHT LBS

Enter the average weights desired for the defaults of each animal described. These data fields will accept 1-4 characters.

CONFINEMENT-START

Select the first month of confinement by pressing the [Shift] and the [<] or [>] keys. If the animals are not confined, select NONE. This field will not allow data to be entered directly.

CONFINEMENT-END

Select the last month of confinement by pressing the [Shift] and the [<] or [>] keys. If the animals are not confined, select NONE. This field will not allow data to be entered directly.

DAYS LIQUID STORAGE

Enter the planned liquid storage period in days not to exceed 365. To copy the current entry to the data field directly below, press [Ctrl] [C]. This data field will accept 1-3 characters.

DAYS SOLID STORAGE

Enter the planned solid storage period in days not to exceed 365. If all of the waste is handled as a liquid, enter 0. To copy the current entry to the data field directly below, press [Ctrl] [C]. This data field will accept 1-3 characters

SCREENS #2, 3, 4,5, SELECT CROPS FOR NUTRIENT DISPOSAL

Use the up and down cursor keys to move through the crop list to find the crops to be used as the defaults. The [PgDn] and [PgUp] keys can be used to go from page to page of the crop list. A crop can be selected by pressing the [Enter] key. A selected crop is indicated by it being highlighted and can be unselected by pressing the [Ctrl] [D] keys together. The last page of the crop selection list allows you to enter additional crops that are not listed in the IDWMG. Be careful to enter nutrient uptake values in their elemental form for any additional crops added. Refer to NRCS Agricultural Waste Management Field Handbook, Chapter Six for information on the Crop Uptake Nutrient.

CROP

Enter the crop names for the crops planned as defaults that are not listed on the previous screens. This data field will accept 1-25 characters.

CONDITION

Enter the condition of the crops planned to be used as defaults. This data field will accept 1-15 characters.

YIELD UNITS

Enter the yield units (ton, bu) for each crop entered as a default. This data field will accept 1-3 characters.

N

Enter the elemental nitrogen uptake value in pounds per yield unit previously entered for each default crop. This data field will accept 1-5 characters.

P

Enter the elemental phosphorous uptake value in pounds per yield unit previously entered for each default crop. Make sure the value entered is in the elemental form as the value entered will be converted to P₂O₅ by the program. This data field will accept 1-5 characters.

K

Enter the elemental potassium uptake value in pounds per yield unit previously entered for each default crop. Make sure the value entered is in the elemental form as the value entered will be converted to K₂O by the program. This data field will accept 1-5 characters.

SCREEN 6, ENTER CROP DATA FOR NUTRIENT DISPOSAL NOT ON LIST

Input items listed above for screens 2-5 for crop, condition, yield units, N, P and K.

SCREEN #7, ENTER DEFAULT NUTRIENT FOR THE NUTRIENT BALANCE AND COST FACTORS

Nutrient

Use the left and right arrow keys to select the nutrient on which the nutrient balance and management data will be computed and press enter. Phosphorous is the typical default nutrient.

Value in Dollars

Use the left and right arrow keys to move to the proper input field and enter the default dollar value to be used for the corresponding nutrient. The data fields will accept 1-5 characters.

Fertilizer Application Cost

Enter the default dollar value to be used for fertilizer application cost. This data field will accept 1-5 characters.

Manure Application Cost

Enter the default dollar value to be used for manure application cost. This data field will accept 1-5 characters.

System Life

Enter the default value to be used for the overall waste management system life. This data field will accept 1-5 characters.

Annual Percentage Rate

Enter the default value to be used for the annual percentage rate at which money can be borrowed. This data field will accept 1-5 characters.

SCREEN #8, CHOOSE PRINTER

Select Printer

Use the up and down cursor keys to move through the list to find the printer that best represents the printer to be used to get printouts from the program. Press the [Enter] key to select the highlighted printer as the default.

Data File Path . . .

Enter the default disk drive and data path where data files are to be saved. Press the [PgDn] key to save the default data as entered.

Saving Data . . .

The program will indicate it is saving the default data and return to the screen where the [F3] key was selected.

E. PROGRAM LIMITS

SCREEN 2 -

A valid climatic station, a valid type of operation and at least one animal number data field must have data in order to proceed to the next data entry screen.

Only a total of 10 different animal descriptions may be entered.

The program uses either the maximum or winter rainfall period based on the liquid storage days entered to compute storage requirements. The program also computes the seepage storage requirements based on the maximum liquid storage days entered. Per State of Idaho requirements a 1 in 5 year winter precipitation is used instead of the average precipitation for the months of Dec through March.

SCREEN 3 -

If a separator factor is entered, the program assumes that the factor includes manure and bedding separated. If a bedding factor is also included, the program will add the bedding volume to the separated volume for the solids produced during the storage period selected on screen 3.

SCREEN 7

A reduction of approximately 30 percent in total sludge volumes is made when a separator factor is used. For anaerobic lagoons, no consideration for a reduction in total solids is made when a solid separator factor is used. If the tank depth computed exceeds 20 feet a warning statement will be displayed indicating that the depth is not practical.

SCREEN 14

Only 10 crops may be selected for nutrient utilization.

F. Example #1

Animal Waste Management System Inventory Worksheet for Dairies

Name of Landowner/Operator Don Green

Street Address P.O. Box 5000

City Meridian, or Zip Code 00000

Phone Number 208 555-1212

Assisted by Ed Helpful Date Sometime very soon

General Description of Operation

Current Mr. Green is currently milking 200 Holstein cows and has 40 dry cows, 40 heifers and 50 calves.

Concrete slabs are scraped daily. He has 400 acres available for waste application which is in corn for silage and irrigated grass legume pasture and hayland. Alfalfa hay typically cut early bloom.

Planned Mr. Green would like to expand his herd size to 300 Holstein milking cows and improve on his waste management system. He would like a waste holding pond for storing liquid wastes and a solid stack area for solids.

Problems Roofs are not guttered, roofs and open lot areas contribute runoff to liquid storage facility.

Livestock Data Current-

Description	Number	Average Weight Pounds	Days Confined	Days Grazed	Days Storage	
					Liquids	Solids
Milkers	<u>200</u>	<u>1400</u>	<u>365</u>	<u>0</u>	<u>10</u>	<u>10</u>
Dry	<u>40</u>	<u>1200</u>	<u>365</u>	<u>0</u>	<u>10</u>	<u>10</u>
Heifers	<u>40</u>	<u>850</u>	<u>212</u>	<u>153</u>	<u>10</u>	<u>10</u>
Calves	<u>50</u>	<u>250</u>	<u>365</u>	<u>0</u>	<u>10</u>	<u>10</u>

Livestock Data Planned-

Description	Number	Average Weight Pounds	Days Confined	Days Grazed	Days Storage	
					Liquids	Solids
Milkers	<u>300</u>	<u>1400</u>	<u>365</u>	<u>0</u>	<u>180</u>	<u>120</u>
Dry	<u>40</u>	<u>1200</u>	<u>365</u>	<u>0</u>	<u>180</u>	<u>120</u>
Heifers	<u>50</u>	<u>850</u>	<u>212</u>	<u>153</u>	<u>180</u>	<u>120</u>
Calves	<u>60</u>	<u>250</u>	<u>365</u>	<u>0</u>	<u>180</u>	<u>120</u>

Storage Component Volumes

Cow Prep (Auto Single Cow: 5-15 gal/milker/day)
 (Auto Multiple Cow: 25-40 gal/milker/day)
 (Manual: 3-7 gal/milker/day) Manual - 4

Bulk Tank (Manual: 30-50 gal/wash) _____ No. Washes 2
 (Auto: 60-110 gal/wash) Manual - 50
 Pipeline (75-150 gal/wash) 150 No. Washes 2
 Miscellaneous (25-35 gal/wash) 30 No. Washes 2
 Milkhouse (300-700 gal/wash) 300 No. Washes 2
 Holding Area (500-1200 gal/wash) _____ No. Washes 2
 Contributing Drainage Area, Acres _____
 Contributing Roof Runoff Area, Sq. Ft. 0, All building will be guttered
 Contributing Lot Runoff Area, Sq. Ft Surfaced 2,000 roof, 1000 concrete (scraped daily)
 Unsurfaced 15000
 Type of Bedding Sawdust
 Volume, CY/Day Current-150 CF/day Planned-160 CF/day

From milking and dry cows 95 % of waste to be handled as a solid from heifers and calves 100% of waste handled as a solid.

General Notes

Soils in the utilization area consist of moderately well drained silt loam soils.

Mr. Green uses a traveling "Big Gun" to apply liquids to the fields for utilization. The "Big "Gun operates at 300 GPM with a wetted diameter of 250 feet.

Mr. Green uses a 160 Bushel tractor spreader to spread solids in 15 foot wide strips to field for utilization.

Mr. Green stated he may apply for EQIP.

Assumptions for nutrient evaluations: for liquids a storage pond > than 50% dilution, for solids unroofed storage area, sprinkler application of liquids, spreader application of solids with incorporation within 3 days.

Animal Waste Management Planning Worksheet

G. Example #2

Animal Waste Management System Inventory Worksheet for Beef

Name of Landowner/Operator Mr. White

Street Address P.O. Box 6000

City Council, Idaho, or Zip Code 83-----

Phone Number 208 555-1212

Assisted by Ed Helpful Date Sometime very soon

General Description of Operation

Current Mr. White has a beef operation in which he feeds approximately 100 – 850 pound ave wt steers. He has 500 acres of alfalfa hay and wheat for disposal of wastes. During summer months animals are grazed or not on property. Alfalfa hay cut when mature.

Planned Mr. White is not planning to expand his herd, but would like to improve on his waste management system. He would like to add some type of waste storage facility to stop storm runoff onto neighbor. Solid wastes will be manure pack in corral. Wants to use a big gun sprinkler for applying liquids. Concrete pad is not scraped on a daily basis. Does not plan on using any wash water.

Problems The existing waste management system does not have any storage. Storm water in winter spring flows into nearby stream.

Livestock Data Current-

Description	Number	Average	Days		Days Storage	
		Weight Pounds	Confined	Grazed	Liquids	Solids
Feeders-forage	<u>100</u>	<u>850</u>	<u>243</u>	<u>122</u>	<u>0</u>	<u>0</u>
Feeders	_____	_____	_____	_____	<u>0</u>	<u>0</u>
Cows	_____	_____	_____	_____	<u>0</u>	<u>0</u>
Calves	_____	_____	_____	_____	<u>0</u>	<u>0</u>

Livestock Data Planned-

Average Days

<u>Description</u>	<u>Number</u>	<u>Weight Pounds</u>	<u>Days Confined</u>	<u>Days Grazed</u>	<u>Storage</u>	
					<u>Liquids</u>	<u>Solids</u>
<u>Feeders-forage</u>	<u>100</u>	<u>850</u>	<u>243</u>	<u>122</u>	<u>180</u>	<u>243</u>
Feeders	_____	_____	_____	_____	<u>0</u>	<u>0</u>
Cows	_____	_____	_____	_____	<u>0</u>	<u>0</u>
Calves	_____	_____	_____	_____	<u>0</u>	<u>0</u>

Storage Component Volumes

Holding Area (500-1200 gal/wash) _____ No. Washes _____
Contributing Drainage Area, Acres None
Contributing Roof Runoff Area, Sq. Ft. None
Contributing Lot Runoff Area, Sq. Ft Surfaced 1500 SF roofs, 1000 SF concrete slab
Unsurfaced 18000
Type of Bedding Wheat Straw
Volume, CY/Day 142 CF/day Currently and Planned

Utilization Area

<u>Field Number</u>	<u>Crop</u>	<u>Acres</u>	<u>Yield</u>		<u>(Good, Fair, Poor)</u>	
			<u>Present</u>	<u>Target</u>	<u>Crop Condition</u>	<u>Management Level</u>
<u>1 & 2</u>	<u>Grass/Legume Past</u>	<u>50</u>	<u>4 ton</u>	<u>4 ton</u>	<u>Good</u>	<u>Good</u>
<u>4 & 6</u>	<u>Alfalfa, Hay</u>	<u>60</u>	<u>4 ton</u>	<u>5 ton</u>	<u>Good</u>	<u>Good</u>
<u>3</u>	<u>Wheat</u>	<u>50</u>	<u>75 bu</u>	<u>75 bu</u>	<u>Good</u>	<u>Good</u>

General Notes

Soils in the utilization area consist of moderately well drained silt to silty loam soils. Depth to water table is greater than 4 feet.

No seepage entering liquid storage facility from feed storage area.

Mr. White has a “Big Gun” sprinkler that can be used to apply liquid waste to the utilization area. The “Big Gun” sprinkler has a flow rate of 165 gallons per minute and a wetted diameter of 200 feet. Mr. White also uses a 160 bushel spreader that spreads the solid waste in 20 foot wide strips to the utilization area.

APPENDIX D - WA NRCS ENGINEERING TECHNICAL NOTE #23

TECHNICAL NOTES

U.S. DEPARTMENT OF AGRICULTURE
ENGINEERING #23

NATURAL RESOURCES CONSERVATION SERVICE
SPOKANE, WASHINGTON
January, 2013

NRCS ASSESSMENT PROCEDURE FOR EXISTING WASTE STORAGE PONDS (WSP)

This Technical Note prescribes a consistent review and assessment process for assigning one of four rating categories and subcategories to a waste storage pond (WSP) according to observed factors that may contribute to the risk of contamination of water resources.

The NRCS assessment should not be construed to provide **ANY** regulatory certainty from State regulatory agencies. State of Washington laws and rules prohibit pollution of waters of the state, including ground water. The state requires a permit for discharge of wastewater to waters of the state. This document does not supersede these requirements.

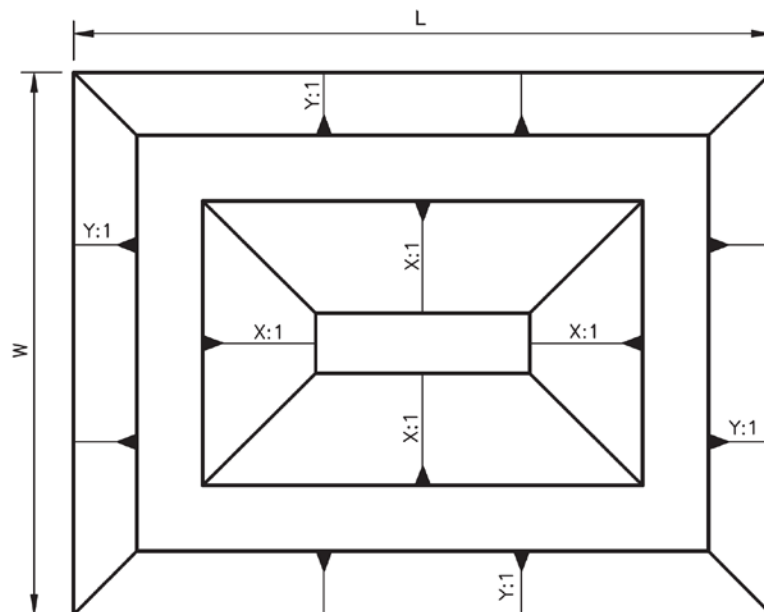

PLAN VIEW

Table of Contents

	<u>Page</u>
Introduction	3
Background	3
Procedure	3
Phase 1 – WSP Site and Structure Inventories	5
Phase 2 – Practice Standard Compliance	5
Phase 3 – Assessment	6
Other Considerations	8
References	9

FORMS

WSP Site and Structure Inventory Forms (SSIF)	11
WSP Practice Standard Compliance Review Form (PSCRF)	21
WSP Assessment Forms (AF)	24

APPENDIX

Appendix 1 – WSP Practice Standard Reference Documents	30
Appendix 2 – WSDA Aquifer Susceptibility Map	33
Appendix 3 – Designated Sole Source Aquifer Map for EPA Region 10	35
Appendix 4 – WSP Volume Estimating Spreadsheet	37

EXISTING WASTE STORAGE POND (WSP) ASSESSMENT PROCEDURE

INTRODUCTION

NRCS works with Dairy operators across Washington State to provide technical and financial assistance to further their effort in the implementation of practices that serve to protect water resources. Waste storage ponds (WSPs) encountered by NRCS staff, while providing assistance, may have been constructed to an outdated standard or constructed to no standard.

This technical note contains a site inventory and assessment procedure for evaluating existing WSPs. This procedure requires collecting existing WSP site information and conducting an assessment of the WSP and Site, to establish an overall assessment of a WSP according to observed factors that may contribute to the risk of water resources. The assessments in this technical note are qualitative in nature and are not intended to quantify seepage amounts occurring from existing WSP's.

BACKGROUND

Waste storage ponds (WSPs) are used in animal production agriculture for the purpose of containing liquid animal waste until such time that the waste can be utilized as a soil nutrient amendment for crop production. The Washington State Department of Agriculture (WSDA) is assigned the responsibility of statewide inspection and enforcement of Dairy facilities. If WSDA identifies a water quality concern, the operator is directed to NRCS and/or the local Conservation District (CD) for technical assistance. On a voluntary basis, NRCS and/or the CD collaborate with the Dairy operator to address the identified water quality concerns.

A WSP is a common component of a Dairy waste management system. Most often the existing WSP structure condition and performance is unknown. Information is needed in order to develop technically sound comprehensive nutrient management plan alternatives for the dairy operation. This technical note provides a standardized procedure for completing a assessment of, and recommendations for existing WSP's.

PROCEDURE

Through this procedure, NRCS personnel will establish an overall assessment category of a WSP according to observed factors that may contribute to the risk of water resource degradation. NRCS personnel will assign one of four rating categories and corresponding subcategory.

This Technical Note describes a three phase procedure that must be completed in order to assign an overall rating category to an existing WSP. Phase 1 consists of documenting the existing WSP and physical site features and includes a series of forms listed in the table below. Phase 2 documents whether the WSP complies with NRCS practice standard criteria. Phase 3 consists of assessment procedures.

The series of forms have been developed for conducting the assessment of the:

- Existing WSP
- Site
- The combined WSP/Site

Phases 1 and 2 must be completed before conducting Phase 3.

Table 1. Overview of Phase 1, 2 and 3 activities

Phase	Form	Name	Subparts
1	SSIF	WSP Site and Structure Inventory Forms	<ol style="list-style-type: none"> 1. General Site Information Form 2. Site Soils Form 3. Site Attributes Form 4. Structure Attributes Form 5. Structure Condition Form 6. Operation and Maintenance Form 7. Structure Modification Form
2	PSCRF	Practice Standard Compliance Report Form	None
3	AF	Assessment Forms	<ol style="list-style-type: none"> 1. Site Assessment Form 2. Structure Assessment Form 3. Overall Assessment Form

PHASE 1 – WSP SITE AND STRUCTURE INVENTORIES

WSP Site and Structure Inventory Forms (SSIF)

Purpose: These forms document the current WSP site and structure conditions.

1. General Site Information: This form is used to document the general information regarding the existing WSP (e.g.: landowner, Address, Location, etc.). General weather and field surface conditions are documented as the accuracy of the data collection effort may be hampered depending on these conditions.
2. Site Soils Form: This form is used to inventory and record the natural ground site soil properties and water table conditions.
3. Site Attributes Form: This form is used to collect and document the WSP site information.
4. Structure Attributes Form: This form is used to document the physical characteristics of the existing WSP. Information collected for this step include a measure of the; embankment height, side slopes, top width, pond depth, etc. It may be necessary to utilize survey equipment to gather this information. The review person should document how the data was collected so that the users of the information can determine if further data collection would be needed in the future.
5. Structure Condition Form: This form is used for the “Near Full” or “Near Empty” condition to document waste storage pond observations made during a site visit such as; erosion, liner and embankment condition.
6. Operation and Maintenance Inventory Form: This form is used for the “Near Full” or “Near Empty” condition to document waste storage pond O&M activities and the resulting effectiveness. Document whether or not there are minor or major repair needs.
7. Structure Modification Form: This form is used to document modifications that have been made to the WSP either through visual inspection or conversation with the operator.

PHASE 2 – PRACTICE STANDARD COMPLIANCE

Practice Standard Compliance Report Form (PSCRF)

Purpose: This form is used to compare the existing WSP or the most recent structure modification against NRCS criteria in place at the time of construction. The current NRCS design criteria for this practice is found in the NRCS Practice Standard 313-Waste Storage Facility. The preceding standard for this practice was the NRCS Practice Standard 425 - Waste Storage Pond. A table listing critical changes to the NRCS Practice Standard design criteria for all of the pertinent revisions is located in Appendix 1.

When completing the form, document whether or not the WSP is performing in accordance with NRCS practice standard in place at the time of construction.

PHASE 3 – ASSESSMENT

Assessment Forms (AF)

Purpose: These series of forms are used to complete the Site, Structure and Overall assessments.

1. Site Assessment Form: The Site Assessment takes into consideration the existing saturated hydraulic conductivity, presence of wells, distance to the nearest body of water, EPA Region 10 sole source aquifer designations and the WSDA Aquifer Susceptibility Maps. Risk ratings of “Low”, “Medium” or “High” are assigned and are defined as:

“Low Risk” - Located in an area that is highly unlikely to have water resources affected by the WSP.

“Medium Risk” - Located in an area that may have water resources that could be affected by the WSP, however the site could be modified to protect water resources.

“High Risk” - Located in an area where water resources are highly vulnerable to contamination and the site cannot be easily modified to protect water resources.

2. Structure Assessment Form: The Structure Assessment takes into account compliance with the NRCS practice standard in place at the time of construction and the inherent associated risk to the protection of water resources. Risk ratings of “Low”, “Medium” or “High” are assigned and are defined as:

“Low Risk” - Waste Storage Pond complies with the NRCS practice standard in use at the time when constructed.

“Medium Risk” - Waste Storage Pond complies with the NRCS practice standard in use at the time when constructed, however there are minor corrective actions necessary in order to restore the WSP to full functionality.

“High Risk” - Waste Storage Pond does not comply with the NRCS practice standard in use at the time when constructed. Major corrective actions are necessary in order to restore the WSP to full functionality.

3. Overall Assessment Form: The Overall Assessment takes into account the Site and Structure assessment. There are four Categories with subcategories that are defined as:

Category 1A - NRCS recommends utilizing the WSP for the purpose of waste storage.

Category 1B - NRCS recommends utilizing the WSP for the purpose of waste storage, however the site may benefit from additional practices to reduce discharge potential in the situation of a structure failure.

Category 2A - NRCS recommends utilizing the WSP for the purpose of waste storage, however the site would benefit from additional practices to reduce discharge potential in the situation of a structure failure.

Category 2B - NRCS recommends discontinued use of the WSP for the purpose of waste storage until minor repairs and/or improvements have been completed in accordance with the NRCS practice standard in place at the time of construction and the site may benefit from additional practices to reduce discharge potential in the situation of a structure failure.

Category 2C - NRCS recommends discontinued use of the WSP for the purpose of waste storage until minor repairs and/or improvements have been completed in accordance with the NRCS practice standard in place at the time of construction.

Category 3A - NRCS recommends discontinued use of the WSP for the purpose of waste storage until major repairs or possible replacement of the existing WSP meeting the current NRCS Conservation Practice Standard – 313, Waste Storage Facility.

Category 3B - NRCS recommends discontinued use of the WSP for the purpose of waste storage until major repairs or possible replacement of the existing WSP meeting the current NRCS Conservation Practice Standard – 313, Waste Storage Facility and the site may benefit from additional practices to reduce discharge potential in the situation of a structure failure.

Category 3C - NRCS recommends discontinued use of the WSP for the purpose of waste storage until minor repairs and/or improvements have been completed for the waste storage pond structure and the site would benefit from additional practices to reduce discharge potential in the situation of a structure failure with structure relocation being considered.

Category 4 - NRCS recommends discontinued use of the WSP for the purpose of waste storage until major repairs or possible replacement of the existing WSP meeting the current NRCS Conservation Practice Standard – 313, Waste Storage Facility and the site would benefit from additional practices to reduce discharge potential in the situation of a structure failure with structure relocation being considered.

OTHER CONSIDERATIONS/ CRITERIA

An existing WSP that stores more than 10 acre-feet above the ground surface must also be evaluated in accordance with the Washington Department of Ecology (DOE), Dam Safety Office (DSO) regulatory requirements. The DOE Dam Safety Office schedule regular review and inspection of jurisdictional WSP projects focused on configuring the WSP to survive suitable design floods and earthquakes. The DSO does not evaluate the adequacy of jurisdictional WSP's in meeting ground water quality performance requirements.

This Technical Note does not evaluate compliance with WA DOE Dam Safety criteria. If the WSP is a state regulated structure the DSO criteria will need to be met in addition to NRCS criteria.

REFERENCES:

1. "Earthen Manure Storage Seepage: A Study of Five Typical Sites," Prepared by: Principal investigator, Bill MacMillan with Study Summary by, Robert Borg and Peter Llewellyn, Agri-Facts, Practical Information for Alberta's Agriculture Industry, July 2001, Agdex 729-1
2. "Seepage Evaluation of Older Swine Lagoons in North Carolina," By R.L. Huffman, 2004 American Society of Agricultural Engineers, Vol. 47(5): pp 1507-1512.
3. "Measurement of Seepage from Earthen Waste Storage Structures in Iowa", T.D. Glanville, J.L. Baker, S.W. Melvin and M.M. Agua, 1999, Department of Agricultural & Biosystems Engineering, Iowa State University, Ames, Iowa 50011
4. DISCUSSION OF "Literature Review and Model (COMET) for Colloid/Metals and Transport in Porous Media", By W. B. Mills, S. Liu, and F.K. Fong, Groundwater, March-April 1991 issue, v. 29, no. 2, pp 199-208.
5. "Geologic and Ground Water Considerations," Chapter 7, Agricultural Waste Management Field Handbook, National Engineering Handbook (NEH),Part 657.07, Natural Resources Conservation Service, June, 1999.
6. "Agricultural Waste Management System Component Design," Chapter 10, Agricultural Waste Management Field Handbook, Amendment 31, National Engineering Handbook (NEH),Part 657.07, Natural Resources Conservation Service, August 2009.
7. "Design and Construction Guidelines for Impoundments Lined with Clay or Amendment-treated Soil," Appendix 10D, Agricultural Waste Management Field Handbook, Amendment 31, National Engineering Handbook (NEH),Part 657.07, Natural Resources Conservation Service, August 2009.
8. "Ground Water/Surface Water Interactions and Quality of Discharging Ground Water in Streams of the Lower Nooksack River Basin, Whatcom County, Washington", Stephen E. Cox, USGS; William Simonds, USGS; Llyn Doremus, Nooksack Indian Tribe, et. al. Scientific Investigations Report 2005-5255, U.S. Department of the Interior, U.S. Geological Survey.
9. "Liquid Animal Waste System Operation & Inspection Guide", Alabama Cooperative Extension System, BSEN – 01C4 (REV JUN 03), By Ted W. Tyson, P.E., C.I.D., Extension Biosystems Engineer & Professor, Auburn University.
10. "Guidance for the Evaluation of Existing Storage Structures", Michigan Department of Environmental Quality, Water Bureau, December 2, 2005.
11. "Subsurface Investigations for Waste Storage Facilities", 04/22/2009, Michigan NRCS, Animal Waste Management website. http://www.mi.nrcs.usda.gov/technical/engineering/animal_waste.html
12. "An AEM Tool for the Evaluation of Un-Designed Waste Storage Facilities", Agricultural Environmental Management, New York State, Soil & Water Conservation Committee, Department of Agriculture and Markets.

13. "Evaluation of Existing Waste Storage Facilities", William Reck PE, Darren Hickman PE, William Boyd PE, USDA-NRCS National Technical Service Center(s), 2006.
14. "Water Quality Indicator Tools", Water Quality Technical Note 1, Washington State NRCS, July 2000.
15. "Waste Storage Facility, Conservation Practice Standard, Code 313", USDA-NRCS, Washington State.
16. EPA Region 10 Sole Source Aquifer Maps,
<http://yosemite.epa.gov/r10/water.nsf/Sole+Source+Aquifers/ssamaps>

SITE AND STRUCTURE INVENTORY FORMS (SSIF)

INSTRUCTIONS: The Site and Structure Inventory Forms are used to document the existing condition, physical features, evidence of operation / maintenance activities and the physical attributes of the WSP. The information collected through this process is used to complete the assessments for an existing WSP.

GENERAL SITE INFORMATION FORM:

Step 1: Document the landowner/farm name, address and the specific WSP location.

Step 2: Check the appropriate box for the review being completed, “WSP is near FULL or “WSP is near EMPTY”.

Step 3: Complete the climatic condition section. This data is very important as it conveys the limitations present during the inventory process.

SITE SOILS FORM:

The Site Soils Form is used to document the existing WSP Site Soils. If there are different site soil types, it may be necessary to complete multiple reports.

SITE ATTRIBUTES FORM:

Information is either measured in the field, from maps, appendices of this technical note or from other previously completed forms of this technical note.

STRUCTURE ATTRIBUTES FORM:

Information is measured during the site visit or gathered from as-built documents. Provide comments pertinent to the site or structure for consideration during the assessment phase.

STRUCTURE CONDITION FORM:

Responses are either yes, no or N/A. The form was set up to address the Full or Empty condition, some of the questions may not apply depending on which condition is being evaluated.

SITE AND STRUCTURE INVENTORY FORMS (SSIF)**INSTRUCTIONS: (Continued)****OPERATION AND MAINTENANCE INVENTORY FORM:**

Read each question and provide the appropriate response. Responses are either yes, no or N/A. The form was set up to address the Full or Empty condition, some of the questions may not apply depending on which condition is being evaluated.

WSP - MODIFICATIONS:

All WSP modifications shall be documented and an impact assessment shall be included.

SIGNATURE BLOCK:

The technically responsible staff person completing the forms shall print and sign their name. The Engineering Job Approval Authority for PS 313, "Design" will be included when completed by NRCS staff.

SITE AND STRUCTURE INVENTORY FORMS (SSIF)**GENERAL SITE INFORMATION FORM**

LANDOWNER/FARM NAME: _____

ADDRESS: _____ STATE: _____ ZIP: _____

WSP LOCATION: Sec _____ T ____ R ____ (or) Lat _____ Long _____

NRCS JOB CLASS: _____

CHECK REVIEW CONDITION BELOW:

WSP is FULL (Typically late winter or early spring)

WSP is near EMPTY (Typically late summer or early fall)

MANURE/ EFFLUENT LEVEL and Other Observations: _____

TODAY: Liquid Level BELOW Top of Embankment or Spillway Elevation: _____ FT.

CLIMATIC CONDITIONS

Weather:

Temperature:

Soil Surface Conditions (circle all that apply):

Dry / Moist / Wet / Saturated / Standing Water/ Frozen/ Snow Covered

Additional Information:

SITE AND STRUCTURE INVENTORY FORMS (SSIF)**SITE SOILS FORM**

INSTRUCTIONS: The Site Soils Report Form is used to document the existing WSP Site Soils. If there are different site soil types within the footprint of the structure or nearby it may be necessary to complete multiple reports.

Step 1: The landowner/farm name, address as well as the specific WSP location shall be documented.

Note: Attaching a soils map with the WSP location for documentation purposes is recommended.

Step 2: The soil type and soil profile properties are retrieved from the NRCS Web Soil Survey (WSS). Aerial photos may also be used to document the surface water section of the site soils report.

It will be necessary to document the USCS classification for soils below the pond bottom surface. If there are two or more soil permeability rate values below the pond bottom surface, it is recommended to use the greatest permeability rate.

Step 3: Upon conducting a site visit it is recommended to verify any data obtained electronically when at the site. This is completed by digging soil pits or using a hand held soil auger.

SITE SOILS COMMENTS / NOTES

SITE SOILS COMMENTS / NOTES

SITE AND STRUCTURE INVENTORY FORMS (SSIF)
Site Soils Report
Dominant Soil Type

 Soil Survey Area Name

 Map Unit Symbol

 Map Unit Name
Soil Profile

Top Depth (in)	Bottom Depth (in)	Unified Soil Classification	K _{sat} low (μm/sec)	K _{sat} high (μm/sec)
<input type="text"/>	<input type="text"/>	<input type="text"/>	<input type="text"/>	<input type="text"/>
<input type="text"/>	<input type="text"/>	<input type="text"/>	<input type="text"/>	<input type="text"/>
<input type="text"/>	<input type="text"/>	<input type="text"/>	<input type="text"/>	<input type="text"/>
<input type="text"/>	<input type="text"/>	<input type="text"/>	<input type="text"/>	<input type="text"/>
<input type="text"/>	<input type="text"/>	<input type="text"/>	<input type="text"/>	<input type="text"/>
<input type="text"/>	<input type="text"/>	<input type="text"/>	<input type="text"/>	<input type="text"/>
<input type="text"/>	<input type="text"/>	<input type="text"/>	<input type="text"/>	<input type="text"/>
<input type="text"/>	<input type="text"/>	<input type="text"/>	<input type="text"/>	<input type="text"/>

 Maximum Hydraulic conductivity (K_{sat}) below WSP bottom surface (μm/sec)

 Depth to water table (in)

SITE AND STRUCTURE INVENTORY FORMS (SSIF)

WSP - SITE ATTRIBUTES FORM	
SITE INVENTORY QUESTIONS	RESPONSE
1. Saturated Hydraulic Conductivity (K_{sat}) of the Existing WSP site soils below the WSP surface (Refer to SSRF)	
2. Distance from the nearest edge of WSP to the nearest groundwater water supply wells	
a. Depth to groundwater source if distance is less than 100 feet from the nearest edge of the WSP. (Refer to DOE well log data sheet or estimate from the landowner)	
3. Distance from nearest toe of WSP to nearest surface water flow or body	
a. If distance is less than 300 feet is there a natural secondary barrier or containment dike between the WSP and the Surface water of concern?	
4. WSP located within an EPA Region 10 Sole Source Aquifer or Source Area? (Refer to Appendix 3 for Regional Map. For more detailed maps visit EPA Region 10 website at: http://yosemite.epa.gov/r10/water.nsf/Sole+Source+Aquifers/ssamaps)	(Circle One) Yes / No
5. WSDA Aquifer Susceptibility Rating? (Refer to Appendix 2 for State Map.)	(Circle One) Very Low Low Medium High

WSP - STRUCTURE ATTRIBUTES FORM	
WSP STRUCTURE ATTRIBUTES	NOTES
1. WSP - Inside Top - Average Width (ft)	
2. WSP - Inside Top - Average Length (ft)	
3. WSP Storage Capacity (cu ft)	
4. Embankment - Inside SS (X:1)	
5. Embankment - Outside SS (Y:1)	
6. Embankment - Top Width (ft)	
7. Combined Side Slope (Outside SS + Inside SS)	
8. Embankment - Maximum Fill Height (ft)	
9. Maximum Excavation Depth (ft)	
10. Total Pond Depth (ft)	
11. Liner Type and Thickness (in)	
12. Inlet Type and Location	
13. WSP Interior-Outlet Ramp Slope (z:1)	
14. Distance to Nearest Well / Water Depth in well(ft)	
15. Failure Impacts; Farm Building, Homes, Roads, Water Course	
16. Emptying Feature is provided to protect against accidental release. (yes/no) If yes please describe in the note section.	
17. Distance to Nearest Home/Dwelling (ft)	
18. Distance to Nearest Water Course (ft)	
WSP - STRUCTURE COMMENTS / NOTES	

SITE AND STRUCTURE INVENTORY FORMS (SSIF)



SITE AND STRUCTURE INVENTORY FORMS (SSIF)

WSP - STRUCTURE CONDITION FORM					
If any boxes checked "YES"; make notes of items for concern, possible extent of damage, identify options to repair, stabilize or address in the REPORT section.					
SITE INVENTORY QUESTIONS		YES	NO	NA	
Liner	Liner type: <input type="checkbox"/> None <input type="checkbox"/> Compacted Clay <input type="checkbox"/> Flexible Membrane <input type="checkbox"/> Bentonite Amendment (Circle One)				
	Evidence of liner slumps, bulges, boils, or whales?				
	If applicable; Are perimeter drain(s) plugged or blocked?				
Embankment – Crest, Exterior Slope and Toe¹	Evidence of cracks in embankment soils?				
	Damp, soft, or slumping areas?				
	Evidence of seepage on the embankment slope?				
	Evidence of seepage around pipes through berm?				
	Evidence of differential (uneven) settlement?				
	Evidence of seepage at the toe of the embankment?				
	Evidence of sand boils on the slope, along the toe or near the toe?				
WSP – Interior Surface	Interior erosion due to wave action?				
	Interior erosion from rainfall?				
¹ Complete inventory questions appropriate to structure, <i>if no embankment, as in a pit pond, show NA.</i>					
NOTES:					

SITE AND STRUCTURE INVENTORY FORMS (SSIF)

WSP - OPERATION AND MAINTENANCE INVENTORY FORM				
If any boxes checked “ YES ”; make notes of location and identify O & M task to improve management in REPORT section.				
SITE INVENTORY QUESTIONS		YES	NO	NA
Embankment – Crest, Exterior Slope and Toe¹	Damage from burrowing animals?			
	Evidence of overtopping of embankment?			
	Evidence of soil erosion or gully on embankment?			
	Pond transfer pipe/structure is obstructed?			
	Presence of trees or woody vegetation?			
	Waste storage pond access is not fenced and properly marked? If not required for structure then n/a.			
WSP Interior/Liner	Interior erosion in vicinity of waste inlet structure?			
	Interior erosion near agitation equipment access points?			
	General erosion of liner material?			
	Damaged liner material (holes, tears, seams)?			
Waste Transfer	Any pumps or transfer pipes are not functional?			
	Any recycling pumps or transfer pipes are not functional?			
Odor	Downwind odor from WSP is strong or unbearable?			
¹ Complete inventory questions appropriate to structure, if no embankment, as in a pit pond, show NA.				
NOTES:				
STRUCTURE and O&M CONDITION CONCERNS		YES	NO	
Was any abnormal condition or practice observed that requires corrective action (If yes then answer 1 and 2 below):				
1. Minor repair or change in practice would bring the WSP into compliance with accepted practice.				
2. Major repair or change in practice would bring the WSP into compliance with accepted practice.				

SITE AND STRUCTURE INVENTORY FORMS (SSIF)

WSP - STRUCTURE MODIFICATION FORM			
		Yes	No
HAS THE WSP BEEN STRUCTURALLY MODIFIED? <i>(If "Yes" complete 1 through 5 below)</i>			
1	Was the WSP modification designed by a qualified individual?		
	Date design of modification		
	Designer (If applicable)		
2	Date of modification construction		
3	<u>Description of structural modification:</u>		
	Did the modification meet the NRCS practice standard in place at the time of construction?		
4	<u>Describe impact of the modification on structural integrity:</u>		
	<u>Describe impact of the modification on storage depth and storage volume:</u>		
WSP Inventory Completed by			
Name:		JAA	
Signature:		Date:	

PRACTICE STANDARD COMPLIANCE REPORT FORM (PSCRf)

INSTRUCTIONS: The Practice Standard Compliance Report Form compares the WSP inventory data to the benchmark condition.

PRACTICE STANDARD COMPLIANCE REPORT FORM:

Step 1: Document the landowner/farm name, address as well as the specific WSP location.

Step 2: Fill in all fields if applicable otherwise place N/A.

Step 3: Complete the physical attributes table for “Current Conditions” by copying forward information from the “WSP Physical Attributes Table”.

Step 4: Complete the NRCS Practice Standard Criteria section referring to Appendix 1, NRCS practice standard criteria for WSP’s. Place the relative NRCS criteria based on the year the WSP was constructed or when the last modification was completed. If the WSP was constructed prior to 1979, then the 1979 criteria shall apply.

SIGNATURE BLOCK:

The technically responsible staff person completing the forms shall print and sign their name. The Engineering Job Approval Authority for PS 313, “Design” will be included when completed by NRCS staff.



PRACTICE STANDARD COMPLIANCE REPORT FORM (PSCRF)

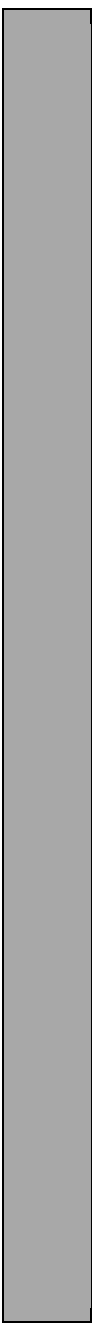

LANDOWNER/FARM NAME: _____ STATE: _____ ZIP: _____
 ADDRESS: _____
 WSP LOCATION: Sec _____ T _____ R _____ (or) Lat _____ Long _____
 DATE ORIGINAL WASTE STORAGE POND or MODIFICATION COMPLETED: _____

NRCS Practice Standard 313 Compliance Check			
PHYSICAL WSP ATTRIBUTES	CURRENT CONDITIONS	NRCS Practice Standard criteria ¹	Complies NRCS Practice Standard Criteria? (Circle One)
1. Embankment height. (Ref SSIF 7/10 - 8.0)			Yes - No - N/A
2. Failure of WSP would result in damages limited to farm buildings, ag-land, or country roads. (Ref SSIF 7/10 - 15.0)			Yes - No - N/A
3. WSP embankment elevation above 25 yr. floodplain. (Estimated)			Yes - No - N/A
4. Inlet permanent and resists; corrosion, plugging, freeze damage and is UV protected. (Ref SSIF 7/10 - 12.0)			Yes - No - N/A
5. Emptying features are provided and are protected against erosion and accidental release. (Ref SSIF 7/10 - 16.0)			Yes - No - N/A
6. Slurry or solid storage ramp slope. (Ref SSIF 7/10 - 13.0)			Yes - No - N/A
7. Fencing necessary for protection of humans and livestock. (Ref SSIF 9/10)			Yes - No - N/A
8. WSP embankment protected against erosion. (Ref SSIF 8/10 & 9/10)			Yes - No - N/A
9. Separation distance from WSP bottom and SHGWT. (Ref SSIF 5/10)			Yes - No - N/A
10. Liner. (Ref SSIF 8/10 & 9/10)			Yes - No - N/A
11. Liner type (Ref PS 521). (Ref SSIF 8/10)			Yes - No - N/A
12. If no liner, foundation soils permeability. (Ref SSIF 5/10)			Yes - No - N/A

¹ Appendix 1: Refer to the NRCS practice standard design criteria by date of adoption for current and archived NRCS practice standards used for Waste Storage Pond design and construction in WA State.



PRACTICE STANDARD COMPLIANCE REPORT FORM

NRCS Practice Standard 313 Compliance Check (***)Continued(***)			
PHYSICAL WSP ATTRIBUTES	CURRENT CONDITIONS	NRCS Practice Standard criteria ²	Complies NRCS Practice Standard Criteria?
13. Embankment inside side slope. (Ref SSIF 7/10 - 4.0)			Yes - No - N/A
14. Embankment outside side slope. (Ref SSIF 7/10 - 5.0)			Yes - No - N/A
15. Combined embankment side slope. (Ref SSIF 7/10 - 7.0)			Yes - No - N/A
16. WSP above ground volumetric storage. (Estimated)			Yes - No - N/A
17. Minimum distance to dwellings. (Ref SSIF 7/10 - 17.0)			Yes - No - N/A
18. Embankment top width. (Ref SSIF 7/10 - 6.0)			Yes - No - N/A
19. Minimum distance to water well. (Ref SSIF 7/10 - 14.0)			Yes - No - N/A
20. Minimum distance to water course. (Ref SSIF 7/10 - 18.0)			Yes - No - N/A
Compliance Check Results		YES	NO
Does the WSP comply with NRCS practice standards at the time of construction or modification?			

WSP Compliance Review Completed by (Print): _____ JAA: _____

Signature _____ Date: _____

² Appendix 1: Refer to the NRCS practice standard design criteria by date of adoption for current and archived NRCS practice standards used for Waste Storage Pond design and construction in WA State.

WSP ASSESSMENT FORMS (AF)

INSTRUCTIONS: The assessment forms provide a standardized procedure for assigning a category that ranks a WSP according to observed factors that may contribute to the risk of degradation to water resources.

SITE ASSESSMENT FORM:

The information that is utilized for the Site Assessment is the completed data located on the Site and Structure Inventory Form.

Step 1: Carefully read each question and check corresponding box.

Step 2: Record the score points in the right hand column for each question.

Step 3: Total the score points and assign the corresponding risk rating.

STRUCTURE ASSESSMENT FORM:

The information that is utilized for the Structure Assessment is the completed data located on the Site and Structure Inventory Form and the Practice Standard Compliance Report Form.

Step 1: Carefully read each question and check corresponding box.

Step 2: Record the score points in the right hand column for each question.

Step 3: Total the score points and assign the corresponding risk rating.

OVERALL ASSESSMENT FORM:

The Overall Assessment Form is completed utilizing the results on the Site and Structure Assessment Forms.

Step 1: On the “Risk Probability Matrix for Water Resource Degradation” plot the “Site Risk” rating and the “Structure Risk” rating.

Step 2: Circle the resulting combined risk factor on the matrix.

Step 3: From the Risk Probability Matrix for Groundwater Degradation check the corresponding box to document recommended actions for the Existing Waste Storage Pond.

SIGNATURE BLOCK:

The technically responsible staff person completing the forms shall print and sign their name. The Engineering Job Approval Authority for PS 313, “Design” will be included when completed by NRCS staff.

WSP ASSESSMENT FORMS

SITE ASSESSMENT FORM				
Consideration	Categories (Check appropriate box for each consideration and record points in the right hand column)			Score
Saturated Hydraulic Conductivity (K_{sat}) of the soils below the WSP bottom surface	Less than 2 $\mu\text{m}/\text{sec}$	Between 2 and 20 $\mu\text{m}/\text{sec}$	Greater than 20 $\mu\text{m}/\text{sec}$	
	<input type="checkbox"/> 0 points	<input type="checkbox"/> 1 points	<input type="checkbox"/> 3 points	
Shallow (< 145 feet deep) groundwater water supply wells within 100 feet of the nearest edge of the WSP	No	Yes, but it is technically feasible to decommission or relocate the shallow groundwater well	Yes, but it is not technically feasible to decommission or relocate the shallow groundwater well	
	<input type="checkbox"/> 0 points	<input type="checkbox"/> 1 points	<input type="checkbox"/> 3 points	
Distance from the nearest surface water flow or body to the toe of the WSP	Greater than 300 ft	Less than 300 ft. but technically feasible to construct a secondary barrier or containment dike between the WSP and the surface water of concern.	Less than 300 ft. but not technically feasible to construct a secondary barrier or containment dike between the WSP and the surface water of concern.	
	<input type="checkbox"/> 0 points	<input type="checkbox"/> 1 points	<input type="checkbox"/> 3 points	
Location with respect to an EPA Region 10 Sole Source Aquifer or Source Area and Medium to High Aquifer Susceptibility according to the WSDA Aquifer Susceptibility Map	Not located in either	Located in one, but not the other	Located in both.	
	<input type="checkbox"/> 0 points	<input type="checkbox"/> 3 points	<input type="checkbox"/> 6 points	
			Total Score	
			Risk	

Total Score **Risk Rating**
 2 points or less = Low Risk
 3 to 5 points = Medium Risk
 6 points or more = High Risk

WSP ASSESSMENT FORMS

STRUCTURE ASSESSMENT FORM				
Consideration	Categories (Check appropriate box for each consideration and record points in the right hand column)			Score
	Yes		No	
WSP complies with NRCS practice standard criteria (PSCRF 3/3)	<input type="checkbox"/> 0 points	N/A	<input type="checkbox"/> 6 points	
Earthen structural condition questions (SSIF 8/10)	<input type="checkbox"/> 0 points	One or more of the questions answered "YES"; repairs require minor restoration effort ¹ .	One or more of the questions answered "YES"; repairs require major restoration effort ² .	
		<input type="checkbox"/> 3 points	<input type="checkbox"/> 6 points	
Operation and maintenance questions (SSIF 9/10)	<input type="checkbox"/> 0 points	One or more of the questions answered "YES"; repairs require minor restoration effort ¹ .	One or more of the questions answered "YES"; repairs require major restoration effort ² .	
		<input type="checkbox"/> 2 points	<input type="checkbox"/> 4 points	
Structural modifications	<input type="checkbox"/> 0 points	Not constructed in accordance with NRCS practice standard criteria in place at the time; repairs require minor restoration effort ¹ .	Not constructed in accordance with NRCS practice standard criteria in place at the time; repairs require major restoration effort ² .	
		<input type="checkbox"/> 3 points	<input type="checkbox"/> 6 points	
			Total Score	
			Risk Rating	

Total Score **Risk Rating**
 2 points or less = **Low Risk**
 3 to 5 points = **Medium Risk**
 6 points or more = **High Risk**

1. Minor restoration effort – Restorative activities can be completed without significant disturbance to the WSP.
2. Major restoration effort – Restorative activities cannot be completed without significant disturbance to the WSP.

WSP ASSESSMENT FORMS

OVERALL ASSESSMENT FORM

Instructions: On the “Risk Probability Matrix for Water Resource Degradation” plot the following factors and circle the resulting combined risk factor on the matrix.

1. **Ground Water Resource - Site Risk** on the Y axis
2. **WSP Seepage - Structure Risk** on the X axis

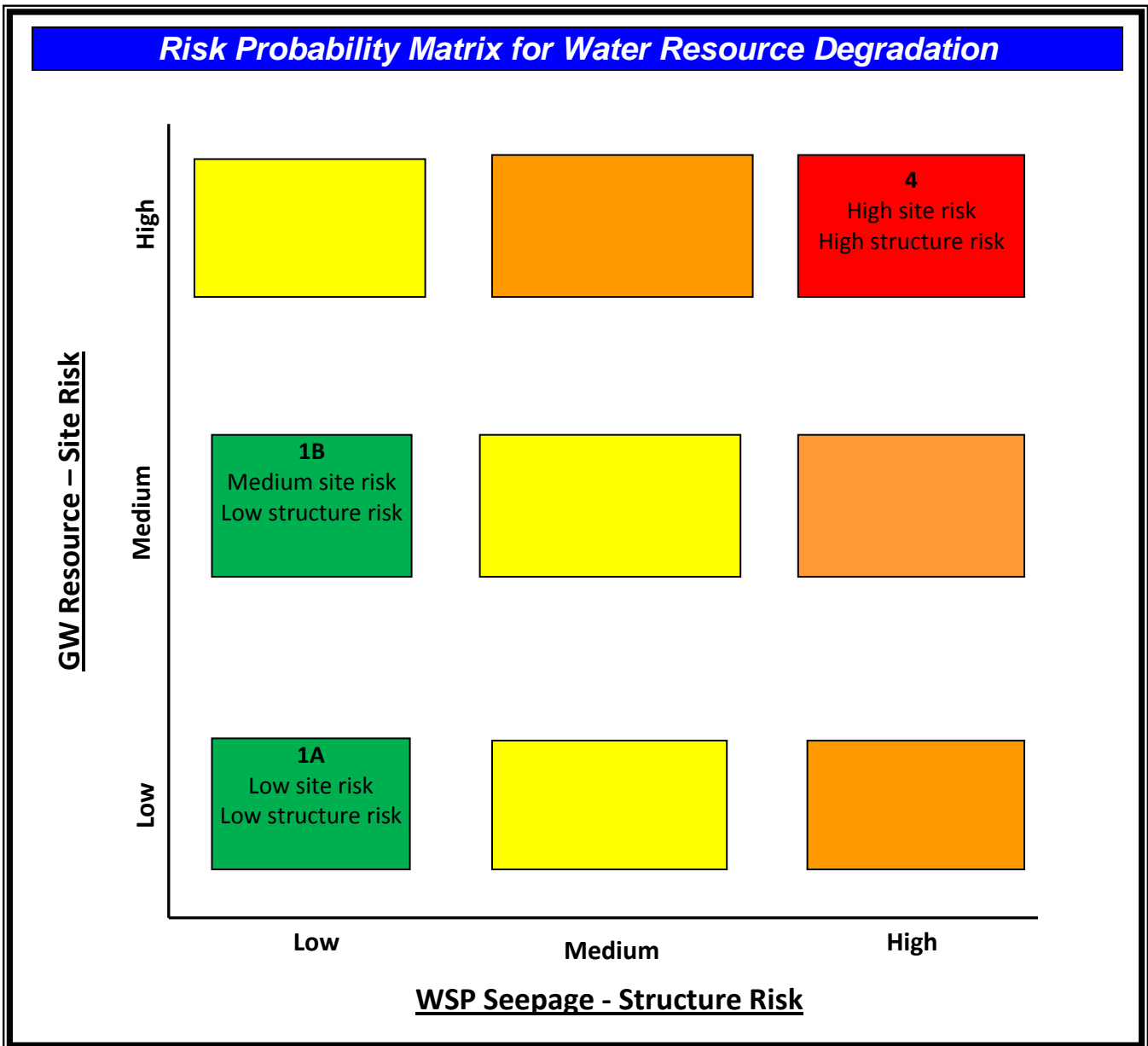

WSP ASSESSMENT FORMS

Instructions: From the Risk Probability Matrix for Water Resource Degradation check the corresponding box to document recommended actions for the existing Waste Storage Pond.

Category 1



A

Low site risk
Low structure risk

B

Medium site risk
Low structure risk

Category 1A - NRCS recommends utilizing the WSP for the purposes of waste storage.

Category 1B - NRCS recommends utilizing the WSP for the purposes of waste storage, however the site may benefit from additional practices to reduce discharge potential in the situation of a structure failure.

Category 2



A

High site risk
Low structure risk

B

Medium site risk
Medium structure

C

Low site risk
Medium structure risk

Category 2A - NRCS recommends utilizing the WSP for the purposes of waste storage, however the site would benefit from additional practices to reduce discharge potential in the situation of a structure failure.

Category 2B - NRCS recommends discontinued use of the WSP for the purposes of waste storage until minor repairs and/or improvements have been completed in accordance with the NRCS practice standard in place at the time of construction and the site may benefit from additional practices to reduce discharge potential in the situation of a structure failure.

Category 2C - NRCS recommends discontinued use of the WSP for the purposes of waste storage until minor repairs and/or improvements have been completed in accordance with the NRCS practice standard in place at the time of construction.

CONTINUED NEXT PAGE

WSP ASSESSMENT FORMS

CONTINUED FROM PREVIOUS PAGE

Category 3



A

Low site risk
High structure risk

B

Medium site risk
High structure risk

C

High site risk
Medium structure

Category 3A - NRCS recommends discontinued use of the WSP for the purposes of waste storage until major repairs or possible replacement of the existing WSP meeting the current NRCS Conservation Practice Standard – 313, Waste Storage Facility.

Category 3B - NRCS recommends discontinued use of the WSP for the purposes of waste storage until major repairs or possible replacement of the existing WSP meeting the current NRCS Conservation Practice Standard – 313, Waste Storage Facility and the site may benefit from additional practices to reduce discharge potential in the situation of a structure failure.

Category 3C - NRCS recommends discontinued use of the WSP for the purposes of waste storage until minor repairs and/or improvements have been completed for the waste storage pond structure and the site would benefit from additional practices to reduce discharge potential in the situation of a structure failure with structure relocation being considered.

Category 4



High site risk
High structure risk

Category 4 - NRCS recommends discontinued use of the WSP for the purposes of waste storage until major repairs or possible replacement of the existing WSP meeting the current NRCS Conservation Practice Standard – 313, Waste Storage Facility and the site would benefit from additional practices to reduce discharge potential in the situation of a structure failure with structure relocation being considered.

SIGNATURE BLOCK

THE WSP INTEGRITY ASSESSMENT REPORT WAS COMPLETED BY:

Evaluating Personnel: _____ Date: _____

Agency: _____

PS 313 Assigned Job Approval Authority for “WSP Review Assessment”: _____

Appendix 1

WSP Practice Standard Criteria Reference Documents

Table outline for – NRCS Practice Standard Criteria Revisions and WA State Supplements

Waste Storage Pond, PS-425, Dated: 1979 -1994

Waste Storage Facility, PS-313, Dated 2000 - Current

Washington State NRCS REVISION and Supplement Dates:

- April 1979 -
- February 1987 – State Supplement
- January 1994 – State Supplement
- February 2000
- June 2001
- December 2004

Earth pond construction dimension criteria for all WSP practices and all revisions: April 1979 to December 2004

Practice Standard Code/Name	PS 425 Waste Storage pond			PS 313 Waste Storage Facility		
	1979, April			2000, February	2001, June	2004, December
Supplement Release Date		1987, February	1994, January			
1. Embankment Height.	35 feet or Less	35 feet or Less	35 feet or Less	35 feet or Less	35 feet or Less	35 feet or Less
2. Failure of WSP would result in damages limited to farm buildings, Ag-Land, or country roads.	N/A	N/A	N/A	Yes	Yes	Yes
3. WSP Embankment Elevation above Floodplain?	25 Yr	25 Yr	25 Yr	25 Yr	25 Yr	25 Yr
4. Inlet permanent and resists; corrosion, plugging, freeze damage and is UV protected?	Yes	Yes	Yes	Yes	Yes	Yes
5. Emptying features are provided and are protected against erosion and accidental release?	Yes	Yes	Yes	Yes	Yes	Yes
6. Liquid Storage Ramp slope.	4:1	4:1	4:1	4:1	4:1	4:1
7. If the WSP creates a safety hazard fencing is necessary for protection of Humans and livestock.	Yes	Yes	Yes	Yes	Yes	Yes
8. WSP Embankment protected against erosion.	Yes	Yes	Yes	Yes	Yes	Yes
9. Separation distance from WSP Bottom and SHGWT.	0 Inches	6 inches	6 inches	24 inches	24 inches	24 inches
10. Liner	Only if Self Sealing is not anticipated	Required for all foundation material, except glacial till, when closer than 300 feet to a domestic well.	Required for all WSP's	Required for all WSP's	Required for all WSP's if wetted surface permeability rate is less than 1×10^{-6} cm/s	Required for all WSP's if wetted surface permeability rate is less than 1×10^{-6} cm/s

****(CONTINUED)****

Earth pond construction dimension criteria for all WSP practices and all revisions: April 1979 to December 2004

Practice Standard Code/Name	PS 425 Waste Storage pond			PS 313 Waste Storage Facility		
	1979, April			2000, February	2001, June	2004, December
Supplement Release Date		1987, February	1994, January			
11. Liner type (Ref PS 521)	If Required	<u>Minimum Requirements</u> GM – 12" thick GC – 9" thick SM – 12" thick SC – 9" thick ML – 12" thick CL – 6" thick CH – 6" thick	12" Minimum thickness & soils requirement GM-w/20% fines GC-w/20% fines SM-w/20% fines SC-w/20% fines (or Amended) ML MH CL CH	12" Minimum thickness & soils requirement GM-w/20% fines GC-w/20% fines SM-w/20% fines SC-w/20% fines (or Amended) ML MH CL CH	12" Minimum thickness & soils requirement of permeability rate is less than 1×10^{-6} cm/s	12" Minimum thickness & soils requirement of permeability rate is less than 1×10^{-6} cm/s
12. If no liner, foundation soils permeability.	Low to Moderate	Low to Moderate	Must be equivalent to liner requirement	Must be equivalent to liner requirement	Must be equivalent to liner requirement	Must be equivalent to liner requirement
13. Maximum operating level marker	N/A	N/A	N/A	N/A	Yes	Yes
14. Embankment Top Width (minimum)	8 feet	8 feet	8 feet	8 feet	Embankment Height / Width 15' or Less / 8' 15'-20' / 10' 20'-25' / 12' 25'-30' / 14' 30'-35' / 15'	Embankment Height / Width 15' or Less / 8' 15'-20' / 10' 20'-25' / 12' 25'-30' / 14' 30'-35' / 15'
15. Embankment Inside Side Slope	N/A	N/A	N/A	No Steeper Than 2:1	No Steeper Than 2:1	No Steeper Than 2:1
16. Embankment Outside Side Slope	N/A	N/A	N/A	No Steeper Than 2:1	No Steeper Than 2:1	No Steeper Than 2:1
17. Combined Embankment Side Slope (minimum)	5:1	5:1	5:1	5:1	5:1	5:1
18. WSP Above Ground Volumetric Storage ³	If over 10 ac-ft above ground storage refer to DOE Dam Safety Criteria	If over 10 ac-ft above ground storage refer to DOE Dam Safety Criteria	If over 10 ac-ft above ground storage refer to DOE Dam Safety Criteria	If over 10 ac-ft above ground storage refer to DOE Dam Safety Criteria	If over 10 ac-ft above ground storage refer to DOE Dam Safety Criteria	If over 10 ac-ft above ground storage refer to DOE Dam Safety Criteria
19. Minimum Distance to Dwellings	100 feet	100 feet	100 feet	N/A	N/A	N/A
20. Minimum Distance to water well	N/A	100 ft., 200 ft. for unconfined aquifers	300 feet	300 feet	300 feet	100 feet
21. Minimum distance to water course	N/A	25 feet	25 feet	N/A	N/A	N/A

³ The storage threshold is the theoretical volume contained in the WSP with the fluid level at the top of the embankment, not at the operating level.

Appendix 2

WSDA Aquifer Susceptibility Map

Aquifer Susceptibility Map - Washington State 2011

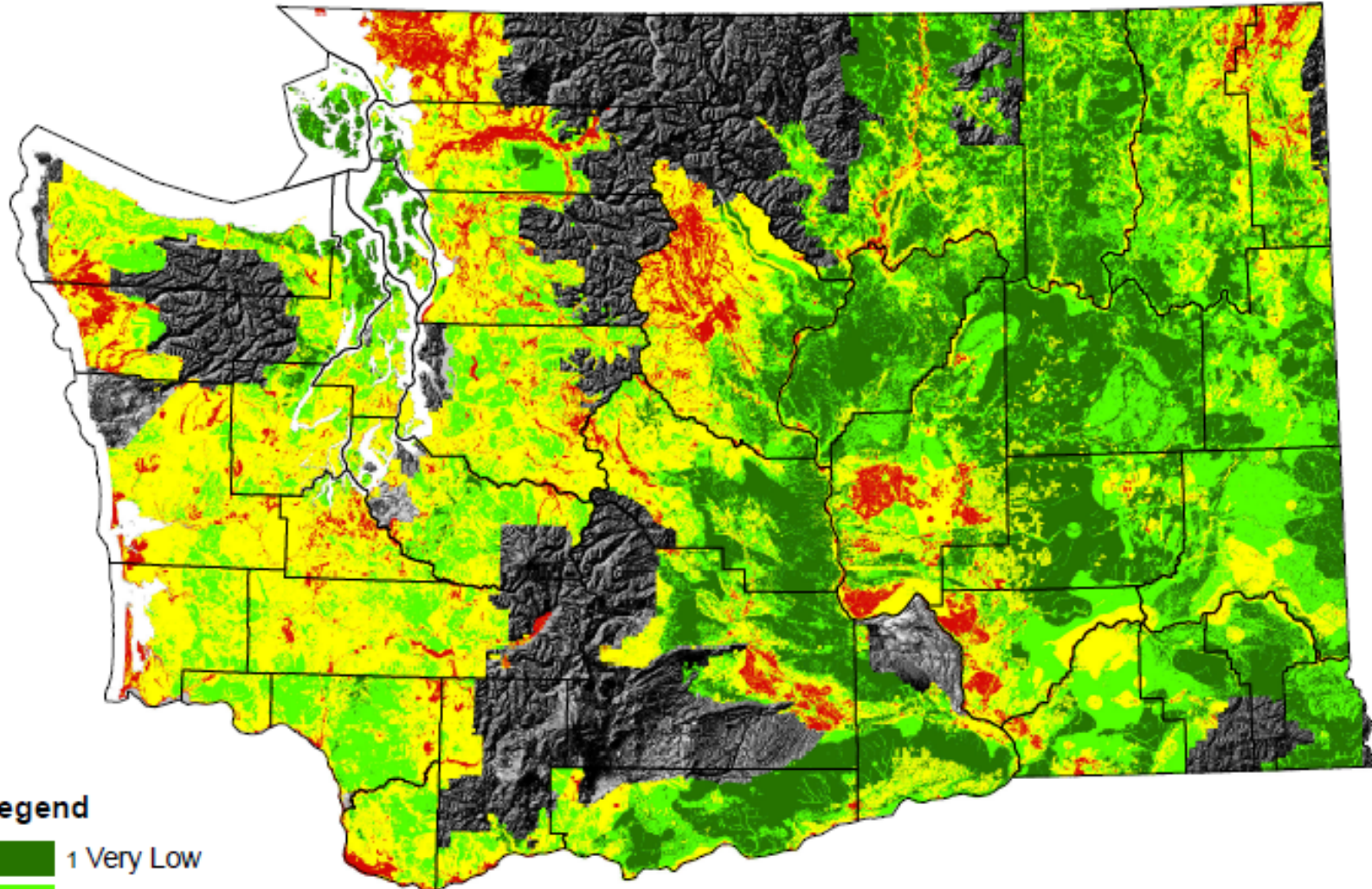

Legend

- 1 Very Low
- 2 Low
- 3 Medium
- 4 High

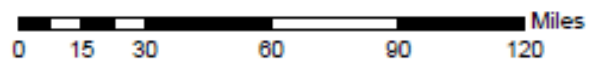
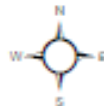

Washington Department of Agriculture
2011 Aquifer Susceptibility Map
Version 2.0

Appendix 3

Designated Sole Source Aquifer Map for EPA Region 10

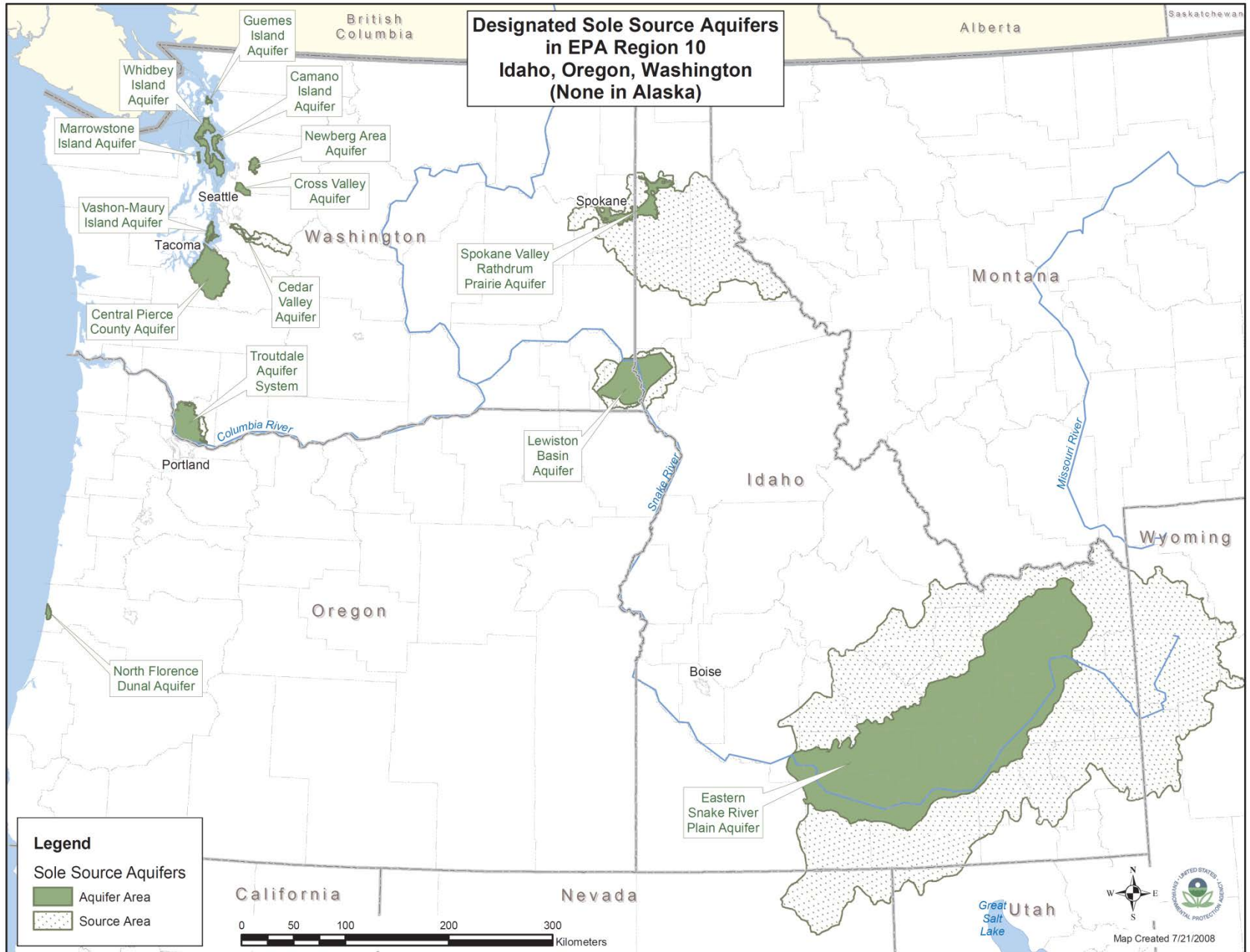

Appendix 4

WSP Volume Estimating Spreadsheet

INSTRUCTIONS

A spreadsheet has been developed to calculate the estimated volume of a square or rectangular WSP.

SPREADSHEET INPUTS

The spreadsheet requires six inputs in order to compute the approximate volume of the WSP.

L1 and L2 are Top of Pond dimensions as shown in feet.

W1 and W2 are Top of Pond dimensions as shown in feet.

h = Depth of WSP measured from crest to pond bottom surface in feet.

SS = Internal side slope of WSP.

h_{out} = Depth of WSP above ground measured from crest to lowest outside toe in feet

SPREADSHEET COMPUTATIONS

The spreadsheet computes the volume utilizing the prismatic formula. All formula variables can be computed from the inputs and the intermediate results are shown in the output window of the spreadsheet.

$$V = h/6 (A_t + 4M + A_b)$$

Where:

V - Volume of the truncated pyramid

h - WSP Depth (Crest to Bottom)

A_t - Top Surface Area, WSP Crest

M - Cross Section Area, Mid-Depth

A_b - Bottom Surface Area, WSP Base

h_{out} - Depth of pond above ground from lowest outside toe to top of crest

V_{ab-gnd} - Volume stored above ground

SS - Internal Sideslope of the WSP

L₁ and *L₂* are Top of Pond dimensions as shown

W₁ and *W₂* are Top of Pond dimensions as shown

SPREADSHEET OUTPUTS

The spreadsheet provides a quick assessment of the estimated WSP volume. Three examples are provided for review.

See Example #1: The user inputs the information that is captured during the SSIF forms. The volume is computed and displayed in the output window. The estimated volume can be used to populate the “WSP Structure Attributes” field for waste storage capacity on SSIF page 7/10.

See Example #2: The user inputs the information that is captured during the SSIF forms. The volume is computed and displayed in the output window. The estimated volume can be used to populate the “WSP Structure Attributes” field for waste storage capacity on SSIF page 7/10.

In addition, a note is displayed when the computed volume is greater than 10 ac-ft. If the above ground storage is greater than 10 ac-ft, the WA State Dam Safety Office has regulatory authority over the facility and the State Dam Safety Standards prevail. NRCS Technical Note 23 does not determine compliance with WA State regulated dams.

See Example #3: The user inputs the information that is captured during the SSIF forms. In this case the volume cannot be computed or displayed in the output window. If the computed length or width of the bottom of the pond is less than zero (0), the results in the intermediate computation field for l or w reports “n.g.”. Either a different method will need to be utilized to compute the volume or the depth may be in error. It is recommended to verify that all of the input fields are correct.

Example 1: Determine the estimated WSP volume

Computation Sheet		U.S. Department of Agriculture Natural Resources Conservation Service		
WA NRCS-ENG-Computation				
State Washington		Project Example #1		
By NRCS	Date 1/4/2013	Checked By	Date	Job No.
Subject Estimated WSP Prismatic Volume				Sheet _____ of _____

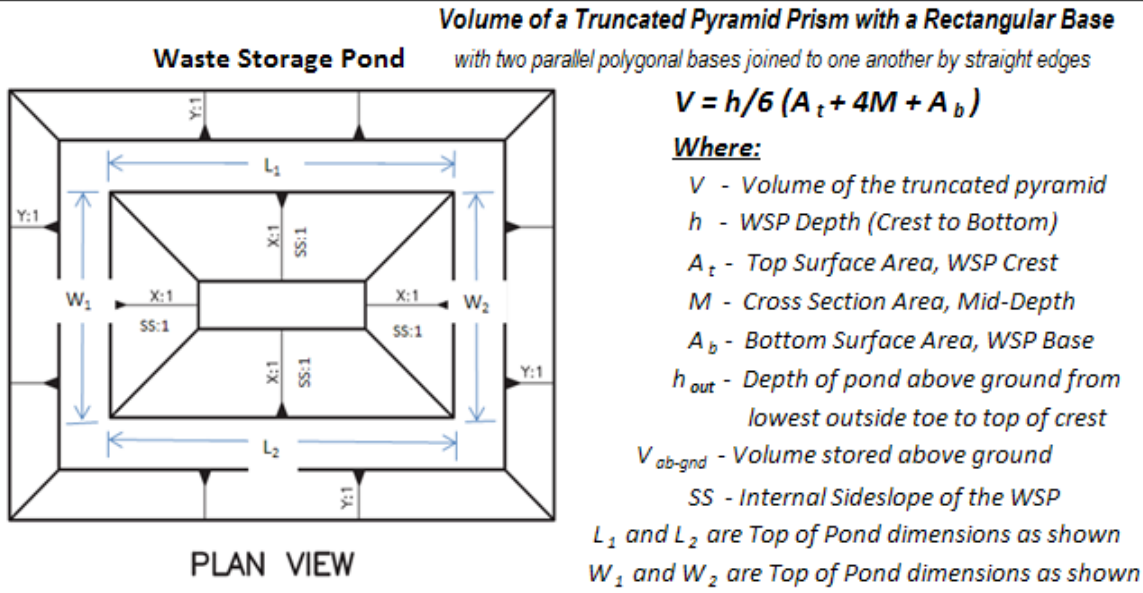

Definitions	Inputs
ft. = Feet	L _{side 1} = 210 ft.
s.f. = Square Feet	L _{side 2} = 185 ft.
c.f. = Cubic Feet	W _{side 1} = 100 ft.
a.f. = Acre-Feet	W _{side 2} = 125 ft.
n.g. = Results are No Good	h = 11 ft.
	SS = 2.5
	h _{out} = 5

Data Input Field

Outputs	
Intermediate Computations	Estimated WSP Volume
A _t = 22,219 s.f.	V = h/6 (A_t + 4M + A_b)
M = 14,450 s.f.	V _{total} = 161,723 c.f.
A _b = 8,194 s.f.	V _{total} = 3.7 a.f.
M _{ab-gnd} = 18,500 s.f.	and
A _{b-ab-gnd} = 15,094 s.f.	V _{ab-gnd} = 92,760 c.f.
	V _{ab-gnd} = 2.1 a.f.

Pond Storage Volume

Above Ground Pond Storage Volume

Example 2: Determine the estimated WSP volume

Computation Sheet		U.S. Department of Agriculture Natural Resources Conservation Service		
WA NRCS-ENG-Computation				
State Washington		Project Example #2		
By NRCS	Date 1/4/2013	Checked By	Date	Job No.
Subject Estimated WSP Prismatic Volume				Sheet _____ of _____

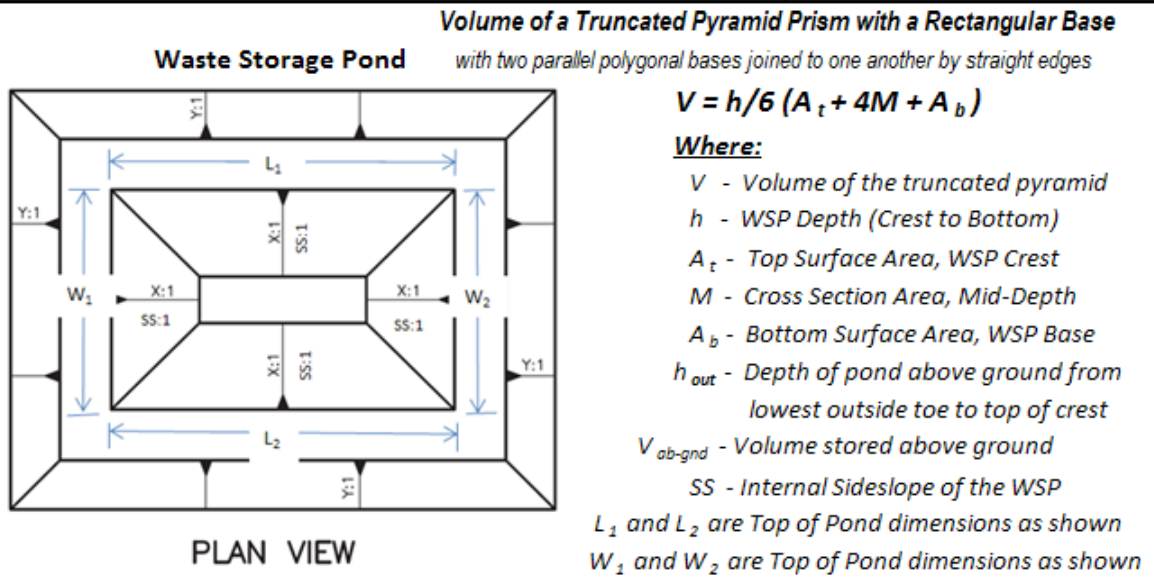

Definitions	Inputs
ft. = Feet	$L_{side\ 1} = 300$ ft.
s.f. = Square Feet	$L_{side\ 2} = 325$ ft.
c.f. = Cubic Feet	$W_{side\ 1} = 250$ ft.
a.f. = Acre-Feet	$W_{side\ 2} = 200$ ft.
n.g. = Results are No Good	$h = 15$ ft.
	$SS = 2.5$
	$h_{out} = 7.5$

Data Input Field

Outputs	
Intermediate Computations	Estimated WSP Volume
$A_t = 70,313$ s.f.	$V = h/6 (A_t + 4M + A_b)$
$M = 51,563$ s.f.	$V_{total} = 780,469$ c.f.
$A_b = 35,625$ s.f.	$V_{total} = 17.9$ a.f.
$M_{ab-gnd} = 60,586$ s.f.	and
$A_{b\ ab-gnd} = 51,563$ s.f.	$V_{ab-gnd} = 455,273$ c.f.
	$V_{ab-gnd} = 10.5$ a.f.
	NOTE: Exceeds 10 Acre-Feet stored above ground

Pond Storage Volume

This notification is displayed when the above ground volume is greater than 10 ac-ft

Example 3: Determine the estimated WSP volume

Computation Sheet		U.S. Department of Agriculture	
WA NRCS-ENG-Computation		Natural Resources Conservation Service	
State Washington		Project Example #3	
By NRCS	Date 1/4/2013	Checked By	Date
Subject Estimated WSP Prismatic Volume		Job No.	
		Sheet _____ of _____	

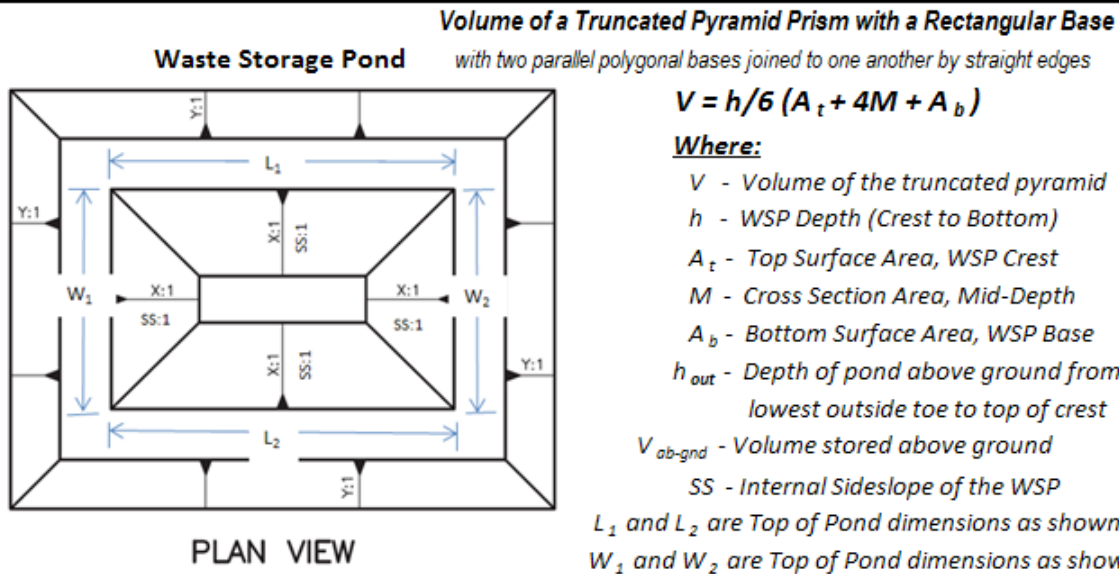

$$V = h/6 (A_t + 4M + A_b)$$

Where:

- V* - Volume of the truncated pyramid
- h* - WSP Depth (Crest to Bottom)
- A_t* - Top Surface Area, WSP Crest
- M* - Cross Section Area, Mid-Depth
- A_b* - Bottom Surface Area, WSP Base
- h_{out}* - Depth of pond above ground from lowest outside toe to top of crest
- V_{ab-gnd}* - Volume stored above ground
- SS* - Internal Sideslope of the WSP
- L₁* and *L₂* are Top of Pond dimensions as shown
- W₁* and *W₂* are Top of Pond dimensions as shown

Definitions	Inputs	Data Input Field
ft. = Feet	<i>L_{side 1}</i> = 100 ft.	
s.f. = Square Feet	<i>L_{side 2}</i> = 90 ft.	
c.f. = Cubic Feet	<i>W_{side 1}</i> = 50 ft.	
a.f. = Acre-Feet	<i>W_{side 2}</i> = 50 ft.	
n.g. = Results are No Good	<i>h</i> = 9 ft.	
	<i>SS</i> = 3	
	<i>h_{out}</i> = 4	

Outputs	
Intermediate Computations	Estimated WSP Volume
<i>A_t</i> = 4,750 s.f.	$V = h/6 (A_t + 4M + A_b)$
<i>M</i> = 1,564 s.f.	<i>V_{total}</i> = n.g. c.f.
<i>A_b</i> = n.g. s.f.	<i>V_{total}</i> = n.g. a.f.
<i>M_{ab-gnd}</i> = 3,154 s.f.	and
<i>A_{b ab-gnd}</i> = 1,846 s.f.	<i>V_{ab-gnd}</i> = 12,808 c.f.
	<i>V_{ab-gnd}</i> = 0.3 a.f.

Output field displays "n.g." when the pond bottom length or width is <0 ft.

APPENDIX E - ID NRCS WATER QUALITY TECHNICAL NOTE #6

TECHNICAL NOTES

USDA-Natural Resources Conservation Service
Boise, Idaho

TN - Water Quality No. 6

July 2006

IDAHO NUTRIENT TRANSPORT RISK ASSESSMENT (INTRA) A Water Quality Risk Assessment Tool for Conservation Planning

The Idaho Nutrient Transport Risk Assessment (INTRA) uses a limited number of landform, site and management characteristics to determine the probability of off-site transport of nutrients (primarily nitrogen and phosphorus). The purpose of the Risk Assessment is to provide planners with a tool to evaluate the various landforms and management practices for potential risk of nutrient movement to surface and ground water. The assessment tool is used during the planning process to determine if surface and/or ground water quality concerns exist. The tool is similar to the risk assessment within ONEPLAN, but is modified to use with conservation management units, not individual fields. The tool was field-tested in both northern and southern Idaho in a number of different landuse-operation scenarios. The tool provides recommendations to assist the planner in selecting appropriate conservation practices that address individual and multiple risk factors to protect or enhance water quality. These mitigating practices are required in order to meet quality criteria for nutrients and organics in surface and ground water if the final risk level is greater than LOW. A brief summary of nutrient movement in agricultural systems, primarily phosphorus and nitrogen, follows. For a more detailed description, refer to *Idaho Water Quality Technical Notes No. 4 and 5*.

Summary of Nutrient Movement in Agricultural Systems

Phosphorus

Phosphorus movement in runoff occurs as particulate P and dissolved P. Particulate P is attached to mineral and organic sediment as it moves with the runoff. Dissolved P is in the water solution. In general, particulate P is the major portion (75-90%) of the P transported in runoff from cultivated land. Dissolved P makes up a larger portion of the total P in runoff from non-cultivated lands such as pastures and fields with reduced tillage.

As runoff moves from the landscape toward surface water, phosphorus may become more bioavailable by the sorption and desorption processes, and by the preferential transport of clay-sized material as sediment moves over the landscape (enrichment). The interaction between the particulate and dissolved P in the runoff is very dynamic and the mechanism of transport is complex. Additionally, dissolved P can move laterally towards surface water bodies as subsurface flow, or downwards, as the soil reaches P saturation. Therefore, it is difficult to predict the transformation and ultimate fate of P as it moves through the landscape (Sharpley et al. 2003).

Nitrogen

Nitrogen is one of the most dynamic and mobile nutrients in the plant-soil-air continuum, with many pathways for loss. There is a large reservoir of N in soil, but most of this is in the organic form. It is estimated that only 2-3% of organic N is mineralized annually. The mineralized form of N (nitrate and ammonium) is readily available for uptake by plants. The N cycle is both spatially and temporally variable within agricultural systems. Variability of soil properties impacts nitrogen movement and loss within agricultural operations, including soil organic matter, residual nitrate, crop residue amount, crop yield variability, and changes in soil chemical and physical properties across the field. The primary loss mechanism of nitrogen in agricultural systems is leaching of nitrate below the root zone. However, losses of nitrogen to the air and by overland flow also occur.

Management plays a critical role in reducing N loss to the environment, and management is the dominant factor influencing long-term nitrate leaching (Shaffer and Delgado 2002). Soil, climate, watershed and aquifer characteristics must also be taken into account in order to minimize nitrate leaching. Loss of nitrate from agricultural systems can range from 0 - 60% of N applied (Meisinger and Delgado 2002). Leaching loss is dependent on the concentration of N in soil solution and the volume of water leached. Over-irrigation can lead to nitrate leaching, especially with shallow rooted crops. Effective management is therefore aimed at reducing transport through proper irrigation water management, and optimizing N application amounts and timing in concert with crop uptake. Crop type and cultivation are also important considerations.

The Idaho Nutrient Transport Risk Assessment: Risk Factors

The main factors influencing nutrient movement in agricultural systems can be separated into transport, source and management factors. Transport factors include the mechanisms by which nutrients move within the landscape. These are rainfall, irrigation, erosion and runoff, and deep percolation. Factors which influence the source and amount of nutrients available for transport include soil nutrient content and form of nutrient applied. Management factors include the method of application, timing and placement in the landscape as influenced by the management of application equipment and tillage.

When the factors of the assessment are analyzed, it will be apparent when an individual factor (or factors) is influencing the assessment disproportionately. These identified factors are the basis for planning corrective soil and water conservation practices and management techniques.

The soil, hydrology, climate and land management site characteristics that have a major influence on nutrient availability, retention, management and movement are listed below. The number in parentheses after each factor is the relative weighting factor.

- Soil test P (available phosphorus in soil laboratory test units relative to the 0-12" soil layer *Phosphorus Threshold* per Idaho Nutrient Management Practice Standard 590) (1.0)
- P fertilizer application rates (in pounds available phosphate per acre) (0.75)
- P fertilizer application methods (0.5)
- Organic P source application rates (in pounds available phosphates per acre) (1.0)

- Organic P source application methods (0.75)
- N fertilizer application rate (1.0)
- N application timing (1.00 if non-irrigated, 0.75 if irrigated)
- N fertilizer application method (0.75)
- Irrigation runoff index (0.5)
- Runoff class (0.5)
- Runoff conservation practices (-1.0)
- Sheet and rill and/or irrigation-induced soil erosion (in tons per acre per year) (1.0)
- Distance to the nearest receiving water body (1.0)
- Irrigation index (for deep percolation) (1.5)
- Leaching index (0.5 irrigated, 1.5 not irrigated)
- Water table depth, geologic features, and hydrologic group (1.00 if irrigated, 1.5 if non-irrigated)

Field-specific data for the site characteristics selected for this version of the Risk Assessment (Table 1) are readily available at the conservation management unit level. Some analytical testing of the soil and organic material is required to determine the rating levels. This soil and organic material analysis is considered essential as a basis for the assessment.

The factors (described below) used in the assessment are rated as VERY LOW, LOW, MEDIUM, HIGH, or VERY HIGH (and some use CRITICAL) by determining the range for each category. The sum of the site characteristic rankings provides an index for surface water quality (Table 2) and an index for ground water quality (Table 3).

Soil P Test

A soil sample (0-12") from the site is necessary to assess the relative level of "plant available P" in the surface layer of the soil. The plant available P is the level customarily given in a soil test analysis by the Cooperative Extension Service or commercial soil test laboratories. The Assessment uses ranges of soil test P. The Olsen (bicarbonate), Bray I, or Morgan (sodium acetate) soil test P methods are required by the NRCS Idaho Nutrient Management Standard depending upon the soil pH. The soil test level for "plant available P" does not ascertain the total P in the surface soil. Rather, it gives an indication of the relative amount of total P that may be present because of the general relationship between the forms of P (organic, adsorbed, and labile P) and the solution P available for plant uptake. If a soil test P result is above the phosphorus threshold as identified in the Idaho Nutrient Management Standard (590), the rating automatically defaults to CRITICAL.

P Fertilizer Application Rate

The P fertilizer application rate is the amount, in pounds per acre (lbs/ac), of commercial phosphate fertilizer (P₂O₅) applied to the soil. This phosphate fertilizer does not include phosphorus from organic sources that are recorded in Organic P Sources Application Rate.

P Fertilizer Application Method

The manner in which P fertilizer is applied to the soil affects potential P movement. Incorporation implies that the fertilizer P is buried below the soil surface. If fertilizer is surface applied on a field with surface runoff (natural or from irrigation) and there is no incorporation, it is considered a significant risk and therefore the rating automatically defaults to CRITICAL.

Organic P Source Application Rate

The organic P application rate is the amount, in pounds per acre (lbs/ac), of potential phosphate (P_2O_5) contained in the manure and applied to the soil. This organic phosphate source does not include phosphorus from fertilizer sources that are recorded in P Fertilizer Application Rate.

Organic P Source Application Method

The manner in which organic P material is applied to the soil can determine potential P movement. Incorporation implies that the organic P material is buried below the soil surface. If manure is surface applied on a field with surface runoff (natural or from irrigation) and there is no incorporation, it is considered to be a discharge and a violation of existing regulations.

Because of this, the rating automatically defaults to CRITICAL.

Runoff Class and Irrigation Runoff Index

Runoff Class: The runoff class of the site is used to determine the risk of runoff from storm events. One method to determine the runoff class is based on the soil permeability and the percent slope of the site (USDA-NRCS Soil Survey Manual, Agricultural Handbook 18, 1993). The matrix relating soil permeability class and slope (Table 4) provides the appropriate value category. This information is available in the SSURGO soils database (physical properties report).

Runoff Index: The irrigation runoff index of the site is used for irrigated lands. For sprinkler irrigated lands, the runoff index is simply based on a user supplied assessment of whether or not runoff (overland flow) exists and, if so, whether or not it leaves the field. For surface irrigated lands, the runoff index is based on the typical percent of the irrigation set time that runoff from the furrow/field occurs; the user enters whether it is more or less than 50%.

Runoff Conservation Practices

Runoff conservation practices include any conservation practices which serve to reduce runoff and the movement of soil, thereby reducing potential for dissolved and particulate phosphorus movement across the landscape toward a receiving water body. Credit (negative point value) is applied depending on the number of conservation practices implemented, so multiple practices receive greater credit than a single practice. Also, runoff conservation practices that filter or trap nutrients (such as buffers, borders, filter strips, and grassed waterways) receive greater credit than those that simply reduce runoff. Certain practices (e.g., tail-water recovery systems with sediment basins) eliminate runoff and sediment loss from the field.

Soil Erosion (Total Water-Induced Soil Erosion)

Soil erosion is defined as the loss of soil along the slope or unsheltered distance caused by the processes of water and wind. Soil erosion is estimated from erosion prediction models including the Revised Universal Soil Loss Equation (RUSLE/RUSLE2) for water erosion from non-irrigated lands (and sprinkler irrigated lands if runoff exists) and the Surface Irrigation Soil Loss equation (SISL) for water erosion from surface irrigated lands. The Wind Erosion Equation (WEQ) is not used in this assessment. The value category is given in tons of soil loss per acre per year (ton/ac/yr). These soil loss prediction models do not predict sediment delivery rates from the end of a field to a water body. The prediction models are used in this assessment to

indicate the potential for sediment and attached nutrient movement across the slope or unsheltered distance toward surface waters.

Distance to Nearest Receiving Water Body

The distance to the nearest receiving water body is the distance in feet between the edge of the field and the nearest receiving water. This is typically a ditch, canal, waterway, drain, etc. – *any water body or water way which has connection (perennial or ephemeral) with a stream, river, pond or lake*. The closer the distance, the greater the likelihood nutrients lost from the field will reach the receiving water body.

Leaching Index

Deep percolation is dependent on numerous factors, including climate and soil type. The leaching index is based on the Nitrogen Leaching Index (Czymmek et al. 2003, Williams and Kissel 1991) which is essentially a water percolation index based on soil water storage. Slight modifications were made to some of the percolation index equations to adjust for low precipitation zones found in areas of Idaho. Total annual precipitation for specific locations is determined from local climate station data, as is winter precipitation. The percolation index is based on precipitation and hydrologic soil group. A seasonal index is calculated as the ratio of winter precipitation to annual precipitation. The leaching index is then calculated as the product of the percolation index and seasonal index. For irrigated lands, the leaching index is low if the irrigation index is low. If not, then the leaching index is based on amount of winter precipitation.

Irrigation Index

Managing irrigation water will minimize nutrient losses from leaching and surface runoff. Potential system application efficiency and irrigation water management have significant impacts on actual water movement through the root zone. Five different factors are used in the irrigation index to determine the potential for irrigation water to transport nutrients to ground water. The irrigation system is the primary rating factor, and the other variables modify that rating based on the level of management for each. These additional factors are water control and measurement, irrigation scheduling and soil moisture monitoring, use of pre- and/or post-season irrigation, and soil condition index (SCI).

N Application Index

Crop nitrogen requirement is determined based on crop yield and University of Idaho fertilizer recommendations. The nitrogen application rate is the percent nitrogen applied compared to the total crop nitrogen requirement according to the fertilizer guides prior to any credits or debits for previous crop and residual nitrogen.

N Application Timing

Timing of N application directly influences potential transport due to the high mobility of nitrate in soils. The appropriate timing of N application is complicated by the soil processes of nitrification, volatilization, and mobilization, which affect N plant availability. Split applications of N throughout the growing season better match crop growth requirements, reducing the likelihood of loss. Fall application in most instances has the greatest potential for loss prior to the planting season; additional N applications are often required to meet crop demand when losses occur.

Water Table Depth/Soil Type

Soils can stop or slow nutrient movement depending on their chemical and physical characteristics. Depth of soils, depth to water tables and limiting layers such as hard pans will influence rooting depth, nitrogen movement, and leaching potential. Fine textured soils (Hydrologic Group D) have a lower potential for leaching due to reduced permeability and high water holding capacity, while coarse textured soils (Hydrologic Group A) have a higher likelihood of nitrate leaching due to low water holding capacity and the rapid infiltration and movement of water through the profile.

If a water table is present within five feet of the surface, the potential for ground water contamination is high regardless of the soil type.

Using the Idaho Nutrient Transport Risk Assessment

The Assessment applies on Cropland, Hayland, and Pasture where nutrients are applied. Use of the Risk Assessment for planning should begin during the initial field visit and interview with the producer. However, some of the information needed for the factors will be obtained from other planning tools (for instance, SISL or RUSLE2, soils database, etc.). **A field data sheet is provided in the spreadsheet, but required calculations and look-up information is performed by the spreadsheet, so entering information from the field data sheet into the spreadsheet (or taking the computer to the field) is required.** Steps for using the assessment tool are:

- 1) An assessment is developed for each land use, conservation management unit, or cropping system.

Example: An operation includes 3 cropping systems or conservation management units:

1. Hay in rotation with row crops and cereals, where commercial fertilizer is applied.
2. Hay in rotation with row crops and cereals where animal waste is applied in addition to commercial fertilizer.
3. Pasture where commercial fertilizer is applied.

An assessment is required for each system/management unit.

- 2) Identify the critical crop in each system. The critical crop is the crop in which the highest potential for off-site transport of nutrients exists. For example, a rotation being evaluated includes winter wheat, spring barley and summer fallow. All the nitrogen for winter wheat is applied in the fall prior to planting the crop. The critical crop is winter wheat. The assessment is made using information which relates to the winter wheat crop.
- 3) The planner must obtain the following information from the producer.
 1. Typical rotation.
 2. For the critical crop:

- a) Soil test data using the appropriate analysis method (Olson, Bray or Sodium Acetate). Note: If no soil test has been done in the last 5 years, the input value is automatically a VERY HIGH.
 - b) Phosphorus fertilizer application rate (lbs/ac/yr).
 - c) Phosphorus fertilizer application method.
 - d) Organic phosphorus application rate (lbs/ac/yr). Note: If the producer can not provide this information, the input value is automatically a VERY HIGH.
 - e) Organic phosphorus fertilizer application method.
 - f) Nitrogen application rate (% of Crop Requirement) requires 2 factors. The actual lbs/ac/yr of Nitrogen applied and the target yield. The program uses these 2 values to generate the rating.
 - g) Nitrogen fertilizer application method.
 - h) Runoff Index (Surface Irrigated). This value is qualitative. The planner determines the input by asking the producer whether water runs off less than or more than 50% of the set time.
 - i) Runoff Index (Sprinkler Irrigated). This value is qualitative. The planner determines the input with on site observation and/or asking the producer. Does water move across the field surface during irrigation? Does water leave the field via overland flow?
- 4) Other Information: Factors like hydrologic soil group, average field slope, permeability, soil erosion, and distance to surface waters are required and should be representative of the cropping scenario/conservation management unit being evaluated.

Requirements for Meeting Quality Criteria

- Quality Criteria is met when an overall rating of LOW is obtained. No mitigating practices are required.
- Quality Criteria is not met when an overall rating of MEDIUM or greater is obtained. Mitigating practices are required. If all possible mitigating practices have already been implemented, then Quality Criteria are considered met. This must be documented in the plan.

Identification of Mitigating Practices

The rating for each site characteristic (factor) is displayed on the Assessment Report. If any site characteristic has a MEDIUM or higher rating, then mitigating practices are required. Mitigating practices are not required for any site characteristic which has a rating of LOW, however “Recommended” practices might be suggested. “Recommended” and “Required” practices are identified on the report in the column titled “Mitigating Practices”.

References

Czymmek, KJ, QM Ketterings, HM van Es, and SD DeGloria. 2003. The New York Nitrate Leaching Index. Cornell University, Department of Crop and Soil Sciences, Extension Publication E03-2.

Meisinger, JJ, and JA Delgado. 2002. Principles of managing nitrogen leaching. *J. Soil and Water Conservation* 57: 485 - 498.

Shaffer, MJ, and JA Delgado. 2002. Essentials of a national nitrate leaching index assessment tool. *J. Soil and Water Conservation* 57: 327 – 335.

Sharpley, AN, T Daniel, T Sims, J Lemunyon, R Stevens, and R Parry. 2003. Agricultural phosphorus and eutrophication (second edition). USDA-Agricultural Research Service, ARS-149.

USDA-NRCS Conservation Practice Standard, Nutrient Management, Idaho 590.

USDA-NRCS, Engineering Technical Note, Series 1901. A Phosphorus Assessment Tool, August 1994.

USDA-NRCS Soil Survey Manual, Agricultural Handbook 18, 1993.

Williams, JR, and DE Kissel. 1991. Water percolation: an indicator of nitrogen-leaching potential. pp 59-83 *IN*: RF Follet, DR Keeney, and RM Cruse (eds). Managing nitrogen for groundwater quality and farm profitability. Soil Science Society of America, Inc. Madison, WI

Table 1. Idaho Nutrient Transport Risk Assessment for Planning (Field Sheet). The weighting for each factor is incorporated into the point value.

Surface Water Quality							
Site Characteristic	Rating and Point Value						SELECTED RATING
	Very Low 0	Low 1	Medium 2	High 4	Very High 8	Critical 10	
Soil Test P (ppm) Olsen Method 0 – 12"	< 8	8 - 15	16 - 25	26 - 35	36 – 40 (or no soil test)	> 40	
Soil Test P (ppm) Bray Method 0 – 12"	< 10	10 - 20	21 - 40	41 - 50	51- 60 (or no soil test)	> 60	
Soil Test P (ppm) Morgan Method (NaOAc) 0 – 12"	< 1.0	1.0 – 2.0	2.1 – 4.0	4.1 – 5.0	5.1- 6.0 (or no soil test)	> 6.0	
Site Characteristic	Rating and Point Value						SELECTED RATING
	Very Low 0	Low 0.75	Medium 1.5	High 3	Very High 6	Critical	
Phosphorus Fertilizer Application Rate (lbs/ac P ₂ O ₅)	0	< 60	60 - 150	151- 300	> 300		
Site Characteristic	Rating and Point Value						SELECTED RATING
	Very Low 0	Low 0.5	Medium 1.0	High 2	Very High 4	Critical 10	
Phosphorus Fertilizer Application Method	None applied	Placed with planter (banded) or injected > 2" or plowed	Incorporated > 3" by disking or chiseling, etc.	Chemigated, or incorporated < 3" by harrowing, etc.	Surface applied, no incorporation	Surface applied on a field with surface runoff (natural or from irrigation) and no incorporation	
Site Characteristic	Rating and Point Value						SELECTED RATING
	Very Low 0	Low 1	Medium 2	High 4	Very High 8	Critical	
Organic Phosphorus Application Rate (lbs/ac P ₂ O ₅)	0	< 40	40 - 100	101 – 200	> 200 (or unknown)		

Site Characteristic	Rating and Point Value						SELECTED RATING
	Very Low 0	Low 0.75	Medium 1.5	High 3	Very High 6	Critical 10	
Organic Phosphorus Application Method	None applied	Placed with planter (banded) or injected > 2" or plowed	Incorporated > 3" by disking or chiseling, etc.	Chemigated, or incorporated < 3" by harrowing, etc.	Surface applied, no incorporation	Surface applied on a field with surface runoff (natural or from irrigation) and no incorporation	
Site Characteristic	Rating and Point Value						SELECTED RATING
	Very Low 0	Low 1	Medium 2	High 4	Very High 8	Critical	
Nitrogen Application Rate (% of Crop Requirement)	< 40	40 - 60	60 - 100	100 - 120	> 120		
Site Characteristic	Rating and Point Value						SELECTED RATING
	Very Low 0	Low 0.75	Medium 1.5	High 3	Very High 6	Critical 10	
Nitrogen Fertilizer Application Method (prior to critical runoff period)	None applied	Placed with planter (banded) or injected > 2" or plowed	Incorporated > 3" by disking or chiseling, etc.	Chemigated, or incorporated < 3" by harrowing, etc.	Surface applied, no incorporation	Surface applied on a field with surface runoff (natural or from irrigation) and no incorporation	
Site Characteristic	Rating and Point Value						SELECTED RATING
	Very Low 0	Low 0.5	Medium 1.0	High 2	Very High 4	Critical	
Runoff Index (Surface Irrigated)	No runoff occurs	-----	Water runs off the field less than 50% of the set time	-----	Water runs off the field 50% or more of the set time		
Runoff (Sprinkler Irrigated)	No runoff occurs	Water moves across the surface but not off the field	-----	Runoff leaves the field	----		
Runoff Class	Negligible	Very low or low	Medium	High	Very High		

Site Characteristic	Rating and Point Value						SELECTED RATING
	Very Low 0	Low -1	Medium -2	High -4	Very High -8	Critical	
Runoff BMPs (Only applies if runoff occurs)	No conservation practices	One or two on-field conservation practices that reduces runoff	Multiple conservation practices that reduce runoff <u>or</u> trap nutrients	Multiple conservation practices that reduce runoff <u>and</u> trap/filter pollutants	Conservation practice(s) that eliminates runoff		
Site Characteristic	Rating and Point Value						SELECTED RATING
	Very Low 0	Low 1	Medium 2	High 4	Very High 8	Critical	
Average Total Soil Erosion due to Water (tons/ac/year)	< 1 ton/acre	1 - 5 tons/acre	5 - 10 tons/acre	10 - 15 tons/acre	> 15 tons/acre		
Site Characteristic	Rating and Point Value						SELECTED RATING
	Very Low 0	Low 1	Medium 2	High 4	Very High 8	Critical	
Distance to Surface Water	> 2640 feet (> 0.5 mile)	2640 - 1320 feet	1319 - 600 feet	599 - 200 feet	< 200 feet		
TOTAL POINTS FOR SURFACE WATER QUALITY (Less than 12 is a LOW rating)							

Ground Water Quality							
Site Characteristic	Rating and Point Value						SELECTED RATING
	Very Low 0	Low 1	Medium 2	High 4	Very High 8	Critical	
Nitrogen Application Rate (% of Crop Requirement)	< 40	40 - 60	60 - 100	100 - 120	> 120		
Site Characteristic	Rating and Point Value						SELECTED RATING
Irrigated> Not Irrigated>	Very Low 0	Low 0.75 1	Medium 1.5 2	High 3 4	Very High 6 8	Critical	
Nitrogen Application Timing	None applied	Nitrogen applied in several applications during the primary growing season, the first application no greater than 30 days of start of primary growing season	Majority of nitrogen is applied within 30 days of, or during, the primary growing season. Nitrogen applied outside this time frame is less than 50 lbs and is applied with a nitrification inhibitor or when soil temperatures are less than 50 deg. F.	Nitrogen is applied as a single application within 90 days of the primary growing season OR a split application is made which does not meet the conditions described for LOW or MEDIUM.	Nitrogen is applied as a single application more than 90 days prior to the primary growing season.		

Site Characteristic	Rating and Point Value						SELECTED RATING
	Very Low 0	Low 1.5	Medium 3	High 6	Very High 12	Critical	
Irrigation Index	> 79	70 - 79	60 - 69	50-59	< 50		
This index requires information on the irrigation system type, water measurement and distribution, irrigation scheduling, SCI, and whether pre or post season irrigation is used. Circle the most appropriate selection in each category.							
<u>Irrigation System</u>		<u>Irrigation Scheduling</u>			<u>Water Control and Measurement</u>		
Surface - Graded Border		Use a set irrigation schedule each year					
Surface - Level Border (Basin)		Irrigation based on visual observation of crop stress			Poor - no water measurement AND poor control of water due to inadequate water control structures throughout the conveyance system		
Surface - Graded Furrow or Corrugates		Soil moisture by NRCS feel method					
Surface - Surge		Check book scheduling, irrigation scheduler, etc.					
Surface - Controlled with contour ditch, turnouts, canvas dams, etc.		Irrigation scheduling via pan evaporation of atmometer in field			Fair - manually recorded water measurement at delivery point to farm AND poor control of water due to inadequate control structures throughout the conveyance system		
Surface - Uncontrolled (wild flood, no control with turnouts, etc.)		Irrigation scheduling via regional weather network (e.g. AgriMet)					
Sprinkler - Big gun or boom		Soil moisture monitoring using Gypsum blocks, moisture probes, etc.			Average - manual recordings somewhere in the system OR good control of water with effective water control structures throughout the conveyance system		
Sprinkler - Periodic Move (hand line or wheel line)		Continuous measurement of soil moisture, water applied, and ET					
Sprinkler - Solid set							
Sprinkler - Center pivot		<u>Pre/Post Irrigation</u>					
Sprinkler - Lateral/linear move		Pre- and post-season irrigations based on standard run time			Good - manual recordings somewhere in the system AND good control of water with effective water control structures throughout the conveyance system		
Micro Irrigation - Sprays and Bubblers		Pre-season OR post-season irrigations based on standard run time					
Micro Irrigation - Tubing or tape w/ integrated or punched-in emitters		Pre- and post-season irrigations based on soil moisture assessment			Excellent - Continuous recording water measurement device(s) AND good control of water with effective water control structures throughout the conveyance system		
		Pre- OR post-season irrigations based on soil moisture assessment					
		No irrigation outside crop growing season					

Leaching Index (Irrigated) (applies only if Irrigation Index > LOW)	< 9	9 - 12	13 - 16	17 - 20	> 20		
Leaching Index (Not Irrigated)	0	0 - 2	2 - 5	5 - 10	>10		
Site Characteristic	Rating and Point Value						SELECTED RATING
	Very Low 0	Low 1	Medium 2	High 4	Very High 8	Critical	
Water Table/Geologic Feature Depth and Soil Type	Water table or geologic feature > 5 feet from surface, Hydrologic Group D	Water table or geologic feature > 5 feet from surface, Hydrologic Group C	Water table or geologic feature > 5 feet from surface, Hydrologic Groups A, B	Water table or geologic feature < 5 feet to surface, Hydrologic Groups C, D	Water table or geologic feature < 5 feet to surface, Hydrologic Groups A, B		
TOTAL POINTS FOR GROUND WATER QUALITY (Less than 9 is a LOW rating)							

Table 2. Surface Water Quality Nutrient Transport Risk Assessment Index rating and site vulnerability.

Surface Water Risk Assessment Rating	Total	Site Vulnerability Chart
LOW	< 12	Low potential for nutrient loss if current farming practices are maintained.
MEDIUM	12 - 20	Medium potential for nutrient loss. Some remediation measures should be undertaken to minimize the probability of nutrient loss.
HIGH	21 - 40	High potential for nutrient loss and adverse effects on surface and/or ground waters. Soil and water conservation measures and phosphorus management plans are needed to reduce the probability of nutrient loss.
VERY HIGH	> 40	Very high potential for nutrient loss and adverse effects on surface and/or ground waters. All necessary soil and water conservation measures and a nutrient management plan must be implemented to minimize nutrient loss.

Table 3. Ground Water Quality Nutrient Transport Risk Assessment Index rating and site vulnerability.

Ground Water Risk Assessment Index Rating	Total	Site Vulnerability Chart
LOW	< 9	Low potential for nutrient loss if current farming practices are maintained.
MEDIUM	9 - 16	Medium potential for nutrient loss. Some remediation measures should be undertaken to minimize the probability of loss.
HIGH	16 - 25	High potential for nutrient loss and adverse effects on ground water. Soil and water conservation measures and nutrient management plans are needed to reduce the probability of loss.
VERY HIGH	>25	Very high potential for nutrient loss and adverse effects on ground water. All necessary soil and water conservation measures and a nutrient management plan must be implemented to minimize loss.

Table 4. The surface RUNOFF CLASS site characteristic determined from the relationship of the soil permeability class and field slope. Adapted from NRCS Soil Survey Manual (1993) Table 3-10.

Slope (%)	Soil Permeability Class ¹ (in/hr)				
	Very Rapid (>20.00 in/hr)	Moderately Rapid and Rapid (2.00 – 20.00)	Moderately Slow and Moderate (0.20 – 2.00)	Slow (0.06 - 0.20)	Very Slow (< 0.06 in/hr)
	Runoff Class ³				
Concave ²	N	N	N	N	N
< 1	N	N	N	L	M
1 - 5	N	VL	L	M	H
5 - 10	VL	L	M	H	VH
10 - 20	VL	L	M	H	VH
> 20	L	M	H	VH	VH

¹ Permeability class of the least permeable layer within the upper 39 inches (one meter) of the soil profile.

Permeability classes for specific soils can be obtained from a published soil survey or from local USDA-NRCS field offices (soils database).

² Area from which no or very little water escapes by overland flow.

³ RUNOFF CLASS: N = negligible, VL = very low, L = low, M = medium, H = high, VH = very high.

ATTACHMENT 1: Example for Conservation Planning

Benchmark condition is sprinkler irrigated potato-sugarbeet-winter wheat in southeast Idaho with manure application.

Site Characteristic and Ranking	Factor Weighting X Rating Value
Soil P test is 35 ppm using an Olsen Test =HIGH	1.0 x 4 = 4.0
P fertilizer application rate is 50 lbs/ac P ₂ O ₅ =LOW	0.75 x 1 = 0.75
P fertilizer application method is placed with planter =LOW	0.5 x 1 = 0.5
Organic P source application rate is 210 lbs/ac =VERY HIGH	1.0 x 8 = 8.0
Organic P source application method is incorporated less than 3 inches by harrowing, etc. =HIGH	0.75 x 4 = 3.0
N fertilizer application rate is 80% of crop requirement prior to debits/credits =MEDIUM	1.0 x 2 = 2.0
N fertilizer application method is broadcast and incorporated greater than 3" =LOW	0.75 x 1 = 0.75
N fertilizer application timing is single application in spring, > 30 days prior to growing season =HIGH	0.75 x 4 = 3
Irrigation Runoff Index for sprinkler irrigated, no runoff occurs but overland flow within field does occur. = LOW	0.5 x 1 = .5
Runoff class from Table 3 is Medium =MEDIUM	0.5 x 2 = 1.0
No runoff conservation practices in place =VERY LOW	1.0 x 0 = 0

Soil erosion is 7.5 tons/ac/yr = MEDIUM	1.0 x 2 = 2.0
Distance to nearest receiving water body is 300 feet =HIGH	1.0 x 4 = 4.0
Irrigation Index calculated at 68 for center pivot with visual observation of crop stress, pre-season irrigation and average control of water =MEDIUM	1.5 x 2 = 3
Leaching Index for Pocatello =LOW	0.75 x 1 = 0.75
Water table/soils for Hydrologic Group C with no water table or geologic feature within 5 feet =LOW	1.0 x 1 = 1.0
Total Points for Surface Water Quality	26.5
Total Points for Ground Water Quality	9.75

Ranking for Surface Water - the site has a **HIGH** potential for nutrient loss and adverse effects on surface waters.

Ranking for Ground Water – the site has a **MEDIUM** potential for nutrient loss and impact to ground water.

Using the individual site characteristics, identify some factors of concern and management options that could be used to reduce this site vulnerability (mitigation):

Soil P Test – The soil P test was **HIGH**. Remember that the soil test level for "available P" does not ascertain the total P in the surface soil. It does, however, give an indication of the amount of total P that may be present because of the general relationship between the forms of P and the solution P available for crop uptake. Research has conclusively shown that the higher the soil test P level of a site, the proportionately higher the potential P loss will be from that site. Therefore the long-term goal should be to conduct a comprehensive soil testing program on the entire farm and implement nutrient management on individual fields using ONEPLAN. Estimates should be made to determine the time required to deplete the soil P to optimum levels.

Organic P Source Application Rate – The organic P source application rate was > 200 lbs/ac, falling in the **VERY HIGH** category. This particular site characteristic is especially important. Here we have a management unit with a soil test P level that is already high and very high rates of organic P are being applied. Considering the long-term management options discussed under

Soil P Test, the organic P application rate should either be reduced to crop P uptake or less, or no organic P should be applied until the soil P is depleted back to an optimal level. The ONEPLAN nutrient management program can help identify fields with lower soil P test and lower risk assessment values where the organic material could be applied.

Organic P Source Application Method – The organic P source application method was incorporated less than 3 inches with a harrow, etc. putting it in the HIGH category. Remember that the manner in which organic P material is applied to the soil can determine potential P movement. Since the organic P was only minimally incorporated, the organic P would still have a substantial surface exposure. Mechanical incorporation reduces the amount of nutrients in the thin mixing zone at the soil surface and/or on crop residue or foliage, thus reducing the interaction with and transfer of nutrients to runoff water. With incorporation, other environmental losses may also be reduced, and nutrient management may be improved. However, mechanical incorporation with tillage may reduce soil-protecting crop residue and increase erosion. Incorporated material may be subject to downward movement. Leaching losses may be increased, and the relative importance of the different loss pathways needs to be considered. The organic P material should be injected or plowed greater than 2 inches if possible, and applied immediately before the crop is planted.

Runoff Conservation Practices – No runoff practices are currently in place, so level of use is VERY LOW. Implementing irrigation water management and use of surface roughening (dam-dike) and buffers would help reduce runoff and sediment loss. (see Soil Erosion).

Soil Erosion – The soil erosion rate was 7.5 tons/ac/yr (MEDIUM category). Prediction models are used in the assessment to indicate a movement of soil, thus potential for sediment and attached phosphorus movement across the slope or unsheltered distance and to a water body. Conservation measures such as residue management or reduced tillage should be considered as a way to reduce erosion. In addition, other conservation measures like field borders or buffers should be considered as a means to mitigate off-site transport and improve the quality of runoff leaving the field.

Irrigation Index – Despite the use of a center pivot system, the irrigation index rated MEDIUM because of pre-season irrigation practices and a low level of irrigation scheduling. Following appropriate irrigation water management techniques could significantly improve efficient use of water and reduce the potential for leaching losses.

Nitrogen Application Timing – Applying nitrogen as a single application more than 30 days prior to the start of the growing season increases the risk of loss during spring. Apply the nitrogen closer to the growing season and consider splitting applications for better crop use efficiency.

APPENDIX F - UNIVERSITY OF IDAHO CIS 1139

Manure and Wastewater Sampling

by Ron E. Sheffield and Richard J. Norell

Nutrient concentrations vary within most types of manure. A review of samples from 42 dairies in Idaho (Table 1) showed that nitrogen (N) and phosphorus (P) in wastewater lagoons vary greatly between farms. For example, on small open lot dairies (< 1,000 head), P can range from 16 to 28 pounds/per acre-inch while on large open lot dairies (> 1,000 head), the range is 12 to 20 pounds per acre-inch.

Phosphorus concentrations on freestall flush dairies ranged from 23 to 31 pounds per acre-inch, while scraped freestall dairies ranged from 17 to 39 pounds per acre-inch. This is a broad range of nutrient levels with the maximum and minimum values differing by more than a factor of two.

These numbers should send a clear message: Average nutrient estimates may be suitable for the purposes of developing a manure utilization plan, but these averages are not adequate for calculating proper application rates.

Do not base your application rates on laboratory test results from previous years because nutrient concentrations can change significantly, particularly when the manure has been exposed to the environment. For example, nutrient levels in a lagoon or storage pond can be greatly diluted by more rainfall than normal or concentrated due to excessive summertime evaporation.

Manure should be tested as close to the date of application as practical. Preferably, the sample should be taken as near the application time as possible prior to the manure application, or within 30 days of application. However, if you urgently need to pump down a full lagoon or storage pond, you should not wait until you can sample and obtain the results. Instead, you should sample the day of irrigation. The results can later be used to determine the nutrients applied to the fields and identify the need for additional nutrients to complete crop production.

Producers who do not test each manure source before or just after land application are faced with a number of ques-

tions they simply may not be able to answer:

- Am I supplying plants with adequate nutrients?
- Am I building up excess nutrients that may ultimately move to surface waters or groundwater?
- Am I applying heavy metals at levels that may be toxic to plants and permanently alter soil productivity?

Because environmental damage and losses in plant yield and quality often happen before visible plant symptoms, always have your manure analyzed by a competent lab. Certified labs in Idaho can analyze manure samples and may be able to make agronomic recommendations regarding the use of the manure as a fertilizer.

Manure sampling

Proper sampling is the key to reliable manure analysis. Although lab procedures are accurate, they have little value if the sample fails to represent the manure product.

Manure samples submitted to a lab should represent the average composition of the material that will be applied to the field. Reliable samples typically consist of material collected from a number of locations. Precise sampling methods vary according to the type of manure. The lab, county extension agent, or crop consultant should have specific instructions on sampling, including proper containers to use and maximum holding or shipping times. General sampling recommendations follow.

Preparing liquid manure for lab analysis. Liquid manure samples submitted for analysis should meet the following requirements:

- Place sample in a sealed, clean plastic container with about a 1-pint volume. Glass is not suitable because it is breakable and may contain contaminants.

Table 1. Average lagoon wastewater concentrations from various types of Idaho dairies.

Farm Type ¹	Ammonia (NH ₃) lb/ac-in	Total Kjeldahl Nitrogen (TKN) lb/ac-in	Total Phosphorus (TP) lb/ac-in	Total Solids (TS) mg/l	Biochemical Oxygen Demand (BOD) mg/l
OL < 1,000 hd	40 +/- 2	119 +/- 29	22 +/- 6	29,291 +/- 12,098	21,067 +/- 20,240
OL > 1,000 hd	61 +/- 22	92 +/- 36	16 +/- 4	5,087 +/- 1,386	1,068 +/- 192
FS Scrape	175 +/- 75	181 +/- 75	28 +/- 11	24,122 +/- 13,826	2,135 +/- 968
FS Flush	149 +/- 23	162 +/- 24	27 +/- 4	10,770 +/- 2,138	1,912 +/- 481

¹ Farm Type: OL = Open Lot Dairy; FS = Freestall Dairy; hd = head.

² Average values +/- standard error.

- Leave at least 1 inch of air space in the plastic container to allow for expansion caused by the release of gas from the manure material.
- Refrigerate or freeze samples that cannot be shipped on the day they are collected, minimizing chemical reactions and pressure buildup from gases.

Ideally, liquid manure should be sampled after it is thoroughly mixed. Because this is sometimes impractical, samples can also be taken in accordance with the suggestions that follow.

Lagoon liquid. Premixing the surface liquid in the lagoon is not needed, provided it is the only component that is being pumped. Growers with multistage systems should draw samples from the lagoon they intend to pump for crop irrigation.

Samples should be collected using a clean, plastic container similar to the one shown in **Figure 1**. One pint of material should be taken from at least eight sites around the lagoon and then mixed in the larger clean, plastic container. Effluent should be collected at least 6 feet from the lagoon's edge at a depth of about a foot. Shallower samples from anaerobic lagoons may be less representative than deep samples because oxygen transfer near the surface sometimes alters the chemistry of the solution. Floating debris and scum should be avoided. One pint of mixed material should be sent to the lab. Galvanized containers should never be used for collection, mixing, or storage due to the risk of contamination from metals like zinc in the container.

A University of Idaho study compared nutrient composition from two sampling locations: direct from storage and during land application. Nitrogen concentration averaged 15 pounds per acre-inch higher in storage samples than from land application samples. Conversely, phosphorus and potassium concentrations were similar between storage and land application samples. Nitrogen application rates may be overestimated if based on nutrient analysis from storage samples.

These recommendations are adequate for average irrigation volumes. If an entire storage structure is to be emptied by such means as furrow irrigation, more frequent sampling with many more sampling points is recommended.

Liquid slurry. Manure materials applied as a slurry (approximately 5 to 12 percent solids) from a pit, storage pond, or vacuumed from a feed alley should be mixed prior to sampling. If you agitate your pit or basin prior to sam-

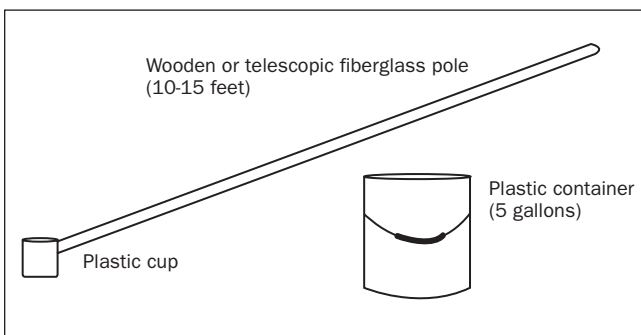

Figure 1. Liquid manure sampling devices like these can be purchased or made.

pling, a sampling device pictured in **Figure 1** can be used. If you wish to sample a storage structure without agitation, you must use a composite sampling device as shown in **Figure 2**. Manure should be collected from approximately eight areas around the pit or pond and mixed thoroughly in a clean, plastic container. An 8- to 10-foot section of 0.5- to 0.75-inch plastic pipe can also be used: extend the pipe into the pit with ball plug open, pull up the ball plug (or press your thumb over the end to form an air lock), and remove the pipe from the manure, releasing the air lock to deposit the manure in the plastic container.

Lagoon sludge. The best time to take a sludge sample is while measuring for volume of sludge in a lagoon. This allows samples to be collected from several points around the interior of the lagoon. How the sample is collected depends on how the sludge will be removed. Depending on the density and nutrient concentration of the lagoon effluent, the samples may differ by up to 100 percent from point to point.

To draw a sample, use the same type of sampler as described above for manure slurry (**Figure 2**) and lower the sampler until it almost reaches the bottom. Avoid using a commercial "sludge-judge," because experience has shown that these devices do not work well on thick manure sludge and settled solids.

Wearing plastic or latex gloves, collect a core or profile of lagoon effluent and sludge. Once the pipe is over a clean 5-gallon plastic bucket, slowly break the vacuum by removing your finger from the end of the pipe. If the entire lagoon is going to be agitated during sludge removal, the entire core of collected sludge and effluent should be sent to the laboratory. If the lagoon effluent is going to be drawn down and primarily only sludge pumped out, then just the collected sludge should be sent to the lab. If you are unsure how the sludge will be removed, take samples using both methods, label them separately, and have both analyzed.

Place several samples in the bucket and mix thoroughly before removing a sub-sample for analysis. Consider using a plastic, wide-mouth bottle when shipping samples to the laboratory.

Solid Manure. Solid manure samples should represent the manure's average moisture content. If the material varies

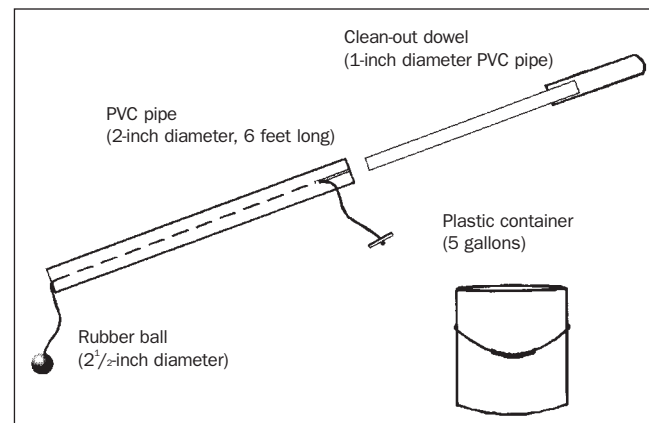

Figure 2. Composite sampler for slurries and lagoon sludge or settled solids includes a collecting PVC pipe and a clean-out dowel (smaller PVC pipe), string, and a rubber ball big enough to cover one end of the collecting pipe.

greatly in its moisture content, you should submit at least 3 samples to a laboratory and take an average of each analysis.

A 1-quart sample is adequate for analysis. Samples should be taken from approximately 8 different areas in the manure pile, placed in a clean plastic container, and thoroughly mixed. Samples should be taken wearing plastic or latex gloves and using a plastic or stainless steel hand shovel or trowel. Do not use galvanized trowels or buckets because they will likely contaminate the sample, rendering falsely high concentrations of metals like zinc in the analysis. Approximately 1 quart of the mixed sample should be placed in a plastic bag, sealed, and shipped directly to the lab. Samples stored for more than 1 day should be refrigerated.

Stockpiled manure or litter. Ideally, stockpiled manure and separated solids should be stored under cover on an impervious surface. The weathered exterior of uncovered waste may not accurately represent the majority of the material. Additionally, rainfall will move water-soluble nutrients down into the pile. If an unprotected stockpile is applied over an extended period, it should be sampled before each application.

Stockpiled manure should be sampled at a depth of at least 18 inches at 6 or more locations around the pile. The collected material should be combined in a plastic container and mixed thoroughly. The 1-quart lab sample should be taken from this mixture, placed in a plastic container or bag, sealed, and shipped to the lab for analysis. If the sample cannot be shipped within one day of sampling, it should be refrigerated.

Surface-scraped manure. Surface-scraped and piled materials should be treated like stockpiled manure. Follow the same procedures for taking samples. Ideally, surface-scraped materials should be protected from the weather unless they are used immediately.

Composted manure. Ideally, composted manure should be stored under cover on an impervious surface. Although nutrients are somewhat stabilized in these materials, some nutrients can leach out during rains. When compost is left unprotected, samples should be submitted to the lab each time the material is applied. Sampling procedures are the same as those described for stockpiled manure.

Who can analyze my manure sample?

Both public and private labs analyze manure samples. Use only labs that are certified or conduct their analysis according to the North American Proficiency Testing – Manure Assessment Program (NAPT-MAP) to test manure and wastewater, or the North American Proficiency Testing – Compost Assessment Program (NAPT-CAP) to test compost. Private labs can be found through local Cooperative Extension Service (CES) agents, state regulators, or on the NAPT-MAP Web site: <http://ghex.colostate.edu/map/>.

Deciding which lab to use depends on several factors:

- Is the lab certified or does it conduct its analysis according to NAPT-MAP or NAPT-CAP guidelines?
- What is the cost to run the sample?

- How long will it take to get your results?
- Does the lab offer all parameters needed for your operation?
- Can you get your sample to the lab in the required time?

When you have selected a lab to analyze the manure, you need to follow its specific sample requirements. Many labs offer sample containers that they ask you to use. Sample collection procedures, including holding times allowed and refrigeration and shipping requirements, must be closely followed to obtain accurate results. One standard that applies to all labs and sampling recommendations is to sample as close to the application time as possible.

Essential analyses include concentrations of essential plant nutrients, including nitrogen as ammonium (NH₄-N), and Total Kjeldahl Nitrogen (TKN), Total phosphorus (TP) and potassium (K). Additionally, you may consider sampling for nitrate (NO₃-N), dissolved phosphorus (PO₄-), calcium (Ca), magnesium (Mg), sulfur (S), iron (Fe), manganese (Mn), zinc (Zn), copper (Cu), boron (B), dry matter content or total solids (TS), pH, and electrical conductivity (for liquid samples). Where applicable, check your NPDES permit (National Pollutant Discharge Elimination System) for specific sampling requirements.

What does my manure analysis report tell me?

Lab results may be presented in a number of ways. The easiest to use is a wet, “as-is” basis in pounds of available nutrient (N, P, or K) (1) per ton; (2) per 1,000 gallons of manure or wastewater; or (3) per acre-inch of manure or wastewater.

If a lab reports results on a dry basis, you must have the moisture content of the manure to convert the results back to a wet basis. A lab may also give results as a concentration (parts per million [ppm] or milligram per liter [mg/l]), which likewise requires conversion factors to get the results into a usable form based on how you apply the manure. Finally, if a lab reports P and K as elemental P and K, you must convert them to the fertilizer basis of P₂O₅ or K₂O. This can be done with the following conversions:

$$P \times 2.29 = P_2O_5$$

$$K \times 1.20 = K_2O$$

Select a lab that reports an analysis on an “as-is” basis in the units of measure most useful to your operation.

Most useful information

The most useful information is predicted nutrients available for the first crop. Nutrient availability is predicted based on estimates of manure breakdown and nutrient loss according to application method. If the lab does not report plant-available nutrients, contact your nutrient management planner, a certified crop advisor, or your local extension office for assistance.

Of the total nutrients predicted to be available for the first crop, 50 to 75 percent will likely become available during the first month. It is, therefore, important to apply manure near the time nutrients are required by plants. The remaining nutrients gradually become available over the next three months. Nutrients not available for the first crop are slowly

released to available forms over time. In soils that do not readily leach with heavy rainfall, nutrients may accumulate to significant quantities over time.

You should review the report to see if the analysis is within the expected ranges for your manure. It is common for manure analyses to vary between seasons, due to excess rainfall, drought, or changes in management practices. However, you should compare your results to the results from previous manure reports to ensure that they appear reasonable. If your results are significantly different from what you expected, it is advisable to resample the manure. The original sample may have been mislabeled or improperly collected, and thus not be representative of the manure.

To meet a specific plant nutrient requirement, nutrients listed in the report or calculated as “available for the first crop” should be used in determining the actual application rate. For the availability prediction to be reliable, you must have properly identified the type of manure and the application method on the information sheet submitted to the lab. It is important to understand that nutrient availability cannot be determined with 100 percent accuracy. Many variables, including the type of manure product and environmental factors (i.e., soil type, rainfall, temperature, and general soil conditions), influence the breakdown of the manure and nutrient loss. Remember, the worst sample of your manure is always better than the best book value.

About the authors

Ron E. Sheffield, is a University of Idaho Extension waste management engineer at the Twin Falls Research & Extension (R&E) Center and assistant professor in the University of Idaho Department of Biological and Agricultural Engineering, rons@uidaho.edu.

Richard J. Norell is a University of Idaho Extension dairy specialist with the Idaho Falls R&E Center, rnorell@uidaho.edu.

Issued in furtherance of cooperative extension work in agriculture and home economics, Acts of May 8 and June 30, 1914, in cooperation with the U.S. Department of Agriculture, Charlotte V. Eberlein, Director of University of Idaho Extension, University of Idaho, Moscow, Idaho 83844. The University of Idaho provides equal opportunity in education and employment on the basis of race, color, national origin, religion, sex, sexual orientation, age, disability, or status as a disabled veteran or Vietnam-era veteran, as required by state and federal laws.



University of Idaho
Extension

APPENDIX G - UNIVERSITY OF IDAHO BULLETIN #704 (REVISED)

Soil Sampling

*Bulletin 704
(revised)*

*R. L. Mahler and
T. A. Tindall*



*College of
Agriculture*

 University of Idaho
Cooperative Extension System

Soil Sampling



Environmental concerns have brought nutrient management in agriculture under increased scrutiny. A goal of sound nutrient management is to maximize the proportion of applied nutrients that is used by the crop (nutrient use efficiency). Soil sampling is a best management practice (BMP) for fertilizer management that will help improve nutrient use efficiency and protect the environment.

Soil sampling is also one of the most important steps in a sound crop fertilization program. Poor soil sampling procedures account for more than 90 percent of all errors in fertilizer recommendations based on soil tests. Soil test results are only as good as the soil sample. Once you take a good sample, you must also handle it properly for it to remain a good sample.

A good soil testing program can be divided into four operations: (1) taking the sample, (2) analyzing the sample, (3) interpreting the sample analyses, and (4) making the fertilizer recommendations. This publication focuses on the first step, collecting the soil sample.

Once you take a sample, you must send it to a laboratory for analysis. Then the Extension agricultural educator or fertilizer fieldman in your county can interpret the analysis and make specific fertilizer recommendations. Fertilizer guides from the University of Idaho Cooperative Extension System are also available to help you select the correct fertilizer application rate.

The soil sampling guidelines in this publication meet sampling standards suggested by federal, state, and local nutrient management programs in Idaho.

What is a soil test?

A soil test is a chemical evaluation of the nutrient-supplying capability of a soil at the time of sampling. Not all soil-testing methods are alike nor are all fertilizer recommendations based on those soil tests equally reliable.

Reliable fertilizer recommendations are developed through research by calibrating laboratory soil test values and correlating them with crop responses to fertilizer rates. These soil test correlation trials must be conducted for several years on a particular crop growing on a specific soil type. If soil test calibration is incomplete, fertilizer recommendations based on soil-test results still can only be best guesses.

A soil test does not measure the total amount of a specific nutrient in the soil. There is usually little relationship between the total amount of a nutrient in the soil and the amount of a nutrient that plants can obtain.

A soil test also does not measure the amount of plant-available nutrients in the soil because not all the nutrients in the soil are in a form readily usable by plants. Through research, however, a relationship can usually be established between soil test nutrient levels and the total amount of a nutrient in the soil.

What does a soil test measure?

Present soil-testing methods measure a certain portion of the total nutrient content of the soil. During testing, this portion is removed from the soil by an extracting solution that is mixed with the soil for a given length of time. The solution containing the extracted portion of the nutrient is separated from the soil by filtration, and then the solution is analyzed.

A low soil-test value for a particular nutrient means the crop will be unable to obtain enough of that nutrient from the soil to produce the highest yield under average soil and climatic conditions. A nutrient deficiency should be corrected by adding the nutrient as a fertilizer. The amount of nutrient that needs to be added for a given soil-test value is calculated based on results from the correlation research test plots.

Sampling timing

Because nutrient concentrations in the soil vary with the season, you should take soil samples as close as possible to planting or to the time of crop need for the nutrient. Ideally, take the soil samples 2 to 4 weeks before planting or fertilizing the crop. It usually requires 1 to 3 weeks to take a soil sample, get the sample to the testing laboratory, and obtain results.

Sampling very wet, very dry, or frozen soils will not affect soil test results

though collecting soil samples under these conditions is difficult. Do not sample snow-covered fields. The snow makes it difficult to recognize and avoid unusual areas in the field, so you may not get a representative sample.

record of soil test results on each field to evaluate long-term trends in nutrient levels.

you can use a shovel or spade for shallow samples. You will need a plastic bucket or other container for each sample to help you collect and mix a composite sample.

Sampling frequency

For best soil fertility management, especially for the mobile nutrients, sample each year and fertilize for the potential yield of the intended crop. Having an analysis performed for every nutrient each year is not necessary. Whether you need an analysis of a nutrient depends on such things as its mobility in the soil and the nutrient requirements of the crop.

Take soil samples at least once during each crop rotation cycle. Maintain a

One of the most important steps in a soil testing program is to collect a soil sample that represents the area to be fertilized. If the soil sample is not representative, the test results and recommendations can be misleading.

The correct steps in soil sampling are illustrated in figure 1. Before sampling, obtain necessary information, materials, and equipment from the Extension agricultural educator or fertilizer fieldman in your county.

Use proper soil sampling tools. A soil auger or probe is most convenient, but

Be sure that all equipment is clean, and especially be sure it is free of fertilizer. Even a small amount of fertilizer dust can result in a highly erroneous analysis. Do not use a galvanized bucket when analyzing for zinc (Zn) or a rusty shovel or bucket when analyzing for iron (Fe). If the sample will be analyzed for Fe or manganese (Mn), do not dry the soil sample before shipping.

When sampling, avoid unusual areas such as eroded sections, dead furrows, and fence lines. If the field to be sampled covers a large area with

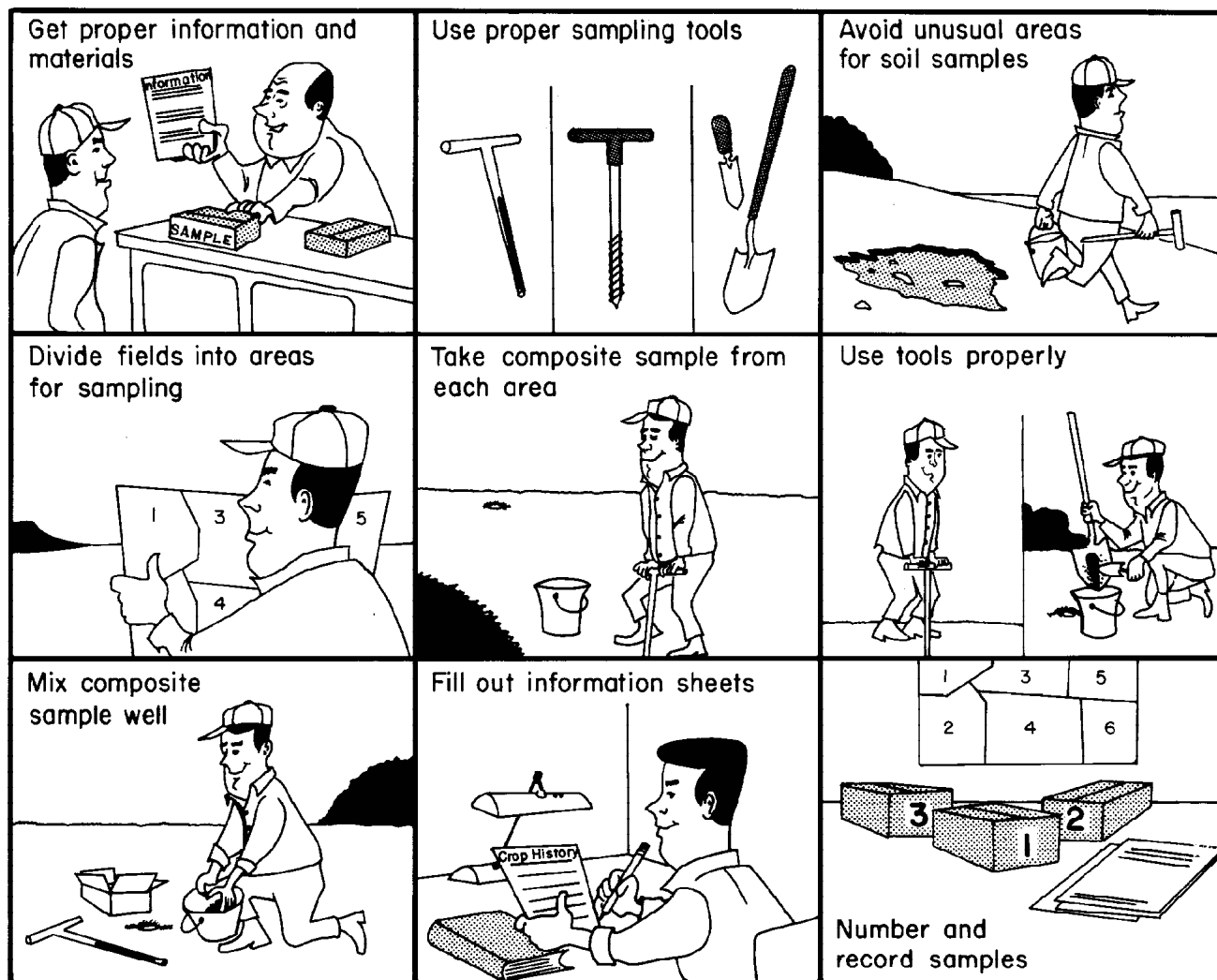

Fig. 1. Follow these steps to obtain a good sample for testing (redrawn courtesy of the National Fertilizer Institute).

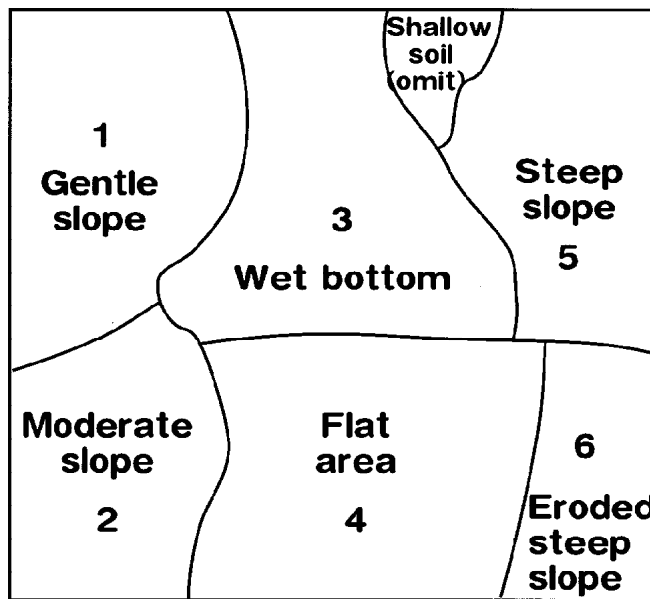

Fig. 2. A field with areas identified as sampling units.

varied topography, subdivide it into relatively uniform sampling units (fig. 2). Sampling subdivision units that are too small to fertilize separately may be of interest, but impractical if you do not treat the small units differently from the rest of the field. Omit these areas from the sampling.

Within each sampling unit take soil samples from several different locations and mix these subsamples into one composite sample. The number of subsamples needed to obtain a representative composite sample depends on the uniformity and size of the sampling unit (table 1). Although the numbers of subsamples in table 1 give the best results, they may be unrealistic if you plan to take a great number of samples. An absolute minimum of 10 subsamples from each sampling unit is necessary to obtain an

acceptable sample. The more subsamples you take, the better the representation of the area sampled.

Take all subsamples randomly from the sampling unit, but be sure to distribute subsample sites throughout the sampling unit. Meander or zig-zag throughout each sampling unit to sample the area. Special considerations are necessary in eroded areas, furrow irrigation, under no-till, and where fertilizer is banded (see "Special Sampling").

The total amount of soil you collect from the sampling unit may be more

Table 2. Effective rooting depth for some common Idaho crops.

Crop	Depth (feet)
Cereals (wheat, barley, oats)	5 to 6
Corn	5 to 6
Alfalfa, rapeseed	4 to 5
Hops, grapes, tree fruits	4 to 5
Sugarbeets	2 to 3
Peas, beans, lentils, onions, potatoes, mint	2
Vegetable seed	1 to 1½

than you need for analyses. Mix the individual subsamples together thoroughly and take the soil sample from the composite mixture. The composite sample should be at least 1 pint—about 1 pound—in size.

Sampling depth

Depth of sampling is critical because tillage and nutrient mobility in the soil can greatly influence nutrient levels in different soil zones (fig. 3). Sampling depth depends on the crop, cultural practices, tillage depth, and the nutrients to be analyzed.

Because the greatest abundance of plant roots, greatest biological activity,

Table 1. Number of subsamples recommended for a representative composite sample based on field size.

Field size (acres)	Number of subsamples
fewer than 5	15
5 to 10	18
10 to 25	20
25 to 50	25
more than 50	30

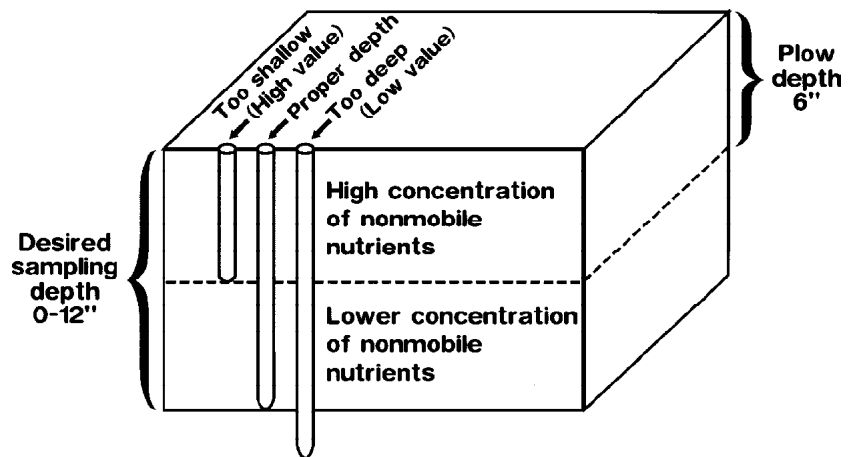

Fig. 3. Too deep or shallow a sampling depth can produce inaccurate soil test results. The plow layer is usually higher in nonmobile nutrients than the soil layers below it.

and highest nutrient levels occur in the surface layers, the upper 12 inches of soil are used for most analyses. The analyses run on the surface sample include soil reaction (pH), phosphorus (P), potassium (K), organic matter, sulfur (S), boron (B), zinc (Zn), and other micronutrients.

Sampling depth is especially critical for nonmobile nutrients such as P and K. The recommended sampling depth for nonmobile nutrients is 12 inches (fig. 3).

The tillage zone, typically 6 to 8 inches deep, usually contains a relatively uniform, high concentration of nonmobile nutrients. Below the tillage zone the concentration is usually lower. Therefore, a sample from the tillage zone will usually have a higher content of nonmobile

nutrients than a sample from the desired 0- to 12-inch sample depth. This can lead to erroneous results.

Depth sampling

When sampling for mobile nutrients such as nitrogen (N), boron (B), and sulfur (S), take samples by 1-foot increments to the effective rooting depth of the crop (fig. 4). This can be a depth of 5 to 6 feet (table 2) unless the soil has a root-limiting layer such as bedrock or hardpan. For each foot depth, take 10 or more subsamples at random from the sampling unit.

If you plan to sample less than a year after banding or injecting fertilizer or if you have any question about fertilizer placement, use the sampling technique described under "Areas

Where Fertilizer Has Been Banded." Irrigation or precipitation should disperse mobile nutrients over a period of a year.

Sample handling

Soil samples need special handling to ensure accurate results and minimize changes in nutrient levels because of biological activity. Keep moist soil

samples cool at all times during and after sampling. Samples can be frozen or refrigerated for extended periods of time without adverse effects.

If the samples cannot be refrigerated or frozen soon after collection, air dry them or take them directly to the soil testing laboratory. Air dry by spreading the sample in a thin layer on a plastic sheet. Break up all clods or lumps, and spread the soil in a layer about 1/4 inch deep. Dry at room temperature. If a circulating fan is available, position it to move the air over the sample for rapid drying.

Caution: Do not dry where agricultural chemical or fertilizer fumes or dust will come in contact with the samples. Do not use artificial heat in drying. Ask the Extension agricultural educator or fertilizer fieldman in your county for more details concerning special handling of soil samples.

When the soil samples are dry, mix the soil thoroughly, crushing any coarse lumps. Take from the sample about 1 pint (roughly 1 pound) of well-mixed soil and place it in a soil sample bag or other container. Soil sample bags and soil test report forms are available from the Cooperative Extension System office in your county or from a fertilizer fieldman.

Label the bag carefully with your name, the sample number, sample depth, and field number. The field number should correspond with a field or farm map showing the areas

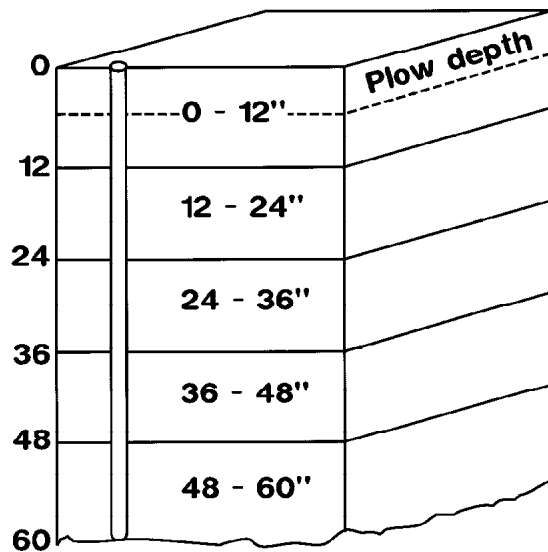

Fig. 4. Depth sampling (successive samples by 12-inch increments) for mobile nutrients (especially N) should be continued to rooting depth, which may be 5 to 6 feet for some crops.

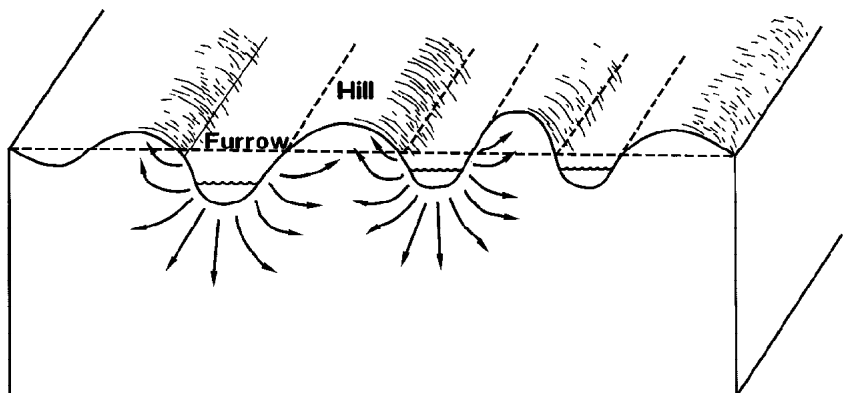

Fig. 5. Movement of mobile nutrients in furrow-irrigated fields.

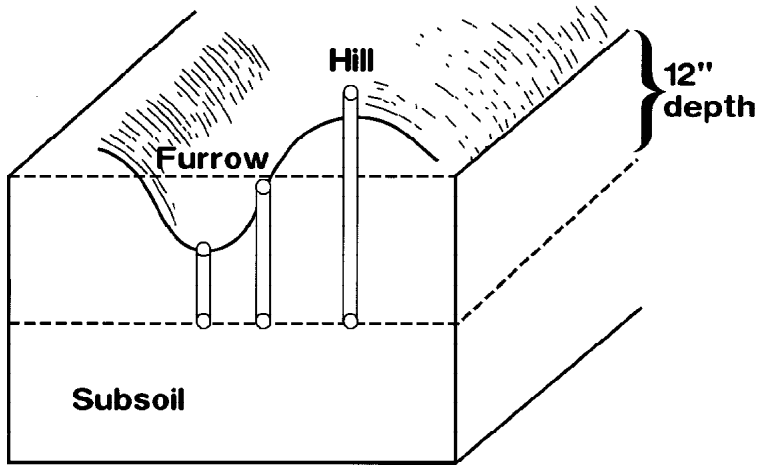

Fig. 6. Special sampling techniques are required when soil sampling furrow-irrigated fields. Take a sample from the hilltop, the furrow bottom, and at the midpoint between the hilltop and furrow bottom. The 12-inch sampling depth is based on the midpoint sampling location.

sampled. This will help you keep an accurate record of soil test reports. Provide information on crop to be grown, yield potential, recent history of crops grown, yields, fertilizer applied, and other information.

Sample analysis

Analyze regularly only for those nutrients that have been shown to be yield limiting in your area or for the crop to be grown. In general, all soils should be analyzed for N, P, K, and S. For determination of potential need for micronutrients, refer to PNW 276, *Current Nutrient Status of Soils in Idaho, Oregon, and Washington*. Occasional analyses for micronutrient concentrations may be advisable.

Special sampling

Special sampling problems occur in fields that have been leveled for irrigation, fields that have lost all or most topsoil as a result of erosion, fields that are surface (furrow)

irrigated, fields that have had a fertilizer band applied, and fields that are not thoroughly tilled.

Land-leveled and eroded areas

Areas that have been eroded or artificially leveled for irrigation usually have little or no original topsoil. The soil surface may be exposed subsoil material. These areas should be sampled separately if they are large enough to be managed differently from where topsoil has not been removed. Subsoil material is usually low in organic matter and can be high in clay, calcium carbonate (lime), or both.

For a representative soil sample, sample furrow-irrigated fields before the furrowing operation. If furrowing has already been completed, follow the special sampling procedures described here.

The movement of water and dissolved plant nutrients can create unique nutrient distribution patterns in the hills between the furrows (fig. 5). To obtain a representative sample, you need to be aware of furrow direction, spacing, and location, and to take closely spaced soil samples perpendicular to the furrow (fig. 6).

Approximately 20 sites (with at least three samples per site) are needed for a representative composite soil sample. At each sampling site, take a sample from the hilltop, from the midpoint between the hilltop and furrow, and from the furrow bottom. The sampling depth at the midpoint between the hilltop and furrow bottom should be 12 inches. The bottom point of this sample should be the same as for the furrow and hilltop samples. Thus, the furrow sampling depth will be less than 12 inches, while the hilltop sampling depth will be more than 12 inches (fig. 6).

Mix the hilltop, midpoint, and furrow samples to make a composite sample for each site. Mix the site samples for a representative composite field soil

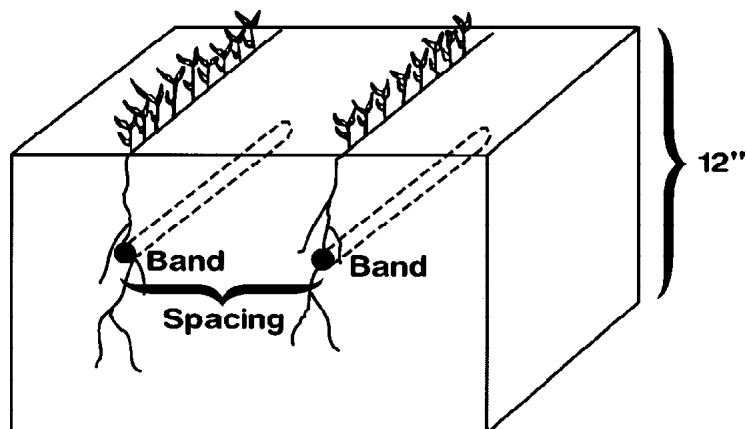

Fig. 7. Diagram of fertilizer location in soil where fertilizer has been banded.

sample to be analyzed for nonmobile nutrients (P, K, and micronutrients). Deeper profile sampling (depth sampling) is recommended for mobile nutrients (N and S).

Areas where fertilizer has been banded

Banding of fertilizers is becoming a more common practice (fig. 7). In fields where fertilizers have been banded and tillage has occurred before soil sampling, regular sampling procedures can be followed. However, if tillage has not adequately mixed the soil, special soil sampling is required. If a field has had a banded fertilizer application the previous growing season and has not been plowed, an ideal sample would be a continuous slice 1 to 2 inches thick and 12 inches deep extending from the center of one band to the center of the next band.

Little research has been conducted to determine the best method of sampling banded fields. Currently three different approaches are used widely. Each method produces a satisfactory representative sample, but the effort required to obtain these samples differs considerably.

Systematic sampling method . If you know the direction, depth, and spacing of the fertilizer band, you can obtain a representative soil sample with this sampling procedure. Take 5 to 10 soil samples perpendicular to the band row beginning in the edge of a fertilizer band and ending at the edge of an adjacent band (fig. 8). Follow this procedure on at least 20 sampling sites in each field or portion of a field being sampled. Mix and composite the soils collected from each site to obtain a representative soil sample.

Controlled sampling method. You also should know the direction, depth, and spacing of the fertilizer bands to obtain a representative soil sample with this method. Take 20 to 30 soil cores from locations scattered throughout the field or portion of the field. Avoid sampling directly in a fertilizer band.

The composite sample should adequately represent the area being sampled. This method may result in slightly lower soil test values of nonmobile nutrients (P, K, and micronutrients) than the systematic and random sampling methods.

Random sampling method . Use this sampling method when the location of the previous season's fertilizer bands is not known. Take 40 to 60 random soil cores to form a composite sample of the area being sampled.

Reduced tillage or no-till fields

You may need special approaches to soil sampling with reduced tillage or no-till fields because the soil has been disturbed so little that fertilizer, whether broadcast on the surface or banded below the surface, is not mixed into the soil. You need to know the history of fertilization, tillage, and other management practices to determine how to obtain a representative sample.

If nonmobile nutrients (P, K, and micronutrients other than B) have been surface broadcast and little or no tillage has been used since their application, remove the surface 1 inch of soil before sampling. Nutrients in the top inch of soil will probably not be available to the growing crop.

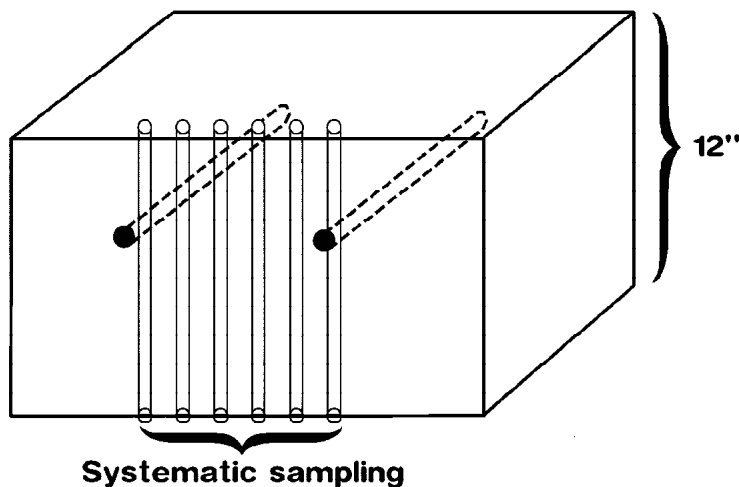

Fig. 8. Systematic soil sampling in a field where fertilizer has been banded (sampling method 1).

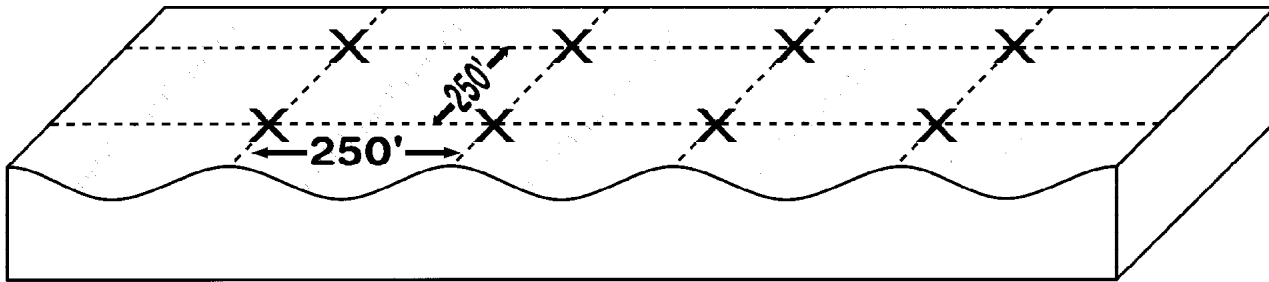

Fig. 9. Grid soil sampling pattern where samples are collected every 250 feet. Note that a complete soil sample is collected at each spot marked with an X.

If fertilizer has been banded with the no-till system, consider methods suggested in "Areas Where Fertilizer Has Been Banded." If a field has been under a continuous no-till system for a long time, determine the pH of the surface foot at 3-inch intervals (0 to 3, 3 to 6, 6 to 9, 9 to 12 inches) every 3 to 5 years. Soil pH will affect the availability of fertilizer nutrients as well as the activity of commonly used herbicides, insecticides, and fungicides.

Grid sampling in nonuniform fields

Many fields are not uniform and vary both horizontally and vertically across landscapes. Traditional soil sampling procedures average nutrient levels in soil subsamples to determine average nutrient levels in the field. The nutrient values obtained are good, but the manager must realize that many of the values in the field are either less than or greater than the values determined. When fields are broken into grids with shorter distances between the sampling points a more precise soil map can be developed to determine nutrient needs.

The technology is now available to combine grid sampling with variable

rate fertilizer application to handle spatial variability within a field. These application techniques make fertilizer nutrient application more precise, resulting in greater nutrient use efficiency and reducing pollution potential.

Irrigated fields including individual pivots should be set up in a 200- to 300-foot grid for potato, sugarbeets, corn, and other potentially high-N-use crops (fig. 9). A wider grid of 400 feet may be used for small grains, beans, and other crops where N management is less intensive or under dryland conditions.

Soil nutrient needs for each segment of the grid are entered into a computer-driven system mounted on specialized commercial fertilizer application equipment. Variable rates of nutrients are then applied based on individual soil samples over the entire field.

A similar system designed for fertilizer applications through pivot sprinklers is being developed by the University of Idaho. This system has the potential to apply variable rates of nutrients and water specifically related to changes across individual fields.

The Soil Conservation Service has a digitized soil survey information system (SSIS), which when combined with the results of grid sampling provides specific information and recommendations for soils and soil types within a field. The SSIS can locate pockets of sandy or coarse-textured soils where leaching is a major concern or areas of finer-textured soils where pockets of residual N may occur. The SSIS also indicates where erosion or surface runoff may be high and where areas should be targeted for federal programs such as the Conservation Reserve Program.

Another computer-mapping technique, Geographic Information Systems (GIS), can be combined with the results of grid sampling to provide growers and land managers with information for land-use planning.

Additional information on proper soil sampling procedures can be obtained from the Extension agricultural educator or fertilizer fieldman in your county.

The authors—Robert L. Mahler, soil scientist, Moscow, and Terry A. Tindall, former Extension soil scientist, Twin Falls Research and Extension Center; both with the University of Idaho Department of Plant, Soil, and Entomological Sciences.

Issued in furtherance of cooperative extension work in agriculture and home economics, Acts of May 8 and June 30, 1914, in cooperation with the U.S. Department of Agriculture, LeRoy D. Luft, Director of Cooperative Extension System, University of Idaho, Moscow, Idaho 83844. The University of Idaho provides equal opportunity in education and employment on the basis of race, color, religion, national origin, age, gender, disability, or status as a Vietnam-era veteran, as required by state and federal laws.

APPENDIX H - ANNUAL REPORT TEMPLATE

CAFO ANNUAL REPORT FORM

Submit a copy of this form to the U.S. Environmental Protection Agency (EPA), Region 10, by March 1st of each year to report data for the previous calendar year:

EPA Region 10
Attn: NPDES Compliance Unit
Office of Compliance and Enforcement
1200 6th Avenue, Suite 900
Mail Stop: OCE-133
Seattle, WA 98101

Also submit a copy of the form to the Idaho State Department of Agriculture (ISDA):

ISDA
Division of Animal Industries
P.O. Box 790
Boise, ID 83701

The reporting period for the information list below is January 1 – December 31, _____.

1. Facility Information

a. Name of CAFO (as listed in the facility's written notification of permit coverage)

b. Permit Number (as listed in the facility's written notification of permit coverage)

Contact Information (provide the name, telephone number, and email address of the person to be contacted about the information contained in this report)

c. Name: _____

d. Telephone: (_____) _____ - _____

e. Email: _____

2. Animal Inventory

For each type of animal confined at this facility, whether in open confinement or housed under roof, list the type and maximum number confined during the year.

Animal Type	Number Confined

3. Manure, Litter, and Process Wastewater Generated and Transferred

Estimate the total amount of manure, litter, and process wastewater generated at this facility and transferred to other persons (i.e., for use on land not under the control of the permitted CAFO or other use or disposal not under the CAFO's control) during the reporting period. Indicate the units (tons or cubic feet) for manure and litter.

	Units	Amount Generated	Amount Transferred
Manure	<input type="checkbox"/> tons or <input type="checkbox"/> ft ³		
Litter	<input type="checkbox"/> tons or <input type="checkbox"/> ft ³		
Process Wastewater	<input type="checkbox"/> gallons or <input type="checkbox"/> ft ³		

4. Production Area Discharges

For each discharge of manure, litter, or process wastewater from the production area during the reporting period, list the date, time, and approximate volume of the discharge.

Discharge date (mm/dd/yyyy)	Time (specify AM or PM)	Approximate volume (specify gallons or other units)

5. Nutrient Management Plan

Was the current version of the CAFO's NMP developed or approved by a certified nutrient management planner?

- Yes No

6. Acres for Land Application

- a. Total number of acres for land application covered by the CAFO’s nutrient management plan (NMP)

_____ Acres

- b. Total number of acres under the control of the CAFO used for land application of manure, litter, or process wastewater during the reporting period

_____ Acres

7. Crops and Yields

For each field, list the field ID as listed in the CAFO’s NMP, the actual crop(s) planted, and the actual yield for each crop harvested during the reporting period. Use multiple lines for double cropping or cover crops. In the last column, check the box to indicate whether the crop was seeded during the year prior to the period covered by this report. Use Table A.7 in Attachment A to list additional fields and crops if needed.

Check here to indicate whether additional fields and crops are listed in Attachment A.

Field ID	Crop	Yield (specify units per acre, e.g., tons, bushels, cwt)	Seeded in previous year?
			<input type="checkbox"/>
			<input type="checkbox"/>
			<input type="checkbox"/>
			<input type="checkbox"/>
			<input type="checkbox"/>
			<input type="checkbox"/>
			<input type="checkbox"/>
			<input type="checkbox"/>
			<input type="checkbox"/>
			<input type="checkbox"/>
			<input type="checkbox"/>
			<input type="checkbox"/>
			<input type="checkbox"/>
			<input type="checkbox"/>
			<input type="checkbox"/>

8. Manure, Litter, and Process Wastewater Application

Provide the total amount of manure, litter, and process wastewater applied to each field during this reporting period. Indicate the units used for manure and litter. Also list the amount of plant-available nitrogen and phosphorus from manure, litter, and process wastewater applied to each field during the reporting period. Use Table A.8 in Attachment A to list additional fields if needed.

Check here to indicate whether additional fields are listed in Attachment A.

Field ID	Manure applied (<input type="checkbox"/> tons/acre or <input type="checkbox"/> ft ³ /acre)	Litter applied (<input type="checkbox"/> tons/acre or <input type="checkbox"/> ft ³ /acre)	Wastewater applied (gallons/acre)	Nutrients applied* (pounds/acre)	
				PAN	P

*Total pounds of plant-available nitrogen (PAN) and phosphorus (P) applied per acre. For PAN, include NO₃, NH₄, and the portion of organic N applied (if any) that is expected to be available to the current crop, determined consistent with the annual nutrient budget.

9. Soil Sample Analyses

For each field, list the analytical results for the most recent soil analysis for pH, soil organic matter (SOM), nitrate (NO₃-N), ammonium (NH₄-N), and phosphorus (P). Include units. Use Table A.9 in Attachment A to list additional fields if needed.

Check here to indicate whether additional fields are listed in Attachment A.

Field ID	pH	SOM	NO ₃ N	NH ₄ N	P

10. Manure, Litter, and Process Wastewater Sample Analyses

For each source of manure, litter, or process wastewater land applied during the reporting period, list the analytical results for the most recent analysis. Include units.

Source of manure or wastewater (e.g., storage structure)		NH ₄ N	TKN	NO ₃ N	P	<input type="checkbox"/> Total Solids or <input type="checkbox"/> Dry Matter
	Units:					

11. Nutrient Budgets

For each field provide the calculated amount manure, litter, and process wastewater, as well as plant-available nitrogen and phosphorus to be applied (in lbs/acre), based on the annual nutrient budget included in the NMP. Indicate the units for manure and litter. Use Table A.11 in Attachment A to list additional fields if needed.

Check here to indicate whether additional fields are listed in Attachment A.

Field ID	Manure (<input type="checkbox"/> tons/acre or <input type="checkbox"/> ft ³ /acre)	Litter (<input type="checkbox"/> tons/acre or <input type="checkbox"/> ft ³ /acre)	Wastewater (gallons/acre)	Nutrients *	
				PAN	P

*Total pounds of plant-available nitrogen (PAN) and phosphorus (P) planned per acre. For PAN, include NO₃, NH₄, and the portion of organic N applied (if any) that is expected to be available to the current crop, from the annual nutrient budget.

12. Certification

Print the form and sign the certification statement below before submittal.

I certify under penalty of law that this document and all attachments were prepared under my direction or supervision in accordance with a system designed to assure that qualified personnel properly gather and evaluate the information submitted. Based on my inquiry of the person or persons who manage the system, or those persons directly responsible for gathering the information, the information submitted is, to the best of my knowledge and belief, true, accurate, and complete. I am aware that there are significant penalties for submitting false information, including the possibility of fine and imprisonment for knowing violations.

Name of Certifying Official (print or type)

Signature

Date Signed

NOTE: This report must be signed and certified by a responsible corporate officer (corporation), a general partner (partnership), or the proprietor (sole proprietorship). The report may be signed by a duly authorized representative of the corporate officer, general partner, or proprietor if:

- i. The authorization is made in writing by the corporate officer, general partner, or proprietor, and
- ii. The authorization specifies either an individual or a position having responsibility for the overall operation of the regulated facility or activity, or an individual or position having overall responsibility for environmental matters for the company; and
- iii. The written authorization is submitted to the Director of EPA Region 10's Office of Compliance and Enforcement.

APPENDIX I - IDAHO PHOSPHORUS SITE INDEX

The Phosphorus Site Index:

***A Systematic Approach to Assess the Risk of Nonpoint Source Pollution of Idaho Waters by
Agricultural Phosphorus***

Dr. April Leytem
Research Soil Scientist
USDA- ARS

Dr. David Bjorneberg
Supervisory Agricultural Engineer
USDA-ARS

Dr. David Tarkalson
Research System Agronomist
USDA-ARS

2017

Table of Contents

Introduction	4
Why is phosphorus a concern for Idaho	4
What is a phosphorus site index	5
Phosphorus Site Index:	7
Part A: Phosphorus Loss Potential Due to Site and Transport Characteristics	8
Part B: Phosphorus Loss Potential Due to P Source and Management Practices	8
Usage of the Idaho Phosphorus Site Index	11
Phosphorus Site Index – Part A:	12
Soil Erosion	13
Runoff Index	15
Leaching Potential	16
Distance from Edge of Field to Surface Water	17
Best Management Practices for Reducing Transport Losses of P	18
Phosphorus Site Index Part A – Sample Calculation	21
Phosphorus Site Index – Part B:	22
Soil Test Phosphorus	23
Phosphorus Application Rate	24
Phosphorus Application Method	25
Phosphorus Site Index Part B – Sample Calculation	27
Calculation and Interpretation of the Overall P Loss Rating for a Site	28
Interpretation of the P Site Index Value	29
Best Management Practice Definitions	30
References	32

List of Tables

Table 1. The Phosphorus Site Index Proposed for use in Idaho	9
Table 2. Generalized Interpretation of the P Site Index Value	10
Table 3. Soil erodibility factor	14
Table 4. Runoff index for surface irrigated fields	15
Table 5. Runoff index for sprinkler or non-irrigated fields	15
Table 6. Leaching potential	16
Table 7. Distance from edge of field to surface water	17
Table 8. Management practices to reduce the loss of P from fields	19
Table 9. Phosphorus application rate	24
Table 10. Phosphorus concentration of dairy manure	24
Table 11. Values for P application methods for the P Site Index	25
Table 12. Generalized Interpretation of the P Site Index Value	29

INTRODUCTION

Why is phosphorus a concern for Idaho?

Water quality in Idaho has been negatively impacted by the inputs of nutrients from both point and nonpoint sources. The two nutrients of greatest concern are nitrogen (N) and phosphorus (P). Efforts to reduce nutrient enrichment of ground and surface waters have become a high priority for state and federal agencies and a matter of considerable importance to all nutrient users and nutrient generators in the state. Two actions in particular highlight the importance of this issue in Idaho:

- Total Maximum Daily Load (TMDL) Program: Section 303(d) of the Federal Clean Water Act (CWA) of 1972 requires states to develop a list of water bodies that need pollution reduction beyond that achievable with existing control measures. These water bodies are referred to as “Water Quality Limited” and are compiled by each state on a “303(d) list”. States are required to develop a “total maximum daily load (TMDL)” for a number of pollutants, including nutrients for these “water quality limited” waters. A TMDL is defined as “the level of pollution or pollutant load below which a water body will meet water quality standards and thereby allow use goals such as drinking water supply, swimming and fishing, or shellfish harvesting”. In ID, approximately 36% of streams were identified as not meeting water quality standards. The TMDL for the upper and middle Snake River was set at 0.075 mg total P L⁻¹.
- Idaho Statute Title 37 Chapter 4 Section 37-40, passed in 1999 requires that all dairy farms shall have a nutrient management plan approved by the Idaho State Department of Agriculture. The nutrient management plan shall cover the dairy farm site and other land owned and operated by the dairy farm owner or operator. Nutrient management plans submitted to the department by the dairy farm shall include the names and addresses of each recipient of that dairy farm’s livestock waste, the number of acres to which the livestock waste is applied and the amount of such livestock waste received by each recipient. The information provided in this subsection shall be available to the county in which the dairy farm, or the land upon which the livestock waste is applied, is located. If livestock waste is converted to compost before it leaves the dairy farm, only the first recipient of the compost must be listed in the nutrient management plan as a recipient of livestock waste from the dairy farm. Existing dairy farms were required to submit a nutrient management plan to the department on or before July 1, 2001, and plans are required to be updated every 5 years.

What is a Phosphorus Site Index?

In the early 1990's the U.S. Department of Agriculture (USDA) began to develop assessment tools for areas with water quality problems. While some models such as the Universal Soil Loss Equation (USLE) for erosion, and Groundwater Loading Effects of Agricultural Management Systems (GLEAMS) for ground water pollution, were already being used to screen watersheds for potential agricultural impacts on water quality, there was no model considered suitable for the field-scale assessment of the potential movement of P from soil to water. A group of scientists from universities and governmental agencies met in 1990 to discuss the potential movement of P from soil to water, and later formed a national work group (PICT: Phosphorus Index Core Team) to more formally address this problem. Members of the PICT soon realized that despite the many scientists conducting independent research on soil P, there was a lack of integrated research that could be used to develop the field scale assessment tool for P needed by USDA. Consequently, the first priority of PICT was a simple, field-based, planning tool that could integrate through a multi-parameter matrix, the soil properties, hydrology, and agricultural management practices within a defined geographic area, and thus to assess, in a relative way, the risk for P movement from soil to water. The initial goals of the PICT team were:

- *To develop an easily used field rating system (the **Phosphorus Site Index**) for Cooperative Extension, Natural Resource Conservation Service (NRCS) technical staff, crop consultants, farmers or others that rates soils according to the potential for P loss to surface waters*
- *To relate the P Site Index to the sensitivity of receiving waters to eutrophication. This is a vital task because soil P is only an environmental concern if a transport process exists that can carry particulate or soluble P to surface waters where eutrophication is limited by P.*
- *To facilitate adaptation of the P Site Index to site specific situations. The variability in soils, crops, climates and surface waters makes it essential that each state or region modify the parameters and interpretation given in the original P Index to best fit local conditions.*
- *To develop agricultural management practices that will minimize the buildup of soil P to excessive levels and the transport of P from soils to sensitive water bodies.*

The *P Site Index* is designed to provide a systematic assessment of the risks of P loss from soils, but does not attempt to estimate the actual quantity of P lost in runoff. Knowledge of this risk not only allows us to design best management practices (BMPs) that can reduce agricultural P losses to surface waters, but to more effectively prioritize the locations where their implementation will have the greatest water quality benefits.

It has long been known that P loss depends on not only the amount of P in or added to a soil but the transport processes that control soil and water movement from fields to waterways. Therefore, when assessing the risk of P loss from soil to water, it is important that we not focus strictly on measures of P, such as agronomic soil test P value. Rather a much broader, multi-disciplinary approach is needed; one that recognizes that P loss will vary among watersheds and soils, due to the rate and type of soil amendments used, and due to the wide diversity in soils, crop management practices, topography, and hydrology. At a minimum, any risk assessment process for soil P shall include the following:

- Characteristics of the P source (fertilizer, manure, biosolids) that influence its solubility and thus the potential for movement or retention of P once the source has been applied to a soil.
- The concentration and bioavailability of P in soils susceptible to loss by erosion.
- The potential for soluble P release from soils into surface runoff or subsurface drainage.
- The effect of other factors, such as hydrology, topography, soil, crop, and P source management practices, on the potential for P movement from soil to water.
- Any “channel processes” occurring in streams, field ditches, etc. that mitigate or enhance P transport into surface waters.
- The sensitivity of surface waters to P and the proximity of these waters to agricultural soils.

In summary, when resources are limited, it is critical to target areas where the interaction of P source, P management, and P transport processes result in the most serious risk of losses of P to surface and shallow ground waters. This is the fundamental goal of the *P Site Index*.

Phosphorus Site Index

The Phosphorus Site Index

The *P Site Index* has two separate components (Table 1). Part A characterizes the risk of P loss based on site-specific soil properties and hydrologic considerations. Part B characterizes the risk of P loss based on site-specific past and current nutrient management practices that affect the concentration of P in the soil (soil test P) and the potential for P loss due to management of inorganic (fertilizer) and organic (manures, composts, etc.) P sources. Parts A and B are summarized below, followed by a detailed discussion and descriptions of each component of the two parts. Generalized interpretations of the *P Site Index* values are given in Table 2.

Part A: Phosphorus Loss Potential Due to Site and Transport Characteristics

Surface transport mechanisms, i.e. soil erosion and runoff are generally the main mechanisms by which P is exported from agricultural fields to receiving waters. In some areas, leaching of P can also be a significant method of P export, especially in areas with artificial subsurface drainage (e.g. tiles, mole drains) high water tables, or shallow soils overlying basalt. Therefore, the considerations of the methods of P transport factors affecting these transport mechanisms are critical to an understanding of P losses from watersheds. Part A includes the following four factors: (i) soil erodibility; (ii) soil surface runoff index; (iii) leaching potential; and (iv) distance from edge of field to surface water.

Part B: Phosphorus Loss Potential Due to P Source and Management Practices

Phosphorus losses are also related to the amount and forms of P at a site which can potentially be transported to ground or surface waters. The main sources of P at any site that must be considered in assessing the risk of P loss are (i) soil P (particulate and dissolved), a reflection of natural soil properties and past management practices; and (ii) P inputs such as inorganic fertilizers and organic P sources (manures, composts, biosolids). Also of importance are the management practices used for all P inputs, such as the rate, method, and timing of fertilizer and manure applications, as these factors will influence whether or not P sources will have negative impacts on water quality. Part B includes the following three factors: (i) soil test P value; (ii) P applications rate; and (iii) P application method.

Table 1. The Phosphorus Site Index proposed for use in Idaho

Part A: Phosphorus loss potential due to site and transport characteristics

Characteristics	Phosphorus Loss Rating					Field Value
	Very Low 0	Low 1	Medium 2	High 4	Very High 8	
Soil Erodibility	Very Low 0	Low 1	Medium 2	High 4	Very High 8	
Soil Surface Runoff Index – Surface Irrigated	No Runoff 0	Water runs off less than 50% of the irrigation set time 4		Water runs off more than 50% of the irrigation set time 8		
Soil Surface Runoff Index – Sprinkler or Non-Irrigated	Very Low 0	Low 1	Medium 2	High 4	Very High 8	
Leaching Potential	Low 1		Medium 2	High 4		
Distance from Edge of Field to Surface Water	> 2,640' 0		200-2,640' 2	< 200' 8		

Part B: Phosphorus loss potential due to P source and management practices.

Characteristics	Phosphorus Loss Rating					Field Value
	Very Low	Low	Medium	High	Very High	
Soil Test P value	0.05 x [Olsen Soil Test P (ppm)] 0.025 x Bray Soil Test P (ppm)					
P Application Rate (lbs P ₂ O ₅ applied per acre)	No Application 0	< 60 1	60 – 150 2	151 – 300 4	>300 8	
P Application Method	None Applied 0	Incorporated within 2 days or injected/banded below surface at least 3” 1	Incorporated within 7 days of application 2	Incorporated > 7 days or no incorporation when applied between February 16 and December 15 4	Application between December 16 and February 15 8	

Table 2. Generalized interpretations of the *P Site Index*.

<i>P Site Index</i> Value	Generalized Interpretation of the <i>P Site Index</i> Value
< 75	LOW potential for P movement from this site given current management practices and site characteristics. There is a low probability of an adverse impact to surface waters from P losses from this site. Nitrogen-based nutrient management planning is satisfactory for this site. Soil P levels and P loss potential may increase in the future due to N-based nutrient management planning.
75 - 150	MEDIUM potential for P movement from this site given current management practices and site characteristics. Phosphorus applications shall be limited to the amount expected to be removed from the field by crop harvest (crop uptake) or soil test-based P application recommendations. Testing of manure P prior to application is required.
151 – 225	HIGH potential for P movement from this site given the current management practices and site characteristics. Phosphorus applications shall be limited to 50% of crop P uptake. Testing of manure P prior to application is required.
> 225	VERY HIGH potential for P movement from this site given current management practices and site characteristics. No P shall be applied to this site.

Usage of the Idaho *Phosphorus Site Index*

The Phosphorus Site Index is a risk assessment tool to help determine the potential for off-site transport of phosphorus from agricultural fields. It is intended to be used as an integral and interactive part of the nutrient management plan to help guide applications of manure and fertilizers to minimize potential P losses from agricultural fields, and to identify fields that may require additional management to reduce P losses even when P applications are not planned. The PSI is also a valuable educational tool to assist producers in recognizing high risk areas, allowing them to focus conservation practices where they would be of most value.

A PSI rating shall be done for each field. Fields that do not receive manure and fertilizer shall only be assessed once until there is a planned application of P. The PSI shall be calculated prior to P application for each field using the planned management and P application rate along with current soil test P results. The risk rating will determine whether or not the P application on the field is allowable, given the current management. For example, if the risk assessment was completed with inputs for the field source factors (soil test P, planned P application rates, and planned application method and timing) and the field received a low rating, then application and management can continue according to plan. If, however, the risk rating is in a medium category, P application will be limited to crop uptake. If the risk rating is in a higher category, BMPs will need to be implemented on the field in order to reduce the potential for P loss, and/or the P application rates must be limited or prohibited in order to reduce the risk of P losses from the field. Producers can receive full credit for maximum of two (2) BMPs per field at any given time. In addition, testing of manure prior to application will be required for fields having a risk rating above low.

When a perennial crop such as alfalfa is part of the rotation, or when allowable manure application rates are below a reasonable application rate (<10 tons/acre for manure and <5 tons/acre for composted manure) then a producer may be allowed to apply up to a four year application rate at one time with no further application over the remainder of the time period that the nutrients have been allocated to. For example, a field with a medium rating beginning a four-year rotation of alfalfa could apply a maximum of four times the annual expected crop P uptake rate in the first year with no additional P application for the next three years; or a field with a high rating beginning a four-year rotation of alfalfa could apply a maximum of two times the annual expected crop P uptake rate in the first year, and the following three years of alfalfa could receive no additional P.

Phosphorus Site Index:

Part A: Phosphorus Loss Potential Due to Site and Transport Characteristics

Soil Erosion

Phosphorus is strongly sorbed by soils, therefore erosion of soil materials dominates the movement of particulate P in landscapes (Bjorneberg et al., 2002; Leytem and Westermann, 2003). Up to 90% of the P transported from surface irrigated crops is transported with eroded sediment (Berg and Carter, 1980). In contrast to rainfall, irrigation is a managed event. Runoff and soil erosion should be minimal from properly managed sprinkler irrigation or drip irrigation. Water flowing over soil during surface irrigation will detach and transport sediment. Annual soil loss from furrow irrigated fields can range from less than 1 to greater than 100 tons per acre (Berg and Carter, 1980; Koluvek et al., 1993). Typically, greater than 90% of the P in surface irrigation runoff from clean-tilled row-crop fields is transported with eroded sediment. Conversely, when erosion is minimal from crops such as alfalfa and pasture, greater than 90% of the total P is dissolved in the runoff water (Berg and Carter, 1980). Total P concentration in surface irrigation runoff correlates directly with sediment concentration (Fitzsimmons et al., 1972, Westermann et al., 2001). Dissolved reactive P concentration in surface irrigation runoff, on the other hand, correlates with soil test P concentration, but not with sediment concentration (Westermann et al., 2001). During detachment and movement of sediment in runoff, the finer-sized fractions of source material are preferentially eroded. Thus, the P content and reactivity of eroded particulate material is usually greater than the source soil (Carter et al., 1974; Sharpley et al., 1985). Therefore, to minimize P loss in the landscape, it is essential to control soil erosion. Particulate P movement in the landscape is a complex function of rainfall, irrigation, soil properties affecting infiltration and runoff of irrigation/rainfall/snowmelt, and soil management factors affecting erosion. Numerous management practices that minimize P loss by erosion are available including filter strips, contour tillage, cover crops, use of polyacrylamide and impoundments or small reservoirs.

Soil erosion can be estimated from erosion prediction models such as the Universal Soil Loss Equation (USLE) or the Revised Universal Soil Loss Equation (RUSLE) for water erosion and Wind Erosion Equation (WEQ) for wind erosion. However, neither USLE nor RUSLE can accurately predict irrigation erosion. Therefore, the potential for soil erosion is based on the erodibility of the soil along with the predominant slope of the field. While this factor does not predict sediment transport and delivery to a water body, it does indicate the potential for sediment and attached P movement across the slope or unsheltered distance toward a water body.

For the *Phosphorous Site Index*, the potential for soil erosion loss is determined by the erodibility of the soil (K_w factor) along with the slope of the field Table 3.

Table 3. Soil erodibility factor

Kw factor - surface mineral layer Whole Soil	Slope Gradients				
	< 2%	2 – 5%	5 – 10%	10 – 15%	> 15%
<= 0.10 Very low erodibility	Very Low	Very Low	Very Low	Very Low	Low
0.11 – 0.20 Low erodibility	Very Low	Very Low	Very Low	Low	Medium
0.21 – 0.32 Moderate erodibility	Very Low	Low	Low	Medium	High
0.33 – 0.43 High erodibility	Low	Low	Medium	High	Very High
0.44 – 0.64 Very high erodibility	Low	Medium	High	Very High	Very High

All factors shall be determined by using the NRCS soil survey data (Web Soil Survey) with field verification of the predominant slope in the field. **The soil erodibility value will range from very low to very high and shall be assigned a value of 0 (very low) to 8 (very high) and used in the calculation of the *P Site Index* (Table 1).**

Runoff Index

Dissolved P (DP) is another important source of P that is transported in surface runoff. Dissolved P exists mainly in the form of orthophosphate, which is available immediately for uptake by algae and other aquatic plants. The first step in the movement of DP in runoff is the desorption, dissolution, and extraction of P from soils, crop residues, and surface applied fertilizer and manure (Sharpley et al., 1994). These processes occur as irrigation water, rainfall, or snowmelt water interacts with a thin layer of surface soil (0.04 to 0.12 in) before leaving the field as runoff or leaching downward in the soil profile (Sharpley, 1995). The soil test P content of surface soils has been found to be directly related to DP concentrations in runoff. Field studies have shown that P losses by surface runoff are greater when soil test P values are above the agronomic optimum range (Turner et al., 2004). Laboratory research has also shown that soils with high agronomic soil test P values are more likely to have high concentrations of soluble, desorbable, and bioavailable P (Paulter and Sims, 2000; Sibbensen and Sharpley, 1997; Sims, 1998b). In furrow irrigation runoff, even soil with low soil test P can have high runoff DP concentrations (Westermann et al., 2001).

For the *P Site Index*, soil runoff index is determined differently for surface irrigated vs sprinkler irrigated or fields with no irrigation. For surface irrigated fields use Table 4, for sprinkler irrigated or non-irrigated fields use Table 5.

Table 4. Runoff index for surface irrigated fields:

Criteria	Value
Fields with no runoff	0
Fields with water running off less than 50% of the irrigation set time	4
Fields with water running off 50% or more of the irrigation set time	8

Table 5. Runoff index for sprinkler or non-irrigated fields.

Hydrologic Soil Group	Slope Gradients				
	< 2%	2 – 5%	5 – 10%	10 – 15%	> 15%
A: Low Runoff Potential	Very Low	Very Low	Low	Medium	High
B: Moderately Low Runoff Potential	Very Low	Low	Medium	High	High
C: Moderately High Runoff Potential	Very Low	Medium	Medium	High	Very High
D, A/D, B/D, C/D: High Runoff Potential	Low	Medium	High	Very High	Very High

All factors shall be determined by using the NRCS soil survey data (Web Soil Survey) with field verification of the predominant slope in the field.

Leaching Potential

While surface transport processes are the major contributing factors in P transport from soil to water in most cases, leaching of P can contribute significant amounts of P to surface waters in some situations, such as in areas where there is relatively flat topography, high water tables, shallow soils over basalt and any artificial drainage system (e.g. ditches, subsurface drains). While P leaching is typically considered to be small there is potential for significant movement of P through the soil profile when soil P values increase to very high or excessive values due to long-term over-fertilization or manuring (Sims et al., 1998). Whether this leached P will reach surface waters depends on the depth to which it has leached and the hydrology of the site in question. In flat areas with shallow groundwater levels, P loss by leaching through soils contributes significantly to the phosphorus loads of streams (Culley et al., 1983; Heathwaite & Dils, 2000). Soils that are poorly drained with high water tables have a higher possibility of P loss than soils that are well drained with deep water tables. Also soils that are shallow (<24”) overlying basalt have a higher possibility of P loss than deeper soils. It is common in poorly drained soils to have water tables rise to the soil surface during the winter and spring months, during this time there is the potential for release of P into these drainage waters which can then be carried to nearby streams via subsurface flow. When soils are wet (during spring and late fall) or during time periods when irrigation exceeds ET, shallow soils can potentially leach P into the underlying basalt which can then be carried to surface waters (i.e. springs).

For the *P Site Index*, leaching potential shall be based on a USDA-NRCS categorization scheme based on the soil hydrologic group, predominant slope, saturated hydraulic conductivity, depth to high water table (HWT) and depth to bedrock Table 6. This information shall be determined through site inspection and the NRCS Web Soil Survey.

Table 6. Leaching potential.

Soil Leaching Potential	Hydrologic Group A	Hydrologic Group B	Hydrologic Group C	Hydrologic Group D
Low	NA	NA	NA	All except : <ul style="list-style-type: none"> • Apparent HWT • Depth to bedrock < 24”
Medium	<ul style="list-style-type: none"> • Slope > 6% • No apparent HWT and Depth to bedrock > 24” 	<ul style="list-style-type: none"> • Slope > 6% or slope ≤ 6% with $K_{sat} < 0.24$ in/hr • No apparent HWT and Depth to bedrock > 24” 	All except : <ul style="list-style-type: none"> • Apparent HWT • Depth to bedrock < 24” 	NA
High	<ul style="list-style-type: none"> • Slope < 6% • Apparent HWT or Depth to bedrock < 24” 	<ul style="list-style-type: none"> • Slope < 6% with $K_{sat} > 0.24$ in/hr • Apparent HWT or Depth to bedrock < 24” 	<ul style="list-style-type: none"> • Apparent HWT • Depth to bedrock < 24” 	<ul style="list-style-type: none"> • Apparent HWT • Depth to bedrock < 24”

High Water Table (HWT) is defined as a saturated layer < 24” from the surface anytime during the year.

Distance from Edge of Field to Surface Water

Another factor that affects the risk of P transport from soils to surface waters is the distance between the P source (i.e., the field) and the receiving waters. In some areas, the nearest water body may be a mile or more from the field being evaluated with no connectivity between the field and surface water; in these cases, even high levels of soil P may have low risk for nonpoint source pollution since the potential for transport to the water body is low. On the other hand, fields that are directly connected to surface water, such as surface irrigated fields with tailwater ditches, directly convey runoff water to surface water bodies through the return flow system. In these cases, even fields with low soil P can convey a large amount of both particulate and soluble P to surface waters.

The *P Site Index* shall take into account the distance from field edge to the nearest surface water body or other conveyance system connected to surface water (tailwater ditches, return flow ditches, laterals (Table 7).

Table 7. Distance from edge of field to surface water

Distance From Edge of Field to Surface Water	Value
> 2,640' (0.5 mile)	0
200' to 2,640'	2
< 200'	8

Best Management Practices for Reducing Transport Losses of P

There are several best management practices (BMPs) that can reduce the transport and loss of P from agricultural fields. In many situations, a combination of management practices is more effective than one BMP alone. To account for the effect of BMPs on the off-site transport of P from agricultural fields, a reduction in the overall transport factor is applied with varying BMPs that could be implemented on farm.

Contour farming, i.e. planting across the slope instead of up and down the hill can reduce soil erosion significantly. It is estimated that contour farming can reduce sediment loss by 20 to 50% depending on the slope of the field (Wischmeier and Smith, 1978). Keeping soil surfaces covered through cover or green manure crops can reduce losses of P by reducing erosion losses, however in some cases soluble P is either not affected or can increase. Sharpley and Smith (1991) reported reductions in total P losses of 54 to 66% with the use of cover crops while soluble P was reduced by 0 to 63%. The use of perennial crops such as alfalfa will also reduce the amount of sediment and therefore P leaving the field.

The installation of a dike or a berm that captures runoff from the field will prevent the loss of both soluble and total P. The effectiveness will depend on the holding capacity of the retention area. The use of drip irrigation vs. surface irrigation can significantly reduce the amount of runoff and therefore P that is transported off site. Mchugh et al. (2008) reported a 90% reduction in total P loss from fields with subsurface drip irrigation vs. furrow irrigation. Vegetative filter strips can trap sediment thereby reducing the offsite transport of P. Abu-Zreig et al. (2003) found that filter strips removed 31 to 89% of total P with filter length being the predominant factor affecting filter strip efficacy. The use of polyacrylamide (PAM) with irrigation has been shown to reduce losses of P from both furrow and sprinkler irrigated fields. Applying PAM with irrigation water or directly to furrow soil reduced soil erosion more than 90% on research plots (Lentz et al. 1992, Sojka and Lentz 1997, Trout et al. 1995). A conservative estimate for production fields is 50% to 80% reduction in soil loss. By reducing soil erosion, PAM treatment also reduced total P concentrations in runoff water (Lentz et al. 1998) but had little impact on dissolved P concentrations (Bjorneberg and Lentz, 2005). When used with sprinkler irrigation PAM has been shown to reduce P losses by 30%, but the effectiveness of PAM is minimal after three irrigations (Bjorneberg et al., 2000). Conservation tillage can also reduce soil erodibility and increase residue in furrows, both of which reduce soil loss to irrigation return flow (Carter and Berg 1991).

Sediment ponds remove suspended material from water by reducing flow velocity to allow particles to settle. Sediment ponds also remove nutrients associated with sediment particles. A large pond removed 65% to 75% of the sediment and 25% to 33% of the total P that entered the pond (Brown et al. 1981). A smaller percentage of total P was removed because only the P associated with sediment was removed and a large portion of the total P flowing into the pond was dissolved. Average total P concentrations significantly decreased by 13 to 42% in five ponds with 2 to 15 hour retention times, while dissolved P concentrations only decreased 7 to 16% in three of the five ponds (Bjorneberg et al., 2015). Dissolved P concentration may actually be greater in pond outflow than pond inflow because P may continue to desorb from sediment as water flows through the pond. Implementing sediment control practices on an 800 ha (2,000 ac) irrigation tract in the Columbia Basin of Washington reduced P discharges by 50% (King et al. 1982). Tailwater recovery systems that capture runoff from furrow irrigated fields and pump it back for re-use as irrigation water should eliminate the loss of P from the system during the irrigation system, provided that no water leaves the field.

The reduction in transport factor due to the implementation of BMPs is listed in Table 8. For each BMP implemented, the transport factor shall be reduced by the amounts listed in the tables. Combinations of BMPs will reduce the transport factor sequentially, for example if you had a score of 36 and you implemented contour farming and a sediment basin your score would then be:

$$36 - (0.2 \times 36) = 28.8 - (0.6 \times 28.8) = \mathbf{11.5}$$

Table 8. Management practices to reduce the loss of P from fields.

Management Practice ¹	BMP Coefficient
Contour Farming	0.20
Cover & Green Manure Crop	0.30
Dike or Berm	0.40 or 0.80
Drip Irrigation	0.80
Filter Strip ³	0.35
PAM - Furrow Irrigation	0.60
PAM – Sprinkler Irrigation	0.30
Residue Management/Conservation Tillage ⁴	0.30
Sediment Basin	0.30
Tailwater Recovery & Pumpback Systems ²	0.80
Established Perennial Crop ⁵	0.50

¹BMPs designed by NRCS can receive full credit; otherwise the BMPs must meet the requirements set out in the BMP definition section.

Phosphorus Site Index

Part A: Phosphorus Loss Potential Due to Site and Transport Characteristics

Sample Calculation

Part A: Phosphorus Loss Potential Due to Site and Transport Characteristics

Calculation of the Total Site and Transport Value for Part A of the P Site Index

Once the values for soil erodibility, soil surface runoff, leaching potential and distance from edge of field to surface water have been obtained, these values shall be added together to obtain a total site and transport value (sum for Part A).

EXAMPLE:

A field located in the Magic Valley with a Portneuf silt loam soil, 1.5% slope, that is surface irrigated with water running off of the field >50% of the irrigation set time. Hydrologic soil group C, K_w factor for erosion is 0.43, K_{sat} 0.2 to 0.6 in/hr, depth to water table > 80". The surface irrigation runoff flows directly into the return flow system.

Soil Erodibility

Using Table 3, a K_w factor of 0.43 with a slope of < 2% puts this in the "Low" category, with a value of **1** (Table 1).

Soil Surface Runoff

This field is surface irrigated with runoff >50% of the set time, which is a value of **8** (Table 1).

Leaching Potential

This soil is in Hydrologic Group C without a high water table and is not a shallow soil, which is a medium risk (Table 6) with a value of **2** (Table 1).

Distance from edge of field to surface water

Since the runoff from this field flows directly into the return flow system the distance from edge of field to surface water is 0' which would be a value of **8** (Table 1).

All of the field values in Part A are then added together to obtain the Total Site Transport Value

$$1 + 8 + 2 + 8 = 19$$

**If this site had a tailwater recovery and pumpback system the transport value would be reduced by 80%*

$$19 - (19 \times 0.8) = 3.8$$

Sum of Part A = 3.8

Phosphorus Site Index

Part B: Phosphorus Loss Potential Due to P Source and Management Practices

Soil Test Phosphorus

Phosphorus exists in many forms in the soil, both inorganic and organic. Major inorganic forms are soluble, adsorbed, precipitated and minerals containing Al, Ca, and Fe. Each “pool” of soil P has a characteristic reactivity and potential for movement in either soluble or particulate forms. Iron and aluminum oxides, prevalent in most soils, strongly adsorb P under acidic conditions; under alkaline conditions, adsorption and precipitation are fostered by the presence of free calcium ions and calcium carbonate (Leytem and Westermann, 2003). Microorganisms and plant uptake can immobilize inorganic P by incorporation into biomass. Conversely, as organic materials decompose, soluble P can be released and made available for transport. How much P exists in each of these pools is determined by soil type, mineralogy, microbial activity, cropping, and fertilization practices (with both inorganic and organic sources of P).

Past and present research has demonstrated that there is a positive relationship between soil test P and dissolved P in surface runoff; that is, as soil test P increases, dissolved P in runoff also increases (Westermann et al., 2001; Turner et al., 2004). However, this relationship varies with soil type, cropping system and nature of the runoff episode. In addition to impacting P levels in surface waters, soil test P has also been found to affect P loss in drainage waters (Heckrath et al., 1995; Sims et al, 1998). Thus, as soils are fertilized to levels exceeding the soil test P values considered optimum for plant growth, the potential for P to be released to soil solution and transported by surface runoff, leaching, subsurface movement and even groundwater increases. Therefore, it is important to include a measure of the current soil test P values in any risk assessment tool for P.

For the *P Site Index*, soil test P values are expressed in ppm of either Olsen or Bray P. Olsen P is the most common (and appropriate) soil test for Idaho’s calcareous soils. However certain regions of the state with lower soil pH (<7.4) may also use the Bray method for determination of soil test P.

P Site Index Value For Table 1 = 0.05 x Olsen Soil Test P (ppm), or

P Site Index Value For Table 1 = 0.025 x Bray Soil Test P (ppm)

Phosphorus Application Rate

The addition of fertilizer P or organic P to a field will usually increase the amount of P available for transport to surface waters. The potential for P loss when fertilizers, manures, or other P sources are applied is influenced by the rate, timing, and method of application and by the form of the P source (e.g. organic vs. inorganic). These factors also interact with others, such as the timing and duration of subsequent irrigation, rainfall or snowmelt and the type of soil cover present (vegetation, crop residues, etc.; Sharpley et al., 1993). Past research has established a clear relationship between the rate of fertilizer P applied and the amount of P transported in runoff (Baker and Laflen, 1982; Romkens and Nelson, 1974). These studies showed a linear relationship between the amount of P added as superphosphate fertilizer and P loss in runoff. Using manure as the source of P, Westerman et al. (1983) also demonstrated a direct relationship between the quality of runoff water and the application of manure. Therefore, it is important that the amount of P added to a site is accounted for in any risk assessment for nonpoint source pollution by P.

The P application rate is the amount of P in pounds P_2O_5 per acre that is applied to the crop. The amount of P in manures shall be determined either by sample submission for testing by a certified laboratory or calculated using Table 10.

Table 9. Phosphorus application rate. Corresponding value to be included in the *P Site Index* (Table 1).

P Application Rate (lbs P_2O_5 applied per acre)	Value
No Application	0
< 60	1
60 - 150	2
151 - 300	4
> 300	8

Table 10. Phosphorus concentration of dairy manure

Dairy Manure Type	%P_2O_5 on a wet basis
Solid stacked	0.57
Composted	0.69
Lagoon liquid	0.03
Slurry	0.30

Phosphorus Application Method

Directly related to the amount of fertilizer and organic P sources applied to a field is the method and timing of the application. Baker and Laflen (1982) determined that the dissolved P concentrations of runoff from areas receiving broadcast fertilizer P average 100 times more than from areas where comparable rates were applied 5cm below the soil surface. Muller et al (1984) showed that incorporation of dairy manure reduced total P losses in runoff five-fold compared to areas with broadcast applications. Surface applications of fertilizers and manures decrease the potential interaction of P with the soil, and therefore increase the availability of P for runoff from the site. When fertilizers and manures are incorporated into the soil, the soil is better able to absorb the added P and thus decrease the likelihood of P loss. It is particularly important that fertilizers and manures are not surface applied during times when there is no plant growth, when the soil is frozen, during or shortly before periods of irrigation, intense storms or times of the year when fields are generally flooded due to snowmelt. The major portion of annual P loss in runoff generally results from one or two intense transport periods. If P applications are made during any of these high risk times, the percentage of applied P lost would be higher than if applications are made when runoff probabilities are lower (Edwards et al., 1992). Also, the time between application of P and the first runoff even is important. Westerman and Overcash (1980) applied manure to plots and simulated rainfall at intervals ranging from one to three days following manure application. Total P concentrations in the runoff were reduced by 90% by delaying the first runoff event for three days. In order to manage manure and fertilizers to decrease potential for P transport off-site, they must be either applied below the surface or incorporated into the soil within a short period of time and also be applied shortly before the growing season when available P can be utilized by the plant.

For the *P site Index*: To determine the field value for application methods of P sources, information about the time of year and method of application must be obtained from the nutrient user and assigned values using Table 11.

Table 11. Values of P application methods for inclusion in *P Site Index* (Table 1).

P Application Method	Value
None applied	0
Incorporated within 2 day or injected/banded below surface at least 2”	1
Incorporated within 7 days of application	2
Incorporated >7 days or no incorporation when applied between February 16 and December 15	4
Application between December 16 and February 15	8

The Phosphorus Site Index
Part B: Phosphorus Loss Potential Due to P Source and Management Practices

Sample Calculation

Part B: Phosphorus Loss Potential Due to P Source and Management Practices

Calculation of the Total P Source and Management Value for Part B of the P Site Index

Once the values for soil test P, P application rate and P application method have been obtained, these values shall be added together to obtain a total P source and management practice value (sum for Part B).

EXAMPLE:

The field described for calculation of Part A has an Olsen soil test P value of 80 and solid manure is applied at 50 tons/acre in October and is not incorporated.

Soil Test P value

Olsen P of 80 x 0.05 = **4**

P Application Rate

50 tons/acre = (50 x 2,000 x (0.57/100)) = 570, this would be a value of **8**

P Application Method

Surface applied between Feb 16 and Dec 15 and not incorporated, this is a value of **4**

All of the field values in Part B are then added together to obtain the Total P Source and Management Value

4 + 8 + 4 = 16

Sum of Part B = 16

The Phosphorus Site Index

Calculation and Interpretation of the Overall P Loss Rating for a Site

To find the overall *P Loss Rating* for a site (the final *P Site Index Value*), multiply the total site and transport value from Part A by the total management and source value from Part B as follows:

$$**P Site Index = [Sum of Part A] x [Sum of Part B]**$$

$$**Sum of Part A = 19**$$

$$**Sum of Part B = 16**$$

$$**P Site Index = 19 x 16 or 304**$$

A *P Site Index* value of **304** is classified as **Very High** (See Tables 2 or 12)

*If a tailwater recover with a pumpback system was used as a BMP then the *P Site Index* value would be

$$**Sum of Part A = 3.8**$$

$$**Sum of Part B = 16**$$

$$**P Site Index = 3.8 x 16 or 61**$$

A *P Site Index* value of **61** is classified as **Low** (See Tables 2 or 12)

Interpretation of the P Site Index Value

Compare the *P Site Index* value calculated as show above with the ranges given in Table 12 for Low, Medium, High, or Very High risk of P loss. **It is important to remember that a P Site Index value is an indication of the degree of risk of P loss, not a quantitative prediction of the actual amount of P lost from a given field.** Fields in the “Low” category are expected to have a lower potential for P losses than fields in the “Medium P loss rating category, while fields in the “Medium P loss rating category are expected to have a relatively lower potential for P loss than fields in the “High” P loss rating category, and so on. The numeric values used in Table 12 to separate the various P loss categories are based on the best professional judgement of the individuals involved in the development of the *P Site Index* using data from fields and farms in Idaho where field evaluations were conducted in 2017.

Table 12. Interpretation of the Phosphorus Site Index Value

<i>P Site Index Value</i>	Generalized Interpretation of the <i>P Site Index Value</i>
< 75	LOW potential for P movement from this site given current management practices and site characteristics. There is a low probability of an adverse impact to surface waters from P losses from this site. Nitrogen-based nutrient management planning is satisfactory for this site. Soil P levels and P loss potential may increase in the future due to N-based nutrient management planning.
75 - 150	MEDIUM potential for P movement from this site given current management practices and site characteristics. Phosphorus applications shall be limited to the amount expected to be removed from the field by crop harvest (crop uptake) or soil test-based P application recommendations. Testing of manure P prior to application is required.
151 – 225	HIGH potential for P movement from this site given the current management practices and site characteristics. Phosphorus applications shall be limited to 50% of crop P uptake. Testing of manure P prior to application is required.
> 225	VERY HIGH potential for P movement from this site given current management practices and site characteristics. No P shall be applied to this site.

Best Management Practice Definitions

Contour Farming. Farming sloping land in such a way that planting is done on the contour (perpendicular to the slope direction). This practice would apply to fields having a slope of 2% or greater. When converting from surface to sprinkler irrigation, this can be as simple as planting across the direction of the surface water flow. For other more complex settings, the maximum row grade shall not exceed half of the downslope grade up to a maximum of 4%. The minimum ridge height shall be 2 inches for row spacing greater than 10 inches and 1 inch for row spacing less than 10 inches.

Cover & Green Manure Crop. A cover and/or green manure crop is a close-growing crop primarily for seasonal protection and soil improvement. This practice reduces erosion by protecting the soil surface. Cover crops must be established (have vegetative cover over a minimum of 30% of the soil) by November 1 and must be maintained to within 30 days prior to planting the following crop. There shall be a minimum of 2 to 3 plants per square foot (about 100,000 plants/acre).

Dike or Berm. This practice applies to non-surface irrigated fields only and is comprised of an embankment to retain water on the field. The dike or berm must be engineered to retain runoff from a 25 year 24 hour storm event (0.8 BMP coefficient) or from 1 inch of runoff from the field (0.4 BMP coefficient).

Drip Irrigation. The credit for implementing this practice only applies when switching from surface irrigation to drip irrigation. A drip irrigation system shall be comprised of an irrigation system with orifices, emitters or perforated pipe that applies water directly to the root zone or soil surface. This practice efficiently applies water to the soil surface with low probability of runoff, as determined using the calculation in Table 5.

Filter Strip. A filter strip is a strip of permanent herbaceous dense vegetation in an area where runoff occurs. A filter strip can only be used on fields having < 10% slope. Ideally they are perpendicular to the flow of water and the runoff from the source area is such that flow through the strip is in the form of sheet runoff. Channeling of water through a filter strip will severely reduce its effectiveness. Filter strips must be a minimum of 20 feet in length. If the length of the field contributing runoff to the filter strip is greater than 1000 feet, then the minimum filter strip width shall be 50 feet. They must be irrigated and maintained so that there is a minimum of 75% vegetative cover. The seeding rate shall be sufficient to ensure that the plant spacing does not exceed 4 inches (about 16-18 plants per square foot).

Polyacrylamide (PAM). PAM is an organic polymer that stabilizes the soil surface when applied with irrigation water. This practice can increase infiltration and reduce soil erosion. The PAM must be a soluble anionic polyacrylamide. Standards for proper implementation of this BMP shall follow the NRCS Conservation Practice Standard “Anionic Polyacrylamide (PAM) Application” (450-CPS-1).

Residue Management/Conservation Tillage. is any method of soil cultivation that leaves the previous year crop residue cover on the soil surface (such as corn stock or wheat stubble).. Conservation tillage must result in crop residue remaining on at least 30% of the soil surface. This practice reduces soil erosion by protecting the soil surface.

Sediment Basin. A basin or pond constructed to collect and retain sediment. This practice slows the velocity of flowing water which allows sediment to settle in the basin. Sediment basin size must be at least 500 cubic feet per acre of drainage area (20,000 ft³ for 40 acre field or 20 ft x 200 ft x 5 ft). The length-to-width ratio shall be 2 to 1 or greater with a minimum depth of 3 feet. Sediment basins must be cleaned on an annual basis or more frequently.

Tailwater Recovery & Pumpback Systems. This practice applies to surface irrigated fields only. Design standards and management must follow the ASABE Engineering Practice Standard 408.3 “Surface Irrigation Runoff Reuse Systems”. Irrigation runoff reuse systems have four basic components: 1) runoff collection and conveyance channels (tailwater ditches, drains), 2) storage reservoir (tailwater pit, pond, sump), 3) pumping plant (reuse, return, pumpback pump), and 4) delivery pipe (return, pumpback pipe). Runoff from irrigated fields is intercepted by a system of open channels or pipelines and conveyed by gravity to a storage reservoir or pumping plant. Capacity of the channels and pipelines shall be sufficient to convey the maximum expected runoff rate from irrigation. Also, the collection system must be able to safely convey or bypass runoff from precipitation. Reuse systems designed to capture 50% of the application volume will usually capture a large percentage of the total irrigation runoff.

Established Perennial Crop. This is a crop that is grown for more than one year. Perennial crop is considered to be “established” the season after it was seeded.

References

- Abu-Zreig, M., R. Rudra, H.R. Whiteley, M.N. Lalonde, and N.K. Kaushik. 2003. Phosphorus removal in vegetated filter strips. *J. Environ. Qual.* 32:613-619
- Baker, J.L., and J.M. Laflen. 1982. Effect of crop residue and fertilizer management on soluble nutrient runoff losses. *Trans. ASAE* 25:344-348.
- Berg, R.D., and D.L. Carter. 1980. Furrow erosion and sediment losses on irrigated cropland. *Journal of Soil and Water Conservation* 35:267-270.
- Bjorneberg, D.L. and Aase, J.K. and Westermann, D.T. (2000) Controlling sprinkler irrigation runoff, erosion, and phosphorus loss with straw and polyacrylamide. *Transactions of the ASAE.* 43(6):1545-1551.
- Bjorneberg, D.L., D.T. Westermann, and J.K. Aase. 2002. Nutrient losses in surface irrigation runoff. *J. Soil Water Cons.* 57:524-529.
- Brown, M.I, JA. Bondurant, and C.E. Brockway. 1981. Ponding surface drainage water for sediment and phosphorus removal. *Transactions of the ASAF* 24:1478- 1481.
- Carter, D.L., and R .D. Berg. 1991. Crop sequences and conservation tillage to control irrigation furrow erosion and increase farmer income. *Journal of Soil and Water Conservation* 46:139-142.
- Carter, D.L., M.J. Brown, C.W. Robbins, and JA. Bondurant. 1974. Phosphorus associated with sediments in irrigation and drainage waters for two large tracts in southern Idaho. *Journal of Environmental Quality* 3:287-291.
- Culley, J.L.B., Bolton, E.F. & Bernyk, V. 1983. Suspended solids and phosphorus loads from a clay soil: I. Plot studies. *Journal of Environmental Quality*, 12, 493–498.
- Edwards, D.R., T.C. Daniel, and O. Marbun. 1992. Determination of best timing for poultry waste disposal: A modeling approach. *Wat Res. Bul.* 28:487-494.
- Fitzsimmons, D.W., G.C. Lewis, D.V. Naylor, and J.R. Busch. 1972. Nitrogen, phosphorous and other inorganic materials in waters in a gravity-irrigated area. *Transactions of the ASAE* 15:292-295.
- Heckrath, G., P.C. Brooks, P.R. Poulton, and K.W. T. Gouliding. 1995. Phosphorus leaching from soils containing different phosphorus concentrations in the Broadbalk experiment. *J. Environ. Qual.* 24:904-910.
- Heathwaite, A.L. & Dils, R.M. 2000. Characterising phosphorus loss in surface and subsurface hydrological pathways. *Science of the Total Environment*, 251–252, 523–538.
- King, LG., B.L. McNeal, F.A. Ziari, S.C. Matulich, and JP Law. 1982. On-farm improvements to reduce sediment and nutrients in irrigation return flow. Washington State University completion report for Grant No. R-805527 from the R .S. Kerr Environmental Research Laboratory. U.S. Environmental Protection Agency, Ada, OK. 193 pp.

- Koluvek, P.K., K.K. Tanji, and T.J. Trout. 1993. Overview of soil erosion from irrigation. *Journal of Irrigation and Drainage Engineering* 119:929-946.
- Lentz, R .D., I. Shainberg, R .E. Sojka, and D.L. Carter. 1992. Preventing irrigation furrow erosion with snail applications of polymers *Soil Science Society of America Journal* 56:1926-1932.
- Lentz, R.D., R.E. Sojka, and C.W. Robbins 1998. Reducing phosphorus losses from surface-irrigated fields Emerging polyacrylamide technology. *Journal of Environmental Quality* 27:305-312.
- Leytem, A.B. and Westermann, D.T. (2003) Phosphate sorption by Pacific Northwest calcareous soils. *Soil Sci.* 168:368-375.
- Mchugh, A.D., S. Bhattarai, G. Lotz, and D.J. Midmore. 2008. Effects of subsurface drip irrigation rates and furrow irrigation for cotton grown on a vertisol on off-site movement of sediments, nutrients and pesticides. *Agron. Sustain. Dev.* 28:507-519.
- Mueller, D.H., R.C. Wendt, and T.C. Daniel. 1984. Phosphorus losses as affected by tillage and manure application. *Soil Sci. Soc. Am. J.* 48:901-905.
- Pautler, M.C., and J.T. Sims. 2000. Relationships between soil test phosphorus, soluble phosphorus, and phosphorus saturation in Delaware soils. *Soil Sci. Soc.Am. J.* 64:765-773.
- Romkens, J.M. and D.W. Nelson. 1974. Phosphorus relationships in runoff from fertilized soils. *J. Environ. Qual.* 3:10-13.
- Sharpley, A.N. 1985. The selective erosion of plant nutrients in runoff. *Soil Science Society of America Journal* 49:1527-1534.
- Sharpley, A.N. 1995. Identifying sites vulnerable to phosphorus loss in agricultural runoff. *J. Environ. Qual.* 24:947-951.
- Sharpley, A.N., S.C. Chapra, R. Wedepohl, J.T. Sims, T.C. Daniel, and K.R. Reddy. 1994. Managing agricultural phosphours for the protection of surface waters: Issues and options. *J. Environ. Qual.* 23:437-451.
- Sharpley, A.N. and S.J. Smith. 1991. Effect of cover crop on surface water quality. p. 41-49, *In* Cover Crop for Clean Water. W.L. Hargrov (Ed.) Soil and Water Conservation Society, Iowa, USA.
- Sibbesen, E. and A.N. Sharpley. 1997. Setting and justifying upper critical limits of r phosphorus in soils. p. 151-176. *In* H. Tunney et al. (eds) Phosphorus loss from soil to water. CAB International, London.
- Sims, J.T. 1998. Phosphorus and soil testing: Innovations for water quality protection. *Comm. Soil Sci. Plant Anal.* 29:1471-1489.
- Sims, J.T., R.R. Simard, and B.C. Joern. 1998. Phosphorus losses in agricultural drainage: Historical perspectives and current research. *J. Environ. Qual.* 27:277-293.

- Sojka, R .E., and R .D. Lentz. 1997. Reducing furrow irrigation erosion with polyacrylamide (PAM). *Journal of Production Agriculture* 10:47-52.
- Trout, T.I, R .E. Sojka, and R .D. Lentz. 1995. Polyacrylamide effect on furrow erosion and infiltration. *Transactions of the ASAF* 38:761-765.
- Turner, B.L., M.A. Kay, and D.T. Westermann. 2004. Phosphorous in surface runoff from calcareous arable soils of the semiarid Western United States. *J. Environ. Qual.* 33:1589-1946.
- Westermann, D.T., D.L. Bjerneberg, J.K. Aase, and C.W. Robbins. 2001. Phosphorus losses in furrow irrigation runoff. *Journal of Environmental Quality* 30:1009-1015.
- Westerman, P.W., T.L. Donnely, and M.R. Overcash. 1983. Erosion of soil and poultry manure – a laboratory study. *Trans ASAE* 26:1070-1078.
- Westerman, P.W. and M.R. Overcash. 1980. Shor-term attenuation of runoff pollution potential for land-applied swine and poultry manure. P. 289-292. In R.J. Smith et al. (eds.) *Livestock waste – A renewable resource.* Prox. 4th Int. Symp on Livestock Wastes, Amarillo TX, 15-17 Apr. ASAE, St. Joseph, MI.
- Wischmeier, W.H. and D.D. Smith. 1978. Predicting rainfall erosion losses – A guide to conservation planning. USDA

NITROGEN MANAGEMENT PLAN WORKSHEET

NAME _____

Crop Year (Harvested) _____

Field ID _____

Acres _____

Crop Nitrogen Management Planning		N Applications/Credits	Recommended/ Planned N	Actual N
1. Crop		<u>Manure/Organic Material N</u>		
2. Production Unit		8. Available N in Manure/Compost (lbs/acre)		
3. Projected Yield (units/acre)		<u>Nitrogen Fertilizers</u>		
4. N Recommended (lbs/acre)		9. Dry/Liquid N (lbs/acre)		
		10. Foliar N (lbs/acre)		
Post Production Actuals		11. Total Available N Applied (lbs/acre)		
5. Actual Yield (units/acre)		<u>Nitrogen Credits</u>		
6. Total N Applied (lbs/acre)		12. Available N in soil (lbs/acre)		
7. N Removed (lbs/acre)		13. N in Irrigation Water (lbs/acre)		
Notes:		14. Total N Credits (lbs/acre)		
PSNT Test:		15. Total N Applied & Available		

Certified By:	
Date:	

Instructions

1. This is the crop that is planted in the year for which the information is recorded.
2. This is the crop yield units ie. bushels, tons, cwt, etc.
3. Projected yield (units/acre). This is the yield that you are anticipating for this crop in this year.
4. N Recommended (lbs/acre). This is the amount of N recommended based on the projected yield.
5. Actual Yield (units/acre). The actual harvested yield on this field for this crop.
6. Total N Applied (lbs/acre). The actual amount of total N that was applied to this crop during this season from line 11.
7. N Removed (lbs/acre). The amount of N that was removed with the crop (calculated by summing all of the biomass removed multiplied by the tissue N concentration of the different biomass pools)
8. Available N in Manure/Compost (lbs/acre). This is the total amount of plant available N applied for the growing season including previous fall applications. Use Table 1 to determine the % PAN of total N in manure/compost/liquid/slurry etc.
9. Dry/Liquid N (lbs/acre). This is the total amount of N applied as fertilizer including starter fertilizer, broadcast applications, in season side-dress applications and any N applied with irrigation.
10. Foliar N (lbs/acre). This is the total amount of N applied as a foliar spray during the growing season.
11. Total Available N Applied (lbs/acre). This is the sum of blocks 8, 9 and 10.
12. Available N in soil (lbs/acre). This is determined from soil samples collected within 8 months of planting. It is preferential to collect a pre-plant soil sample within 3 weeks of planting for the most accurate accounting of N in soil. This must include soils from 0 to 12". The lbs/acre is calculated by multiplying the average ppm N ($\text{NH}_4 + \text{NO}_3$) in the 0 to 12" sample by 4. It is preferential to account for the N in the top 2' of soil. If you have soil samples from 0 to 12" and 12 to 24" you would multiply each sample by 4 and then add them together ($0 \text{ to } 12'' \text{ ppm N} \times 4$) + ($12 \text{ to } 24'' \text{ ppm N} \times 4$). Alternatively, if you only have a 0 to 12" soil sample you could multiply the ppm N x 8 to represent the first 2', however this is not as accurate.
13. N in irrigation water (lbs/acre). If irrigation water contains N, the N applied with irrigation water must be included.
14. Total N Credits (lbs/acre). This is the sum of blocks 12 and 13.
15. Total N Applied and Available. This is the sum of blocks 11 and 14.

Table 1. Plant available N in manure

Manure Source	N available (%)
Lagoon Liquid	80
Lagoon Slurry/Sludge	60
Solid Stacked Manure (corral)	30
Composted Manure	10